

Portable Grand
DGX-640

Owner's Manual

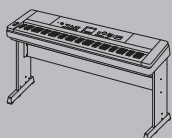

Keyboard Stand Assembly

For information on assembling the keyboard stand, refer to the instructions on **page 10** of this manual.

Setting Up

Quick Guide

Reference

Appendix

SPECIAL MESSAGE SECTION

This product utilizes batteries or an external power supply (adapter). DO NOT connect this product to any power supply or adapter other than one described in the manual, on the name plate, or specifically recommended by Yamaha.

WARNING: Do not place this product in a position where anyone could walk on, trip over, or roll anything over power or connecting cords of any kind. The use of an extension cord is not recommended! If you must use an extension cord, the minimum wire size for a 25' cord (or less) is 18 AWG. NOTE: The smaller the AWG number, the larger the current handling capacity. For longer extension cords, consult a local electrician.

This product should be used only with the components supplied or; a cart, rack, or stand that is recommended by Yamaha. If a cart, etc., is used, please observe all safety markings and instructions that accompany the accessory product.

SPECIFICATIONS SUBJECT TO CHANGE:

The information contained in this manual is believed to be correct at the time of printing. However, Yamaha reserves the right to change or modify any of the specifications without notice or obligation to update existing units.

This product, either alone or in combination with an amplifier and headphones or speaker/s, may be capable of producing sound levels that could cause permanent hearing loss. DO NOT operate for long periods of time at a high volume level or at a level that is uncomfortable. If you experience any hearing loss or ringing in the ears, you should consult an audiologist.

IMPORTANT: The louder the sound, the shorter the time period before damage occurs.

Some Yamaha products may have benches and / or accessory mounting fixtures that are either supplied with the product or as optional accessories. Some of these items are designed to be dealer assembled or installed. Please make sure that benches are stable and any optional fixtures (where applicable) are well secured BEFORE using.

Benches supplied by Yamaha are designed for seating only. No other uses are recommended.

NOTICE:

Service charges incurred due to a lack of knowledge relating to how a function or effect works (when the unit is operating as designed) are not covered by the manufacturer's warranty, and are therefore the owners responsibility. Please study this manual carefully and consult your dealer before requesting service.

ENVIRONMENTAL ISSUES:

Yamaha strives to produce products that are both user safe and environmentally friendly. We sincerely believe that our products and the production methods used to produce them, meet these goals. In keeping with both the letter and the spirit of the law, we want you to be aware of the following:

Battery Notice:

This product MAY contain a small non-rechargeable battery which (if applicable) is soldered in place. The average life span of this type of battery is approximately five years. When replacement becomes necessary, contact a qualified service representative to perform the replacement.

This product may also use "household" type batteries. Some of these may be rechargeable. Make sure that the battery being charged is a rechargeable type and that the charger is intended for the battery being charged.

When installing batteries, never mix old batteries with new ones, and never mix different types of batteries. Batteries MUST be installed correctly. Mismatches or incorrect installation may result in overheating and battery case rupture.

Warning:

Do not attempt to disassemble, or incinerate any battery. Keep all batteries away from children. Dispose of used batteries promptly and as regulated by the laws in your area. Note: Check with any retailer of household type batteries in your area for battery disposal information.

Disposal Notice:

Should this product become damaged beyond repair, or for some reason its useful life is considered to be at an end, please observe all local, state, and federal regulations that relate to the disposal of products that contain lead, batteries, plastics, etc. If your dealer is unable to assist you, please contact Yamaha directly.

NAME PLATE LOCATION:

The name plate is located on the bottom of the product. The model number, serial number, power requirements, etc., are located on this plate. You should record the model number, serial number, and the date of purchase in the spaces provided below and retain this manual as a permanent record of your purchase.

Model

Serial No.

Purchase Date

PLEASE KEEP THIS MANUAL

92-BP (bottom)

FCC INFORMATION (U.S.A.)

1. IMPORTANT NOTICE: DO NOT MODIFY THIS UNIT!

This product, when installed as indicated in the instructions contained in this manual, meets FCC requirements. Modifications not expressly approved by Yamaha may void your authority, granted by the FCC, to use the product.

2. IMPORTANT:

When connecting this product to accessories and/or another product use only high quality shielded cables. Cable/s supplied with this product MUST be used. Follow all installation instructions. Failure to follow instructions could void your FCC authorization to use this product in the USA.

3. NOTE:

This product has been tested and found to comply with the requirements listed in FCC Regulations, Part 15 for Class "B" digital devices. Compliance with these requirements provides a reasonable level of assurance that your use of this product in a residential environment will not result in harmful interference with other electronic devices. This equipment generates/uses radio frequencies and, if not installed and used according to the instructions found in the users manual, may cause interference harmful to the operation of other electronic devices. Compliance with FCC regulations does

not guarantee that interference will not occur in all installations. If this product is found to be the source of interference, which can be determined by turning the unit "OFF" and "ON", please try to eliminate the problem by using one of the following measures:

Relocate either this product or the device that is being affected by the interference.

Utilize power outlets that are on different branch (circuit breaker or fuse) circuits or install AC line filter/s.

In the case of radio or TV interference, relocate/reorient the antenna. If the antenna lead-in is 300 ohm ribbon lead, change the lead-in to co-axial type cable.

If these corrective measures do not produce satisfactory results, please contact the local retailer authorized to distribute this type of product. If you can not locate the appropriate retailer, please contact Yamaha Corporation of America, Electronic Service Division, 6600 Orangethorpe Ave, Buena Park, CA90620

The above statements apply ONLY to those products distributed by Yamaha Corporation of America or its subsidiaries.

* This applies only to products distributed by YAMAHA CORPORATION OF AMERICA.

(class B)

OBSERVERA!

Apparaten kopplas inte ur växelströmskällan (nätet) så länge som den är ansluten till vägguttaget, även om själva apparaten har stängts av.

ADVÅRSEL: Netzspændingen til dette apparat er IKKE afbrudt, så længe netledningen sidder i en stikkontakt, som er tændt — også selvom der er slukket på apparatets afbryder.

VAROITUS: Laitteen toisiopiiriin kytketty käyttökytkin ei irroita koko laitetta verkosta.

(standby)

The serial number of this product may be found on the bottom of the unit. You should note this serial number in the space provided below and retain this manual as a permanent record of your purchase to aid identification in the event of theft.

Model No.

Serial No.

(bottom)

COMPLIANCE INFORMATION STATEMENT (DECLARATION OF CONFORMITY PROCEDURE)

Responsible Party : Yamaha Corporation of America
Address : 6600 Orangethorpe Ave., Buena Park,
Calif. 90620
Telephone : 714-522-9011
Type of Equipment : Digital Piano
Model Name : DGX-640

This device complies with Part 15 of the FCC Rules.

Operation is subject to the following two conditions:

- 1) this device may not cause harmful interference, and
- 2) this device must accept any interference received including interference that may cause undesired operation.

See user manual instructions if interference to radio reception is suspected.

* This applies only to products distributed by
YAMAHA CORPORATION OF AMERICA.

(FCC DoC)

IMPORTANT NOTICE FOR THE UNITED KINGDOM Connecting the Plug and Cord

IMPORTANT. The wires in this mains lead are coloured in accordance with the following code:

BLUE : NEUTRAL
BROWN : LIVE

As the colours of the wires in the mains lead of this apparatus may not correspond with the coloured markings identifying the terminals in your plug proceed as follows:

The wire which is coloured BLUE must be connected to the terminal which is marked with the letter N or coloured BLACK.

The wire which is coloured BROWN must be connected to the terminal which is marked with the letter L or coloured RED.

Making sure that neither core is connected to the earth terminal of the three pin plug.

* This applies only to products distributed by
Yamaha Music U.K. Ltd.

(2 wires)

Information for Users on Collection and Disposal of Old Equipment



This symbol on the products, packaging, and/or accompanying documents means that used electrical and electronic products should not be mixed with general household waste.

For proper treatment, recovery and recycling of old products, please take them to applicable collection points, in accordance with your national legislation and the Directives 2002/96/EC.

By disposing of these products correctly, you will help to save valuable resources and prevent any potential negative effects on human health and the environment which could otherwise arise from inappropriate waste handling.

For more information about collection and recycling of old products, please contact your local municipality, your waste disposal service or the point of sale where you purchased the items.

[For business users in the European Union]

If you wish to discard electrical and electronic equipment, please contact your dealer or supplier for further information.

[Information on Disposal in other Countries outside the European Union]

This symbol is only valid in the European Union. If you wish to discard these items, please contact your local authorities or dealer and ask for the correct method of disposal.

(weee_eu_en)

PRECAUTIONS

PLEASE READ CAREFULLY BEFORE PROCEEDING

* Please keep this manual in a safe place for future reference.



WARNING

Always follow the basic precautions listed below to avoid the possibility of serious injury or even death from electrical shock, short-circuiting, damages, fire or other hazards. These precautions include, but are not limited to, the following:

Power supply/AC power adaptor

- Do not place the power cord near heat sources such as heaters or radiators, and do not excessively bend or otherwise damage the cord, place heavy objects on it, or place it in a position where anyone could walk on, trip over, or roll anything over it.
- Only use the voltage specified as correct for the instrument. The required voltage is printed on the name plate of the instrument.
- Use the specified adaptor (page 112) only. Using the wrong adaptor can result in damage to the instrument or overheating.
- Check the electric plug periodically and remove any dirt or dust which may have accumulated on it.

Do not open

- This instrument contains no user-serviceable parts. Do not open the instrument or attempt to disassemble or modify the internal components in any way. If it should appear to be malfunctioning, discontinue use immediately and have it inspected by qualified Yamaha service personnel.

Water warning

- Do not expose the instrument to rain, use it near water or in damp or wet conditions, or place containers on it containing liquids which might spill into any openings. If any liquid such as water seeps into the instrument, turn off the power immediately and unplug the power cord from the AC outlet. Then have the instrument inspected by qualified Yamaha service personnel.
- Never insert or remove an electric plug with wet hands.

Fire warning

- Do not put burning items, such as candles, on the unit. A burning item may fall over and cause a fire.

If you notice any abnormality

- When one of the following problems occur, immediately turn off the power switch and disconnect the electric plug from the outlet. Then have the device inspected by Yamaha service personnel.
 - The power cord or plug becomes frayed or damaged.
 - It emits unusual smells or smoke.
 - Some object has been dropped into the instrument.
 - There is a sudden loss of sound during use of the instrument.



CAUTION

Always follow the basic precautions listed below to avoid the possibility of physical injury to you or others, or damage to the instrument or other property. These precautions include, but are not limited to, the following:

Power supply/AC power adaptor

- Do not connect the instrument to an electrical outlet using a multiple-connector. Doing so can result in lower sound quality, or possibly cause overheating in the outlet.
- When removing the electric plug from the instrument or an outlet, always hold the plug itself and not the cord. Pulling by the cord can damage it.
- Remove the electric plug from the outlet when the instrument is not to be used for extended periods of time, or during electrical storms.

Location

- Do not place the instrument in an unstable position where it might accidentally fall over.
- Before moving the instrument, remove all connected cables.
- When setting up the product, make sure that the AC outlet you are using is easily accessible. If some trouble or malfunction occurs, immediately turn off the power switch and disconnect the plug from the outlet. Even when the power switch is turned off, electricity is still flowing to the product at the minimum level. When you are not using the product for a long time, make sure to unplug the power cord from the wall AC outlet.
- Use only the stand specified for the instrument. When attaching the stand or rack, use the provided screws only. Failure to do so could cause damage to the internal components or result in the instrument falling over.

Connections

- Before connecting the instrument to other electronic components, turn off the power for all components. Before turning the power on or off for all components, set all volume levels to minimum.
- Be sure to set the volumes of all components at their minimum levels and gradually raise the volume controls while playing the instrument to set the desired listening level.

Handling caution

- Do not insert a finger or hand in any gaps on the instrument.
- Never insert or drop paper, metallic, or other objects into the gaps on the panel.
- Do not rest your weight on, or place heavy objects on the instrument, and do not use excessive force on the buttons, switches or connectors.
- Do not use the instrument/device or headphones for a long period of time at a high or uncomfortable volume level, since this can cause permanent hearing loss. If you experience any hearing loss or ringing in the ears, consult a physician.

Yamaha cannot be held responsible for damage caused by improper use or modifications to the instrument, or data that is lost or destroyed.

Always turn the power off when the instrument is not in use.

Even when the [](Standby/On) switch is in the "Standby" position, electricity is still flowing to the instrument at the minimum level. When you are not using the instrument for a long time, make sure you unplug the power cord from the wall AC outlet.

NOTICE

To avoid the possibility of damage to the product, data or other property, follow the notices below.

■ Handling and Maintenance

- Do not use the instrument in the vicinity of a TV, radio, stereo equipment, mobile phone, or other electric devices. Otherwise, the instrument, TV, or radio may generate noise.
- Do not expose the instrument to excessive dust or vibrations, or extreme cold or heat (such as in direct sunlight, near a heater, or in a car during the day) to prevent the possibility of panel disfiguration or damage to the internal components.
- Do not place vinyl, plastic or rubber objects on the instrument, since this might discolor the panel or keyboard.
- When cleaning the instrument, use a soft, dry cloth. Do not use paint thinners, solvents, cleaning fluids, or chemical-impregnated wiping cloths.
- During extreme changes in temperature or humidity, condensation may occur and water may collect on the surface of the instrument. If water is left, the wooden parts may absorb the water and be damaged. Make sure to wipe any water off immediately with a soft cloth.

■ Saving data

- Some data items (page 64) are automatically saved as backup data in the internal memory even if you turn the power off. Saved data may be lost due to malfunction or incorrect operation. Save important data to a USB storage device/or other external device such as a computer (pages 93–94 and 101).
- To protect against data loss through media damage, we recommend that you save your important data onto two USB storage devices/or other external device such as a computer.

● About copyrights

- Copying of the commercially available musical data including but not limited to MIDI data and/or audio data is strictly prohibited except for your personal use.
- This product incorporates and bundles computer programs and contents in which Yamaha owns copyrights or with respect to which it has license to use others' copyrights. Such copyrighted materials include, without limitation, all computer software, style files, MIDI files, WAVE data, musical scores and sound recordings. Any unauthorized use of such programs and contents outside of personal use is not permitted under relevant laws. Any violation of copyright has legal consequences. DON'T MAKE, DISTRIBUTE OR USE ILLEGAL COPIES.

● About functions/data bundled with the instrument

- Some of the preset songs have been edited for length or arrangement, and may not be exactly the same as the original.
- This device is capable of using various types/formats of music data by optimizing them to the proper format music data for use with the device in advance. As a result, this device may not play them back precisely as their producers or composers originally intended.

● About this manual

- The illustrations and LCD screens as shown in this manual are for instructional purposes only, and may appear somewhat different from those on your instrument.
- Windows is a registered trademark of Microsoft® Corporation in the United States and other countries.
- The company names and product names in this manual are the trademarks or registered trademarks of their respective companies.

Logos



GM System Level 1

“GM System Level 1” is an addition to the MIDI standard which ensures that any GM-compatible music data can be accurately played by any GM-compatible tone generator, regardless of manufacturer. The GM mark is affixed to all software and hardware products that support GM System Level.



XGlite

As its name implies, “XGlite” is a simplified version of Yamaha’s high-quality XG tone generation format. Naturally, you can play back any XG song data using an XGlite tone generator. However, keep in mind that some songs may play back differently compared to the original data, due to the reduced set of control parameters and effects.



XF

The Yamaha XF format enhances the SMF (Standard MIDI File) standard with greater functionality and open-ended expandability for the future. The instrument is capable of displaying lyrics when an XF file containing lyric data is played.



STYLE FILE

The Style File Format is Yamaha’s original style file format which uses a unique conversion system to provide high-quality automatic accompaniment based on a wide range of chord types.

About this Owner's Manual and Data List

This manual consists of four main sections: "Setting Up," "Quick Guide," "Reference," and "Appendix." Also, a separate "Data List" is provided.

Owner's Manual (this book)

Setting Up	Please read this section first.
Quick Guide	This section explains how to use the basic functions. Refer to this section while playing the instrument.
Reference	This section explains how to make detailed settings for the instrument's various functions.
Appendix	This section includes troubleshooting information and specifications.

Data List

Voice List, MIDI Data Format, etc.

MIDI Reference

The MIDI Reference section contains MIDI related information. The MIDI Reference is available for downloading from the Yamaha Manual Library at: <http://www.yamaha.co.jp/manual/>

Included Accessories

The DGX-640 package includes the following items. Please check that you have them all.

- | | |
|--|--|
| <ul style="list-style-type: none">• Music rest• Accessory CD-ROM• Owner's manual (this book)• Keyboard stand• Footswitch | <ul style="list-style-type: none">• AC Power Adaptor<ul style="list-style-type: none">* May not be included depending on your particular area. Please check with your Yamaha dealer.• Data List• My Yamaha Product User Registration<ul style="list-style-type: none">* The PRODUCT ID on the sheet will be needed when you fill out the User Registration form. |
|--|--|

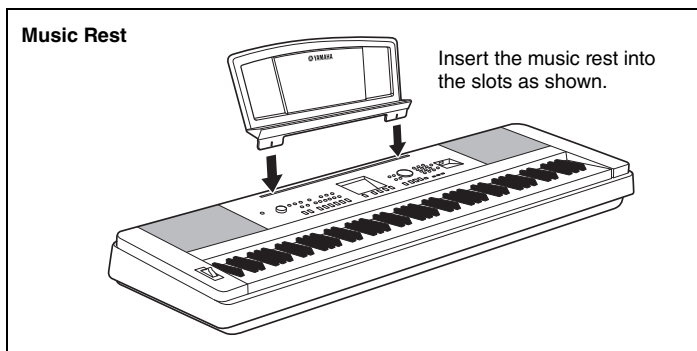

Special Features

Graded Hammer Standard Keyboard

Thanks to our experience as the world's leading manufacturer of acoustic pianos, we've developed a keyboard with action that's virtually indistinguishable from the real thing. Just as on a traditional acoustic piano, the keys of the lower notes have a heavier touch, while the higher ones are more responsive to lighter playing. The keyboard's sensitivity can even be adjusted to match your playing style. This Graded Hammer technology also enables the DGX-640 to provide authentic touch in a lightweight instrument.

Performance assistant technology

► Page 43

Play along with a song on the instrument's keyboard and produce a perfect performance every time ... even if you play wrong notes! All you have to do is play on the keyboard—alternately on the left- and right-hand ranges of the keyboard, for example—and you'll sound like a pro as long as you play in time with the music.

And if you can't play with both hands, you can still play the melody simply by tapping one key.



All you need is one finger!

Play a Variety of Instrument Voices

► Page 18

With the DGX-640, the instrument voice that sounds when you play the keyboard can be changed to violin, flute, harp, or any of an extensive range of voices. You can change the mood of a song written for piano, for example, by using violin to play it instead. Experience a whole new world of musical variety.



Play Along with Styles

► Page 24

Want to play with full accompaniment? Try the auto-accompaniment Styles. The accompaniment styles provide the equivalent of a full backing band covering wide variety of styles from waltzes to 8-beat to euro-trance ... and much more. Select a style that matches the music you want to play, or experiment with new styles to expand your musical horizons.

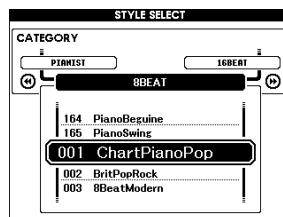

Easy Performance with Music Notation Display

► Page 32

When you play back a song, the corresponding score will be shown on the display as the song plays. This is a great way to learn how to read music. If the song contains lyric and chord data*, the lyrics and chords will also appear on the score display.

* No lyrics or chords will appear on the display if the song you are using with the score display function does not contain the appropriate lyric and chord data.

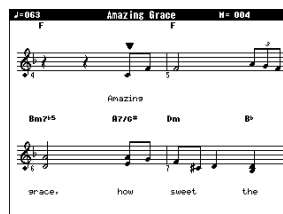

Contents

About this Owner's Manual and Data List	7
Included Accessories	7
Special Features	8

Setting Up

Setting Up	10
Keyboard Stand Assembly	10
Power Requirements	13
Connecting Headphones (PHONES/OUTPUT Jack)	13
Connecting a Footswitch (SUSTAIN Jack)	13
Connecting a Pedal Unit (PEDAL UNIT jack)	14
Connecting to a Computer (USB Terminal)	15
Turning the Power On	15
Panel Controls and Terminals	16

Quick Guide

Try Playing a Variety of Instrument Voices	18
Select and Play a Voice—MAIN	18
Play the Grand Piano Voice	19
Play Two Voices Simultaneously—DUAL	20
Play Different Voices with the Left and Right Hands—SPLIT	21
The Metronome	22
Start the Metronome	22
Adjusting the Metronome Tempo	22
Setting the Time Signature	23
Playing Styles	24
Select a Style Rhythm	24
Play Along with a Style	25
Playing Songs	28
Select and Listen to a Song	28
Select and Play Songs on a USB Flash Memory	30
Song Fast Forward, Fast Reverse, and Pause	31
Play the Demo Song	31
Displaying the Song Score	32
Display the Lyrics	33

Reference

Basic Operation	34
Select a Song For a Lesson	38
The Easy Way to Play Piano	43
Play Using the Music Database	53
Change a Song's Style	54
Record Your Own Performance	56
Memorize Your Favorite Panel Settings	62
Backup and Initialization	64
Backup	64
Initialization	64
Play with a Variety of Effects	65
Adding Harmony	65
Adding Reverb	66
Adding Chorus	66

Adding DSP	67
Panel Sustain	68
Pitch Bend	68
Select an EQ Setting for the Best Sound	69

Handy Performance Features 70

Tap Start	70
One Touch Setting	70
Setting the Click bell sound	70
Adjusting the Metronome Volume	71
Changing the Display Language	71

Voice Settings 72

Voice Editing	72
Selecting a Dual Voice	73
Selecting a Split Voice	73
Pitch Controls (Transpose)	74
Pitch Controls (Tuning)	74
Touch Response Sensitivity	75

Style (Auto-accompaniment) Functions 76

Pattern Variation (Sections)	76
Changing the tempo of the Style	79
Adjusting the Style Volume	79
Setting the Split Point	80
Play a Style with Chords but No Rhythm (Stop Accompaniment)	80
AI Fingered	81
Playing Styles Using the Entire Keyboard	81
Looking Up Chords Using the Chord Dictionary	82

Song Settings 83

Changing the tempo of the Song	83
Song Volume	83
A-B Repeat	84
Muting Independent Song Tracks	84
Change the Melody Voice	84
BGM Playback	85
Random Song Playback	85

The Functions 86

Selecting and Setting Functions	86
---------------------------------------	----

Saving and Loading Data 90

Connecting a USB Flash Memory	90
Precautions when using the USB TO DEVICE terminal	91
Using USB Storage Devices	91

Connecting to a Computer 97

Connecting a Personal Computer	97
Transferring Performance Data to and from a Computer	98
Transferring Data Between the Computer and Instrument	99

Accessory CD-ROM Installation Guide 102

Important Notices about the CD-ROM	102
CD-ROM Contents	103
System Requirements	104
Software Installation	104

Appendix

Troubleshooting	109
Messages	110
Specifications	112
Index	113

Setting Up

Keyboard Stand Assembly

⚠ CAUTION

Read these cautions carefully before you assemble or use the keyboard stand.

These cautions are to promote safe use of the stand and to prevent injury and damage from occurring to you and others. By following these cautions carefully, your keyboard stand will provide you with safe and prolonged use.

- Be careful not to confuse parts, and be sure to install all parts in the correct direction. Please assemble in accordance with the sequence given below.
- Assembly should be carried out by at least two persons.
- Be sure to use the correct screw size, as indicated below. Use of incorrect screws can cause damage.
- Use the stand after assembly is complete. An uncompleted stand may overturn or the keyboard may drop.
- Always place the stand on a flat, stable surface. Placing the stand on uneven surfaces may cause it to become unstable or overturn, the keyboard to drop, or injury.
- Do not use the stand for anything other than its designed purpose. Placing other objects on the stand may result in the object dropping or the stand overturning.
- Do not apply excessive force to the keyboard as it may cause the stand to overturn or the keyboard to drop.
- Make sure the stand is sturdy and safe, and all screws have been tight and firm before use. If not, the stand may overturn, the keyboard may drop, or may result in injury to the user.
- To disassemble, reverse the assembly sequence given below.

Have a phillips-head (+) screwdriver of the appropriate size ready.

- 1** The parts shown in the “Assembly Parts” illustration will be used. Follow the assembly instructions and select the parts as needed.

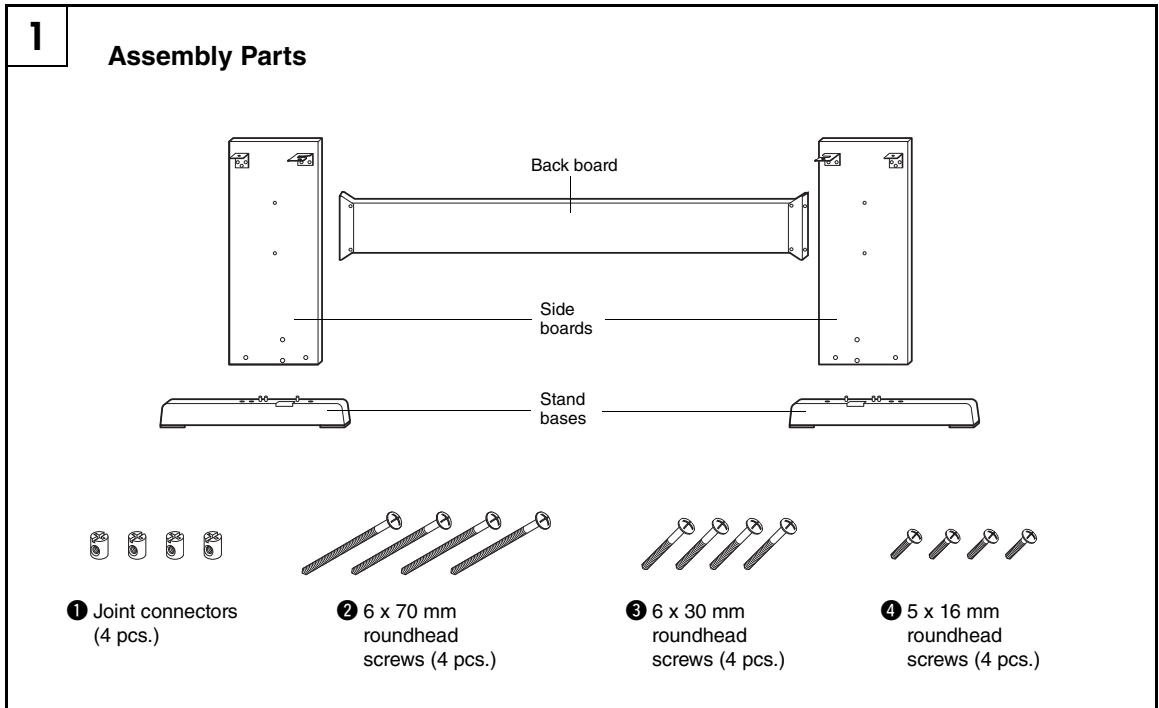

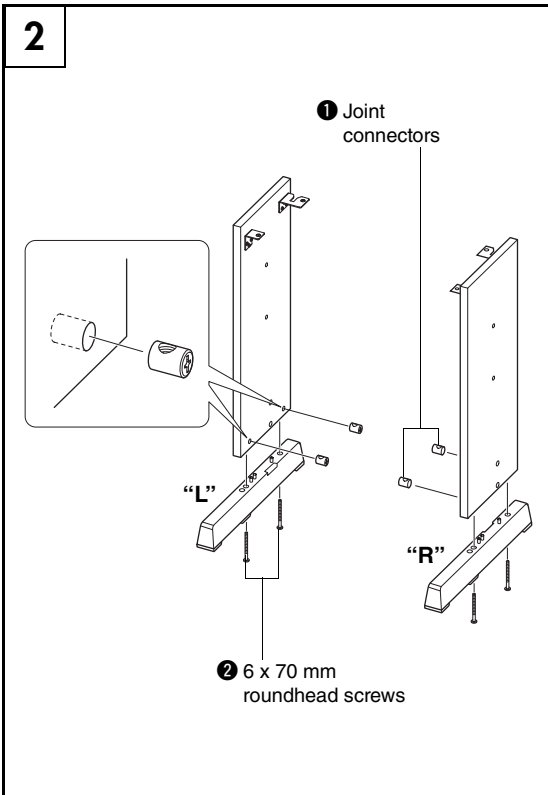

2 Attach the stand bases.

Insert the joint connectors ① into the side boards as shown. The joint connectors have been installed properly if you can see the screw head on the connector.

NOTE

- If you put the connectors in wrong direction and want to take them out, tap around the holes on the boards.

Attach the “L” (Left) and “R” (Right) stand bases to the bottom of the side boards, using the screws ②. “L” (Left) and “R” (Right) are marked on the upper surfaces of the stand bases. If you have trouble fastening the screws, use a screwdriver to rotate the joint connectors so that the connector holes are aligned with the screw holes on the stand bases.

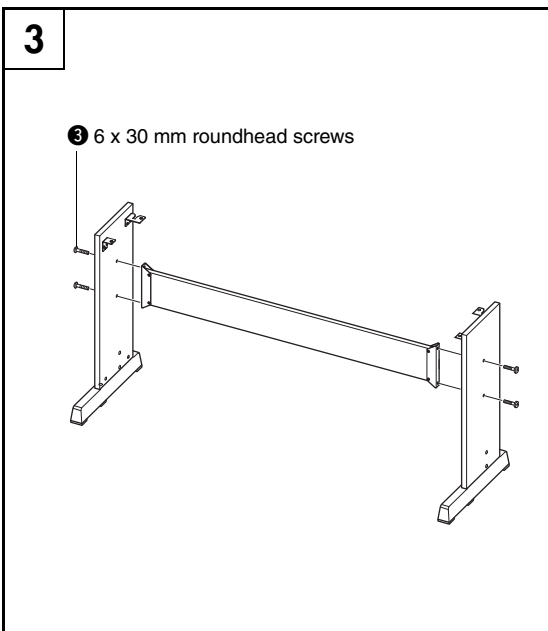

3 Attach the back board.

Attach the back board, using the screws ③. Check the back-to-front orientation for the side boards. Make sure the non-colored surface is facing down.

CAUTION

- Be careful not to drop the back board or touch the sharp metal fittings.

NOTE

- If you have purchased an optional pedal unit, attach the pedal unit before proceeding to the next step. Refer to the instructions provided with your pedal unit.

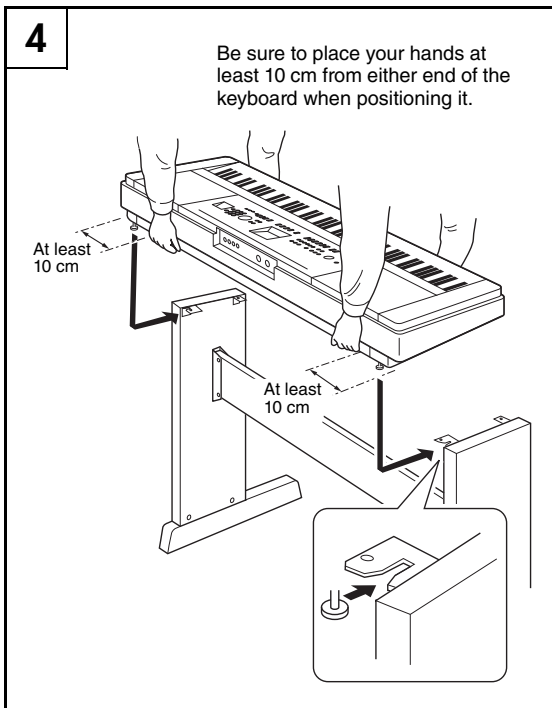

4 Put the keyboard on the stand.

Check the back-to-front orientation for stand, and carefully place the keyboard on the side boards. Slowly move the keyboard so that the holes on the bottom of the keyboard are properly aligned with the holes on the angle brackets.

CAUTION

- Be careful not to drop the keyboard or to get your fingers caught between the keyboard and the stand parts.
- Do not hold the keyboard in any position other than the position shown in the illustration.

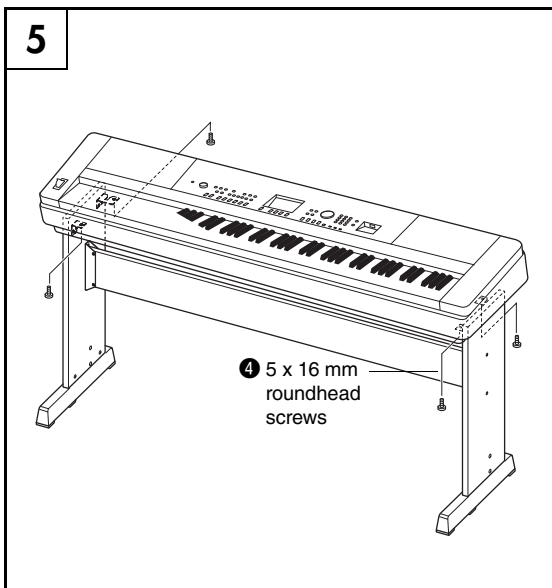

5 Install the keyboard to the stand.

Fix the keyboard to the angle brackets, using the screws ④.

Post-assembly checklist

Once you've assembled the stand, check the following points:

- Are there any parts left over?
 - If so, read the assembly instructions again and correct any errors you might have made.
- Is the instrument clear of doors and other movable fixtures?
 - If not, move the instrument to an appropriate location.
- Does the instrument make a rattling noise when you play it or move it?
 - If so, properly tighten all screws.
- Also, if the keyboard makes a creaking noise or seems unsteady when you play it, refer carefully to the assembly instructions and diagrams and retighten all screws.

Be sure to do the following operations **BEFORE** turning on the power.

Power Requirements

- 1 Make sure that the [⏻] (Standby/On) switch of the instrument is in the “Standby” position.

⚠ WARNING

- Use the specified adaptor (page 112). The use of other adaptors may result in irreparable damage to both the adaptor and the instrument.

- 2 Connect the AC adaptor to the power supply jack.
- 3 Plug the AC adaptor into an AC outlet.

⚠ CAUTION

- Unplug the AC Power Adaptor when not using the instrument, or during electrical storms.

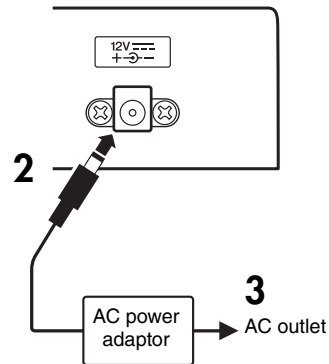

Make all necessary connections below **BEFORE** turning the power on.

Connecting Headphones (PHONES/OUTPUT Jack)

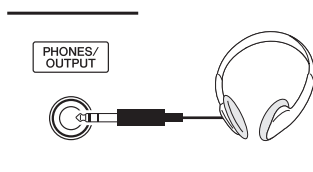

Any pair of stereo headphones with a 1/4" stereo phone plug can be plugged in here for convenient monitoring. The speakers are automatically shut off when a plug is inserted into this jack.

The PHONES/OUTPUT jack also functions as an external output. You can connect the PHONES/OUTPUT jack to a keyboard amplifier, stereo system,

mixer, tape recorder, or other line-level audio device to send the instrument's output signal to that device.

⚠ WARNING

- Avoid listening with the headphones at high volume for long periods of time; doing so may not only result in ear fatigue, it may be damaging to your hearing.

⚠ CAUTION

- To prevent damage to the speakers, set the volume of the external devices at the minimum setting before connecting them. Failure to observe these cautions may result in electric shock or equipment damage. Also, be sure to set the volumes of all devices at their minimum levels and gradually raise the volume controls while playing the instrument to set the desired listening level.

Connecting a Footswitch (SUSTAIN Jack)

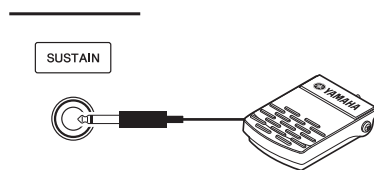

The sustain function lets you produce a natural sustain as you play by pressing a footswitch. Plug the supplied footswitch into this jack and use it to switch sustain on and off.

NOTE

- The sustain function does not affect split voices.
- Make sure that the footswitch plug is properly connected to the SUSTAIN jack before turning on the power.
- Do not press the footswitch while turning the power on. Doing this changes the recognized polarity of the footswitch, resulting in reversed footswitch operation.

Connecting a Pedal Unit (PEDAL UNIT jack)

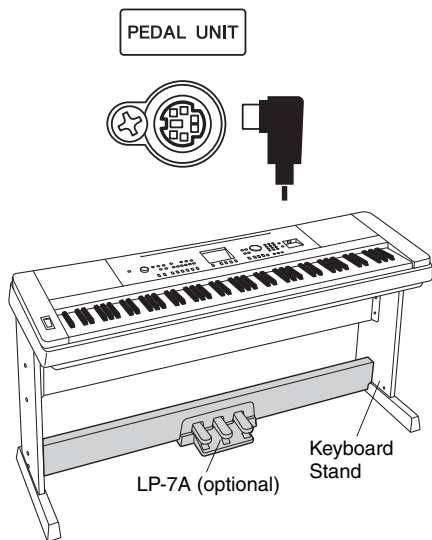

This jack is for connecting an optional LP-7A pedal unit. When connecting the pedal unit, make sure to also assemble the unit on the supplied keyboard stand.

NOTE

- Make sure that power is OFF when connecting or disconnecting the pedal.

Pedal Unit Functions

The optional pedal unit has three foot pedals that produce a range of expressive effects similar to those produced by the pedals on an acoustic piano. The pedal unit does not affect the split voice when the keyboard is in split mode.

Damper (Right) Pedal

The damper pedal functions in the same way as a damper pedal on an acoustic piano. When the damper pedal is pressed, notes sustain longer. Releasing the pedal immediately stops (damps) any sustained notes. A “half-pedal” effect lets you use the damper pedal to create partial sustain effects, depending on how far down you press the pedal.

* When using both the Footswitch and pedal unit, the last effect applied takes priority.

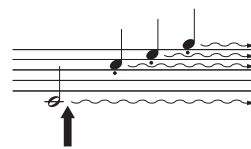
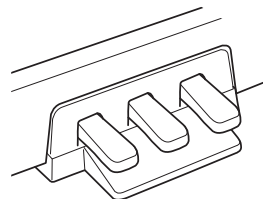

When you press the damper pedal here, the notes you play before you release the pedal have a longer sustain.

Sostenuto (Center) Pedal

If you play a note or chord on the keyboard and press the sostenuto pedal while the note(s) are held, those notes will sustain as long as you hold the pedal (as if the damper pedal had been pressed) but all subsequently played notes will not be sustained. This makes it possible to sustain a chord, for example, while other notes are played “staccato.”

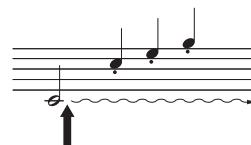

When you press the sostenuto pedal here while holding the note, the note will sustain as long as you hold the pedal.

Soft (Left) Pedal

The soft pedal reduces the volume and slightly changes the timbre of notes played while the pedal is pressed. The soft pedal will not affect notes that are already playing when it is pressed.

Connecting to a Computer (USB Terminal)

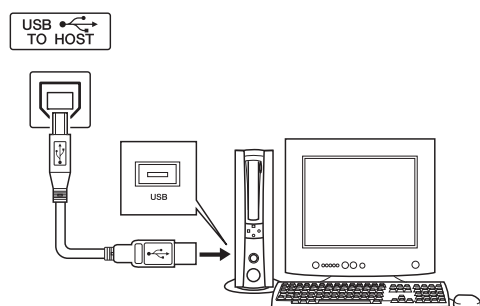

Connect the instrument's USB terminal to the USB terminal of a computer, and you can transfer performance data and song files between the two (page 97).

Turning the Power On

The [⏻](Standby/On) switch turns the power to the instrument on (■) or standby (■).

Turn down the volume by turning the [MASTER VOLUME] control to the left and press the [⏻](Standby/On) switch to turn on the power. Press the [⏻](Standby/On) switch again to turn the power off.

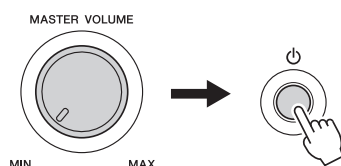

Backup data in the flash memory is loaded to the instrument when the power is turned on. If no backup data exists on flash memory, all instrument settings are restored to the initial factory defaults when the power is turned on.

⚠ CAUTION

- Even when the switch is in the "STANDBY" position, electricity is still flowing to the instrument at the minimum level. When you are not using the instrument for a long time, make sure you unplug the AC power adaptor from the wall AC outlet.

NOTICE

- Never attempt to turn the power off when a "WRITING!" message is shown in the display. Doing so can damage the flash memory and result in a loss of data.

Panel Controls and Terminals

Front Panel

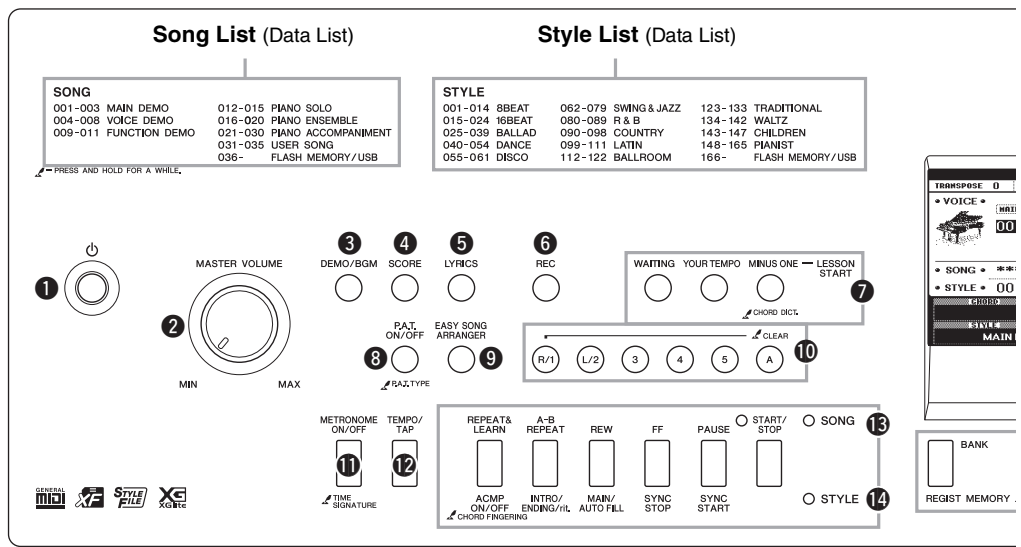

Front Panel

- ① [⏻](Standby/On) switch..... page 15
- ② [MASTER VOLUME] control page 15
- ③ [DEMO/BGM] button pages 31, 85
- ④ [SCORE] button..... page 32
- ⑤ [LYRICS] button..... page 33
- ⑥ [REC] button..... page 56
- ⑦ LESSON START
 - [WAITING] button..... page 38
 - [YOUR TEMPO] button page 40
 - [MINUS ONE] button..... page 41
- ⑧ [P.A.T. ON/OFF] button page 44
- ⑨ [EASY SONG ARRANGER] button page 54
- ⑩ Song Track
 - [1]–[5], [A] buttons..... pages 57, 84
 Lesson
 - [R/1] and [L/1] buttons page 38
- ⑪ [METRONOME ON/OFF] button page 22
- ⑫ [TEMPO/TAP] button..... pages 22, 79, 83
- ⑬ SONG
 - [REPEAT&LEARN] button..... page 42
 - [A-B REPEAT] button..... page 84
 - [REW] button..... page 31
 - [FF] button..... page 31
 - [PAUSE] button page 31
 - [START/STOP] button page 29
- ⑭ STYLE
 - [ACMP ON/OFF] button page 25
 - [INTRO/ENDING/rit.] button page 76
 - [MAIN/AUTO FILL] button page 76
 - [SYNC STOP] button page 78
 - [SYNC START] button..... page 77
 - [START/STOP] button..... pages 24, 26
- ⑮ REGIST MEMORY [BANK],
 - [1]–[4] buttons page 62
- ⑯ CATEGORY [◀] and [▶] buttons page 35
- ⑰ [EXIT] button page 36
- ⑱ [FUNCTION] button..... pages 36, 86
- ⑲ DATA ENTRY
 - Dial, Number buttons [0]–[9], [+], and [-] buttons..... page 35
- ⑳ [FILE CONTROL] button..... page 90
- ㉑ [EXECUTE] button page 92
- ㉒ [PORTABLE GRAND] button..... page 19
- ㉓ [SONG] button..... page 28
- ㉔ [STYLE] button..... page 24
- ㉕ [VOICE] button page 18
- ㉖ [MUSIC DATABASE] button..... page 53
- ㉗ [SPLIT ON/OFF] button page 21
- ㉘ [DUAL ON/OFF] button page 20
- ㉙ [HARMONY ON/OFF] button page 65
- ㉚ [PITCH BEND] wheel page 68
- ㉛ Drum Kit page 19
 - The illustrations next to each key indicate the drum and percussion instruments assigned to the keys when “Standard Kit 1” is selected.
- ㉜ USB TO DEVICE terminal pages 30, 90

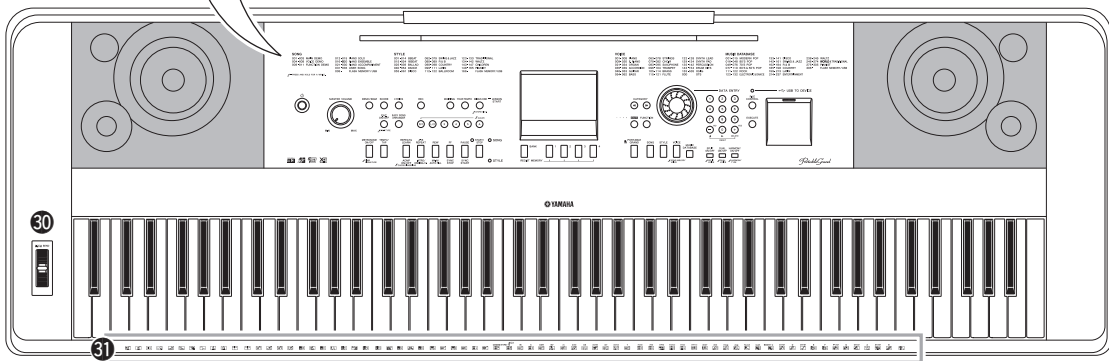
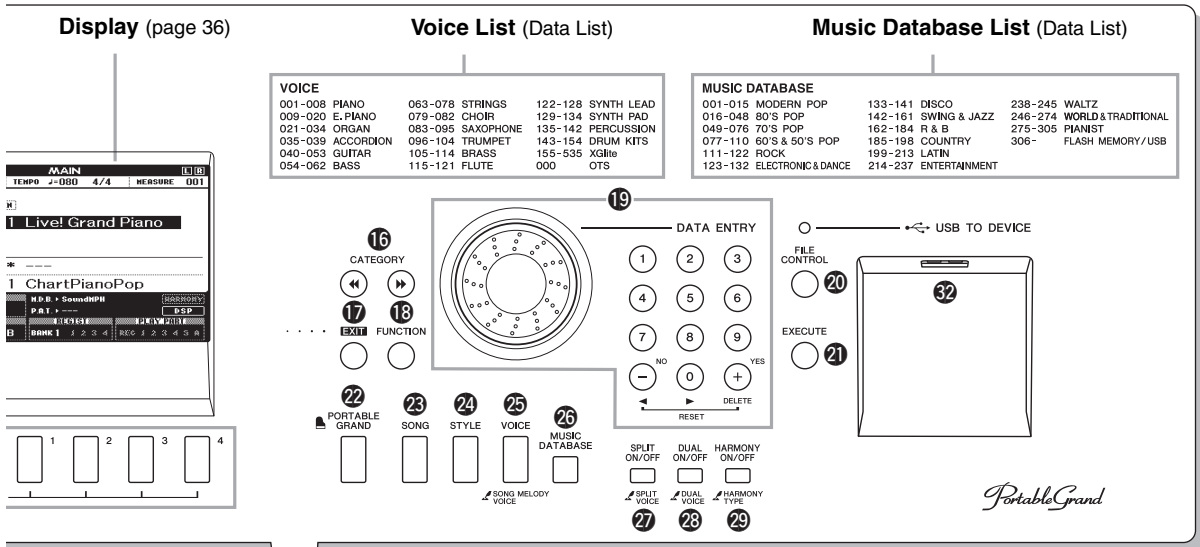

Rear Panel

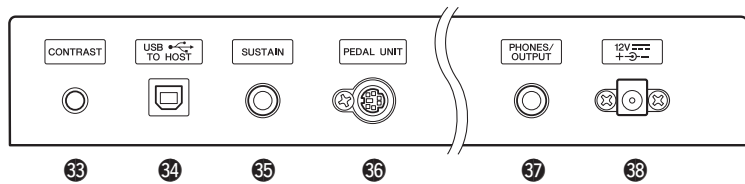

Rear Panel

- 33 CONTRAST knobpage 37
- 34 USB TO HOST terminal.....page 97
- 35 SUSTAIN jackpage 13
- 36 PEDAL UNIT jackpage 14
- 37 PHONES/OUTPUT jack.....page 13
- 38 DC IN jack.....page 13

Try Playing a Variety of Instrument Voices

In addition to piano, organ, and other “standard” keyboard instruments, this instrument has a large range of voices that includes guitar, bass, strings, sax, trumpet, drums and percussion, sound effects ... a wide variety of musical sounds.

Select and Play a Voice—MAIN

This procedure selects the main voice you will play on the keyboard.

1 Press the [VOICE] button.

The main voice selection display will appear.

The currently selected voice number and name will be highlighted.

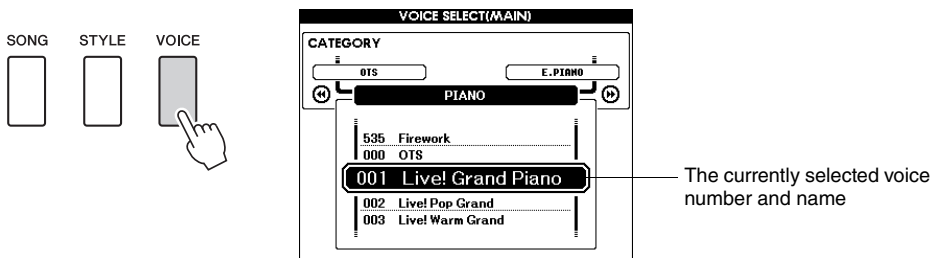

2 Select the voice you want to play.

While watching the highlighted voice name rotate the dial. The available voices will be selected and displayed in sequence. The voice selected here becomes the main voice.

For this example select the “117 Flute” voice.

NOTE 1

- See the separate Data List for a complete list of the available voices.

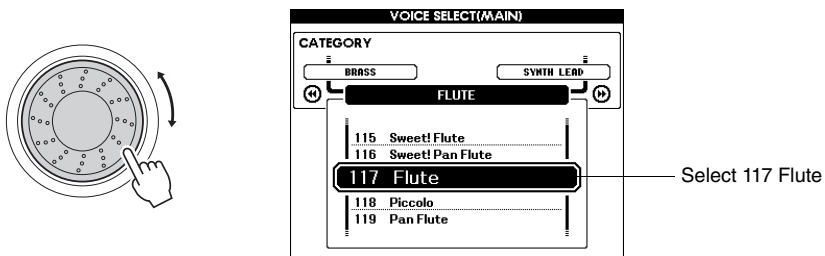

3 Play the keyboard.

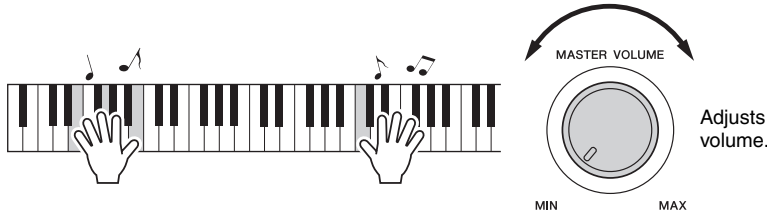

NOTE 1

- Voice Settings (page 72)

Try selecting and playing a variety of voices.
Press the [EXIT] button to return to the MAIN display.

Preset Voice Types

001–142 155–535	Instrument Voices
143–154 (Drum Kit)	Various drum and percussion sounds are assigned to individual keys, via which they can be played. Details on assigning instruments to keys are provided in the Drum Kit List of the separate Data List.

Play the Grand Piano Voice

When you just want to play piano, all you have to do is press one convenient button.

Press the [PORTABLE GRAND] button.
The “001 Live! Grand Piano” voice will be selected.



NOTE 1

- When you press the [PORTABLE GRAND] button all settings other than touch sensitivity are turned off. The dual and split voices will also be turned off, so only the Grand Piano voice will play over the entire keyboard.

Play Two Voices Simultaneously—DUAL

Once you press the [DUAL ON/OFF] button to turn the dual function on, a second voice will sound that will play in addition to the main voice when you play the keyboard. The second voice is known as the “dual” voice. The currently selected dual voice name and number will be displayed in the MAIN display.

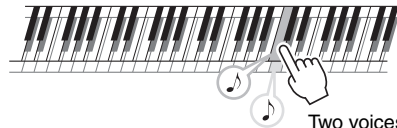
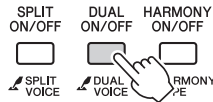

Two voices will sound at the same time.

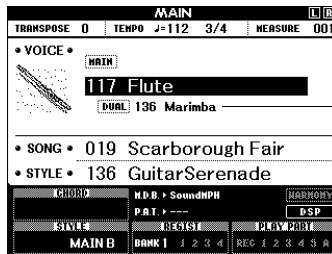

Dual voice number and name

Press the button a second time to turn the dual voice function off.

A suitable dual voice is automatically selected when you turn on this function, but you can easily select a different dual voice (page 73).

Play Different Voices with the Left and Right Hands—SPLIT

Once you press the [SPLIT ON/OFF] button to turn the split function on, you can play different voices to the left and right of the keyboard “split point”. The main and dual voices can be played to the right of the split point, while the voice played to the left of the split point is known as the “split voice”. The currently selected split voice name and number will be displayed in the MAIN display. The split point setting can be changed as required (page 80).

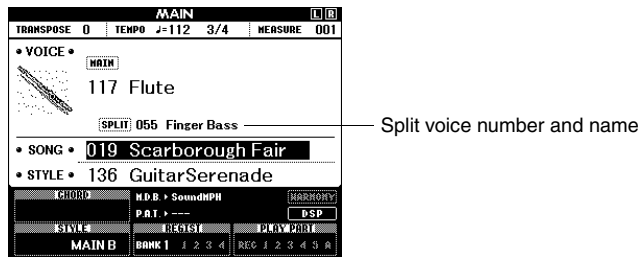
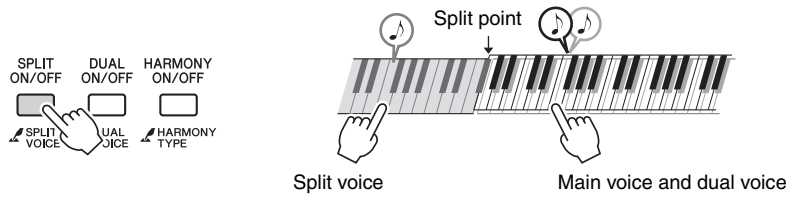

Press the button a second time to turn the split voice function off.

A suitable split voice is automatically selected when you turn on this function, but you can easily select a different split voice (page 73).

The Metronome

The instrument includes a metronome with adjustable tempo and time signature. Play and set the tempo that is most comfortable for you.

Start the Metronome

Turn the metronome on and start it by pressing the [METRONOME ON/OFF] button.

To stop the metronome, press the [METRONOME ON/OFF] button again.

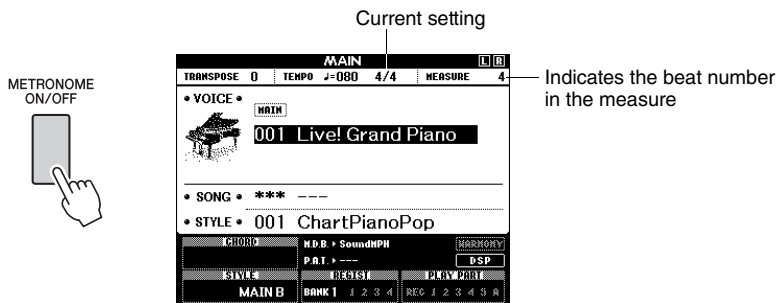

Adjusting the Metronome Tempo

- 1 Press the [TEMPO/TAP] button to call up the tempo setting.

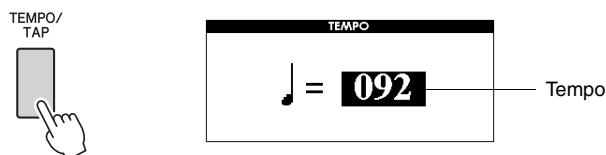

- 2 Use the dial to select a tempo from 5 to 280.

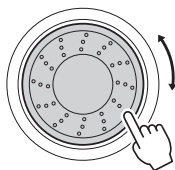

Setting the Time Signature

In this example we'll set up a 5/8 time signature.

- 1 Press and hold the [METRONOME ON/OFF] button for longer than a second to select the function "Time Signature–Numerator".

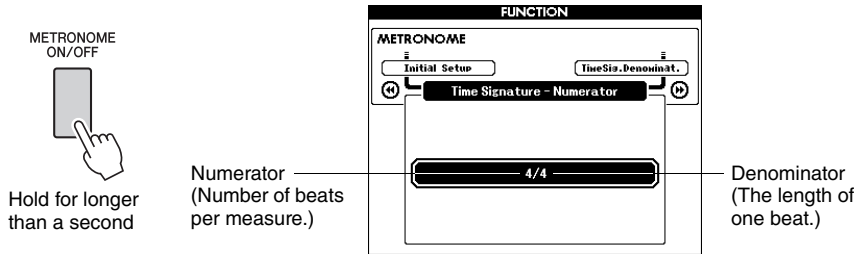

- 2 Use the dial to select the number of beats per measure.

The available range is from 1 through 60. Select 5 for this example. A bell accent will be sounded at the first beat of each measure.

NOTE

- The metronome time signature will synchronize to a style or song that is playing, so these parameters cannot be changed while a style or song is playing.

- 3 Press the CATEGORY [◀] and [▶] buttons as many times as necessary to select the beat length function "Time Signature–Denominator".

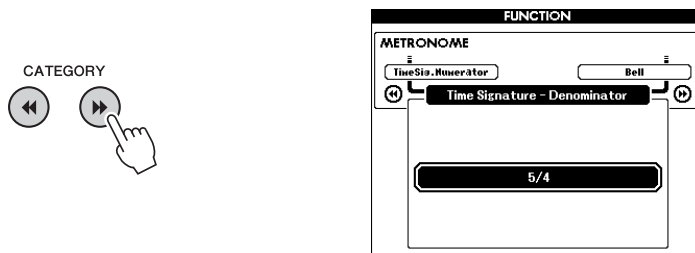

- 4 Use the dial to select the beat length.

Select the required length for each beat: 2, 4, 8, or 16 (half note, quarter note, eighth note, or 16th note). Select 8 for this example.

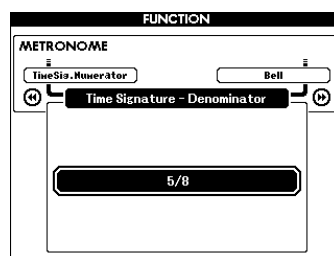

Playing Styles

This instrument has an auto accompaniment feature that produces accompaniment (rhythm + bass + chords) in the style you choose to match chords you play with your left hand. You can select from 165 different styles covering a range of musical genres and time signatures. In this section we'll learn how to use the auto accompaniment features.

Select a Style Rhythm

Most styles includes a rhythm part. You can select from a wide variety of rhythmic types—rock, blues, Euro trance, and many, many more. Let's begin by listening to just the basic rhythm. The rhythm part is played using percussion instruments only.

1 Press the [STYLE] button.

The style select display will appear. The currently selected style number and name will be highlighted.

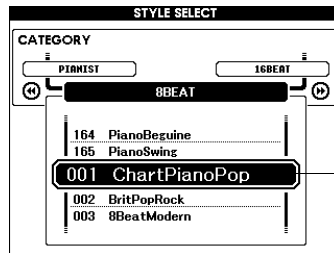
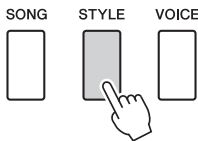

The currently selected style

2 Select a style.

Use the dial to select the style you want to use. A list of all the available styles is provided in the Style List of the separate Data List.

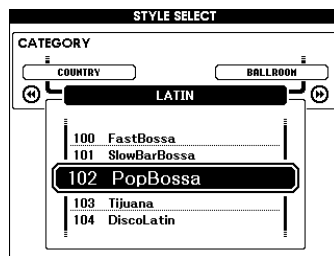
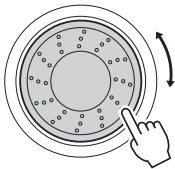

NOTE

- You can also use the style files provided on the supplied CD-ROM (page 102).

3 Press the [START/STOP] button.

The style rhythm will start playing. Press the [START/STOP] button a second time when you want to stop playback.

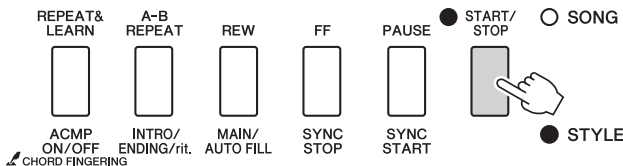

NOTE

- The "Serenade" style in the Waltz category and all styles in the Pianist category have no rhythm part and therefore no rhythm will play if you use them for the above example. For these styles first turn auto accompaniment on as described on page 25, press the [START/STOP] button, and the accompaniment bass and chord parts will begin playing when you play a key to the left of the keyboard split point.

Play Along with a Style

You learned how to select a style rhythm on the preceding page. Here we'll see how to add bass and chord accompaniment to the basic rhythm to produce a full, rich accompaniment that you can play along with.

1 Press the [STYLE] button and select the desired style.

For this example select the "153 PianoBoogie" style.

2 Turn automatic accompaniment on.

Press the [ACMP ON/OFF] button. Pressing this button a second time will turn automatic accompaniment off.

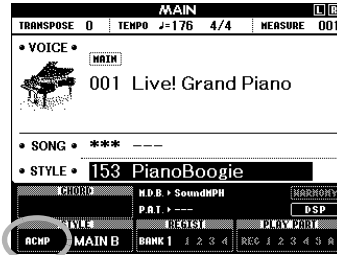
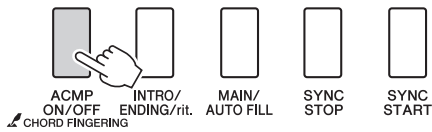

This icon appears when automatic accompaniment is on.

When automatic accompaniment is on ...
 The area of the keyboard to the left of the split point (54: F#2) becomes the "auto accompaniment range" and is used only for specifying the accompaniment chords.

3 Turn sync start on.

Press the [SYNC START] button to turn the sync start function on.

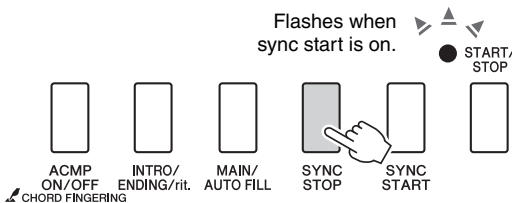

When sync start is on, the bass and chord accompaniment included in a style will start playing as soon as you play a note to left of the keyboard split point. Press the button a second time to turn the sync start function off.

4 Start playing.

Style playback will begin as soon as you play a chord in the accompaniment range of the keyboard. Try playing the chord progression shown below. The accompaniment will change according to the left-hand notes you play.

NOTE 1

- Chords (page 27)
- Looking Up Chords Using the Chord Dictionary (page 82)

The diagram illustrates the auto-accompaniment range on a piano keyboard, marked by a bracket and labeled 'Auto accompaniment range'. A 'Split point' is indicated by a vertical line. Below the keyboard, two musical staves show chord progressions. The first staff shows chords C, F, and C, and the second staff shows G, F, and C. Each chord is accompanied by a small keyboard diagram showing the chord's fingering.

This progression provides varied harmonic backing with just three chords. When you get a feel for the progression in the score, try changing the order of the chords!

Indicates the chord currently being played in the accompaniment range of the keyboard.



5 Stop playing.

Press the [START/STOP] button to stop style playback when you're done.

NOTE 1

- You can also stop playing by pressing the [INTRO/ENDING/rit.] button so that an appropriate ending pattern will play and then style playback will stop.

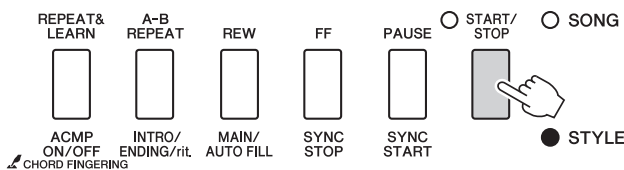

NOTE 1

- You can switch style "sections" to add variety to the accompaniment. Refer to "Pattern Variation (Sections)" on page 76.

Chords

For users who are new to chords, this chart features common chords. Since there are many useful chords and many different ways to use them musically, refer to commercially available chord books for further details.

★ indicates the root note.

Major	Minor	Seventh	Minor Seventh	Major Seventh
C 	Cm 	C7 	Cm7 	CM7
D 	Dm 	D7 	Dm7 	DM7
E 	Em 	E7 	Em7 	EM7
F 	Fm 	F7 	Fm7 	FM7
G 	Gm 	G7 	Gm7 	GM7
A 	Am 	A7 	Am7 	AM7
B 	Bm 	B7 	Bm7 	BM7

- A wide variety of chord types can be recognized as well as the above chord types.
- Depending on the chord type, inversions can be used as well as in "root" position.
- Some chord types may not be recognized if some notes are omitted.

Easy Chords

This method lets you easily play chords in the accompaniment range of the keyboard using only one, two, or three fingers.

For root "C"



To play a major chord
Press the root note (★) of the chord.



To play a minor chord
Press the root note together with the nearest black key to the left of it.



To play a seventh chord
Press the root note together with the nearest white key to the left of it.



To play a minor seventh chord
Press the root note together with the nearest white and black keys to the left of it (three keys altogether).

AI Finger

By changing the chord fingering type to "AI Fingered", you can automatically produce appropriate accompaniment even if you don't press all of the notes which comprise a chord. (pages 81 and 87)

Playing Songs

With this instrument the term “song” refers the data that makes up a piece of music. You can simply enjoy listening to the 30 internal songs, or use them with just about any of the many functions provided—the performance assistant technology feature, lessons, and more. The songs are organized by category. In this section we’ll learn how to select and play songs, and briefly describe the 30 songs provided.

Select and Listen to a Song

1 Press the [SONG] button.

The song selection display will appear.

The currently selected song number and name will be highlighted.

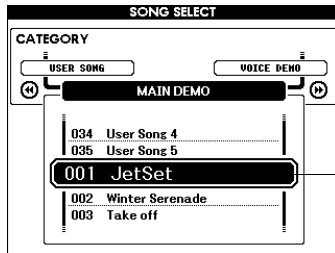
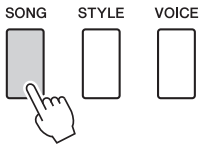

The currently selected song number and name

2 Select a song.

Select a song after referring to the Song List in the separate Data List. Use the dial to select the song you want to listen to.

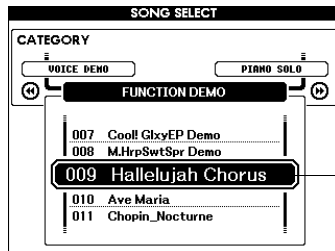
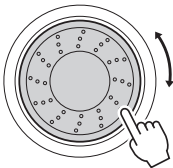

The song highlighted here can be played

NOTE

- You can also play songs you have recorded yourself (User Songs) or songs that have been transferred to the instrument from a computer in the same way that you play the internal songs.

The songs are organized by category.

SONG

- 001-003 MAIN DEMO • The songs in this category have been created to give you an idea of the advanced capabilities of this instrument.
- 004-008 VOICE DEMO • These songs features some of the instrument's many useful voices.
- 009-011 FUNCTION DEMO • Use these songs to experience some of the instrument's advanced features: song number 9 for the easy song arranger, and songs 10 and 11 for the performance assistant technology feature.
- 012-015 PIANO SOLO • These piano solo pieces are ideally suited for use as lesson songs.
- 016-020 PIANO ENSEMBLE • A selection of piano ensemble songs that are also well suited for use as lesson songs.
- 021-030 PIANO ACCOMPANIMENT • When you need to practice backing (accompaniment) patterns, these are the songs to do it with.
- 031-035 USER SONG • Songs you record yourself.
- 036- FLASH MEMORY / USB • Songs stored on a USB flash memory plugged into the instrument, or songs transferred from a computer (pages 30 and 99).

3 Listen to the song.

Press the [START/STOP] button to begin playback of the selected song.

You can stop playback at any time by pressing the [START/STOP] button again.

The red lamp lights on the first beat of every measure when a song is playing. The other beats are indicated with a green light.

NOTE 1

- Score data for the 30 internal songs are provided in the Songbook on the CD-ROM. The exceptions are songs 1 to 11 and 30. The scores for songs 9 to 11 are provided in the separate Data List.

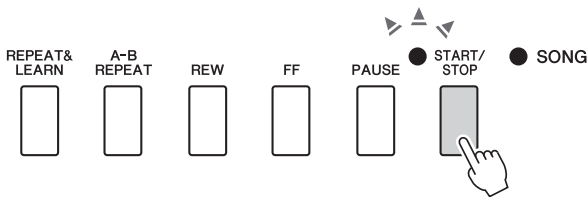

Select and Play Songs on a USB Flash Memory

MIDI songs stored on a USB flash memory connected to the instrument can be directly selected and played.

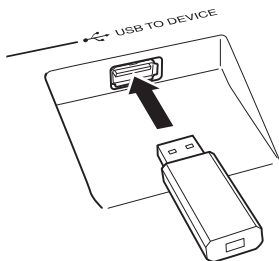

The procedure is exactly the same as that for selecting internal songs (page 28). Songs on a USB flash memory are numbered from 36 upward, so all you need to do is select song number 36 or higher.

NOTE

- Precautions when using the [USB TO DEVICE] terminal (page 91)

IMPORTANT

- In order to play data copied to a USB flash memory from a computer or other device, the data must be stored either in the USB flash memory's root directory or a first-level/second-level folder in the root directory. Data stored in third-level-folders created inside a second-level folder cannot be selected and played by this instrument.

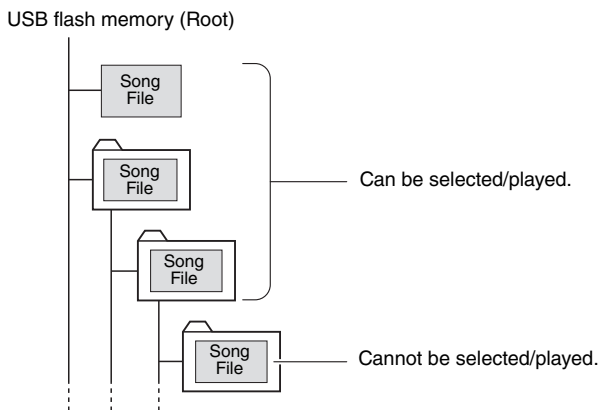

Song Title Display Language

File names containing Japanese characters will be properly displayed if the instrument's display language is set to "Japanese" (page 71).

Song Fast Forward, Fast Reverse, and Pause

These are just like the transport controls on a cassette deck or CD player, letting you fast forward [FF], rewind [REW] and pause [PAUSE] playback of the song.

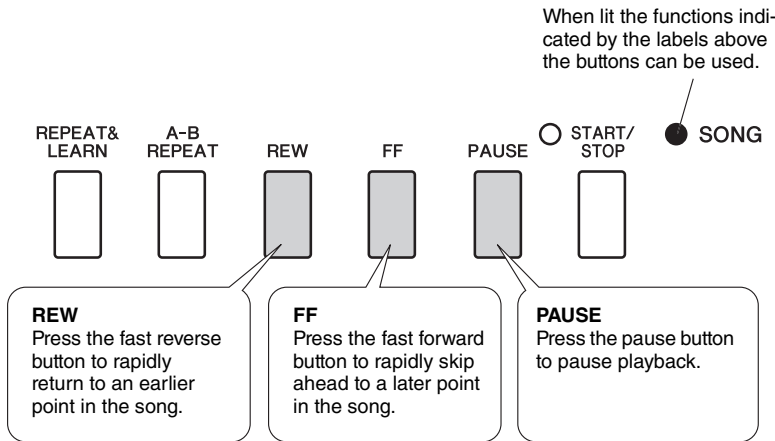

Play the Demo Song

Press the [DEMO/BGM] button. The demo song will start playing. Listen to some of the outstanding instrument voices provided!

The demo song will automatically repeat from the beginning after it has played all the way through. You can stop demo playback at any time by pressing the [DEMO/BGM] button or [START/STOP] button.



With the default setting only one demo song is played back and repeated when the [DEMO/BGM] button is pressed. This setting can be changed so that all internal songs are played, or all songs transferred to the instrument from a computer are played. Five playback group settings are provided. Simply select the one that suits your needs. (page 85)

Displaying the Song Score

This instrument is capable of display the scores of songs.

Scores are displayed for the 30 internal preset songs as well as songs in SMF format stored in a USB flash memory or the instrument's internal flash memory.

1 Select a song.

Follow steps 1 and 2 of the procedure described on page 28.

2 Press the [SCORE] button and a single-staff score will appear.

There are two types of score display: single-staff and double-staff.

These are alternately selected each time the [SCORE] button is pressed.

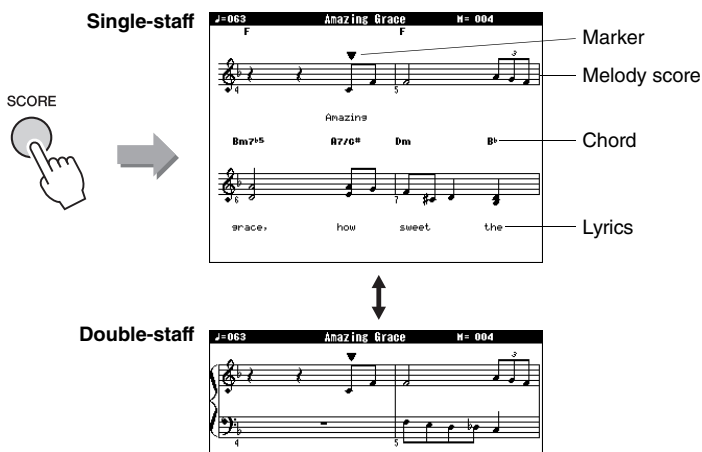

NOTE 1

- Both chords and lyrics will be shown in single-staff score display of a song that includes chord and lyric data.
- When there are many lyrics they may be displayed in two rows a measure.
- Some lyrics or chords may be abbreviated if the selected song has a lot of lyrics.
- Small notes that are hard to read may be easier to read after you use the quantize function (page 88).

NOTE 2

- No chords or lyrics are shown on the double-staff.

NOTE 3

- If the song volume is turned all the way down at this point you will be able to hear only the sound of your own performance so that you can play the song yourself while reading the score. Refer to page 83 for the song volume adjustment procedure.

3 Press the [START/STOP] button.

The song will begin playing. The triangular will move across the top of the score to indicate the current location.

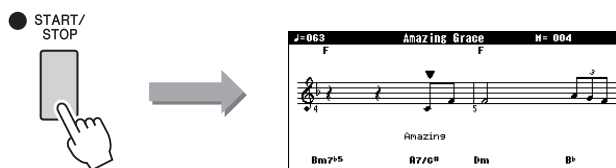

4 Press the [EXIT] button to return to the MAIN display.

Display the Lyrics

If a song contains lyric data, the lyrics can be made to appear on the display. No lyrics will be displayed for a song that contains no lyric data even if the [LYRICS] button is pressed.

1 Select a song.

Select a song 16 by performing steps 1 and 2 described on page 28. Internal song number 16 is the only internal song that provides lyric display.

NOTE 1

- Songs downloaded from the Internet or commercially available song files, including XF format files (page 6), are compatible with the lyrics display features as long as they are standard MIDI file format files containing lyric data. Lyrics display may not be possible with some files.

2 Press the [LYRICS] button.

The title, lyricist, and composer of the song will appear on the display.

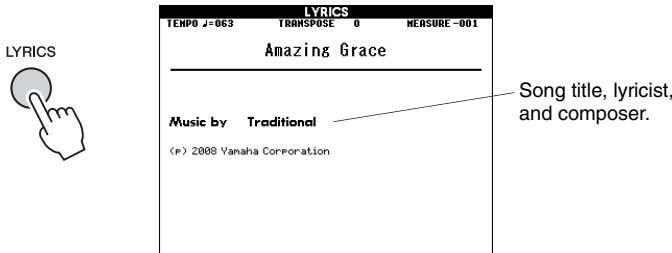

NOTE 1

- If the lyrics display shows garbled characters, try changing the display language (page 71).

3 Press the [START/STOP] button.

The song will play back while the lyrics and chords are shown on the display.

The lyrics will be highlighted to show the current location in the song.

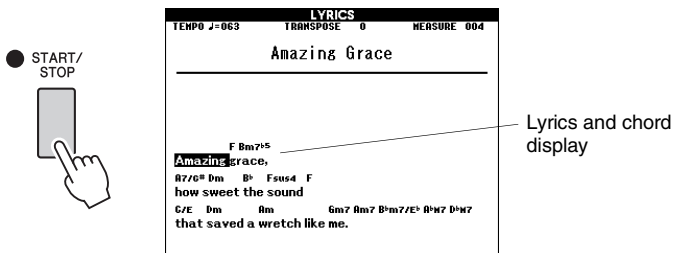

Basic Operation

Basic Operation

Overall DGX-640 control is based on the following simple operations.

- 1 Press a button to select a basic function.
- 2 Use the dial to select an item or value.
- 3 Start a function.

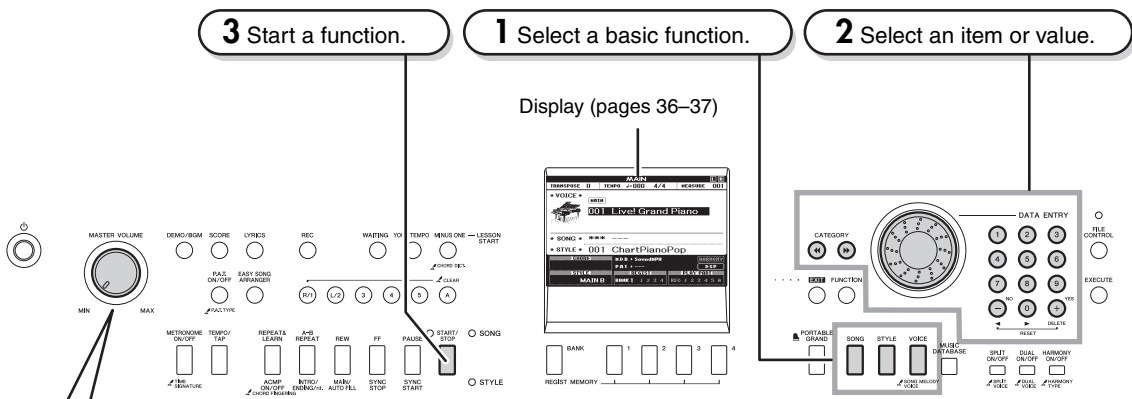

Volume Adjustment

Adjusts the volume of the sound heard via the instrument's speakers or a pair of headphones plugged into the PHONES jack.

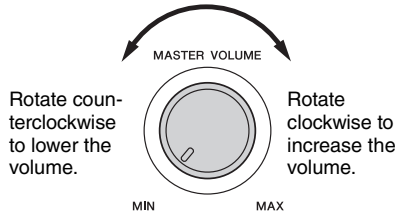

1 Press a button to select a basic function.

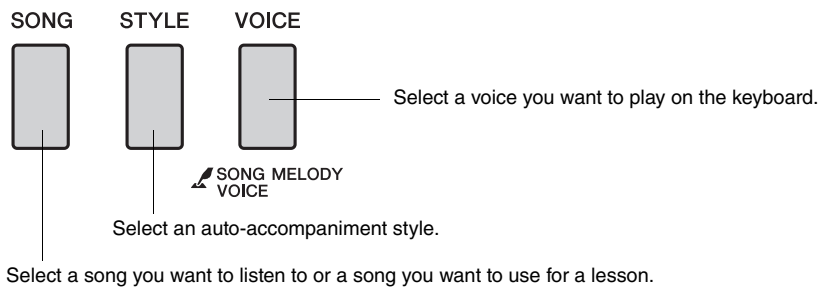

2 Use the dial to select an item or value.

When you select a basic function, the item corresponding to that function will be listed in the display. You can then use the dial or the number buttons [0]–[9] to select the desired item.

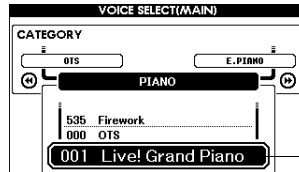

The currently selected item is highlighted in the display. In this example the [VOICE] button has been pressed.

Changing Values

Dial

Rotate the dial clockwise to increase the value of the selected item, or counterclockwise to decrease its value. Rotate the dial continuously to continuously increase or decrease the value.

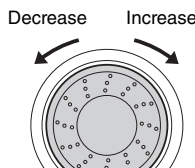

[+] and [-] Buttons

Press the [+] button briefly to increment the value by 1, or press the [-] button briefly to decrement the value by 1. Press and hold either button to continuously increment or decrement the value in the corresponding direction.

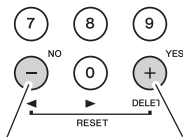

Press briefly to decrement. Press briefly to increment.

Number Buttons [0]–[9]

The number buttons can be used to directly enter a song number or parameter value. Hundreds or tens digits that are "0" can be omitted (see below).

Example: Song number "003" can be entered in three ways.

- [0] → [0] → [3]
 - [0] → [3]
 - [3]
- ("003" will appear on the display after a brief delay)

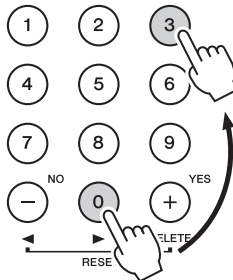

Press number buttons [0], [0], [3].

CATEGORY [◀] and [▶] buttons

When selecting a song, style, or voice, you can use these buttons to jump to the first item in the next or previous category.

The CATEGORY [◀] and [▶] buttons are useful for selecting categorized items, as in the example below.

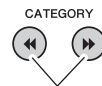

Jump to the first item in the next or previous category.

Example: VOICE SELECT Display

CATEGORY button [◀] mark.

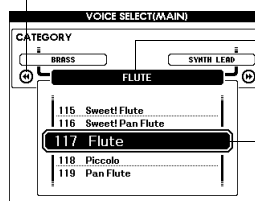

Select the category shown here.

CATEGORY button [▶] mark.

The first voice in the selected category is selected.

In a display in which a category appears, selection is easy if you first use the CATEGORY [◀] and [▶] buttons to select the category containing the desired item, then use the dial or [+] and [-] buttons to select the item. This can be particularly handy when you have to select from a large number of voices.

In most procedures described throughout this owner's manual the dial is recommended for selection simply because it is the easiest and most intuitive selection method. Please note however, that most items or values that can be selected using the dial can also be selected using the [+] and [-] buttons.

3 Start a function.

○ START/STOP



This is the [START/STOP] button.

Press the [START/STOP] button after pressing the [SONG] or [STYLE] button to start playback of the selected song or style (rhythm).

The Displays

Display Names

All operations are carried out while watching the display. A number of display types are provided for different modes and functions. The name of the current display appears at the top of the display.

MAIN Display

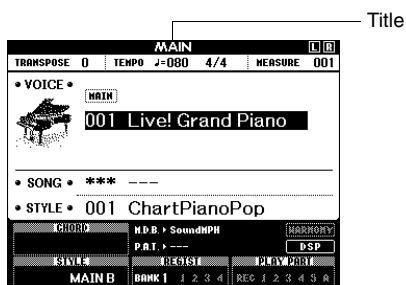

To Return To the MAIN Display



Most basic operations are carried out from the instrument's MAIN display.

You can return to the MAIN display from any other display by pressing the [EXIT] button near the lower right corner of the display panel.

FUNCTION Display

The FUNCTION display provides access to 53 utility functions (page 86).

The FUNCTION display appears when the [FUNCTION] button is pressed. In the FUNCTION display you can use the CATEGORY [◀] and [▶] buttons to select 53 different groups of functions. Press the CATEGORY button(s) as many times as necessary until the required function appears. You can then use the dial, the [+] and [-] buttons, or the number [0]–[9] buttons to adjust the value of the function as required.

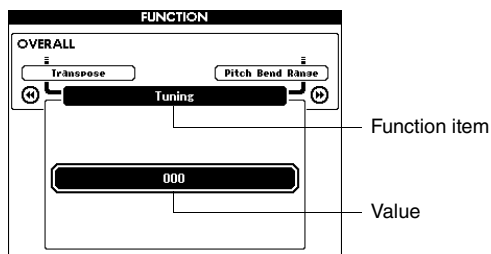

The "Press & Hold" Symbol

The "  " symbol that appears next to some buttons indicates that the button can be pressed and held for longer than a second to call up a related function. This provides convenient direct access to a range of functions.



MAIN Display Items

The MAIN display shows all of the current basic settings: song, style, voice.
It also includes a range of indicators that show the on/off status of a range of functions.

* Adjust the LCD CONTRAST control on the rear panel of the instrument for optimum display legibility.

CONTRAST



Tempo

A-B Repeat
Appears when repeat playback is engaged.

Measure Number

Transpose

VOICE
Main (page 18)
Dual (page 20)
Split (page 21)
Song (page 28)
Style (page 24)
MDB (page 53)

Chord Display

Function ON/Off Icons

Performance assistant technology
P.A.T. > CHORD
Appears when the performance assistant technology is on.

Harmony
HARMONY
Appears when Harmony is on. When this icon is showing harmony notes will be added to the main voice.

DSP
DSP
Appears when DSP is on.

Style (Auto-accompaniment) Status

ACMP **MAIN B**
ACMP Appears when auto accompaniment is on.
MAIN B Appears when the synchro-stop function is engaged.
MAIN B The style pattern name.

Registration Memory Status

REGIST
BANK 1 Shows the selected bank number.
1 2 3 4 Shows the memory numbers that contain data. A border appears around the selected number.

Song Track Status

PLAY PART
REC Highlighted during user song recording.
1 2 3 4 5 A A border is off when track is muted.

Select a Song For a Lesson

Yamaha Education Suite

You can select song you like and use it for a left-hand, right-hand, or both-hands lesson. During the lesson you can play as slowly as you like, and you can even play wrong notes. Song playback will slow down to a speed you can handle. It's never too late to start learning!

The practice methods:

Lesson 1—Waiting	→	Learn to play the correct notes.
Lesson 2—Your Tempo	→ →	Learn to play the correct notes with the correct timing.
Lesson 3—Minus One	→ → →	Learn to play the correct notes at the correct timing along with the song.

Lesson 1—Waiting

In this lesson, try playing the correct notes. Play the note shown in the display. The song will wait until you play the right note.

1 Select a song for your lesson.

Select a song from the Piano Solo, Piano Ensemble category! For this example try selecting the “012 For Elise”.

NOTE

- Song numbers 10 and 11 are function demos for performance assistant. The lesson function cannot be used with them.
- You can also use songs (only SMF format 0) transferred from the computer and saved to flash memory. (page 100)
- You can also use songs (only SMF format 0) on a USB flash memory. (page 30)

2 Press [EXIT] button to return to the MAIN display.



3 Turn off playback of the part you wish to practice.

The preset songs have separate left- and right-hand parts. You can turn the left- and right-hand parts on or off as required in order to practice the corresponding part (the part that is turned off) on the keyboard. The right-hand part is played by the [R/1] button and the left-hand part is played by the [L/2] button.

NOTE

- You can turn parts on or off, even during playback.

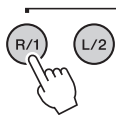

Right-hand lesson **1 2** (R part is off)

Left-hand lesson **1 2** (L part is off)

Both-hands lesson **1 2** (R and L parts are off)

Pressing the part buttons [R/1] and [L/2] toggles part playback on and off. Turn off playback of the part you wish to practice. When you first select a song, both “1” and “2” indicators with borders light up, indicating that both parts are on.

When you press one of the buttons to turn off playback, the border around the corresponding part indicator disappears and the corresponding part playback is muted.

4 Start Lesson 1.

Press the [Waiting] button to start Lesson 1.



Song playback will begin automatically when you select Lesson 1.

Play the notes shown in the on-screen score. The next note to be played is indicated by a dot (●) on the appropriate key of the graphic on-screen keyboard. When you play the correct note the marker will move to the next key to be played. Playback will pause and wait for you to play the correct note. The triangular marker (▼) above the score indicates playback progress.

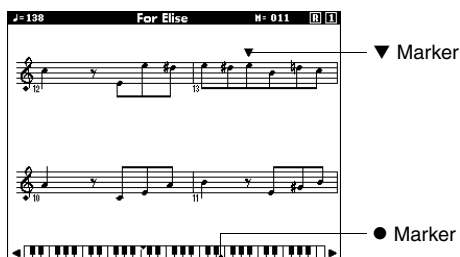

Shifting the keyboard left or right.

The hidden () areas of the keyboard can be brought into view by pressing the [+] or [-] button

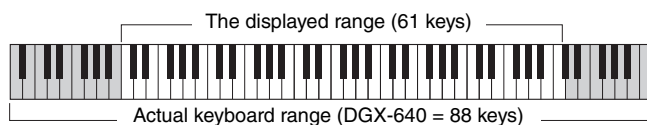

61 keys of the keyboard's range are shown on the display. The DGX-640 actually have 88 keys. In some songs that include very high or low notes, those notes may fall outside the displayed range and may not be shown on the display. In such cases an "over" indicator appear to the left or right of the graphic keyboard. Use the [+] or [-] button to shift the keyboard left or right so you can see the notes (the ● marker will appear on the appropriate key in the display). Notes that actually fall outside the keyboard's range cannot be used in the lesson.

5 Stop the Lesson mode.

You can stop the Lesson mode at any time by pressing the [START/STOP] button.

Lesson 2—Your Tempo

Learn to play the correct notes with the correct timing. Song playback tempo will vary to match the speed you are playing at. The song will slow down when you play wrong notes, so you can learn at your own pace.

1 Select the song and part you want to practice (steps 1 and 3 on page 38).

2 Start Lesson 2.

Press the [YOUR TEMPO] button to start Lesson 2.

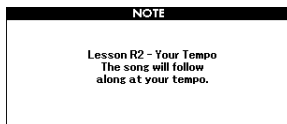
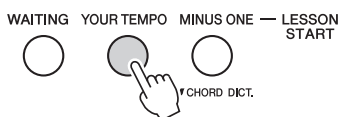

Song playback will begin automatically when Lesson 2 is selected.

The triangular marker will appear in the score display, and will move to indicate the current note in the song. Try to play the notes at the correct timing. As you learn to play the right notes at the right timing the tempo will increase until eventually you'll be playing at the song's original tempo.

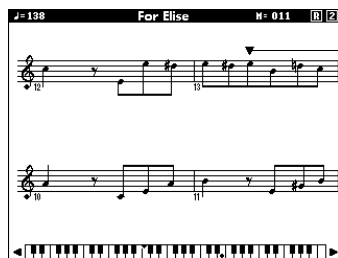

Play while following the score marker

3 Stop the Lesson mode.

You can stop the Lesson mode at any time by pressing the [START/STOP] button.

Lesson 3—Minus One

Here's where you can perfect your technique. The song will play at the normal tempo, minus the part you have chosen to play. Play along while listening to the song.

1 Select the song and part you want to practice (steps 1 and 3 on page 38).

2 Start Lesson 3.

Press the [Minus One] button to start Lesson 3.



Song playback will begin automatically when Lesson 3 is selected.

Play along while listening to the song. The score marker and keyboard marker in the display will indicate the notes to play.



3 Stop the Lesson mode.

You can stop the Lesson mode at any time by pressing the [START/STOP] button.

See How You've Done

When the lesson song has played all the way through your performance will be evaluated in 4 levels: OK, Good, Very Good, or Excellent. "Excellent!" is the highest evaluation.



After the evaluation display has appeared, the lesson will start again from the beginning.

NOTE

- The evaluation feature can be turned off via the FUNCTION Grade item (page 88).

Practice Makes Perfect—Repeat and Learn

Use this feature when you want to start again just ahead of a section on which you made a mistake, or to repeatedly practice a section you find difficult.

Press the [REPEAT & LEARN] button during a lesson. The song location will move back four measures from the point at which you pressed the button, and playback will begin after a one-measure count-in. Playback will continue up to the point at which you pressed the [REPEAT & LEARN] button, and then jump back four measures and begin again after a count-in. This process will repeat, so all you have to do is press the [REPEAT & LEARN] button when you make a mistake in order to repeat practice of that section until you get it right. Press the button again to return to the normal lesson mode.

NOTE

- You can change the number of measures the Repeat and learn function jumps back by pressing a number button [1]–[9] during repeat playback.

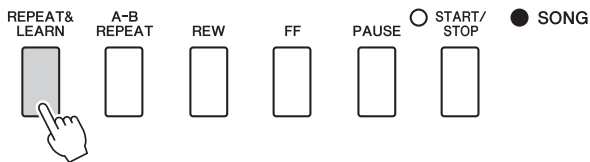

The Easy Way to Play Piano

This instrument includes a performance assistant technology feature that lets you play along with a song and sound like a great pianist (even though you might be making lots of mistakes)! In fact, you can play any notes and still sound good! You could even just tap one key and the results would be a beautiful melody. So even if you can't play piano and can't read a note of music, you can have some musical fun.

Performance assistant technology offers four selectable types. Select the type that produces the best results for you.

- **Chord**..... No matter where or what you play, the result will be musical, well-balanced sound. This type offers the greatest freedom, allowing you to play anything with both your left and right hands.
- **Chord/Free** If you can play simple right-hand melodies but have trouble with left-hand chords, this is the type for you. The Chord type applies to only the left-hand section of the keyboard, allowing you to easily play chords to support the melody you are playing with your right hand.
- **Melody**..... This type lets you play the melody of the selected song by playing any keys with just one finger. Start playing melodies right away, even if you've never played a keyboard instrument before!
- **Chord/Melody** Play the melody of the selected song with one finger on the right-hand section of the keyboard, and play chords on the left-hand section of the keyboard using the Chord type.

To use the performance assistant technology feature it is necessary to play a song that includes the required chord and/or melody data. When the Chord and Chord/Free type is selected the performance assistant technology can only be used with songs that include chord data. When the Melody type is selected the performance assistant technology will only work with songs that include melody data. When the Chord/Melody type is selected the performance assistant technology can only be used with songs that include chord and melody data. In order to find out if a song includes the required chord data, refer to the Song List in the separate Data List document.

Refer to page 52 for more information on using performance assistant technology to help you play.

CHORD Type—Play with Both Hands

Try out the performance assistant technology using the preset song “Ave Maria.”

1 Press the [P.A.T. ON/OFF] button.

This turns on the performance assistant technology feature.

The currently selected type is shown in the MAIN display when the performance assistant technology feature is on.

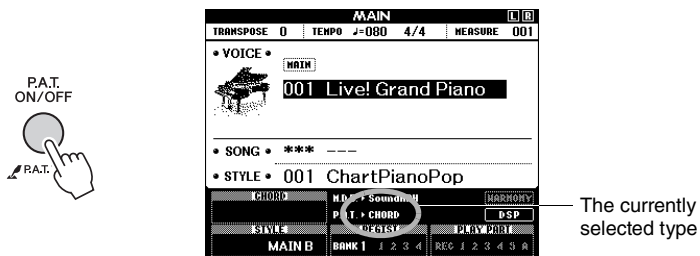

2 Select the CHORD type.

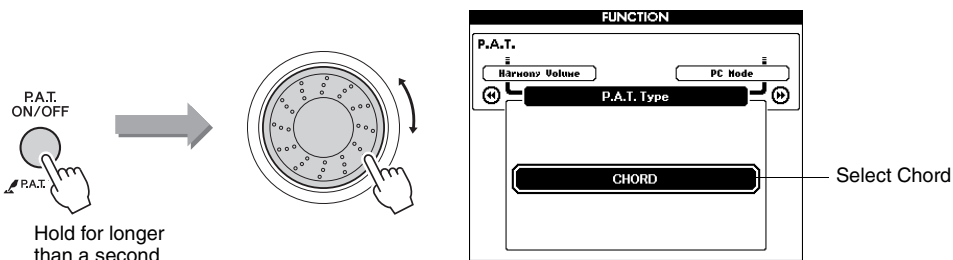

Press and hold the [P.A.T. ON/OFF] button for longer than a second so that the performance assistant technology type appears. Select the Chord type by using the dial.

3 Select a song.

For this example try selecting the “010 Ave Maria”.

When the Chord type is selected, features only available for this song can be seen in the display!

NOTE 1

- Select and Listen to a Song (page 28)

4 Press the [START/STOP] button.

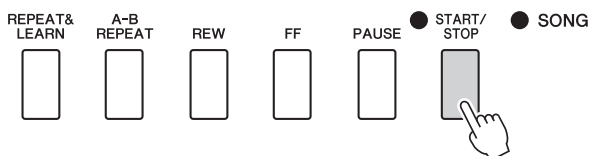

Song playback will begin.

The basic pattern will play repeatedly. Listen to the basic pattern for four measures while getting a feel for the basic pattern, then begin playing yourself from the fifth measure. The keys you should play will be shown in the display.

5 Play on the keyboard.

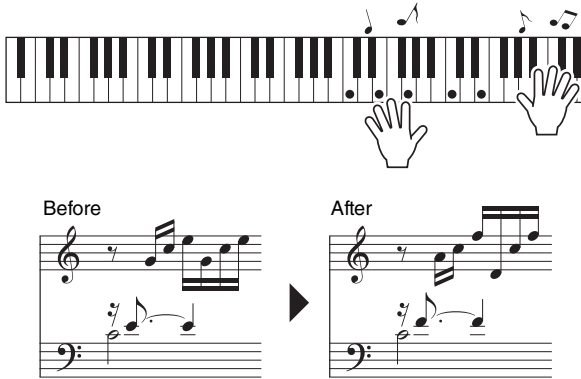

Try playing the score on the left with both hands. You can even play the same keys over and over: C, E, G, C, E, G, C, E. You'll notice that at measure five the notes will come out according to the score on the right. Keep playing, and performance assistant technology Chord type will continue to “correct” the notes that you play.

This is the performance assistant technology Chord type.

You can stop song playback at any time by pressing the [START/STOP] button.

6 Press the [P.A.T. ON/OFF] button to turn the performance assistant technology feature off.

“...” will appear on the display where the performance assistant technology type is normally shown.

Next try playing a different preset song.

NOTE

- The score for Ave Maria is provided in the separate Data List.

CHORD/FREE Type—Applying the Chord Type to the Left Hand Only

Try out the performance assistant technology using the preset song “Nocturne.”

1 Press the [P.A.T. ON/OFF] button.

This turns on the performance assistant technology feature.

The currently selected type is shown in the MAIN display when the performance assistant technology feature is on.

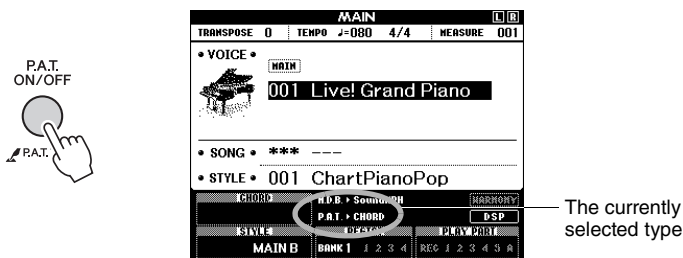

2 Select the CHORD/FREE type.

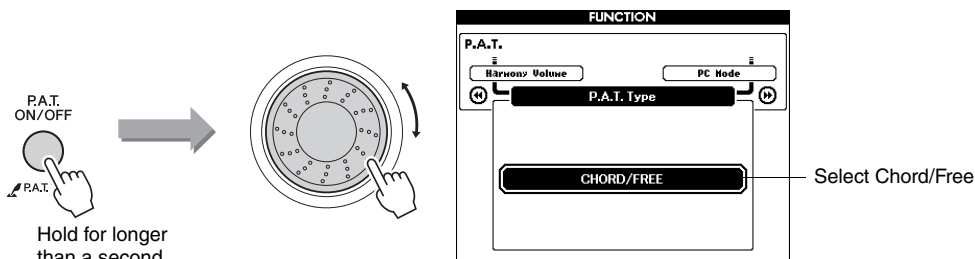

Press and hold the [P.A.T. ON/OFF] button for longer than a second so that the performance assistant technology type appears. Select the Chord/Free type by using the dial.

3 Select a song.

For this example try selecting the “011 Nocturne”.

NOTE

- Select and Listen to a Song (page 28)

4 Press the [START/STOP] button.

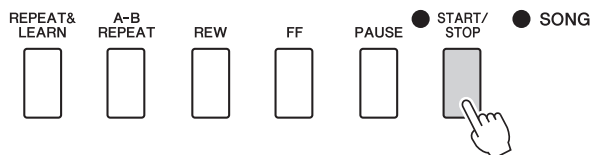

Song playback will begin.

The left-hand keys you should play will be shown on the display.

5 Play on the keyboard.

Play to the right of the split point with your right hand, and to the left of the split point with your left hand.

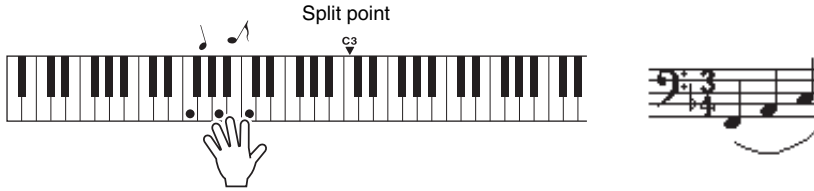

With this type notes played on the left-hand side of the split point will actually sound an octave higher.

Play the Nocturne melody with your right hand. Continually play an F-A-C arpeggio with your left hand as indicated by the score shown in the display. Although you're repeatedly playing the same notes with your left hand, the actual notes produced will change to match the music.

This is the performance assistant technology Chord/Free type.

Press the [SCORE] button if you want to see the score for the right-hand part in the display.

You can stop song playback at any time by pressing the [START/STOP] button.

NOTE

- The score for Nocturne is provided in the separate Data List.

6 Press the [P.A.T. ON/OFF] button to turn the performance assistant technology feature off.

"..." will appear on the display where the performance assistant technology type is normally shown.

Next try playing a different preset song.

MELODY Type—Play with One Finger

1 Press the [P.A.T. ON/OFF] button.

This turns on the performance assistant technology feature. The currently selected type is shown in the MAIN display when the performance assistant technology feature is on.

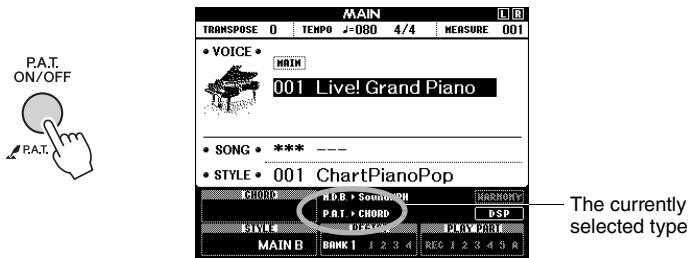

2 Select the MELODY type.

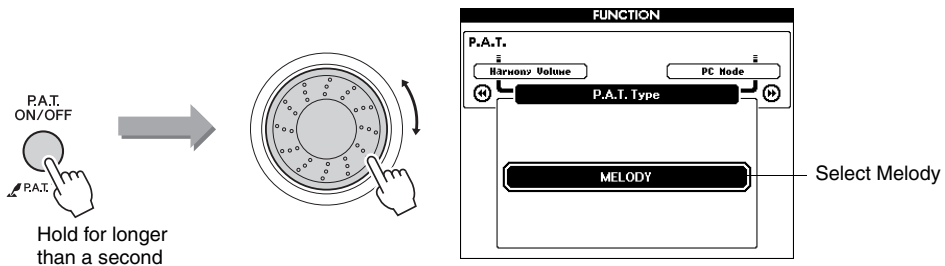

Press and hold the [P.A.T. ON/OFF] button for longer than a second so that the performance assistant technology type appears. Select the Melody type by using the dial.

3 Select a song.

For this example try selecting the “012 For Elise”.

NOTE 1

- *Select and Listen to a Song (page 28)*

4 Display the score.

Press the [SCORE] button to call up the melody score in the display.

NOTE 1

- *Displaying the Song Score (page 32)*

5 Press the [START/STOP] button.

Song playback will begin. Because the Melody type has been selected, the song melody will not sound. You can enjoy playing the melody yourself.

6 Play on the keyboard.

The marker will indicate the current position in the score during playback. If you play a key each time the marker appears above a note in the score you will be able to play the melody with the correct “original” rhythm.

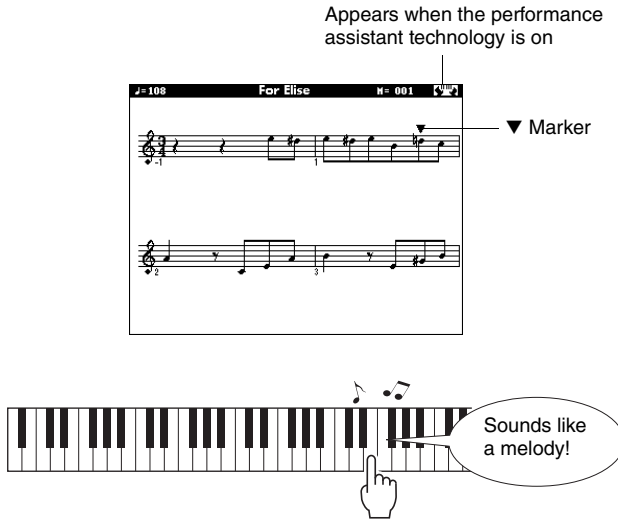

How does it sound? You’ve played the melody using only one finger thanks to the performance assistant technology Melody type!

You can stop song playback at any time by pressing the [START/STOP] button.

7 Press the [P.A.T. ON/OFF] button to turn the performance assistant technology feature off.

“...” will appear on the display where the performance assistant technology type is normally shown.

Next try playing a different preset song.

CHORD/MELODY—Chord Type with the Left Hand, Melody with the Right

1 Press the [P.A.T. ON/OFF] button.

This turns on the performance assistant technology feature. The currently selected type is shown in the MAIN display when the performance assistant technology feature is on.

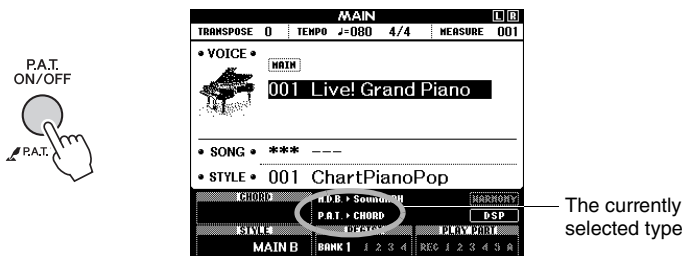

2 Select the CHORD/MELODY type.

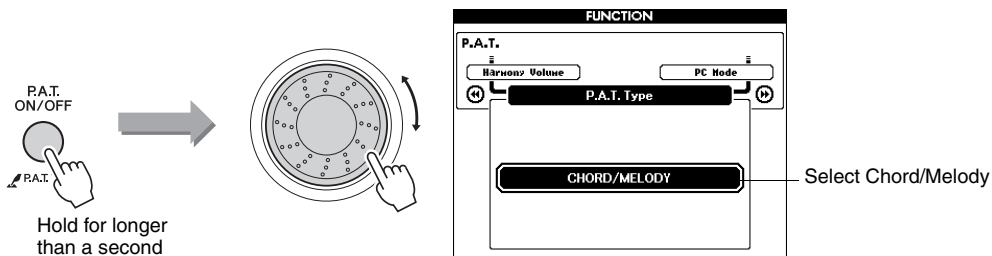

Press and hold the [P.A.T. ON/OFF] button for longer than a second so that the performance assistant technology type appears. Select the Chord/Melody type by using the dial.

3 Select a song.

For this example try selecting the “023 Rock Piano”.

NOTE 1

- Select and Listen to a Song (page 28)

4 Display the score.

Press the [SCORE] button twice to call up the double-staff score in the display.

NOTE 1

- Displaying the Song Score (page 32)

5 Press the [START/STOP] button.

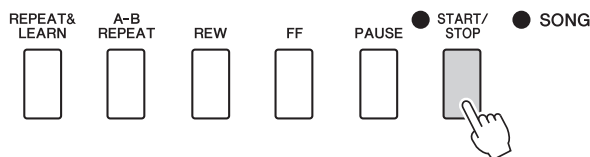

Song playback will begin.

Because the Melody type has been selected, the song melody will not sound. You can enjoy playing the melody yourself.

6 Play on the keyboard.

Play to the right of the split point with your right hand, and to the left of the split point with your left hand.

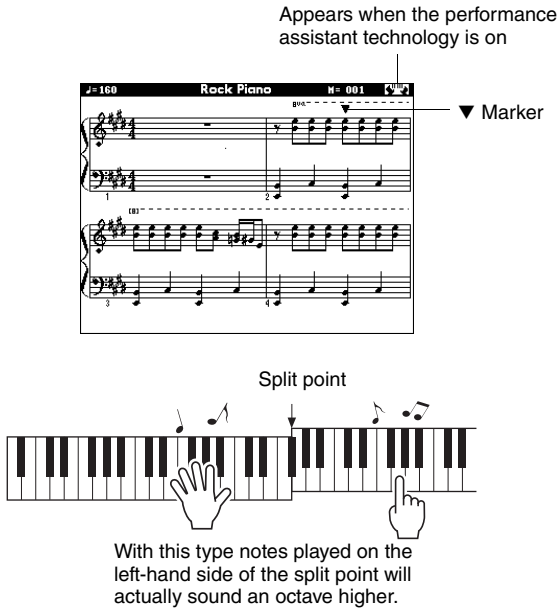

Play along with the rhythm of the song melody with your right hand. You can play any keys as long as you're playing to the right of the split point. At the same time play accompaniment-like chords and phrases with your left hand. No matter what you play, you'll produce the song melody with your right hand and beautiful chords and phrases with your left hand. This is the performance assistant technology Chord/Melody type.

7 Press the [P.A.T. ON/OFF] button to turn the performance assistant technology feature off.

"..." will appear on the display where the performance assistant technology type is normally shown.

Next try playing a different preset song.

Use the Performance Assistant to Play Like a Pro!

Here are a few hints for using the Chord type.

If you select Chord/Free or Chord/Melody, the left-hand section of the keyboard becomes the Chord type section, so use these hints on the left-hand section of the keyboard.

To begin, try to feel the rhythm of the song. Then, with your hands spread as shown in the illustration, simply play the keyboard alternately with your left and right hands (any notes will do).

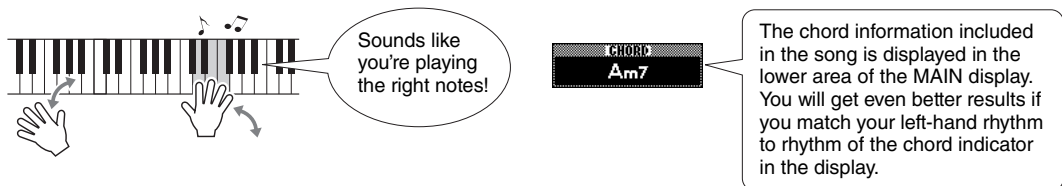

How does it sound? You'll get acceptable results no matter where you play thanks to the performance assistant technology Chord type!

Next try the three playing methods illustrated below. Different ways of playing produce different results.

Play with the left and right hands at the same timing—type 1.



Play 3 notes at once with your right hand.

Play with the left and right hands at the same timing—type 2.

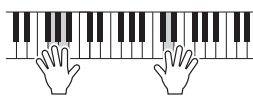

Play 1 note at a time with your right hand (for example: index finger → middle finger → ring finger).

Play alternately with the left and right hands—type 3.

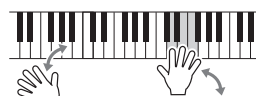

Play 3 notes at once with your right hand.

Once you get a feel for it, try playing chords with your left hand and a melody with your right ... or any other combination.

External Songs and the performance assistant technology

Songs downloaded from the Internet can also be used with the performance assistant technology as long as they include the required chord and/or melody data.

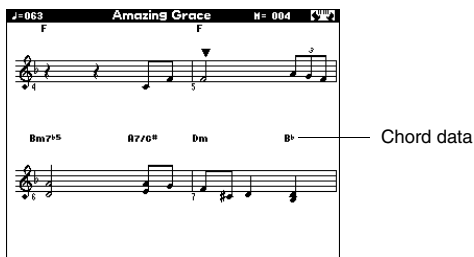

Play Using the Music Database

You want to play music in your favorite style, but you're not sure how to select the best voice and style for the type of music you want to play ... simply select the appropriate style from the Music Database. The panel settings will automatically be adjusted for the ideal combination of sounds and style!

- 1 Press the [MUSIC DATABASE] button.

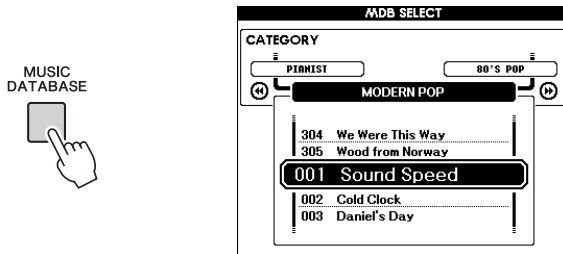

A Music Database list will appear in the display.

- 2 Select a Music Database.

Referring to the list on the panel or Music Database List in the separate Data List, use the dial to select a music database. Select one that matches the image of the song you intend to play.

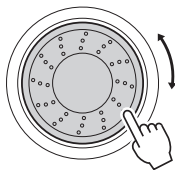

NOTE 1

- Music Database (MDB) files transferred from a computer or stored on a USB flash memory device connected to the instrument can be selected and used in the same way as the internal Music Databases (MDB numbers 306-). File transfer instructions are provided on page 100.

- 3 Play the chords with your left hand and melody with your right.

The style will start playing when you play a left-hand chord to the left of the split point. Refer to pages 26–27 for information about playing chords.

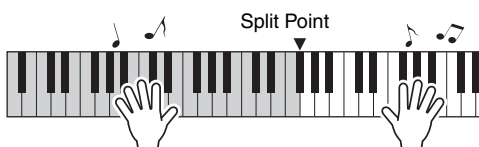

If you press the [EXIT] button to return to the MAIN display at this point you can check the assigned voice and style.

- 4 Press the [START/STOP] button to stop playback.

Change a Song's Style

In addition to each song's default style, you can select any other style to play the song with the Easy Song Arranger feature. This means that you can play a song that is normally a ballad, for example, as a bossa nova, as a hip-hop tune, etc. You can create totally different arrangements by changing the style with which a song is played. You can also change the song's melody voice and the keyboard voice for a complete change of image.

Listen to the DEMO Song for Easy Song Arranger

The "Hallelujah Chorus" in the preset songs lets you experience the Easy Song Arranger. Playing it.

Press the [SONG] button and use the dial to select "009 Hallelujah Chorus." Press the [START/STOP] button begin playback of the song. An explanation of the Easy Song Arranger feature will appear on the display. As the song progresses the styles will change, changing the overall image of the song.

Keep in mind that you can enjoy using Easy Song Arranger with other songs as well—any songs that include chord data.

NOTE 1

- The score for Hallelujah Chorus is provided in the separate Data List.

Using the Easy Song Arranger

Try switching styles while the song plays back.

1 Press the [EASY SONG ARRANGER] button from the MAIN display.

The EASY SONG ARRANGER MAIN display will appear. The currently selected song name and number will be highlighted.

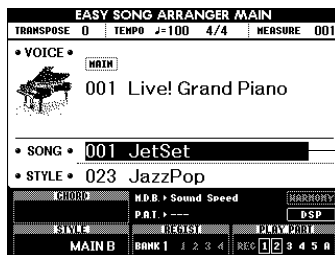

The currently selected song number and name are displayed here.

2 Select a Song.

Press the [SONG] button and then rotate the dial to select the song you want to arrange. Select the songs that include the required chord data referring to the Song List in the separate Data List.

3 Listen to the song.

Press the [START/STOP] button to begin playback of the song. Move on to the next step while the song is playing.

NOTE 1

- When playing song numbers 010 and 021 to 030 while using the Easy Song Arranger, melody tracks will be automatically muted and no melody will sound. In order to hear the melody tracks you will need to press the SONG MEMORY buttons [3] to [5].

4 Select a style.

Press the [STYLE] button and then rotate the dial to hear how the song sounds with different styles. As you select different styles the song will remain the same while only the styles change.

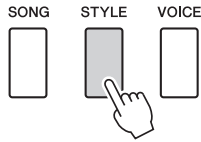

5 Changing a song melody voice.

If you press and hold the [VOICE] button for longer than a second a voice list will appear. The Melody R and Melody L displays will be selected alternately each time you press the [VOICE] button.

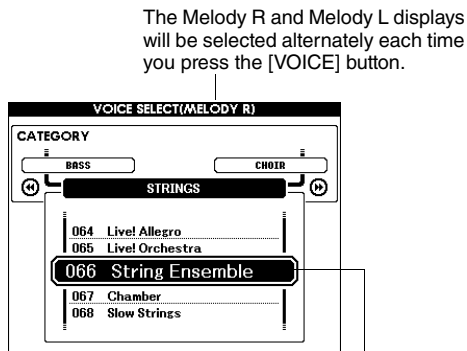
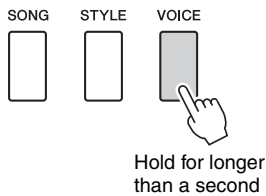

The Melody R and Melody L displays will be selected alternately each time you press the [VOICE] button.

The currently selected melody voice will be displayed.

Use the dial to change the melody voice. As you select different melody voices the song will remain the same while only the melody voice changes.

6 Press the [EASY SONG ARRANGER] button to turn the function off.

If the song or style is being played back, first stop the playback, then turn the Easy Song Arranger function off.

NOTE

- Because the Easy Song Arranger uses song data you can't specify chords by playing in the accompaniment range of the keyboard. The [ACMP ON/ OFF] button will not function.
- If the time signature of the song and style are different, the time signature of the song will be used.

NOTE

- If you press the [INTRO/ENDING/rit.] button during style playback, the style will stop but the song will continue playing. Use the [START/ STOP] button to stop playback completely.

Record Your Own Performance

You can record up to 5 of your own performances and save them as user songs 031 through 035. Once your performances have been saved as user songs they can be played in the same way as the internal songs. User songs can also be saved to a USB flash memory device, as described on page 94.

Recording

1 Press the [REC] button.

Flashes when record mode is on.

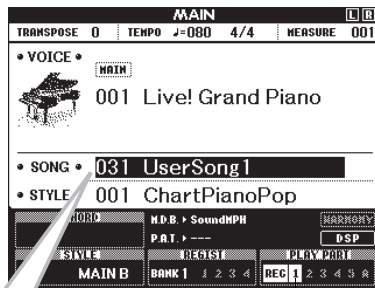
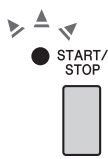

The lowest-numbered unrecorded User Song (Song numbers 031–035) available for recording is displayed. If you want to select the Song you will be recording, select the desired Song number by using the dial.

Track 1 is automatically selected

NOTICE

- If all User Songs (Song numbers 031–035) contain recorded data, Song 031 will automatically be selected. In this case, you will record over and erase any previous data in Song 031, so be careful that you won't be erasing any material you want to keep!

NOTE

- Accompaniment cannot be turned on or off once the [REC] button is pressed.

You can turn off the Record mode by pressing the [REC] button again or [EXIT] button (The [START/STOP] button indicator stop flashing).

NOTE

- After you've selected the desired User Song for recording, you can select a Style to be recorded as well. To do this, press the [STYLE] button and select the Style number while the ACMP indication is on.

2 Start recording.

When you play the keyboard, recording will begin.

3 Stop recording.

Press the [REC] button or [START/STOP] button to stop the recording.

4 Save the song.

When recording is stopped a message asking if you want to save the song will appear. Press the [+ / YES] button to save the song, or the [- / NO] button if you don't want to save the song. If saved, the song will be stored as a MIDI file in song number 031–035.

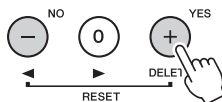

NOTICE

- Never attempt to turn the power off when a "Writing!" message is shown in the display. Doing so can damage the flash memory and result in a loss of data.

To playback the newly recorded performance, press the [START/STOP] button.

Recording to a specified track

Recordable Data

You can record up to a total of 6 tracks: 5 melody tracks and 1 style (chord) track. Each track can be recorded individually.

- **SONG MEMORY (Track) [1]–[5]**..Record the melody parts.
- **SONG MEMORY (Track) [A]**.....Records the style pattern and chord parts.

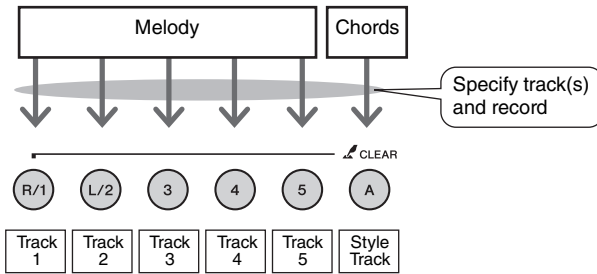

Track Mute

This instrument allows you to choose whether recorded tracks will play back while you are recording or playing back other tracks (page 84).

NOTE 1

- Up to approximately 30,000 notes can be recorded for the five user songs if you record only to the melody tracks.
- User songs are saved as SMF (Standard MIDI File) format 0 files. Refer to page 108 for information on SMF files.

- 1 From the MAIN display press the [SONG] button, then use the dial to select the user song number (031–035) you want to record to.

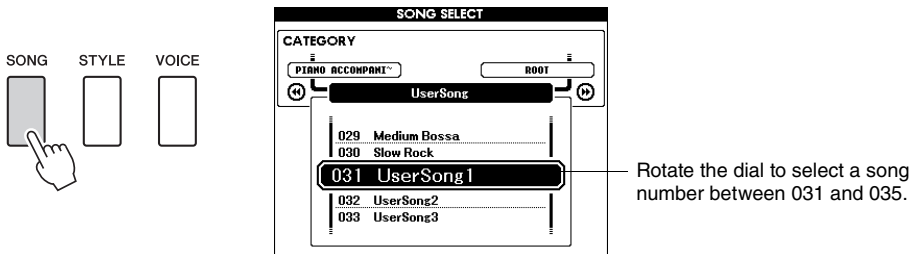

- 2 Select the track(s) you want to record to and confirm your selection on the display.

◆ Record a Melody Track and the Accompaniment Track Together

Press the melody track button [1]–[5] you want to record to while holding the [REC] button.

Next, press the [A] button while holding the [REC] button.

The selected tracks will be highlighted in the display.

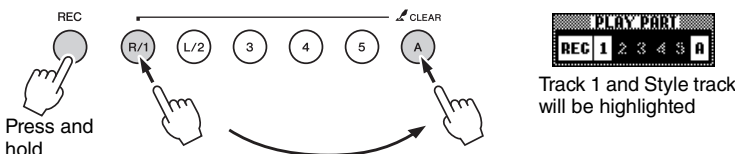

NOTICE

- If you record to track that contains previously-recorded data the previous data will be overwritten and lost.

NOTE 1

- Style accompaniment is automatically turned on when you select the style track [A] for recording.
- Style accompaniment cannot be turned on or off while recording is in progress.

◆ Record a Melody track

Press the melody track button [1]–[5] you want to record to while holding the [REC] button. Select button [1]–[3] if you want to record a dual voice. Split voices cannot be recorded.

The selected track will be highlighted in the display.

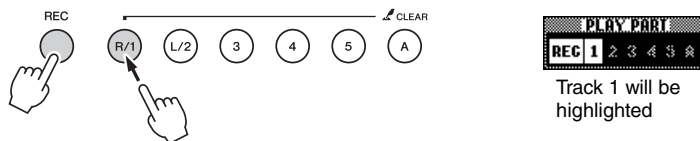

NOTE 1

• If style accompaniment is on and track [A] has not yet been recorded, the style track [A] will automatically be selected for recording when a melody track is selected. If you only want to record a melody track, be sure to turn the style track [A] off.

To cancel recording to a selected track, press that track button a second time.

3 Recording will start when you play on the keyboard.

You can also start recording by pressing the [START/STOP] button.

The current measure will be shown on the display during recording.

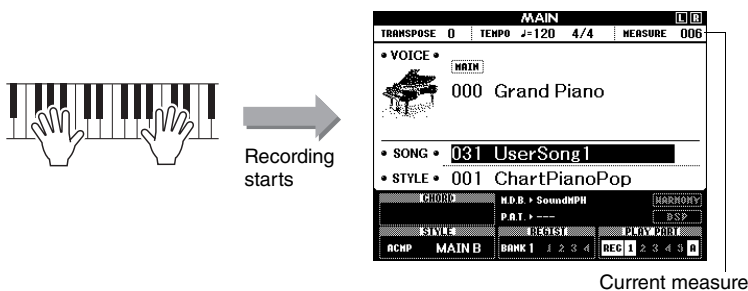

NOTE 1

• If the memory becomes full during recording a warning message will appear and recording will stop automatically. Use the song clear or track clear (pages 60–61) function to delete unwanted data and make more room available for recording, then do the recording again.

NOTE 1

• If you want to record only the rhythm (percussion) part, press the [START/STOP] button to play just the rhythm, then add the section change by pressing the [INTRO/ENDING/rit.] button or [MAIN/AUTO FILL] button.

4 Stop recording by pressing the [START/STOP] or [REC] button.

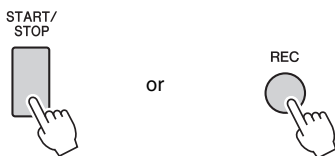

When recording stops the current measure number will return to 001 and the recorded track numbers in the display will be shown in a box border.

NOTE 1

• If you press the [INTRO/ENDING/rit.] button while recording a style track, an appropriate ending pattern will play and then recording will stop.

5 Save the song.

When recording is stopped a message asking if you want to save the song will appear. Press the [+ / YES] button to save the song, or the [- / NO] button if you don't want to save the song. If saved, the song will be stored as a MIDI file in song number 031–035.

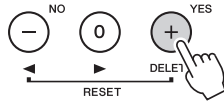

If you press the [- / NO] button in response to the confirmation message the song will not be saved as a MIDI file but will remain in the instrument's memory until the power is turned off, so you have the option of converting the song to a MIDI file and saving it later. To do this press and hold the [REC] button until the save confirmation message appears, then press the [+ / YES] button.

To Record Other Tracks

Repeat steps 2 through 5 to record any of the remaining tracks. By selecting an unrecorded track—track buttons [1]–[5], [A]—you can record the new track while listening to previously recorded tracks (the border around the track number will appear in the display). You can also mute previously recorded tracks (the border around the track number disappears in the display) while recording new tracks.

To Re-record a Track

Simple select the track you want to re-record for recording in the normal way. The new material will overwrite the previous data.

6 When the recording is done ...

To playback the newly recorded performance, press the [START/STOP] button.

◆ To Play Back a User Song

User songs are played back in the same way as regular songs (page 28).

◆ To save a User Song to USB flash memory → page 94.

Data that cannot be recorded

- Split voice
- The following items are recorded at the beginning of the track. Changes made during the song will not be recorded.
Time signature, Style number, Style volume

NOTICE

- *The recorded Song data will be lost if you turn the power to the instrument off without executing the Save operation.*

Song Clear—Deleting User Songs

This function clears an entire user song (all tracks).

NOTE 1

- If you only want to clear a specific track from a user song use the Track Clear function.

1 From the MAIN display select the user song (031–035) you want to clear.

2 Press and hold the track [1] button for longer than a second while holding the track [A] button.

A confirmation message will appear on the display.

You can cancel the clear operation by pressing the [-] button.

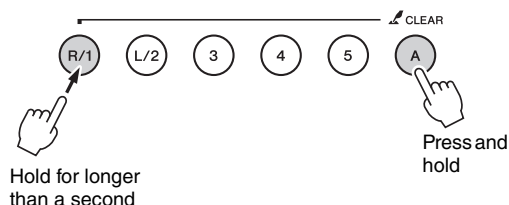

3 Press the [+] button to clear the song.

The clear-in-progress message will appear briefly on the display while the song is being cleared.

Track Clear—Deleting a Specified Track from a User Song

This function lets you delete a specified track from a user song.

- 1 From the MAIN display select the user song (031–035) you want to clear.
- 2 Press and hold the track button ([1]–[5], [A]) corresponding to the track you want to clear for longer than a second.

A confirmation message will appear on the display.

You can cancel the clear operation by pressing the [-] button.

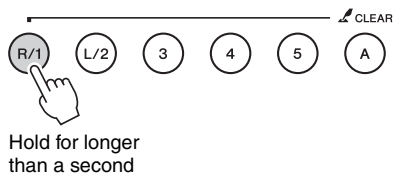

- 3 Press the [+] button to clear the track. The clear-in-progress message will appear briefly on the display while the track is being cleared.

Memorize Your Favorite Panel Settings

This instrument has a Registration Memory feature that lets you save your favorite settings for easy recall whenever they're needed. Up to 32 complete setups can be saved (8 banks of four setups each).

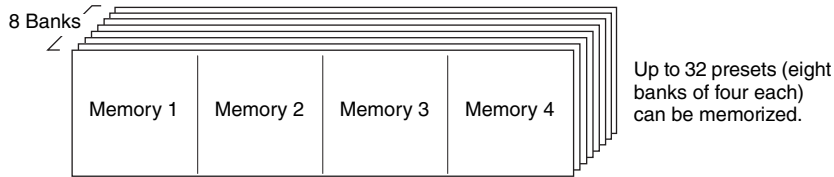

Saving to the Registration Memory

- 1 Set the panel controls as required—select a voice, accompaniment style, etc.
- 2 Press the [BANK] button. A bank number will appear in the display when you release the button.

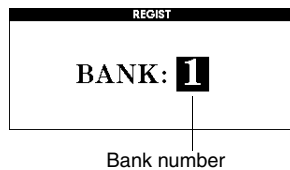
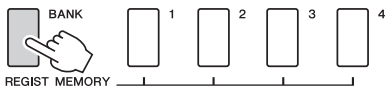

- 3 Use the dial or the [1]–[8] number buttons to select a bank number from 1 to 8.
- 4 Press one of the REGIST MEMORY buttons [1] to [4] while holding the [BANK] button to store the current panel settings to the specified registration memory.

Press the [EXIT] button to return to the MAIN display in order to check the bank and registration memory numbers.

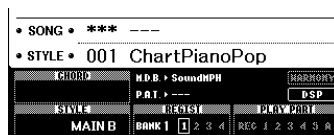
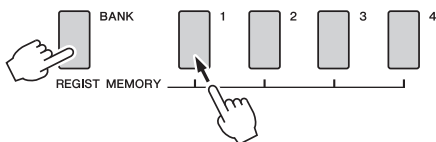

NOTE 1

- Data cannot be saved to the registration memory during song playback.

NOTE 2

- You can also save your panel settings memorized to registration memory button into USB flash memory as the user file or to a computer as the backup file.

NOTE 3

- If you select a Registration Memory number that already contains data, the previous data is deleted and overwritten by the new data.

NOTICE

- Do not turn off the power while saving settings to the registration memory, otherwise the data may be damaged or lost.

Recalling a Registration Memory

- 1 Press the [BANK] button. A bank number will appear in the display when you release the button.

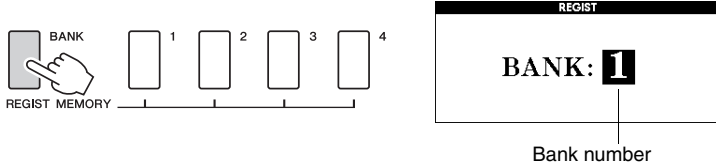

- 2 Use the dial or the [1]–[8] number buttons to select bank you want to recall.

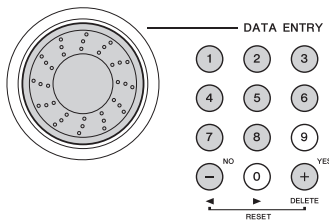

You can check whether the panel settings are stored in registration memory 1–4 by pressing the [EXIT] button to return to the MAIN display.

- 3 Press one of the REGIST MEMORY buttons [1] to [4] containing the settings you want to recall. The panel controls will be instantly set accordingly.

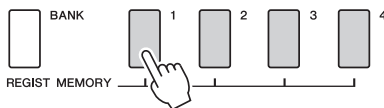

Settings That Can be Saved to the Registration Memory

Style settings*

Style number, Auto Accompaniment ON/OFF, Split Point, Style settings (Main A/B), Style Volume, Tempo, Chord Fingering

Voice settings

Main Voice setting (Voice number, Volume, Octave, Pan, Reverb Level, Chorus Level, DSP Level),

Dual Voice settings (Dual ON/OFF, Voice number, Volume, Octave, Pan, Reverb Level, Chorus Level, DSP Level),

Split Voice settings (Split ON/OFF, Voice number, Volume, Octave, Pan, Reverb Level, Chorus Level)

Effect settings

Reverb Type, Chorus Type, Panel Sustain ON/OFF, DSP ON/OFF, DSP Type

Harmony settings

Harmony ON/OFF, Harmony Type, Harmony Volume

Other settings

Transpose, Pitch Bend Range

* Style settings are not available for Registration Memory when using the Song features.

Backup and Initialization

Backup

The following settings are always backed up, and are maintained even when the power is turned off. If you want to initialize the settings, use the Initialize operation “Backup Clear” as explained below.

The Backup Parameters

- Registration Memory
- FUNCTION Settings: Tuning, Split Point, Touch Sensitivity, Style Volume, Song Volume, Metronome Volume, Grade, Demo Cancel, Demo Group, Demo Play Mode, Language Selection, Panel Sustain, Master EQ type, Chord Fingering

NOTE 1

- You can save the settings as backup data to your computer, by using the Musicsoft Downloader (MSD) software. Refer to the section “Transfer a backup file from the instrument to a computer” on page 101.

Initialization

This function erases all backup data in the instrument’s flash memory and restores the initial default settings. The following initialization procedures are provided.

Backup Clear

To clear data backed up to the internal flash memory—panel user setting, registration memory—turn the power on by pressing the [⏻] (Standby/On) switch while holding the highest white key on the keyboard. The backed up data will be erased and the default values restored.

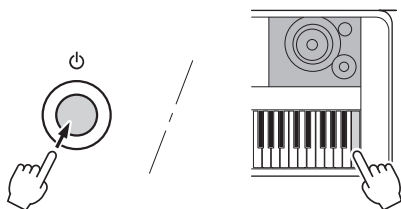

Initialization does not delete the files transferred from the computer. If you want to delete the files, see “Deleting Files” below.

Deleting Files

To clear Song, Style, and Music Database files that have been transferred to the internal flash memory from a computer, turn the power on by pressing the [⏻] (Standby/On) switch while simultaneously holding the highest white key on the keyboard and the three highest black keys.

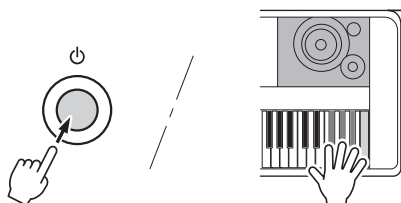

NOTICE

- When you execute the Flash Clear operation, data you have purchased will also be cleared. Be sure to save data you want to keep to a computer.

Play with a Variety of Effects

Adding Harmony

This feature adds harmony notes to the main voice.

1 Press the [HARMONY ON/OFF] button to turn Harmony feature on.

To turn Harmony off, press the [HARMONY ON/OFF] button again.

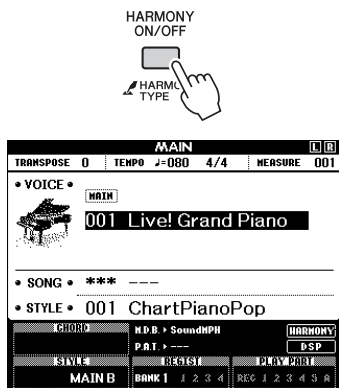

When harmony is on the harmony icon will appear in the display.

NOTE 1

- When you press the [HARMONY ON/OFF] button to turn this feature on, the appropriate harmony type for the currently selected main voice is automatically selected.

2 Press and hold the [HARMONY] button for longer than a second.

The currently selected harmony type will be displayed.

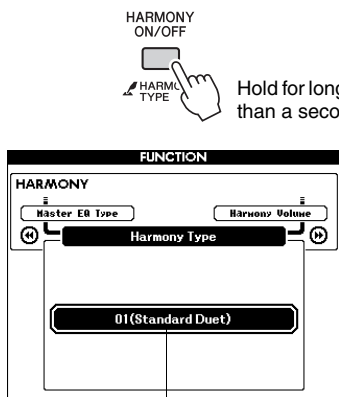

The currently selected harmony type

3 Use the dial to select a harmony type.

Refer to the Effect Type List in the separate Data List for information about the available harmony types. Try playing the keyboard with the harmony function. The effect and operation of each Harmony Type is different—refer to the below section “How to sound each Harmony Type” as well as the Effect Type List for details.

NOTE 1

- The harmony notes can be added only to the Main Voice, not to Dual or Split Voices.
- The keys left of the Split Point of the keyboard produce no harmony notes when the auto accompaniment is on (ACMP ON is lit).

How to sound each Harmony Type

- Harmony type 01 to 10, 13



Press the right-hand keys while playing chords in the auto accompaniment range of the keyboard when the Auto Accompaniment is on.

- Harmony type 15 to 18 (Echo)



Keep holding down the keys.

- Harmony type 19 to 22 (Tremolo)



Keep holding down the keys.

- Harmony type 23 to 26 (Trill)



Hold down two keys.

You can adjust the Harmony Volume in the Function Settings (page 88).

Adding Reverb

Reverb lets you play with a rich concert hall type ambience. When you select a style or song the optimum reverb type for the voice used is automatically selected. If you want to select a different reverb type, use the procedure described below. Refer to the Effect Type List in the separate Data List for information about the available reverb types.

- 1 Press the [FUNCTION] button to call up the FUNCTION display.

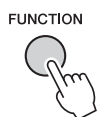

- 2 Use the CATEGORY [◀] and [▶] buttons to select the Reverb Type item. The currently selected reverb type will be displayed.

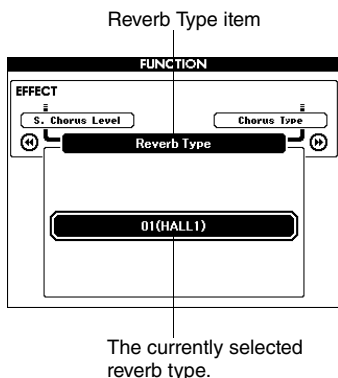

- 3 Use the dial to select a reverb type. You can check how the selected reverb type sounds by playing on the keyboard.

Refer to the Effect Type List in the separate Data List for information about the available reverb types.

Adjusting the Reverb Level

You can individually adjust the amount of reverb that is applied to the main, dual, and split voices. (See page 87).

Adding Chorus

The chorus effect creates a thick sound that is similar to many of the same voices being played in unison. When you select a style or song the optimum chorus type for the voice used is automatically selected. If you want to select a different chorus type, use the procedure described below.

- 1 Press the [FUNCTION] button to call up the FUNCTION display.

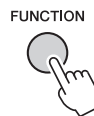

- 2 Use the CATEGORY [◀] and [▶] buttons to select the Chorus Type item. The currently selected chorus type will be displayed.

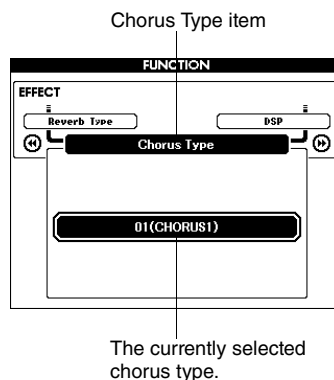

- 3 Use the dial to select a chorus type. You can check how the selected chorus type sounds by playing on the keyboard.

Refer to the Effect Type List in the separate Data List for information about the available chorus types.

Adjusting the Chorus Level

You can individually adjust the amount of chorus that is applied to the main, dual, and split voices. (See page 87).

Adding DSP

DSP is term of abbreviated form of Digital Signal Processor. The DSP effect can be added to the Main and Dual Voices. These range from reverb-like ambience effects to distortion and other dynamic processing tools that let you enhance the sound, or completely transform it.

- 1 Press the [FUNCTION] button to call up the FUNCTION display.

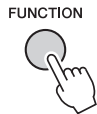

NOTE

- When DSP is turned on, the optimum DSP type for the current Voice is automatically selected.
- The volume of the currently playing Voice changes when turning DSP on or off. This is not a malfunction. The amount of change differs depending on the selected Voice.
- The DSP type is an overall setting—only one type can be selected. For this reason, when you play a newly loaded Song or Style, for example, the currently playing Voices may not sound as expected. This is normal, since the Song or Style has its own DSP type which replaces any selection you've made before loading. A similar phenomenon occurs when you use the [FF], [REW] buttons or A-B Repeat function during song playback.

- 2 Use the CATEGORY [◀] and [▶] buttons to select the DSP ON/OFF item.

The current setting is displayed.

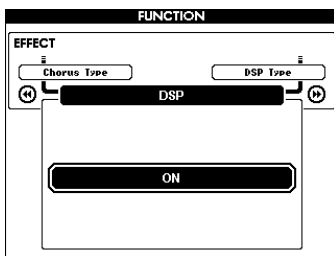

- 3 Use the dial to turn DSP on or off.

Press the [EXIT] button to return to the MAIN display in order to check the DSP on/off status.

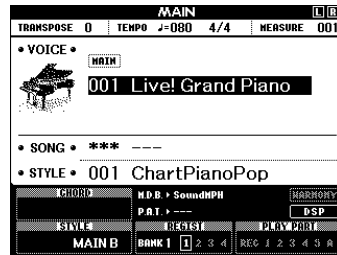

When DSP is on the DSP icon will appear in the display

- 4 Use the CATEGORY [◀] and [▶] buttons to select the DSP Type item.

The currently selected DSP type will be displayed.

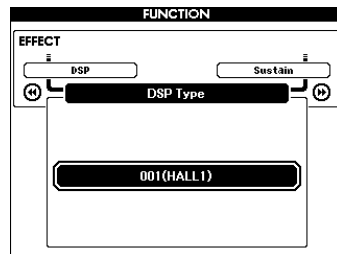

- 5 Use the dial to select a DSP type.

Refer to the DSP Type List in the separate Data List for information about the available DSP types.

Adjusting the DSP Level

You can individually adjust the amount of DSP that is applied to the main and dual voices. (See page 87).

Panel Sustain

This function adds sustain to the keyboard voices. Use it when you want to add sustain to the voices at all times, regardless of footswitch operation. The sustain function does not affect split voice.

- 1 Press the [FUNCTION] button to call up the FUNCTION display.

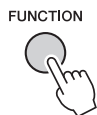

- 2 Use the CATEGORY [◀◀] and [▶▶] buttons to select the Sustain item.

The current setting is displayed.

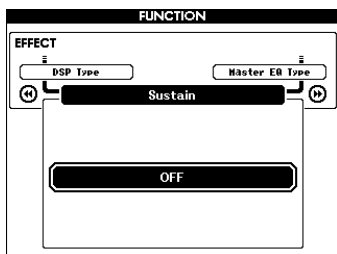

- 3 Use the dial to turn panel sustain on or off.

NOTE

- The sustain of some voices may not be markedly affected when the panel sustain function is turned on.

Pitch Bend

The pitch bend wheel can be used to add smooth pitch variations to notes you play on the keyboard. Roll the wheel upward to raise the pitch, or downward to lower the pitch.

You can change the amount of pitch bend produced by the wheel, as described on page 87.

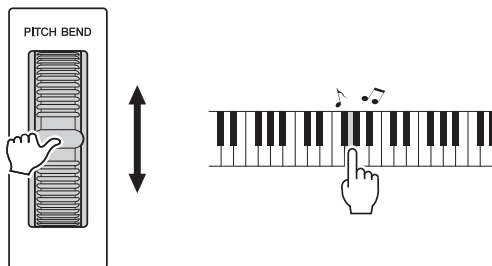

Select an EQ Setting for the Best Sound

Five different master equalizer (EQ) settings are provided to give you the best possible sound when listening through different reproduction systems—the instrument’s internal speakers, headphones, or an external speaker system.

1 Press the [FUNCTION] button.

The currently selected function will appear in the display.

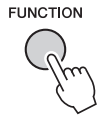

2 Press the CATEGORY [◀] and [▶] buttons as many times as necessary to select the master EQ type function “Master EQ Type”:

The currently selected EQ type will appear.

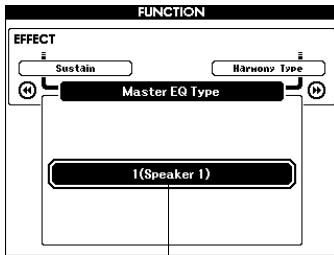

The currently selected master EQ type.

3 Use the dial to select the desired Master EQ setting.

Five settings are available: 1–5. Settings 1 and 2 are best for listening via the instrument’s built-in speakers, setting 3 is for headphones, and settings 4 and 5 are ideal for listening via external speakers.

Handy Performance Features

Tap Start

You can start the song/style by simply tapping the [TEMPO/TAP] button at the required tempo—4 times for time signatures in 4, and three times for time signatures in 3. You can change the tempo during song/style playback by pressing the button just twice.

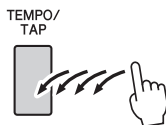

One Touch Setting

Sometimes selecting the ideal voice to play with a song or style can be confusing. The One Touch Setting feature automatically selects a well-balanced voice for you when you select a style or song. Simply select voice number “000” to activate this feature.

Setting the Click bell sound

This allows you to select whether the click sound has a bell accent, or plays only a click sound.

- 1 Press the [FUNCTION] button.

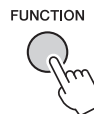

- 2 Use the CATEGORY [◀] and [▶] buttons to select the Bell item.

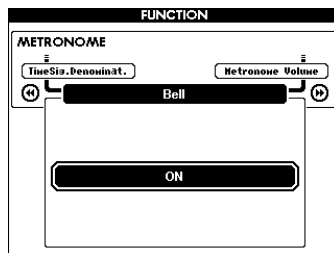

- 3 You can then use the [+] and [-] buttons to turn the bell sound on or off.

Adjusting the Metronome Volume

- 1 Press the [FUNCTION] button.

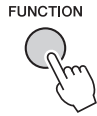

- 2 Use the CATEGORY [◀] and [▶] buttons to select the Metronome Volume item.

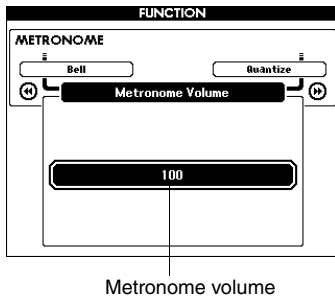

- 3 Use the dial to set the metronome volume as required.

Changing the Display Language

This instrument allows you to select English or Japanese as the display language. The default display language is English, but if you switch to Japanese the lyrics, file names, and some messages will be displayed in Japanese where appropriate.

- 1 Press the [FUNCTION] button.

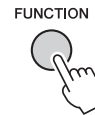

- 2 Press the CATEGORY [◀] and [▶] buttons a number of times until the “Language” item appears.

The currently selected display language will appear below the “Language” item. When highlighted you can use the [+] and [-] buttons to select the language as required.

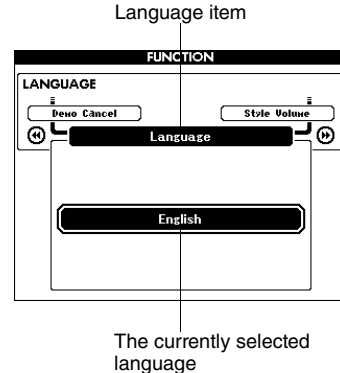

- 3 Select a display language.

The [+] button selects English and the [-] button selects Japanese.

The language selection will be stored in the internal flash memory so that it is retained even when the power is turned off.

Voice Settings

Voice Editing

Create original voices by editing the many available voice parameters. By editing the various parameters available you can create new voices that best suit your musical needs.

1 Press the [FUNCTION] button.

The currently selected function will appear in the display.

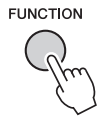

2 Use the CATEGORY [◀] and [▶] buttons to select the item you want to edit.

You can individually adjust the voice setting (Volume, Octave, Pan, Reverb Level, Chorus Level and DSP Level) that is applied to the main, dual, and split voices. Refer to the Functions on page 87 for details.

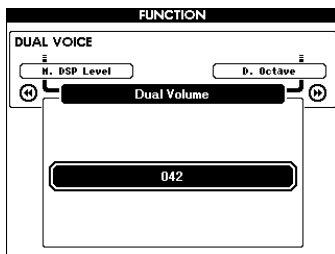

3 Use the dial to set the value.

Edited parameters can be saved to registration memory. If you select a different keyboard voice the parameters will be reset and the ideal settings for the selected voice will be automatically recalled.

Category	Function Item	Range/Settings
MAIN VOICE	Main Volume	000–127
	Main Octave	-2+2
	Main Pan	000 (left)–64 (center)–127 (right)
	Main Reverb Level	000–127
	Main Chorus Level	000–127
	Main DSP Level	000–127
DUAL VOICE	Dual Volume	000–127
	Dual Octave	-2+2
	Dual Pan	000 (left)–64 (center)–127 (right)
	Dual Reverb Level	000–127
	Dual Chorus Level	000–127
	Dual DSP Level	000–127
SPLIT VOICE	Split Volume	000–127
	Split Octave	-2+2
	Split Pan	000 (left)–64 (center)–127 (right)
	Split Reverb Level	000–127
	Split Chorus Level	000–127

Selecting a Dual Voice

- 1 Press and hold the [DUAL ON/OFF] button for longer than a second.

The dual voice selection display will appear.

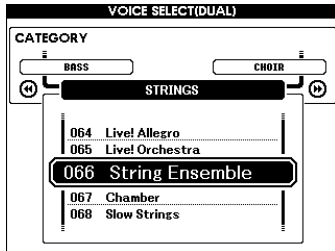
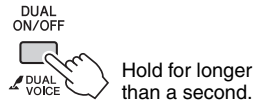

- 2 Select the desired dual voice.

Watch the displayed dual voice and rotate the dial until the voice you want to use is selected. The voice selected here becomes the dual voice.

Press the [EXIT] button to return to the MAIN display.

Selecting a Split Voice

- 1 Press and hold the [SPLIT ON/OFF] button for longer than a second.

The split voice selection display will appear.

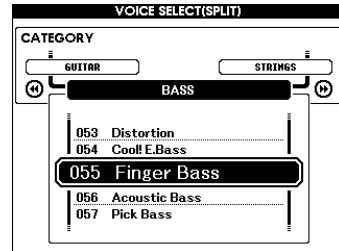
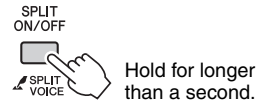

- 2 Select the desired split voice.

Watch the highlighted split voice and rotate the dial until the voice you want to use is selected. The voice selected here becomes the split voice which will play to the left of the keyboard split point.

Press the [EXIT] button to return to the MAIN display.

Pitch Controls (Transpose)

The overall pitch of the instrument can be shifted up or down by a maximum of 1 octave in semitone increments.

- 1 Press the [FUNCTION] button.

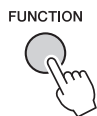

- 2 Use the CATEGORY [◀◀] and [▶▶] buttons to select the Transpose item.

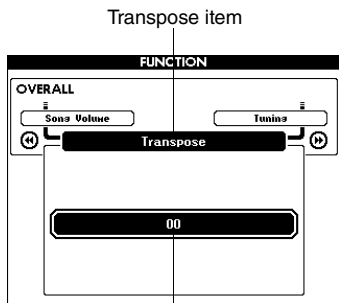

Can be set between -12 and +12

- 3 Use the dial to set the transpose value between -12 and +12 as required.

NOTE

- The pitch of Drum Kits voices cannot be changed.

Pitch Controls (Tuning)

The overall tuning of the instrument can be shifted up or down by a maximum of 100 cents in 1-cent increments (100 cents = 1 semitone).

- 1 Press the [FUNCTION] button.

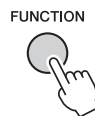

- 2 Use the CATEGORY [◀◀] and [▶▶] buttons to select the Tuning item.

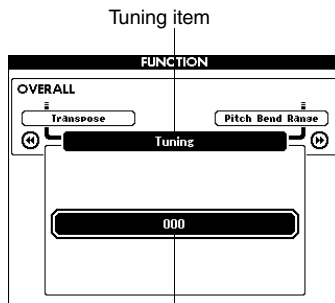

Can be set between -100 and +100

- 3 Use the dial to set the tuning value between -100 and +100 as required.

NOTE

- The pitch of Drum Kits voices cannot be changed.

Touch Response Sensitivity

You can adjust the keyboard's sensitivity to dynamics in three steps.

1 Press the [FUNCTION] button.

The currently selected function will appear in the display.

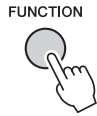

2 Use the CATEGORY [◀] and [▶] buttons to select the Touch Sensitivity item.

The currently selected touch sensitivity will be displayed.

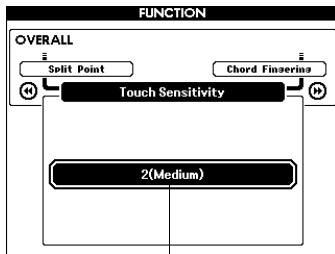

Touch Sensitivity item

3 Use the dial to select a touch sensitivity setting between 1 and 3. Higher values produce greater (easier) volume variation in response to keyboard dynamics —i.e. greater sensitivity.

A setting of “4” results in a fixed touch response, or no level change no matter how hard or how soft you play the keys.

NOTE

- The initial default touch sensitivity setting is “2”.

Style (Auto-accompaniment) Functions

Basic operation of the Style (auto-accompaniment) feature is described on page 24 of the Quick Guide.

Here are some other ways you can play the styles, the style volume adjustment procedure, and more.

Pattern Variation (Sections)

The instrument features a wide variety of style “sections” that allow you to vary the arrangement of the accompaniment to match the song you are playing.

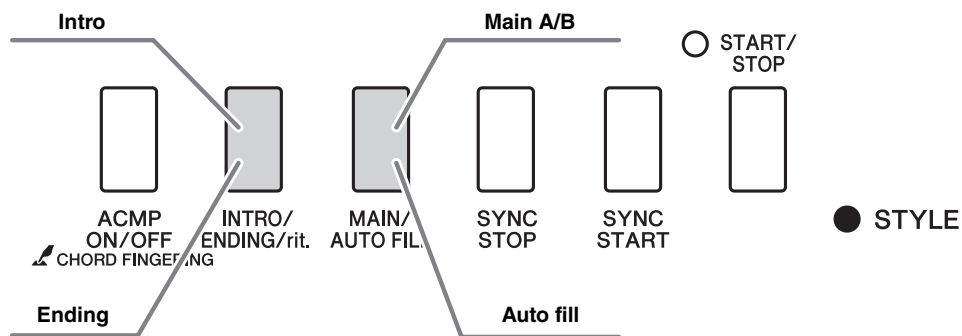

INTRO section

This is used for the beginning of the Song. When the intro finishes playing, accompaniment shifts to the main section. The length of the intro (in measures) differs depending on the selected Style.

MAIN section

This is used for playing the main part of the Song. It plays a main accompaniment pattern, and repeats indefinitely until another section's button is pressed. There are two variations on the basic pattern (A and B), and the Style playback sound changes harmonically based on the chords you play with your left hand.

Fill-in section

This is automatically added before changing to section A or B.

ENDING section

This is used for the ending of the Song. When the ending is finished, the auto accompaniment stops automatically. The length of the ending (in measures) differs depending on the selected Style.

1 Press the [STYLE] button and then select a style.

2 Press the [ACMP ON/OFF] button to turn auto accompaniment on.

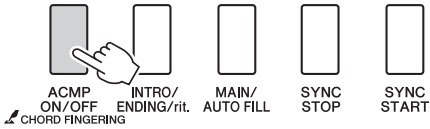

Appears when auto accompaniment is on.

3 Press the [SYNC START] button to turn synchro start on.

The indicator will flash when the synchro start standby mode will be engaged.

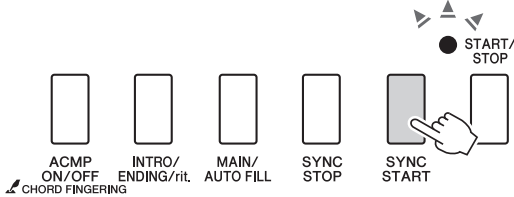

Synchro Start

When the synchro start standby mode is engaged, style playback will begin as soon as you play a chord in the accompaniment range of the keyboard. You can disengage the synchro-start standby mode by pressing the [SYNC START] button again.

4 Press the [MAIN/AUTO FILL] button.

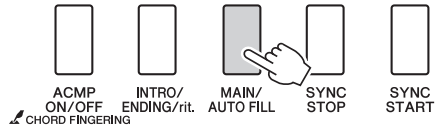

The name of the selected section—MAIN A or MAIN B—will be displayed.

5 Press the [INTRO/ENDING/rit.] button.

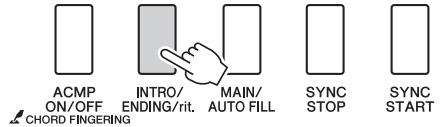

You're now ready to play the intro.

6 As soon as you play a chord with your left hand, the Intro of the selected Style starts.

For this example, play a C major chord (as shown below). For information on how to enter chords, see "Chords" on page 27.

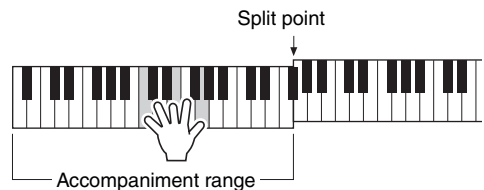

7 Press the [MAIN/AUTO FILL] button.

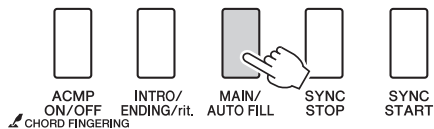

When the fill-in is finished, it leads smoothly into the selected main section A/B.

8 Press the [INTRO/ENDING/rit.] button.

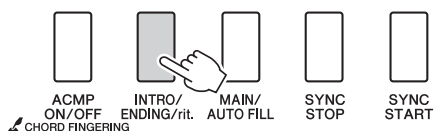

This switches to the ending section. When the ending is finished, the auto accompaniment stops automatically. You can have the ending gradually slow down (ritardando) by pressing the [INTRO/ENDING/rit.] button again while the ending is playing back.

Syncho Stop

When this function is selected the accompaniment style will only play while you are playing chords in the accompaniment range of the keyboard. Style playback will stop when you release the keys. To turn the function on, press the [SYNC STOP] button.

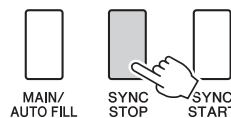

The style will play while you are playing the keys

Style playback will stop when you release the keys

Changing the tempo of the Style

Styles can be played at any tempo you desire—fast or slow.

- 1 Press the [TEMPO/TAP] button to call up the Tempo setting in the display after selecting a Style.

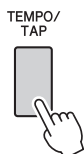

- 2 Use the dial to select a tempo from 011 to 280 quarter-note beats per minute.

Press the [+] and [-] buttons simultaneously to instantly reset the value to the default tempo of a Style.

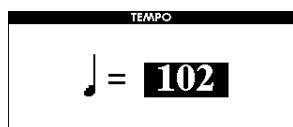

You can change the tempo during style playback by pressing the [TEMPO/TAP] button just twice.

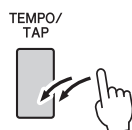

Adjusting the Style Volume

Press the [STYLE] button to engage the style function.

- 1 Press the [FUNCTION] button.

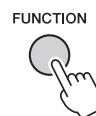

- 2 Use the CATEGORY [◀] and [▶] buttons to select the Style Volume item.

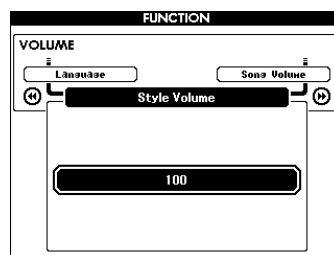

- 3 Use the dial to set the style volume between 000 and 127.

Setting the Split Point

The initial default split point is key number 54 (the F#2 key), but you can change it to another key using the procedure described below.

- 1 Press the [FUNCTION] button.

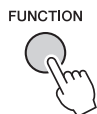

- 2 Use the CATEGORY [◀] and [▶] buttons to select the Split point item.

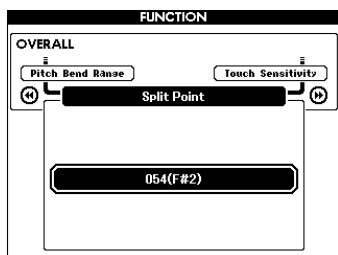

- 3 Use the dial to set the split point to any key from 021(A-1) through 108 (C7).

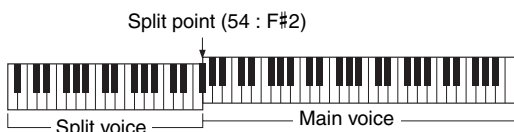

NOTE 1

- When you change the split point the auto-accompaniment split point also changes.
- The split point cannot be changed during a song lesson.
- The split voice sounds when the split-point key is played.

Play a Style with Chords but No Rhythm (Stop Accompaniment)

When auto accompaniment is on (the ACMP ON icon is showing) and Synchro Start is off, you can play chords in the left-hand accompaniment range of the keyboard while the style is stopped and still hear the accompaniment chords. This is “Stop Accompaniment”, and any of the chord fingerings recognized by the instrument can be used.

- Press the [ACMP ON/OFF] button to turn auto accompaniment on after pressing the [STYLE] button.

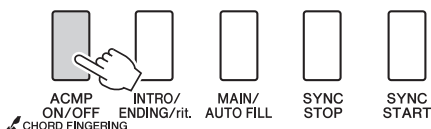

Appears when auto accompaniment is on

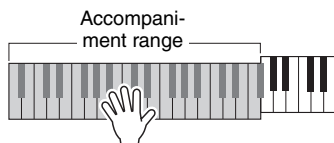

AI Fingered

Less than three notes can be played to indicate the chords (based on the previously played chord, etc.).

- 1 Press and hold the [ACMP ON/OFF] button for longer than a second to select the function “Chord Fingering”.

In this mode Easy Chords cannot be detected.

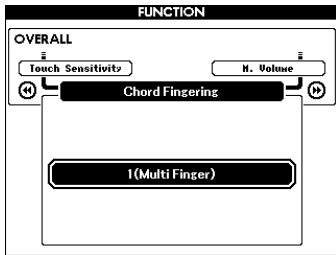
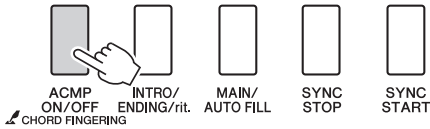

- 2 Use the dial to select 3 “AI Fingered”.

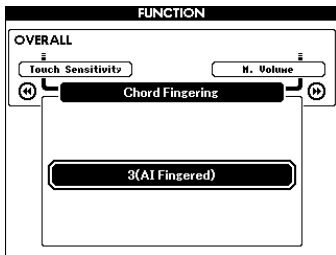

To reset the chord fingering to default setting, select 1 “Multi Finger”.

Playing Styles Using the Entire Keyboard

In “Play Along with a Style” on page 25 we described a method of playing styles in which chords were detected only to the left of the keyboard split point. By making the settings described below, however, chord detection for style accompaniment occurs over the entire range of the keyboard, allowing for even more dynamic style performance. In this mode Easy Chords cannot be detected.

- 1 Press and hold the [ACMP ON/OFF] button for longer than a second to select the function “Chord Fingering”.

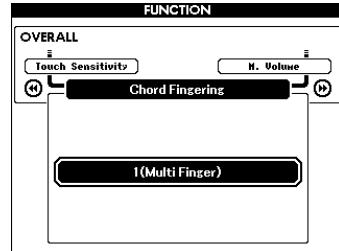
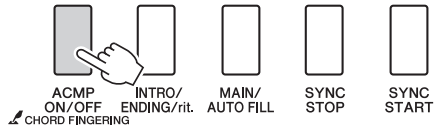

- 2 Use the dial to select 2 “FullKeyboard”.

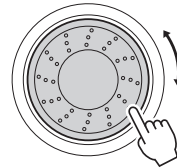

To reset the chord fingering to default setting, select 1 “Multi Finger”.

Looking Up Chords Using the Chord Dictionary

The Dictionary function is essentially a built-in “chord book” that shows you the individual notes of chords. It is ideal when you know the name of a certain chord and want to quickly learn how to play it.

- 1 Press and hold the [MINUS ONE] button for longer than a second.

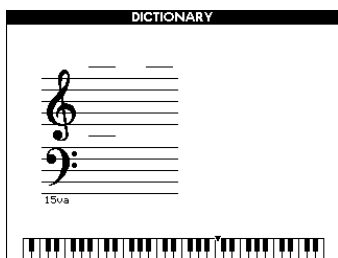
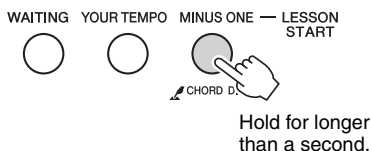

- 2 As an example, we'll learn how to play a GM7 (G major seventh) chord. Press the “G” key in the section of the keyboard labeled “ROOT”. (The note doesn't sound.) The root note you set is shown in the display.

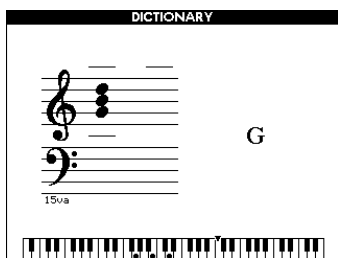
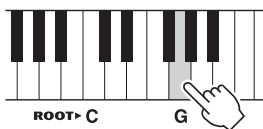

- 3 Press the “M7” (major seventh) key in the section of the keyboard labeled “CHORD TYPE”. (The note doesn't sound.) The notes you should play for the specified chord (root note and chord type) are shown in the display, both as notation and in the keyboard diagram.

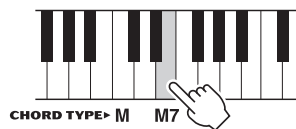

Notation of chord Chord name (root and type)

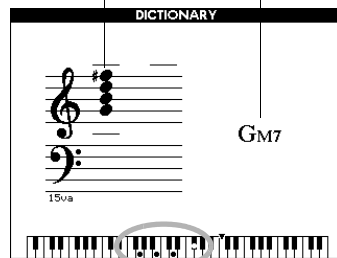

Individual notes of chord (keyboard)

To call up possible inversions of the chord, press the [+]/[-] buttons.

NOTE

- About major chords: Simple major chords are usually indicated only by the root note. For example, “C” refers to C major. However, when specifying major chords here, make sure to select “M” (major) after pressing the root note.
- Be aware that the chord types explained here are the left-hand notes applied to various styles and different from the one for the performance assistant technology feature.

- 4 Try playing a chord in the auto accompaniment section of the keyboard, checking the indications in the display. When you've played the chord properly, a bell sound signals your success and the chord name in the display flash.

Press the [EXIT] button to return to the MAIN display.

Song Settings

Changing the tempo of the Song

Songs can be played at any tempo you desire—fast or slow.

- 1 Press the [TEMPO/TAP] button to call up the Tempo setting in the display after selecting a Song.

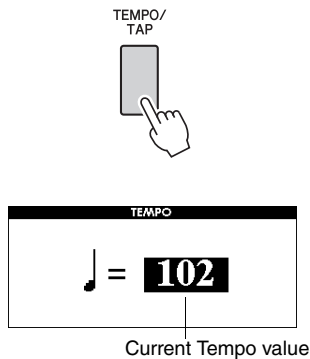

- 2 Use the dial to select a tempo from 011 to 280 quarter-note beats per minute. Press the [+] and [-] buttons simultaneously to instantly reset the value to the default tempo of a Song.

You can change the tempo during song playback by pressing the [TEMPO/TAP] button just twice.

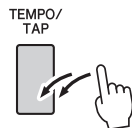

Song Volume

- 1 Press the [FUNCTION] button.

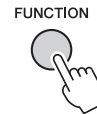

- 2 Use the CATEGORY [◀] and [▶] buttons to select the Song Volume item.

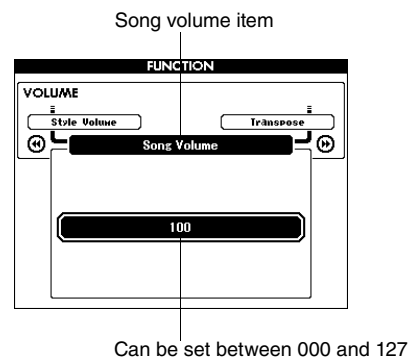

- 3 Use the dial to set the song volume between 000 and 127.

NOTE

- Song volume can be adjusted while a song is selected.

A-B Repeat

You can specify a section of a song—"A" is the start point and "B" is the end point—for repeat playback.



- 1 Play the song and press the [A-B REPEAT] button at the beginning of the section you want to repeat (the "A" point).

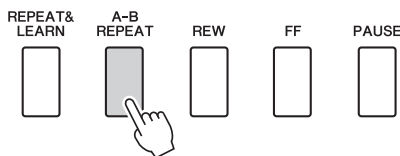

- 2 Press the [A-B REPEAT] button a second time at the end of the section you want to repeat (the "B" point).

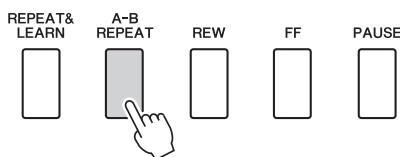

- 3 The specified A-B section of the song will now play repeatedly.

You can stop repeat playback at any time by pressing the [A-B REPEAT] button.

NOTE

- Repeat start and end points cannot be specified within the same measure. While the song is stopped.
- The current measure number is shown in the display during playback.
- If you want to set the start point "A" at the very beginning of the song, press the [A-B REPEAT] button before starting playback of the song.

Muting Independent Song Tracks

Each "track" of a song plays a different part of the song—melody, percussion, accompaniment, etc. You can mute individual tracks and play the muted part on the keyboard yourself, or simply mute tracks other than the ones you want to listen to. To mute a track, press the appropriate track button (TRACK [1]–[5], [A]) button. Press the same button a second time to disengage track muting.



Track number with border
... track contains data and is not muted.



No track number ... no data.

Track number without border
... track contains data but is muted.

Change the Melody Voice

You can change a song's melody voice to any other voice you prefer.

Press the [VOICE] button for longer than a second during the song playback. The VOICE SELECT (MELODY R or MELODY L) display will appear so you can select the Melody R or Melody L voice. Pressing the [VOICE] button alternates between VOICE SELECT MELODY R and MELODY L. Use the dial to select the voice. As you select different melody voices, only the melody voice changes while the song will remain the same.

BGM Playback

With the default setting only one demo song is played back and repeated when the [DEMO/BGM] button is pressed. This setting can be changed so that all internal songs, all songs transferred to the instrument from a computer, or all MIDI songs on a USB flash memory connected to the instrument are played. Five playback group settings are provided. Simply select the one that suits your needs.

- 1 Press and hold the [DEMO/BGM] button for longer than a second to call up the “Demo Group” selection display.

The currently selected repeat playback target will appear.

DEMO/BGM



Hold for longer than a second.

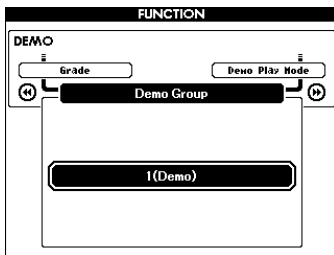

- 2 Use the dial to select a repeat playback group from the table below.

Demo	Demo Song
Preset	All preset songs
User	All User songs
Download	All songs transferred from a computer
USB	All songs stored on a USB flash memory connected to the instrument.

Random Song Playback

The random play mode causes the songs in the group selected for BGM playback to be played back in random order.

- 1 Press the [FUNCTION] button.

FUNCTION



- 2 Press the CATEGORY [◀◀] and [▶▶] buttons as many times as necessary to select “Demo Play Mode”.

The currently selected repeat playback mode will appear.

You cannot select the repeat playback mode when “Demo” is selected as the repeat playback group.

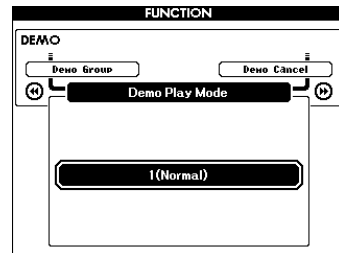

- 3 Use the dial to select “Random”.

If you want to restore the normal playback mode, select “Normal”.

The Functions

The “Functions” provide access to a range of detailed instrument parameters for tuning, setting the split point, and adjusting the voices and effects. Take a look at the function list starting on the opposite page. There are 53 function parameters in all. When you locate a function you want to set up, simply select the function’s display name and adjust as required.

Selecting and Setting Functions

- 1 Find the function you want to set in the list that begins on page 87.
- 2 Press the [FUNCTION] button.

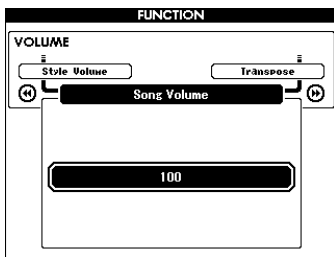
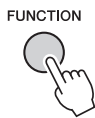

- 3 Select a function. Press the CATEGORY [◀] and [▶] buttons as many times as necessary until the function’s display name appears in the display.

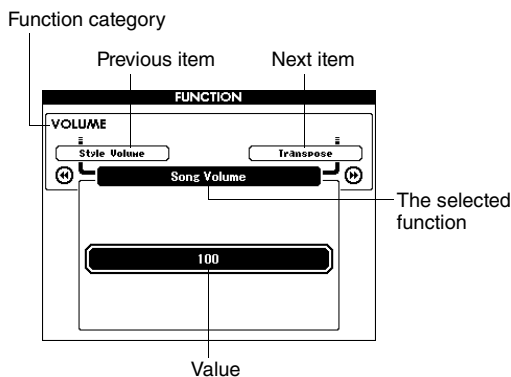
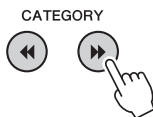

- 4 Use the dial, the [+] and [-] buttons, or the [0]–[9] number buttons to set the selected function as required.

The [+] and [-] buttons are used to make ON/OFF type settings: [+] = ON, [-] = OFF.

In some cases the [+] button will initiate execution of the selected function, and the [-] will cancel the selection.

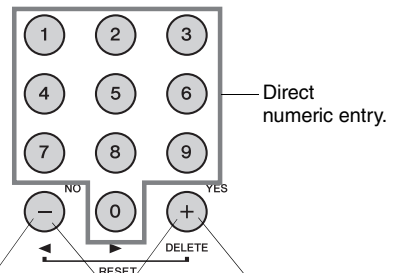

- Decrement value by 1.
- OFF
- Cancel
- Press simultaneously to recall the default setting.
- Increment value by 1.
- ON
- Execute

Some Function settings are stored in memory as soon as they are changed. See “The Backup Parameters” on page 64 for information on the function settings that are stored on the instrument.

To restore all initial factor default settings perform the “Backup Clear” procedure described in the “Initialization” section on page 64.

Function Setting List

Category	Function Item	Range/Settings	Description
VOLUME	Style Volume	000–127	Determines the volume of the Style.
	Song Volume	000–127	Determines the volume of the Song.
OVERALL	Transpose	-12→+12	Determines the pitch of the instrument by semitone increments.
	Tuning	-100→+100	Sets the pitch of the instrument's sound in 1-cent increments.
	Pitch Bend Range	01–12	Sets the pitch bend range in semitone increments.
	Split Point	021(A-1)–108(C7)	Determines the highest key for the Split voice and sets the Split “point”—in other words, the key that separates the Split (lower) and Main (upper) voices. The Split Point setting and Accompaniment Split Point setting are automatically set to the same value.
	Touch Sensitivity	1(Soft), 2(Medium), 3(Hard), 4(Off)	Determines the sensitivity of the feature.
	Chord Fingering	1(Multi Finger), 2(FullKeyboard), 3(AI Fingered)	Sets the chord detection mode. In the Multi Finger mode both normal chords and simple chords played to the left of the split point are detected. In the Full Keyboard mode normal chords played anywhere on the keyboard will be detected, and the notes played will be sound as well. In the AI Fingered mode, less than three notes can be played to indicate the chords (based on the previously played chord, etc.).
MAIN VOICE	Main Volume	000–127	Determines the volume of the Main voice.
	Main Octave	-2→+2	Determines the octave range for the Main voice.
	Main Pan	000 (left)– 64 (center)– 127 (right)	Determines the pan position of the Main voice in the stereo image. The value “0” results in the sound being panned full left; the value “127” results in the sound being panned full right.
	Main Reverb Level	000–127	Determines how much of the Main voice's signal is sent to the Reverb effect.
	Main Chorus Level	000–127	Determines how much of the Main voice's signal is sent to the Chorus effect.
	Main DSP Level	000–127	Determines how much of the Main voice's signal is sent to the DSP effect.
DUAL VOICE	Dual Volume	000–127	Determines the volume of the Dual voice.
	Dual Octave	-2→+2	Determines the octave range for the Dual voice.
	Dual Pan	000 (left)– 64 (center)– 127 (right)	Determines the pan position of the Dual voice in the stereo image. The value “0” results in the sound being panned full left; the value “127” results in the sound being panned full right.
	Dual Reverb Level	000–127	Determines how much of the Dual voice's signal is sent to the Reverb effect.
	Dual Chorus Level	000–127	Determines how much of the Dual voice's signal is sent to the Chorus effect.
	Dual DSP Level	000–127	Determines how much of the Dual voice's signal is sent to the DSP effect.
SPLIT VOICE	Split Volume	000–127	Determines the volume of the Split voice.
	Split Octave	-2→+2	Determines the octave range for the Split voice.
	Split Pan	000 (left)– 64 (center)– 127 (right)	Determines the pan position of the Split voice in the stereo image. The value “0” results in the sound being panned full left; the value “127” results in the sound being panned full right.
	Split Reverb Level	000–127	Determines how much of the Split voice's signal is sent to the Reverb effect.
	Split Chorus Level	000–127	Determines how much of the Split voice's signal is sent to the Chorus effect.

Category	Function Item	Range/Settings	Description
EFFECT	Reverb Type	01–36	Determines the Reverb type, including off.
	Chorus Type	1–45	Determines the Chorus type, including off.
	DSP ON/OFF	ON/OFF	Determines whether the DSP effect is on or off.
	DSP Type	001–239	Determines the DSP type.
	Sustain	ON/OFF	Determines whether or not panel sustain is always applied to the MAIN/ DUAL voices. Panel sustain is applied continuously when ON, or not applied when OFF.
	Master EQ Type	1(Speaker 1), 2(Speaker 2), 3(Headphones), 4(Line Out 1), 5(Line Out 2)	Sets the equalizer applied to the speaker output for optimum sound in different listening situations.
HARMONY	Harmony Type	01–26	Determines the Harmony type.
	Harmony Volume	000–127	Determines the volume of the Harmony effect.
PAT	P.A.T. Type	CHORD, CHORD/FREE, MELODY, CHORD/MELODY	Determines the performance assistant technology feature type.
PC	PC Mode	PC1/PC2/OFF	Optimizes the MIDI settings when you connect to a computer.
MIDI	Local	ON/OFF	Determines whether the instrument's keyboard controls the internal tone generator (ON) or not (OFF).
	External Clock	ON/OFF	Determines whether the instrument synchronizes to the internal clock (OFF) or an external clock (ON).
	Keyboard Out	ON/OFF	Determines whether keyboard performance data of the instrument is transmitted (ON) or not (OFF).
	Style Out	ON/OFF	Determines whether Style data is transmitted (ON) via USB or not (OFF) during Style playback.
	Song Out	ON/OFF	Determines whether User Song is transmitted (ON) via USB or not (OFF) during Song playback.
	Initial Setup	YES/NO	Lets you send the data of the panel settings to a computer. Press [+] to send, or press [-] to cancel.
METRO- NOME	Time Signature - Numerator	01–60	Determines the time signature of the Metronome.
	Time Signature - Denominator	2, 4, 8, 16	Sets the length of each metronome beat.
	Bell	ON/OFF	Determines whether a bell accent will be sounded (ON) or not (OFF).
	Metronome Volume	000–127	Determines the volume of the Metronome.
SCORE	Quantize	1(1/4 note), 2(1/4 note triplet), 3(1/8 note), 4(1/8 note triplet), 5(1/16 note), 6(1/16 note triplet), 7(1/32 note), 8(1/32 note triplet)	Depending on the song data, you can make the score more readable by adjusting the timing of the notes. This determines the minimum timing resolution used in the song. For example, if there are both quarter notes and eighth notes in the song, you should set this value to "eighth note." Any notes or rests shorter than this value will not be shown in the score.
SONG/ LESSON	Right-Part	GuideTrack 1–16, OFF	Determines the guide track number for your right hand lesson. The setting is effective for songs in SMF format 0 and 1 transferred from a computer.
	Left-Part	GuideTrack 1–16, OFF	Determines the guide track number for your left hand lesson. The setting is effective for songs in SMF format 0 and 1 transferred from a computer.
LESSON	Grade	ON/OFF	Determines whether the Grade function is on or off.

Category	Function Item	Range/Settings	Description
DEMO	Demo Cancel	ON/OFF	Determines whether Demo cancel is enabled or not. When this is set to ON, the Demo Song will not play, even if the [DEMO/BGM] button is pressed.
	DEMO GROUP	1(Demo), 2(Preset), 3(User), 4(Download), 5(USB)	Determines the repeat playback group.
	DEMO PLAY MODE	1(Normal)/ 2(Random)	Determines the repeat playback mode.
LANGUAGE	Language	English/Japanese	Determines the display language for the song file names, lyrics and certain display messages. All other messages and names are displayed in English. When this is set to Japanese, the file names are displayed in the Japanese font. The lyrics display follows the language setting originally made in the song data; however, when no such setting exists, the setting here is used.

* All these settings can be conveniently reset to their initial default values by pressing the [+] and [-] buttons simultaneously. (The exception to this is Initial Send, which is an operation, not a setting.)

Saving and Loading Data

USB flash memory is a memory medium used for storing data. When a USB flash memory is inserted in this instrument's USB TO DEVICE terminal, registered settings can be saved from or loaded into the instrument. In this section we'll look at the procedures for setting up and formatting USB flash memory devices, as well as for saving and loading data to and from them. Before using a USB device, read through the "Precautions when using the USB TO DEVICE terminal" section on page 91.

Connecting a USB Flash Memory

- 1 Connect a USB flash memory to the USB TO DEVICE terminal, being careful to insert it with the proper orientation.

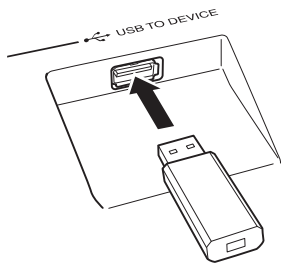

A message (information or confirmation dialog) sometimes appears on the display to facilitate operation. Refer to the "Messages" on page 110 for an explanation of each message.

- 2 Wait for confirmation that the USB flash memory has been properly mounted.

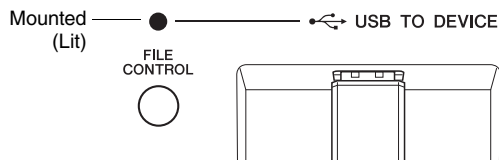
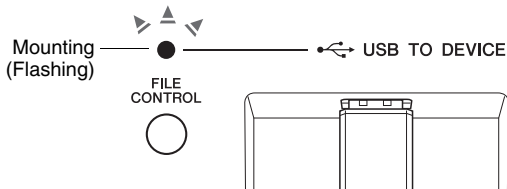

- 3 Press the [FILE CONTROL] button to call up the FILE CONTROL display.

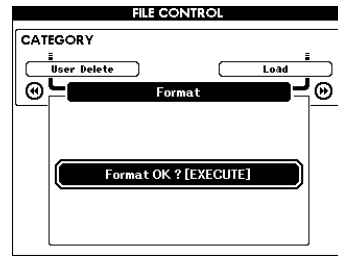

You can access file operations listed below by pressing the category [◀] and [▶] buttons from FILE CONTROL display.

Menu	Reference page
Format	92
User File Save	93
User Song Save	94
Load	95
USB Delete	96
User Delete	96

If you press the [FILE CONTROL] button while an unformatted USB flash memory is connected to the instrument, the "Format" function will automatically be selected.

To exit from the FILE CONTROL display press the [EXIT] button.

NOTE

- No sound will be produced if you play the keyboard while the FILE CONTROL display is showing. Also, in this state only buttons related to file functions will be active.

NOTE

- The FILE CONTROL display will not appear in any of the following cases:
 - During style or song playback.
 - During a lesson.
 - While data is being loaded from a USB flash memory.

Precautions when using the USB TO DEVICE terminal

This instrument features a built-in USB TO DEVICE terminal. When connecting a USB device to the terminal, be sure to handle the USB device with care. Follow the important precautions below.

NOTE

- Although CD-R/RW drives can be used to read data to the instrument, they cannot be used for saving data.

Compatible USB devices

- USB storage devices (flash memory, floppy disk drive)

The instrument does not necessarily support all commercially available USB devices. Yamaha cannot guarantee operation of USB devices that you purchase. Before purchasing a USB device for use with this instrument, please visit the following web page: <http://music.yamaha.com/download/>

NOTE

- Other USB devices such as a computer keyboard or mouse cannot be used.

Connecting USB device

- When connecting a USB device to the USB TO DEVICE terminal, make sure that the connector on the device is appropriate and that it is connected in the proper direction.
- Though the instrument supports the USB 1.1 standard, you can connect and use a USB 2.0 storage device with the instrument. However, note that the transfer speed is that of USB 1.1.

Using USB Storage Devices

By connecting the instrument to a USB storage device, you can save data you've created to the connected device, as well as read data from the connected device.

NOTE

- Although CD-R/RW drives can be used to read data to the instrument, they cannot be used for saving data.

The number of USB storage device to be used

Only one USB storage devices can be connected to the USB TO DEVICE terminal.

Formatting USB storage media

When a USB storage device is connected or media is inserted, a message may appear prompting you to format the device/media. If so, execute the Format operation (page 92).

NOTICE

- The format operation overwrites any previously existing data. Make sure that the media you are formatting does not contain important data.

To protect your data (write-protect)

To prevent important data from being inadvertently erased, apply the write-protect provided with each storage device or media. If you are saving data to the USB storage device, make sure to disable write-protect.

Connecting/removing USB storage device

Before removing the media from the device, make sure that the instrument is not accessing data (such as in the Save and Delete operations).

NOTICE

- Avoid frequently turning the power on/off to the USB storage device, or connecting/disconnecting the device too often. Doing so may result in the operation of the instrument "freezing" or hanging up. While the instrument is accessing data (such as during Save, Delete, Load and Format operations) or is mounting the USB storage device (shortly after the connection), do NOT unplug the USB connector, do NOT remove the media from the device, and do NOT turn the power off to either device. Doing so may corrupt the data on either or both devices.

All the instructions in this chapter are related to the FILE CONTROL display. To call up the FILE CONTROL display, press the [FILE CONTROL] button.

Formatting USB Flash Memory

New USB flash memory must be formatted before they can be used by this instrument.

NOTICE

- If a USB flash memory that contains data is formatted as described below, the data will be erased. Make sure that a USB flash memory to be formatted contains no important data before carrying out the formatting procedure.

1 Use the CATEGORY [◀] and [▶] buttons to select the Format item.

The display prompts you for confirmation.

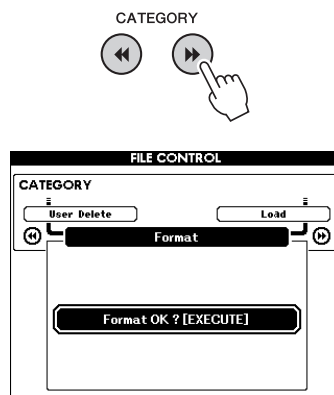

2 Press the [EXECUTE] button and the display prompts you for confirmation.

You can press the [-] button at this point to cancel the operation.

3 Press the [EXECUTE] button again, or the [+] button, and the format operation will begin.

NOTICE

- Once the format-in-progress message appears on the display the format operation cannot be canceled. Never turn off the power or remove the USB flash memory during this operation.

4 A message will appear on the display to inform you that the operation has finished.

Press the [EXIT] button to return to the MAIN display.

NOTE

- If the USB flash memory has been write-protected, an appropriate message will appear on the display and you will not be able to execute the operation.

Saving User Files (Registration Memory) to USB Flash Memory

This operation saves a “User File” containing the registration memory data to a USB flash memory device. The User File name will have a “.usr” extension which will not appear in the instrument’s display.

1 Use the CATEGORY [◀] and [▶] buttons to locate the Regist Save item.

A default file name will automatically be created.

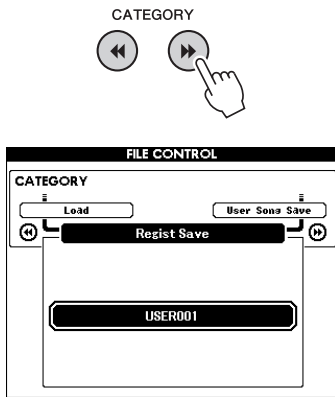

To Overwrite an Existing File

If you want to overwrite a file that already exists on the USB flash memory, use the dial or the [+] and [-] buttons to select the file, then skip ahead to step 4.

NOTE

- Up to 100 user files can be saved to a single USB flash memory.

2 Press the [EXECUTE] button. A cursor will appear below the first character in the file name.

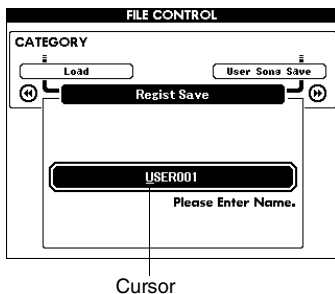

3 Change the file name as necessary.

- The [-] button moves the cursor to the left, and the [0] button moves it to the right.
- Use the dial to select a character for the current cursor location.
- The [+] button deletes the character at the cursor location.

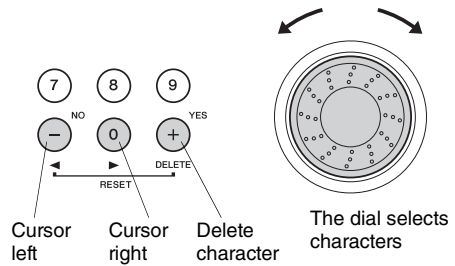

4 Press the [EXECUTE] button. The display prompts you for confirmation.

You can cancel the save operation at this point by pressing the [-] button.

5 Press the [EXECUTE] button again, or the [+] button, and the save operation will begin.

User file will be saved in a folder labeled “USER FILES” which will automatically be created on the USB flash memory.

NOTICE

- Once the save-in-progress message appears on the display the operation cannot be canceled. Never turn off the power or remove the USB flash memory during this operation.

6 A message will appear on the display to inform you that the operation has finished.

Press the [EXIT] button to return to the MAIN display.

NOTE

- If an existing filename is specified the display prompts you for confirmation. Press [EXECUTE] or [+] if it is OK to overwrite the file, or [-] to cancel.
- The amount of time it will take to perform the save operation will depend on the condition of the USB flash memory.

Save a User Song to USB Flash Memory

This operation saves a user song (song numbers 031–035) to USB flash memory.

- 1 Use the **CATEGORY** [**◀◀**] and [**▶▶**] buttons to locate the **User Song Save** item. The **SOURCE FILE**—a user song name—will be highlighted.

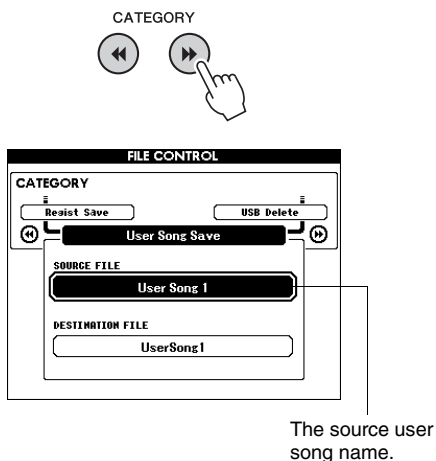

- 2 Select the source user song. You can press the [**+**] and [**-**] buttons simultaneously to select the first user song.
- 3 Press the [**EXECUTE**] button. The **DESTINATION SONG** will be highlighted, and a default name will automatically be created.

To Overwrite an Existing File

If you want to overwrite a file that already exists on the USB flash memory, use the dial or the [**+**] and [**-**] buttons to select the file, then skip ahead to step 6.

- 4 Press the [**EXECUTE**] button. A cursor will appear below the first character in the file name.

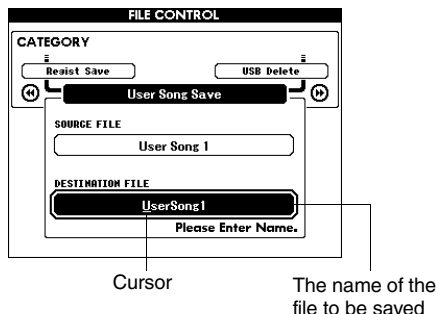

- 5 Change the file name as necessary. Refer to “Saving User Files (Registration Memory) to USB Flash Memory” on page 93 for file-name entry.
- 6 Press the [**EXECUTE**] button. The display prompts you for confirmation. You can cancel the save operation at this point by pressing the [**-**] button.
- 7 Press the [**EXECUTE**] button again, or the [**+**] button, and the save operation will begin. User song will be saved in a folder labeled “USER FILES” which will automatically be created on the USB flash memory.

NOTICE

- Once the save-in-progress message appears on the display the operation cannot be canceled. Never turn off the power or remove the USB flash memory during this operation.

- 8 A message will appear on the display to inform you that the operation has finished.

Press the [**EXIT**] button to return to the MAIN display.

NOTE

- If an existing filename is specified the display prompts you for confirmation. Press [**EXECUTE**] or [**+**] if it is OK to overwrite the file, or [**-**] to cancel.
- The amount of time it will take to perform the save operation will depend on the condition of the USB flash memory.

Loading Files from a USB Flash Memory

User files as well as Style, Song, and Music Database files residing on a USB flash memory can be loaded into the instrument.

NOTICE

- If you load a User File registration memory data will be overwritten by the newly loaded data. Save important data to a USB flash memory before loading data that will overwrite it.

- 1 Use the CATEGORY [◀] and [▶] buttons to locate the Load item.

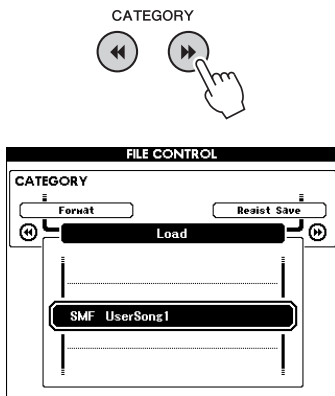

- 2 Use the dial to select the file you want to load.

All user files in the USB flash memory will be displayed first, followed by the style files, song files and music database files.

Files must be located in the “User Files” folder in the USB flash memory. Files located outside of that folder will not be recognized.

- 3 Press the [EXECUTE] button. The display prompts you for confirmation.

You can cancel the load operation at this point by pressing the [-] button.

- 4 Press the [EXECUTE] button again, or the [+] button, and the load operation will begin.

NOTICE

- Once the load-in-progress message appears on the display the operation cannot be canceled. Never turn off the power or remove the USB flash memory during this operation.

- 5 A message will appear on the display to inform you that the operation has finished.

Press the [EXIT] button to return to the MAIN display.

Deleting Data from a USB Flash Memory

This procedure deletes User, Style and Music Database files and Song files that were created on this instrument from a USB flash memory.

- 1 Use the CATEGORY [◀] and [▶] buttons to locate the USB Delete item.

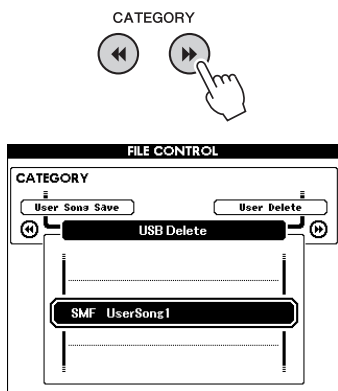

- 2 Use the dial to select the file you want to delete.

All User files in the USB flash memory will be displayed first, followed by the style files, song files and music database files.

Files must be located in the “User Files” folder in the USB flash memory. Files located outside of that folder will not be recognized.

- 3 Press the [EXECUTE] button. The display prompts you for confirmation.

You can cancel the delete operation at this point by pressing the [-] button.

- 4 Press the [EXECUTE] button again, or the [+] button, and the delete operation will begin.

NOTICE

- Once the delete-in-progress message appears on the display the operation cannot be canceled. Never turn off the power or remove the USB flash memory during this operation.

- 5 A message will appear on the display to inform you that the operation has finished.

Press the [EXIT] button to return to the MAIN display.

Delete User Data from the Instrument

This procedure deletes the User Song as well as Style, Song, and Music Database files transferred from an external device such as a computer. This operation does not erase the preset data.

- 1 Use the CATEGORY [◀] and [▶] buttons to locate the User Delete item.

Only “User Delete” can be selected if no USB flash memory is connected to the instrument.

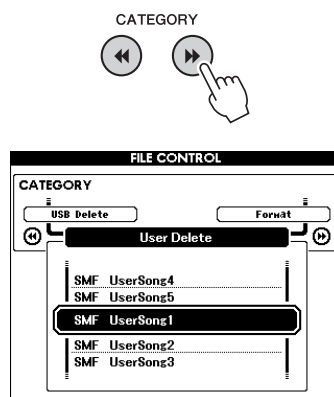

- 2 Use the dial to select the file you want to delete.

All user songs will be displayed first, followed by the song, style and music database files.

- 3 Press the [EXECUTE] button. The display prompts you for confirmation.

You can cancel the delete operation at this point by pressing the [-] button.

- 4 Press the [EXECUTE] button again, or the [+] button, and the delete operation will begin.

NOTICE

- Once the delete-in-progress message appears on the display the operation cannot be canceled.

- 5 A message will appear on the display to inform you that the operation has finished.

Press the [EXIT] button to return to the MAIN display.

Connecting to a Computer

This instrument can be connected to a computer to allow transfer of MIDI data or a file.

Connecting a Personal Computer

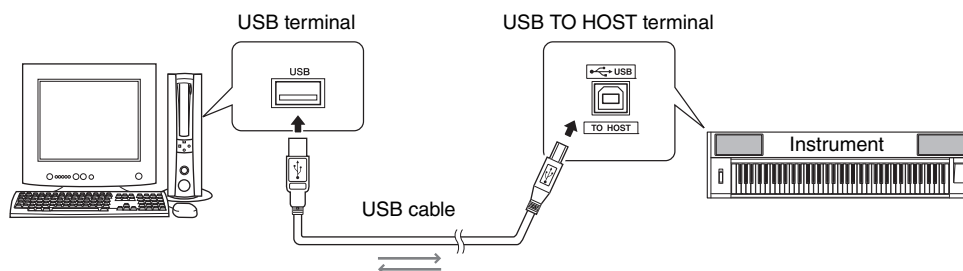

MIDI Basics

If you want to know more about MIDI and how to use it, refer to this introductory book. MIDI Basics is available for downloading from the Yamaha Manual Library at:
<http://www.yamaha.co.jp/manual/>

In order to be able to communicate with and use instruments connected to your computer, the appropriate driver software must be properly installed on your computer. The USB-MIDI driver allows sequence software and similar applications on your computer to transmit and receive MIDI data to and from MIDI devices via a USB cable. The USB-MIDI driver is included on the CD-ROM. Installation of the USB-MIDI driver is described on page 104.

CAUTION

- **Connect the instrument to external equipment only after turning off power for all devices. Then, turn on the power, first to the instrument, then to the connected external equipment. Reverse this order when you turn the power off.**

Precautions when using the USB TO HOST terminal

When connecting the computer to the USB TO HOST terminal, make sure to observe the following points. Failing to do so risks freezing the computer and corrupting or losing the data. If the computer or the instrument freezes, restart the application software or the computer OS, or turn the power to the instrument off then on again.

- Use an AB type USB cable of less than about 3 meters.
- Before connecting the computer to the USB TO HOST terminal, exit from any power-saving mode of the computer (such as suspended, sleep, standby).
- Before turning on the power to the instrument, connect the computer to the USB TO HOST terminal.
- Execute the following before turning the power to the instrument on/off or plugging/unplugging the USB cable to/from the [USB TO HOST] terminal.
 - Quit any open application software on the computer.
 - Make sure that data is not being transmitted from the instrument. (Data is transmitted whenever you play on the keyboard or play back a song, etc.)
- While the computer is connected to the instrument, you should wait for six seconds or more between these operations: (1) when turning the power of the instrument off then on again, or (2) when alternately connecting/disconnecting the USB cable.

Transferring Performance Data to and from a Computer

By connecting the instrument to a computer, the instrument's performance data can be used on the computer, and performance data from the computer can be played on the instrument.

MIDI settings

These settings pertain to performance data transmission and reception.

Item	Range/Settings	Description
Local	ON/OFF	Local control determines whether or not notes played on the instrument are sounded by its internal tone generator system: the internal tone generator is active when local control is on, and inactive when local control is off.
External Clock	ON/OFF	These settings determine whether the instrument is synchronized to its own internal clock (OFF), or to a clock signal from an external device (ON).
Keyboard Out	ON/OFF	These settings determine whether keyboard performance data of the instrument is transmitted (ON) or not (OFF).
Style Out	ON/OFF	These settings determine whether Style data is transmitted (ON) or not (OFF) during Style playback.
Song Out	ON/OFF	These settings determine whether User Song is transmitted (ON) or not (OFF) during Song playback.

If you can't get any sound out of the instrument, this most likely may be caused by Local Control being set to off.

If External Clock is ON and no clock signal is being received from an external device, the song, style, and metronome functions will not start.

1 Press the [FUNCTION] button.

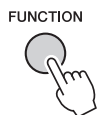

2 Use the CATEGORY [◀] and [▶] buttons to select the item you want to change its value.

3 Use the dial to select ON or OFF.

PC Mode

A number of MIDI settings need to be made when you want to transfer performance data between the computer and the instrument. The PC Mode item can conveniently make multiple settings for you in one operation. Three settings are available: PC1, PC2, and OFF.

This setting is not necessary when transferring song or backup files between the computer and the instrument.

* Set the PC mode to PC2 when using Digital Music Notebook.

	PC1	PC2*	OFF
Local	OFF	OFF	ON
External Clock	ON	OFF	OFF
Song Out	OFF	OFF	OFF
Style Out	OFF	OFF	OFF
Keyboard Out	OFF	ON	ON

1 Press the [FUNCTION] button.

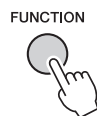

2 Press the CATEGORY [◀] and [▶] buttons as many times as necessary to select the PC mode item.

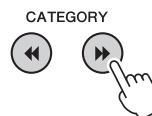

3 Use the dial to select PC1, PC2, or OFF.

NOTE

- Preset Song data cannot be transmitted from the instrument by the Song Out function, but User Songs can be.

Initial Send

This function lets you send the panel setup data to a computer. Before you record performance data to a sequencer application running on your computer, it is a good idea to first send and record the panel setup data before the actual performance data.

1 Press the [FUNCTION] button.

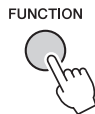

2 Use the CATEGORY [◀] and [▶] buttons to select the Initial Send item.

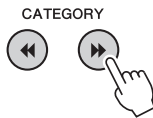

3 Press [+ / YES] to send, or press [- / NO] to cancel.

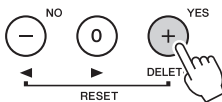

Transferring Data Between the Computer and Instrument

Songs, styles, or Music Database files residing on a computer or the supplied CD-ROM, can be transferred to the instrument. Backup file can also be transferred from the instrument to the computer and back. In order to transfer files between your computer and the instrument you will need to install the Musicsoft Downloader application and the USB-MIDI Driver included on the Accessory CD-ROM on your computer. Refer to the Accessory CD-ROM Installation Guide on page 102 for installation details.

Data that can be transferred from a computer to this instrument.

Data Capacity: 1895KB

502 files total for the Song, Style and Music Database.

Data Format

Song: .mid SMF format 0/1

Style: .sty

Music Database: .mfd

Backup File: 10PG88G.bup

What is SMF (Standard MIDI File)?

The SMF (Standard MIDI File) format is one of the most common and widely compatible sequence formats used for storing sequence data. There are two variations: Format 0 and Format 1. A large number of MIDI devices are compatible with SMF Format 0, and most commercially available MIDI sequence data is provided in SMF Format 0.

With the Musicsoft Downloader You Can.

- Transfer files from the computer to the instrument's flash memory.
→ refer to the procedure described on page 100.
The procedure for transferring songs included on the Accessory CD-ROM from your computer to the instrument is given as an example.
- Backup file can be transferred from the instrument to a computer and back.
→ refer to the procedure described on page 101.

* Use the Musicsoft Downloader application with Internet Explorer 5.5 or higher.

Use Musicsoft Downloader To Transfer Songs From the Accessory CD-ROM To the Instrument's flash memory

NOTE

- If a song or style is being played, stop playback before proceeding.

1 Install the Musicsoft Downloader and USB-MIDI driver to your computer, then connect the computer and the instrument (page 104).

2 Insert the included CD-ROM into the CD-ROM drive.

3 Double-click the Musicsoft Downloader shortcut icon that is created on the desktop.

This will launch the Musicsoft Downloader application and the main window will appear.

NOTE

- The instrument cannot be operated while the Musicsoft Downloader is running.

4 Click the “Add File” button and the Add File window will appear.

5 Click the button to the right of “Look in” and select the CD-ROM drive from the drop-down menu that appears. Double-click the “SampleData” Folder on the window. Select the file from the “SongData” Folder you want to transfer to the instrument, and click “Open”.

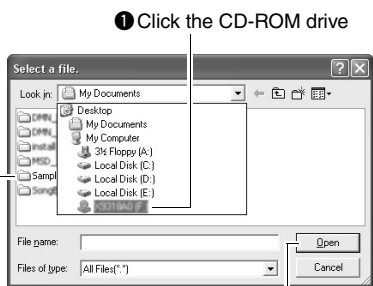

- 2** Double-click “SampleData” Folder → “SongData” Folder, and click a song file.
- 3** Click “Open”

At this point you can select a Style or Music Database file on the computer or CD-ROM and transfer it to the instrument in the same way as a song file.

6 A copy of the selected MIDI song file will appear in the “List of files stored temporarily” at the top of the window. The memory medium will also be displayed at the bottom of the window to specify the destination for the transfer. Click “Instrument”, and then “Flash memory”.

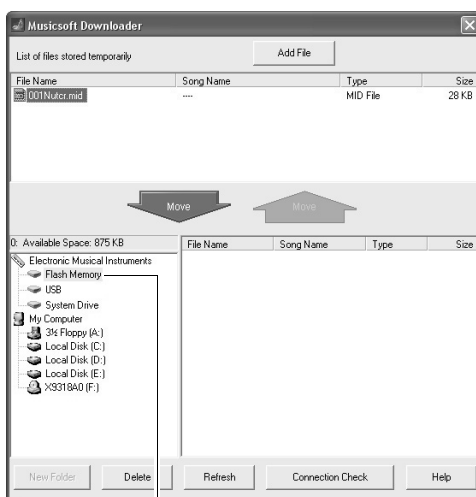

- 1** Click the “Electronic Musical Instruments,” and then “Flash Memory”

7 After selecting the file in the “List of files stored temporarily”, click the downward [Move] button and a confirmation message will appear. Click [OK] and the song will be transferred from the “List of files stored temporarily” to the instrument’s memory.

NOTE

- Files transferred to a USB flash memory root directory using the Musicsoft Downloader—any location outside the USER FILES folder on the USB flash memory device—cannot be deleted via the instrument’s file control display. Use the Musicsoft Downloader delete button to delete such files.

8 Close the window to end the Musicsoft Downloader.

NOTE 4

- End the Musicsoft Downloader to playback the file transferred from your computer.

9 To playback a song stored in flash memory, press the [SONG] button. Use the dial to select the song you want to play, then press the [START/STOP] button to start playback.

NOTICE

- Do not unplug the USB cable during a data transfer. Not only will the data not be transferred and saved, but operation of the memory media may become unstable and its contents may disappear completely when the power is turned on or off.

NOTICE

- Store data can be lost due to equipment malfunction or improper operation. For safety we recommend that you keep a copy of all important data stored on your computer.

To Use transferred Songs For Lessons...

When using songs (only SMF format 0 and 1) transferred from a computer for lessons you can specify which channels are to be played back as the right-hand and left-hand parts.

- 1 Press the [SONG] button and select the song (036–) residing in flash memory for which you want to set the guide track.
- 2 Press the [FUNCTION] button.
- 3 Use the CATEGORY [◀◀] and [▶▶] buttons to select the R-Part or L-Part item.
- 4 Use the dial to select the channel you want to play back as the specified right- or left-hand part.

The default settings are channel 1 for the right-hand part and channel 2 for the left-hand part.

Transfer a Backup file from the instrument to a computer

You can use the Musicsoft Downloader to transfer “Backup” files containing Registration Memory and FUNCTION settings to a computer. If you click “Electronic Musical Instruments” in the Musicsoft Downloader display, and then “System Drive”, a file named “10PG88G.bup” will appear in the lower right corner of the Musicsoft Downloader display. This is the backup file. For details about how to transfer backup files using the Musicsoft Downloader application, refer to the Online help “Transferring Data Between the Computer and Instrument (for unprotected data)” in the application.

NOTICE

- The backup file is transmitted/received as a single file. As a result, all registration memory data will be overwritten every time you transmit or receive. Keep this in mind when transferring data.

NOTICE

- Do not rename the backup file on the computer. If you do so it will not be recognized when transferred to the instrument.

Accessory CD-ROM Installation Guide

SPECIAL NOTICES

- The software and this manual are the exclusive copyrights of Yamaha Corporation.
- Use of the software and this manual is governed by the license agreement which the purchaser fully agrees to upon breaking the seal of the software packaging. (Please read carefully the Software Licensing Agreement on page 108 before installing the application.)
- Copying of the software or reproduction of this manual in whole or in part by any means is expressly forbidden without the written consent of the manufacturer.
- Yamaha makes no representations or warranties with regard to the use of the software and documentation and cannot be held responsible for the results of the use of this manual and the software.
- This disk containing the software is not meant for use with an audio/visual system (CD player, DVD player, etc.). Do not attempt to use the disk on equipment other than a computer.
- The screen displays as illustrated in this manual are for instructional purposes, and may appear somewhat different from the screens which appear on your computer.
- Software such as the USB-MIDI driver may be revised and updated without prior notice. Make sure to check and download the latest version of the software from the following site.
<http://music.yamaha.com/download/>
- Future upgrades of application and system software and any changes in specifications and functions will be announced separately.

Important Notices about the CD-ROM

Data Types

This CD-ROM includes application software. Please refer to page 104 for software installation instructions.

CAUTION

- *Do not attempt to play this CD-ROM on equipment other than a computer. The result high-volume noise can potentially cause hearing damage or damage your equipment.*

Operating System (OS)

The applications in this CD-ROM are provided in versions for Windows operating systems.

CD-ROM Contents

When the included CD-ROM is inserted into the CD-ROM drive, the following start window will appear automatically. (If the start window does not appear automatically, open the “My computer” folder and double click “Start.exe” in the CD-ROM drive.)



Folder Name		Application / Data Name	Contents
1	MSD_	Musicsoft Downloader	This application can be used to download MIDI song data from the Internet and transfer it from the computer to the instrument's memory. Refer to page 104 for installation instructions.
2	USBdrv32_	USB-MIDI Driver (for 32-bit version Windows 2000/XP/Vista/7)	This driver software is necessary to connect MIDI devices to your computer via USB. Refer to page 104 for installation instructions.
	USBdrv64_	USB-MIDI Driver (for 64-bit version Windows XP/Vista/7)	
3	SongBook	Song Book	Includes score data for the 30 internal songs provided on the instrument as well as 70 MIDI songs provided on the CD-ROM. The exceptions are songs 1–11 and 30. The scores for songs 9–11 are provided in the separate Data List.
	SampleData	SongData	These songs, styles, or data can be transferred to the instrument and played or used with the instrument's functions.
		StyleData	
		MDB	

In order to view PDF scores, you will need to install Adobe Reader in your computer. Adobe Reader can be downloaded free at the Adobe website.

System Requirements

Data	OS	Computer	Memory	Hard Disk	Display
Musicsoft Downloader	Windows 2000/XP Home Edition/XP Professional/Vista * Only 32-bit is supported. Windows 7	233 MHz or higher; Intel Pentium/Celeron Processor family (500 MHz or higher is recommended)	64 MB or more (256 MB or more is recommended)	128 MB or more (at least 512 MB of free space is recommended)	800 x 600 HighColor (16-bit)
USB Driver for Windows	Windows XP Professional (SP2/SP3)/XP Home Edition (SP2/SP3)/2000 (SP4)	166 MHz or higher; Intel Core/Pentium/Celeron processor	32 MB or more (64 MB or more is recommended)	10 MB or more	—
	Windows XP Professional x64 Edition (SP2)	Intel 64 compatible processor	256 MB or more	10 MB or more	—
	Windows Vista (SP0/SP1/SP2)	800 MHz or higher; Intel Core/Pentium/Celeron processor or Intel 64 compatible processor	512 MB or more	10 MB or more	—
	Windows 7	1.4 GHz or higher; Intel Core/Pentium/Celeron processor or Intel 64 compatible processor	1 GB or more (32-bit)/2 GB or more (64-bit)	10 MB or more	—

Software Installation

If you have any problems with the installation, refer to the troubleshooting section on page 106.

NOTE

- The example displays shown in this guide are in English.

Installing / Updating the USB-MIDI Driver

In order to be able to communicate with and use MIDI instruments connected to your computer, the appropriate driver software must be properly installed on your computer.

The USB-MIDI driver allows sequence software and similar applications on your computer to transmit and receive MIDI data to and from instruments via a USB cable.

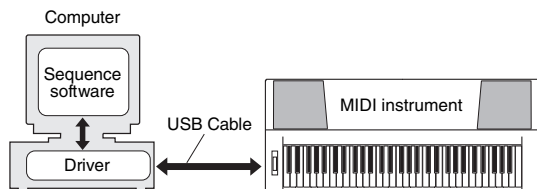

Follow the steps below to install (or update) the USB-MIDI driver.

- 1 Disconnect all USB devices from the computer except for the mouse and computer keyboard.**

- 2 Start the computer and use the “Administrator” account to log on to Windows.**

Close all applications and windows that are open.

- 3 Insert the Accessory CD-ROM into your computer’s CD-ROM drive.**

- 4 Turn off the power of the instrument.**

- 5 Connect the USB connector of the computer to the USB TO HOST terminal of the MIDI instrument with a standard USB cable.**

NOTE

- Do not use a USB hub for connecting multiple USB devices.

NOTE

- If you are using several MIDI instruments with USB connection at the same time, connect all the instruments to the computer and turn on the power for all of them, then perform the following installation procedure.

- 6 Turn on the power of the instrument(s).**

- 7 When the “Found New Hardware Wizard” window appears, click [Cancel].**

NOTE

- On some computers, it may take a few minutes before this screen appears.

NOTE

- This screen will not appear on Windows 7. When the message “Device driver software was not successfully installed” appears, continue the installation procedure.

NOTE

- This screen will not appear if you are updating the USB-MIDI driver from the previous version. Continue the installation procedure.

8 Open the following folder from the CD-ROM drive in your “My Computer” folder, and double click “setup.exe.”

- For users of 32 bit version Windows 2000/XP/Vista/7: “USBdrv32_”
- For users of 64 bit version Windows XP/Vista/7: “USBdrv64_”
- * Select [Start] menu → [Control Panel] → [System] to check the system. (Windows XP: “x64 Edition” appears on the 64 bit version, and does not appear on the 32 bit version.)

9 When the “File Download” window appears, click [Run] or [Open].

The “Preparing to install” window appears. The next window will appear after finishing this preparation.

NOTE

- The messages that appear in this window may differ somewhat depending on your browser.

NOTE

- (Windows XP) If the “Security Warning” window appears, click [Run].

NOTE

- (Windows Vista/7) If the “User Account Control” window appears, click [Continue] or [Yes].

10 When the “Welcome to the InstallShield Wizard for Yamaha USB-MIDI Driver” window appears, click [Next].

If the warning message below appears during the installation, click [Yes], [Continue Anyway], or [Install].

Windows 2000

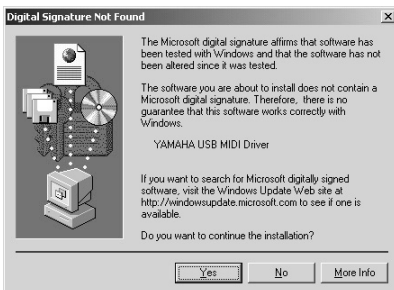

Windows XP



Windows Vista/7

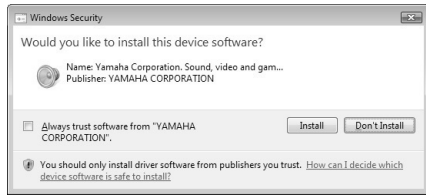

11 When a message appears indicating that the driver has been successfully installed, click [Finish].

NOTE

- On some computers, it may take a few minutes before this screen appears.

12 When a window appears prompting you to restart the computer, do so.

Restart the computer by following the on-screen directions.

NOTE

- This display will not appear when using Windows XP x64/Vista/7. No restart is necessary.

Checking the version of the driver

Open the “Control Panel” and double-click the “Yamaha USB-MIDI Driver” icon.

A window appears and the driver version is indicated in the lower left of the window.

NOTE

- When using Windows XP x64/Vista/7, double-click the “Yamaha USB-MIDI Driver (WDM)” icon.

Installing the Musicsoft Downloader

IMPORTANT

- You will need to log on with administrator (root) privileges in order to install Musicsoft Downloader on a computer running Windows 2000, XP, Vista or 7.

1 Insert the Accessory CD-ROM into your computer's CD-ROM drive.

The start window will appear automatically showing software applications.

NOTE

- If the start window does not appear automatically, open the "My Computer" folder and double click "Start.exe" in the CD-ROM drive. Then, proceed to step 2 below.

2 Click [Musicsoft Downloader].

3 Click the [Install] button, and follow the on-screen instructions to install the software.

For Musicsoft Downloader operating instructions see the Help menu: launch the Musicsoft Downloader application and click "Help".

- * You can obtain the latest version of the Musicsoft Downloader at the following web site.
<http://music.yamaha.com/download/>

IMPORTANT

- Only Musicsoft Downloader can be used to transfer files between this instrument and a computer. No other file transfer application can be used.

Troubleshooting

The driver cannot be installed.

- **Is the USB cable connected correctly?**
Check the USB cable connection. Disconnect the USB cable, then connect it again.
- **Is the USB function enabled on your computer?**
When you connect the instrument to the computer for the first time, if the "Add (Found) New Hardware Wizard" or the "Found New Hardware" window does not appear, the USB function on the computer may be disabled. Perform the following steps.
 - 1 Select [Control Panel]* → [System] → [Hardware] → [Device Manager] (for Windows 2000/XP), or select [Control Panel] → [Device Manager] (for Windows Vista/7).**
* Classic View only in Windows XP.
 - 2 Make sure that no "!" or "x" marks appear at "Universal serial bus controller" or "USB Root Hub". If you see an "!" or "x" mark, the USB controller is disabled.**
- **Is any unknown device registered?**
If driver installation fails, the instrument will be marked as an "Unknown device", and you will not be able to install the driver. Delete the "Unknown device" by following the steps below.
 - 1 Select [Control Panel]* → [System] → [Hardware] → [Device Manager] (for Windows 2000/XP), or select [Control Panel] → [Device Manager] (for Windows Vista/7).**
* Classic View only in Windows XP.
 - 2 Look for "Other devices" in the menu "View devices by type".**
 - 3 If you find "Other devices", double-click it to extend the tree to look for "Unknown device". If one appears, select it and click the [Remove] button.**
 - 4 Remove the USB cable from the instrument, and make the connection again.**
 - 5 Install the driver again. (pages 104–105)**

When controlling the instrument from your computer via USB, the instrument does not operate correctly or no sound is heard.

- Did you install the driver? (page 104)
- Is the USB cable connected correctly?
- Are the volume settings of the instrument, playback device, and application program set to the appropriate levels?
- Have you selected an appropriate port in the sequence software?
- Are you using the latest USB MIDI driver? The latest driver can be downloaded from the following web site.

<http://music.yamaha.com/download/>

Playback response is delayed.

- Does your computer satisfy the system requirements?
- Is any other application or device driver running?

Cannot suspend or resume the computer correctly.

- **Do not suspend the computer while the MIDI application is running.**
If you are using Windows 2000, you may not be able to suspend/resume normally, depending on the particular environment (USB Host Controller, etc.). Even so, simply disconnecting and connecting the USB cable will allow you to use the instrument functions again.

How can I remove the software?

[Windows 2000/XP]

- 1 Disconnect all USB devices from the computer except for the mouse and keyboard.**
- 2 Start the computer and log on to the Administrator account.**
Exit from any open applications and close all open windows.
- 3 From the [Start] menu, select ([Settings] → [Control Panel] → [Add or Remove Programs]) to display the Add or Remove Programs panel.**
- 4 Click “Change or Remove Programs” located in the upper left, then select “Yamaha USB-MIDI Driver” or “Yamaha Musicsoft Downloader” from the list in the right panel.**
- 5 Click [Remove].**
A dialog box appears. Follow the instructions to remove the software.

[Windows Vista/7]

- 1 Disconnect all USB devices from the computer except for the mouse and keyboard.**
- 2 Start the computer and log on to the Administrator account.**
Exit from any open applications and close all open windows.
- 3 From the [Start] menu, select the [Control Panel] → [Programs and Features] or [Uninstall a program] to display the “Uninstall or change a program” window.**
- 4 Select “Yamaha USB-MIDI Driver” or “Yamaha Musicsoft Downloader” from the list.**
- 5 Click [Uninstall].**
If the “User Account Control” window appears, click [Allow] or [Continue].
A dialog box appears. Follow the instructions to remove the software.

ATTENTION SOFTWARE LICENSE AGREEMENT

PLEASE READ THIS SOFTWARE LICENSE AGREEMENT ("AGREEMENT") CAREFULLY BEFORE USING THIS SOFTWARE. YOU ARE ONLY PERMITTED TO USE THIS SOFTWARE PURSUANT TO THE TERMS AND CONDITIONS OF THIS AGREEMENT. THIS AGREEMENT IS BETWEEN YOU (AS AN INDIVIDUAL OR LEGAL ENTITY) AND YAMAHA CORPORATION ("YAMAHA").

BY BREAKING THE SEAL OF THIS PACKAGE YOU ARE AGREEING TO BE BOUND BY THE TERMS OF THIS LICENSE. IF YOU DO NOT AGREE WITH THE TERMS, DO NOT INSTALL, COPY, OR OTHERWISE USE THIS SOFTWARE.

1. GRANT OF LICENSE AND COPYRIGHT

Yamaha hereby grants you the right to use one copy of the software program(s) and data ("SOFTWARE") accompanying this Agreement. The term SOFTWARE shall encompass any updates to the accompanying software and data. The SOFTWARE is owned by Yamaha and/or Yamaha's licensor(s), and is protected by relevant copyright laws and all applicable treaty provisions. While you are entitled to claim ownership of the data created with the use of SOFTWARE, the SOFTWARE will continue to be protected under relevant copyrights.

- You may use the SOFTWARE on a single computer.
- You may make one copy of the SOFTWARE in machine-readable form for backup purposes only, if the SOFTWARE is on media where such backup copy is permitted. On the backup copy, you must reproduce Yamaha's copyright notice and any other proprietary legends that were on the original copy of the SOFTWARE.
- You may permanently transfer to a third party all your rights in the SOFTWARE, provided that you do not retain any copies and the recipient reads and agrees to the terms of this Agreement.

2. RESTRICTIONS

- You may not engage in reverse engineering, disassembly, decompilation or otherwise deriving a source code form of the SOFTWARE by any method whatsoever.
- You may not reproduce, modify, change, rent, lease, or distribute the SOFTWARE in whole or in part, or create derivative works of the SOFTWARE.
- You may not electronically transmit the SOFTWARE from one computer to another or share the SOFTWARE in a network with other computers.
- You may not use the SOFTWARE to distribute illegal data or data that violates public policy.
- You may not initiate services based on the use of the SOFTWARE without permission by Yamaha Corporation.

Copyrighted data, including but not limited to MIDI data for songs, obtained by means of the SOFTWARE, are subject to the following restrictions which you must observe.

- Data received by means of the SOFTWARE may not be used for any commercial purposes without permission of the copyright owner.
- Data received by means of the SOFTWARE may not be duplicated, transferred, or distributed, or played back or performed for listeners in public without permission of the copyright owner.
- The encryption of data received by means of the SOFTWARE may not be removed nor may the electronic watermark be modified without permission of the copyright owner.

3. TERMINATION

This Agreement becomes effective on the day that you receive the SOFTWARE and remains effective until terminated. If any copyright law or provisions of this Agreement is violated, the Agreement shall terminate automatically and immediately without notice from Yamaha. Upon such termination, you must immediately destroy the licensed SOFTWARE, any accompanying written documents and all copies thereof.

4. LIMITED WARRANTY ON MEDIA

As to SOFTWARE sold on tangible media, Yamaha warrants that the tangible media on which the SOFTWARE is recorded will be free from defects in materials and workmanship under normal use for a period of fourteen (14) days from the date of receipt, as evidenced by a copy of the receipt. Yamaha's entire liability and your exclusive remedy will be replacement of the defective media if it is returned to Yamaha or an authorized Yamaha dealer within fourteen days with a copy of the receipt. Yamaha is not responsible for replacing media damaged by accident, abuse or misapplication. TO THE FULLEST EXTENT PERMITTED BY LAW, YAMAHA EXPRESSLY DISCLAIMS ANY IMPLIED WARRANTIES ON THE TANGIBLE MEDIA, INCLUDING THE IMPLIED WARRANTIES OF MERCHANTABILITY AND FITNESS FOR A PARTICULAR PURPOSE.

5. DISCLAIMER OF WARRANTY ON SOFTWARE

You expressly acknowledge and agree that use of the SOFTWARE is at your sole risk. The SOFTWARE and related documentation are provided "AS IS" and without warranty of any kind. NOTWITHSTANDING ANY OTHER PROVISION OF THIS AGREEMENT, YAMAHA EXPRESSLY DISCLAIMS ALL WARRANTIES AS TO THE SOFTWARE, EXPRESS, AND IMPLIED, INCLUDING BUT NOT LIMITED TO THE IMPLIED WARRANTIES OF MERCHANTABILITY, FITNESS FOR A PARTICULAR PURPOSE AND NON-INFRINGEMENT OF THIRD PARTY RIGHTS. SPECIFICALLY, BUT WITHOUT LIMITING THE FOREGOING, YAMAHA DOES NOT WARRANT THAT THE SOFTWARE WILL MEET YOUR REQUIREMENTS, THAT THE OPERATION OF THE SOFTWARE WILL BE UNINTERRUPTED OR ERROR-FREE, OR THAT DEFECTS IN THE SOFTWARE WILL BE CORRECTED.

6. LIMITATION OF LIABILITY

YAMAHA'S ENTIRE OBLIGATION HEREUNDER SHALL BE TO PERMIT USE OF THE SOFTWARE UNDER THE TERMS HEREOF. IN NO EVENT SHALL YAMAHA BE LIABLE TO YOU OR ANY OTHER PERSON FOR ANY DAMAGES, INCLUDING, WITHOUT LIMITATION, ANY DIRECT, INDIRECT, INCIDENTAL OR CONSEQUENTIAL DAMAGES, EXPENSES, LOST PROFITS, LOST DATA OR OTHER DAMAGES ARISING OUT OF THE USE, MISUSE OR INABILITY TO USE THE SOFTWARE, EVEN IF YAMAHA OR AN AUTHORIZED DEALER HAS BEEN ADVISED OF THE POSSIBILITY OF SUCH DAMAGES. In no event shall Yamaha's total liability to you for all damages, losses and causes of action (whether in contract, tort or otherwise) exceed the amount paid for the SOFTWARE.

7. THIRD PARTY SOFTWARE

Third party software and data ("THIRD PARTY SOFTWARE") may be attached to the SOFTWARE. If, in the written materials or the electronic data accompanying the Software, Yamaha identifies any software and data as THIRD PARTY SOFTWARE, you acknowledge and agree that you must abide by the provisions of any Agreement provided with the THIRD PARTY SOFTWARE and that the party providing the THIRD PARTY SOFTWARE is responsible for any warranty or liability related to or arising from the THIRD PARTY SOFTWARE. Yamaha is not responsible in any way for the THIRD PARTY SOFTWARE or your use thereof.

- Yamaha provides no express warranties as to the THIRD PARTY SOFTWARE. IN ADDITION, YAMAHA EXPRESSLY DISCLAIMS ALL IMPLIED WARRANTIES, INCLUDING BUT NOT LIMITED TO THE IMPLIED WARRANTIES OF MERCHANTABILITY AND FITNESS FOR A PARTICULAR PURPOSE, as to the THIRD PARTY SOFTWARE.
- Yamaha shall not provide you with any service or maintenance as to the THIRD PARTY SOFTWARE.
- Yamaha is not liable to you or any other person for any damages, including, without limitation, any direct, indirect, incidental or consequential damages, expenses, lost profits, lost data or other damages arising out of the use, misuse or inability to use the THIRD PARTY SOFTWARE.

8. GENERAL

This Agreement shall be interpreted according to and governed by Japanese law without reference to principles of conflict of laws. Any dispute or procedure shall be heard before the Tokyo District Court in Japan. If for any reason a court of competent jurisdiction finds any portion of this Agreement to be unenforceable, the remainder of this Agreement shall continue in full force and effect.

9. COMPLETE AGREEMENT

This Agreement constitutes the entire agreement between the parties with respect to use of the SOFTWARE and any accompanying written materials and supersedes all prior or contemporaneous understandings or agreements, written or oral, regarding the subject matter of this Agreement. No amendment or revision of this Agreement will be binding unless in writing and signed by a fully authorized representative of Yamaha.

Troubleshooting

For the Instrument

Problem	Possible Cause and Solution
When the instrument is turned on or off, a popping sound is temporarily produced.	This is normal and indicates that the instrument is receiving electrical power.
When using a mobile phone, noise is produced.	Using a mobile phone in close proximity to the instrument may produce interference. To prevent this, turn off the mobile phone or use it further away from the instrument.
There is no sound even when the keyboard is played or when a song or style is being played back.	Check that nothing is connected to the PHONES/OUTPUT jack on the rear panel. When a set of headphones is plugged into this jack, no sound is output.
	Check the Local Control on/off. (See page 98.)
	Is the FILE CONTROL display showing? The instrument's keyboard, etc., will not produce any sound while the FILE CONTROL display is showing. Press the [EXIT] button to return to the MAIN display.
Playing keys in the right hand area of the keyboard does not produce any sound.	When using the Dictionary function (page 82), the keys in the right hand area are used only for entering the chord root and type.
The style or song does not play back when the [START/STOP] button is pressed.	Is External Clock set to ON? Make sure External Clock is set to OFF; refer to "External Clock" on page 98.
The style does not sound properly.	Make sure that the Style Volume (page 79) is set to an appropriate level.
	Is the split point set at an appropriate key for the chords you are playing? Set the split point at an appropriate key (page 80).
	Is the "ACMP" indicator showing in the display? If it is not showing press the [ACMP ON/OFF] button so that it does show.
No rhythm accompaniment plays when the [START/STOP] button is pressed after selecting style number 136 or a style between 148–165 (Pianist).	This is not a malfunction. Style number 136 and style numbers 148–165 (Pianist) have no rhythm parts, so no rhythm will play. The other parts will begin playing when you play a chord in the accompaniment range of the keyboard if style playback is turned on.
Not all of the voices seem to sound, or the sound seems to be cut off.	The instrument is polyphonic up to a maximum of 64 notes. If the Dual voice or Split voice is being used and a style or song is playing back at the same time, some notes/sounds may be omitted (or "stolen") from the accompaniment or song.
The footswitch (for sustain) seems to produce the opposite effect. For example, pressing the footswitch cuts off the sound and releasing it sustains the sounds.	The polarity of the footswitch is reversed. Make sure that the footswitch plug is properly connected to the SUSTAIN jack before turning on the power.
The sound of the voice changes from note to note.	This is normal. The AWM tone generation method uses multiple recordings (samples) of an instrument across the range of the keyboard; thus, the actual sound of the voice may be slightly different from note to note.
There are Japanese characters in the display messages.	Make sure the Language setting in the FUNCTION display is set to English. (See page 71)
The appropriate display does not appear when the [SONG], [EASY SONG ARRANGER], [STYLE], or [VOICE] button is pressed.	Is another display showing? Try pressing the [EXIT] button to return to the MAIN display, and then pressing one of the mentioned buttons.
The wrong notes sound when the keyboard is played.	Perhaps the performance assistant technology is turned on. Press the [P.A.T. ON/OFF] button to turn it off.
The ACMP indicator does not appear when the [ACMP ON/OFF] button is pressed.	Always press the [STYLE] button first when you are going to use any style-related function.
The "OverCurrent" message is shown in the upper area of the MAIN display and the USB device does not respond.	Communication with the USB device has been shut down because of the overcurrent to the USB device. Disconnect the device from the USB TO DEVICE terminal, then turn on the power of the instrument.

Messages

LCD Message	Comment
Access error!	Indicates the failure in reading or writing from/to the media or the flash memory.
All Memory Clearing...	Displayed while erasing all data in the flash memory. Never turn the power off during data transmission.
Are you sure?	Confirms whether Song Clear or Track Clear is executed or not.
Backup Clearing...	Displayed while clearing the back-up data in the flash memory.
Cancel	Displayed when the transmission of Initial Send is cancelled.
Can't clear TrackA.	Displayed when a track clear error occurs.
Clearing...	Displayed while executing Song Clear or Track Clear of the user songs.
Com Mode	Displayed when the Musicsoft Downloader is started on the PC connected to the keyboard. This will not be displayed while the instrument is played back.
Completed	Indicates the specified job completion such as data saving and transmission.
Create Directory	Displayed while creating a folder in the Musicsoft Downloader application.
Data Error!	Displayed when the user song contains illegal data.
Delete File	Displayed while deleting a file in the Musicsoft Downloader.
Delete OK ?	Confirms whether the Delete job is executed or not.
Delete Directory	Displayed while deleting a folder in the Musicsoft Downloader.
Deleting...	Displayed while the delete function is engaged.
End	Displayed when the transmission of Initial Send has been completed.
Error!	Displayed when writing has failed.
Exit.	Displayed when the record standby mode is exited because an inappropriate style has been selected during style record standby.
"File information area is not large enough."	Indicates that saving data in the media cannot be executed since the total number of files have become too many.
File is not found.	Indicates there is no file.
"File too large. Loading is impossible."	Indicates that loading data cannot be executed since the file data is too large.
Flash Clearing...	Displayed while clearing the song or style data transmitted to the internal flash memory.
Format OK ? [EXECUTE]	Confirms whether formatting the media is executed or not.
Formatting...	Displayed while formatting.
Load OK ?	Confirms whether loading is executed or not.
Loading...	Displayed while loading data.
Media is not inserted.	Displayed when accessing the media while it is not inserted.
Media capacity is full.	Displayed when saving data cannot be executed since the media memory becomes full.
Memory Full	Displayed when the internal memory becomes full during song recording.
"MIDI receive buffer overflow."	Displayed when too much MIDI data was received at one time and failed to proceed.
Move File	Displayed while moving a file in the Musicsoft Downloader.
"Now Writing... (Don't turn off the power now, otherwise the data may be damaged.)"	Displayed while writing data in the memory. Never turn the power off while writing. Doing so may result in data loss.
OverCurrent	Communication with the USB device has been shut down because of the overcurrent to the USB device. Disconnect the device from the USB TO DEVICE terminal, then turn on the power of the instrument.
Overwrite ?	Confirms whether overwriting is executed or not.
Please Wait...	Displayed when executing the jobs that take some time, such as displaying scores and lyrics, or stopping recording.
Rename File	Displayed while rewriting the file name in the Musicsoft Downloader.
Save OK ?	Confirms whether saving is executed or not.
Saved data is not found.	Displayed when the data to be saved doesn't exist.

LCD Message	Comment
Saving...	Displayed while saving data in the memory. Never turn the power off while saving. Doing so may result in data loss.
Send OK?	Confirms whether the data transmission is executed or not.
Sending...	Displayed while transmitting data.
"Since the media is in use now, this function is not available."	Indicates that the file control function is currently unavailable since the media is being accessed.
Style data is too large to load.	Indicates that style data cannot be loaded since the style data is too large.
Sure ? [YES/NO]	Reconfirms whether each operation is executed or not.
"The limit of the media has been reached."	Indicates that saving data cannot be executed since the folder/directory structure has become too complicated.
The media is not formatted.	Indicates the inserted media has not been formatted.
"The media is write-protected."	Indicates that the inserted media cannot be written since it is write-protected. Set to the write-protect switch to the "overwrite" position before use.
The notation cannot be displayed, since this song is not allowed to display the notation.	This message will appear if you attempt to display the score of a song for which score display is prohibited.
"The song data is too large to be converted to notation."	Indicates that the score cannot be displayed since the song data is too large.
There are too many files.	Indicates that saving data cannot be executed since the total number of files exceeds the capacity.
"This function is not available now."	Indicates the designated function is not available since the instrument is executing another job.
[nnn] "file name"	Indicates the file name of the currently transmitting. "nnn" indicates the receiving block.

NOTE

- Not all the messages are listed in the table: the messages necessary to be explained only.

Specifications

Keyboards

- 88 Graded Hammer Standard keys (A-1–C7), with Touch Response.

Display

- 320 x 240 dots LCD display (backlit)

Setup

- STANDBY/ON
- MASTER VOLUME: MIN–MAX
- LCD CONTRAST

Realtime Control

- Pitch Bend Wheel

Voice

- 142 panel voices + 12 drum/SFX kits + 381 XGlite voices
- Polyphony: 64
- DUAL
- SPLIT

Style

- 165 Preset Styles + External files
- Style Control: ACOMP ON/OFF, SYNC STOP, SYNC START, START/STOP, INTRO/ENDING/rit., MAIN/AUTO FILL
- Fingering: Multi Finger, Full Keyboard, AI Fingered
- Style Volume

Music Database

- 305 + External files

Education Feature

- Dictionary
- Lesson 1–3, Repeat & Learn

Registration Memory

- 8 banks x 4 types

Function

- VOLUME: Style Volume, Song Volume
- OVERALL: Tuning, Transpose, Split Point, Touch Sensitivity, Pitch Bend Range, Chord Fingering
- MAIN VOICE: Volume, Octave, Pan, Reverb Level, Chorus Level, DSP Level
- DUAL VOICE: Volume, Octave, Pan, Reverb Level, Chorus Level, DSP Level
- SPLIT VOICE: Volume, Octave, Pan, Reverb Level, Chorus Level
- EFFECT: Reverb Type, Chorus Type, DSP ON/OFF, DSP Type, Sustain, Master EQ Type
- HARMONY: Harmony Type, Harmony Volume
- Performance assistant technology: Performance assistant technology Type
- PC: PC Mode
- MIDI: Local On/Off, External Clock, Initial Send, Keyboard Out, Style Out, Song Out
- METRONOME: Time Signature Numerator, Time Signature Denominator, Metronome Volume, Bell Quantize
- SCORE:
- SONG/LESSON: Lesson Track (R), Lesson Track (L)
- LESSON: GRADE
- DEMO: Demo Cancel, DEMO GROUP, DEMO PLAY MODE
- LANGUAGE: English/Japanese

Effects

- Reverb: 35 types
- Chorus: 44 types
- DSP: 238 types
- Harmony: 26 types

Song

- 30 Preset Songs + 5 User Songs + Accessory CD-ROM Songs (70)
- Song Clear, Track Clear
- Song Volume
- Song Control: REPEAT & LEARN, A-B REPEAT, PAUSE, REW, FF, START/STOP

Performance assistant technology

- Chord, Chord/Free, Melody, Chord/Melody

Recording

- Song
- User Song: 5 Songs
- Recording Tracks: 1, 2, 3, 4, 5, STYLE

MIDI

- Local On/Off
- Initial Send
- External Clock
- Keyboard Out
- Style Out
- Song Out

Auxiliary jacks

- PHONES/OUTPUT, DC IN 12V, USB TO HOST, USB TO DEVICE, SUSTAIN, PEDAL UNIT

Amplifier

- 6W + 6W

Speakers

- 12cm x 2 + 3cm x 2

Power Supply

- Adaptor: Users within U.S or Europe: PA-150 or an equivalent recommended by Yamaha
Others: PA-5D, PA-150 or an equivalent

Dimensions (W x D x H)

- 1,397 x 445 x 146 mm (55" x 17-1/2" x 5-3/4") with keyboard stand:
1,399 x 445 x 761 mm (55-1/16" x 17-1/2" x 29-15/16")

Weight

- 20.7kg (45 lbs. 10 oz.) with keyboard stand: 27.7kg (61 lbs. 1 oz.)

Supplied Accessories

- Data List
- Music Rest
- Accessory CD-ROM
- Keyboard Stand
- Owner's Manual
- Footswitch
- My Yamaha Product User Registration
- * The PRODUCT ID on the sheet will be needed when you fill out the User Registration form.
- AC Power adaptor (PA-150 or an equivalent)
- * May not be included depending on your particular area.

Optional Accessories

- AC Power Adaptor: Users within U.S or Europe: PA-150 or an equivalent recommended by Yamaha
Others: PA-5D, PA-150 or an equivalent
- Headphones: HPE-150
- Pedal Unit: LP-7A
- Footswitch: FC4/5

* Specifications and descriptions in this owner's manual are for information purposes only. Yamaha Corp. reserves the right to change or modify products or specifications at any time without prior notice. Since specifications, equipment or options may not be the same in every locale, please check with your Yamaha dealer.

- A**
- A-B Repeat 84
 - Accessories 7
 - ACMP 25
 - AI Fingering 27, 81, 87
 - Auto Accompaniment Range .. 25
 - Auto-Accompaniment 25, 76
- B**
- Backup 64, 101
 - Bell 70
- C**
- Channel 101
 - Chord 26–27, 43, 82
 - Chord Dictionary 82
 - Chord Fingering 27, 81, 87
 - Chord type (performance assistant technology) 44
 - Chord/Free type (performance assistant technology) 46
 - Chord/Melody type (performance assistant technology) 50
 - Chorus 66
 - Chorus Level 72
 - Computer 97
- D**
- Default Setting 86
 - Delete (Songs transferred from a computer) 64
 - Delete (USB flash memory) 96
 - Delete (User Data) 96
 - Delete (User Song) 60
 - Demo 31
 - Demo Cancel 89
 - Demo Group 85
 - Demo Play Mode 85
 - Display 36–37
 - Double-Staff Score 32
 - Drum Kit 19
 - DSP 67
 - Dual Voice 20, 73
- E**
- Easy Chords 27
 - Easy Song Arranger 54
 - Effect 65
 - Ending 76
 - External Clock 98
- F**
- Fast-Forward (FF) 31
 - File Control 90
 - File Name 93
 - Fill 76
 - Flash Memory 29, 100
 - Footswitch 13
 - Format (File Control) 92
 - FullKeyboard 81, 87
 - Function 86
 - Function Display 36
- G**
- Grade 42
- H**
- Harmony 65
 - Harmony Volume 88
 - Headphones 13
- I**
- Initial Send 99
 - Initialization 64
 - Intro 76
- K**
- Keyboard Out 98
 - Keyboard Stand Assembly 10
- L**
- Language 71
 - Lesson 38
 - Load 95
 - Local 98
 - L-Part 101
 - Lyric 33
- M**
- Main (Section) 76
 - MAIN Display 36
 - Main Voice 18
 - Master EQ Type 69
 - Measure 37
 - Melody 32, 43
 - Melody score 32
 - Melody type (performance assistant technology) 48
 - Melody Voice 55, 84
 - Messages 110
 - Metronome 22, 70–71
 - MIDI 98
 - Multi Finger 81, 87
 - Music Database 53
 - Music Rest 7
 - Mute 84
- N**
- notation 32
- O**
- Octave 72
 - One Touch Setting 70
- P**
- P.A.T. Type 43
 - Pan 72
 - Panel Sustain 68
 - Part (Right, Left) 38
 - PC Mode 98
 - Pedal Unit 14
 - performance assistant technology 43
 - Pitch Bend 68
 - Pitch Bend Range 87
 - Power Adaptor 13
 - Preset Song 28
- Q**
- Quantize 88

R

Recording	56
Registration Memory	62
Repeat	42, 84
Reverb	66
Reverb Level	72
Rewind (REW)	31
R-Part	101

S

Save (User File)	93
Save (User Song)	94
Score	32
Section	76
Single-Staff Score	32
SMF (Standard MIDI File)	99
Song	28, 83
Song Clear	60
Song Out	98
Split Point	21, 80
Split Voice	21, 73
Style	24, 76
Style File	24
Style Out	98
Sustain (Footswitch)	13
Sustain (Panel)	68
Synchro Start	25, 77
Synchro Stop	78

T

Tempo (Metronome)	22
Tempo (Song)	83
Tempo (Style)	79
Time Signature (Denominator, Numerator)	23
Touch Response	75
Touch Sensitivity	75
Track	57
Track Clear	61
Transfer	98–99
Transpose	74
Troubleshooting	106, 109
Tuning	74

U

USB TO DEVICE	30, 90
USB TO HOST	97
USB-MIDI Driver	103–105
User file	93
User File Save	93
User Song	56

V

Voice	18, 72
Volume (Dual Voice)	72
Volume (Main Voice)	72
Volume (master)	15
Volume (Song)	83
Volume (Split Voice)	72
Volume (Style)	79

X

XF	6, 33
XGlite	6



LIMITED 3-YEAR WARRANTY ON DIGITAL PIANOS (DGX SERIES)

Thank you for selecting a Yamaha product. Yamaha products are designed and manufactured to provide a high level of defect-free performance. Yamaha Corporation of America ("Yamaha") is proud of the experience and craftsmanship that goes into each and every Yamaha product. Yamaha sells its products through a network of reputable, specially authorized dealers and is pleased to offer you, the Original Owner, the following Limited Warranty, which applies only to products that have been (1) directly purchased from Yamaha's authorized dealers in the fifty states of the USA and District of Columbia (the "Warranted Area") and (2) used exclusively in the Warranted Area. Yamaha suggests that you read the Limited Warranty thoroughly, and invites you to contact your authorized Yamaha dealer or Yamaha Customer Service if you have any questions.

Coverage: Yamaha will, at its option, repair or replace the product covered by this warranty if it becomes defective, malfunctions or otherwise fails to conform with this warranty under normal use and service during the term of this warranty, without charge for labor or materials. Repairs may be performed using new or refurbished parts that meet or exceed Yamaha specifications for new parts. If Yamaha elects to replace the product, the replacement may be a reconditioned unit. You will be responsible for any installation or removal charges and for any initial shipping charges if the product(s) must be shipped for warranty service. However, Yamaha will pay the return shipping charges to any destination within the USA if the repairs are covered by the warranty. This warranty does not cover (a) damage, deterioration or malfunction resulting from accident, negligence, misuse, abuse, improper installation or operation or failure to follow instructions according to the Owner's Manual for this product; any shipment of the product (claims must be presented to the carrier); repair or attempted repair by anyone other than Yamaha or an authorized Yamaha Service Center; (b) any unit which has been altered or on which the serial number has been defaced, modified or removed; (c) normal wear and any periodic maintenance; (d) deterioration due to perspiration, corrosive atmosphere or other external causes such as extremes in temperature or humidity; (e) damages attributable to power line surge or related electrical abnormalities, lightning damage or acts of God; or (f) RFI/EMI (Interference/noise) caused by improper grounding or the improper use of either certified or uncertified equipment, if applicable. Any evidence of alteration, erasing or forgery of proof-of-purchase documents will cause this warranty to be void. This warranty covers only the Original Owner and is not transferable.

In Order to Obtain Warranty Service: Warranty service will only be provided for defective products within the Warranted Area. Contact your local authorized Yamaha dealer who will advise you of the procedures to be followed. If this is not successful, contact Yamaha at the address, telephone number or website shown below. Yamaha may request that you send the defective product to a local authorized Yamaha Servicer or authorize return of the defective product to Yamaha for repair. If you are uncertain as to whether a dealer has been authorized by Yamaha, please contact Yamaha's Service Department at the number shown below, or check Yamaha's website at www.Yamaha.com. Product(s) shipped for service should be packed securely and must be accompanied by a detailed explanation of the problem(s) requiring service, together with the original or a machine reproduction of the bill of sale or other dated, proof-of-purchase document describing the product, as evidence of warranty coverage. Should any product submitted for warranty service be found ineligible therefore, an estimate of repair cost will be furnished and the repair will be accomplished only if requested by you and upon receipt of payment or acceptable arrangement for payment.

Limitation of Implied Warranties and Exclusion of Damages: ANY IMPLIED WARRANTIES, INCLUDING WARRANTIES OF MERCHANTABILITY AND FITNESS FOR A PARTICULAR PURPOSE SHALL BE LIMITED IN DURATION TO THE APPLICABLE PERIOD OF TIME SET FORTH ABOVE. YAMAHA SHALL NOT BE RESPONSIBLE FOR INCIDENTAL OR CONSEQUENTIAL DAMAGES OR FOR DAMAGES BASED UPON INCONVENIENCE, LOSS OF USE, DAMAGE TO ANY OTHER EQUIPMENT OR OTHER ITEMS AT THE SITE OF USE OR INTERRUPTION OF PERFORMANCES OR ANY CONSEQUENCES. YAMAHA'S LIABILITY FOR ANY DEFECTIVE PRODUCT IS LIMITED TO REPAIR OR REPLACEMENT OF THE PRODUCT, AT YAMAHA'S OPTION. SOME STATES DO NOT ALLOW LIMITATIONS ON HOW LONG AN IMPLIED WARRANTY LASTS OR THE EXCLUSION OR LIMITATION OF INCIDENTAL OR CONSEQUENTIAL DAMAGES, SO THE ABOVE LIMITATION OR EXCLUSION MAY NOT APPLY TO YOU. This Warranty gives you specific legal rights, and you may also have other rights which vary from state to state. This is the only express warranty applicable to the product specified herein; Yamaha neither assumes nor authorizes anyone to assume for it any other express warranty.

If you have any questions about service received or if you need assistance in locating an authorized Yamaha Servicer, please contact:



CUSTOMER SERVICE
Yamaha Corporation of America
6600 Orangethorpe Avenue, Buena Park, California 90620-1373
Telephone: 800-854-1569
www.yamaha.com

Do not return any product to the above address without a written Return Authorization issued by YAMAHA.

©2009 Yamaha Corporation of America. Effective: 11/01/09

Important Notice: Guarantee Information for customers in European Economic Area (EEA) and Switzerland

English	Important Notice: Guarantee Information for customers in EEA* and Switzerland For detailed guarantee information about this Yamaha product, and Pan-EEA* and Switzerland warranty service, please either visit the website address below (Printable file is available at our website) or contact the Yamaha representative office for your country. (next page). * EEA: European Economic Area
Deutsch	Wichtiger Hinweis: Garantie-Information für Kunden in der EWR* und der Schweiz Für nähere Garantie-Information über dieses Produkt von Yamaha, sowie über den Pan-EEA*- und Schweizer Garantieservice, besuchen Sie bitte entweder die folgende angegebene Internetadresse (eine druckfähige Version befindet sich auch auf unserer Webseite), oder wenden Sie sich an den für Ihr Land zuständigen Yamaha-Vertrieb (nächste Seite). *EWR: Europäischer Wirtschaftsraum
Français	Remarque importante: informations de garantie pour les clients de l'EEE et la Suisse Pour des informations plus détaillées sur la garantie de ce produit Yamaha et sur le service de garantie applicable dans l'ensemble de l'EEE ainsi qu'en Suisse, consultez notre site Web à l'adresse ci-dessous (le fichier imprimable est disponible sur notre site Web) ou contactez directement Yamaha dans votre pays de résidence (page suivante). * EEE : Espace Economique Européen
Nederlands	Belangrijke mededeling: Garantie-informatie voor klanten in de EER* en Zwitserland Voor gedetailleerde garantie-informatie over dit Yamaha-product en de garantieservice in heel de EER* en Zwitserland, gaat u naar de onderstaande website (u vindt een afprintbaar bestand op onze website) of neemt u contact op met de vertegenwoordiging van Yamaha in uw land (volgende pagina). * EER: Europese Economische Ruimte
Español	Aviso importante: información sobre la garantía para los clientes del EEE* y Suiza Para una información detallada sobre este producto Yamaha y sobre el soporte de garantía en la zona EEE* y Suiza, visite la dirección web que se incluye más abajo (la versión del archivo para imprimir está disponible en nuestro sitio web) o póngase en contacto con el representante de Yamaha en su país (página siguiente). * EEE: Área Económica Europea
Italiano	Aviso importante: informazioni sulla garanzia per i clienti residenti nell'EEA* e in Svizzera Per informazioni dettagliate sulla garanzia relativa a questo prodotto Yamaha e l'assistenza in garanzia nei paesi EEA* e in Svizzera, potete consultare il sito Web all'indirizzo riportato di seguito (è disponibile il file in formato stampabile) oppure contattate l'ufficio di rappresentanza locale della Yamaha (pagina seguente). * EEA: Area Economica Europea
Português	Aviso importante: informações sobre as garantias para clientes da AEE* e da Suíça Para obter uma informação pormenorizada sobre este produto da Yamaha e sobre o serviço de garantia na AEE* e na Suíça, visite o site a seguir (o arquivo para impressão está disponível no nosso site) ou entre em contato com o escritório de representação da Yamaha no seu país (próxima página). * AEE: Área Económica Europeia
Ελληνικά	Σημαντική σημείωση: Πληροφορίες εγγύησης για τους πελάτες στον ΕΟΧ* και Αλγερία Για λεπτομερείς πληροφορίες εγγύησης σχετικά με το παρόν προϊόν της Yamaha και την κάλυψη εγγύησης σε όλη τις χώρες του ΕΟΧ* και την Αλγερία, επισκεφτείτε την παρακάτω ιστοσελίδα (ετυπωσιμότητα μπορεί είναι διαθέσιμη στην ιστοσελίδα μας) ή απευθυνθείτε στην αντιπροσωπεία της Yamaha στη χώρα σας (επόμενη σελίδα). * ΕΟΧ: Ευρωπαϊκός Οικονομικός Χώρος
Svenska	Viktigt: Garantiinformation för kunder i EES-området* och Schweiz För detaljerad information om denna Yamaha-produkt samt garantiservice i hela EES-området* och Schweiz kan fås enten ved å besöka nedanstående webbadress (en utskriftsvärdig fil finns på webbplatsen) eller kontakta Yamahas officiella representant i ditt land (nästa sida). * EES: Europeiska Ekonomiska Samarbetsområdet
Norsk	Viktig merknad: Garantiinformasjon for kunder i EØS* og Sveits Detaljert garantiinformasjon om dette Yamaha-produktet og garantiservice for hele EØS-området* og Sveits kan fås enten ved å besøke nettadressen nedenfor (utskriftsversjon finnes på våre nettsider) eller kontakte kontakta Yamaha-kontoret i landet der du bor (neste side). *EØS: Det europeiske økonomiske samarbeidsområdet
Dansk	Vigtig oplysning: Garantioplysninger til kunder i EØO* og Schweiz De kan finde detaljerede garantioplysninger om dette Yamaha-produkt og den fælles garantiserviceordning for EØO* (og Schweiz) ved at besøge det websted, der er angivet nedenfor (der findes en fil, som kan udskrives, på vores websted), eller ved at kontakte Yamahas nationale repræsentationskontor i det land, hvor De bor (næste side). * EØO: Det Europæiske Økonomiske Område

Stuomi	Tärkeä ilmoitus: Taku tiedot Euroopan talousalueen (ETA)* ja Sveitsin asiakkaille Tämän Yamaha-tuotteen sekä ETA-alueen ja Sveitsin takuuta koskevat yksityiskohtaiset tiedot saatte alla olevasta netti-sivustosta. (Tulostettava tiedosto saatavissa sivustollamme.) Voitte myös ottaa yhteyttä paikalliseen Yamaha-edustajaan (seuraavalla sivulla). *ETA: Euroopan talousalue
Polski	Ważne: Warunki gwarancyjne obowiązujące w EOG* i Szwajcarii Aby dowiedzieć się więcej na temat warunków gwarancyjnych tego produktu firmy Yamaha i serwisu gwarancyjnego w całym EOG* i Szwajcarii, należy odwiedzić wskazaną poniżej stronę internetową (plik gotowy do wydruku znajduje się na naszej stronie internetowej) lub skontaktować się z przedstawicielstwem firmy Yamaha w swoim kraju (następna strona). * EOG — Europejski Obszar Gospodarczy
Česky	Důležité oznámení: Záruční informace pro zákazníky v EHS* a ve Švýcarsku Podrobné záruční informace o tomto produktu Yamaha a záručním servisu v celém EHS* a ve Švýcarsku naleznete na níže uvedené webové adrese (soubor k tisku je dostupný na našich webových stránkách) nebo se můžete obrátit na zastoupení firmy Yamaha ve své zemi (další stránka). * EHS: Evropský hospodářský prostor
Magyar	Fontos figyelmeztetés: Garancia-információk az EGT* területén és Svájcban élő vásárlók számára A jelen Yamaha termék részletes garancia-információját, valamint az EGT*-re és Svájcra kiterjedő garanciális szolgáltatás tekintetében keresse fel webhelyünket az alábbi címen (a webhelyen nyomtatható fájl is talál), vagy pedig lépjen kapcsolatba az országában működő Yamaha képviselői irodával (következő oldal). * EGT: Európai Gazdasági Térség
Eesti keel	Oluline märkus: Garantiteave Euroopa Majanduspiirkonna (EMP)* ja Šveitsi klientidele Täpsemat teavet saamiseks selle Yamaha toote garantii ning kogu Euroopa Majanduspiirkonna ja Šveitsi garantiteeninduse kohta, külastage palun veebisaiti alljärgneval aadressil (meie saitil on saadaval printitav fail) või pöörduge Teie regiooni Yamaha esinduse poole (järgmine lehekülg). * EMP: Euroopa Majanduspiirkond
Latviešu	Svarīgs paziņojums: garantijas informācija klientiem EEE* un Šveicē Lai saņemtu detaļētāku garantijas informāciju par šo Yamaha produktu, kā arī garantijas apkalpošanu EEE* un Šveicē, lūdzam apmeklētiet zemāk norādīto tīmekļa vietnes adresi (tīmekļa vietnē ir pieejams drukājams fails) vai sazināties ar jūsu valstī apkalpojošo Yamaha pārstāvniecību (nākamā lappuse). * EEE: Eiropas Ekonomikas zona
Lietuvių kalba	Dėmesio: informacija dėl garantijos priekšams EEE* ir Šveicarijoje Jei reikia išsamios informacijos apie šį „Yamaha“ produktą ir jo techninę priežiūrą visoje EEE* ir Šveicarijoje, apsilankykite mūsų svetainėje toliau nurodytu adresu (svetainėje yra spausdintinas failas) arba kreipkitės į „Yamaha“ atstovybę savo šaliai (kitas puslapis). * EEE – Europos ekonominė erdvė
Slovenčina	Dôležité upozornenie: Informácie o záruke pre zákazníkov v EHP* a Švajčiarsku Podrobné informácie o záruke týkajúcej sa tohto produktu od spoločnosti Yamaha a garancijnom servisu v EHP* a Švajčiarsku nájdete na webovej stránke uvedenej nižšie (na našej webovej stránke je k dispozícii súbor na tlač) alebo sa obráťte na zástupcu spoločnosti Yamaha vo svojej krajine (nasledujúca strana). * EHP: Európsky hospodársky priestor
Slovensščina	Pomembno obvestilo: Informacije o garanciji za kupce v EGP* in Švici Za podrobnejše informacije o tem Yamahinem izdelku ter garancijskem servisu v celotnem EGP in Švici, obiščite spletno mesto, ki je navedeno spodaj (natisljiva datoteka je na voljo na našem spletnem mestu), ali se obrnite na Yamahinega predstavništva v svoji državi (naslednja stran). * EGP: Evropski gospodarski prostor
Български език	Важно съобщение: Информация за гаранцията за клиенти в ЕИП* и Швейцария За подробна информация за гаранцията за този продукт на Yamaha и гаранционното обслужване в панаевропейската зона на ЕИП* и Швейцария или посетете посочения по-долу уеб сайт (на нашия уеб сайт има файл за печат), или се свържете с представителния офис на Yamaha във вашата страна (следваща страница). * ЕИП: Европейско икономическо пространство
Limba română	Notificare importantă: Informații despre garanție pentru clienții din SEE* și Elveția Pentru informații detaliate privind acest produs Yamaha și serviciul de garanție Pan-SEE* și Elveția, vizitați site-ul la adresa de mai jos (fișierul imprimabil este disponibil pe site-ul nostru) sau contactați biroul reprezentanței Yamaha din țara dumneavoastră (pagina următoare). * SEE: Spațiul Economic European

<http://europe.yamaha.com/warranty/>

Yamaha Representative Offices in Europe

AUSTRIA

Yamaha Music Europe GmbH
Branch Austria
Schleiergasse 20, A-1100 Wien Austria
Tel: +43 (0)1 602 03900
Fax: +43 (0)1 602 039051

BELGIUM

Yamaha Music Europe GmbH
Branch Benelux
Clarissenhof 5b NL, 4133 AB, Vianen
The Netherlands
Tel: +31 (0)347 358040
Fax: +31 (0)347 358060

BULGARIA

Yamaha Music Europe GmbH
Branch Austria (Central and Eastern Europe)
Schleiergasse 20, A-1100 Wien Austria
Tel: +43 (0)1 602 03900
Fax: +43 (0)1 602 039051

CYPRUS

NAKAS Music Cyprus Ltd.
31C Nikis Ave., 1086 Nicosia
Tel: +357 (0)22 510 477
Fax: +357 (0)22 511 080

CZECH REPUBLIC

Yamaha Music Europe GmbH
Branch Austria (Central and Eastern Europe)
Schleiergasse 20, A-1100 Wien Austria
Tel: +43 (0)1 602 03900
Fax: +43 (0)1 602 039051

DENMARK

YS Copenhagen Liaison Office
(Yamaha Scandinavia AB Filial Denmark)
Generatørvej 6A, 2730 Herlev, Denmark
Tel: +45 44 92 49 00
Fax: +45 44 54 47 09

ESTONIA

Yamaha Music Europe GmbH
Sp. z o.o. Oddział w Polsce
(Branch Poland)
ul. 17 Sycznia 56
PL-02-146 Warszawa Poland
Tel: +48 (0)22 500 29 25
Fax: +48 (0)22 500 29 30

FINLAND

(For Musical Instrument)
F - Musiikki OY
Kaisaniementkatu 7, PL260
00101 Helsinki, Finland
Tel: +358 (0)9 618511
Fax: +358 (0)9 61851385

(For Pro Audio)

Yamaha Scandinavia AB
J.A. Wettergrens gata 1
Västra Frolunda, Sweden
(Box 300 53, 400 43 Goleborg
Sweden - Postal Address)
Tel: +46 (0)31 893400
Fax: +46 (0)31 454026

FRANCE

Yamaha Musique France
Zone d'activité de Pariset
7, rue Ambroise-Croizat
77183 Croissy-Beaubourg, France
(B.P. 70, 77312 Marne la Vallée Cedex 2
France-Adresse postale)
Tel: +33 (0)1 64 61 4000
Fax: +33 (0)1 64 61 4079

GERMANY

Yamaha Music Europe GmbH
Siemensstr 22-34
D-25462 Rellingen, b. Hamburg, Germany
Tel: +49 (0)4101 3030
Fax: +49 (0)4101 303 77702

GREECE

PH. Nakas S.A. Music House/Service
19 KM Leoforos Lavriou
19002 Peania / Attiki, Greece
Tel: +30 (0)210 6686260
Fax: +30 (0)210 6686269

HUNGARY

Yamaha Music Europe GmbH
Branch Austria (Central and Eastern Europe)
Schleiergasse 20, A-1100 Wien Austria
Tel: +43 (0)1 602 03900
Fax: +43 (0)1 602 039051

ICELAND

(For Musical Instrument)
HLJODFAERAHUSSID EHF
Siðumúli 20
108 Reykjavík, Iceland
Tel: +354 525 50 50
Fax: +354 568 65 14

(For Pro Audio)

Yamaha Scandinavia AB
J.A. Wettergrens gata 1
Västra Frolunda, Sweden
(Box 300 53, 400 43 Goleborg
Sweden - Postal Address)
Tel: +46 (0)31 893400
Fax: +46 (0)31 454026

IRELAND (REPUBLIC OF IRELAND)

Yamaha Music UK Ltd.
Sherbourne Drive
Tilbrook, Milton Keynes MK7 8BL
United Kingdom
Tel: +353 (0) 1526 2449
Fax: +44 (0) 1908 369278

ITALY

Yamaha Musica Italia s.p.a.
Viale Italia 88
20020, Lainate (Milano), Italy
Tel: +39 (0)2 93577 1
Fax: +39 (0)2 937 9556

LATVIA

Yamaha Music Europe GmbH
Sp. z o.o. Oddział w Polsce
(Branch Poland)
ul. 17 Sycznia 56
PL-02-146 Warszawa Poland
Tel: +48 (0)22 500 29 25
Fax: +48 (0)22 500 29 30

LIECHTENSTEIN

Yamaha Music Europe GmbH, Rellingen,
Branch Switzerland in Zurich
Seefeldstrasse 94, CH-8008
Zürich, Switzerland
Tel: +41 (0)44 3878080
Fax: +41 (0)44 3833918

LITHUANIA

Yamaha Music Europe GmbH
Sp. z o.o. Oddział w Polsce
(Branch Poland)
ul. 17 Sycznia 56
PL-02-146 Warszawa Poland
Tel: +48 (0)22 500 29 25
Fax: +48 (0)22 500 29 30

LUXEMBOURG

Yamaha Music Europe
Branch Benelux
Clarissenhof 5b NL, 4133 AB, Vianen
The Netherlands
Tel: +31 (0)347 358040
Fax: +31 (0)347 358060

MALTA

Olimpus Music Ltd.
The Emporium, Level 3, St. Louis Street
Msida MSD06
Tel: +356 (0)2133 2093
Fax: +356 (0)2133 2144

NETHERLANDS

Yamaha Music Europe
Branch Benelux
Clarissenhof 5b NL, 4133 AB, Vianen
The Netherlands
Tel: +31 (0)347 358040
Fax: +31 (0)347 358060

NORWAY

YS Oslo Liaison Office
(Yamaha Scandinavia AB Filial Norway)
Grini Naeringspark 1
1361 Osteras, Norway
Tel: +47 67 16 77 70
Fax: +47 67 16 77 79

POLAND

YAMAHA Music Europe GmbH
Sp. z o.o. Oddział w Polsce
ul. 17 Sycznia 56
02-146 WARSZAWA/POLSKA
Tel: +48 (0)22 500 29 25
Fax: +48 (0)22 500 29 30

PORTUGAL

Yamaha Música Ibérica, S.A.U.
Sucursal Portuguesa
Rua Alfredo da Silva
2610-016 Amadora, Portugal
Tel: +351 214 704 330
Fax: +351 214 718 220

ROMANIA

Yamaha Music Europe GmbH
Branch Austria (Central and Eastern Europe)
Schleiergasse 20, A-1100 Wien Austria
Tel: +43 (0)1 602 03900
Fax: +43 (0)1 602 039051

SLOVAKIA

Yamaha Music Europe GmbH
Branch Austria (Central and Eastern Europe)
Schleiergasse 20, A-1100 Wien Austria
Tel: +43 (0)1 602 03900
Fax: +43 (0)1 602 039051

SLOVENIA

Yamaha Music Europe GmbH
Branch Austria (Central and Eastern Europe)
Schleiergasse 20, A-1100 Wien Austria
Tel: +43 (0)1 602 03900
Fax: +43 (0)1 602 039051

SPAIN

Yamaha Música Ibérica, S.A.U.
Ctra. de la Corona km.17, 200
28230 Las Rozas de Madrid, Spain
Tel: +34 902 39 8686
Fax: +34 91 638 4660

SWEDEN

Yamaha Scandinavia AB
J.A. Wettergrens gata 1
Västra Frolunda, Sweden
(Box 300 53, 400 43 Goleborg
Sweden - Postal Address)
Tel: +46 (0)31 893400
Fax: +46 (0)31 454026

SWITZERLAND

Yamaha Music Europe GmbH, Rellingen,
Branch Switzerland in Zurich
Seefeldstrasse 94, CH-8008
Zürich, Switzerland
Tel: +41 (0)44 3878080
Fax: +41 (0)44 3833918

UNITED KINGDOM

Yamaha Music UK Ltd.
Sherbourne Drive
Tilbrook, Milton Keynes MK7 8BL
United Kingdom
Tel: +44 (0) 870 4445575
Fax: +44 (0) 1908 369278

For details of products, please contact your nearest Yamaha representative or the authorized distributor listed below.

NORTH AMERICA

CANADA

Yamaha Canada Music Ltd.
135 Milner Avenue, Scarborough, Ontario,
M1S 3R1, Canada
Tel: 416-298-1311

U.S.A.

Yamaha Corporation of America
6600 Orangethorpe Ave., Buena Park, Calif. 90620,
U.S.A.
Tel: 714-522-9011

CENTRAL & SOUTH AMERICA

MEXICO

Yamaha de México S.A. de C.V.
Calz. Javier Rojo Gómez #1149,
Col. Guadalupe del Moral
C.P. 09300, México, D.F., México
Tel: 55-5804-0600

BRAZIL

Yamaha Musical do Brasil Ltda.
Rua Joaquim Floriano, 913 - 4º andar, Itaim Bibi,
CEP 04534-013 Sao Paulo, SP. BRAZIL
Tel: 011-3704-1377

ARGENTINA

Yamaha Music Latin America, S.A.
Sucursal de Argentina
Olga Cossetini 1553, Piso 4 Norte
Madero Este-C1107CEK
Buenos Aires, Argentina
Tel: 011-4119-7000

PANAMA AND OTHER LATIN AMERICAN COUNTRIES/ CARIBBEAN COUNTRIES

Yamaha Music Latin America, S.A.
Torre Banco General, Piso 7, Urbanización Marbella,
Calle 47 y Aquilino de la Guardia,
Ciudad de Panamá, Panamá
Tel: +507-269-5311

EUROPE

THE UNITED KINGDOM/IRELAND

Yamaha Music U.K. Ltd.
Sherbourne Drive, Tilbrook, Milton Keynes,
MK7 8BL, England
Tel: 01908-366700

GERMANY

Yamaha Music Europe GmbH
Siemensstraße 22-34, 25462 Rellingen, Germany
Tel: 04101-3030

SWITZERLAND/LIECHTENSTEIN

Yamaha Music Europe GmbH
Branch Switzerland in Zürich
Seefeldstrasse 94, 8008 Zürich, Switzerland
Tel: 01-383 3990

AUSTRIA

Yamaha Music Europe GmbH Branch Austria
Schleiergasse 20, A-1100 Wien, Austria
Tel: 01-60203900

CZECH REPUBLIC/SLOVAKIA/ HUNGARY/SLOVENIA

Yamaha Music Europe GmbH Branch Austria
Schleiergasse 20, A-1100 Wien, Austria
Tel: 01-602039025

POLAND/LITHUANIA/LATVIA/ESTO- NIA

Yamaha Music Europe GmbH
Branch Sp.z o.o. Oddzial w Polsce
ul. 17 Stycznia 56, PL-02-146 Warszawa, Poland
Tel: 022-868-07-57

THE NETHERLANDS/ BELGIUM/LUXEMBOURG

Yamaha Music Europe Branch Benelux
Clarissenhof 5-b, 4133 AB Vianen, The Netherlands
Tel: 0347-358 040

FRANCE

Yamaha Musique France
BP 70-77312 Marne-la-Vallée Cedex 2, France
Tel: 01-64-61-4000

ITALY

Yamaha Musica Italia S.P.A.
Viale Italia 88, 20020 Lainate (Milano), Italy
Tel: 02-935-771

SPAIN/PORTUGAL

Yamaha Música Ibérica, S.A.
Ctra. de la Coruna km. 17, 200, 28230
Las Rozas (Madrid), Spain
Tel: 91-639-8888

GREECE

Philippos Nakas S.A. The Music House
147 Skiathou Street, 112-55 Athens, Greece
Tel: 01-228 2160

SWEDEN

Yamaha Scandinavia AB
J. A. Wettergrens Gata 1, Box 30053
S-400 43 Göteborg, Sweden
Tel: 031 89 34 00

DENMARK

YS Copenhagen Liaison Office
Generatorvej 6A, DK-2730 Herlev, Denmark
Tel: 44 92 49 00

FINLAND

F-Musiikki Oy
Kluuvikatu 6, P.O. Box 260,
SF-00101 Helsinki, Finland
Tel: 09 618511

NORWAY

Norsk filial av Yamaha Scandinavia AB
Grini Næringspark 1, N-1345 Østerås, Norway
Tel: 67 16 77 70

ICELAND

Skifan HF
Skeifan 17 P.O. Box 8120, IS-128 Reykjavik, Iceland
Tel: 525 5000

RUSSIA

Yamaha Music (Russia)
Office 4015, entrance 2, 2/15 Kuznetskii
Most street, Moscow, 107996, Russia
Tel: 495 626 0660

OTHER EUROPEAN COUNTRIES

Yamaha Music Europe GmbH
Siemensstraße 22-34, 25462 Rellingen, Germany
Tel: +49-4101-3030

AFRICA

Yamaha Corporation,
Asia-Pacific Music Marketing Group
Nakazawa-cho 10-1, Naka-ku, Hamamatsu,
Japan 430-8650
Tel: +81-53-460-2312

MIDDLE EAST

TURKEY/CYPRUS

Yamaha Music Europe GmbH
Siemensstraße 22-34, 25462 Rellingen, Germany
Tel: 04101-3030

OTHER COUNTRIES

Yamaha Music Gulf FZE
LOB 16-513, P.O.Box 17328, Jubel Ali,
Dubai, United Arab Emirates
Tel: +971-4-881-5868

ASIA

THE PEOPLE'S REPUBLIC OF CHINA

Yamaha Music & Electronics (China) Co.,Ltd.
2F, Yunhedasha, 1818 Xinzha-lu, Jingan-qu,
Shanghai, China
Tel: 021-6247-2211

HONG KONG

Tom Lee Music Co., Ltd.
11/F, Silvercord Tower 1, 30 Canton Road,
Tsimshatsui, Kowloon, Hong Kong
Tel: 2737-7688

INDIA

Yamaha Music India Pvt. Ltd.
5F Ambience Corporate Tower Ambience Mall Complex
Ambience Island, NH-8, Gurgaon-122001, Haryana, India
Tel: 0124-466-5551

INDONESIA

PT. Yamaha Music Indonesia (Distributor)
PT. Nusantik
Gedung Yamaha Music Center, Jalan Jend. Gatot
Subroto Kav. 4, Jakarta 12930, Indonesia
Tel: 21-520-2577

KOREA

Yamaha Music Korea Ltd.
8F, 9F, Dongsung Bldg. 158-9 Samsung-Dong,
Kangnam-Gu, Seoul, Korea
Tel: 080-004-0022

MALAYSIA

Yamaha Music Malaysia, Sdn., Bhd.
Lot 8, Jalan Perbandaran, 47301 Kelana Jaya,
Petaling Jaya, Selangor, Malaysia
Tel: 3-78030900

PHILIPPINES

Yupangco Music Corporation
339 Gil J. Puyat Avenue, P.O. Box 885 MCPO,
Makati, Metro Manila, Philippines
Tel: 819-7551

SINGAPORE

Yamaha Music Asia Pte., Ltd.
#03-11 A-Z Building
140 Paya Lebor Road, Singapore 409015
Tel: 747-4374

TAIWAN

Yamaha KHS Music Co., Ltd.
3F, #6, Sec.2, Nan Jing E. Rd. Taipei.
Taiwan 104, R.O.C.
Tel: 02-2511-8688

THAILAND

Siam Music Yamaha Co., Ltd.
4, 6, 15 and 16th floor, Siam Motors Building,
891/1 Rama 1 Road, Wangmai,
Pathumwan, Bangkok 10330, Thailand
Tel: 02-215-2626

OTHER ASIAN COUNTRIES

Yamaha Corporation,
Asia-Pacific Music Marketing Group
Nakazawa-cho 10-1, Naka-ku, Hamamatsu,
Japan 430-8650
Tel: +81-53-460-2317

OCEANIA

AUSTRALIA

Yamaha Music Australia Pty. Ltd.
Level 1, 99 Queensbridge Street, Southbank,
Victoria 3006, Australia
Tel: 3-9693-5111

NEW ZEALAND

Music Works LTD
P.O.BOX 6246 Wellesley, Auckland 4680,
New Zealand
Tel: 9-634-0099

COUNTRIES AND TRUST TERRITORIES IN PACIFIC OCEAN

Yamaha Corporation,
Asia-Pacific Music Marketing Group
Nakazawa-cho 10-1, Naka-ku, Hamamatsu,
Japan 430-8650
Tel: +81-53-460-2312

HEAD OFFICE Yamaha Corporation, Pro Audio & Digital Musical Instrument Division
Nakazawa-cho 10-1, Naka-ku, Hamamatsu, Japan 430-8650
Tel: +81-53-460-3273



Yamaha Home Keyboards Home Page
<http://music.yamaha.com/homekeyboard/>

Yamaha Manual Library
<http://www.yamaha.co.jp/manual/>

U.R.G., Pro Audio & Digital Musical Instrument Division, Yamaha Corporation
© 2010 Yamaha Corporation

WT98820 XXXPOXXX.X-01A0
Printed in China