



DJX

DJX-UB

Owner's Manual

SPECIAL MESSAGE SECTION

This product utilizes batteries or an external power supply (adapter). DO NOT connect this product to any power supply or adapter other than one described in the manual, on the name plate, or specifically recommended by Yamaha.

WARNING: Do not place this product in a position where anyone could walk on, trip over, or roll anything over power or connecting cords of any kind. The use of an extension cord is not recommended! IF you must use an extension cord, the minimum wire size for a 25' cord (or less) is 18 AWG. NOTE: The smaller the AWG number, the larger the current handling capacity. For longer extension cords, consult a local electrician.

This product should be used only with the components supplied or; a cart, rack, or stand that is recommended by Yamaha. If a cart, etc., is used, please observe all safety markings and instructions that accompany the accessory product.

SPECIFICATIONS SUBJECT TO CHANGE:

The information contained in this manual is believed to be correct at the time of printing. However, Yamaha reserves the right to change or modify any of the specifications without notice or obligation to update existing units.

This product, either alone or in combination with an amplifier and headphones or speaker/s, may be capable of producing sound levels that could cause permanent hearing loss. DO NOT operate for long periods of time at a high volume level or at a level that is uncomfortable. If you experience any hearing loss or ringing in the ears, you should consult an audiologist.

IMPORTANT: The louder the sound, the shorter the time period before damage occurs.

Some Yamaha products may have benches and / or accessory mounting fixtures that are either supplied with the product or as optional accessories. Some of these items are designed to be dealer assembled or installed. Please make sure that benches are stable and any optional fixtures (where applicable) are well secured BEFORE using.

Benches supplied by Yamaha are designed for seating only. No other uses are recommended.

NOTICE:

Service charges incurred due to a lack of knowledge relating to how a function or effect works (when the unit is operating as designed) are not covered by the manufacturer's warranty, and are therefore the owners responsibility. Please study this manual carefully and consult your dealer before requesting service.

ENVIRONMENTAL ISSUES:

Yamaha strives to produce products that are both user safe and environmentally friendly. We sincerely believe that our products and the production methods used to produce them, meet these goals. In keeping with both the letter and the spirit of the law, we want you to be aware of the following:

Battery Notice:

This product MAY contain a small non-rechargeable battery which (if applicable) is soldered in place. The average life span of this type of battery is approximately five years. When replacement becomes necessary, contact a qualified service representative to perform the replacement.

This product may also use "household" type batteries. Some of these may be rechargeable. Make sure that the battery being charged is a rechargeable type and that the charger is intended for the battery being charged.

When installing batteries, do not mix batteries with new, or with batteries of a different type. Batteries MUST be installed correctly. Mismatches or incorrect installation may result in overheating and battery case rupture.

Warning:

Do not attempt to disassemble, or incinerate any battery. Keep all batteries away from children. Dispose of used batteries promptly and as regulated by the laws in your area. Note: Check with any retailer of household type batteries in your area for battery disposal information.

Disposal Notice:

Should this product become damaged beyond repair, or for some reason its useful life is considered to be at an end, please observe all local, state, and federal regulations that relate to the disposal of products that contain lead, batteries, plastics, etc. If your dealer is unable to assist you, please contact Yamaha directly.

NAME PLATE LOCATION:

The name plate is located on the bottom of the product. The model number, serial number, power requirements, etc., are located on this plate. You should record the model number, serial number, and the date of purchase in the spaces provided below and retain this manual as a permanent record of your purchase.

Model _____

Serial No. _____

Purchase Date _____

PLEASE KEEP THIS MANUAL

PRECAUTIONS

PLEASE READ CAREFULLY BEFORE PROCEEDING

* Please keep these precautions in a safe place for future reference.



WARNING

Always follow the basic precautions listed below to avoid the possibility of serious injury or even death from electrical shock, short-circuiting, damages, fire or other hazards. These precautions include, but are not limited to, the following:

- Do not open the instrument or attempt to disassemble the internal parts or modify them in any way. The instrument contains no user-serviceable parts. If it should appear to be malfunctioning, discontinue use immediately and have it inspected by qualified Yamaha service personnel.
- Do not expose the instrument to rain, use it near water or in damp or wet conditions, or place containers on it containing liquids which might spill into any openings.
- If the AC adaptor cord or plug becomes frayed or damaged, or if there is a sudden loss of sound during use of the instrument, or if any unusual smells or smoke should appear to be caused by it, immediately turn off the power switch, disconnect the adaptor plug from the outlet, and have the instrument inspected by qualified Yamaha service personnel.
- Use the specified adaptor (PA-5B, PA-5C or an equivalent recommended by Yamaha) only. Using the wrong adaptor can result in damage to the instrument or overheating.
- Before cleaning the instrument, always remove the electric plug from the outlet. Never insert or remove an electric plug with wet hands.
- Check the electric plug periodically and remove any dirt or dust which may have accumulated on it.



CAUTION

Always follow the basic precautions listed below to avoid the possibility of physical injury to you or others, or damage to the instrument or other property. These precautions include, but are not limited to, the following:

- Do not place the AC adaptor cord near heat sources such as heaters or radiators, and do not excessively bend or otherwise damage the cord, place heavy objects on it, or place it in a position where anyone could walk on, trip over, or roll anything over it.
- When removing the electric plug from the instrument or an outlet, always hold the plug itself and not the cord.
- Do not connect the instrument to an electrical outlet using a multiple-connector. Doing so can result in lower sound quality, or possibly cause overheating in the outlet.
- Unplug the AC power adaptor when not using the instrument, or during electrical storms.
- Always make sure all batteries are inserted in conformity with the +/- polarity markings. Failure to do so might result in overheating, fire, or battery fluid leakage.
- Always replace all batteries at the same time. Do not use new batteries together with old ones. Also, do not mix battery types, such as alkaline batteries with manganese batteries, or batteries from different makers, or different types of batteries from the same maker, since this can cause overheating, fire, or battery fluid leakage.
- Do not dispose of batteries in fire.
- Do not attempt to recharge batteries that are not intended to be charged.
- When the batteries run out, or if the instrument is not to be used for a long time, remove the batteries from the instrument to prevent possible leakage of the battery fluid.
- Keep batteries away from children.
- If the batteries do leak, avoid contact with the leaked fluid. If the battery fluid should come in contact with your eyes, mouth, or skin, wash immediately with water and consult a doctor. Battery fluid is corrosive and may possibly cause loss of sight or chemical burns.
- Before connecting the instrument to other electronic components, turn off the power for all components. Before turning the power on or off for all components, set all volume levels to minimum. Also, be sure to set the volumes of all components at their minimum levels and gradually raise the volume controls while playing the instrument to set the desired listening level.
- Do not expose the instrument to excessive dust or vibrations, or extreme cold or heat (such as in direct sunlight, near a heater, or in a car during the day) to prevent the possibility of panel disfiguration or damage to the internal components.
- Do not use the instrument near other electrical products such as televisions, radios, or speakers, since this might cause interference which can affect proper operation of the other products.
- Do not place the instrument in an unstable position where it might accidentally fall over.
- Before moving the instrument, remove all connected adaptor and other cables.
- When cleaning the instrument, use a soft, dry cloth. Do not use paint thinners, solvents, cleaning fluids, or chemical-impregnated wiping cloths. Also, do not place vinyl, plastic or rubber objects on the instrument, since this might discolor the panel or keyboard.
- Do not rest your weight on, or place heavy objects on the instrument, and do not use excessive force on the buttons, switches or connectors.
- Use only the stand specified for the instrument. When attaching the stand or rack, use the provided screws only. Failure to do so could cause damage to the internal components or result in the instrument falling over.
- Do not operate the instrument for a long period of time at a high or uncomfortable volume level, since this can cause permanent hearing loss. If you experience any hearing loss or ringing in the ears, consult a physician.

■ SAVING USER DATA

- Always save data to an external device such as the Yamaha MIDI data filer MDF3 frequently, in order to help prevent the loss of important data due to a malfunction or user operating error.

Yamaha cannot be held responsible for damage caused by improper use or modifications to the instrument, or data that is lost or destroyed.

Always turn the power off when the instrument is not in use.

Make sure to discard used batteries according to local regulations.

Congratulations on your purchase of the Yamaha DJX-IIB!

The DJX-IIB is a complete dance-music workstation that can be used both as a real-time performance instrument and a powerful production tool. Its intuitive interface makes real-time operation easy for artists with a DJ background.

Read this Owner's Manual carefully while playing your new DJX-IIB in order to take full advantage of its various features.

Packing List

- DJX-IIB
- Owner's Manual

- CD-ROM

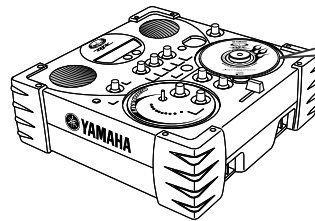

(Installed at the factory.)

How to Use the Manual

- **What is the DJX-IIB?**page 5
Introduces the various DJX-IIB features.
- **Panel Controls**page 8
Use this section to find out about all of the buttons and controls of the DJX-IIB.
- **Setting Up**page 12
Explains how to connect up the power adaptor and how to install batteries.
- **100 tips to be a DJ!**page 14
This section guides the novice user step-by-step through 100 important and useful tips in playing and creating great dance music. Like a game, each tip is a step up toward the goal of becoming a master DJ.
- **Appendix**page 70
This contains various important lists such as the Voice list, Preset Pattern list, MIDI data format and MIDI implementation chart.
- **Troubleshooting**page 70
If the DJX-IIB does not function as expected or you have some problem with the sound or operation, consult this section before calling your Yamaha dealer or service center. Most common problems and their solutions are covered here in a very simple and easy-to-understand way.
- **Glossary**page 73
This section covers various important words and terms related to both the DJX-IIB and to dance music in general.
- **Index**page 88
This section alphabetically lists virtually all topics, features, functions and operations with their respective page numbers, letting you quickly and easily find the information you need.

The illustrations and displays as shown in this owner's manual are for instructional purposes only, and may be different from your instrument.



What is the DJX-IIB?



The new DJX-IIB is a digital DJ powerhouse!

If you've dreamed of creating and performing your own cutting-edge, phat 'n' funky dance music, you've come to the right place... The DJX-IIB is a fully digital DJ machine — a revolutionary new instrument that blends the reliability and clean sound of digital with stunningly powerful and easy-to-use analog-like controls.



No music knowledge or experience required!

If you've got great music in your head, but haven't had the training to bring it out to the real world, here's your chance! You don't need to know about chords, or how to read and play melodies — all you need is a good sense of rhythm, and the DJX-IIB can even help you develop that, too!



Let the DJX-IIB show you how to become a master DJ!

Whether you're a complete beginner or a turntable and mixing genius, the DJX-IIB can help you fully master the instrument. With the "100 Tips" section, you're guided step-by-step through 100 tips and trade secrets the pros use in playing and creating great dance music. Like a game, each tip is a step up toward the goal of becoming a master DJ.

Now let's take a look at the individual features and functions of the DJX-IIB

- **Pattern Playerpage 14**
The DJX-IIB features a total of 70 dynamic rhythm patterns, perfect for your DJ performance. Each pattern has 10 different variations.
- **Scratch Padpage 26**
This awesome feature puts a virtual turntable at your fingertips, letting you scratch your own accents, beats and instrument hits — just like a real DJ! With a huge selection of 73 special Scratch "kits" to choose from, you can fly in turntable scratches, arpeggios, sound effects, and vocal soundbites — all while the rhythm is playing!
- **Powerful Effectspage 20**
The DJX-IIB gives you a ton of amazing sonic control features, including a wide variety of stunning effects that can be manipulated in real time. Use the special Scratch Pad and the knobs to tweak, warp and mangle your sound as you play.
- **Audio bpmpage 62**
If you've got a favorite beat on CD or vinyl, you can easily sync it up to the DJX-IIB! The DJX-IIB "hears" the beat (from a connected CD player, MD player, etc.) and automatically locks into the rhythm by auto-adjusting the bpm of the DJX-IIB's pattern.
- **MIDI Compatibility for Even Greater DJ Performance Powerpage 65**
Grow your own patterns! With MIDI, you can connect a MIDI device (such as a computer or sequencer) to the DJX-IIB, and send patterns you've created on the sequencer to the DJX-IIB as pattern data. Then wail away with your new patterns on the DJX-IIB!

Contents

Packing List.....	4
How to Use the Manual.....	4
What is the DJX-IIB?.....	5
Contents	6
Panel Controls.....	8
Top Panel.....	8
Changing the Scratch Pad CD.....	10
Rear Panel & Connections	11
Setting Up (Power supply connections).....	12
Switching On the Power	13
Data Backup & Initialization	13

100 Tips to be a DJ! 14

Chapter 1

Pattern Player Basics..... 14

Tip 1 Work out with the Patterns!	14
Tip 2 Switch between Banks	15
Tip 3 Mixing Main and Fill-in Patterns.....	16
Tip 4 Exploring other Patterns.....	16
Tip 5 Come down on the “one”!.....	18
Tip 6 Keep the bpm steady!	19

Chapter 2

Live Effector Basics.....20

Tip 7 What is the Live Effector?	20
Tip 8 Distortion	21
Tip 9 Auto Pan	21
Tip 10 Ring Modulation	21
Tip 11 Flanger	21
Tip 12 Phaser.....	22
Tip 13 Slice	22
Tip 14 Delay	22
Tip 15 Echo	23
Tip 16 Lo-Fi.....	23
Tip 17 Wah.....	23

Chapter 3

Isolator Basics.....24

Tip 18 Tweak the sound just right!	24
--	----

Chapter 4

Filter Basics.....25

Tip 19 Cutoff and Resonance.....	25
----------------------------------	----

Chapter 5

Scratch Pad Clinic.....26

Tip 20 Work out on the Scratch Pad!	26
Tip 21 Quarter-note scratching.....	27
Tip 22 Eighth-note scratching.....	28
Tip 23 Sixteenth-note scratching	28
Tip 24 Shuffle feel	29
Tip 25 Triggering drum loops from the Scratch Pad	29

Tip 26 Scratch Pad arpeggios	30
Tip 27 Scratch Pad sound effects	30
Tip 28 Scratch low, scratch high.....	30
Tip 29 Stop the turntable	31
Tip 30 Give the Scratch Pad a new face!	31
Tip 31 CD-ROM goodies	31

Chapter 6

Part Mixer Basics..... 32

Tip 32 What is a Part?.....	32
Tip 33 Take the console and remix the Parts!	32
Tip 34 Extra texture!.....	33

Chapter 7

Crossfader Basics..... 34

Tip 35 Work the Crossfader!.....	34
Tip 36 Mute the Pattern	34
Tip 37 Crossfader cuts	35

Chapter 8

Intermediate

Techniques..... 36

Tip 38 Transpose the key.....	36
Tip 39 Change the bpm	37
Tip 40 Reset to the default bpm.....	37
Tip 41 Fade in, fade out.....	38
Tip 42 Travel light!	38
Tip 43 Tweak the cutoff.....	39
Tip 44 Wah-wah scratching	39
Tip 45 Warped vinyl and a cheap turntable!.....	40
Tip 46 Scratch Drum Loops in sync	40
Tip 47 Mute the Scratch	40

Chapter 9

Pattern Player Power Tips..... 41

Tip 48 Hitting a new Pattern and Variation — at the same time!	41
Tip 49 Hitting a new Pattern, Bank and Variation — at the same time!	41
Tip 50 Break to a new Pattern!.....	42
Tip 51 One-bar Patterns — all in a row!	43

Chapter 10

Crossfader Power Tips..... 44

Tip 52 Quick Crossfader scratching	44
Tip 53 Long Crossfader scratching	44
Tip 54 Pattern loop vs. scratch loop	44

Chapter 11

Using the BPM/TAP button..... 45

Tip 55 Tap out the beat!	45
Tip 56 Start with a tap.....	45

Chapter 12

The Outside World..... 46

Tip 57 Expanding your DJ setup.....	46
Tip 58 Mute the speakers	46

Chapter 13

More Pattern Player Power Tips ...47

- Tip 59 Creative Fill-in 1 47
- Tip 60 Creative Fill-in 2 47
- Tip 61 Playing intros and transitions 47
- Tip 62 Playing intros and transitions, part 2 47

Chapter 14

Live Effector Power Tips 48

- Tip 63 Distortion 48
- Tip 64 Auto Pan 48
- Tip 65 Ring Modulation 49
- Tip 66 Flanger 49
- Tip 67 Phaser 49
- Tip 68 Slice 49
- Tip 69 Delay 50
- Tip 70 Delay fill-in 50
- Tip 71 Echo 51
- Tip 72 Lo-Fi 51
- Tip 73 Wah 51

Chapter 15

Isolator and Filter Power Tips ..52

- Tip 74 Isolator to the max! 52
- Tip 75 Dark mixes and deep grooves
— cut the Cutoff! 53

Chapter 16

Scratch Pad Power Tips54

- Tip 76 Scratching triplets 54
- Tip 77 Scratch on an intro! 55
- Tip 78 Spin around and stop! 55
- Tip 79 Instrumental dropout 56
- Tip 80 More Part mixing 56

Chapter 17

Advanced Techniques58

- Tip 81 Delay fill-in and fader cut 58
- Tip 82 Fade the scratch in and out! 58
- Tip 83 Bored? Add some chords... and scratching! 59
- Tip 84 Down and out! 59
- Tip 85 One-hand Effector control! 60
- Tip 86 Instant reset! 61
- Tip 87 Hit the Part on the “one”! 61
- Tip 88 Check the bpm 61

Chapter 18

DJ Performance

Master Class62

- Tip 89 Cut in with a scratch and hit the next
Variation 62
- Tip 90 Auto-adjusting the bpm 62
- Tip 91 Creative Fill-in 3 63
- Tip 92 Crossfader cut-in — Scratch plus effect 63
- Tip 93 Crossfader cut-in — Scratch plus Delay 63
- Tip 94 Outro -tro -tro -tro 64

- Tip 95 Upside down, inside out! 64
- Tip 96 Taking the pulse 64
- Tip 97 Sync applications
— using the DJX-IIB as the master 65
- Tip 98 Sync applications
— using the DJX-IIB as the slave 66
- Tip 99 Get more Patterns! 67
- Tip 100 Create your own Patterns! 68

Appendix

70

Troubleshooting	70
Error Message List	71
Specifications	72
Glossary	73
Pattern List	75
Voice List	76
Drum Kit List	78
MIDI Data Format	81
MIDI Implementation Chart	87
Index	88

Panel Controls

Top Panel

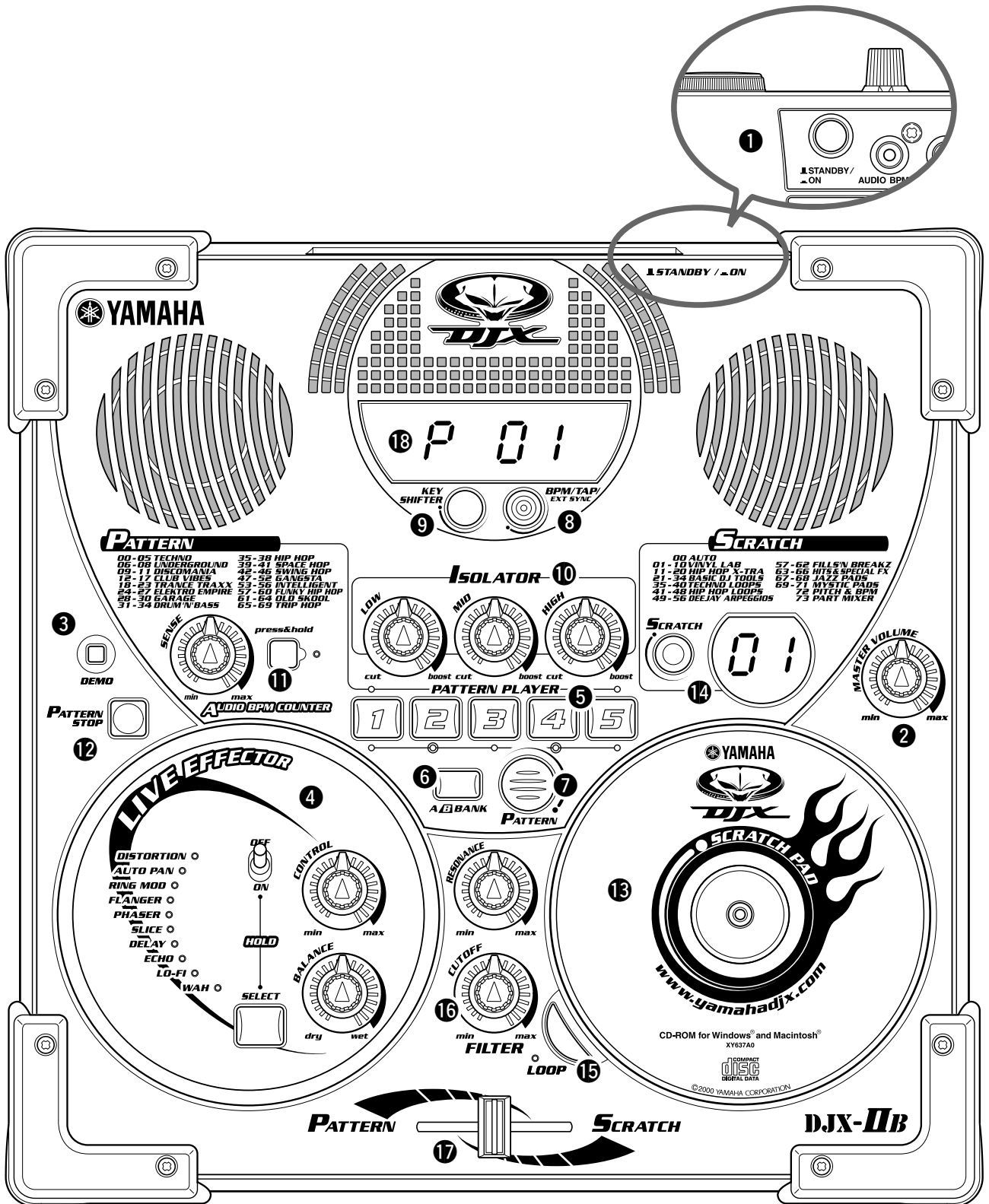

◆ **Be careful!** Avoid pressing three or more panel buttons simultaneously. Doing so can cause the DJX-IIB to behave erratically.

This is the DJX-IIB!

1 STANDBY/ON switch13
 Press to toggle the power on or off. (Power is on when the switch is pressed in.)

2 MASTER VOLUME.....13
 This determines the overall volume of the DJX-IIB.

3 DEMO button
 This is used to play the Demo songs that showcase the sophisticated capabilities of the DJX-IIB.
 Press this button to start/stop the Demo songs.
 To select one of the Demo songs, hold the button down and simultaneously turn the scratch pad.

4 LIVE EFFECTOR section..... 20, 48
 The DJX-IIB has a wide variety of built-in effects that affect the entire sound of the DJX-IIB and can be manipulated in real time. Use the SELECT button to call up one of the ten effects, then work the knobs to change the depth and amount of the effect.

5 PATTERNPLAYER buttons14
 Press these buttons to trigger the various patterns of the DJX-IIB. The pattern starts immediately, as soon as its button is pressed.

6 A/B BANK button15
 Each of the DJX-IIB's patterns has 10 different variations. Use this button to switch between banks, then use the five PATTERN PLAYER buttons to play the desired pattern — giving you 10 different patterns to work with!

7 PATTERN button16
 This button lets you select the desired pattern. Simultaneously hold the button down and rotate the Scratch Pad "CD."

8 BPM/TAP button..... 45
 This is used to change the bpm (tempo) of the selected pattern.
 Each pattern of the DJX-IIB has been programmed with a default or standard bpm (tempo); however, you can change the bpm to any value between 32 and 280 beats per minute.
 This button also determines whether the DJX-IIB will use its own internal clock or whether it will use MIDI clock received from the MIDI IN connector.

9 KEY SHIFTER button..... 36
 This convenient button lets you change the overall pitch of the DJX-IIB to match the music on your CDs or vinyl, or to create chord changes. You can change the key of the pattern by pressing this button while the pattern is playing.

10 ISOLATOR knobs 24, 52
 Use these knobs to change the timbre or tone of the

sound, adjusting the level of each frequency range: Low, Mid, and High. Turning each knob to the right boosts the level at that frequency, while turning it to the left cuts it.

11 AUDIO BPM COUNTER button, knob..... 62
 The DJX-IIB has a powerful and convenient function that lets you synchronize external audio (such as from a CD or MD) with the patterns of the DJX-IIB. Hold down this button while playing the connected audio device. The DJX-IIB monitors the beat from the audio, and automatically locks into the rhythm by auto-adjusting the bpm of the DJX-IIB's pattern. The extracted bpm value is indicated in the display. The SENSE knob is used to adjust the input level of the external audio source.

12 PATTERN STOP button 14
 This button stops playback of the Patterns and Scratch loops. Start the DJX-IIB's patterns by pressing one of the PATTERN PLAYER buttons and stop them by pressing the PATTERN STOP button.

13 SCRATCH PAD26
 This amazing feature emulates a real turntable. Turning or rocking the CD back and forth lets you play various turntable scratches, as well as loops, hits, and other special sound effects. Select the desired Scratch sound or effect by pressing the SCRATCH button. The CD "platter" can be changed as desired. (See page 10.)

14 SCRATCH button 26
 The Scratch Pad has a total of 74 different presets/functions. Use this button to select the desired preset. The preset number is always indicated in the small display next to the SCRATCH button.

15 LOOP button 29
 Pressing this button (to turn Loop on) lets you vary the Scratch effect in different ways, depending on the selected Scratch preset.

16 FILTER knobs..... 25
 These adjust the filter cutoff and filter resonance of each part of the pattern. For the RESONANCE knob, turning to the right increases the effect. For the CUTOFF knob, turning to the right raises the frequency.

17 Fader..... 34
 This determines the level balance between the pattern and scratch sounds.

18 Display
 This shows important information on certain settings and values of the DJX-IIB.

Changing the Scratch Pad CD

Included with the DJX-IIB is a special CD-ROM disc. The disc normally serves as a “platter” for the Scratch Pad function. Since special software is included on the disk, you will need to remove the disc to install the software.

If you have a CD with a particular design that you like, you can replace the included CD-ROM disc with a disc of your choice. To change the disc, follow the instructions below.

IMPORTANT

- *The DJX-IIB does not read audio or other data from the Scratch Pad CD or CD-ROM. It merely functions as a physical “platter” for controlling the Scratch Pad, and provides added decoration. Feel free to install your own CD for different decoration if you like!*
- *Make sure to treat the included CD-ROM disc with care and be very careful not to damage it (especially during removal), since the reverse side of the disc contains important data. Yamaha cannot be responsible for any loss of data resulting from mishandling of the disc. (Normal use of the disc as a Scratch Pad will not damage the disc.)*

1 Remove the indicated screw with a screwdriver.

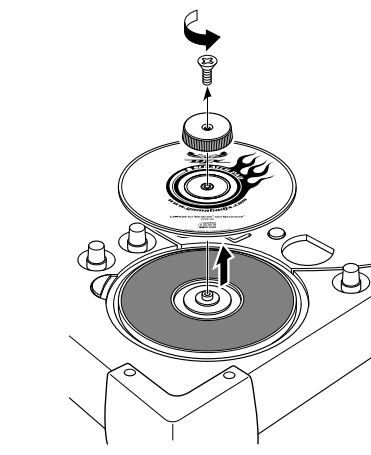

2 Remove the CD-ROM disk.

3 Place the desired audio CD (or CD-ROM) on the Scratch Pad.

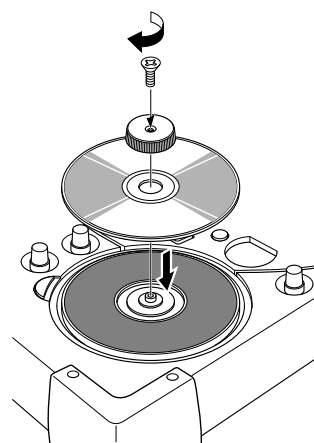

4 Replace and tighten the screw.

■ About the included CD-ROM

The included CD-ROM contains the following data:

DJX-II/IIB Premium CD-ROM

- *Live Movie at DJX Satellite*
- *DJX-II/IIB Function Guide — a fun way to get to know the DJX-IIB and its features!*
- *Pattern Launcher Application — for loading new Patterns to the DJX-IIB!*
- *Extra Patterns — a selection of specially programmed new Patterns you can load to your DJX-IIB!*

Rear Panel & Connections

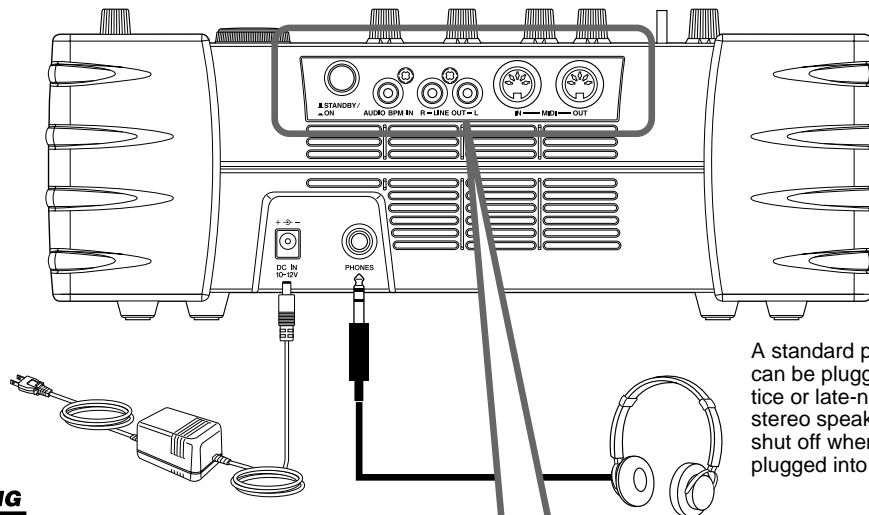

⚠ WARNING

- Connect the AC adaptor (PA-5B, PA-5C or other adaptor specifically recommended by Yamaha) to the power supply jack.

See page 12 for details.

A standard pair of stereo headphones can be plugged in here for private practice or late-night playing. The internal stereo speaker system is automatically shut off when a pair of headphones is plugged into the PHONES jack.

⚠ CAUTION

- Do not listen with the headphones at high volume for long periods of time. Doing so may cause hearing loss.

Refer to page 13.

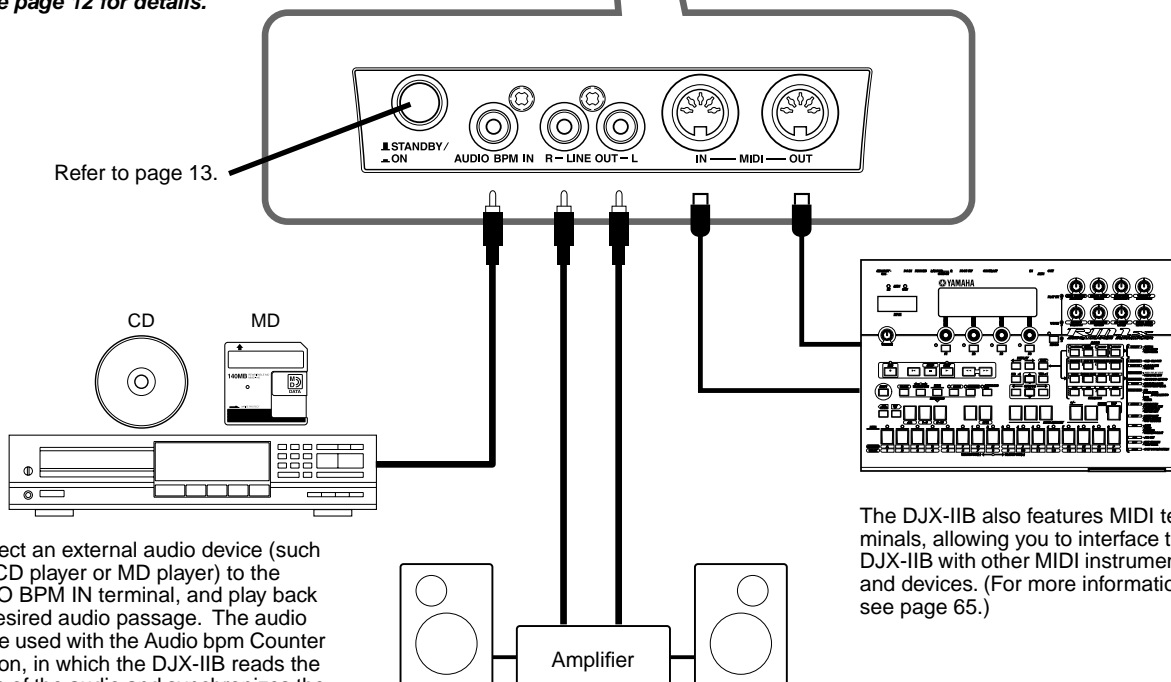

Connect an external audio device (such as a CD player or MD player) to the AUDIO BPM IN terminal, and play back the desired audio passage. The audio can be used with the Audio bpm Counter function, in which the DJX-IIB reads the tempo of the audio and synchronizes the pattern rhythm to it.

The DJX-IIB also features MIDI terminals, allowing you to interface the DJX-IIB with other MIDI instruments and devices. (For more information, see page 65.)

The LINE OUT jacks are used to send the DJX-IIB output to a keyboard amplifier, stereo sound system, mixing console, or tape recorder.

⚠ CAUTION

- Connect the DJX-IIB to external equipment only after turning off power for all devices. To prevent damage to the speakers, set the volume of the external devices at the minimum setting before connecting them. Failure to observe these cautions may result in electric shock or equipment damage.

Switching On the Power

Once you've set up your DJX-IIB, try turning the power on. Make sure your sound system's main level/volume control(s) and the DJX-IIB volume control are turned all the way down prior to turning the power on.

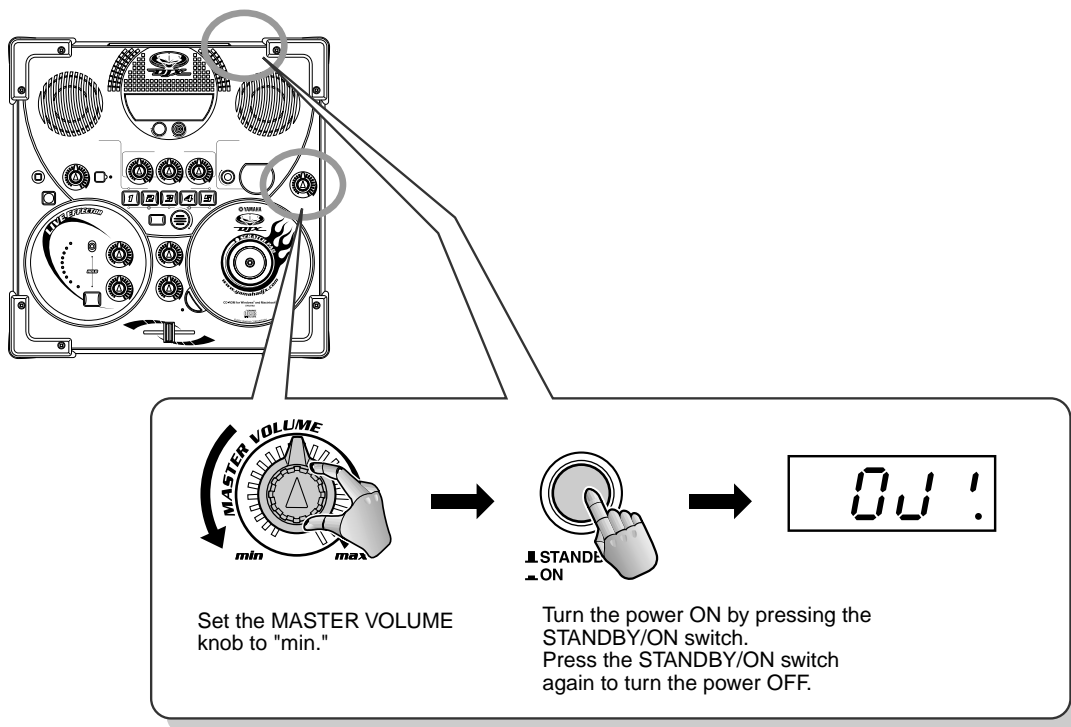

CAUTION

- Even when the switch is in the "STANDBY" position, electricity is still flowing to the instrument at the minimum level. When you are not using the DJX-IIB for a long time, make sure you unplug the AC power adaptor from the wall AC outlet, and/or remove the batteries from the instrument.

Data Backup & Initialization

Except for the User Pattern data, all DJX-IIB panel settings are reset to their initial settings whenever the power is turned on. The Use Pattern data is backed up (i.e. retained in memory) as long as an AC adaptor is connected or a set of batteries is installed.

All data can be initialized and restored to the factory preset condition by turning on the power while holding the LOOP button. "Clr!" will appear briefly on the display.



CAUTION

- All settings listed above, will be erased and/or changed when the data initialization procedure is carried out.
- Carrying out the data initialization procedure will usually restore normal operation if the DJX-IIB freezes or begins to act erratically for any reason.

This is NOT an owner's manual! At least not an ordinary one. But, then again, the DJX-IIB is no ordinary instrument. It's packed with exciting, easy-to-use dance music features that instantly sets it apart from run-of-the-mill conventional instruments!

This collection of 100 hot tips shows you how to get the most out of your new DJX-IIB in the shortest time possible. It's like an expert DJ or mixer taking you by the hand and showing you the ropes, sharing all the tricks and techniques you need to be a master DJ yourself! It takes you from the bare-bones basics, to advanced power tips that get you mixing like a pro in no time!

So jump in!

◆ The Levels — Work your way up!

- ☞ Basic operations
- ☞☞ Intermediate functions
- ☞☞☞ Advanced tricks and techniques
- ☞☞☞☞ ... Power user features

Chapter 1

Pattern Player Basics

Start your DJ apprenticeship right here! The Patterns are the basic building blocks of the DJX-IIB sound — they're the rhythmic foundation for everything else on this dance machine.

Tip 1

Work out with the Patterns!



Here's where it all starts!

Hit one of the buttons in the PATTERN PLAYER section — and the Pattern starts immediately. Hitting another button instantly switches to a different Pattern (actually, a variation on the main Pattern).

Since the DJX-IIB starts the Pattern right away, be careful to press the key in time with the rhythm

Practice this a while — there's no better way to get your timing tight and develop a solid sense of rhythm!

To stop the Pattern, press PATTERN STOP.

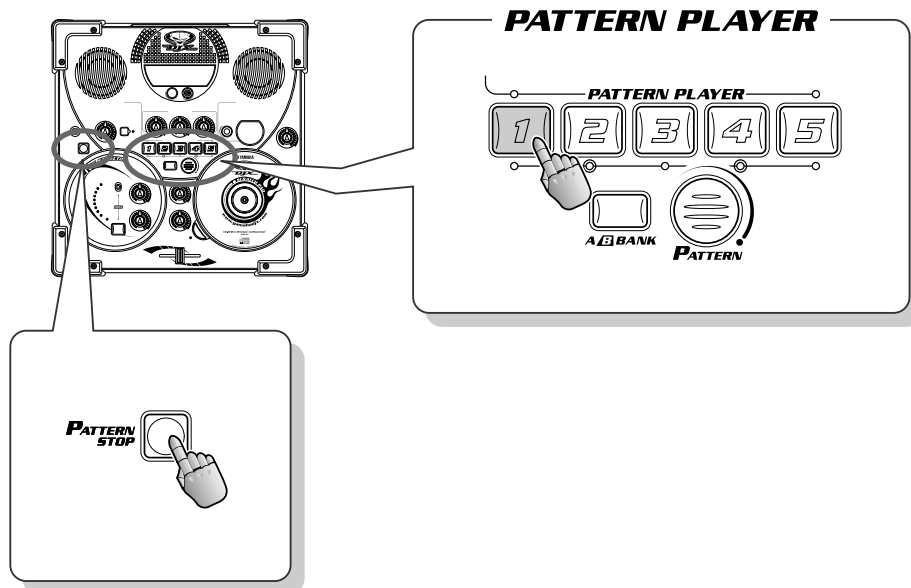



2

Switch between Banks



Even though there are five buttons in the PATTERN PLAYER, you have a total of ten Patterns at your disposal — thanks to the A/B BANK button.

Each Bank, A and B, has five Patterns. When the A/B BANK button lamp is off, you can play Patterns A1 to A5. When the A/B BANK button lamp is on, you can play Patterns B1 to B5. Pressing the button doesn't change the Pattern, it only enables the Bank. So if you press the A/B BANK button by mistake, don't worry — simply press it again, and you're back to the original bank, without any sound changes!

Try this example:

1 Start Pattern A1.

Press Pattern button 1.



2 Select Bank B.

Press the A/B BANK button. The A/B BANK button is on and Pattern button 1 flashes. (The flashing Pattern button indicates Bank select standby.)

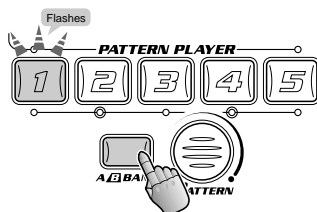

Notice that Pattern A1 is still playing. It will only change if you press another Pattern button.

3 Press Pattern button 3.

Now Pattern B3 is playing.

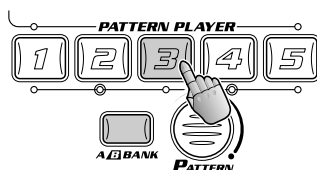

4 Select Bank A again.

The A/B BANK button is off and Pattern button 3 flashes.

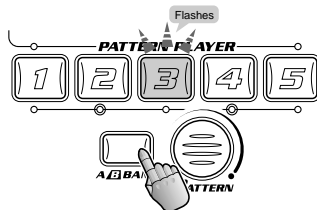

5 Press Pattern button 1.

Now you're back to Pattern A1.

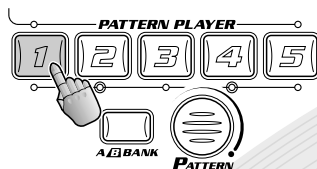



3

Mixing Main and Fill-in Patterns



Try mixing it up!

As you learned in Tip 2 above, each of the DJX-11B's Patterns has ten different Variations. The main Patterns are played with buttons 1, 3, and 5, while the fill-in Patterns are played with buttons 2 and 4. (Fill-in Patterns are usually used as dynamic breaks or transitions.)

In general, the higher the Variation number (A1 - A5, B1 - B5), the busier or more complex the Patterns become.

Listen carefully to each Pattern — remember how each of them sound — then play them one after another for your own special performance!

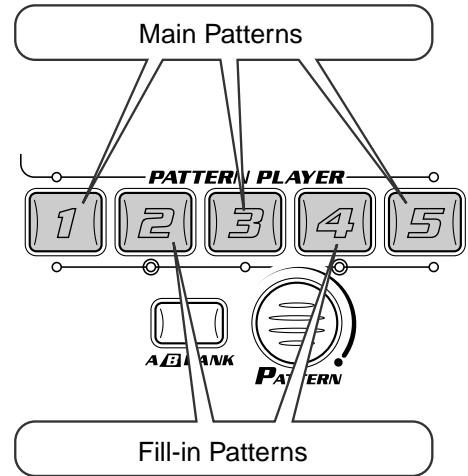

4

Exploring other Patterns



Try out some different patterns

To change the Pattern, hold down PATTERN and simultaneously turn the Scratch Pad.

Check the display to see what you're selecting. The two numbers on the left indicate the current Pattern number, and the numbers on the right indicate the new one. Turn the Scratch Pad clockwise to advance through the Pattern numbers; turn it clockwise to go back.

But wait! The new Pattern doesn't actually start until you release PATTERN! Keep holding down the button while the Pattern loops, then release PATTERN on the "one" downbeat (see Tip 5) — the Pattern changes immediately!

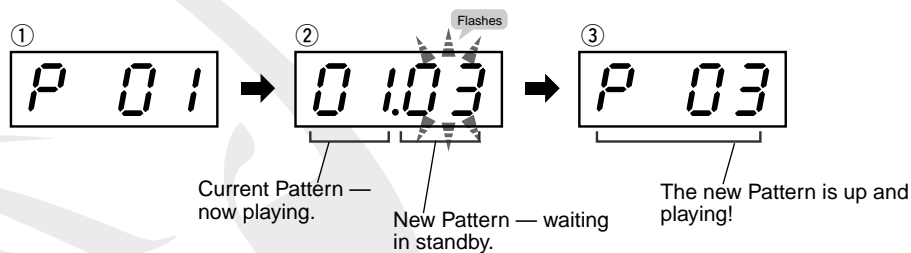
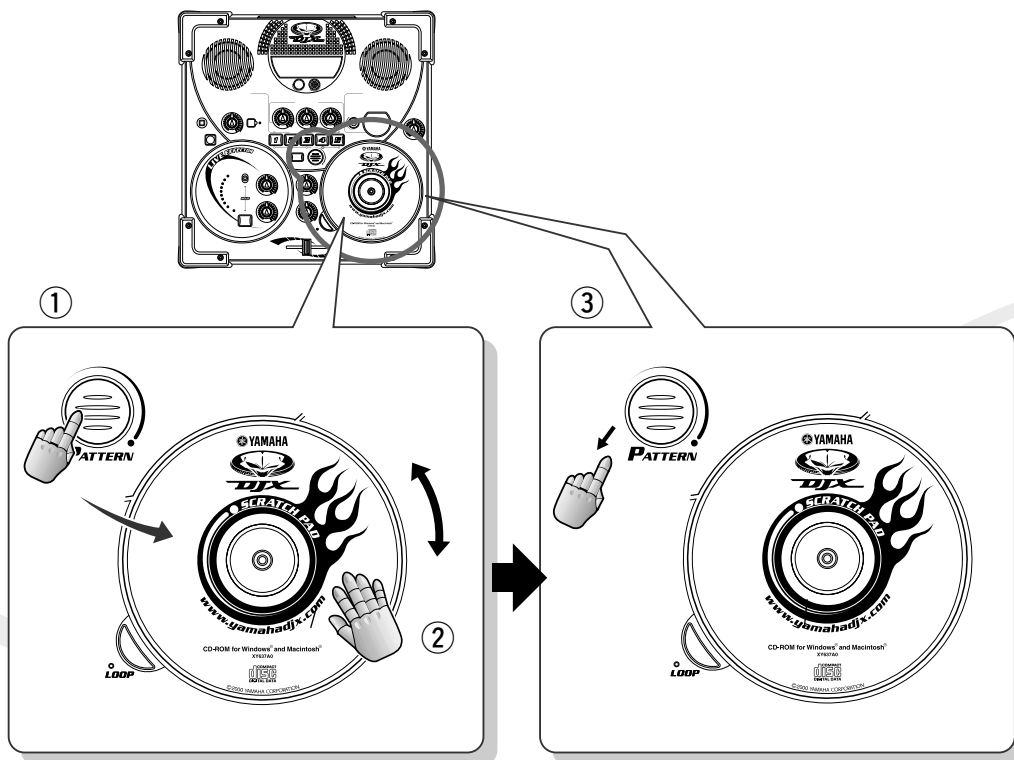

● Exploring other Patterns

Category	#	Pattern Name	Comment
TECHNO	01	Japan Beatz	Experimental electronic madness — way cool!
	05	Detroit	Serious House music — from where it all started!
DISCOMANIA	11	Disco House	London's disco club scene.
CLUB VIBES	17	Hard House	Harder than you might expect...
DRUM'N'BASS	34	Jazz D&B	Straight from the heart of London — fast and stylish!
GANGSTA	50	Light	Feel it flow, a real Hip-hop cruiser from L.A.
	52	Female	Extra smooth 'n' silky R&B-style Hip-hop.
FUNKY HIP HOP	59	Club Funk	Funk with a Hip-hop flavor — real nice!
OLD SKOOL	62	Scratchin'	Really dark and hard Hip-hop — with a nice melody on Variation 10.
TRIP HOP	65	Deep	Dark and heavy Trip-hop, atmospheric and dreamy.

Tip 5 Come down on the “one”!



The key to great timing is knowing where the “one” is. And the “one” is the first beat in a four-beat Pattern. Another key to timing is feeling the downbeats (four downbeats to a Pattern). The DJX-II B makes this easy to do!

Check this out:

While the Pattern is playing, the dot in the bpm display flashes rhythmically. (If the bpm display is not shown, press BPM/TAP.)

Try hitting a different Pattern button on the “one” downbeat — when you’ve hit it right, you’ll feel it!

If you’re having trouble coming down on the “one,” here’s a handy hint that’ll help you keep time... Double-up your count! This works especially well for slower rhythms — because even slight deviations from the beat can put glitches in your groove!

For a four-beat measure, count two on every beat — like this: 1 - 2 - 3 - 4 - 5 - 6 - 7 - 8.

Or count: “One-and-two-and-three-and-four-and...”

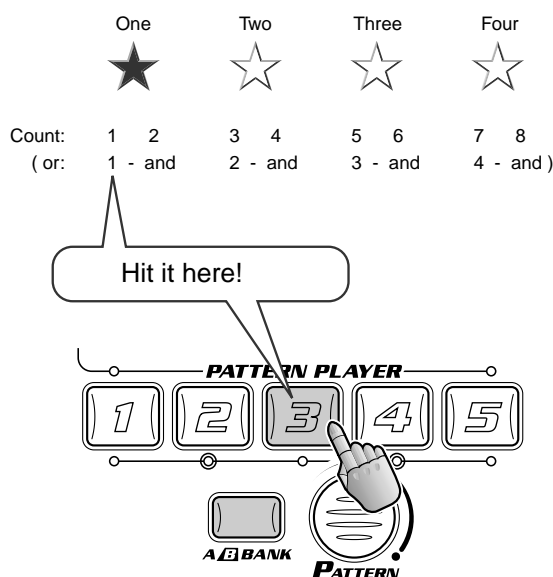

Try this technique while changing Patterns. Press a new PATTERN PLAYER button every bar, right on the “one,” all the time counting out the beat like above. It’s a fool-proof way to master the groove!

Tip 6 Keep the bpm steady!



Once you've started a Pattern, it's better to keep it playing at a steady bpm — unless you're aiming for special effects and sudden tempo changes.

Actually, the DJX-IIB takes care of this for you — automatically! If you change Patterns while a Pattern is playing, the bpm setting stays the same. However, if you stop the Pattern and start a new one, the bpm is automatically reset to best suit the newly selected Pattern.

While the Pattern is running...

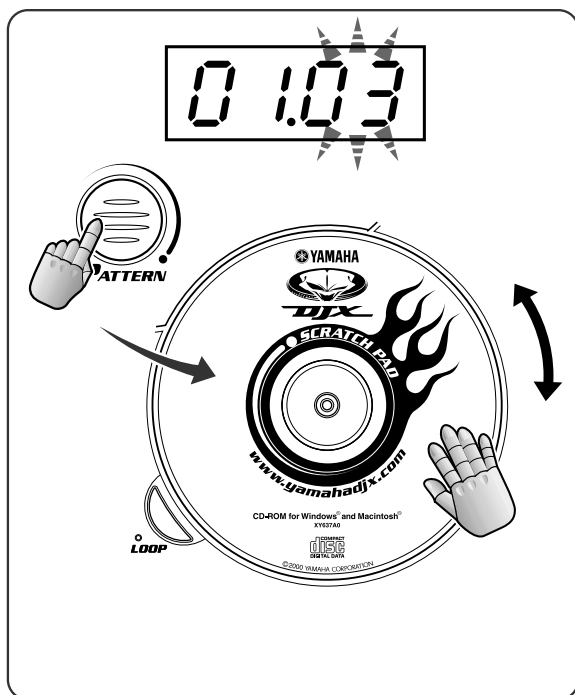

... and the bpm stays the same.

When the Pattern is stopped...

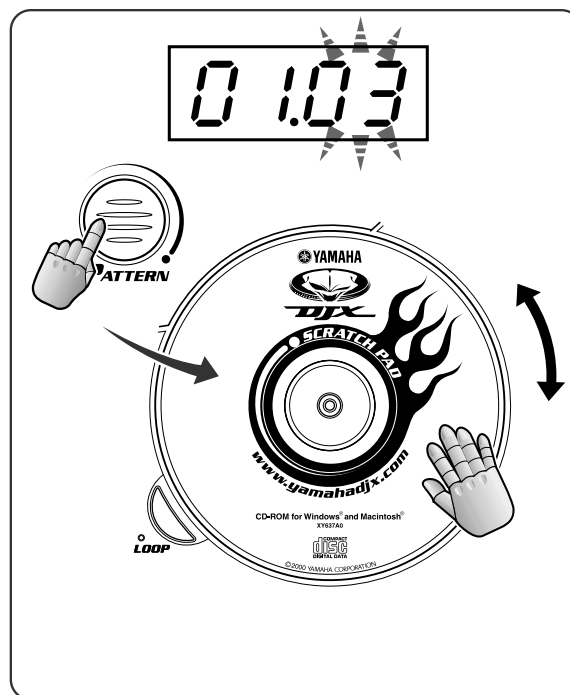

... and the bpm is set to best suit the selected Pattern.

Live Effector Basics

The effects of the DJX-IIB are more than just frosting on the cake — they're powerful tools that can completely transform the sounds and rhythms, and put a whole new spin on your tracks!

Tip 7 What is the Live Effector?



Here's where you can really get down and dirty with your beats!

The Live Effector gives you a wide variety of real-time effects that let you mangle and munge the sound in wild and exciting ways. All of the sounds of the DJX-IIB — the Patterns and the Scratches (→ page 26) — are processed by these versatile sound shapers. You can turn the effects on and off in time with the rhythm, and adjust a pre-programmed key effect parameter and the balance (depth) of the effect in realtime as the Pattern plays.

A continuously lit LED indicates that the effect is selected. When the effect is turned on, the LED flashes in time with the Pattern.



• **To keep the effect locked on:** Simultaneously hold the toggle switch on and press SELECT.

To "unlock" the effect, turn the effect on and off again.

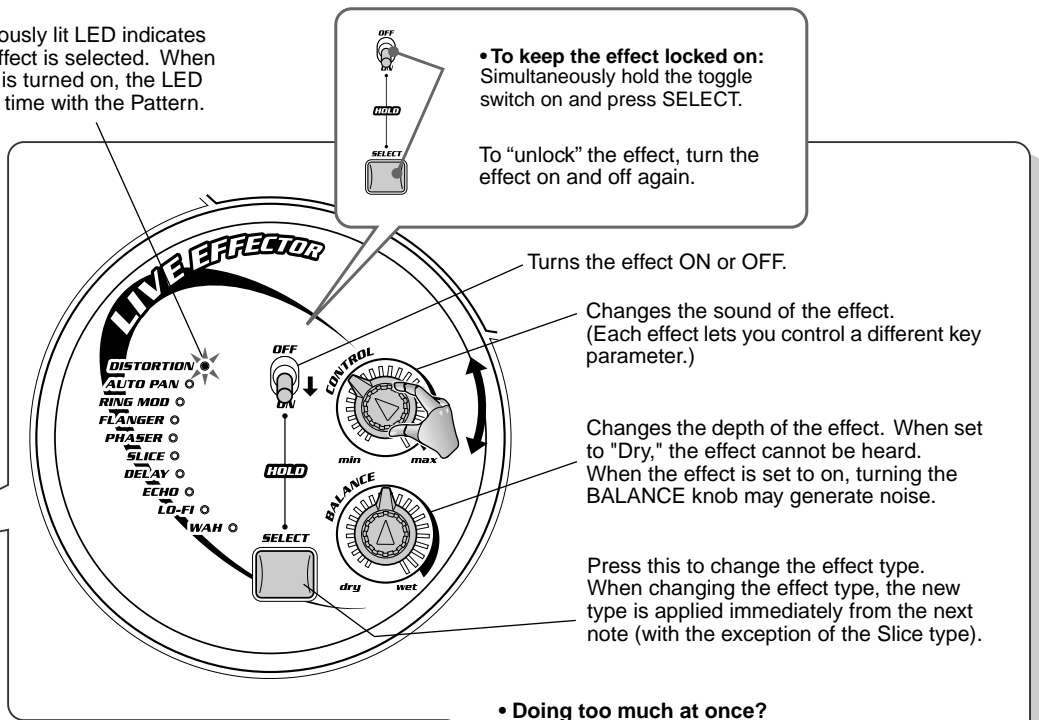

Turns the effect ON or OFF.

Changes the sound of the effect. (Each effect lets you control a different key parameter.)

Changes the depth of the effect. When set to "Dry," the effect cannot be heard. When the effect is set to on, turning the BALANCE knob may generate noise.

Press this to change the effect type. When changing the effect type, the new type is applied immediately from the next note (with the exception of the Slice type).

• **Doing too much at once?**

Changing the effect type while the effect is on and a Pattern is playing back and/or while you're playing the Scratch Pad can overload the processing power of the DJX-IIB. This could affect the sound in different ways, making the overall sound softer or changing the sound of the effect in unexpected or undesirable ways. For best results, stop the Pattern and/or stop playing the Scratch Pad briefly before changing the effect type. Better yet, turn the effect off briefly, then change the type and turn it back on again as needed.

◆ **Tech note:**

You can change the effect type while the effect is on in the "hold" condition; however, it cannot be changed when holding down the toggle switch manually.

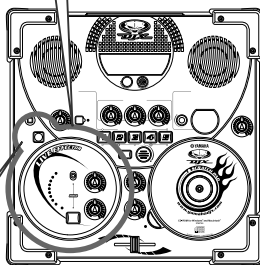

PATTERN STOP



- ① Start the Pattern.
- ② Select the desired effect, turn the Effect on, and twist the knobs.
- ③ Stop the Pattern.



Tip 8 Distortion

This popular effect lets you distort the sound — from a soft grunge to a full-on metallic assault. Turn the CONTROL knob to the right for more crunch and bite.

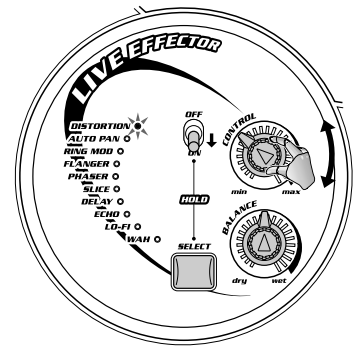

Tip 9 Auto Pan

Get your sound moving in space! This effect shifts the sound in the stereo image back and forth between hard left and hard right. Setting the CONTROL knob toward max speeds up the panning so much, the sound seems to be modulated — like on a synthesizer!

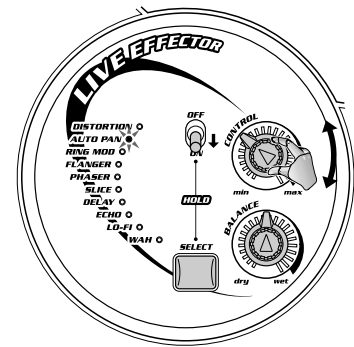

Tip 10 Ring Modulation

Here's an ultracool effect straight out of analog synthesizers! The Ring Modulator changes the sound dramatically by “overdriving” the oscillator — as set with the CONTROL knob. This effect can completely destroy the original pitch of the sound while generating a whole new set of pitches and harmonics, for a massively dynamic metallic sound. Use the CONTROL knob to change the frequency of the oscillator.

Use this sparingly! You'll want to save this awesome, powerful effect for certain climactic parts of your performance — and then blow people away!

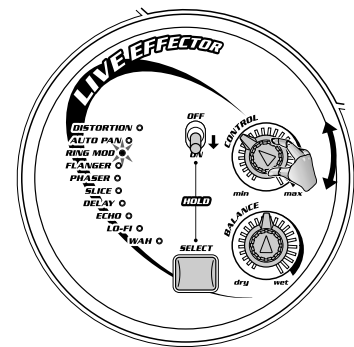

Tip 11 Flanger

This modulation-based effect produces a “swishing” or “tunneling” sound. Changing the speed of the modulation with the CONTROL knob produces a characteristic metallic, sweeping effect — much like a jet airplane taking off.

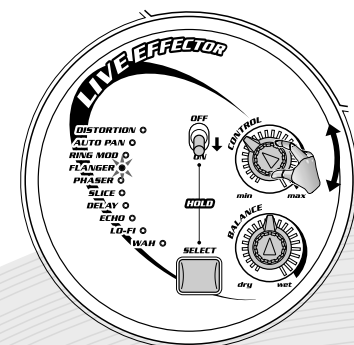

Tip 12 Phaser



The Phaser effect is similar to Flanger (in Tip 11 above), but more subtle — not quite as dramatic. Phaser is good for adding a little bit of warm animation and movement to the sound. Use the CONTROL knob to change the speed of the modulation.

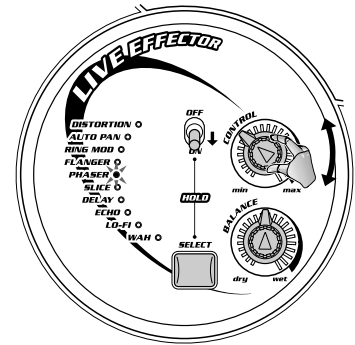

Tip 13 Slice



Chop up the beat, slice and dice — completely change the feel of the rhythm! Use the CONTROL knob on this happening effect to change the “slice” patterns, and come up with new rhythms on the fly!

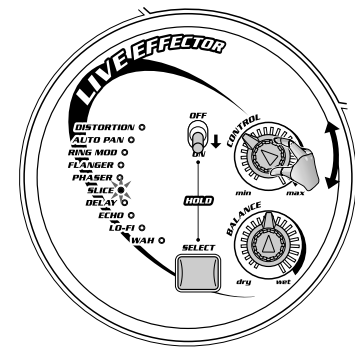

Tip 14 Delay



Delay is a popular effect that repeats the sound in rhythm. (There’s a related Echo effect; see Tip 15 below.) And check this out — no rocket science needed! The DJX-IIB automatically syncs the delay time to the current bpm, so you don’t even need to re-adjust the knob, even when the bpm is changed. Use the CONTROL knob to change the relative delay time to match the rhythmic effect you want. The DJX-IIB syncs to note values — 16th, 8th, 4th, triplet, etc.

◆ **Be careful** — changing the delay time (by changing the CONTROL knob or bpm) may result in some noise.

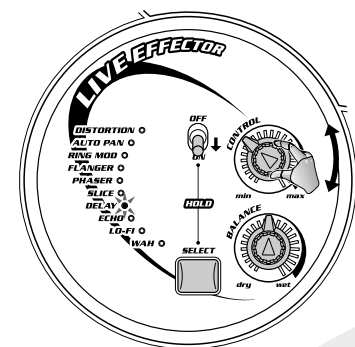



Tip 15 Echo

Like Delay (in Tip 14 above), Echo produces repeats of the sound for rhythmic effect. However, the CONTROL knob is used to change the number of repeats (also called “feedback”). Naturally, the DJX-II B automatically syncs this effect to the bpm of the Pattern.

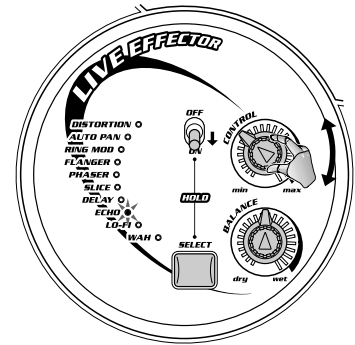

Tip 16 Lo-Fi

Need to grunge up your sound, but Distortion is too nasty for you? This useful effect lets you slap that retro, lo-rez sound onto your beats — just like they do in hip-hop, trip-hop and other styles. Lo-Fi gives the sound just a little bit of “dirt” — and lets you add a vintage analog-like touch to your performance.

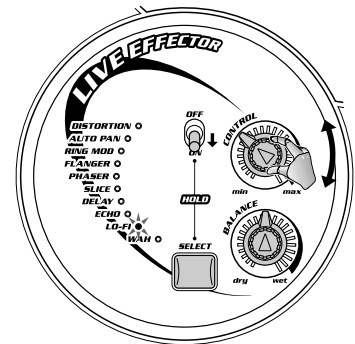

Tip 17 Wah

Wah is a special moving filter effect that gives a funky feel to the sound. Use the CONTROL knob to change the speed of the filter motion. Setting this toward the maximum produces a trembling sound.

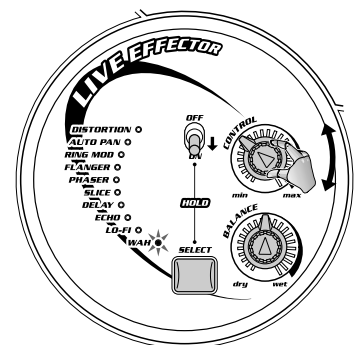

Isolator Basics

More sonic control to you! The Isolator lets you tailor the sound just the way you want it — phat and round, thin and edgy, or big and banging!

Tip 18 Tweak the sound just right!



Need a beefier low end? Want to put some edge and shimmer in the top? Tweak these knobs to your heart's content, and get the sound just the way you want it! Try turning the Low and High knobs of the Isolator a little bit to the right, and make the sound more punchy. Try other settings as well to get the sound just right!

Each of these knobs boosts or cuts a general frequency band of the sound. Technically, the range for each knob is -12dB to +12dB.

◆ **Be careful with this, though** — if the Master Volume is at or near the max, boosting these frequencies can result in some nasty distortion!

◆ **Helpful hint:** Avoid boosting the level (when possible). For example, if you want to emphasize the highs and lows, add a gentle mid cut instead.

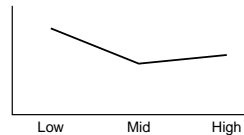
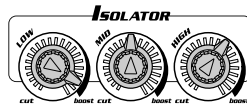
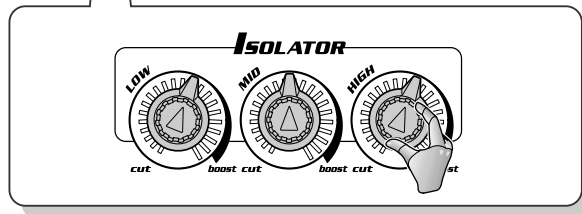
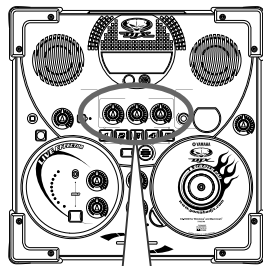

Boosted low end, slightly crisper high end.

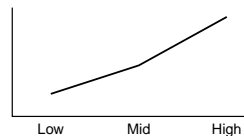
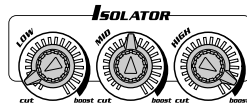

Very tinny sound — almost no bass, very bright and brittle high end.

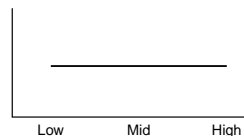
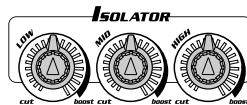

Flat response — normal settings.

Filter Basics

Pump up the energy on the dance floor a serious notch or two with these powerful filter tools!

Tip 19 Cutoff and Resonance



The CUTOFF and RESONANCE knobs control the filter effects. And what are “filter effects,” you ask? Well, filters have been used for a long time with analog synthesizers, and in the right hands they are capable of turning static, boring sounds into something really dynamic and animated.

Turn CUTOFF to the left and the sound becomes darker or “muffled.” Turn CUTOFF to the right and the sound becomes brighter. The RESONANCE knob controls how sharp the peak of the filter is. Turn RESONANCE to the right and the filter peak becomes sharp and pronounced. Turn the RESONANCE left and the filter becomes flat.

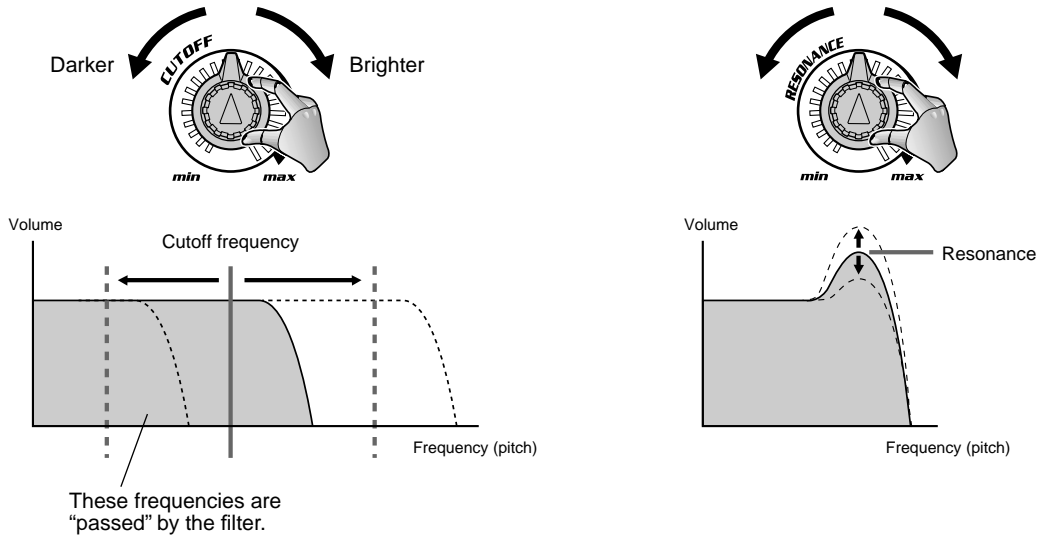

Try tweaking CUTOFF while RESONANCE is at about 2 or 3 o'clock (see below). The filter becomes sharper, and you can actually hear the filter peak moving according to the CUTOFF knob position.

There’s no way to adequately describe this effect in words — you just have to try it out for yourself, and hear how awesome it can make your music sound!

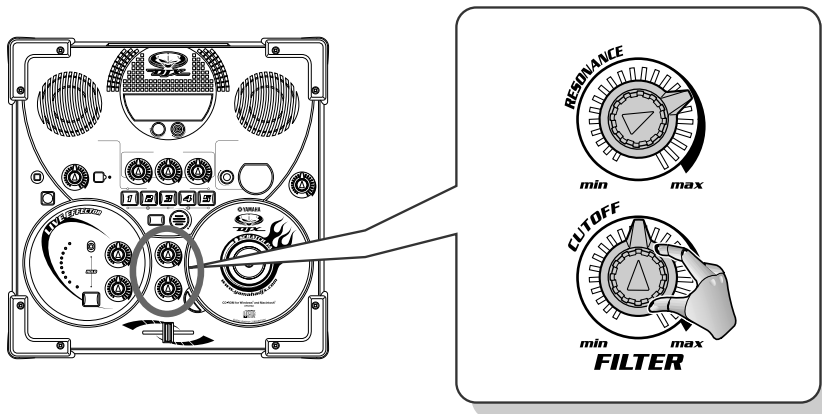

Scratch Pad Clinic

The true mettle of a DJ is in his or her turntable work. That's why the DJX-IIB has a special Scratch Pad that lets you strut your stuff!



20 Work out on the Scratch Pad!



Step up to the turntable and work the platter like a real DJ! That's what the Scratch Pad's for!

Set the Crossfader to around the center, then rock the Scratch Pad back and forth. Now you're scratching!

Start a Pattern and work the Scratch Pad while the Pattern's playing back — adding your own rhythmic parts and accents to the mix!

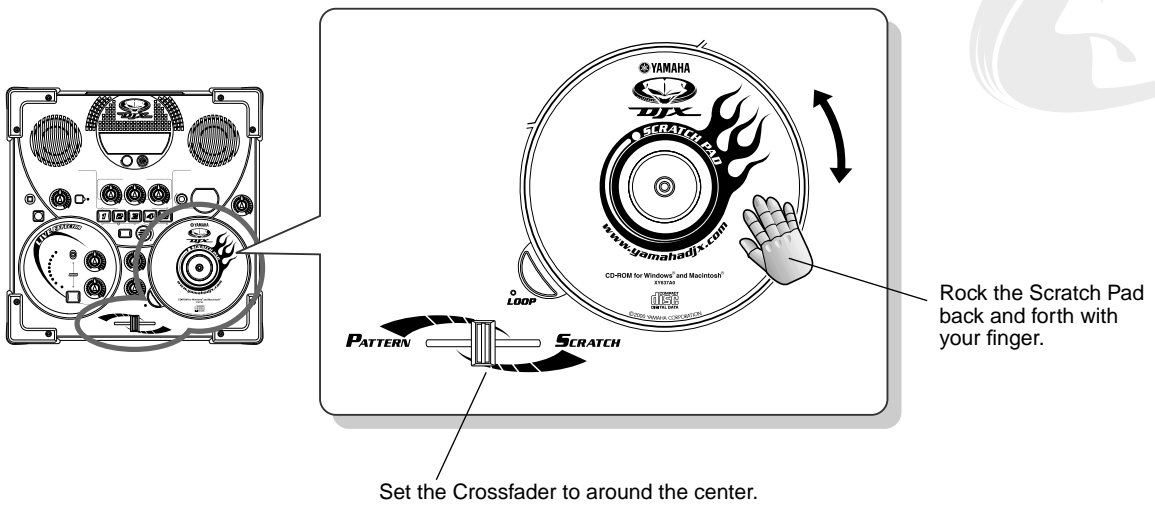

No need for vinyl here — leave your records at home! The DJX-IIB has a whopping total of 73 special Scratch “kits” that you can call up instantly and scratch right along with the Patterns!

To change the Scratch kit, hold down the SCRATCH button and simultaneously turn the Scratch Pad. Check the Scratch display to see what you're selecting.

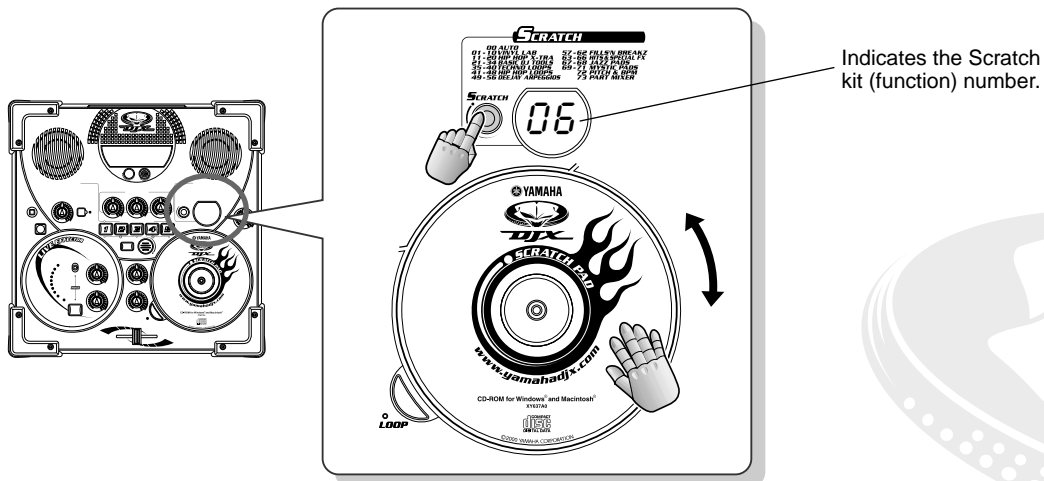

● **Scratch List**

The Auto kit (0) automatically selects a kit to best match the currently selected pattern.

No.	Category Name	Scratch Name	No.	Category Name	Scratch Name	No.	Category Name	Scratch Name
0	AUTO	Auto	21	BASIC DJ TOOLS	Basic DJ Tools 1	49	DEEJAY ARPEGGIOS	DeeJay Arpeggios 1
1	VINYL LAB	Vinyl Lab 1	22		Basic DJ Tools 2	50		DeeJay Arpeggios 2
2		Vinyl Lab 2	23		Basic DJ Tools 3	51		DeeJay Arpeggios 3
3		Vinyl Lab 3	24		Basic DJ Tools 4	52		DeeJay Arpeggios 4
4		Vinyl Lab 4	25		Basic DJ Tools 5	53		DeeJay Arpeggios 5
5		Vinyl Lab 5	26		Basic DJ Tools 6	54		DeeJay Arpeggios 6
6		Vinyl Lab 6	27		Basic DJ Tools 7	55		DeeJay Arpeggios 7
7		Vinyl Lab 7	28		Basic DJ Tools 8	56		DeeJay Arpeggios 8
8		Vinyl Lab 8	29		Basic DJ Tools 9	57	FILLS 'N BREAKZ	Fills 'n Breakz 1
9		Vinyl Lab 9	30		Basic DJ Tools 10	58		Fills 'n Breakz 2
10		Vinyl Lab 10	31		Basic DJ Tools 11	59		Fills 'n Breakz 3
11	HIP HOP X-TRA	Hip Hop X-tra 1	32		Basic DJ Tools 12	60		Fills 'n Breakz 4
12		Hip Hop X-tra 2	33		Basic DJ Tools 13	61		Fills 'n Breakz 5
13		Hip Hop X-tra 3	34		Basic DJ Tools 14	62		Fills 'n Breakz 6
14		Hip Hop X-tra 4	35	TECHNO LOOPS	Techno Loops 1	63	HITS & SPECIAL FX	Hits & Special FX 1
15		Hip Hop X-tra 5	36		Techno Loops 2	64		Hits & Special FX 2
16		Hip Hop X-tra 6	37		Techno Loops 3	65		Hits & Special FX 3
17		Hip Hop X-tra 7	38		Techno Loops 4	66		Hits & Special FX 4
18		Hip Hop X-tra 8	39		Techno Loops 5	67	JAZZ PADS	Jazz Pads 1
19		Hip Hop X-tra 9	40		Techno Loops 6	68		Jazz Pads 2
20		Hip Hop X-tra 10	41	HIP HOP LOOPS	Hip Hop Loops 1	69	MYSTIC PADS	Mystic Pads 1
		42	Hip Hop Loops 2		70	Mystic Pads 2		
		43	Hip Hop Loops 3		71	Mystic Pads 3		
		44	Hip Hop Loops 4		72	PITCH & BPM	Pitch & BPM	
		45	Hip Hop Loops 5		73		PART MIXER	Part Mixer
		46	Hip Hop Loops 6					
		47	Hip Hop Loops 7					
		48	Hip Hop Loops 8					

Tip 21 Quarter-note scratching



Now that you've tried out the Scratch Pad and some different Scratch sounds, let's get started using the Scratch Pad in real musical examples.

Quarter notes are the simplest to scratch in time with, since you simply scratch on every downbeat. In this example, select P12 and start up V A1. Rock the pad forward (clockwise) on the first downbeat, then rock it back (counter-clockwise) on the second downbeat, and so on. Notice that the scratch sound is actually a musical part that changes with the chords in the Pattern. Tap your foot or your heel with the beats (count out loud if you want, too!), and try to hit each beat with a scratch! Try different scratch "lengths" as well — for example, scratching forward for a short 1/8 turn, and back for a long 1/2 turn. Stay on the beat!

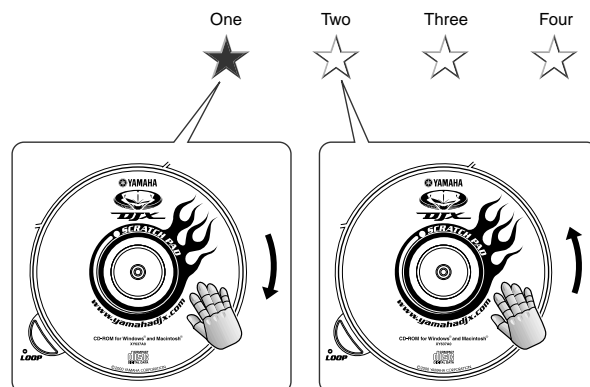



22 Eighth-note scratching



Once you've mastered quarter-note scratching, eighth notes are real easy! Just double up your scratching and play two scratches (forward and back) on every beat! For this example, call up P39 and play V B5. For your scratching, try out Scratch 01 and rock the pad back and forth in short 1/8 turns.

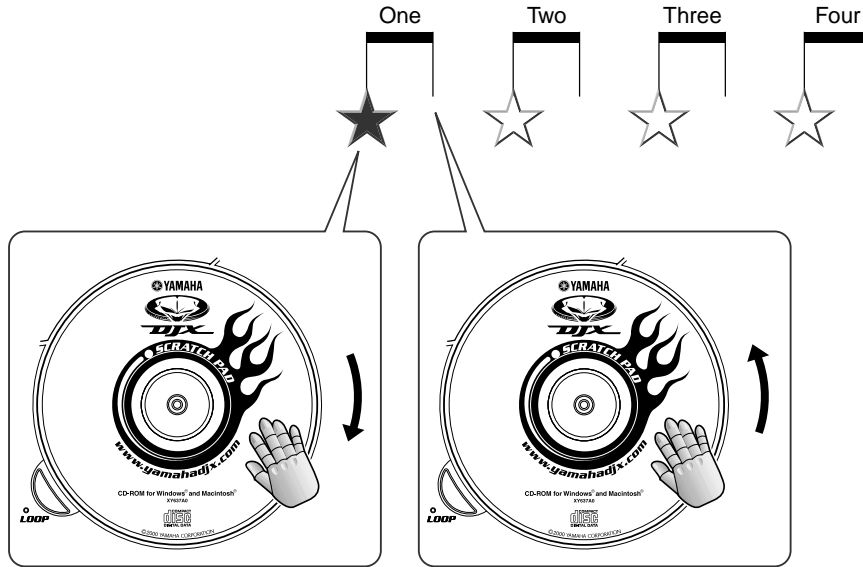

23 Sixteenth-note scratching



Now let's go a little bit faster. Since sixteenth notes are half the value of eighth notes, you'll have to play twice as fast! This means four scratches (forward-back-forward-back) on every beat. For this exercise, call up P41 and play V A1. For an alternate scratch, try out Scratch 13 and (like in Tip 22 above) work the pad in short 1/8 turns.

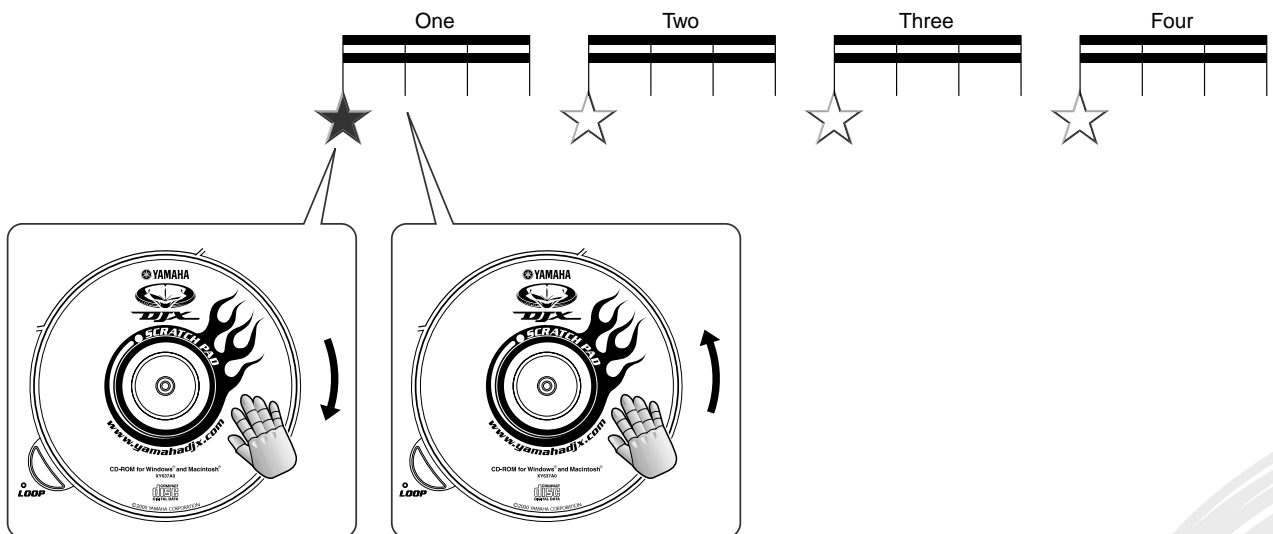

Slow down the bpm (Tip 39) if necessary — this will let you lock into the rhythm more easily.



Tip 24 Shuffle feel

Here things get a bit tricky! But don't worry — once you feel the rhythm, you'll have no trouble playing it!

Shuffle rhythms are a cornerstone of hip-hop music, and feature a heavy “swing” feel. Scratching to this rhythm is tricky since the forward scratch and backward scratch are not even — you'll have to do one slower than the other!

To get you into this, select P36 and start V B1. Try locking into the hi-hat groove — that's where the shuffle is!

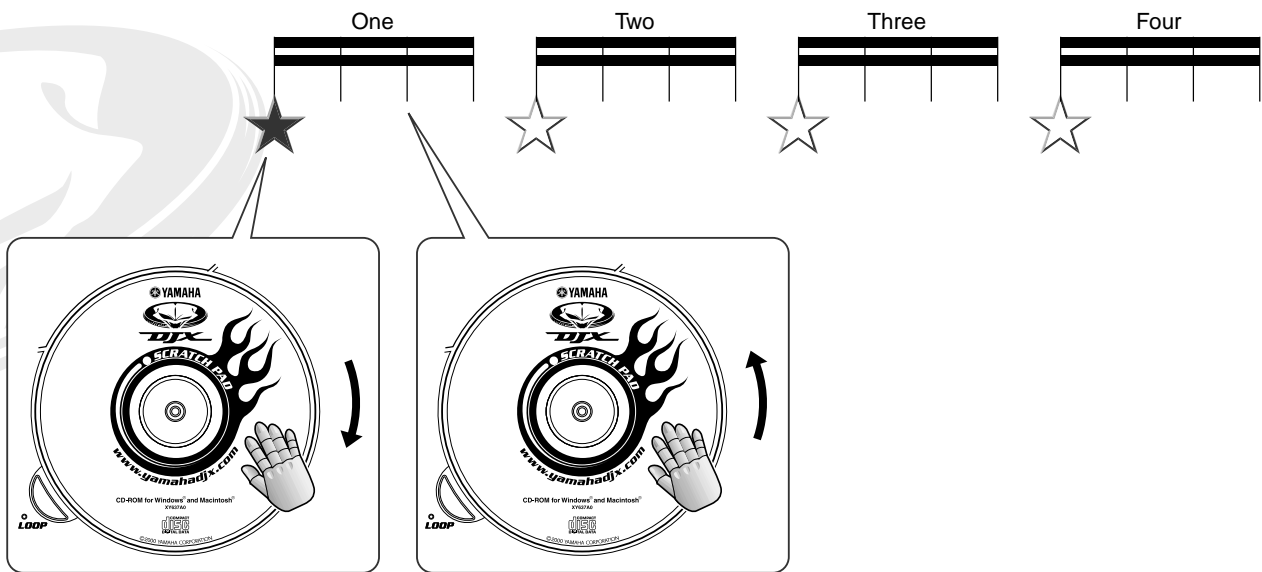

Tip 25 Triggering drum loops from the Scratch Pad



A common DJ technique is to scratch a vinyl loop a couple of times, then let the rhythm play. On the DJX-IIB, you can do the same thing!

Call up Scratch 01 and press the LOOP button (the lamp lights). Now, give the Scratch Pad a light push or pull, and the drum loop starts!

To stop the drum loop, press LOOP again (or press PATTERN STOP).

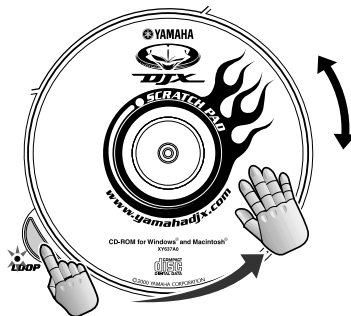



26 Scratch Pad arpeggios



The Scratch Pad has so much more than just scratch sounds! For some examples of how musical you can get with the Scratch Pad, check out the Arpeggiator kits.

Try this out! Select P29 and start V A3. Call up Scratch 49. Now the Scratch Pad plays arpeggiated phrases in time with the rhythm. Mix the arpeggios in with the Pattern and create your own sophisticated, multi-textured arrangements! You can keep the arpeggios playing indefinitely — even when the Scratch Pad is stopped — by pressing LOOP. Try working the Scratch Pad in different ways — rotating the pad in full turns, and changing speed, too. Notice how the arpeggios get higher or lower in pitch, depending on how fast you turn the pad!

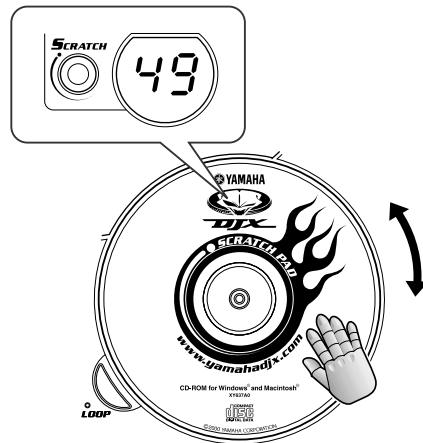

27 Scratch Pad sound effects



The DJX-IIB's Scratch Pad has a slew of special sound effects you can fly into your tracks and give your mixes a unique, dynamic touch.

Select Scratch 63. Turn the Scratch Pad clockwise to get one sound effect, and turn it counter-clockwise to get a different sound!

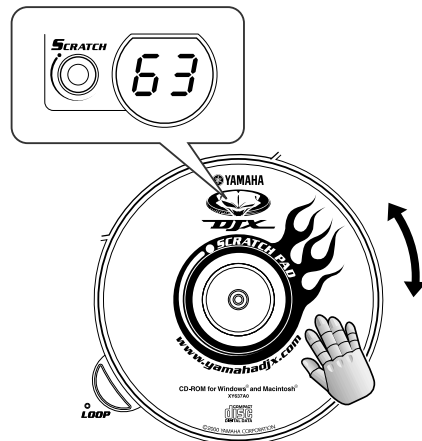

28 Scratch low, scratch high...



The pitch of the Scratch Pad depends on how fast you scratch — just like a real turntable!

To get real low and grainy, turn the pad real slowly. For an edgy, high-pitched scratch, move the pad fast. Play around with this, and experiment with different Scratch kits!

Tip 29 Stop the turntable



You've heard the effect — where the whole track drops in pitch and slows down to a grinding halt! Guess what — you can do the same thing on the DJX-IIIB, and have fingertip control over it, too!

Select Scratch 72. This assigns the Scratch Pad to control both pitch and bpm simultaneously. Spin the pad counter-clockwise — and hear the pitch go down and the bpm slow down. Naturally, the bpm value is shown in the display as well. Turning the pad continuously until the display shows “- - - -” brings everything to a grinding halt — just like turning off the power on a turntable!



Press the LOOP button, and the “turntable” starts up again! The Pattern starts at low pitch and bpm, and quickly works its way back up to speed. An awesome effect that cranks up the excitement factor a couple more notches!



In a variation on this, try spinning the pad clockwise slowly a few turns to bring the pitch and speed up, then press LOOP. This gives you a more gradual build-up.

Tip 30 Give the Scratch Pad a new face!



Sure, this tip doesn't change the sound — but you CAN give the Scratch Pad a new look by swapping discs!

If you've got a CD or CD-ROM disc with a design you like, you can easily attach it to the Scratch Pad platter. For instructions on how to do this, see “Changing the Scratch Pad CD” on page 10.

Tip 31 CD-ROM goodies



The CD-ROM on the Scratch Pad actually contains a wealth of interesting and useful stuff for your DJX-IIIB! It's compatible with both Windows 95/98 and Macintosh, and features the toys and tools listed below.

DJX-II/IIB Premium CD-ROM

- Live Movie at DJX Satellite
- DJX-II/IIB Function Guide — a fun way to get to know the DJX-IIIB and its features!
- Pattern Launcher Application — for loading new Patterns to the DJX-IIIB!
- Extra Patterns — a selection of specially programmed new Patterns you can load to your DJX-IIIB!

Part Mixer Basics

Now that you've got your rhythm chops up to speed and some DJ tricks up your sleeve, it's time to work on the Parts! This chapter gives you the keys to improvising interesting arrangements and instrumental textures. Not to mention creating some slammin' and smokin' tracks!

Tip 32 What is a Part?



The DJX-IIB Patterns are made up of several different instrument Parts: Kick, Snare, Hi-Hat, Percussion, Bass, and pitched Phrases. Each Part has its own unique function and sound within the rhythm.

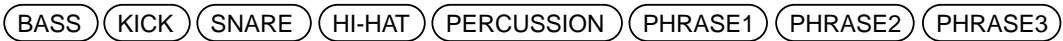

The Part Mixer puts you in the producer's seat — it lets you throw Parts in and drop Parts out in real time with the Scratch Pad, allowing you to arrange on the fly!

Part Mixer is contained in the Scratch kits — just select Scratch 73. (If Scratch 00 is currently up, simply hold down SCRATCH and turn the Scratch Pad back a “notch” to 73!)

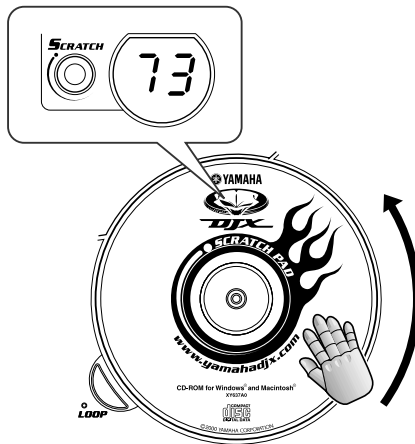

Tip 33 Take the console and remix the Parts!



Step up to the mixer and start juggling the arrangement around! When the Part Mixer “kit” is called up (see Tip 32 above), you can mute certain Parts by turning the pad counter-clockwise about 1/4 turn or 90°. Likewise, if you've taken Parts out, you can bring them back in by turning the pad back clockwise by the same amount.

◆ **Tech note** The specific Parts that are muted and the order in which they are brought in and out of the mix differs according to the selected Pattern.

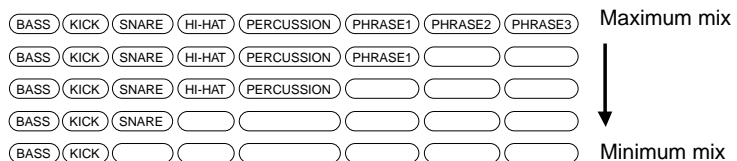
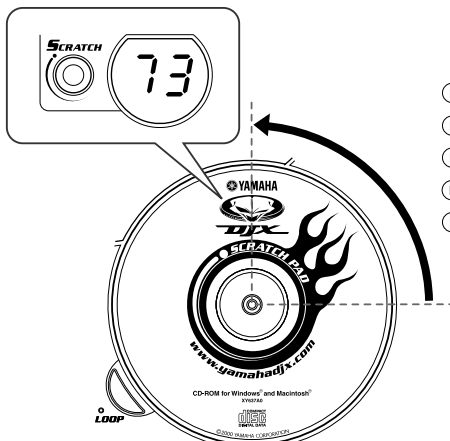

Each 1/4 turn goes forward or back one “step” in the Part Mix arrangement. Turning the pad around a full 360° counter-clockwise instantly takes the mix down to the minimum. Turning it 360° clockwise restores the maximum mix.

◆ **Helpful hint:**

If you've muted several Parts, you can turn them all back on again instantly! Simply press LOOP — do this on the “one” downbeat — and the whole rhythm kicks in at once!

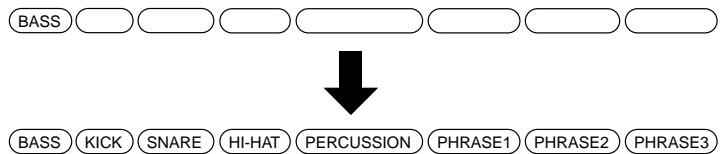
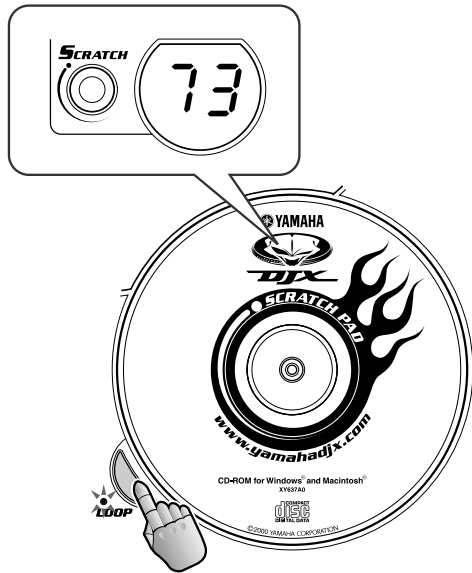

Tip 34 Extra texture!



Work on your instrument textures. All the mixmasters and mixologists do it! Why? Because it works like a charm!

Here's a specific example to get you started. Select P05. Before starting the Pattern, spin the pad counter-clockwise two full rotations. (Make sure Part Mixer is selected!) This takes the Part mix down to the bare bones! Now, start V A1.

Let the Pattern carry on for a while. Then turn the pad clockwise 1/4 of the way to change the texture. Keep doing this, letting each instrument group play for a while before bringing in the next. Also, try going back — turning the pad counter-clockwise to take Parts out of the mix. Then, when you want to get all the Parts happening, simply press LOOP (as in the “Helpful hint” in Tip 33 above).

Experiment with this — on the example Pattern and others — and let your ears be the judge. Above all, have fun! After all, this is the way the pros build up the sound.



Crossfader Basics

The DJX-IIB has a feather-touch Crossfader — just like those found on real DJ mixers — that lets you crossfade between your beats and your scratching!

Tip 35 Work the Crossfader!



This short-throw, feather-touch Crossfader gives you easy and fast control over the Pattern/Scratch balance. The center spot has a lot of leeway and is very forgiving — just get the Crossfader somewhere near the middle and the level balance is equal. To hear only the Pattern, move the fader all the way to the left; to hear only the Scratch, move it all the way to the right.

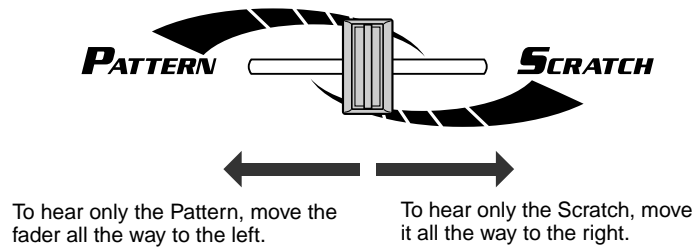

◆ **Helpful hint:**

Want to work the Crossfader the opposite way — with the Scratch Pad sound on the left and the Pattern sound on the right? If you feel more comfortable with that arrangement, this operation's for you!

Simultaneously hold down the SCRATCH button and turn the power on. This reverses the operation of the Crossfader. To restore normal operation, simply turn the power off and back on again as usual.

Tip 36 Mute the Pattern



Sometimes you'll want to cut the Pattern out of the mix — maybe to work out on the Scratch Pad for a while — then bring it back in instantly. The Crossfader is a great way to do this — fast and easy!

Simply move the fader all the way to the right — preferably just before the “one” downbeat. To bring the Pattern back in from the “one,” flip the Crossfader back to the left and hit the Pattern button, all in one motion.

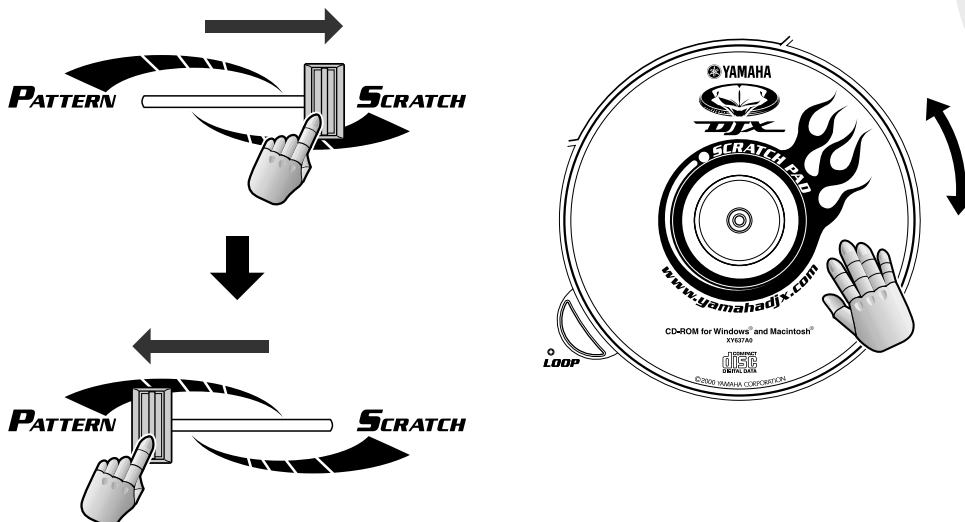



Tip 37 Crossfader cuts

This is one of the most basic moves in the DJ's collection of Crossfader techniques — cutting in with a scratch.

Hit a Pattern and keep the Crossfader all the way to the left so that only the Pattern is heard. While the Pattern is playing, work the Scratch Pad (even though you can't hear it). Whip the fader to the right and then back left quickly. If you do it right, you'll get a brief hit of the scratch — without interrupting the flow of the rhythm!

Once you get the hang of it — and you think your scratching chops are up to it — try working the Scratch Pad only when you flick the Crossfader!

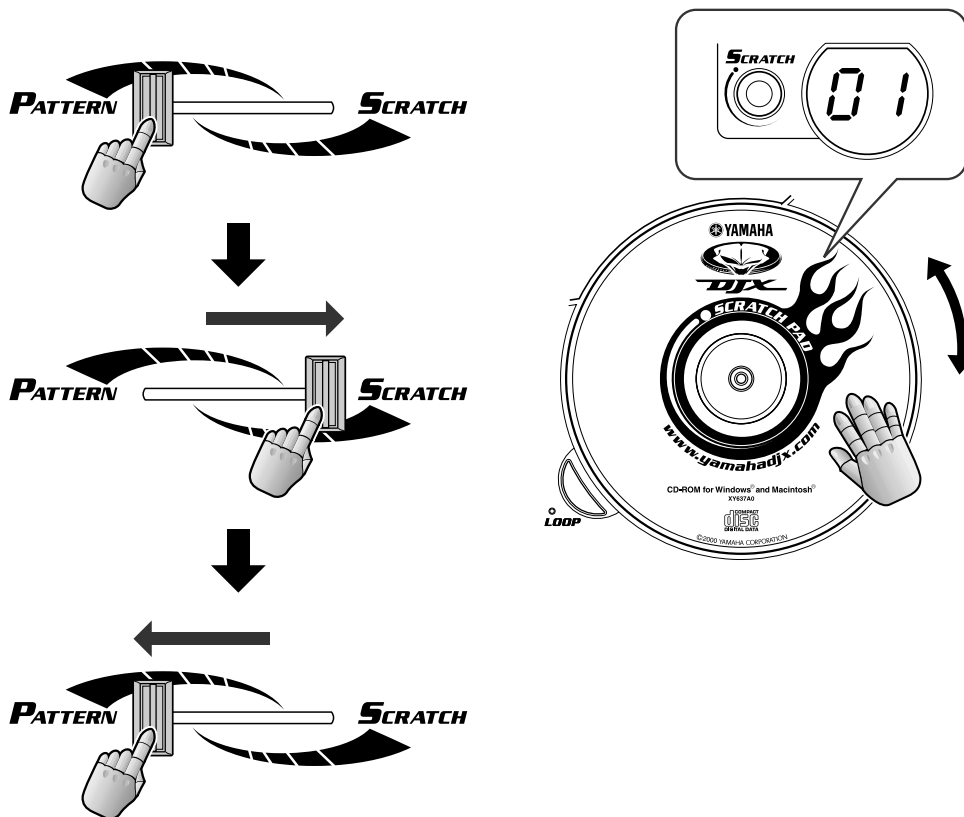

Chapter 8

Intermediate Techniques

This chapter is a grab bag full of various tips that solidify your DJ chops and put you on your way to really mastering the instrument! Take your time and get these down before moving on to Chapter 9...

Tip 38 Transpose the key



The Key Shifter section of the DJX-IIB lets you take the pitch (or “key”) of the overall sound, and transpose it up or down — instantly!

Believe it or not, changing the key of the overall sound makes subtle but fundamental changes to the character of the sound as well. Use higher keys (+1 to +6) to make the sound more tense or brighter, and use the lower keys (-1 to -5) to make the sound more relaxed and subdued.

To change the key, hold down the KEY SHIFTER button and simultaneously turn the Scratch Pad. The amount of shift is shown in the display (-5 to 0 to +6, with 0 being normal pitch). Keep holding down the button until the point at which you want to change key, then release it — the key changes to the new setting instantly!

Key Shifter is especially convenient when you’re using the DJX-IIB with an external sound source, such as CD or vinyl — letting you match the key of the Pattern to the key on the external source!

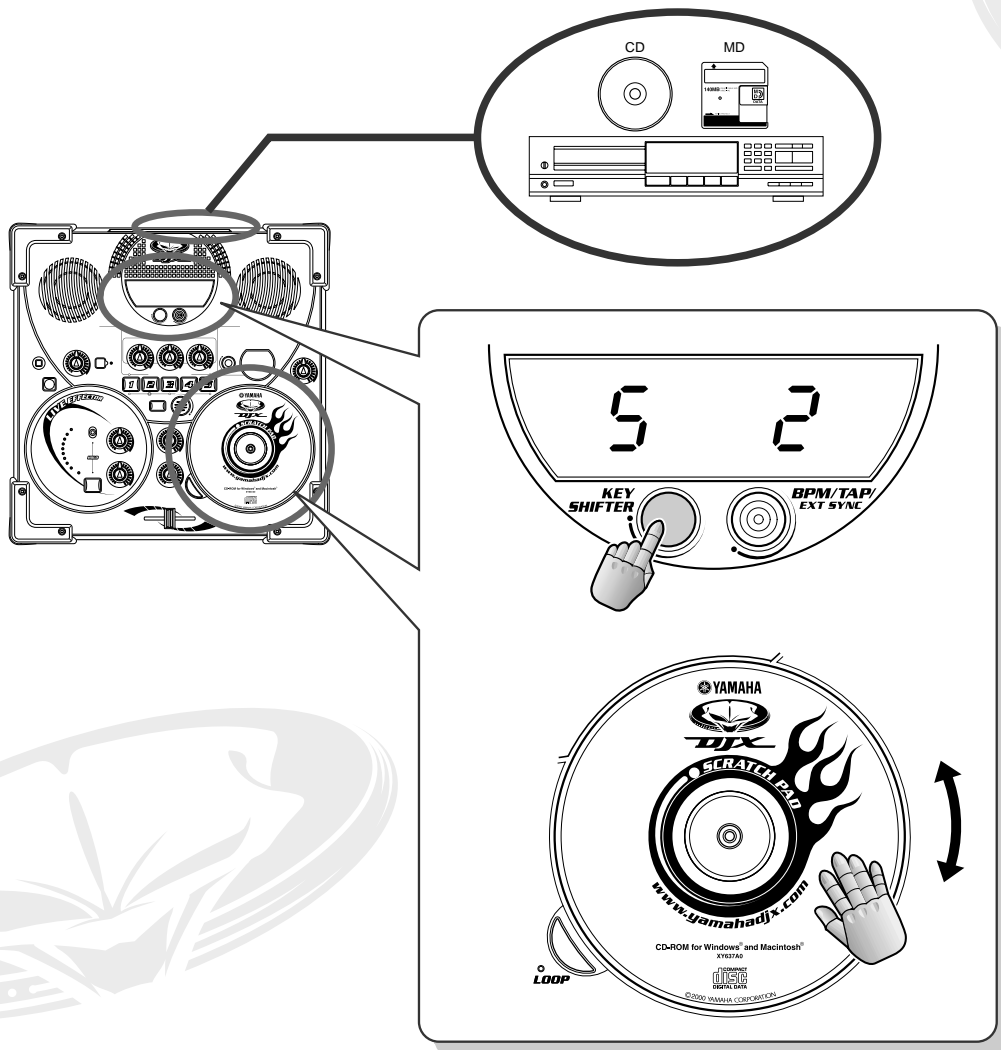

Tip 39 Change the bpm



Another sure-fire way to stir things up is to play with the bpm. Turn up the bpm and turn up the heat!

Press BPM/TAP once and turn the scratch pad. For you techies, the bpm range is 32.0 - 280.0. try starting the Pattern at a slower-than-normal bpm, then gradually bring the bpm up in speed to get the groove really happening!

◆ **Be careful!** If the Pattern is stopped and you turn the scratch pad past 280.0, "Sync" appears in the display and the DJX-IIB goes into the Sync Mode (see page 66). To get out of this mode, simply turn the scratch pad clockwise, until bpm values appear in the display again.

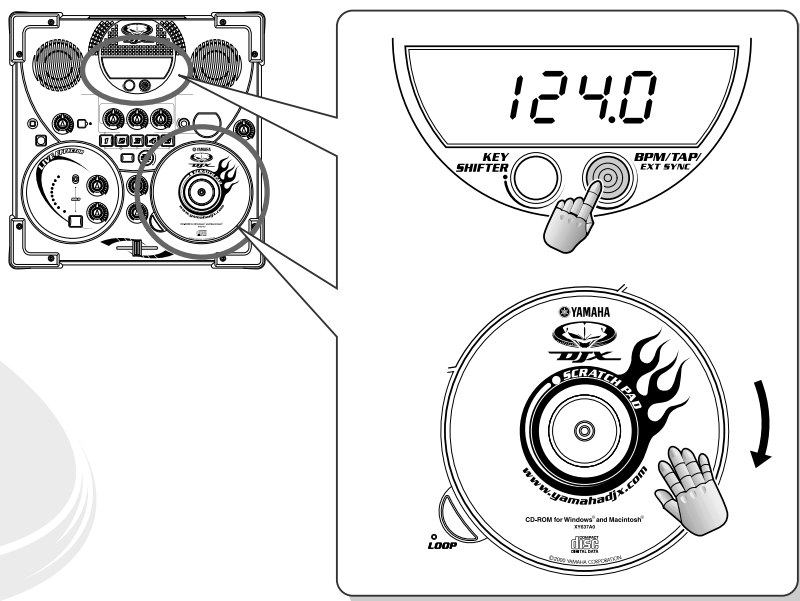

Sync Mode (page 66).
(Only selectable when Pattern is stopped.)

Tip 40 Reset to the default bpm



Want to get back to the original pre-programmed default bpm? Simply press and hold down BPM/TAP — and the bpm of the currently selected Pattern is instantly reset to its original speed.

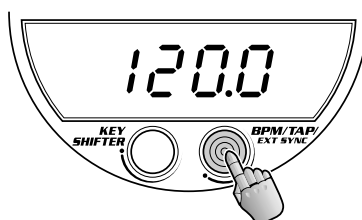

Tip 41 Fade in, fade out



Easy, but effective! Simply use the MASTER VOLUME dial to create your own smooth fade-ins and fade-outs. One specific trick you can try is to fade out a Pattern down to silence, then quickly bring MASTER VOLUME up to normal and burst in with a new Pattern!

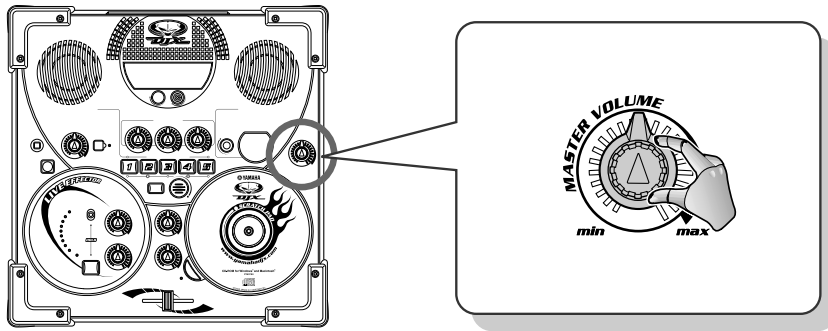

Tip 42 Travel light!



Small and light, the DJX-IIB is made for the road! And with the two special hooks fastened onto the bottom of the unit, just slap on a guitar strap — and you're ready to go!

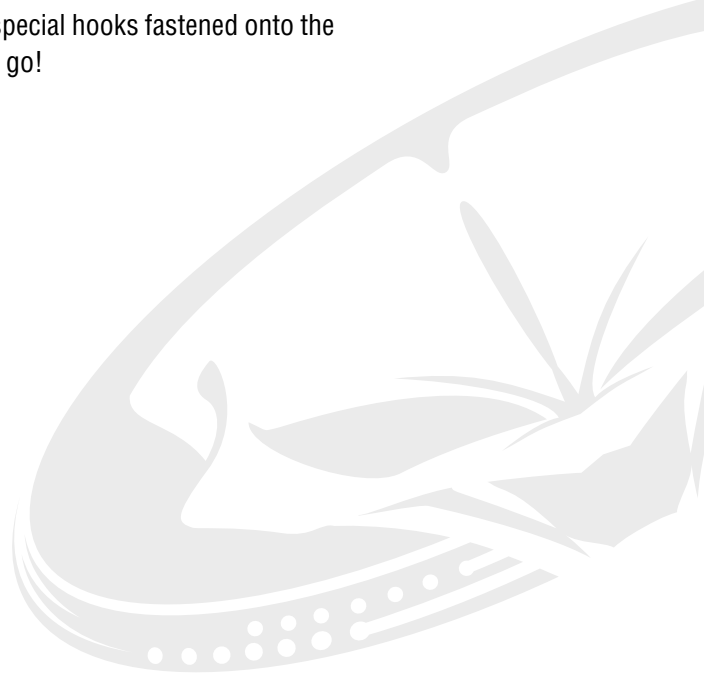
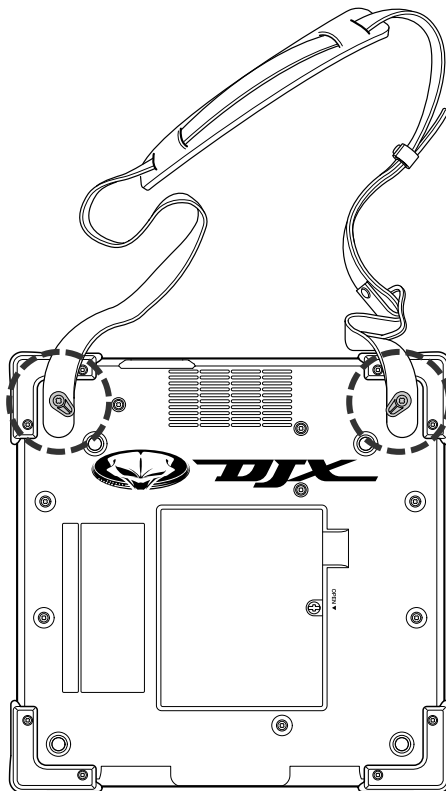



Tip 43 Tweak the cutoff

Select P06 and start V A1. Set RESONANCE to about 2 or 3 o'clock, then slowly turn the CUTOFF knob to create a slow sweeping effect. Twiddle the knob back and forth quickly and create a wah-wah like trembling effect.

PATTERN PLAYER

1 2 3 4 5

A/B BANK PATTERN

① Start the Pattern.

RESONANCE

min max

② Set RESONANCE to about 2 or 3 o'clock.

CUTOFF

min max

FILTER

③ Turn the CUTOFF knob.

PATTERN STOP

④ Stop the Pattern.



Tip 44 Wah-wah scratching

Here's a cool effect you can use to funkify your tracks! It's like running a turntable through a wah-wah pedal. The settings suggested here work especially well with Scratch 01, but you may want to experiment with other settings when using other Scratch kits.

Set RESONANCE to max then turn the CUTOFF knob back and forth between 7 and 10 o'clock while playing the scratch sound. Try to keep the groove — both in your scratching and your knob turning!

RESONANCE

min max

CUTOFF

min max

FILTER

YAMAHA

DJK

SCRATCH PAD

www.yamahadjax.com

CD-ROM for Windows® and Macintosh®

YX527A0

DJS

SERVO MOTOR

©2000 YAMAHA CORPORATION

Tip 45 Warped vinyl and a cheap turntable!



A lot of dance styles call for a lo-fi, analog sound. This simple trick lets you mimic the wow and flutter of a warped record — or a bad turntable!

Select Scratch 72 to call up the Pitch & bpm “kit” — this lets you speed up and slow down the Pattern. While the Pattern is playing, move the Scratch Pad back and forth slowly and over a short distance — just enough to waver the pitch up and down a little. For even greater lo-fi “realism,” try using the Lo-Fi effect (Tip 16).

Tip 46 Scratch Drum Loops in sync



Here’s a real convenient feature! You’ll never have to worry about your Scratch Pad Drum Loops drifting out of time — the DJX-IIB automatically matches up the bpm of the loops to the bpm of the Pattern. (For information on playing Drum Loops, see Tip 25.)

However, the DJX-IIB can’t sync up your loops if you don’t play them on time! Be careful to turn the Scratch Pad right on the beat — just as you did with the Patterns. If you don’t hit LOOP in rhythm, just press it again to turn it off, then try again!

Tip 47 Mute the Scratch



The Scratch Pad is a sensitive little beast — even the slightest touch can put a scratch in your mix. For those times you want to make sure the scratching stays out of the way of the Pattern, move the Crossfader all the way to the left.

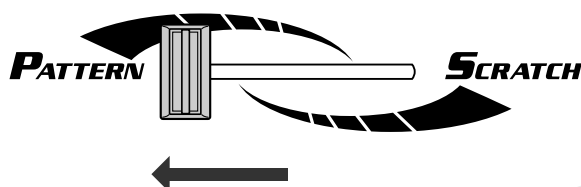

Pattern Player Power Tips



48 Hitting a new Pattern and Variation – at the same time!



There will be times when you'll want to change not only to a new Pattern, but to a specific Variation — instantly and at the same time. Here's the best way to do that!

First, simultaneously hold down PATTERN and turn the Scratch Pad to call up the new Pattern number. Remember to keep holding down PATTERN! Then — just at the “one” downbeat in the Pattern — press the desired Pattern button. Both the Pattern number and the Variation number change simultaneously.

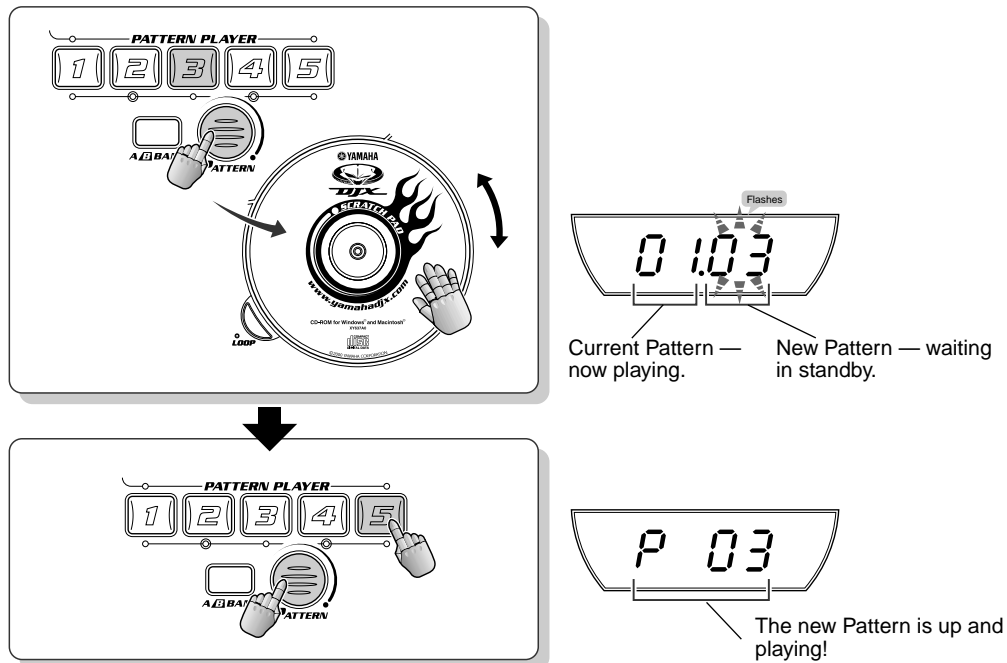

49 Hitting a new Pattern, Bank and Variation – at the same time!



Here's a sophisticated twist to Tip 48 above — changing the Bank along with the Pattern and Variation!

First, simultaneously hold down PATTERN and turn the Scratch Pad to call up the new Pattern number. Remember to keep holding down PATTERN! Next, press the A/B BANK button. Finally (without releasing the PATTERN button), press the desired PATTERN PLAYER button — just at the “one” downbeat in the Pattern. The Pattern number, the Bank and the Variation number all change simultaneously!

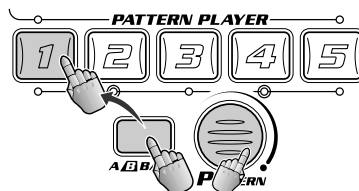

Tip 50 Break to a new Pattern!



One sure-fire method to turn up the heat on the dance floor is to use a break or a drop-out just before hitting a new Pattern! Here, we'll try dropping everything out for a full measure (four beats).

While the first Pattern is playing, count the beat in your mind and tap it out with your heel — to make sure you're locked into the groove! At the same time, call up the new Pattern by simultaneously holding down PATTERN and turning the Scratch Pad. Remember to keep holding down PATTERN! Then — right on the “one” downbeat — press PATTERN STOP. Keep counting while you hold the button — 1 - 2 - 3 - 4! Finally, on the next “one,” press the desired Pattern button.

Try this out with P08, V A4 as the first Pattern (good for a four-beat intro!), and break to P09, V A1.

As always, timing is everything! Whether you break for one beat, two beats, or four — make sure you come in with the next rhythm right on the “one”!

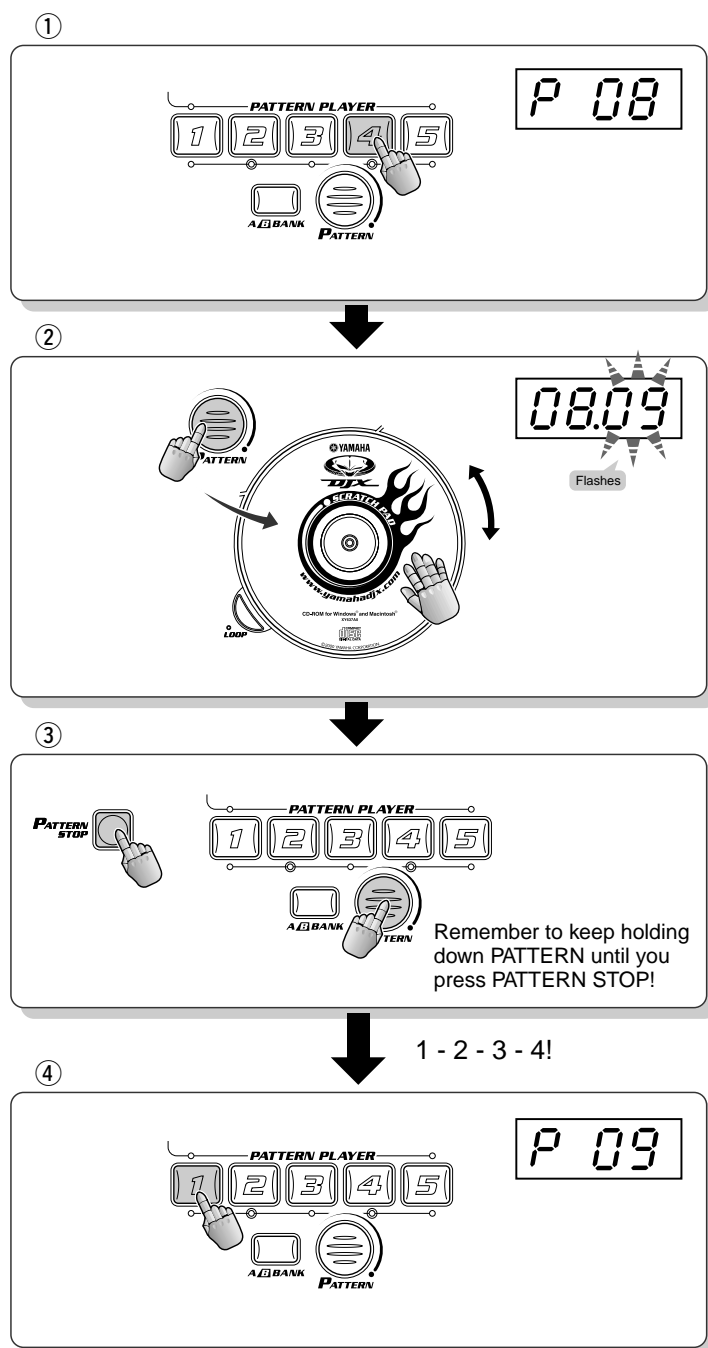

Tip 51 One-bar Patterns – all in a row!



Nearly all of the DJX-IIB's Patterns change every bar (four beats). Some loop in two-bar patterns, some loop every four bars. Some Patterns have more obvious changes than others (for example, listen to P59, V A1), but all have some sort of musical or textural progression that make the music flow and breathe.

You can create a different kind of flow by playing different Patterns in a row, each Pattern lasting just one bar. Select P59, and play V A1, A2, A3, and A4 like this:

Repeat the above passage for about four or eight times, then switch to this:

See how easily this lets you create your own two- or four-bar variations! Try it out with some of the other Patterns, too.

Crossfader Power Tips

Tip 52 Quick Crossfader scratching



Here's a cool way to change the sound of a Pattern — and put your personal scratch touches on it — without disrupting the flow of the rhythm!

Select P50 and start V A1. Also, call up Scratch 01. While the Pattern is playing, try scratching along with the rhythm — just to get in the groove. As you keep working the Scratch Pad, flick the Crossfader on the beat, between hard left and hard right, like this:

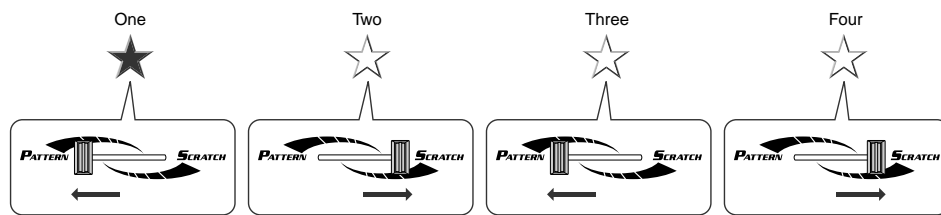

Flick it fast! Make sure the Pattern plays on the “one” and “three,” while your scratching comes down on the “two” and “four” backbeats. And keep scratching even while only the Pattern is playing — so you stay in the pocket! Try other variations on this, cutting in to a Pattern with short scratch fills and accents.

Tip 53 Long Crossfader scratching



This one's going to take a bit of practice! Like Tip 52 above, try flicking the Crossfader between the Pattern and your scratching — but this time, hang with the scratch for one full bar!

That's right — scratch for four beats, then come back in with the Pattern on the “one.” The reason this is tricky is because you have to rely on your body and mind as the timekeeper until you flick back to the Pattern.

◆ Helpful hints:

- Tap out the beat with your foot. Try to flick the Crossfader back just before the “one.”
- Double-up the count for slower rhythms (see Tip 5).
- Try practicing your fader-flicking without the Scratch Pad at first. Then, when you've got it down, bring in the scratch!

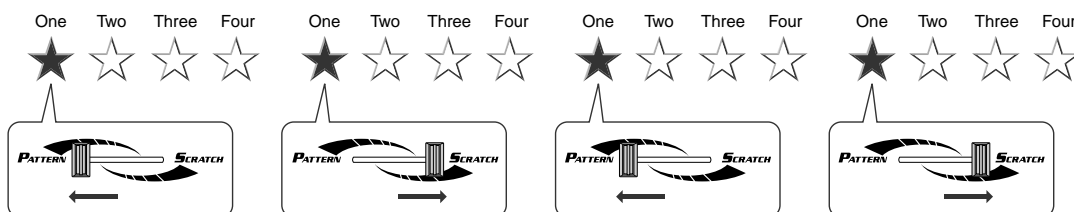

Tip 54 Pattern loop vs. scratch loop



Try Tips 52 and 53 with a Drum Loop instead of a scratch! Since the DJX-II B keeps the Drum Loop in sync with the Pattern, you can switch seamlessly between the two — and create a ton of new rhythms!

Select one of the Drum Loops in the Scratch kits. Try to get a loop that complements the selected Pattern. Or, if you're after special effects and off-the-wall beats, call up a loop that intentionally clashes with the Pattern!

Start the Pattern with the Crossfader all the way left, and turn the Scratch Pad right on the “one” to start the Drum Loop. Then, work the Crossfader like you did in Tips 53 and 54. Try some other rhythmic flicks as well — like coming in with the loop on beats 3 and 4, for example.

Using the BPM/TAP button

Tip 55 Tap out the beat!



Change the bpm in real time! Tap the BPM/TAP button twice rhythmically, while the Pattern is running — and the bpm automatically changes to the tapped speed.

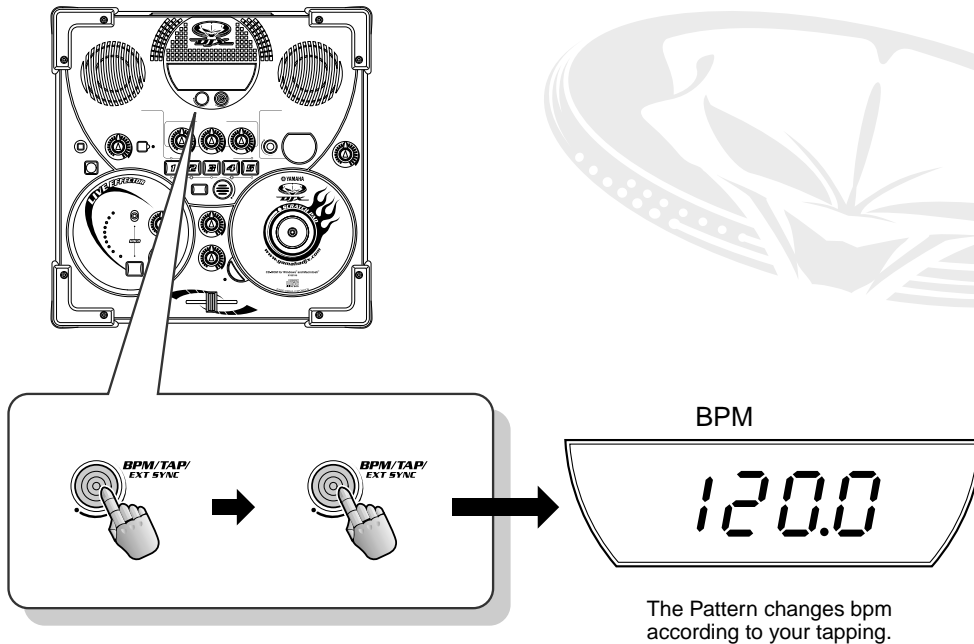

Tip 56 Start with a tap...



You can also get the Pattern going at whatever speed you like by simply tapping it out. Select a Pattern, then instead of hitting one of the Pattern Player, tap the BPM/TAP button — four times, in rhythm — and the Pattern starts automatically at the bpm you've tapped.

While you're tapping, the display shows each of your four taps, then displays the resulting bpm.

◆ **Tech note** Only two taps are needed to start Pattern 42, since that Pattern is in 2/4 time.

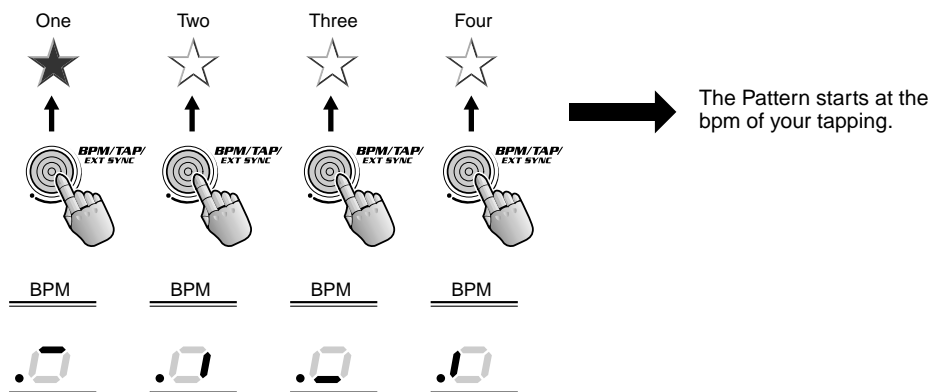

The Outside World

Here are a couple of tips that get you started interfacing the DJX-IIB with external gear. Go for it, and get your sound out there!

Tip 57 Expanding your DJ setup



The DJX-IIB can easily do double-duty as part of a larger DJ setup. For example, you can connect the LINE OUT jacks to two of the inputs of a DJ mixer. Hook up a turntable to the other channels of the DJ mixer, and you've got a full dance production setup to rival the pros! This way you can play the DJX-IIB as well as your favorite vinyl tracks, and mix and switch them with the controls on the DJ mixer.

Naturally, you can also hook your DJX-IIB up to an MD recorder or cassette deck and record your DJ performances to disk or tape.

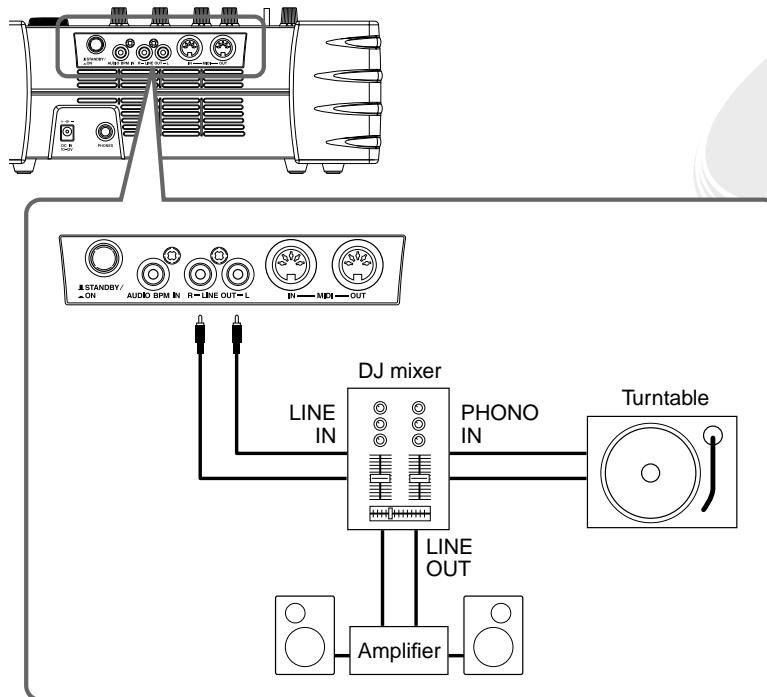

Tip 58 Mute the speakers



If you're routing the DJX-IIB's sound to a DJ mixer or external amplifier/speaker system, you may want to cut off the sound of the DJX-IIB's built-in speakers. Easy! Simply insert a phone plug into the PHONES jack — or hook up a set of stereo headphones for monitoring the DJX-IIB sound.

Naturally, even when the built-in speakers are muted in this way, audio is still output through the LINE OUT jacks.

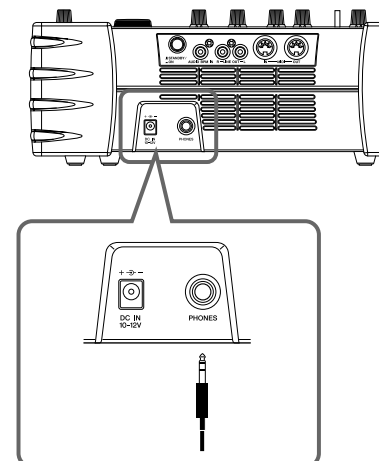

More Pattern Player Power Tips

Tip 59 Creative Fill-in 1



Select P35 and start with V A1. Then, hit the V A1 button in the following rhythm.

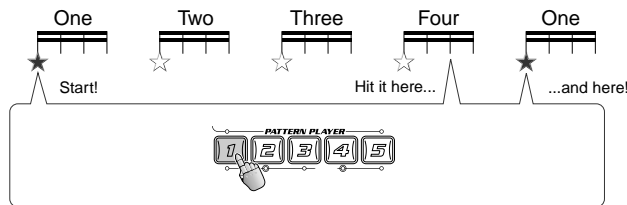

Tip 60 Creative Fill-in 2



Select P35 and start with V A1. Hit the V A2 button repeatedly in the following rhythm, then play the V A3 button on the "one" to change the Pattern!

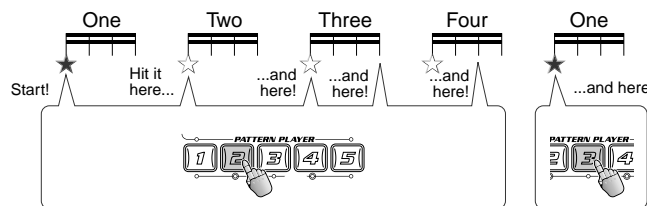

Tip 61 Playing intros and transitions



Sometimes it's best to keep things simple! Here's an effective but easy-to-use technique that's ideal for intros and transitions.

Select P39 and play V A1 to V A3 like this:

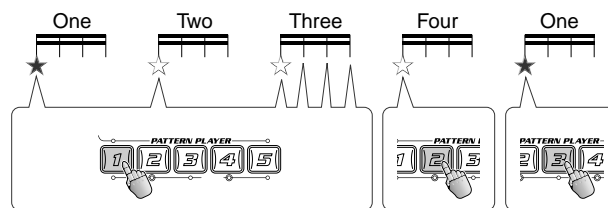

For this kind of trick, it's best to have the bpm firmly in your memory before starting the Pattern. For an even more interesting (or dangerous!) variation on this, try starting with bar 3 above (a tap each beat). Even if your tapping is slower than the correct bpm, it still makes for a hip intro!

Tip 62 Playing intros and transitions, part 2



Here's a cool variation on Tip 60 above. Use P39 for this again, and try it out — and try out some of your own intro ideas, too!

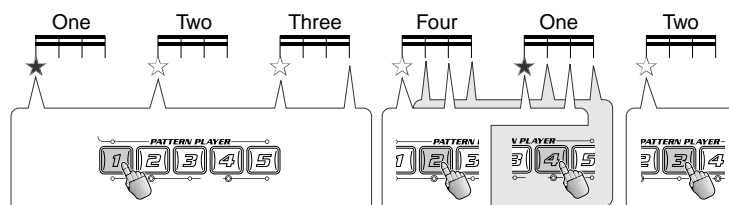

Live Effector Power Tips

Tip 63 Distortion



This little trick can kick your tracks into high gear! Use the Distortion effect selectively, applying it only to certain beats in the Pattern, places you want to add an accent — such as on the 2nd or 3rd beat of the bar. This gives you a massive, in-your-face sound — right on that all-important back-beat — and takes the rhythm to a new level!

In a variation on this technique, bring in the Distortion repeatedly and rhythmically. This punches new accents into the Pattern, and — with the right treatment — creates a completely new Pattern! This technique works extremely well with some of the other effects, such as Ring Mod, Flanger, and Phaser.

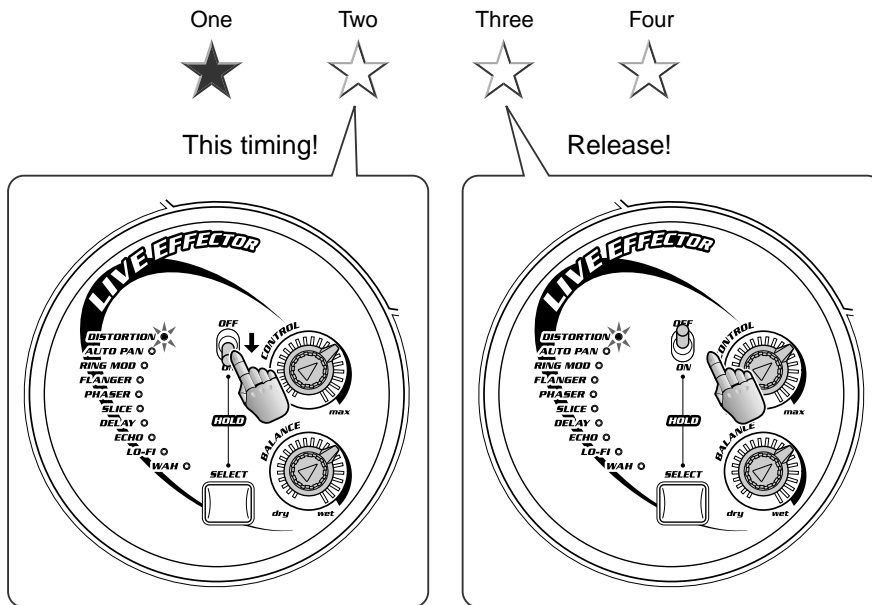

Tip 64 Auto Pan



Tweak the knob until you hit the “sweet spot” — the point at which auto panning syncs up to the bpm and gives you the rhythmic effect you want.

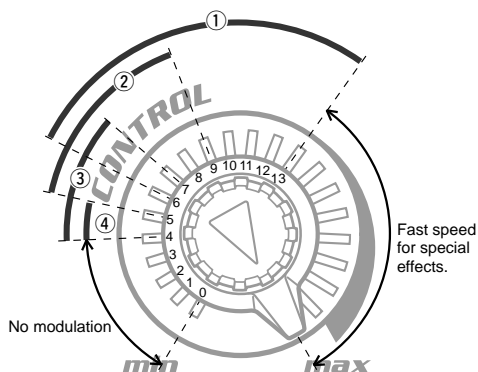

① 1 beat cycle	Knob position	6	7	8	9	10	11	12	13
	bpm	55	70	90	110	125	145	160	195
② 2 beat cycle	Knob position	5	6	7	8	9			
	bpm	70	110	140	180	200			
③ 3 beat cycle	Knob position	4	5	6	7				
	bpm	60	105	165	210				
④ 4 beat cycle	Knob position	4	5						
	bpm	80	140						

◆ **Tech tip:**

The knob positions and the corresponding bpm readings shown here are approximate — let your ears be the final judge!



Tip 65 Ring Modulation

As we pointed out in Tip 10, this effect is a powerful one, so you'll want to save it for huge, in-your-face intros, transitions and endings. Here's how you can use Ring Modulation to build to an enormous climax:

First, set the controls — CONTROL to min and BALANCE to max. Then, hold the effect on (or lock it, as described in Tip 7), and simultaneously move the CONTROL knob toward max — very slowly. Use the effect to build to a fever pitch, then — right at the climactic moment, just before the “one” — turn the effect off and switch to a new Pattern or Variation.

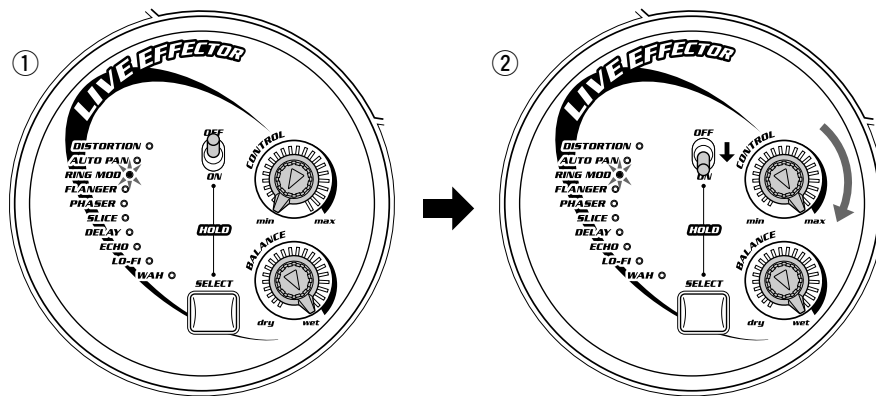

Tip 66 Flanger



Tweak the knob until you hit the “sweet spot” — the point at which the Flanger's modulation cycle syncs up to the bpm and gives you the rhythmic effect you want. (See the illustration in Tip 64 for details on how the knob settings relate to bpm.)

Tip 67 Phaser



Tweak the knob until you hit the “sweet spot” — the point at which the Phaser's modulation cycle syncs up to the bpm and gives you the rhythmic effect you want. (See the illustration in Tip 64 for details on how the knob settings relate to bpm.)

Tip 68 Slice



The different rhythm feels that Slice creates depends on the Pattern you've selected as well as the CONTROL knob setting. Experimentation is the key! Try different Patterns and see how they morph when you change the CONTROL knob setting. Move the knob slowly, and find your favorite settings.

Tip 69 Delay



Clever use of Delay is a cornerstone in many different styles of dance music — especially dub. For a dub flavor, set the BALANCE knob to around 2 or 3 o'clock, and turn on the effect only for certain beats. Play around with this — experiment and try to hit the “sweet spot,” the point where the Delay locks into the groove and gives you the feel you want!

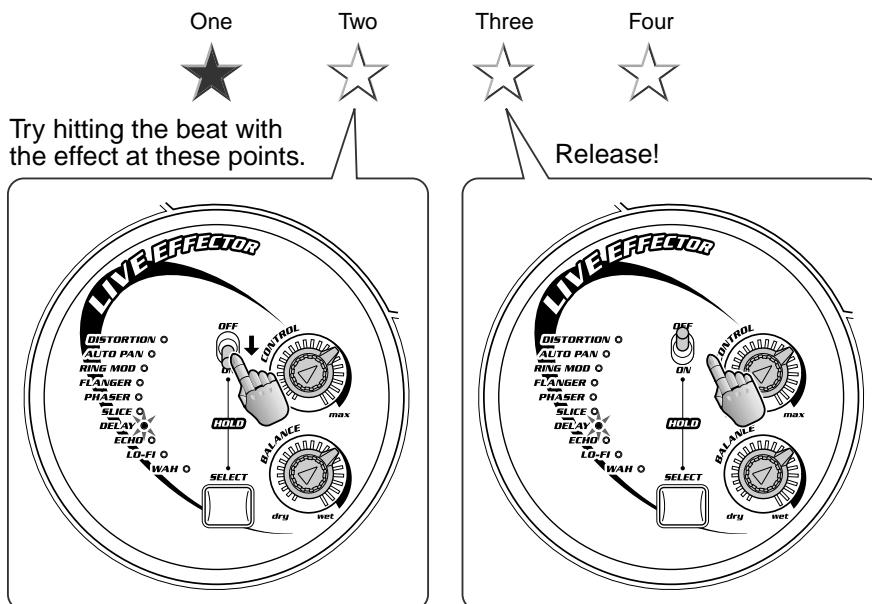

◆ Knob position and Delay time

The knob position determines the rhythmic division (in note values) of the Delay — automatically synchronizing the Delay to the bpm.

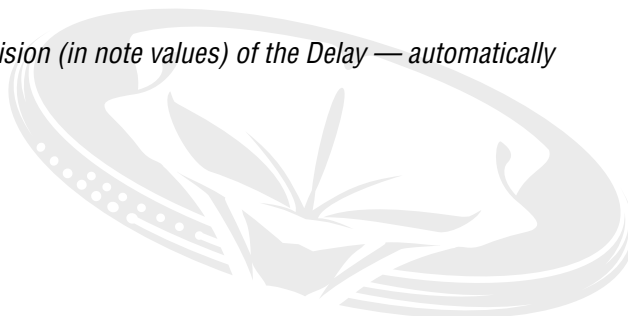

Tip 70 Delay fill-in



Delay can be also used as a break or fill-in to take you into the next Pattern. This takes a little bit of practice and gives your rhythm chops a workout — but when you hit it right, it can really rock the house!

Set both the CONTROL and BALANCE knobs to 12 o'clock. Select P38, and play V A1. Turn on the effect right on the “four” and hit PATTERN STOP on the next “one.” Let the delay wind down, then come in with V A3. Experiment with this a bit, hitting the effect a fraction of a second earlier or stopping the Pattern later.

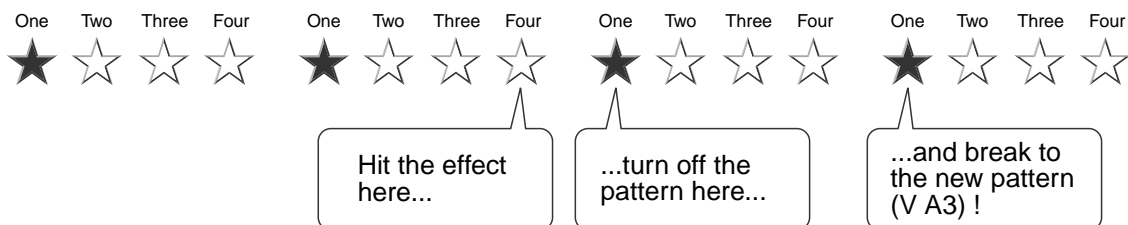

Tip 71 Echo



Many styles of dance music use echo effects in surprising, unique ways. The DJX-IIB's Echo effect lets you use the popular 3/4 beat delay to build up dramatic rhythmic rolls and fills. It also gives you some fascinating echo textures to use in transitions and endings.

Here's a cool trick you can use in your own music! Select P25 and start up V A1 with only the Percussion. (Use the Part Mixer to bring the mix down to the minimum; see page 32.) Set CONTROL to about 2 o'clock and BALANCE to roughly 12 o'clock (center). Turn on the effect, then stop the Pattern and let the Percussion repeats fade out. Just before the Percussion disappears, start the Pattern with all the Parts on! (Press LOOP to turn all Parts on.)

Tip 72 Lo-Fi



Though you may have personal preferences of your own, Lo-Fi is often best when set to the extreme settings — with CONTROL at max and BALANCE at wet.

To get an even more authentic AM radio sound, set the Isolator LOW and HIGH knobs to min. Work these controls in rhythm, and try to bring the sound back to normal right on the “one” downbeat — turning the effect off and bringing the LOW and HIGH knobs to center as quickly as you can!

Tip 73 Wah



Tweak the knob until you hit the “sweet spot” — the point at which the Wah's modulation cycle syncs up to the bpm and gives you the rhythmic effect you want. (See the illustration in Tip 64 for details on how the knob settings relate to bpm.)



Isolator and Filter Power Tips

Tip 74 Isolator to the max!



Play the Isolator in real time! Get the Pattern running, then tweak the knobs to their extreme settings for radical changes to the sound — on the fly!

For example, try cutting back Low and Mid to zero, and bring High up to the max — for a really brittle, tinny sound. Or try boosting Low to the max while taking Mid and High all the way down — for a boomy, bass-only sound. Or go for the sound of an AM radio by setting Mid to max and cutting Low and High.

Since the effect of the Isolator controls depends in part on the selected Pattern, you'll need to do some playing around. Stick to one Pattern and some of its variations, then experiment with the Isolator to find some hip settings.

For maximum dramatic effect, make these changes as quickly as you can, bringing the knobs up or down instantly, if possible. Also, rhythm rules — so, make your moves on the downbeat, right in time! Practice your moves and get them down so you can tweak the sound as you perform!

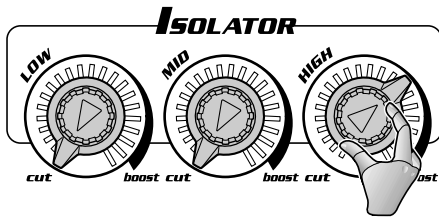

Brittle, tinny sound

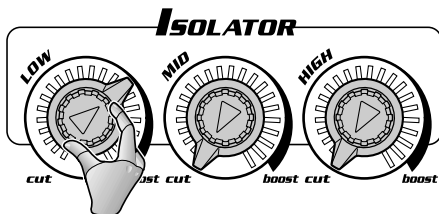

Boomy, bass-only sound

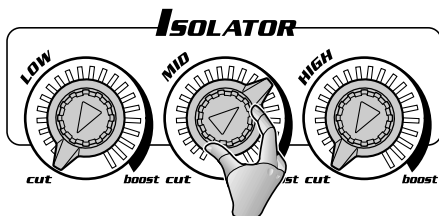

AM radio sound



75 Dark mixes and deep grooves – cut the Cutoff!



Here's a powerful trick to instantly darken up your tracks — if that's what you're after. It's also great for getting a phat, bottom-heavy sound!

First, set the Cutoff and Resonance to zero. Notice how all the high end disappears from the sound, and all you're left with is a pulsing bass! You can accentuate this effect even more by boosting the Isolator Low knob to the maximum and setting Mid and High to the minimum.

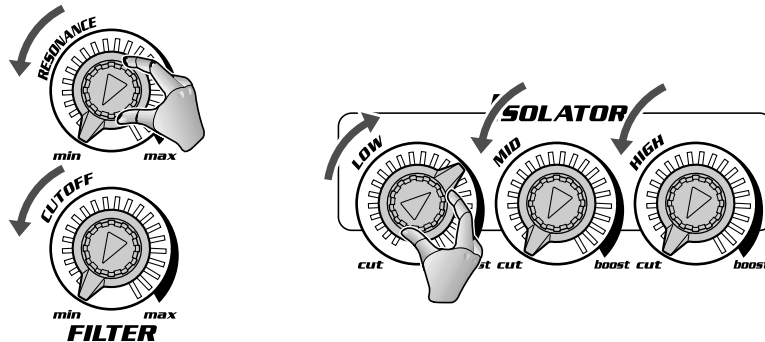

From this starting point, try bringing up the Resonance. Then play with the Cutoff knob in time with the rhythm for some stunning filter sweep effects. It's a great way to fade in the other rhythm parts — plus bring in some killer textures!

To bring things back to normal, turn the Cutoff and Resonance knobs to their center positions. Do it on the “one”!

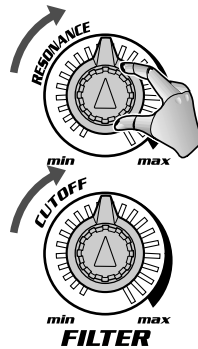

Scratch Pad Power Tips

Tip 76 Scratching triplets



The triplet feel is common to a lot of hip-hop music. Triplets are three notes played in the space of one beat (or other note value). It's a tricky rhythm to master, so we'll give it to you in steps! For these exercises, select P51 and start V A5. Also, call up Scratch 07.

First, try this straight eighth-note rhythm. While the Pattern is playing, scratch up and down (forward and back) each beat. Tap your foot and count the rhythm out while scratching!

Tap with your foot: ★ ☆ ☆ ☆

Count: 1 - and 2 - and 3 - and 4 - and

Scratch (up/down):

Now, try out eighth-note triplets. Instead of two notes for each beat, you'll be scratching three notes. This is a bit difficult, since it may sound as if you're fighting the rhythm! Try to keep the three scratches as even as possible. You may even want to try scratching and counting without the Pattern — just to get used to this tricky feel!

Tap with your foot: ★ ☆ ☆ ☆

Count: 1 - 2 - 3 2 - 2 - 3 3 - 2 - 3 4 - 2 - 3

Scratch (up/down):

Let's pick up the pace a bit with some sixteenth-note triplets. For this, you'll probably want to slow down the bpm. That'll make it easier for you to master the feel! To start with, set the bpm to about 50, and practice the exercise below until you've got it. Then bump the speed up about 5 bpm to 55, and try again. Keep doing this, increasing the speed a little bit each time, until you're comfortable scratching sixteenth notes at the normal bpm. Keep the scratches as even as possible — no matter what the bpm!

Tap with your foot: ★ ☆ ☆ ☆

Count: 1 - 2 - 3 2 - 2 - 3 1 - 2 - 3 2 - 2 - 3 1 - 2 - 3 2 - 2 - 3 1 - 2 - 3 2 - 2 - 3

Scratch (up/down):

Remember, this is just an exercise... Playing all sixteenth notes throughout the rhythm is bound to be boring! Try mixing up your scratching — doing sixteenth notes for just one beat or less, and leaving spaces or putting in odd accents. Keep in mind too that not all of the DJX-IIB Patterns lend themselves equally to triplet scratching. Some work well, some are a bit hard to scratch to, and a few may not work with triplets at all! Select some different Patterns and try it out for yourself, looking for what works and what doesn't.

Tip 77 Scratch on an intro!



Improvise on the Scratch Pad for a bar or two, then start the Pattern. To pull this off properly, you'll want to have the bpm firmly in your memory. Also, keep your scratching simple — doing that helps you feel the rhythm and helps you lock into the coming Pattern!

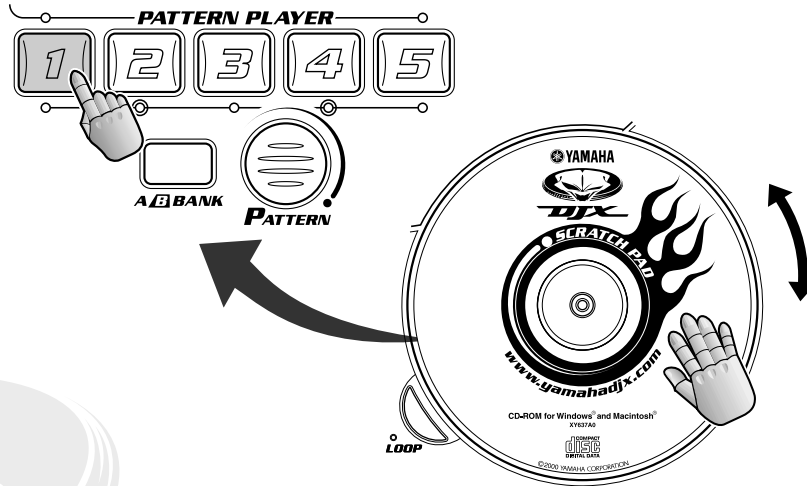

◆ **Helpful hint:**

Try taking the bpm from the display. If the Pattern display is currently up, simply press BPM/TAP to call up the bpm display. Then, tap your foot along with the flashing dot, and scratch as you tap!

Tip 78 Spin around and stop!



Spinning the Scratch Pad and stopping on a downbeat is another hip item in the DJ's bag of tricks! Flick the Scratch Pad around on one downbeat and stop it on the next. Use this technique alone, or with conventional back-and-forth scratching.

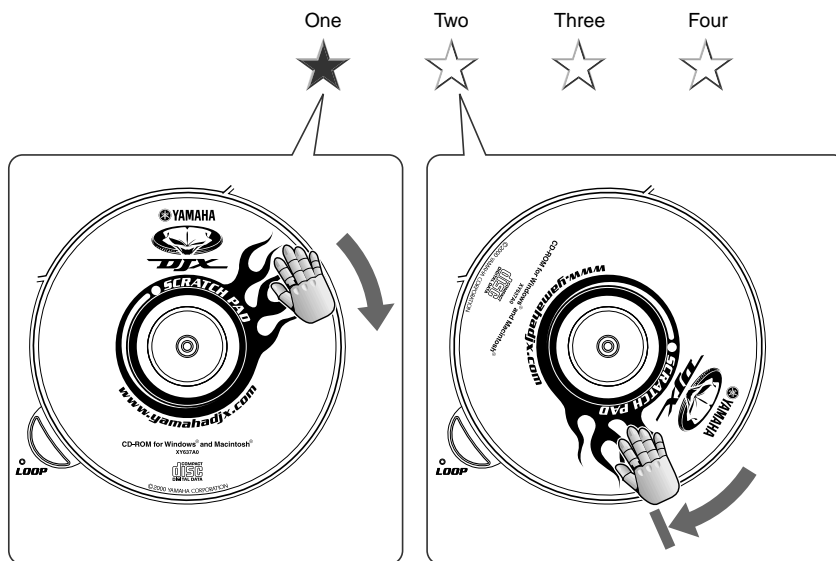

Tip 79 Instrumental dropout



Here's a cool outro that's like a fade-out — only much more interesting!

While the Pattern is running, select Scratch 73 (Part Mixer). Turn the Scratch Pad counter-clockwise slowly to take instruments out of the mix, one-by-one. After playing a couple of bars of only the last instrument, hit PATTERN STOP right on the “one.”

◆ **Tech note** The specific Parts that are muted and the order in which they are brought in and out of the mix differs according to the selected Pattern.

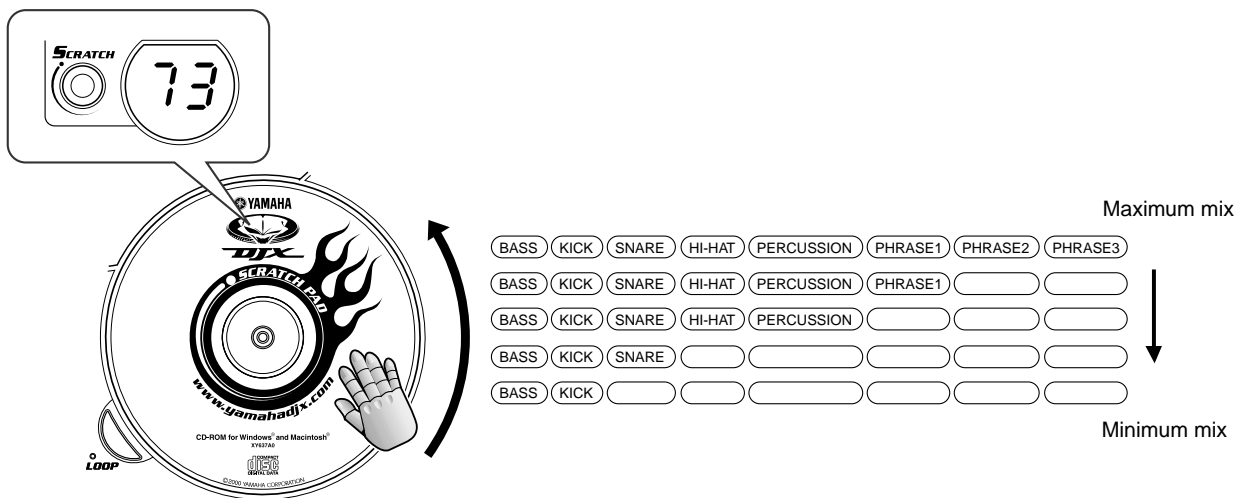

Each 1/4 turn goes forward or back one “step” in the Part Mix arrangement. Turning the pad around a full 360° counter-clockwise instantly takes the mix down to the minimum. Turning it 360° clockwise restores the maximum mix.

Tip 80 More Part mixing



Here's another example of Part Mixer magic!

Select P31, and start up V A1. Let the full Pattern play for one bar, then cut out some parts on the next bar. Repeat and alternate with some other Part Mixer settings, then change to V A3. Here's the recipe:

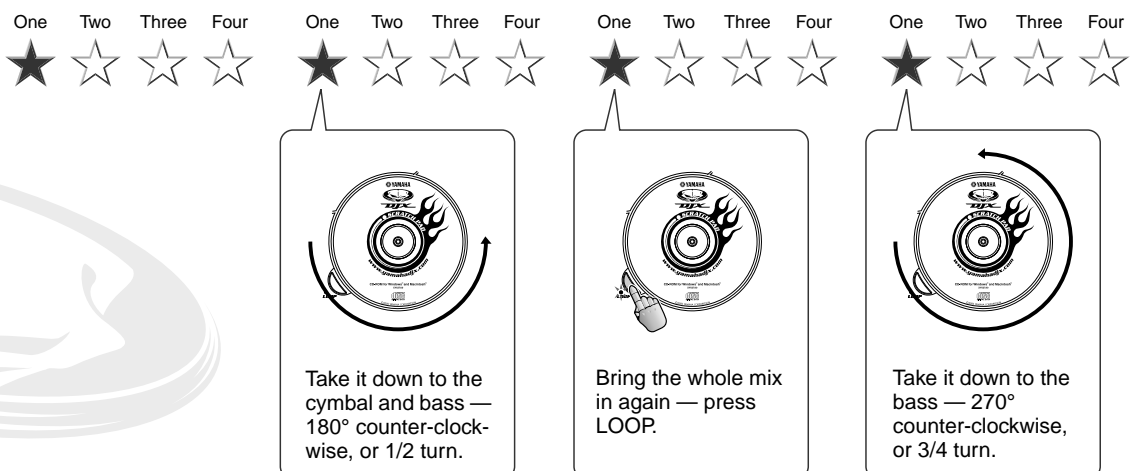

One	Two	Three	Four	One	Two	Three	Four	One	Two	Three	Four	One	Two	Three	Four
★	☆	☆	☆	★	☆	☆	☆	★	☆	☆	☆	★	☆	☆	☆



Bring back the whole mix — press LOOP.



Cymbal and bass only — 1/4 turn counter-clockwise.



Whole mix — press LOOP.



Bass again — 3/4 turn counter-clockwise.

One	Two	Three	Four
★	☆	☆	☆



Finally, bring back the whole mix again (press LOOP), and hit Variation A3 on the “one”!

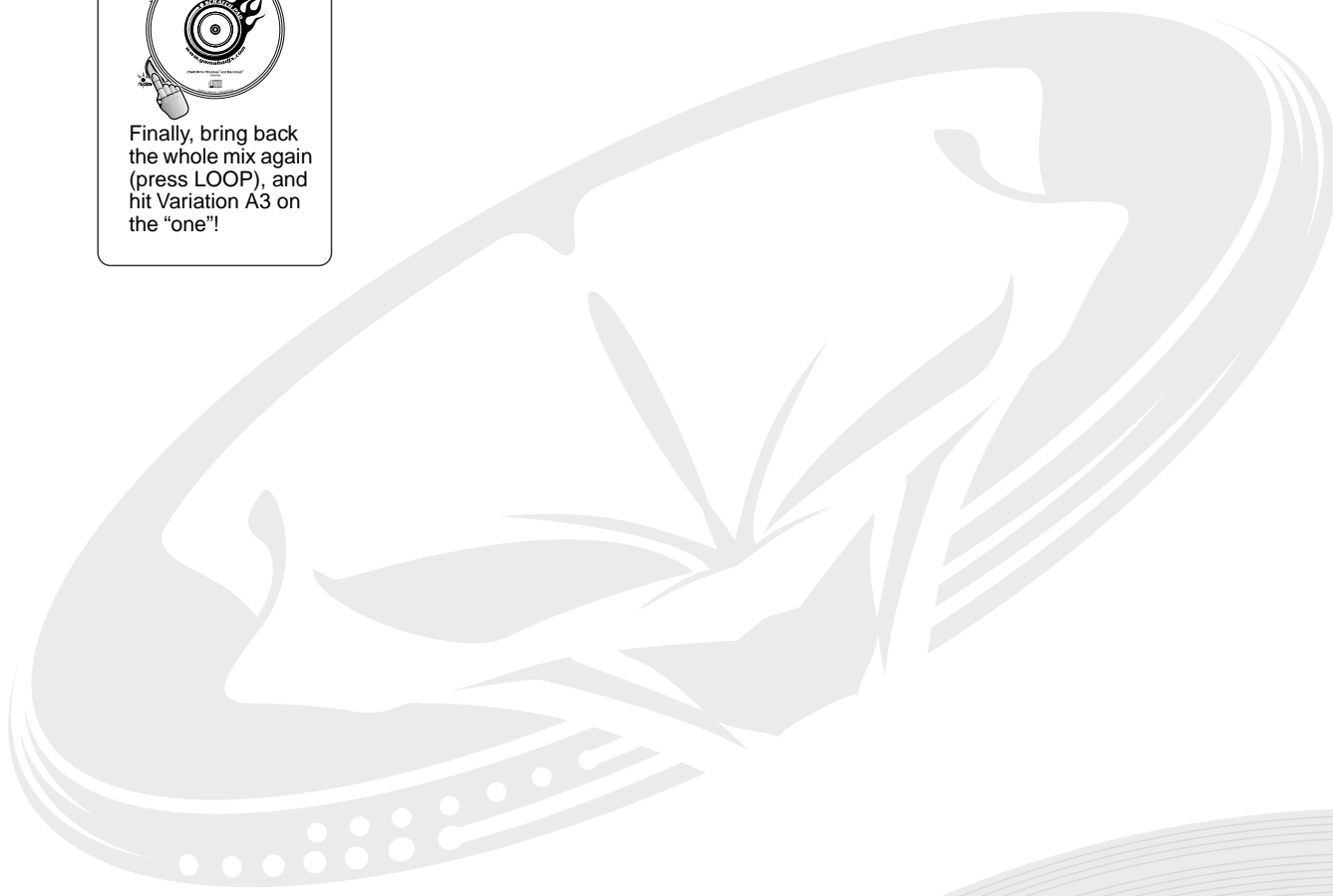

Chapter 17

Advanced Techniques

Tip 81 Delay fill-in and fader cut



Like Tip 69 above, this shows you another way to use Delay for a fill-in — while you flick the Crossfader to mute the Pattern.

First, select the Delay effect and set the CONTROL knob to about 1 o'clock and the BALANCE knob to 12 o'clock. Select P47, and play V B5.

Let the Pattern play for one bar. On the “two” of bar 2, turn the effect on. Then, right on the “three” downbeat, slap the Crossfader all the way right to cut the Pattern. If you’ve hit both of these right, the Delay should continue the beat and start to fade out. Finally turn off the delay and flick the Crossfader back to center on the next “one” beat, to bring the Pattern back in.

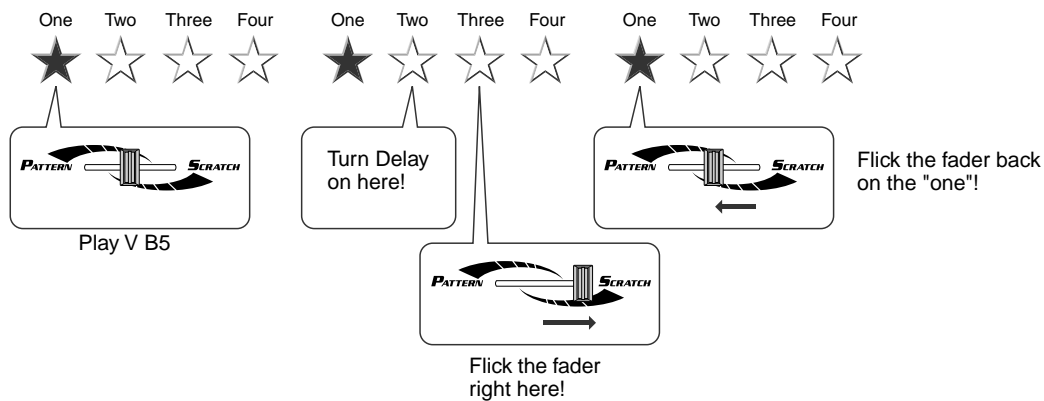

Tip 82 Fade the scratch in and out!



Now for some mixing finesse! With the Crossfader set to the center, scratch along with the Pattern. As you keep both the Pattern and the scratching happening, gradually — ever so slowly — move the Crossfader to the left, and your scratching will be faded out.

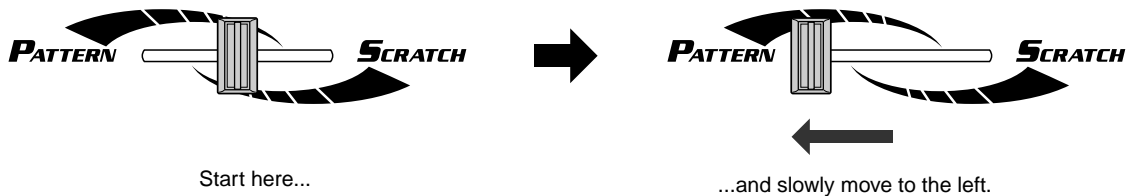

Naturally, you can work in the opposite direction, too — to fade in the scratch sound:

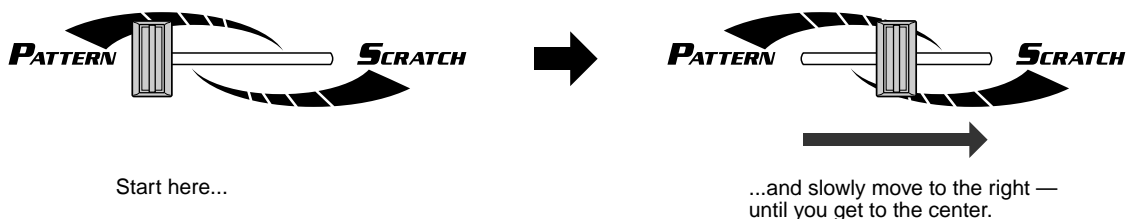



83 Bored? Add some chords... and scratching!



While you're scratching along with a repeating Pattern, sometimes it may feel as if the rhythm's going nowhere. And no amount of intense scratch work can keep the Pattern from getting old. The best way to spice things up is with some key changes!

Try setting the Key Shifter to 2, and release the KEY SHIFTER button on the downbeat. Keep in mind you can't scratch while holding KEY SHIFTER, so try to make your key changes as close to the "one" as you can — then get scratching again!

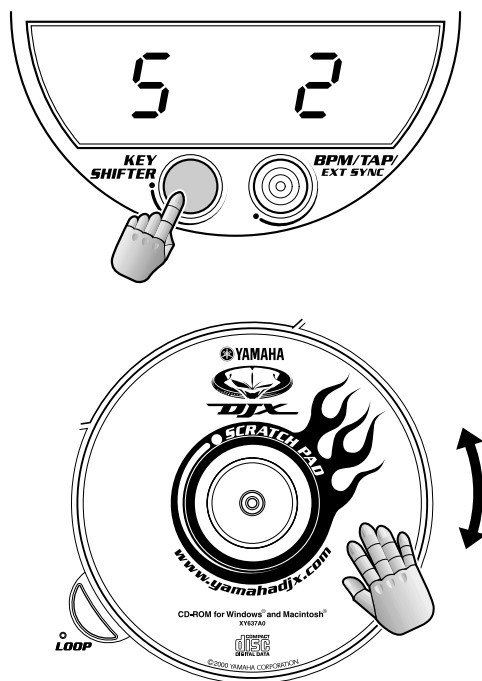

84 Down and out!



In Tip 29, you learned how to recreate the sound of a turntable grinding to a halt — here's a variation on that trick. This slows down the speed of the Pattern without changing the pitch.

While the Pattern is running, simultaneously hold down the BPM/TAP button and turn the Scratch Pad counter-clockwise to slow down the bpm gradually. After the bpm gets as slow as you want, wait until the right downbeat, then press PATTERN STOP to stop the Pattern.

Tip 85 One-hand Effector control!



This technique may take a little practice and some digital dexterity — but once you’ve got it down and are able to play in the pocket, you’re on your way to being a true DJ wizard!

Grab the Control knob with your forefinger and thumb, and use your middle finger or ring finger to flick the effect switch on and off. This lets work the effect in rhythm — and still have your right hand free to change Patterns and work the Scratch Pad. Or use your right hand to further mangle the sound with the Isolator or Part Controller knobs!

As always, keep the rhythm steady — a master DJ is only as good as his time! However, this effectively starts the same Pattern with all its original settings, including resetting the Key Shifter to “0” — and puts you back at home base!

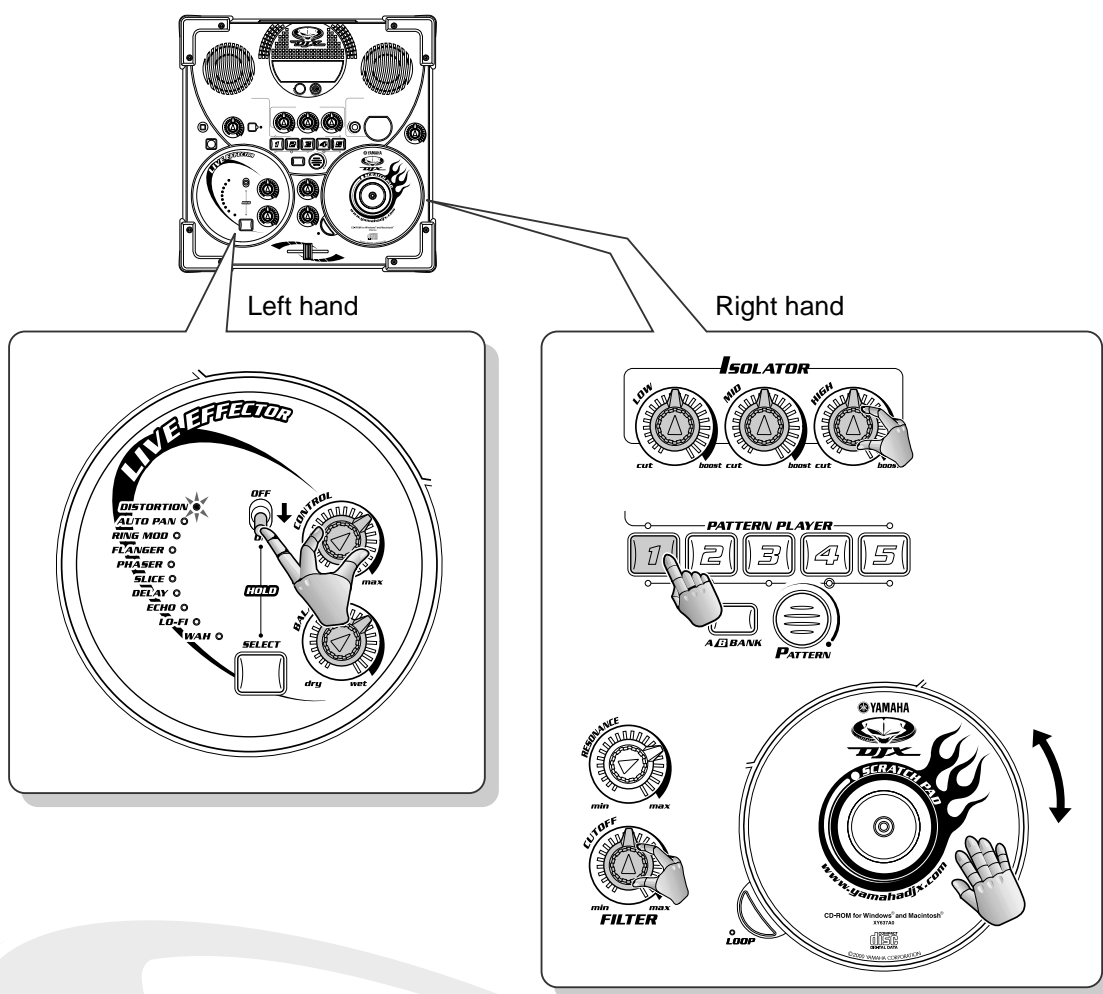



Tip 86 Instant reset!

Once you've made a few changes to the Filter or Key Shifter settings, it's not so easy to get back to where you started! Often, you'll want to be able to backtrack and instantly reset the Pattern to its original sound and pitch. In such a case, the best and easiest way to return to home base is to re-select the Pattern.

Hold down PATTERN and simultaneously turn the Scratch Pad clockwise so the the Pattern number in the display advances one step (+1), and then turn it back again (-1) to return to the currently selected Pattern. Finally, release PATTERN to start the Pattern again — preferably on the “one” downbeat. Doing this fools the DJX-IIB into thinking you've selected a new Pattern! However, this effectively starts the same Pattern with all its original settings, including resetting the Key Shifter to “0” — and puts you back at home base!

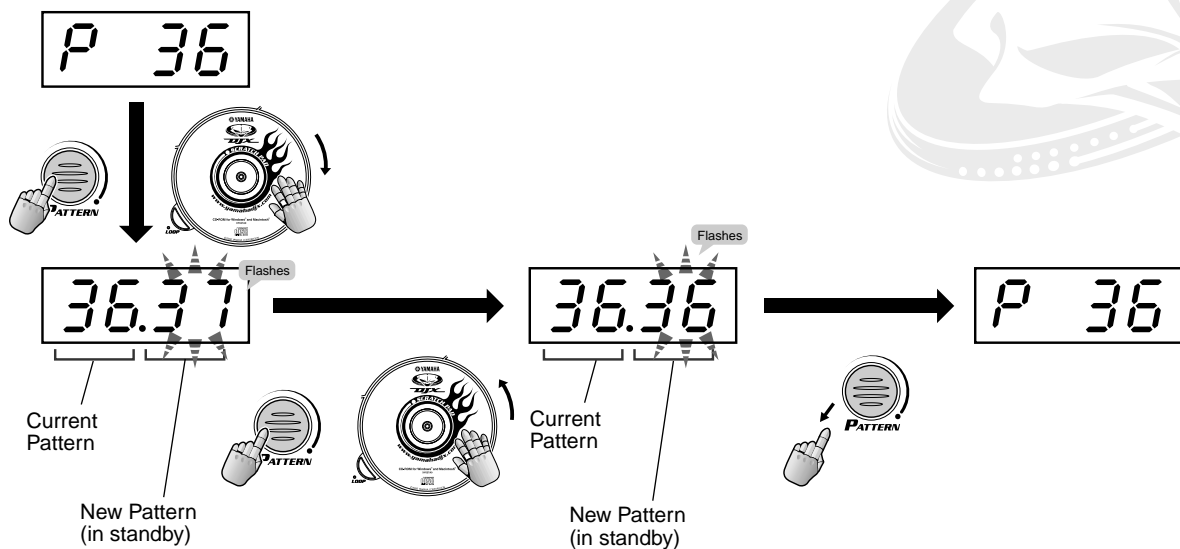

Tip 87 Hit the Part on the “one”!



We said it before, we'll say it again— make sure you keep it in the pocket! That means making all your hits right on the beat, so that the whole rhythm grooves.

When using the Scratch Pad as a Part Mixer, changing Parts on the downbeat is a little bit tricky. When you add Parts to the mix, you should perform your Scratch Pad move a fraction of a second before the actual downbeat to make sure everything flows smoothly and stays in the pocket. Subtracting Parts from the mix (turning the pad counter-clockwise) is easier and more forgiving — basically do it whenever you want, or wherever feels good!

Tip 88 Check the bpm



Need to know what the bpm of a certain track on CD or vinyl is? Here's a convenient tool! Just tap out the rhythm of the music as you listen to it, and the DJX-IIB displays the bpm for you — automatically! (Make sure to turn down the MASTER VOLUME to keep the DJX-IIB Pattern from sounding.)



DJ Performance Master Class

Take it up to the next level! Use these advanced tips as a springboard to explore all the amazing DJ possibilities — and become a true mixing virtuoso!



89 Cut in with a scratch and hit the next Variation



Here's some fancy finger work for you! This move will take some practice, but it's a great way to break for a beat with a scratch fill-in and go onto another Variation.

On the “four” beat, flick the Crossfader all the way right and play a scratch fill-in. Then — on the next “one” — simultaneously swing the Crossfader to the left and hit a new Variation button.



90 Auto-adjusting the bpm



Got a favorite beat on CD or vinyl that you want to sync to the DJX-IIB? This powerful function lets you do just that!

The DJX-IIB “hears” the beat (from a connected external sound source) and automatically locks into the rhythm by auto-adjusting the bpm of the currently playing Pattern.

To use this, connect a CD player or turntable and mixer (as shown), and play the source music. Then, press and hold the AUDIO BPM COUNTER button and adjust the SENSE dial until the lamp flashes. The optimum setting is when the lamp flashes only at each downbeat in the source music. For best results, try narrowing in on the bpm roughly at first by tapping it out (Tip 55), then using the auto-adjust function.

Most dance music styles (such as techno or house) that have a prominent kick and bass sound only on the downbeat are ideal for this function. Keep in mind, however, that some kinds of source music may not work with this. If that's the case, use the Tap function (Tip 55) to lock into the bpm.

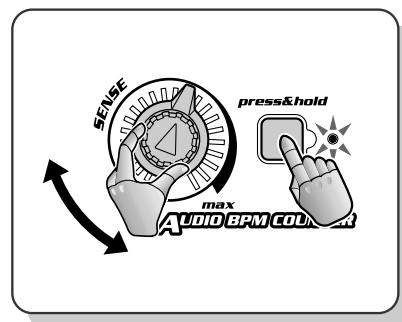
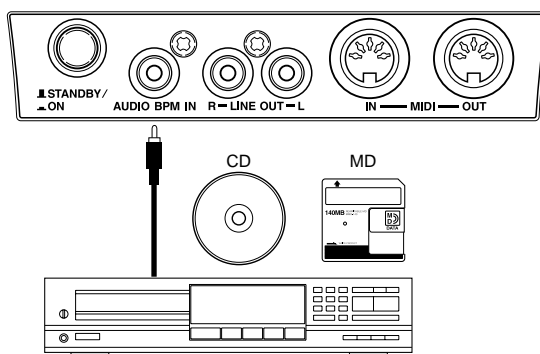

Tip 91 Creative Fill-in 3



Here's a cool technique for stopping the Pattern and coming back in with the rhythm. Select P42 and start with V A1. Then, hit PATTERN STOP and the Variation as shown.

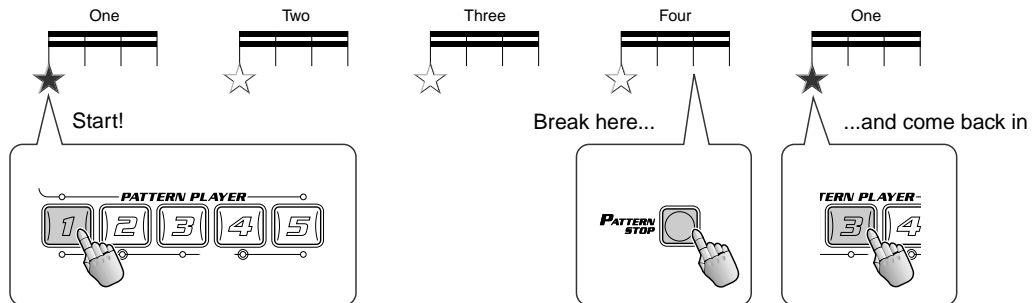

Tip 92 Crossfader cut-in – Scratch plus effect



This requires a bit of tricky finger work... But it's an effective to add some atmospheric fill-ins to your tracks!

Here's the basic idea: Alternate between the Pattern and your scratching (with the Crossfader), and apply the effect to only the scratch. The trick is to have your left hand do two things at once! Use your 4th or 5th finger to flick the Live Effector switch on and off, while your thumb swings the Crossfader back and forth. Meanwhile, your right hand is busy doing the scratching! Try alternating bars — four beats of Pattern, then four beats of scratch.

Tip 93 Crossfader cut-in – Scratch plus Delay



Try this variation on Tip 92 above. Delay works well as an effect for scratch fill-ins, since it locks into the bpm and gives you a clue to where the beat is — even when you can't hear the Pattern! Keep your scratching simple, and the Delay will guide you back to the "one."

Once you feel comfortable with this technique, try scratching for two bars instead of one! Also, try the Echo effect for some off-the-wall scratch effects.

Tip 94 Outro -tro -tro -tro



Here's another popular technique from the producer's bag of tricks — ending with an echo!

Select the Delay or Echo effect. Then, on the very last beat (or last two beats) of the last bar of the Pattern, switch and hold the effect on. Then press PATTERN STOP just before the “one” of the next bar to stop the Pattern. Don't forget to keep holding the effect on! The Delay or Echo hits just the last notes of the rhythm and fades them out in a delayed repeat. Awesome!

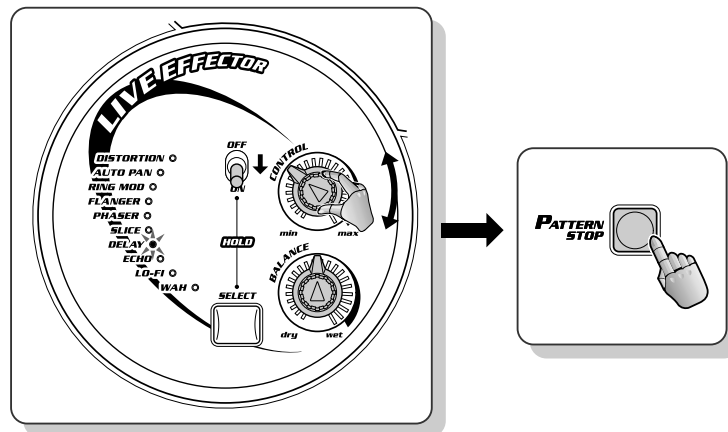

Tip 95 Upside down, inside out!



Sometimes when you play certain Parts in a Pattern by themselves, it's difficult to hear where the downbeat is. Especially in an intro. Your ears may fool you into hearing and expecting a completely different downbeat! Then, when the rest of the rhythm kicks in, it turns your feet (and whole body!) around. Like with this tricky intro!

Select P19. Then set the Part Mixer (Scratch 73) so that the minimum mix will play. (To do this, spin the Scratch Pad around counter-clockwise a couple of full turns.) Then start V A1. Let the Bass play by itself for a few bars, and try to feel the downbeat. Don't worry if you can't — the other Parts will cue you into it! Turn the pad 1/4 turn clockwise each time you want to bring in new Parts to the mix. Do it gradually! Let the rhythm simmer for a while each time you bring in a Part or Parts. At some point — probably when the Kick comes in — the beat turns around, and you can finally “hear” the rhythm!

Tip 96 Taking the pulse



The DJX-IIB has a variety of bpm-related tools that help you get the proper bpm — such as tapping it out (Tip 55) or capturing the bpm from an external source (Tip 90 above). Sometimes you may find it difficult or impossible to get an accurate reading, however. In the end, the best tools are your ears!

Use the AUDIO BPM COUNTER or Tap function to zero in (as close as possible) on the bpm of an external source. Then, to fine tune the bpm reading, start the Pattern Player on the “one” downbeat of the source music. If the beats stay in sync for several bars, you've got the right bpm! If the beats drift apart, try adjusting the bpm manually, re-starting the Pattern on the “one” each time. Eventually, you'll hone in on the proper bpm!



97 Sync applications – using the DJX-IIB as the master



The advanced sync features of the DJX-IIB let you lock it together with the rhythm and bpm of another device, such as a DJX-II, another DJX-IIB, or an external sequencer. No drift, no slipping out of sync — the two devices stay perfectly in the same groove! This is just one of the enormous advantages of digital-based music. Try syncing two turntables together, and you'll see what we mean!

Although this is really just one feature, we've divided it into two separate tips: using the DJX-IIB as the master device, and using it as the slave (in Tip 98 below). If you've got a second device, try it both ways!

When the DJX-IIB is used as the master, you can play the Patterns of the DJX-IIB and have sequenced patterns and music on an external sequencer lock into the bpm of the DJX-IIB.

1 Set up the DJX-IIB and the external device.

Use a standard MIDI cable to connect the two devices as shown.

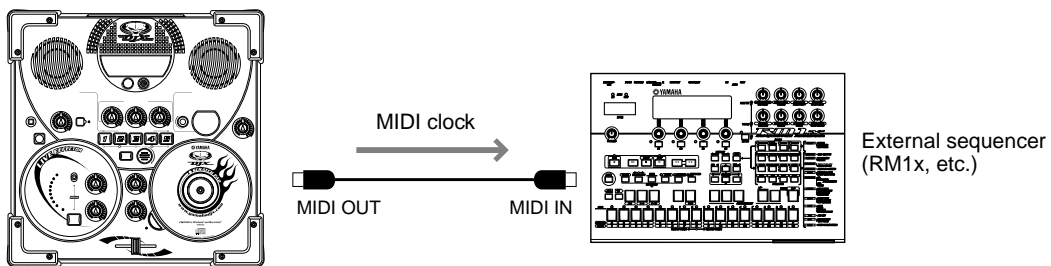

2 Set the external device to “external sync.”

For specific instructions on changing the sync setting, refer to the owner's manual of the external device.

3 Play the DJX-IIB.

When you start and stop the Patterns of the DJX-IIB, the songs or patterns on the external device start and stop at the same time. Likewise, changing the bpm on the DJX-IIB automatically changes the bpm of the external device. All playback operations function in perfect sync between the two machines, with the DJX-IIB as the master.



98 Sync applications – using the DJX-IIB as the slave



Here we'll do the opposite of Tip 97 above. This sophisticated application lets you play sequenced patterns and song data on an external sequencer and have the Patterns of the DJX-IIB lock into the bpm of that device.

1 Set up the DJX-IIB and the external device.

Use a standard MIDI cable to connect the two devices as shown.

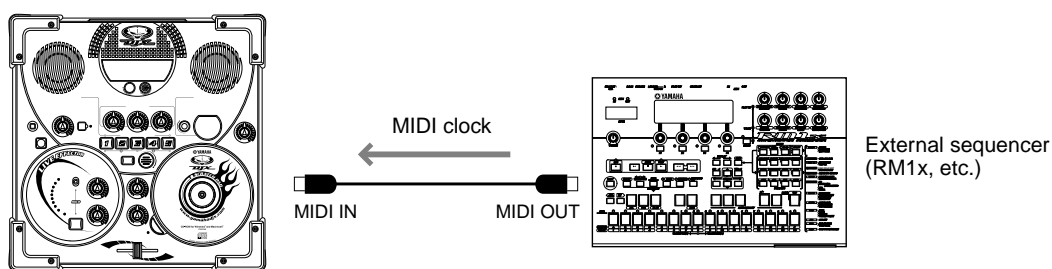

2 Set the DJX-IIB to "external sync."

Simultaneously hold down BPM/TAP and turn the scratch pad clockwise, a couple of turns past the maximum of 280.0, until "Sync" appears in the display.

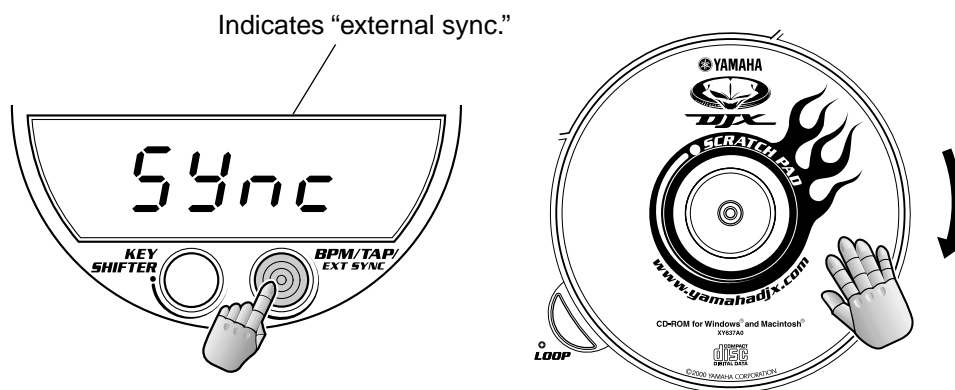

3 Play the DJX-IIB.

When you start and stop the song or pattern on the external device, the Patterns of the DJX-IIB start and stop at the same time. Likewise, changing the bpm on the external device automatically changes the bpm of the DJX-IIB. All playback operations function in perfect sync between the two machines, with the external device as the master and the DJX-IIB as the slave.

Tip 99 Get more Patterns!



One of the great things about the DJX-IIB is how open-ended the system is! You can get additional Patterns from the DJX Internet Site (www.yamahadjx.com), and — with the **Pattern Launcher** software (on the included CD-ROM; see Tip 31) — load that Pattern data right into your DJX-IIB!

Once new Pattern data is loaded, select one of the Patterns U1 - U5 to play the desired Pattern. (U1 - U5 appear only when User Pattern data has been loaded to the DJX-IIB.) Up to five Patterns can be loaded at one time.

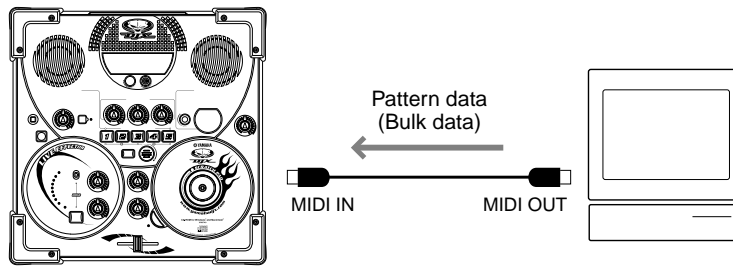

■ Connecting to a Personal Computer

- When the computer has a MIDI interface installed, connect the MIDI OUT terminal of the personal computer to the MIDI IN terminal of the DJX-IIB.

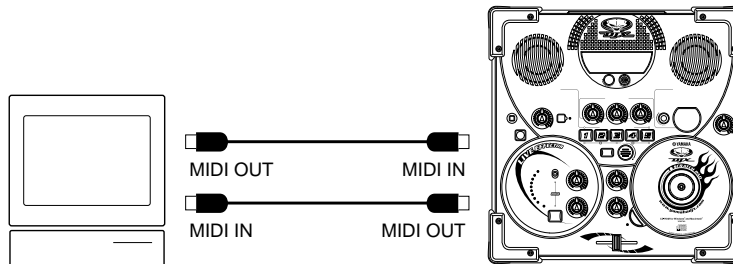

- When using a MIDI interface with a Macintosh series computer, connect the RS-422 terminal of the computer (modem or printer terminal) to the appropriate MIDI interface, then connect the MIDI OUT terminal on the MIDI interface to the MIDI IN terminal of the DJX-IIB, as shown in the diagram below.

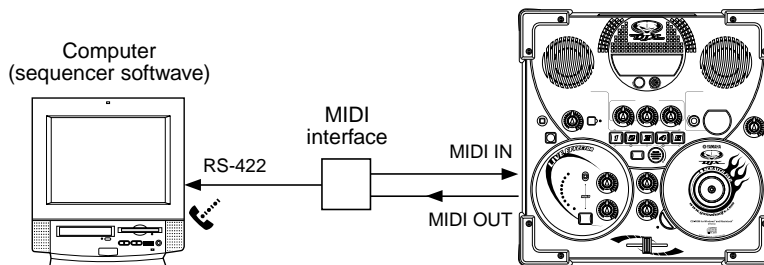

- When the computer has a USB interface, use the Yamaha UX256.

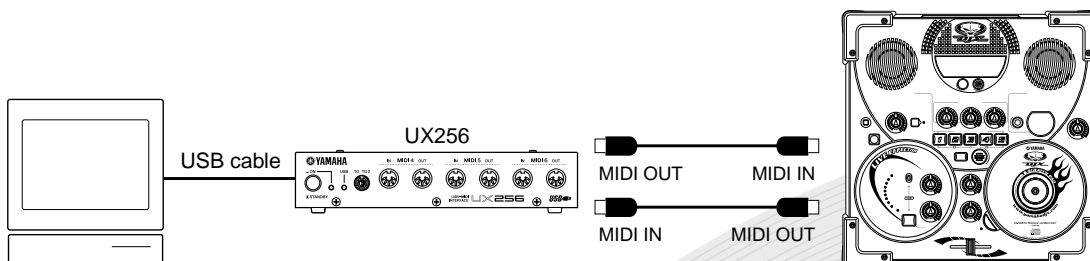

For details on using the **Pattern Launcher** software, refer to the online Help file in the software.

Tip 100 Create your own Patterns!



Roll your own! Yes, you can even create your own Patterns — for mangling, mucking about, and mashing on the DJX-IIB!

Simply use a conventional MIDI sequencer software (such as XG Works) to record your original Patterns as MIDI data — then import the data to the DJX-IIB using the special **Pattern Launcher** software. Data for up to five Patterns (maximum of 85 KB) can be loaded to the DJX-IIB.

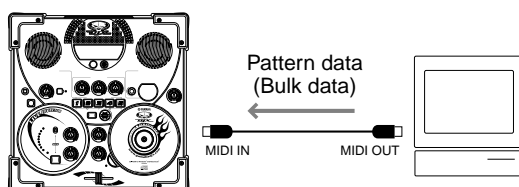

How to Create Your Own Pattern Data

As mentioned above, you can create your own original Pattern data (on an external MIDI sequencer or a computer with sequencer software) and load it to the DJX-IIB with the **Pattern Launcher** software.

■ Connections

Connect a MIDI keyboard and the DJX-IIB to the computer or sequencer as shown below. You'll be using the MIDI keyboard to enter data to the computer and play the sounds of the DJX-IIB.

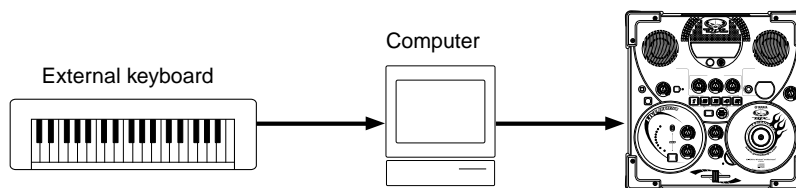

■ Creating the Data

- Creating the data is a relatively simple procedure. However, make sure that you follow the instructions below very carefully to ensure proper creation and loading of the data.

● Recording the Parts

- Record each instrument Part over its own MIDI channel as listed below. (The DJX-IIB's internal tone generator responds according to these channel assignments.) To determine the specific voice used, insert appropriate program changes for each Part. (Refer to the Voice List on page 76 for program change numbers and voices.)

Part	MIDI Ch.
Kick	9
Snare	10
Hi-Hat	11
Percussion	12
Bass	13
Phrase1	14
Phrase2	15
Phrase3	16

● Recording each Variation

- Make sure to record the Variations in the order listed below. Also, enter a "marker meta-event" at the beginning of each Variation exactly as shown.

◆ NOTE:

Timing indications in these instructions are based on a resolution of 480 clocks per quarter note, and are shown in a measure:beat:clock format. For example, "1111000" indicates clock "000" of the first beat of the first measure.

- Enter the following System Exclusive message at the very beginning of the sequence (1111000), before any other data:
 F0, 43, 73, 6F, 30, 00, F7 (TG Reset)
- The first measure (1111000 - 1141479) is reserved for Initial Setup data. The second measure (2111000) through to the end of Variation 10 is used for the actual Pattern data. (See chart below.)

- The timings indicated in the chart below are for example purposes only. The actual timing of the Variations and the marker meta-events (starting with Variation 2) depends on the length of the recorded Patterns. (The length of each Pattern can be up to 256 measures.)

Timing	Marker Meta-Event	Contents
111000 111000 112000 ⋮ 1141479		TG Reset Initial Setup Events
211000 ⋮ 3141479	1	Variation 1 2 bars Pattern (up to 256 bars)
411000 ⋮ 4141479	2	Variation 2 1 bar Pattern (up to 256 bars)
511000 ⋮ 5141479	3	Variation 3 1 bar Pattern (up to 256 bars)
611000 ⋮ 7141479	4	Variation 4 2 bars Pattern (up to 256 bars)
811000 ⋮ 9141479	5	Variation 5 2 bars Pattern (up to 256 bars)
1011000 ⋮ 11141479	6	Variation 6 2 bars Pattern (up to 256 bars)
1211000 ⋮ 12141479	7	Variation 7 1 bar Pattern (up to 256 bars)
1311000 ⋮ 13141479	8	Variation 8 1 bar Pattern (up to 256 bars)
1411000 ⋮ 15141479	9	Variation 9 2 bars Pattern (up to 256 bars)
1611000 ⋮ 17141479	10	Variation 10 2 bars Pattern (up to 256 bars)

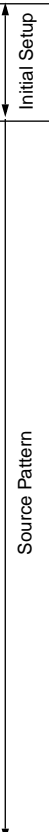

- Enter all voice and effect settings in the last three beats of the Initial Setup area (112000 - 1141479). Do not include any note event data here.
- Start recording Variation 1 data from the second measure (211000). The length of the data can be from 1 to 256 measures. All measures must be of one of the following time signatures: 2/4, 3/4, 4/4, or 5/4.

- Variation 2 begins from the top of the measure directly following the last measure of Variation 1. In the chart, this is listed as 411000; however, the actual timing depends on the length of Variation 1.
- The following charts indicate the valid MIDI events for both the Initial Setup data and the Pattern data. Make sure to **NOT** enter any events marked with a dash (—), nor any events not listed here.

Channel Message

Event	Initial Setup	Pattern
Note Off	—	OK
Note On	—	OK
Program Change	OK	OK
Pitch Bend	OK	OK
Control #0 (Bank Select MSB)	OK	OK
Control #1 (Modulation)	OK	OK
Control #6 (Data Entry MSB)	OK	—
Control #7 (Master Volume)	OK	OK
Control #10 (Panpot)	OK	OK
Control #11 (Expression)	OK	OK
Control #32 (Bank Select LSB)	OK	OK
Control #38 (Data Entry LSB)	OK	—
Control #71 (Harmonic Content)	OK	OK
Control #72 (Release Time)	OK	—
Control #73 (Attack Time)	OK	—
Control #74 (Brightness)	OK	OK
Control #84 (Portamento Control)	—	OK
Control #91 (Reverb Send Level)	OK	OK
Control #93 (Chorus Send Level)	OK	OK
Control #100 (RPN LSB)	OK	—
Control #101 (RPN MSB)	OK	—

RPN & NRPN

Event	Initial Setup	Pattern
RPN (Pitch Bend Sensitivity)	OK	—
RPN (Fine Tuning)	OK	—
RPN (Null)	OK	—

System Exclusive

Event	Initial Setup	Pattern
TG Reset	OK	—
Sys Ex XG Parameter Change (Effect1)	OK	—
Reverb Type	OK	—
Chorus Type	OK	—

■ Saving and Loading the Sequence Data

- Save the completed sequence data to your computer.
- Save the file using Standard MIDI File Format 0 and make sure that the file extension “.mid” is included in the name.
- Load the Pattern file to the DJX-IIB using the **Pattern Launcher** software. (Refer to the online Help file in the software for specific operation instructions.)

■ About the User Pattern Data

As you create your own Patterns and use them with the DJX-IIB, keep in mind that these User Patterns differ from the built-in preset Patterns of the DJX-IIB in the following ways:

- The Scratch Pad’s Auto kit (00) does not apply to the User Patterns. Select from any of the other kits (01 - 72) to use the Scratch Pad with a User Pattern.
- The actual number of taps needed to tap start a Pattern (Tip 56) depends on the time signature of the User pattern. For example, in the case of a Pattern created in 3/4 beat, tap the BPM/TAP button three times to start the Pattern.
- The FILTER knobs affect all Parts of User Patterns equally.

PROBLEM	POSSIBLE CAUSE/SOLUTION
The speakers produce a “pop” sound whenever the power is turned ON or OFF.	This is normal and is no cause for alarm.
When using a mobile phone, noise is produced.	Using a mobile phone in close proximity to the DJX-IIB may produce interference. To prevent this, turn off the mobile phone or use it further away from the DJX-IIB.
The volume is reduced or the sound is distorted.	The batteries probably need to be replaced. Either replace all six batteries, or use an AC power adaptor.
The sound quality has gotten progressively worse.	
The display goes blank and all panel controls are reset.	
There is no sound even when the scratch pad is turned on or when a pattern is being played back.	Check that nothing is connected to the PHONES jack on the rear panel. When a set of headphones is plugged into this jack, no sound is output.
The panel buttons do not function.	Check whether the MIDI bulk data is being transmitted/receiving or not. When the MIDI bulk data is being transmitted/receiving, all of the buttons other than the PATTERN STOP button do not function.
The Pattern does not start even when the PATTERN PLAYER button is pressed.	Check whether the BPM is set to “Sync” or not by pressing the BPM/TAP button. When set to “Sync”, the external MIDI device can start the Pattern of the DJX-IIB and the DJX-IIB itself cannot start the Pattern.
None of the Scratch Pad sounds or functions work.	Make sure that the DJX-IIB is not set to “external sync” (see Tip 98). When “external sync” is on, the DJX-IIB Scratch Pad cannot be used.
The sound is distorted or noisy.	<ul style="list-style-type: none"> • Many of the DJX-IIB sounds have been deliberately processed or created with a “lo-rez” or “grunge” sound to suit certain styles of music. • Using the CUTOFF and RESONANCE knobs at or near the maximum settings (especially when the MASTER VOLUME knob is also at maximum) may result in distortion.

Error Message List

ERROR MESSAGE	DESCRIPTION
<i>Err 1</i>	This appears when the MIDI reception buffer of the DJX-IIB has filled up, and processing is not possible. Try decreasing the amount of data or increasing the interval time and transmit the data once again.
<i>Err 2</i>	This appears when a MIDI data reception error occurs, such as that caused by an improper connection or by use of an excessively long MIDI cable.
<i>Err 3</i>	This appears when the received bulk data contains illegal Pattern data. The illegal data is automatically cleared.
<i>Clr</i>	This appears briefly when initializing the DJX-IIB to the factory preset data, by simultaneously holding down the LOOP button and turning the power on. See page 13 for details.

Specifications

- **PATTERNS** Total 700 Preset Patterns and Variations
 - Preset 70 Patterns
 - User 5 Patterns..... Up to 85 KB for all User Patterns
 - Variation 10

- **SCRATCH PAD**
 - Preset 74 Kits Includes Auto function (00)

- **VOICES**
 - Preset 203 180 Voices + 23 Drum Kits (accessible only via MIDI)

- **POLYPHONY** 32 notes max.

- **EFFECTS**

- Live Effector 10 Presets Distortion, Auto Pan, Ring Modulator, Flanger, Phaser, Slice, Delay, Echo, Lo-Fi, Wah

- Reverb 11 Presets Accessible only via MIDI

- Chorus 7 Presets Accessible only via MIDI

- 3 Bands Isolator -12dB~+12dB

- Key Shifter (Transpose) -5~0~+6

- BPM (Tempo) 32~280

- Audio BPM Counter

- **CONTROLLERS**

- Scratch Pad
 - ∅=120mm The CD-ROM can be changed.

- Filter Knobs
 - Cutoff, Resonance

- Isolator Knobs
 - Low, Mid, High

- Live Effector Knobs
 - Control, Balance

- Other Knobs
 - Sense, Master Volume

- Cross Fader 45mm

- **DISPLAY**

- Multi Display 7-seg. LED x 4 digits

- Scratch 7-seg. LED x 2 digits

- Panel LED LED x 18

- **DEMONSTRATION**
 - 3 songs

- **AUXILIARY JACKS**

- MIDI
 - MIDI IN MIDI Clock In, Remote Control, Tone Generator, Bulk Receive

- MIDI OUT MIDI Clock Out

- Audio
 - PHONES
 - LINE OUT (L, R) ... RCA Pin
 - AUDIO BPM IN RCA Pin

- **AMPLIFIERS** 6W + 6W (when using PA-5C power adaptor)

- **SPEAKERS** 8cm x 2 Bass Reflex, 6 liters Enclosure x 1

- **POWER SUPPLY**

- Adaptor PA-5B, PA-5C

- Batteries 6 x "D" size or SUM-1 or R-20

- **POWER CONSUMPTION**
 - 20W

- **DIMENSIONS (W x D x H)**

- 334 x 334 x 126 mm
(13-1/8" x 13-1/8" x 4-15/16")

- **WEIGHT** 3.5kg (7 lbs., 11 oz.)

- **SUPPLIED ACCESSORIES**

- Owner's Manual x 1
- CD-ROM x 1 For Windows and Macintosh (installed on the panel)

- **OPTIONAL ACCESSORIES**

- Headphones HPE-150, HPE-3

* Specifications and descriptions in this owner's manual are for information purposes only. Yamaha Corp. reserves the right to change or modify products or specifications at any time without prior notice. Since specifications, equipment or options may not be the same in every locale, please check with your Yamaha dealer.

Glossary

A

Audio bpm Counter Tips 90, 96

This powerful function lets you synchronize external audio (such as from a CD, MD, or vinyl record) with the Patterns of the DJX-IIB. The DJX-IIB monitors the beat from the audio, and automatically locks into the rhythm by auto-adjusting the bpm of the DJX-IIB's Pattern.

B

bpm..... Tips 39, 40, 55, 56, 88, 90, 96

Abbreviation for “beats per minute.” Obviously, a rhythm playing at 120 bpm would have two beats every second. The bpm value determines the speed of the rhythm — the higher the bpm, the faster the rhythm. This is also called “tempo.”

F

Filter Tips 19, 43, 44, 75

Filters were originally used to process sound on analog synthesizers. The DJX-IIB uses the same basic filter setup to process the sound. More than just “process,” the filter is capable of radically altering and completely changing the character of the sound! The filter is controlled by the CUT-OFF and RESONANCE knobs in the **Filter** section.

I

Isolator Tips 18, 74, 75

The Isolator section provides three separate controls — Low, Mid, and High — for adjusting the tone or timbre of the sound. Like the Bass and Treble controls on a stereo amplifier, these let you tailor the sound just the way you like to hear it.

K

key Tips 38, 83

The word “key” refers to the basic pitch of a piece of music. There are twelve keys: C, D \flat (or C \sharp), D, E \flat (or D \sharp), E, F, F \sharp (or G \flat), G, A \flat (or G \sharp), A, B \flat (or A \sharp), and B. On the DJX-IIB, you can change the key by using the **Key Shifter**. (Knowing the names of the keys isn't important. On the DJX-IIB, you change the number — the amount by which the key is shifted.)

Changing keys (also called “transposing”) adds variety to the music. It also is capable of changing the character of a piece, making the music brighter and more upbeat, or darker and more subdued.

L

Live Effector..... Tips 7 - 17, 63 - 73

Effects are used to process the sound and change it in various ways. In modern recording studios, almost every recorded sound is processed in some way. On the DJX-IIB, the Live Effector section provides ten different, high-quality effects — the same effects used by the pros in creating hot tracks.

All of the DJX-IIB sounds — the **Pattern** and **Scratch Pad** — are processed by these effects. A toggle switch lets you turn the effect on and off in time with the rhythm, and special CONTROL and BALANCE knobs let you tweak the effects as the Pattern plays.

Loop..... Tips 25, 46, 54

A loop is a (usually) short audio passage or phrase that is repeated indefinitely, or “looped.” Originally used with tape recorders (tape loops), loops have infiltrated the world of sampling and music making in general. Sometimes loops are used to create sustained sound. More commonly (and especially on the DJX-IIB), loops are mainly for rhythmic phrases — drum and percussion rhythms, arpeggiator phrases, etc. The DJX-IIB Patterns are made up entirely of loops.

The **Scratch Pad** also has a special LOOP button that lets you loop certain rhythm phrases, and have them stay in sync with the **Patterns**.

Glossary

M

MIDI..... **Tips 97 - 100**

MIDI (Musical Instrument Digital Interface) allows electronic instruments of various types and manufacturers to “communicate” with each other. At the most basic level, MIDI allows you to play one instrument’s sounds from the controls or keyboard of another instrument. More sophisticated uses included synchronizing two or more instruments together, exchanging data between compatible devices, or having a whole studio’s worth of keyboards, synthesizers, samplers, and rhythm machines controlled from a single computer.

Naturally, the DJX-IIB is MIDI compatible, and can be used effectively in any of the above scenarios. You can sync two DJX-IIBs together (or the DJX-II), and have the bpm’s of both machines lock for synchronized playback. With the special Pattern Launcher software and a computer, you can even load new and original Patterns to the DJX-IIB!

P

Part..... **Tips 32 - 34, 79, 80, 87**

The DJX-IIB Patterns contain up to eight separate instrument Parts — each of which has its own special function and sound within the rhythm. Specifically the Parts are: Kick, Snare, Hi-Hat, Percussion, Bass, and Phrases 1 -3.

Depending on the Pattern, each Part may have a completely different sound. For example, the Bass Part on one Pattern might be an soft acoustic upright bass, while on another Pattern it may be a buzzy synthesizer bass.

By using the powerful **Part Mixer** function with the **Scratch Pad** (see Tips 32 - 34), you can change the arrangement of the Parts on the fly, as the Pattern is playing!

Pattern..... **Tips 1 - 6, 48 - 51, 59 - 62, 99, 100**

Patterns are the basic building blocks of the DJX-IIB sound. Each Pattern is a discrete musical/rhythmic passage, that loops (or repeats) continuously. The Patterns contain different instrumental **Parts** — such as bass, kick drum, snare drum, hi-hat, percussion, and (depending on the Pattern) other pitched instruments such as guitar, organ, strings, etc. Each main Pattern has ten **Variations**, which can be used together for greater variety in performance.

Different Patterns have different lengths, but all are based on four-beat lengths called “measures.” In other words, a Pattern may be eight beats long (two measures) or sixteen beats long (four measures), but all Patterns cycle around a basic count of “1-2-3-4.” The key to developing good rhythm and using the Patterns musically involves knowing this four-beat count and feeling it in your body!

S

scratch, scratching **Tip 20 - 31, 44 - 47, 52 - 54, 76 - 80, 82, 83, 89, 92, 93**

This comes from turntable playing, in which the DJ rocks the record back and forth with the needle down, creating a scratching-like noise. On the DJX-IIB, scratching is done with the **Scratch Pad**.

T

Tap..... **Tips 55, 56, 88, 96**

The DJX-IIB has a convenient Tap function that allows you to change or set the bpm of the instrument simply by tapping out a steady rhythm on the BPM/TAP button. This can be used to automatically start a Pattern at the tapped speed, or it can be used to instantly change the bpm of a currently playing Pattern.

V

Variation..... **Tips 3, 48, 49, 89**

Each of the 70 **Patterns** of the DJX-IIB actually contains ten separate Patterns, called “Variations.” Each Variation, as its name implies, is a different version of the basic Pattern rhythm. There are two types of Variations, main and fill-in. Main Variations are used for the constant rhythm of the music, while fill-in Variations are usually used as dynamic breaks and transitions. In general, the higher the Variation number, the busier or more complex the rhythm becomes.

Pattern List

Pattern No.	Category Name	Pattern Name
00	TECHNO	Berlin Techno
01		Japan Beatz
02		Detroit 2000
03		Parade Beat
04		French Techno
05		Detroit
06	UNDERGROUND	Acid Techno
07		German Underground
08		Loop Techno
09	DISCOMANIA	UK Disco
10		US Disco
11		Disco House
12	CLUB VIBES	Dub House
13		Dark House
14		Chicago House
15		Ibiza
16		Progressive House
17		Hard House
18	TRANCE TRAXX	Hard Trance
19		Acid Trance
20		Euro Trance
21		Goa
22		Dream Trax
23		Eurobeat
24	ELEKTRO EMPIRE	Elektro Beat
25		Breakdance
26		Elektromix
27		Technolectro
28	GARAGE	London Underground
29		Speed Garage
30		UK Garage
31	DRUM'n'BASS	Jungle Beatz
32		Breakbeat
33		Hard Step 8th
34		Jazz D&B

Pattern No.	Category Name	Pattern Name
35	HIP HOP	Hard Hip Hop
36		Hardcore
37		Pop
38		Rock Hop
39	SPACE HOP	Futuristic
40		Cosmic
41		Universal
42	SWING HOP	Live
43		Miami
44		Jazzy
45		Los Angeles
46		Mechanical
47	GANGSTA	Psyco
48		Bangin'
49		Smooth
50		Light
51		R&B
52		Female
53	INTELLIGENT	Soul
54		Busy
55		Laid Back
56		Landscape
57	FUNKY HIP HOP	Cool
58		Jam'n
59		Club Funk
60	OLD SKOOL	Hard Funk
61		80's
62		Scratchin'
63		Breakz
64	TRIP HOP	Beat Street
65		Deep
66		Ambient
67		Dreamy
68		Grunge
69	Dark	

Appendix Voice List

- The Voices of the DJX-IIB listed below cannot be selected directly from the DJX-IIB panel. However, you can select them and play them from a connected MIDI device, such as a MIDI keyboard, sequencer or MIDI-equipped computer.

Bank Select		MIDI Program Change#	Voice Name
MSB	LSB		
HYPER MIX			
0	123	96	DJX-IIB
KEYBOARD			
0	112	4	Funky EP
0	0	1	Bright Piano
0	0	7	Clavi
0	0	9	Glocken
0	0	11	Vibes
0	0	12	Marimba
ELECTRIC PAD			
0	112	17	Jazz Organ
0	112	18	Rock Organ
0	113	16	Cheez Organ
0	114	17	Miss U
0	115	17	R&B Organ
0	0	17	Perc Organ
SYNTH PAD			
0	112	90	Sequenza
0	112	94	Insomnia
0	112	95	Wave 2001
0	113	91	Amber
0	112	91	Trance
0	0	89	Warm Pad
0	0	90	Poly Synth Pad
0	0	92	Bowed Pad
0	0	94	Halo Pad
0	0	95	Sweep Pad
ACOUSTIC PAD			
0	112	48	Strings 1
0	112	50	Syn Strings
0	113	50	String Pad
0	0	48	Strings 2
0	0	49	Strings 3
0	0	52	Choir Aah
GUITAR			
0	113	26	Octave
0	112	27	Clean 1
0	113	27	60's Clean
0	112	28	Muted
0	0	26	Jazz
0	0	27	Clean 2
0	0	30	Dist.
0	112	30	Dist.5th
SYNTH LEAD			
0	115	84	Fuzz line
0	113	84	Talkbox
0	114	84	Acid Sync
0	112	84	Adrenaline
0	112	85	Fragile
0	112	83	Cut Glass
0	0	82	Calliope Lead
BASS LEAD			
0	112	87	Killer S
0	118	87	Reso-X
0	117	87	Choppy
0	115	87	Happy Vibes
0	116	87	Tri Touch
0	119	87	Sync
0	0	87	Bass&Lead

Bank Select		MIDI Program Change#	Voice Name
MSB	LSB		
SQUARE LEAD			
0	116	80	Alien
0	115	80	Psyche
0	112	80	Square Lead1
0	113	80	Square Lead2
0	0	80	Square Lead3
SAW LEAD			
0	122	81	Breaklt
0	117	80	MC-Line
0	117	81	Scary
0	120	81	Movelt
0	119	81	Robot Lead
0	116	81	Fat
0	115	81	Seq Ana
0	118	81	Stab
0	112	81	Saw Lead1
0	113	81	Saw Lead2
0	0	81	Saw Lead3
ACOUSTIC LEAD			
0	112	73	Coco Flute
0	112	61	Bright Brass
0	114	62	Techno Brass
0	113	62	Jump Brass
0	0	56	Trumpet
0	0	59	Mute. Trumpet
0	0	61	Brass Section
0	0	62	Synth Brass1
0	0	63	Synth Brass2
0	0	65	Alto Sax
0	0	73	Flute
RESONANCE BASS			
0	113	38	Techno Bass
0	116	38	Kickin'B
0	114	38	Bassline
0	117	38	NuFloor
0	115	38	Fish303
0	119	38	NuSwing
0	112	38	Synth Bass1
0	0	38	Synth Bass2
ANALOG BASS			
0	112	39	Analog Bass
0	114	39	Snap Bass
0	115	39	Old Mini
0	116	39	Power Bass
0	117	39	Dub Bass
0	118	39	Factory
0	119	39	Hyper
0	120	38	Hard-Syn
0	120	39	Dist-Syn
0	121	39	Techno
0	113	39	Blip Bass
0	118	38	H-Bass
0	121	38	Sin Bass
0	122	38	OB Bass
0	122	39	Sub Osc
0	0	39	Syn Bass
BASIC BASS			
0	112	33	Finger Bass
0	112	34	Pick Bass

Bank Select		MIDI Program Change#	Voice Name
MSB	LSB		
0	112	35	Fretless
0	0	32	Aco. Bass
0	0	35	Fretless
SCRATCH			
0	123	80	Scratch 1F
0	123	81	Scratch 1B
0	123	82	Scratch 2F
0	123	83	Scratch 2B
0	123	84	Scratch 3F
0	123	85	Scratch 3B
0	123	86	Scratch 4F
0	123	87	Scratch 4B
SFX			
0	123	56	Reverse
0	112	126	Turntble
0	0	96	Rain
0	0	101	Goblins
0	0	102	Echoes
HIT			
0	113	55	Sharp Hit
0	113	115	Claps-X
0	0	113	Agogo
HUMAN VOICE			
0	123	0	Ain't Going Out (1)
0	123	1	Ain't Going Out (2)
0	123	2	Beat
0	123	3	Clap Your Hands
0	123	4	Club
0	123	5	Com On
0	123	6	DJ
0	123	7	Feel The Bass (1)
0	123	8	Feel The Bass (2)
0	123	9	Feel The Bass (3)
0	123	10	Huhh
0	123	11	Kickin'It
0	123	12	Massive
0	123	13	Movelt
0	123	14	My Flow Is Tight (1)
0	123	15	My Flow Is Tight (2)
0	123	16	My Flow Is Tight (3)
0	123	17	OK
0	123	18	Peace
0	123	19	Play That Beat (1)
0	123	20	Play That Beat (2)
0	123	21	Play That Beat (3)
0	123	22	Respect Is Due (1)
0	123	23	Respect Is Due (2)
0	123	24	Respect Is Due (3)
0	123	25	Scratchin'
0	123	26	The House
0	123	27	Uuh!
0	123	28	What's Going Down (1)
0	123	29	What's Going Down (2)
0	123	30	What's Going Down (3)
0	123	31	Wow
0	123	32	Yeah What's Up (1)
0	123	33	Yeah What's Up (2)
0	123	34	Yeah What's Up (3)
0	123	35	Yo Baby (1)

Bank Select		MIDI Program Change#	Voice Name
MSB	LSB		
0	123	36	Yo Baby (2)
0	123	40	I am Your DJ (robot) (1)
0	123	41	I am Your DJ (robot) (2)
0	123	42	I am Your DJ (robot) (3)
0	123	48	Rock The House (robot) (1)
0	123	49	Rock The House (robot) (2)
0	123	50	Rock The House (robot) (3)
0	123	44	Feel The Vibe (robot) (1)
0	123	45	Feel The Vibe (robot) (2)
0	123	46	Feel The Vibe (robot) (3)
0	123	52	The Real Bass (robot) (1)
0	123	53	The Real Bass (robot) (2)
0	123	54	The Real Bass (robot) (3)
DRUM LOOP			
0	123	68	Drum Loop T1
0	123	69	Drum Loop T2
0	123	70	Drum Loop T3
0	123	71	Drum Loop T4
HOP LOOP			
0	123	64	Drum Loop H1
0	123	65	Drum Loop H2
0	123	66	Drum Loop H3
0	123	67	Drum Loop H4
HYPER DRUM KIT			
127	0	5	Analog Kit1
127	0	8	Analog Kit2
127	0	10	Analog Kit3
127	0	13	Analog Kit1D
127	0	14	Analog Kit2D
127	0	12	RhBox Kit
127	0	9	Hard Kit
127	0	11	Break Kit
127	0	6	Dance Kit
127	0	4	Electronic Kit1
126	0	0	Electronic Kit2
126	0	1	B900 Kit
126	0	2	DJX Kit
126	0	3	BD Kit
126	0	4	SD Kit
126	0	5	HH Kit
126	0	6	Human Kit
126	0	7	Scratch Kit
BASIC DRUM KIT			
127	0	0	Standard Kit1
127	0	1	Standard Kit2
127	0	2	Room Kit
127	0	3	Rock Kit
127	0	7	Jazz Kit

Appendix Drum Kit List

- : Same as Standard Kit1.
- : Same as the kit to the immediate left.
- The Keyboard Note Numbers (#) and Note names shown in this list apply to all kits, with the exception of Voice #190 (Electronic Kit2), #191 (B900 Kit), #192 (DJX Kit), #196 (Human Kit) and #197 (Scratch Kit).
- In order to properly hear Voices #190 (Electronic Kit2), #191 (B900 Kit), and #192 (DJX Kit), play notes on the keyboard one octave lower than indicated.
- In order to properly hear Voices #196 (Human Kit) and #197 (Scratch Kit), play notes on the keyboard one octave higher than indicated.
- Key Off & Alternate Assign : These are applicable only for kits whose Bank MSB#=127.

Voice #		198	199	200	201	189	180	188	202	181	186		
Bank MSB#		127	127	127	127	127	127	127	127	127	127		
Bank LSB#		0	0	0	0	0	0	0	0	0	0		
Program #		0	1	2	3	4	5	6	7	8	9		
Keyboard Note#	MDI Note	Key off	Alternate assign	Standard Kit1	Standard Kit2	Room Kit	Rock Kit	Electronic Kit1	Analog Kit1	Dance Kit	Jazz Kit	Analog Kit2	Hard Kit
25	C# 0	13	C# -1	3	Surdo Mute								
26	D 0	14	D -1	3	Surdo Open								
27	D# 0	15	D# -1		Hi-Q								
28	E 0	16	E -1		Whip								
29	F 0	17	F -1	4	Scratch H								
30	F# 0	18	F# -1	4	Scratch L								
31	G 0	19	G -1		Finger Snap								
32	G# 0	20	G# -1		Click								
33	A 0	21	A -1		Metronome Click								
34	A# 0	22	A# -1		Metronome Bell								
35	B 0	23	B -1		Seq Click L								
36	C 1	24	C 0		Seq Click H								
37	C# 1	25	C# 0		Brush Tap								
38	D 1	26	D 0	O	Brush Swirl								
39	D# 1	27	D# 0		Brush Slap								
40	E 1	28	E 0	O	Brush Swirl W/Attack			Reverse Cymbal					
41	F 1	29	F 0	O	Snare Roll								
42	F# 1	30	F# 0		Castanet			Hi Q					
43	G 1	31	G 0		Snare H Soft	Snare H Soft2	SD Elec M	Snare L	SD Elec H2	SD Analog 2		SD T8 1	SD Hard 1
44	G# 1	32	G# 0		Sticks								
45	A 1	33	A 0		Bass Drum L	Bass Drum L2		Bass Drum H	Bass Drum H	BD Analog 2		BD Analog	BD Hard 1
46	A# 1	34	A# 0		Open Rim Shot	Open Rim Shot2				SD Analog Open Rim			SD Hard 2
47	B 1	35	B 0		Bass Drum M		Bass Drum H3	BD Rock	BD Analog 1L	BD Analog 3		BD T8 2	BD Hard 2
48	C 2	36	C 1		Bass Drum H	Bass Drum H 2		BD Rock 2	BD Analog 1H	BD Analog 4	BD Jazz	BD T8 3	BD Hard 3
49	C# 2	37	C# 1		Side Stick				Analog Side Stick 1			T8 Side Stick	
50	D 2	38	D 1		Snare L	Snare L2	SD Room L	SD Rock	SD Elec M	SD Analog 1H	SD Analog 3	SD Jazz L	SD T8 3L
51	D# 2	39	D# 1		Hand Clap								
52	E 2	40	E 1		Snare H Hard	Snare H Hard2	SD Room H	SD Rock Rim	SD Elec H	SD Analog 1L	SD Analog 4	SD Jazz H	SD T8 3M
53	F 2	41	F 1		Floor Tom L		Room Tom 1	Rock Tom 1	E Tom 1	Analog Tom 1	SD Analog 4	Jazz Tom 1	SD Hard 4
54	F# 2	42	F# 1	1	Hi-Hat Closed					Analog HH Closed1	Dance HH Closed1		T8 HH 1 Closed1
55	G 2	43	G 1		Floor Tom H		Room Tom 2	Rock Tom 2	E Tom 2	Analog Tom 2		Jazz Tom 2	Hard Tom 2
56	G# 2	44	G# 1	1	Hi-Hat Pedal					Analog HH Closed2	Dance HH Closed2		T8 HH 1 Closed2
57	A 2	45	A 1		Low Tom		Room Tom 3	Rock Tom 3	E Tom 3	Analog Tom 3		Jazz Tom 3	Hard Tom 3
58	A# 2	46	A# 1	1	Hi-Hat Open					Analog HH 1 Open	HH Open2		T8 HH 1 Open 1
59	B 2	47	B 1		Mid Tom L		Room Tom 4	Rock Tom 4	E Tom 4	Analog Tom 4		Jazz Tom 4	Hard Tom 4
60	C 3	48	C 2		Mid Tom H		Room Tom 5	Rock Tom 5	E Tom 5	Analog Tom 5		Jazz Tom 5	Hard Tom 5
61	C# 3	49	C# 2		Crash Cymbal 1					Analog Cymbal			
62	D 3	50	D 2		High Tom		Room Tom 6	Rock Tom 6	E Tom 6	Analog Tom 6		Jazz Tom 6	Hard Tom 6
63	D# 3	51	D# 2		Ride Cymbal 1								
64	E 3	52	E 2		Chinese Cymbal								
65	F 3	53	F 2		Ride Cymbal Cup								
66	F# 3	54	F# 2		Tambourine								
67	G 3	55	G 2		Splash Cymbal								
68	G# 3	56	G# 2		Cowbell				Analog Cowbell				
69	A 3	57	A 2		Crash Cymbal 2								
70	A# 3	58	A# 2		Hand Clap 1								
71	B 3	59	B 2		Ride Cymbal 2								
72	C 4	60	C 3		Bongo H								
73	C# 4	61	C# 3		Bongo L								
74	D 4	62	D 3		Conga H Mute				Analog Conga H				
75	D# 4	63	D# 3		Conga H Open				Analog Conga M				
76	E 4	64	E 3		Conga L				Analog Conga L				
77	F 4	65	F 3		Timbale H								
78	F# 4	66	F# 3		Timbale L								
79	G 4	67	G 3		Agogo H								
80	G# 4	68	G# 3		Agogo L								
81	A 4	69	A 3		Cabasa								
82	A# 4	70	A# 3		Maracas				Analog Maracas				
83	B 4	71	B 3	O	Samba Whistle H								
84	C 5	72	C 4	O	Samba Whistle L								
85	C# 5	73	C# 4		Guiro Short								
86	D 5	74	D 4	O	Guiro Long								
87	D# 5	75	D# 4		Claves				Analog Claves				
88	E 5	76	E 4		Wood Block H								
89	F 5	77	F 4		Wood Block L								
90	F# 5	78	F# 4		Scratch Push								
91	G 5	79	G 4		Scratch Pull								
92	G# 5	80	G# 4	2	Triangle Mute								
93	A 5	81	A 4	2	Triangle Open								
94	A# 5	82	A# 4		Shaker								
95	B 5	83	B 4		Hand Clap 2								
96	C 6	84	C 5		Hand Clap 3								
97	C# 6	85	C# 5										
98	D 6	86	D 5										
99	D# 6	87	D# 5										
100	E 6	88	E 5										
101	F 6	89	F 5										
102	F# 6	90	F# 5										
103	G 6	91	G 5										
104	G# 6	92	G# 5										
105	A 6	93	A 5										
106	A# 6	94	A# 5										
107	B 6	95	B 5										
108	C 7	96	C 6										

Drum Kit List

Voice #		198	182	187	185	183	184	190		
Bank MSB#		127	127	127	127	127	127	126		
Bank LSB#		0	0	0	0	0	0	0		
Program #		0	10	11	12	13	14	0		
Keyboard	MIDI	Key off	Alternate assign	Standard Kit1	Analog Kit3	Break Kit	RhBox Kit	Analog Kit1D	Analog Kit2D	Electronic Kit2
Note#	Note	Note#	Note							
25	C# 0	13	C# -1	3	Surdo Mute					
26	D 0	14	D -1	3	Surdo Open					
27	D# 0	15	D# -1		Hi-Q					
28	E 0	16	E -1		Whip					
29	F 0	17	F -1	4	Scratch H					
30	F# 0	18	F# -1	4	Scratch L					
31	G 0	19	G -1		Finger Snap					
32	G# 0	20	G# -1		Click					
33	A 0	21	A -1		Metronome Click					
34	A# 0	22	A# -1		Metronome Bell					
35	B 0	23	B -1		Seq Click L					
36	C 1	24	C 0		Seq Click H					
37	C# 1	25	C# 0		Brush Tap					
38	D 1	26	D 0	O	Brush Swirl					
39	D# 1	27	D# 0		Brush Slap					
40	E 1	28	E 0	O	Brush Swirl W/Attack			Reverse Cymbal		
41	F 1	29	F 0	O	Snare Roll					
42	F# 1	30	F# 0		Castanet			Hi Q		
43	G 1	31	G 0		Snare H Soft	SD T9 1	SD Break 1	SD RhBox 1	SD Elec H2	SD T9 Dist 1
44	G# 1	32	G# 0		Sticks					
45	A 1	33	A 0		Bass Drum L	BD Analog	BD Break 1	BD RhBox 1	BD Ana Dist 3	BD Analog
46	A# 1	34	A# 0		Open Rim Shot		SD Break 2	SD RhBox 2		
47	B 1	35	B 0		Bass Drum M	BD Jungle 4	BD Break 2	BD RhBox 2	BD Ana Dist 1	BD Jungle 4
48	C 2	36	C 1		Bass Drum H	BD T9 1	BD Break 3	BD RhBox 3	BD Ana Dist 2	BD T9 Dist 1
49	C# 2	37	C# 1		Side Stick	T9 Side Stick	Analog Side Stick 1		Analog Side Stick 1	T9 Side Stick
50	D 2	38	D 1		Snare L	SD T9 4L	SD Break 3	SD RhBox 3	SD Ana Dist 1	SD T9 Dist 4L
51	D# 2	39	D# 1		Hand Clap					SD T8 1
52	E 2	40	E 1		Snare H Hard	SD T9 4H	SD Break 4	SD RhBox 4	SD Ana Dist 2	SD T9 Dist 4H
53	F 2	41	F 1		Floor Tom L	T9 Tom 1	Analog Tom 1		Hard Tom 1	SD T8 4
54	F# 2	42	F# 1	1	Hi-Hat Closed	T9 HH 1 Closed1		RhBox HH Closed 1	Ana HH Clsd Dist 1	T9 HH 1 Clsd Dist 1
55	G 2	43	G 1		Floor Tom H	T9 Tom 2	Analog Tom 2		Hard Tom 2	T8 Conga 1
56	G# 2	44	G# 1	1	Hi-Hat Pedal	T9 HH 1 Closed2		RhBox HH Closed 2	Ana HH Clsd Dist 2	T9 HH 1 Clsd Dist 2
57	A 2	45	A 1		Low Tom	T9 Tom 3	Analog Tom 3		Hard Tom 3	T8 Conga 2
58	A# 2	46	A# 1	1	Hi-Hat Open	T9 HH 1 Open 2		Rh Box HH Open	Ana HH Opn Dist	T9 HH 1 Opn Dist 2
59	B 2	47	B 1		Mid Tom L	T9 Tom 4	Analog Tom 4		Hard Tom 4	T8 Conga 3
60	C 3	48	C 2		Mid Tom H	T9 Tom 5	Analog Tom 5		Hard Tom 5	T8 Conga 4
61	C# 3	49	C# 2		Crash Cymbal 1			Rh Box Cymbal	Analog Cymbal	T8 Side Stick
62	D 3	50	D 2		High Tom	T9 Tom 6	Analog Tom 6		Hard Tom 6	T8 Clave
63	D# 3	51	D# 2		Ride Cymbal 1					T8 Clap
64	E 3	52	E 2		Chinese Cymbal	T9 HH Half Open				
65	F 3	53	F 2		Ride Cymbal Cup					T8 Tom 1
66	F# 3	54	F# 2		Tambourine					T8 HH 1 Closed1
67	G 3	55	G 2		Splash Cymbal					T8 Tom 2
68	G# 3	56	G# 2		Cowbell			Analog Cowbell		T8 HH 1 Closed2
69	A 3	57	A 2		Crash Cymbal 2					T8 Tom 3
70	A# 3	58	A# 2		Hand Clap 1					T8 HH 1 Open
71	B 3	59	B 2		Ride Cymbal 2					T8 Tom 4
72	C 4	60	C 3		Bongo H					Analog Cymbal
73	C# 4	61	C# 3		Bongo L					
74	D 4	62	D 3		Conga H Mute			Analog Conga H		
75	D# 4	63	D# 3		Conga H Open			Analog Conga M		BD T9 1
76	E 4	64	E 3		Conga L			Analog Conga L		BD T9 3n
77	F 4	65	F 3		Timbale H					BD Jungle 4
78	F# 4	66	F# 3		Timbale L					T9 HH 1 Open 2
79	G 4	67	G 3		Agogo H					SD T9 1L
80	G# 4	68	G# 3		Agogo L					SD T9 2
81	A 4	69	A 3		Cabasa					SD T9 1M
82	A# 4	70	A# 3		Maracas			Analog Maracas		SD T9 3
83	B 4	71	B 3	O	Samba Whistle H					SD T9 1H
84	C 5	72	C 4	O	Samba Whistle L					SD T9 4L
85	C# 5	73	C# 4		Guiro Short					T9 Side Stick
86	D 5	74	D 4	O	Guiro Long					SD T9 4M
87	D# 5	75	D# 4		Claves			Analog Claves		T9 Clap
88	E 5	76	E 4		Wood Block H					SD T9 4H
89	F 5	77	F 4		Wood Block L					T9 Tom 1
90	F# 5	78	F# 4		Scratch Push					T9 HH 1 Closed1
91	G 5	79	G 4		Scratch Pull					T9 Tom 2
92	G# 5	80	G# 4	2	Triangle Mute					T9 HH 1 Closed2
93	A 5	81	A 4	2	Triangle Open					T9 Tom 3
94	A# 5	82	A# 4		Shaker					T9 HH 1 Open 2
95	B 5	83	B 4		Hand Clap 2					T9 Tom 4
96	C 6	84	C 5		Hand Clap 3					T9 Crash 1
97	C# 6	85	C# 5			Bell Tree 2			Bell Tree 2	T9 Ride
98	D 6	86	D 5			Bell Tree 3			Bell Tree 3	T9 Crash 2
99	D# 6	87	D# 5			BD T8 2			BD T8 2	
100	E 6	88	E 5			SD T8 4			SD T8 4	
101	F 6	89	F 5			SD T8 3H			SD T8 3H	
102	F# 6	90	F# 5			T8 HH 2 Closed1			T8 HH 2 Closed1	
103	G 6	91	G 5			T8 Cowbell			T8 Cowbell	
104	G# 6	92	G# 5			T8 HH 2 Closed2			T8 HH 2 Closed2	
105	A 6	93	A 5			T8 Tambourine			T8 Tambourine	
106	A# 6	94	A# 5			T8 HH 2 Open			T8 HH 2 Open	
107	B 6	95	B 5			T8 Guiro			T8 Guiro	
108	C 7	96	C 6			Metal			Metal	

Drum Kit List

Voice #		191	192	193	194	195	196	197			
Bank MSB#		126	126	126	126	126	126	126			
Bank LSB#		0	0	0	0	0	0	0			
Program #		1	2	3	4	5	6	7			
Keyboard	MIDI	Key off	Alternate assign	B900 Kit	DJX Kit	BD Kit	SD Kit	HH Kit	Human Kit	Scratch Kit	
Note#	Note	Note#	Note								
25	C# 0	13	C# -1								
26	D 0	14	D -1								
27	D# 0	15	D# -1								
28	E 0	16	E -1								
29	F 0	17	F -1								
30	F# 0	18	F# -1								
31	G 0	19	G -1								
32	G# 0	20	G# -1								
33	A 0	21	A -1								
34	A# 0	22	A# -1								
35	B 0	23	B -1								
36	C 1	24	C 0			BD1	SD1	HH1	Ain'tGoingOut(1)		
37	C# 1	25	C# 0			BD2	SD2	HH2	Ain'tGoingOut(2)		
38	D 1	26	D 0	O		BD3	SD3	HH3	Beat		
39	D# 1	27	D# 0			BD4	SD4	HH4	ClapYourHands		
40	E 1	28	E 0	O		BD5	SD5	HH5	Club		
41	F 1	29	F 0	O		BD6	SD6	HH6	ComOn		
42	F# 1	30	F# 0			BD7	SD7	HH7	DJ		
43	G 1	31	G 0			BD8	SD8	HH8	FeelTheBass(1)		
44	G# 1	32	G# 0			BD9	SD9	HH9	FeelTheBass(2)		
45	A 1	33	A 0			BD10	SD10	HH10	FeelTheBass(3)		
46	A# 1	34	A# 0			BD11	SD11	HH11	Huhh		
47	B 1	35	B 0			BD12	SD12	HH12	Kickin'It		
48	C 2	36	C 1		BD Jungle 4	BD00 T9 Distortion	BD13	SD13	HH13	Massive	Scratch1-F
49	C# 2	37	C# 1		BD T8 2Long	BD04 T9	BD14	SD14	HH14	MoveIt	Scratch1-R
50	D 2	38	D 1		BD Jungle 1	BD09 T8 Low Long	BD15	SD15	HH15	MyFlowsTight(1)	Scratch2-F
51	D# 2	39	D# 1		BD Jungle 2	BD28 T8	BD16	SD16	HH16	MyFlowsTight(2)	Scratch2-R
52	E 2	40	E 1		BD T8 2Cont	BD47 Hard Distortion	BD17	SD17	HH17	MyFlowsTight(3)	Scratch3-F
53	F 2	41	F 1		BD Jungle 5	BD55 Jungle	BD18	SD18	HH18	OK	Scratch3-R
54	F# 2	42	F# 1	1	BD HipHop1	SD00 T8	BD19	SD19	HH19	Peace	Scratch4-F
55	G 2	43	G 1		BD HipHop2	SD03 higher	BD20	SD20	HH20	PlayThatBeat(1)	Scratch4-R
56	G# 2	44	G# 1	1	SD Jungle 1	SD12 T9 4	BD21	SD21	HH21	PlayThatBeat(2)	Scratch L
57	A 2	45	A 1		SD Jungle 2	SD23 brutal	BD22	SD22	HH22	PlayThatBeat(3)	SCR 1M
58	A# 2	46	A# 1	1	SD Jungle 3	SD24 high metal	BD23	SD23	HH23	RespectsDue(1)	SCR 2M
59	B 2	47	B 1		SD Jungle 4	SD31 Elect.2	BD24	SD24	HH24	RespectsDue(2)	SCR 3M
60	C 3	48	C 2		SD HipHop1	SD43 T9 4	BD25	SD25	HH25	RespectsDue(3)	SCR 4M
61	C# 3	49	C# 2		SD HipHop2	SD47 noisy scratch	BD26	SD26	HH26	Scratchin'	SCR 6ML
62	D 3	50	D 2		SD HipHop3	SD49 T8 3	BD27	SD27	HH27	TheHouse	SCR 7ML
63	D# 3	51	D# 2		SD Elect.1	HH00 MS Closed	BD28	SD28	HH28	Uuuuugh	TurnTable
64	E 3	52	E 2		SD Elect.2	HH00 MS Open	BD29	SD29	HH29	What'sGoingDown(1)	
65	F 3	53	F 2		SD Elect.3	HH06 T9 Hard Closed	BD30	SD30	HH30	What'sGoingDown(2)	
66	F# 3	54	F# 2		SD Elect.4	HH06 T9 Hard Open	BD31	SD31	HH31	What'sGoingDown(3)	
67	G 3	55	G 2		SD T8 3M	HH07 T8 Closed	BD32	SD32	HH32	Wow	
68	G# 3	56	G# 2		SD 78	HH07 T8 Open	BD33	SD33	HH33	YeahWhat'sUp(1)	
69	A 3	57	A 2		HH 1 Closed	HH08 FX1 Closed	BD34	SD34	HH34	YeahWhat'sUp(2)	
70	A# 3	58	A# 2		HH 2 Closed	HH08 FX1 Open	BD35	SD35	HH35	YeahWhat'sUp(3)	
71	B 3	59	B 2		HH 2 Open	HH19 T9 Closed	BD36	SD36	HH36	YoBady(1)	
72	C 4	60	C 3		HH 3 Closed	HH19 T9 Open	BD37	SD37	HH37	YoBady(2)	
73	C# 4	61	C# 3		HH 78 Open	HH29 T6 Closed	BD38	SD38	HH38	IamYourDJ(robot)(1)	
74	D 4	62	D 3		HH 4 Closed	HH29 T6 Open	BD39	SD39	HH39	IamYourDJ(robot)(2)	
75	D# 4	63	D# 3		HH 4 Open	HH31 Nat Closed	BD40	SD40	HH40	IamYourDJ(robot)(3)	
76	E 4	64	E 3		PC Snap	HH31 Nat Open	BD41	SD41	HH41	RockTheHouse(robot)(1)	
77	F 4	65	F 3		PC Tamb2	HH37 FX2 Closed	BD42	SD42	HH42	RockTheHouse(robot)(2)	
78	F# 4	66	F# 3		BD Jungle 4Long	HH37 FX2 Open	BD43	SD43	HH43	RockTheHouse(robot)(3)	
79	G 4	67	G 3		BD Analog	HH40 T9Low Closed	BD44	SD44	HH44	FeelTheVibe(robot)(1)	
80	G# 4	68	G# 3		Hit 1L	HH40 T9Low Open	BD45	SD45	HH45	FeelTheVibe(robot)(2)	
81	A 4	69	A 3		Hit 1M	HH52 T8Metal Closed	BD46	SD46	HH46	FeelTheVibe(robot)(3)	
82	A# 4	70	A# 3		Hit 1H	HH52 T8Metal Open	BD47	SD47	HH47	TheRealBass(robot)(1)	
83	B 4	71	B 3	O	Hit 2L	HH56 T9Filt. Closed	BD48	SD48	HH48	TheRealBass(robot)(2)	
84	C 5	72	C 4	O	Hit 2M	HH56 T9Filt. Open	BD49	SD49	HH49	TheRealBass(robot)(3)	
85	C# 5	73	C# 4		Hit 2H	PC00G# Clave	BD50	SD50	HH50		
86	D 5	74	D 4	O	Hit Brass 1	PC02C Pulse		SD51			
87	D# 5	75	D# 4		SCR 1L	PC02C# Pulse		SD52			
88	E 5	76	E 4		SCR 1M	PC02D Pulse		SD53			
89	F 5	77	F 4		SCR 1H	PC02D# BD		SD54			
90	F# 5	78	F# 4		SCR 2L	PC02E Tom		SD55			
91	G 5	79	G 4		SCR 2M	PC02F SD		SD56			
92	G# 5	80	G# 4	2	SCR 2H	PC02F# Pulse&Noise		SD57			
93	A 5	81	A 4	2	SCR 3L	PC02G Pulse&Noise		SD58			
94	A# 5	82	A# 4		SCR 3M	PC02G# Snaps		SD59			
95	B 5	83	B 4		SCR 3H	PC02A Noise Echo		SD60			
96	C 6	84	C 5		SCR 4L	PP Perc.C3		SD61			
97	C# 6	85	C# 5		SCR 4M	PP Perc.F3		SD62			
98	D 6	86	D 5		SCR 4H	PP Snaps		SD63			
99	D# 6	87	D# 5		SCR 6L	PP Claps Bb2		SD64			
100	E 6	88	E 5		SCR 6ML	PP Claps C3		SD65			
101	F 6	89	F 5		SCR 6MH			SD66			
102	F# 6	90	F# 5		SCR 6H			SD67			
103	G 6	91	G 5		SCR 7L			SD68			
104	G# 6	92	G# 5		SCR 7ML			SD69			
105	A 6	93	A 5		SCR 7MH			SD70			
106	A# 6	94	A# 5		SCR 7H			SD71			
107	B 6	95	B 5		Hit Brass 2						
108	C 7	96	C 6		Analog Cymbal						

MIDI Data Format

Many MIDI messages listed in the MIDI Data Format are expressed as decimal numbers, binary numbers or hexadecimal numbers. Hexadecimal numbers may include the letter "H" as a suffix. Also, "n" can freely be defined as any whole number.

To enter data/values, refer to the table below.

Decimal	Hexadecimal	Binary
0	00	0000 0000
1	01	0000 0001
2	02	0000 0010
3	03	0000 0011
4	04	0000 0100
5	05	0000 0101
6	06	0000 0110
7	07	0000 0111
8	08	0000 1000
9	09	0000 1001
10	0A	0000 1010
11	0B	0000 1011
12	0C	0000 1100
13	0D	0000 1101
14	0E	0000 1110
15	0F	0000 1111
16	10	0001 0000
17	11	0001 0001
18	12	0001 0010
19	13	0001 0011
20	14	0001 0100
21	15	0001 0101
22	16	0001 0110
23	17	0001 0111
24	18	0001 1000
25	19	0001 1001
26	1A	0001 1010
27	1B	0001 1011
28	1C	0001 1100
29	1D	0001 1101
30	1E	0001 1110
31	1F	0001 1111

Decimal	Hexadecimal	Binary
32	20	0010 0000
33	21	0010 0001
34	22	0010 0010
35	23	0010 0011
36	24	0010 0100
37	25	0010 0101
38	26	0010 0110
39	27	0010 0111
40	28	0010 1000
41	29	0010 1001
42	2A	0010 1010
43	2B	0010 1011
44	2C	0010 1100
45	2D	0010 1101
46	2E	0010 1110
47	2F	0010 1111
48	30	0011 0000
49	31	0011 0001
50	32	0011 0010
51	33	0011 0011
52	34	0011 0100
53	35	0011 0101
54	36	0011 0110
55	37	0011 0111
56	38	0011 1000
57	39	0011 1001
58	3A	0011 1010
59	3B	0011 1011
60	3C	0011 1100
61	3D	0011 1101
62	3E	0011 1110
63	3F	0011 1111

Decimal	Hexadecimal	Binary
64	40	0100 0000
65	41	0100 0001
66	42	0100 0010
67	43	0100 0011
68	44	0100 0100
69	45	0100 0101
70	46	0100 0110
71	47	0100 0111
72	48	0100 1000
73	49	0100 1001
74	4A	0100 1010
75	4B	0100 1011
76	4C	0100 1100
77	4D	0100 1101
78	4E	0100 1110
79	4F	0100 1111
80	50	0101 0000
81	51	0101 0001
82	52	0101 0010
83	53	0101 0011
84	54	0101 0100
85	55	0101 0101
86	56	0101 0110
87	57	0101 0111
88	58	0101 1000
89	59	0101 1001
90	5A	0101 1010
91	5B	0101 1011
92	5C	0101 1100
93	5D	0101 1101
94	5E	0101 1110
95	5F	0101 1111

Decimal	Hexadecimal	Binary
96	60	0110 0000
97	61	0110 0001
98	62	0110 0010
99	63	0110 0011
100	64	0110 0100
101	65	0110 0101
102	66	0110 0110
103	67	0110 0111
104	68	0110 1000
105	69	0110 1001
106	6A	0110 1010
107	6B	0110 1011
108	6C	0110 1100
109	6D	0110 1101
110	6E	0110 1110
111	6F	0110 1111
112	70	0111 0000
113	71	0111 0001
114	72	0111 0010
115	73	0111 0011
116	74	0111 0100
117	75	0111 0101
118	76	0111 0110
119	77	0111 0111
120	78	0111 1000
121	79	0111 1001
122	7A	0111 1010
123	7B	0111 1011
124	7C	0111 1100
125	7D	0111 1101
126	7E	0111 1110
127	7F	0111 1111

- Other messages not listed above include: 144-159(decimal)/9nH/1001 0000-1001 1111(binary) denotes the Note On Message for each channel (1-16). 176-191/BnH/1011 0000-1011 1111 denotes the Control Change Message for each channel (1-16). 192-207/CnH/1100 0000-1100 1111 denotes the Program Change Message for each channel (1-16). 240/FOH/1111 0000 denotes the start of a System Exclusive Message. 247/F7H/1111 0111 denotes the end of a System Exclusive Message.
- aaH (hexidecimal)/0aaaaaaa (binary) denotes the data address. The address contains High, Mid, and Low.
- bbH/0bbbbbbb denotes the byte count.
- ccH/0ccccccc denotes the check sum.
- ddH/0ddddddd denotes the data/value.

MIDI Data Format

■ Channel/Mode/Realtime Messages

o : available

MIDI Events	Status byte		1st Data byte		2nd Data byte		MIDI	
	Status		Data (HEX)	Parameter	Data (HEX)	Parameter	Transmitted	Recognized
Key Off	8nH	(n:channel no.)	kk	Key no. (0 - 127)	vv	Velocity (0 - 127)	x	o
Key On	9nH		kk	Key no. (0 - 127)	vv	Key On :vv=1 - 127 Key Off :vv=0	x	o
Control Change	BnH		0 (00H)	Bank Select MSB	0 (00H) 126, 127 (7FH)	Normal Drum kit	x	o
			32 (20H)	Bank Select LSB			x	o
			1 (01H)	Modulation	0 - 127 (...7FH)		x	o
			6 (06H)	Data Entry MSB	0 - 127 (...7FH)		x	o
			38 (26H)	Data Entry LSB	0 - 127 (...7FH)		x	x
			7 (07H)	Main Volume	0 - 127 (...7FH)		x	o
			10 (0AH)	Panpot	0 - 127 (...7FH)		x	o
			11 (0BH)	Expression	0 - 127 (...7FH)		x	o
			64 (40H)	Sustain (Damper)	0 - 127 (...7FH)		x	o
			71 (47H)	Harmonic Content	0 - 127 (...7FH)		x	o
			72 (48H)	Release Time	0 - 127 (...7FH)		x	o
			73 (49H)	Attack Time	0 - 127 (...7FH)		x	o
			74 (4AH)	Brightness	0 - 127 (...7FH)		x	o
			84 (54H)	Portamento Control	0 - 127 (...7FH)		x	o
			91 (5BH)	Effect1 Depth (Reverb Send Level)	0 - 127 (...7FH)		x	o
			93 (5DH)	Effect3 Depth (Chorus Send Level)	0 - 127 (...7FH)		x	o
			96 (60H)	Increment	0 - 127 (...7FH)		x	o
			97 (61H)	Decrement	0 - 127 (...7FH)		x	o
100 (64H)	RPN LSB	0 - 127 (...7FH)		x	o			
101 (65H)	RPN MSB	0 - 127 (...7FH)		x	o			
Mode Message	BnH		120 (78H)	All sound off	0		x	o
			121 (79H)	Reset all controllers	0		x	o
			123 (7BH)	All note off	0		x	o
			124 (7CH)	All note off	0		x	o
			125 (7DH)	All note off	0		x	o
			126 (7EH)	MONO	0 - 16 (...10H)		x	o
			127 (7FH)	POLY	0		x	o
Program Change	CnH		pp	Voice number (0 - 127)	-	-	x	o
Pitch Bend Change	EnH		cc	LSB	dd	MSB	x	o
RealTime Message	F8H	MIDI Clock	-		-		o	o
	FAH	Start	-		-		o	o
	FCH	Stop	-		-		o	o
	FEH	Active Sensing	-		-		x	o

■ System Exclusive Messages

Universal System Exclusive

o : available

MIDI Event	Data Format	Transmitted	Recognized
MIDI Master Volume	F0H 7FH 7FH 04H 01H ll mm F7H	x	o
	ll mm Volume (mm = 0 - 7f, ll = Ignored)		
	or		
	F0H 7FH XN 04H 01H ll mm F7H	x	o
	XN when N is received N=0-F, whichever is received. X = Ignored		
	ll mm Volume (mm = 0 - 7f, ll = Ignored)		

XG standard

MIDI Event	Data Format	Transmitted	Recognized
XG Parameter Change	F0H 43H 1nH 4CH hh mm ll dd ... F7H	x	o
	hh mm ll Address dd Data		
Bulk Dump	F0H 43H 0nH 4CH aa bb hh mm ll dd ... dd cc F7H	x	o
	0n Device Number (0 - f (receive))		
	aa bb Byte Count (aa << 7) + bb		
	hh mm ll Address dd Data		

Bulk dump

MIDI Event	Data Format	Transmitted	Recognized
User Pattern Data Bulk Dump	F0H 43H 73H 6FH 06H 07H aa bb cc dd hh mm ll [BULK DATA] sum F7H	x	o
	6FH Model ID		
	06H Bulk ID		
	07H Bulk No.		
	aa ByteCount MSB		
	bb ByteCount LSB		
	cc Data size (MSB)		
	dd Data size (LSB)		
	hh Address High		
	mm Address Mid		
	ll Address Low		
	[BULK DATA] User Pattern data (1byte,2byte....7byte,MSBdata)		
	sum Check Sum = 0-sum (BULK DATA)		

Others

MIDI Event	Data Format	Transmitted	Recognized
Master Tune	F0H 43H 1n 27H 30H 00H 00H mm ll cc F7H	x	o
	1n Device Number (0 - f (receive)) mm ll cc (mm << 4) + ll (1step/1cent), cc = Ignored		
TG RESET	F0H 43H 73H 6FH 30H 00H F7H	x	o

MIDI Data Format

■ MIDI Parameter Change Table

MIDI PARAMETER CHANGE TABLE (EFFECT)

Address (H)	Size (H)	Data (H)	Parameter	Transmitted	Recognized	Description	Default
2 1 0	2	00-7F	REVERB TYPE MSB	x	o	Refer to "MIDI Effect Map." 00 : basic type	01 (=HALL1)
		00-7F	REVERB TYPE LSB				00
2 1 20	2	00-7F	CHORUS TYPE MSB	x	o	Refer to "MIDI Effect Map." 00 : basic type	41 (=CHORUS1)
		00-7F	CHORUS TYPE LSB				00
2 1 40	2	00-7F	VARIATION TYPE MSB	x	o*	Refer to "MIDI Effect Map." 00 : basic type	00 (=DJ DISTORTION)
		00-7F	VARIATION TYPE LSB				00

* Between MIDI messages and panel operation(Live Effector), the last message will take priority.

■ Effect Map

REVER BLOCK

Type MSB	Type LSB			
DEC	00	16	17	19
001	HALL 1		HALL 2	
002	ROOM		ROOM 1	ROOM 2
003	STAGE	STAGE 1	STAGE 2	
004	PLATE	PLATE 1	PLATE 2	
005...127				

If the received value does not contain an effect type in the TYPE LSB, the LSB will be directed to TYPE LSB 0.

CHORUS BLOCK

Type MSB	Type LSB			
DEC	00	02	08	17
001...064	NO EFFECT			
065	CHORUS	CHORUS 2		
066	CELESTE			CHORUS 1
067	FLANGER		FLANGER 1	FLANGER 2
068...127	NO EFFECT			

If the received value does not contain an effect type in the TYPE LSB, the LSB will be directed to TYPE LSB 0.

VARIATION BLOCK

Type MSB	Type LSB
DEC	00
001	DJ DISTORTION
002	DJ FLANGER
003	DJ PHASER
004	DJ DELAY
005	DJ ECHO
006	DJ RING MOD
007	DJ SLICE
008	DJ AUTO PAN
009	DJ WAH
010	DJ LO-FI

If the received value does not contain an effect type in the TYPE LSB, the LSB will be directed to TYPE LSB 0.

■ About MIDI remote control

About MIDI IN channel and DJX-IIB parts

The individual Parts of the DJX-IIB respond to incoming data over the MIDI channels as listed below.

MIDI IN channel

channel	
1	---- Reserved ----
2	---- Reserved ----
3	---- Reserved ----
4	Remote
5	---- Reserved ----
6	---- Reserved ----
7	---- Reserved ----
8	---- Reserved ----
9	Pattern Kick
10	Pattern Snare
11	Pattern Hi-Hat
12	Pattern Percussion
13	Pattern Bass
14	Pattern Phrase 1
15	Pattern Phrase 2
16	Pattern Phrase 3

Data received over channel 4 (Remote) is used to control the various panel controls of the DJX-IIB.

About MIDI remote control

Remote Control Data

Functions	Panel Operation	MIDI Data Format
Scratch Pad	Scratch Pad function selection	** = Scratch Kit Number Bank Select MSB (B3H, 00H, 00H) Bank Select LSB (B3H, 20H, 02H) Program Change (C3H, **H)
	Scrach Pad rocking Clockwise Counterclockwise Overall Pitch Control Pitch Control Volume	** = Note On (7FH), Note Off (00H) Note (93H, 5FH, **H) Note (93H, 60H, **H) Breath Controller MSB (B3H, 02H) Breath Controller LSB (B3H, 22H) Pitch Bend(E3H) Volume (B3H, 07H)
	LOOP on/off Loop off Loop on	Sustain (B3H, 40H, 00H) Sustain (B3H, 40H, 7FH)
Fader	FADER position	Expression (B3H, 0BH, **H) **= 00 - 7FH)
Pattern	Pattern Variation selection BANK A1 BANK A2 BANK A3 BANK A4 BANK A5 BANK B1 BANK B2 BANK B3 BANK B4 BANK B5	** = Note On (7FH), Note Off (00H) Note (93H, 48H, **H) Note (93H, 49H, **H) Note (93H, 4AH, **H) Note (93H, 4BH, **H) Note (93H, 4CH, **H) Note (93H, 4DH, **H) Note (93H, 4EH, **H) Note (93H, 4FH, **H) Note (93H, 50H, **H) Note (93H, 51H, **H)
	Pattern number selection	Bank Select MSB (B3H, 00H, 00H) Bank Select LSB (B3H, 20H, 01H) Program Change (C3H, **H) ** = Pattern Number Preset: 00H - 45H User: 46H - 4AH
	PART MIXER setting BASS+KICK PHRASE1+2+3 KICK+HI-HAT BASS KICK SNARE PHRASE1 HI-HAT PHRASE2 PERC PHRASE3 TOGGLE	** = Note On (7FH), Note Off (00H) — — — Note (93H, 3FH, **H) Note (93H, 40H, **H) Note (93H, 41H, **H) Note (93H, 42H, **H) Note (93H, 43H, **H) Note (93H, 44H, **H) Note (93H, 45H, **H) Note (93H, 46H, **H) —
Filter Knobs	CUTOFF knob RESONANCE knob	Brightness (B3H, 4AH, **H) Harmonic Content (B3H, 47H, **H) **= 00 - 7FH)

MIDI Data Format

Functions	Panel Operation	MIDI Data Format
Live Effector	ON/OFF switch	Soft Pedal (B3H, 43H, 7FH) Soft Pedal (B3H, 43H, 00H)
	Effect Type selection	Bank Select MSB (B3H, 00H, 00H) Bank Select LSB (B3H, 20H, 04H) Program Change (C3H, 00H) Program Change (C3H, 01H) Program Change (C3H, 02H) Program Change (C3H, 03H) Program Change (C3H, 04H) Program Change (C3H, 05H) Program Change (C3H, 06H) Program Change (C3H, 07H) Program Change (C3H, 08H) Program Change (C3H, 09H)
	DISTORTION AUTO PAN RING MOD FLANGER PHASER SLICER DELAY ECHO LO-FI WAH	
	CONTROL knob BALANCE knob	Effect4 Depth (B3H, 5EH, **H) Effect5 Depth (B3H, 5FH, **H) **= 00H - 7FH
Key Shifter	KEY SHIFTER setting	** = Note On (7FH), Note Off (00H)
	0	Note (93H, 24H, **H)
	1	Note (93H, 25H, **H)
	2	Note (93H, 26H, **H)
	3	Note (93H, 27H, **H)
	4	Note (93H, 28H, **H)
	5	Note (93H, 29H, **H)
	6	Note (93H, 2AH, **H)
	-5	Note (93H, 2BH, **H)
	-4	Note (93H, 2CH, **H)
	-3	Note (93H, 2DH, **H)
	-2	Note (93H, 2EH, **H)
	-1	Note (93H, 2FH, **H)
BPM setting	Scratch Pad rocking	General Purpose Controller Absolute tempo value MSB (B3H, 10H, mmH) Absolute tempo value LSB (B3H, 30H, llH) Relative tempo value MSB (B3H, 11H, mmH) Relative tempo value LSB (B3H, 31H, llH)
Other buttons	PATTERN button	Channel Pressure (D3H, 01H)
	BPM/TAP button	Channel Pressure (D3H, 03H)
	KEY SHIFTER button	Channel Pressure (D3H, 04H)
	PATTERN STOP button	Channel Pressure (D3H, 05H)

MIDI Implementation Chart

YAMAHA [DJ-GEAR]
Model DJX-IIB MIDI Implementation Chart

Date :17-MAR-2000
Version : 1.0

Function...	Transmitted	Recognized	Remarks
Basic Default Channel Changed	x x	1 - 16 1 - 16	
Mode Default Messages Altered	x x *****	3 x x	
Note Number : True voice	x *****	0 - 127 0 - 127	
Velocity Note ON Note OFF	x x	o 9nH,v=1-127 o 9nH,v=0 or 8nH	
After Key's Touch Ch's	x x	x x	
Pitch Bend	x	o	
Control Change 0,32 1 6,38 7,10 11 64 71-74 84 91,93 96,97 100,101	x x x x x x x x x x x	o o o o o o o o o o o	Bank Select Modulation wheel Data Entry Expression Sustain Sound Controller Portamento Control Effect Depth RPN Inc,Dec RPN LSB,MSB
Prog Change : True #	x *****	o 0 - 127	
System Exclusive	x	o *	
: Song Pos. Common : Song Sel. : Tune	x x x	x x x	
System : Clock Real Time: Commands	o o	o o	
Aux :All Sound OFF :Reset All Cntrls :Local ON/OFF Mes- :All Notes OFF sages:Active Sensing :Reset	x x x x x x	o(120,126,127) o(121) x o(123-125) o x	
Notes: * For details, see "MIDI Data Format" on page 83.			

Mode 1 : OMNI ON , POLY
Mode 3 : OMNI OFF, POLY

Mode 2 : OMNI ON ,MONO
Mode 4 : OMNI OFF,MONO

o : Yes
x : No

- A**
AC adaptor 12
AUDIO BPM COUNTER 9, 62
AUDIO BPM IN jack 11, 62
Auto Pan 21, 48
- B**
Balance (Live Effector) 20
Bank 9, 15
Bass 32, 68
bpm 19, 37, 45, 61, 62
bpm, auto-adjust 62
bpm, tapping 45
- C**
Control (Live Effector) 20
Crossfader 26, 34, 35, 44, 63
Cutoff 25, 39, 53
- D**
data backup 13
Delay 22, 50
Demo 9
Display 9
Distortion 21, 48
Drum Kit List 78, 79
- E**
Echo 23, 51
effects 5, 20, 48, 73
endings (outro) 64
Error Message List 71
- F**
fill-in 16, 47, 50, 58, 63
filter 9, 25, 53, 73
Flanger 21, 49
- G**
Glossary 73
- H**
High (Isolator) 24, 52
Hi-Hat 32, 68
HOLD 20
- I**
initialization 13
intro 47, 55
Isolator 24, 52, 73
- K**
key 36, 59
Key Shifter 9, 36
kick 32, 68
kits (Scratch Pad) 26
knob 9, 20, 24, 25, 39, 48, 52
- L**
LINE OUT jacks 11, 46
Live Effector 20, 48
Lo-Fi 23, 51
Loop (Scratch Pad) 9, 29, 40, 44, 73
Low (Isolator) 24, 52
- M**
Mid (Isolator) 24, 52
MIDI 65, 66, 67, 68, 69
MIDI Data Format 81
MIDI Implementation Chart 87
- P**
Part 32, 74
Part Mixer 32, 56
Pattern 14, 74
Pattern Launcher 68
Pattern List 75
Pattern Player 14
Pattern Stop 9, 14
Patterns, creating your own 68
Percussion 32, 68
Phaser 22, 49
PHONES 11
Phrase 32, 68
Pitch & bpm 40
- R**
Resonance 25, 73
Ring Modulation 21, 49
- S**
Scratch Pad 9, 10, 26, 55
scratch, scratching 74

Sense 62
sequencer 65, 66, 67
Slice 22, 49
Snare 32, 68
Specifications 72
Sync 8, 37, 40, 65, 66

T

transpose 36

V

Variation 74
Voice List 76
Volume 9, 13, 38

W

Wah 23, 51

FCC INFORMATION (U.S.A.)

1. IMPORTANT NOTICE: DO NOT MODIFY THIS UNIT!

This product, when installed as indicated in the instructions contained in this manual, meets FCC requirements. Modifications not expressly approved by Yamaha may void your authority, granted by the FCC, to use the product.

2. IMPORTANT: When connecting this product to accessories and/or another product use only high quality shielded cables. Cable/s supplied with this product **MUST** be used. Follow all installation instructions. Failure to follow instructions could void your FCC authorization to use this product in the USA.

3. NOTE: This product has been tested and found to comply with the requirements listed in FCC Regulations, Part 15 for Class "B" digital devices. Compliance with these requirements provides a reasonable level of assurance that your use of this product in a residential environment will not result in harmful interference with other electronic devices. This equipment generates/uses radio frequencies and, if not installed and used according to the instructions found in the users manual, may cause interference harmful to the operation of other electronic devices. Compliance

with FCC regulations does not guarantee that interference will not occur in all installations. If this product is found to be the source of interference, which can be determined by turning the unit "OFF" and "ON", please try to eliminate the problem by using one of the following measures:

Relocate either this product or the device that is being affected by the interference.

Utilize power outlets that are on different branch (circuit breaker or fuse) circuits or install AC line filter/s.

In the case of radio or TV interference, relocate/reorient the antenna. If the antenna lead-in is 300 ohm ribbon lead, change the lead-in to co-axial type cable.

If these corrective measures do not produce satisfactory results, please contact the local retailer authorized to distribute this type of product. If you can not locate the appropriate retailer, please contact Yamaha Corporation of America, Electronic Service Division, 6600 Orangethorpe Ave, Buena Park, CA90620

The above statements apply **ONLY** to those products distributed by Yamaha Corporation of America or its subsidiaries.

* This applies only to products distributed by YAMAHA CORPORATION OF AMERICA.

(class B)

OBSERVERA!

Apparaten kopplas inte ur växelströmskällan (nätet) så länge som den är ansluten till vägguttaget, även om själva apparaten har stängts av.

ADVARSEL: Netspændingen til dette apparat er IKKE afbrudt, så længe netledningen sidder i en stikkontakt, som er tændt — også selvom der er slukket på apparatets afbryder.

VAROITUS: Laitteen toisiopiiriin kytketty käyttökytkin ei irroita koko laitetta verkosta.

(standby)

Entsorgung leerer Batterien (nur innerhalb Deutschlands)

Leisten Sie einen Beitrag zum Umweltschutz. Verbrauchte Batterien oder Akkumulatoren dürfen nicht in den Hausmüll. Sie können bei einer Sammelstelle für Altbatterien bzw. Sondermüll abgegeben werden. Informieren Sie sich bei Ihrer Kommune.

(battery)

Limited Warranty

90 DAYS LABOR

1 YEAR PARTS

Yamaha Corporation of America, hereafter referred to as Yamaha, warrants to the original consumer of a product included in the categories listed below, that the product will be free of defects in materials and/or workmanship for the periods indicated. This warranty is applicable to all models included in the following series of products:

PSR SERIES OF PORTATONE ELECTRONIC KEYBOARDS

If during the first 90 days that immediately follows the purchase date, your new Yamaha product covered by this warranty is found to have a defect in material and/or workmanship, Yamaha and/or its authorized representative will repair such defect without charge for parts or labor.

If parts should be required after this 90 day period but within the one year period that immediately follows the purchase date, Yamaha will, subject to the terms of this warranty, supply these parts without charge. However, charges for labor, and/or any miscellaneous expenses incurred are the consumers responsibility. Yamaha reserves the right to utilize reconditioned parts in repairing these products and/or to use reconditioned units as warranty replacements.

THIS WARRANTY IS THE ONLY EXPRESS WARRANTY WHICH YAMAHA MAKES IN CONNECTION WITH THESE PRODUCTS. ANY IMPLIED WARRANTY APPLICABLE TO THE PRODUCT, INCLUDING THE WARRANTY OF MERCHANT ABILITY IS LIMITED TO THE DURATION OF THE EXPRESS WARRANTY. YAMAHA EXCLUDES AND SHALL NOT BE LIABLE IN ANY EVENT FOR INCIDENTAL OR CONSEQUENTIAL DAMAGES.

Some states do not allow limitations that relate to implied warranties and/or the exclusion of incidental or consequential damages. Therefore, these limitations and exclusions may not apply to you.

This warranty gives you specific legal rights. You may also have other rights which vary from state to state.

CONSUMERS RESPONSIBILITIES

If warranty service should be required, it is necessary that the consumer assume certain responsibilities:

1. Contact the Customer Service Department of the retailer selling the product, or any retail outlet authorized by Yamaha to sell the product for assistance. You may also contact Yamaha directly at the address provided below.
2. Deliver the unit to be serviced under warranty to: the retailer selling the product, an authorized service center, or to Yamaha with an explanation of the problem. Please be prepared to provide proof purchase date (sales receipt, credit card copy, etc.) when requesting service and/or parts under warranty.
3. Shipping and/or insurance costs are the consumers responsibility.* Units shipped for service should be packed securely.

*Repaired units will be returned PREPAID if warranty service is required within the first 90 days.

IMPORTANT: Do NOT ship anything to ANY location without prior authorization. A Return Authorization (RA) will be issued that has a tracking number assigned that will expedite the servicing of your unit and provide a tracking system if needed.

4. Your owners manual contains important safety and operating instructions. It is your responsibility to be aware of the contents of this manual and to follow all safety precautions.

EXCLUSIONS

This warranty does not apply to units whose trade name, trademark, and/or ID numbers have been altered, defaced, exchanged removed, or to failures and/or damages that may occur as a result of:

1. Neglect, abuse, abnormal strain, modification or exposure to extremes in temperature or humidity.
2. Improper repair or maintenance by any person who is not a service representative of a retail outlet authorized by Yamaha to sell the product, an authorized service center, or an authorized service representative of Yamaha.
3. This warranty is applicable only to units sold by retailers authorized by Yamaha to sell these products in the U.S.A., the District of Columbia, and Puerto Rico. This warranty is not applicable in other possessions or territories of the U.S.A. or in any other country.

Please record the model and serial number of the product you have purchased in the spaces provided below.

Model _____ Serial # _____ Sales Slip # _____

Purchased from _____ Date _____
(Retailer)

YAMAHA CORPORATION OF AMERICA
Electronic Service Division
6600 Orangethorpe Avenue
Buena Park, CA 90620

KEEP THIS DOCUMENT FOR YOUR RECORDS. DO NOT MAIL!

For details of products, please contact your nearest Yamaha or the authorized distributor listed below.

Pour plus de détails sur les produits, veuillez-vous adresser à Yamaha ou au distributeur le plus proche de vous figurant dans la liste suivante.

Die Einzelheiten zu Produkten sind bei Ihrer unten aufgeführten Niederlassung und bei Yamaha Vertragshändlern in den jeweiligen Bestimmungsländern erhältlich.

Para detalles sobre productos, contacte su tienda Yamaha más cercana o el distribuidor autorizado que se lista debajo.

NORTH AMERICA

CANADA

Yamaha Canada Music Ltd.
135 Milner Avenue, Scarborough, Ontario,
M1S 3R1, Canada
Tel: 416-298-1311

U.S.A.

Yamaha Corporation of America
6600 Orangethorpe Ave., Buena Park, Calif. 90620,
U.S.A.
Tel: 714-522-9011

CENTRAL & SOUTH AMERICA

MEXICO

**Yamaha de Mexico S.A. De C.V.,
Departamento de ventas**
Javier Rojo Gomez No.1149, Col. Gpe Del
Moral, Deleg. Iztapalapa, 09300 Mexico, D.F.
Tel: 686-00-33

BRAZIL

Yamaha Musical do Brasil LTDA.
Av. Rebouças 2636, São Paulo, Brasil
Tel: 011-853-1377

ARGENTINA

Yamaha Music Argentina S.A.
Viamonte 1145 Piso 2-B 1053,
Buenos Aires, Argentina
Tel: 1-371-7021

PANAMA AND OTHER LATIN AMERICAN COUNTRIES/ CARIBBEAN COUNTRIES

Yamaha de Panama S.A.
Torre Banco General, Piso 7, Urbanización Marbella,
Calle 47 y Aquilino de la Guardia,
Ciudad de Panamá, Panamá
Tel: 507-269-5311

EUROPE

THE UNITED KINGDOM

Yamaha-Kemble Music (U.K.) Ltd.
Sherbourne Drive, Tilbrook, Milton Keynes,
MK7 8BL, England
Tel: 01908-366700

IRELAND

Danfay Ltd.
61D, Sallynoggin Road, Dun Laoghaire, Co. Dublin
Tel: 01-2859177

GERMANY/SWITZERLAND

Yamaha Europa GmbH.
Siemensstraße 22-34, 25462 Rellingen,
F.R. of Germany
Tel: 04101-3030

AUSTRIA

Yamaha Music Austria
Schleiergasse 20, A-1100 Wien Austria
Tel: 01-60203900

THE NETHERLANDS

Yamaha Music Nederland
Kanaalweg 18G, 3526KL, Utrecht, The Netherlands
Tel: 030-2828411

BELGIUM

Yamaha Music Belgium
Keiberg Imperiastraat 8, 1930 Zaventem, Belgium
Tel: 02-7258220

FRANCE

**Yamaha Musique France,
Division Claviers**
BP 70-77312 Marne-la-Vallée Cedex 2, France
Tel: 01-64-61-4000

ITALY

**Yamaha Musica Italia S.P.A.,
Home Keyboard Division**
Viale Italia 88, 20020 Lainate (Milano), Italy
Tel: 02-935-771

SPAIN/PORTUGAL

Yamaha-Hazen Electronica Musical, S.A.
Ctra. de la Coruna km. 17, 200, 28230
Las Rozas (Madrid) Spain
Tel: 91-201-0700

GREECE

Philippe Nakas S.A.
Navarinou Street 13, P.Code 10680, Athens, Greece
Tel: 01-364-7111

SWEDEN

Yamaha Scandinavia AB
J. A. Wettergrens Gata 1
Box 30053
S-400 43 Göteborg, Sweden
Tel: 031 89 34 00

DENMARK

YS Copenhagen Liaison Office
Generatorvej 8B
DK-2730 Herlev, Denmark
Tel: 44 92 49 00

FINLAND

F-Musiikki Oy
Kluuvikatu 6, P.O. Box 260,
SF-00101 Helsinki, Finland
Tel: 09 618511

NORWAY

Norsk filial av Yamaha Scandinavia AB
Grini Næringspark 1
N-1345 Østerås, Norway
Tel: 67 16 77 70

ICELAND

Skifan HF
Skeifan 17 P.O. Box 8120
IS-128 Reykjavik, Iceland
Tel: 525 5000

OTHER EUROPEAN COUNTRIES

Yamaha Europa GmbH.
Siemensstraße 22-34, 25462 Rellingen,
F.R. of Germany
Tel: 04101-3030

AFRICA

**Yamaha Corporation,
International Marketing Division**
Nakazawa-cho 10-1, Hamamatsu, Japan 430-8650
Tel: 053-460-2312

MIDDLE EAST

TURKEY/CYPRUS

Yamaha Europa GmbH.
Siemensstraße 22-34, 25462 Rellingen,
F.R. of Germany
Tel: 04101-3030

OTHER COUNTRIES

Yamaha Music Gulf FZE
LB21-128 Jebel Ali Freezone
P.O.Box 17328, Dubai, U.A.E.
Tel: 971-4-81-5868

ASIA

HONG KONG

Tom Lee Music Co., Ltd.
11/F., Silvercord Tower 1, 30 Canton Road,
Tsimshatsui, Kowloon, Hong Kong
Tel: 2737-7688

INDONESIA

**PT. Yamaha Music Indonesia (Distributor)
PT. Nusantik**
Gedung Yamaha Music Center, Jalan Jend. Gatot
Subroto Kav. 4, Jakarta 12930, Indonesia
Tel: 21-520-2577

KOREA

Cosmos Corporation
1461-9, Seocho Dong, Seocho Gu, Seoul, Korea
Tel: 02-3486-0011

MALAYSIA

Yamaha Music Malaysia, Sdn., Bhd.
Lot 8, Jalan Perbandaran, 47301 Kelana Jaya,
Petaling Jaya, Selangor, Malaysia
Tel: 3-703-0900

PHILIPPINES

Yupangco Music Corporation
339 Gil J. Puyat Avenue, P.O. Box 885 MCPO,
Makati, Metro Manila, Philippines
Tel: 819-7551

SINGAPORE

Yamaha Music Asia Pte., Ltd.
11 Ubi Road #06-00, Meiban Industrial Building,
Singapore
Tel: 65-747-4374

TAIWAN

Yamaha KHS Music Co., Ltd.
10F, 150, Tun-Hwa Northroad,
Taipei, Taiwan, R.O.C.
Tel: 02-2713-8999

THAILAND

Siam Music Yamaha Co., Ltd.
121/60-61 RS Tower 17th Floor,
Ratchadaphisek RD., Dindaeng,
Bangkok 10320, Thailand
Tel: 02-641-2951

THE PEOPLE'S REPUBLIC OF CHINA AND OTHER ASIAN COUNTRIES

**Yamaha Corporation,
International Marketing Division**
Nakazawa-cho 10-1, Hamamatsu, Japan 430-8650
Tel: 053-460-2317

OCEANIA

AUSTRALIA

Yamaha Music Australia Pty. Ltd.
17-33 Market Street, South Melbourne, Vic. 3205,
Australia
Tel: 3-699-2388

NEW ZEALAND

Music Houses of N.Z. Ltd.
146/148 Captain Springs Road, Te Papapa,
Auckland, New Zealand
Tel: 9-634-0099

COUNTRIES AND TRUST TERRITORIES IN PACIFIC OCEAN

**Yamaha Corporation,
International Marketing Group**
Nakazawa-cho 10-1, Hamamatsu, Japan 430-8650
Tel: 053-460-2312

HEAD OFFICE Yamaha Corporation, Pro Audio & Digital Musical Instrument Division
Nakazawa-cho 10-1, Hamamatsu, Japan 430-8650
Tel: 053-460-3273

