



# PSR-A3000

Digital Workstation

Owner's Manual

Thank you for purchasing this Yamaha Digital Workstation!  
We recommend that you read this manual carefully so that you can fully take advantage of the advanced and convenient functions of the instrument. We also recommend that you keep this manual in a safe and handy place for future reference.  
**Before using the instrument, be sure to read "PRECAUTIONS" on pages 5 – 6.**



## SPECIAL MESSAGE SECTION

This product utilizes batteries or an external power supply (adapter). DO NOT connect this product to any power supply or adapter other than one described in the manual, on the name plate, or specifically recommended by Yamaha.

**WARNING:** Do not place this product in a position where anyone could walk on, trip over, or roll anything over power or connecting cords of any kind. The use of an extension cord is not recommended! If you must use an extension cord, the minimum wire size for a 25' cord (or less) is 18 AWG. NOTE: The smaller the AWG number, the larger the current handling capacity. For longer extension cords, consult a local electrician.

This product should be used only with the components supplied or; a cart, rack, or stand that is recommended by Yamaha. If a cart, etc., is used, please observe all safety markings and instructions that accompany the accessory product.

### SPECIFICATIONS SUBJECT TO CHANGE:

The information contained in this manual is believed to be correct at the time of printing. However, Yamaha reserves the right to change or modify any of the specifications without notice or obligation to update existing units.

This product, either alone or in combination with an amplifier and headphones or speaker/s, may be capable of producing sound levels that could cause permanent hearing loss. DO NOT operate for long periods of time at a high volume level or at a level that is uncomfortable. If you experience any hearing loss or ringing in the ears, you should consult an audiologist.

**IMPORTANT:** The louder the sound, the shorter the time period before damage occurs.

Some Yamaha products may have benches and / or accessory mounting fixtures that are either supplied with the product or as optional accessories. Some of these items are designed to be dealer assembled or installed. Please make sure that benches are stable and any optional fixtures (where applicable) are well secured BEFORE using.

Benches supplied by Yamaha are designed for seating only. No other uses are recommended.

### NOTICE:

Service charges incurred due to a lack of knowledge relating to how a function or effect works (when the unit is operating as designed) are not covered by the manufacturer's warranty, and are therefore the owners responsibility. Please study this manual carefully and consult your dealer before requesting service.

### ENVIRONMENTAL ISSUES:

Yamaha strives to produce products that are both user safe and environmentally friendly. We sincerely believe that our products and the production methods used to produce them, meet these goals. In keeping with both the letter and the spirit of the law, we want you to be aware of the following:

### Battery Notice:

This product MAY contain a small non-rechargeable battery which (if applicable) is soldered in place. The average life span of this type of battery is approximately five years. When replacement becomes necessary, contact a qualified service representative to perform the replacement.

This product may also use "household" type batteries. Some of these may be rechargeable. Make sure that the battery being charged is a rechargeable type and that the charger is intended for the battery being charged.

When installing batteries, never mix old batteries with new ones, and never mix different types of batteries. Batteries MUST be installed correctly. Mismatches or incorrect installation may result in overheating and battery case rupture.

### Warning:

Do not attempt to disassemble, or incinerate any battery. Keep all batteries away from children. Dispose of used batteries promptly and as regulated by the laws in your area. Note: Check with any retailer of household type batteries in your area for battery disposal information.

### Disposal Notice:

Should this product become damaged beyond repair, or for some reason its useful life is considered to be at an end, please observe all local, state, and federal regulations that relate to the disposal of products that contain lead, batteries, plastics, etc. If your dealer is unable to assist you, please contact Yamaha directly.

### NAME PLATE LOCATION:

The name plate is located on the bottom of the product. The model number, serial number, power requirements, etc., are located on this plate. You should record the model number, serial number, and the date of purchase in the spaces provided below and retain this manual as a permanent record of your purchase.

Model

---

Serial No.

---

Purchase Date

---

## PLEASE KEEP THIS MANUAL

92-BP (bottom)

## For PSR-A3000

### COMPLIANCE INFORMATION STATEMENT (DECLARATION OF CONFORMITY PROCEDURE)

Responsible Party : Yamaha Corporation of America  
Address : 6600 Orangethorpe Ave., Buena Park, Calif. 90620  
Telephone : 714-522-9011  
Type of Equipment : Digital Keyboard  
Model Name : PSR-A3000

This device complies with Part 15 of the FCC Rules.  
Operation is subject to the following two conditions:  
1) this device may not cause harmful interference, and  
2) this device must accept any interference received including interference that may cause undesired operation.  
See user manual instructions if interference to radio reception is suspected.

\* This applies only to products distributed by YAMAHA CORPORATION OF AMERICA.

(FCC DoC)

## For AC adaptor and PSR-A3000

### FCC INFORMATION (U.S.A.)

**1. IMPORTANT NOTICE: DO NOT MODIFY THIS UNIT!**

This product, when installed as indicated in the instructions contained in this manual, meets FCC requirements. Modifications not expressly approved by Yamaha may void your authority, granted by the FCC, to use the product.

**2. IMPORTANT:** When connecting this product to accessories and/or another product use only high quality shielded cables. Cable/s supplied with this product **MUST** be used. Follow all installation instructions. Failure to follow instructions could void your FCC authorization to use this product in the USA.

**3. NOTE:** This product has been tested and found to comply with the requirements listed in FCC Regulations, Part 15 for Class "B" digital devices. Compliance with these requirements provides a reasonable level of assurance that your use of this product in a residential environment will not result in harmful interference with other electronic devices. This equipment generates/uses radio frequencies and, if not installed and used according to the instructions found in the users manual, may cause interference harmful to the operation of other electronic devices. Compliance with FCC regulations does not guarantee

that interference will not occur in all installations. If this product is found to be the source of interference, which can be determined by turning the unit "OFF" and "ON", please try to eliminate the problem by using one of the following measures:

Relocate either this product or the device that is being affected by the interference.

Utilize power outlets that are on different branch (circuit breaker or fuse) circuits or install AC line filter/s.

In the case of radio or TV interference, relocate/reorient the antenna. If the antenna lead-in is 300 ohm ribbon lead, change the lead-in to co-axial type cable.

If these corrective measures do not produce satisfactory results, please contact the local retailer authorized to distribute this type of product. If you can not locate the appropriate retailer, please contact Yamaha Corporation of America, Electronic Service Division, 6600 Orangethorpe Ave, Buena Park, CA90620

The above statements apply **ONLY** to those products distributed by Yamaha Corporation of America or its subsidiaries.

\* This applies only to products distributed by YAMAHA CORPORATION OF AMERICA.

(class B)

## For AC adaptor

This device complies with Part 15 of the FCC Rules. Operation is subject to the following two conditions: (1) this device may not cause harmful interference, and (2) this device must accept any interference received, including interference that may cause undesired operation.

(fcc\_sengen)

### CAN ICES-3 (B)/NMB-3(B)

- This applies only to products distributed by Yamaha Canada Music Ltd.
- Ceci ne s'applique qu'aux produits distribués par Yamaha Canada Musique Ltée.  
(can\_b\_01)

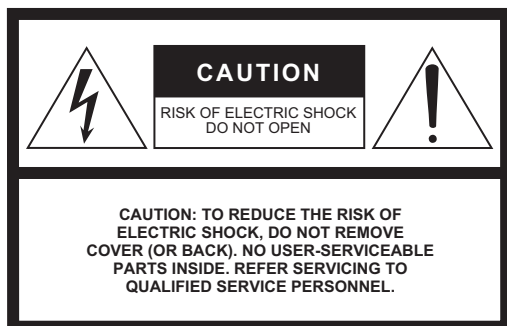

### Explanation of Graphical Symbols



The lightning flash with arrowhead symbol within an equilateral triangle is intended to alert the user to the presence of uninsulated “dangerous voltage” within the product’s enclosure that may be of sufficient magnitude to constitute a risk of electric shock to persons.



The exclamation point within an equilateral triangle is intended to alert the user to the presence of important operating and maintenance (servicing) instructions in the literature accompanying the product.

## IMPORTANT SAFETY INSTRUCTIONS

- 1 Read these instructions.
- 2 Keep these instructions.
- 3 Heed all warnings.
- 4 Follow all instructions.
- 5 Do not use this apparatus near water.
- 6 Clean only with dry cloth.
- 7 Do not block any ventilation openings. Install in accordance with the manufacturer’s instructions.
- 8 Do not install near any heat sources such as radiators, heat registers, stoves, or other apparatus (including amplifiers) that produce heat.
- 9 Do not defeat the safety purpose of the polarized or grounding-type plug. A polarized plug has two blades with one wider than the other. A grounding type plug has two blades and a third grounding prong. The wide blade or the third prong are provided for your safety. If the provided plug does not fit into your outlet, consult an electrician for replacement of the obsolete outlet.
- 10 Protect the power cord from being walked on or pinched particularly at plugs, convenience receptacles, and the point where they exit from the apparatus.
- 11 Only use attachments/accessories specified by the manufacturer.
- 12 Use only with the cart, stand, tripod, bracket, or table specified by the manufacturer, or sold with the apparatus. When a cart is used, use caution when moving the cart/apparatus combination to avoid injury from tip-over.
- 13 Unplug this apparatus during lightning storms or when unused for long periods of time.
- 14 Refer all servicing to qualified service personnel. Servicing is required when the apparatus has been damaged in any way, such as power-supply cord or plug is damaged, liquid has been spilled or objects have fallen into the apparatus, the apparatus has been exposed to rain or moisture, does not operate normally, or has been dropped.



### WARNING

TO REDUCE THE RISK OF FIRE OR ELECTRIC SHOCK, DO NOT EXPOSE THIS APPARATUS TO RAIN OR MOISTURE.

(UL60065\_03)

# PRECAUTIONS

## PLEASE READ CAREFULLY BEFORE PROCEEDING

Please keep this manual in a safe and handy place for future reference.

### For AC adaptor



#### WARNING

- This AC adaptor is designed for use with only Yamaha electronic instruments. Do not use for any other purpose.
- Indoor use only. Do not use in any wet environments.



#### CAUTION

- When setting up, make sure that the AC outlet is easily accessible. If some trouble or malfunction occurs, immediately turn off the power switch of the instrument and disconnect the AC adaptor from the outlet. When the AC adaptor is connected to the AC outlet, keep in mind that electricity is flowing at the minimum level, even if the power switch is turned off. When you are not using the instrument for a long time, make sure to unplug the power cord from the wall AC outlet.

### For PSR-A3000



#### WARNING

Always follow the basic precautions listed below to avoid the possibility of serious injury or even death from electrical shock, short-circuiting, damages, fire or other hazards. These precautions include, but are not limited to, the following:

#### Power supply/AC adaptor

- Do not place the power cord near heat sources such as heaters or radiators. Also, do not excessively bend or otherwise damage the cord, or place heavy objects on it.
- Only use the voltage specified as correct for the instrument. The required voltage is printed on the name plate of the instrument.
- Use the specified adaptor (page 215) only. Using the wrong adaptor can result in damage to the instrument or overheating.
- Check the electric plug periodically and remove any dirt or dust which may have accumulated on it.

#### Do not open

- This instrument contains no user-serviceable parts. Do not open the instrument or attempt to disassemble or modify the internal components in any way. If it should appear to be malfunctioning, discontinue use immediately and have it inspected by qualified Yamaha service personnel.

#### Water warning

- Do not expose the instrument to rain, use it near water or in damp or wet conditions, or place on it any containers (such as vases, bottles or glasses) containing liquids which might spill into any openings. If any liquid such as water seeps into the instrument, turn off the power immediately and unplug the power cord from the AC outlet. Then have the instrument inspected by qualified Yamaha service personnel.
- Never insert or remove an electric plug with wet hands.

#### Fire warning

- Do not put burning items, such as candles, on the unit. A burning item may fall over and cause a fire.

#### If you notice any abnormality

- When one of the following problems occur, immediately turn off the power switch and disconnect the electric plug from the outlet. Then have the device inspected by Yamaha service personnel.
  - The power cord or plug becomes frayed or damaged.
  - It emits unusual smells or smoke.
  - Some object has been dropped into the instrument.
  - There is a sudden loss of sound during use of the instrument.



## CAUTION

Always follow the basic precautions listed below to avoid the possibility of physical injury to you or others, or damage to the instrument or other property. These precautions include, but are not limited to, the following:

### Power supply/AC adaptor

- Do not connect the instrument to an electrical outlet using a multiple-connector. Doing so can result in lower sound quality, or possibly cause overheating in the outlet.
- When removing the electric plug from the instrument or an outlet, always hold the plug itself and not the cord. Pulling by the cord can damage it.
- Remove the electric plug from the outlet when the instrument is not to be used for extended periods of time, or during electrical storms.

### Location

- Do not place the instrument in an unstable position where it might accidentally fall over.
- Do not place objects in front of the instrument's air vent, since this may prevent adequate ventilation of the internal components, and possibly result in the instrument overheating.
- Before moving the instrument, remove all connected cables, to prevent damage to the cables or injury to anyone who might trip over them.
- When setting up the product, make sure that the AC outlet you are using is easily accessible. If some trouble or malfunction occurs, immediately turn off the power switch and disconnect the plug from the outlet. Even when the power switch is turned off, electricity is still flowing to the product at the minimum level. When you are not using the product for a long time, make sure to unplug the power cord from the wall AC outlet.

- Use only the stand specified for the instrument. When attaching it, use the provided screws only. Failure to do so could cause damage to the internal components or result in the instrument falling over.

### Connections

- Before connecting the instrument to other electronic components, turn off the power for all components. Before turning the power on or off for all components, set all volume levels to minimum.
- Be sure to set the volumes of all components at their minimum levels and gradually raise the volume controls while playing the instrument to set the desired listening level.

### Handling caution

- Do not insert a finger or hand in any gaps on the instrument.
- Never insert or drop paper, metallic, or other objects into the gaps on the panel or keyboard. This could cause physical injury to you or others, damage to the instrument or other property, or operational failure.
- Do not rest your weight on, or place heavy objects on the instrument, and do not use excessive force on the buttons, switches or connectors.
- Do not use the instrument/device or headphones for a long period of time at a high or uncomfortable volume level, since this can cause permanent hearing loss. If you experience any hearing loss or ringing in the ears, consult a physician.

Yamaha cannot be held responsible for damage caused by improper use or modifications to the instrument, or data that is lost or destroyed.

Always turn the power off when the instrument is not in use.

Even when the [  ] (Standby/On) switch is in standby status (display is off), electricity is still flowing to the instrument at the minimum level.

When you are not using the instrument for a long time, make sure you unplug the power cord from the wall AC outlet.

DMI-5 2/2

## NOTICE

To avoid the possibility of malfunction/ damage to the product, damage to data, or damage to other property, follow the notices below.

### ■ Handling

- Do not use the instrument in the vicinity of a TV, radio, stereo equipment, mobile phone, or other electric devices. Otherwise, the instrument, TV, or radio may generate noise. When you use the instrument along with an application on your iPad, iPhone or iPod touch, we recommend that you set "Airplane Mode" to "ON" on that device in order to avoid noise caused by communication.
- Do not expose the instrument to excessive dust or vibrations, or extreme cold or heat (such as in direct sunlight, near a heater, or in a car during the day) to prevent the possibility of panel disfiguration, damage to the internal components or unstable operation. (Verified operating temperature range: 5° – 40°C, or 41° – 104°F.)
- Do not place vinyl, plastic or rubber objects on the instrument, since this might discolor the panel or keyboard.

### ■ Maintenance

- When cleaning the instrument, use a soft cloth. Do not use paint thinners, solvents, alcohol, cleaning fluids, or chemical-impregnated wiping cloths.

### ■ Saving data

- The edited Songs/Styles/Voices/Multi Pads and MIDI settings are lost when you turn off the power to the instrument. This also occurs when the power is turned off by the Auto Power Off function (page 17). Save the edited data to the instrument, or to a USB flash drive (page 28). However, the data saved to the instrument may be lost due to some failure, an operation mistake, etc. Save your important data onto a USB flash drive. For information about the handling of USB flash drive, refer to page 95.
- To protect against data loss through USB flash drive damage, we recommend that you save your important data onto spare USB flash drive or an external device such as a computer as backup data.

The model number, serial number, power requirements, etc., may be found on or near the name plate, which is at the bottom of the unit. You should note this serial number in the space provided below and retain this manual as a permanent record of your purchase to aid identification in the event of theft.

Model No. \_\_\_\_\_

Serial No. \_\_\_\_\_

(bottom\_en\_01)

# Included Accessories

- Owner's Manual (this book)
- Online Member Product Registration  
The "PRODUCT ID" on the sheet will be needed when you fill out the User Registration form.
- Music rest
- AC adaptor, power cord  
May not be included depending on your area. Check with your Yamaha dealer.

## About the Manuals

This instrument has the following document and instructional materials.

### ■ Included Document



#### Owner's Manual (this book)

Contains overall instructions for using your PSR-A3000. The function instructions are divided into the two following sections for convenient use.

#### • Basic Operations:

Provides overall explanations of the PSR-A3000 basic functions.

#### • Advanced Features:

Explains advanced features of the instrument, not explained in the Basic Operations section. For example, you can learn how to create original Styles, Songs or Multi Pads, or find detailed explanations of specific parameters.

\* Each chapter in the Advanced Features section corresponds to the relevant chapters in the Basic Operations section.

### ■ Online Materials (PDF)



#### Data List

Contains various preset content lists such as Voices, Styles, Effects, as well as MIDI-related information.



#### Computer-related Operations

Includes instructions on connecting this instrument to a computer, and operations related to transmitting/receiving MIDI data.



#### iPhone/iPad Connection Manual (only in English, French, German and Spanish)

Explains how to connect the instrument to smart devices, such as an iPhone, iPad, etc.

To obtain these materials, access the Yamaha Downloads website, then enter the model name for searching the desired files.

**Yamaha Downloads** <http://download.yamaha.com/>

- The illustrations and LCD screens as shown in this manual are for instructional purposes only, and may appear somewhat different from those on your instrument.
- iPhone, iPad and iPod touch are trademarks of Apple Inc., registered in the U.S. and other countries.
- The company names and product names in this manual are the trademarks or registered trademarks of their respective companies.

### Instruction conventions in this manual

Throughout this manual, instructions with multiple steps are given in convenient shorthand, with arrows indicating the proper sequence.

Example: [FUNCTION] → TAB [▶] MENU 2 → [G] SYSTEM → TAB [◀][▶] BACKUP/RESTORE

The example above describes a four step operation:

- 1) Press the [FUNCTION] button.
- 2) Press the TAB [▶] button to select the MENU 2 tab.
- 3) Press the [G] (SYSTEM) button.
- 4) Use the TAB [◀][▶] buttons to select the BACKUP/RESTORE tab.

# Formats

---



“GM (General MIDI)” is one of the most common Voice allocation formats. “GM System Level 2” is a standard specification that enhances the original “GM” and improves Song data compatibility. It provides for increased polyphony, greater Voice selection, expanded Voice parameters, and integrated effect processing.



XG is a major enhancement of the GM System Level 1 format, and was developed by Yamaha specifically to provide more Voices and variations, as well as greater expressive control over Voices and effects, and to ensure compatibility of data well into the future.



GS was developed by the Roland Corporation. In the same way as Yamaha XG, GS is a major enhancement of the GM specifically to provide more Voices and Drum kits and their variations, as well as greater expressive control over Voices and effects.



The Yamaha XF format enhances the SMF (Standard MIDI File) standard with greater functionality and open-ended expandability for the future. This instrument is capable of displaying lyrics when an XF file containing lyric data is played.



“SFF (Style File Format)” is an original Style file format by Yamaha which uses a unique conversion system to provide high-quality automatic accompaniment based on a wide range of chord types. “SFF GE (Guitar Edition)” is an enhanced format of SFF, which features improved note transposition for guitar tracks.

## Information

---

### ■ About copyrights

- Copying of the commercially available musical data including but not limited to MIDI data and/or audio data is strictly prohibited except for your personal use.
- This product incorporates and bundles contents in which Yamaha owns copyrights or with respect to which Yamaha has license to use others' copyrights. Due to copyright laws and other relevant laws, you are NOT allowed to distribute media in which these contents are saved or recorded and remain virtually the same or very similar to those in the product.
  - \* The contents described above include a computer program, Accompaniment Style data, MIDI data, WAVE data, voice recording data, a score, score data, etc.
  - \* You are allowed to distribute medium in which your performance or music production using these contents is recorded, and the permission of Yamaha Corporation is not required in such cases.
- The followings are the titles, credits and copyright notices for some of the songs pre-installed in this instrument:

#### **Beauty And The Beast**

from Walt Disney's BEAUTY AND THE BEAST

Lyrics by Howard Ashman

Music by Alan Menken

©1991 Walt Disney Music Company and Wonderland Music Company, Inc.

All Rights Reserved Used by Permission

#### **What Makes You Beautiful**

Words and Music by Savan Kotecha, Rami Yacoub and Carl Falk

© 2011 EMI APRIL MUSIC INC., MR. KANANI SONGS, RAMI PRODUCTIONS AB and AIR CHRYSALIS SCANDINAVIA AB  
All Rights for MR. KANANI SONGS Controlled and Administered by EMI APRIL MUSIC INC.

All Rights for RAMI PRODUCTIONS AB Administered by KOBALT SONGS MUSIC PUBLISHING

All Rights for AIR CHRYSALIS SCANDINAVIA AB Administered by CHRYSALIS MUSIC GROUP, INC., a BMG CHRYSALIS COMPANY

All Rights Reserved International Copyright Secured Used by Permission

### ■ About functions/data bundled with the instrument

- Some of the preset songs have been edited for length or arrangement, and may not be exactly the same as the original.
- This device is capable of using various types/formats of music data by optimizing them to the proper format music data for use with the device in advance. As a result, this device may not play them back precisely as their producers or composers originally intended.
- The bitmap fonts used in this instrument have been provided by and are the property of Ricoh Co., Ltd.



# Main Features

## **Extraordinarily expressive and realistic Voices .....page 36**

The PSR-A3000 has a comprehensive and sonically stunning set of authentic Voices, and gives you the tools to play these Voices more naturally and with greater expressiveness.

## **Play along with a backing band .....page 49**

The Styles of the PSR-A3000 make it possible to perform in a wide variety of music genres with full instrumental accompaniment, just by playing chords.

## **Voice and Style expandability .....page 46**

The PSR-A3000 is an open-ended instrument that lets you continually expand the available content for your creative explorations. Featured on our special website (<http://www.yamaha.com/awk/>) are many Voices and Styles (called Expansion Pack data) that you can get and load to the PSR-A3000. By using the “Yamaha Expansion Manager” software, you can manage the variety of Expansion Packs and create your own custom Pack for installing on your instrument.

## **Powerful DSP effect for enhancing the sound .....page 42**

The PSR-A3000 has new and high-quality effect types, including Real Distortion and Real Reverb. The DSP effects allow you to play the keyboard dynamically with a distorted guitar sound, or sound like you are playing in a concert hall.

## **Audio playing and recording with a USB flash drive .....page 71**

Audio files (WAV or MP3 format) saved to a USB flash drive can be played back on the instrument. You can also record your performance as audio files (WAV format) to a USB flash drive—making it easy to edit your recordings on computer as desired, and share them over the Internet, or burn your own original CDs. The instrument also provides a variety of advanced, convenient audio playback and processing functions, including Time Stretch, which lets you slow down or speed up an audio file without changing the pitch, and Pitch Shift, which allows you to change the pitch without affecting the time. Moreover, a Vocal Cancel function effectively attenuates the vocals which may be positioned in the center of a file, allowing you to sing “karaoke” style with just instrumental backing.

## **Versatile real-time controller — Joystick .....page 40**

This expressive joystick lets you intuitively change the sounds during your performance in real-time. You can also freely assign functions to it as desired. For example, you can use the joystick to adjust the filter, or to turn on/off playback of the Style channels—easily applying variations to the sound without interrupting your performance.

## **Setting your Original Scales .....page 88**

The Oriental Scales feature lets you simply and easily change the pitches of specific notes and create your own scales. The settings can be stored for instant recall, whenever you need them.

## **Playing with Arpeggios .....page 44**

You can play arpeggios (broken chords) by simply pressing the appropriate notes on the keyboard, allowing you to instantly and automatically have complex and otherwise difficult-to-play phrases backing your performance.

The Demos (page 19) showcase the instrument's high-quality sounds, the variety of advanced functions, and provide helpful information for learning about your new keyboard.

**These are just a few of the many functions that enhance your musical enjoyment and expand your creative and performance possibilities. Try them out and enjoy your new keyboard!**

# Table of Contents

Included Accessories.....	7	Displaying Lyrics/Text.....	65
About the Manuals.....	7	Turning Each Channel of the Song On/Off.....	65
Formats.....	8	One-handed Practice with the Guide Function.....	66
Information.....	8	Repeat Playback.....	67
<b>Main Features</b> .....	<b>9</b>	Recording Your Performance.....	68
<b>Panel Controls and Terminals</b> .....	<b>12</b>	<b>4 USB Audio Player/Recorder</b> <b>– Playing Back and Recording Audio Files –</b>	<b>71</b>
<b>Starting Up</b> .....	<b>16</b>	Playing Back Audio Files.....	71
Power Requirements.....	16	Recording Your Performance as Audio.....	74
Turning the Power On/Off.....	16	<b>5 Multi Pads</b> <b>– Adding Musical Phrases to Your Performance –</b>	<b>76</b>
Adjusting the Master Volume.....	18	Playing the Multi Pads.....	76
Changing the Display Language.....	18	Using Chord Match.....	77
Playing the Demos.....	19	Using the Multi Pad Synchro Start Function.....	77
Display-based Controls.....	20	Creating a Multi Pad with Audio files (Audio Link Multi Pad).....	78
Calling Up the Desired Display Instantly — Direct Access.....	23	<b>6 Music Finder</b> <b>– Calling Up Ideal Panel Setups for Your Performance –</b>	<b>80</b>
Messages Shown in the Display.....	23	Selecting the Desired Record (Panel Settings).....	80
Main Display Configuration.....	24	Searching for Records (Panel Settings).....	81
File Selection Display Configuration.....	26	Downloading Records (Panel Settings) from the Website.....	82
File Management.....	27	Registering a Song, Audio or Style File to a Record.....	83
Entering Characters.....	32	<b>7 Registration Memory</b> <b>– Saving and Recalling Custom Panel Setups –</b>	<b>85</b>
Resetting to the Factory-programmed Settings.....	33	Registering Your Panel Setups.....	85
Data Backup.....	34	Saving the Registration Memory as a Bank file.....	86
<b>Basic Operations</b> .....	<b>35</b>	Recalling a Registered Panel Setup.....	87
<b>1 Voices</b> <b>– Playing the keyboard –</b>	<b>36</b>	<b>8 Oriental Scales</b> <b>– Setting Original Scales –</b>	<b>88</b>
Playing Voices.....	36	Setting Oriental Scales.....	88
Changing the Pitch of the Keyboard.....	39	Saving the Scale Memory as a Bank File.....	89
Using the Joystick.....	40	<b>9 Mixing Console</b> <b>– Editing the Volume and Tonal Balance –</b>	<b>91</b>
Applying Voice Effects.....	42	Basic Procedure.....	91
Creating Your Original Organ Flutes Voices.....	45	<b>10 Connections</b> <b>– Using Your Instrument with Other Devices –</b>	<b>93</b>
Adding New Contents — Expansion Packs.....	46	Connecting a Footswitch/Foot Controller (FOOT PEDAL jacks).....	93
<b>2 Styles</b> <b>– Playing Rhythm and Accompaniment –</b>	<b>49</b>	Connecting Audio Devices (OUTPUT [L/L+R]/[R] jacks, [AUX IN] jack).....	94
Playing a Style with the Auto Accompaniment.....	49	Connecting USB Devices ([USB TO DEVICE] terminal).....	95
Operating Style Playback.....	51	Connecting to an iPhone/iPad ([USB TO DEVICE], [USB TO HOST] and MIDI terminals).....	97
Changing the Chord Fingering Type.....	53	Connecting to a Computer ([USB TO HOST] terminal).....	97
Calling up Appropriate Panel Settings for the Current Style (One Touch Setting).....	54	Connecting External MIDI Devices (MIDI [IN]/[OUT] terminals).....	98
Finding Suitable Music Pieces for the Current Style (Repertoire).....	55	<b>11 Other Functions</b> <b>– Making Global Settings and Using Advanced Features –</b>	<b>99</b>
Turning On/Off Each Channel of the Style.....	56	Basic Procedure.....	99
Adjusting the Volume Balance Between the Parts.....	57		
Setting the Split Point.....	58		
Specifying Chords with Your Right Hand while Playing Bass with Your Left Hand.....	59		
Creating/Editing Styles (Style Creator).....	60		
<b>3 Songs</b> <b>– Playing, Practicing and Recording Songs –</b>	<b>62</b>		
Playback of Songs.....	62		
Displaying Music Notation (Score).....	64		

<b>Advanced Features</b>	<b>101</b>
<b>1 Voices</b>	<b>102</b>
Voice Types (Characteristics) .....	102
Selecting GM&XG or Other Voices .....	104
Touch Response and Effect-Related Settings .....	105
Pitch-Related Settings .....	108
Editing Parameters Assigned to the Joystick .....	110
Editing Voices (Voice Set) .....	113
Editing Organ Flutes Voices .....	118
<b>2 Styles</b>	<b>120</b>
Chord Fingering Types .....	120
Style Playback Related Settings .....	122
Memorizing Original Settings to One Touch Setting .....	124
Creating/Editing Styles (Style Creator) .....	125
<b>3 Songs</b>	<b>143</b>
Editing Music Notation (Score) Settings .....	143
Editing Lyrics/Text Display Settings .....	145
Using the Auto Accompaniment Features with Song Playback .....	146
Song Playback Related Parameters (Guide Function, Channel settings, Repeat settings) .....	147
Creating/Editing Songs (Song Creator) .....	151
<b>4 USB Audio Player/Recorder</b>	<b>168</b>
<b>5 Multi Pads</b>	<b>168</b>
Creating Multi Pads (Multi Pad Creator) .....	168
Editing Multi Pads .....	170
<b>6 Music Finder</b>	<b>172</b>
Creating a Set of Favorite Records .....	172
Editing Records .....	173
Saving the Records as a Single File .....	174
<b>7 Registration Memory</b>	<b>176</b>
Editing the Registration Memory .....	176
Disabling Recall of Specific Items (Freeze) .....	177
Calling Up Registration Memory Numbers in Order (Registration Sequence) .....	178
<b>8 Oriental Scales</b>	<b>181</b>
<b>9 Mixing Console</b>	<b>181</b>
Editing VOL/VOICE Parameters .....	181
Editing FILTER Parameters .....	182
Editing TUNE Parameters .....	183
Editing EFFECT Parameters .....	184
Editing EQ Parameters .....	187
Editing Master Compressor (CMP) Parameters .....	189
Block Diagram .....	190
<b>10 Connections</b>	<b>191</b>
Footswitch/Foot Controller Settings .....	191
MIDI Settings .....	194
Connecting with an iPhone/iPad via Wireless LAN .....	200

<b>11 Other Functions</b>	<b>202</b>
UTILITY .....	202
SYSTEM .....	206
<b>Function List</b>	<b>209</b>
<b>Direct Access Chart</b>	<b>210</b>
<b>Troubleshooting</b>	<b>211</b>
<b>Specifications</b>	<b>214</b>
<b>Index</b>	<b>216</b>

# Panel Controls and Terminals

## ■ Top Panel

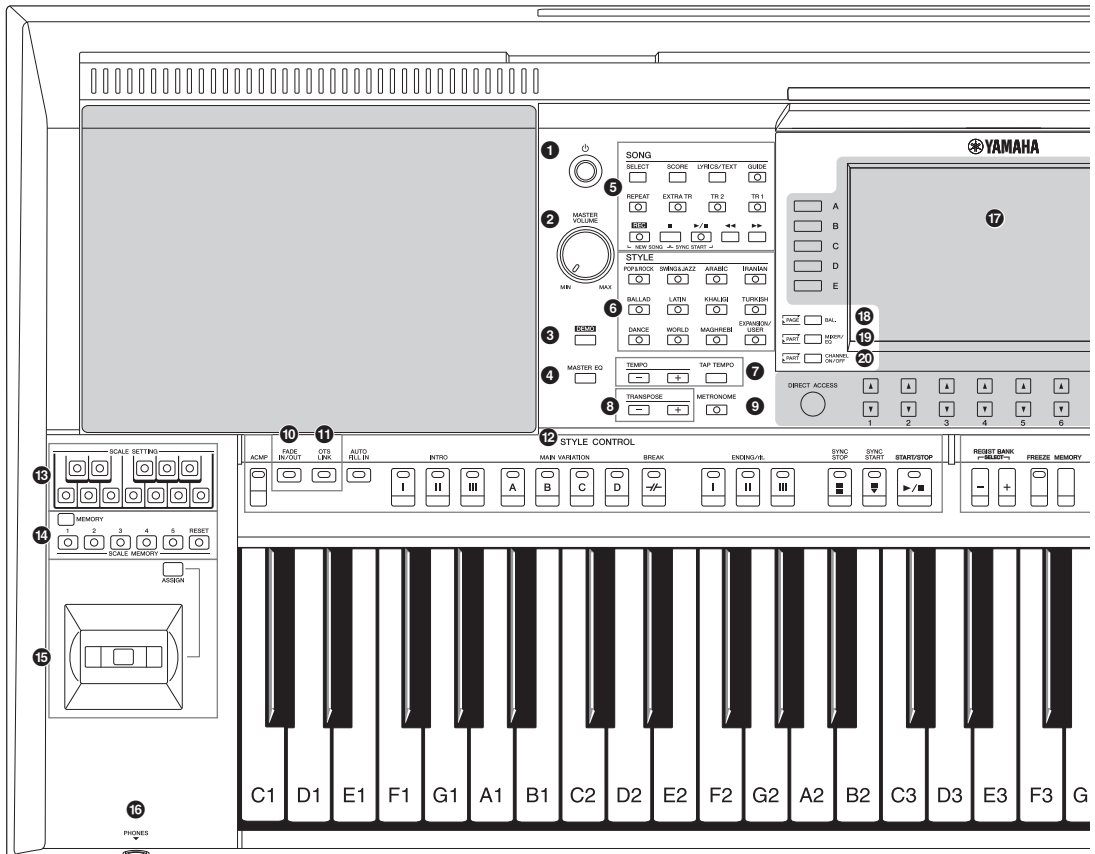

- |  |  |
|--|--|
| <p><b>1</b> [  ] (Standby/On) switch .....Page 16<br/>Turns on the instrument's power or sets to standby.</p> <p><b>2</b> [MASTER VOLUME] dial .....Page 18<br/>Adjusts the overall volume.</p> <p><b>3</b> [DEMO] button .....Page 19<br/>Calls up the display for selecting a Demo.</p> <p><b>4</b> [MASTER EQ] button .....page 188<br/>Calls up the display for setting the Master Equalizer type.</p> <p><b>5</b> SONG buttons .....Page 62<br/>Selects a Song and controls Song playback.</p> <p><b>6</b> STYLE category selection buttons .....Page 49<br/>Selects a Style category.</p> <p><b>7</b> [TAP TEMPO]/TEMPO buttons .....Page 52<br/>Controls the tempo for Style, Song and Metronome playback.</p> <p><b>8</b> TRANSPOSE buttons .....Page 39<br/>Transposes the entire pitch of the instrument in semitone steps.</p> <p><b>9</b> [METRONOME] button .....Page 38<br/>Turns the metronome on or off.</p> | <p><b>10</b> [FADE IN/OUT] button ..... Page 53<br/>Controls fade in/out of Style/Song playback.</p> <p><b>11</b> [OTS LINK] button ..... Page 55<br/>Turns on/off the OTS Link function.</p> <p><b>12</b> STYLE CONTROL buttons ..... Page 51<br/>Controls Style playback.</p> <p><b>13</b> SCALE SETTING buttons ..... page 88<br/>Lowers the pitches of specific notes by 50 cents.</p> <p><b>14</b> SCALE MEMORY [MEMORY],<br/>[1] – [5], [RESET] buttons ..... page 89<br/>Lets you memorize your scale settings, or reset them to factory default.</p> <p><b>15</b> Joystick, [ASSIGN] button ..... page 40<br/>For using pitch bend or modulation functions, or assigning other functions to control sounds in real time.</p> <p><b>16</b> [PHONES] jack ..... Page 15<br/>For connecting a pair of headphones.</p> <p><b>17</b> LCD and related controls ..... Page 20</p> <p><b>18</b> [BAL.] button ..... Pages 57, 74<br/>Calls up settings for the volume balance among the parts.</p> |
|--|--|

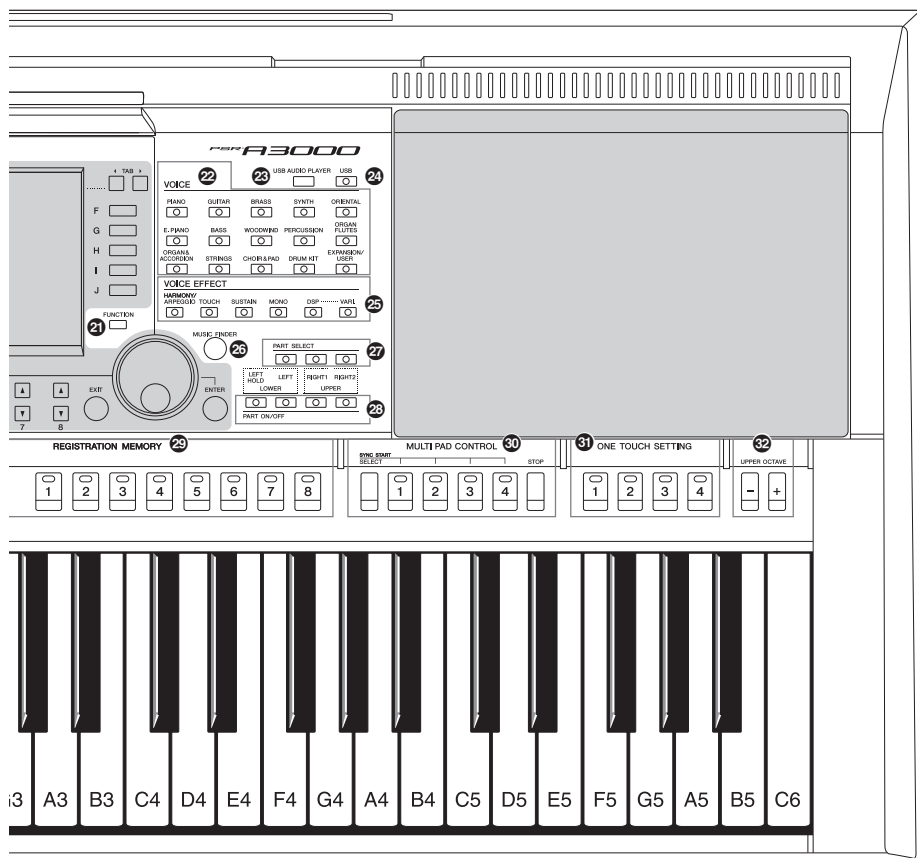

- 19 [MIXER/EQ] button** .....Page 91  
Calls up various settings for the keyboard, Style and Song parts.
- 20 [CHANNEL ON/OFF] button**.....Pages 56, 65  
Calls up settings for turning Style/Song channels on or off.
- 21 [FUNCTION] button** .....Page 99  
Lets you make advanced settings and create your original Styles, Songs and Multi Pads.
- 22 VOICE category selection buttons**.....Page 37  
Selects a Voice category.
- 23 [USB AUDIO PLAYER] button**.....Page 71  
Calls up the display for playing back audio files and recording your performance in audio format.
- 24 [USB] button** .....Page 96  
Calls up the display for selecting a file in the USB flash drive.
- 25 VOICE EFFECT buttons** .....Page 42  
Applies various effects to the keyboard performance.
- 26 [MUSIC FINDER] button**.....Page 80  
Calls up ideal panel setups for your performance.
- 27 PART SELECT buttons** .....Page 37  
Selects a keyboard part.
- 28 PART ON/OFF buttons**.....Page 36  
Turns the keyboard part on or off.
- 29 REGISTRATION MEMORY buttons** .....Page 85  
Registers and recalls panel setups.
- 30 MULTI PAD CONTROL buttons** .....Page 76  
Selects and plays a rhythmic or melodic Multi Pad phrase.
- 31 ONE TOUCH SETTING buttons**.....Page 54  
Calls up the appropriate panel settings for the Style.
- 32 UPPER OCTAVE buttons** .....Page 39  
Shifts the pitch of the keyboard in octave steps.

**Panel Setup (Panel Settings)**  
By using the controls on the panel, you can make various settings as described here. These settings of the instrument are together referred to as "panel setup" or "panel settings" in this manual.

## ■ Rear Panel

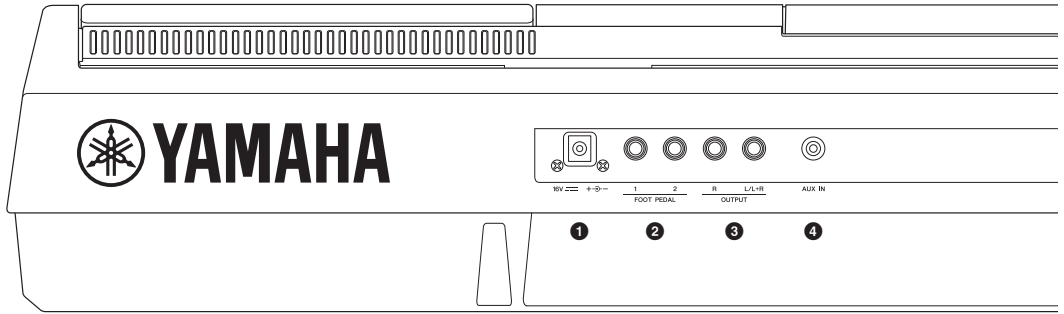

- |  |   |
|--|---|
| <p><b>1 DC IN jack</b>.....Page 16<br/>For connecting the AC adaptor.</p> <p><b>2 FOOT PEDAL [1]/[2] jacks</b>.....Page 93<br/>For connecting Footswitches and/or Foot controllers.</p> <p><b>3 OUTPUT [L/L+R]/[R] jacks</b> .....Page 94<br/>For connecting external audio devices.</p> <p><b>4 [AUX IN] jack</b>.....Page 94<br/>For connecting an external audio device, such as a portable audio player.</p> | <p><b>5 MIDI [IN]/[OUT] terminals</b> ..... Page 98<br/>For connecting external MIDI devices.</p> <p><b>6 [USB TO HOST] terminal</b> ..... Page 97<br/>For connecting to a computer.</p> <p><b>7 [USB TO DEVICE] terminal</b>..... Page 95<br/>For connecting a USB device such as a USB flash drive.</p> |
|--|---|

### Air Vents

#### **NOTICE**

This instrument has special air vents in the top panel and rear panel. Do not place objects where they might block the air vent, since this may prevent adequate ventilation of the internal components, and possibly result in the instrument overheating.

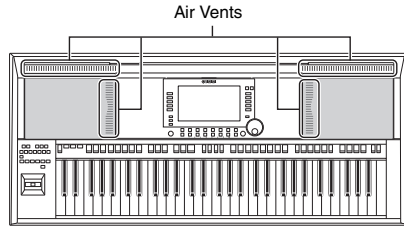

### Attaching the Music Rest

Insert the music rest into the slots as shown.

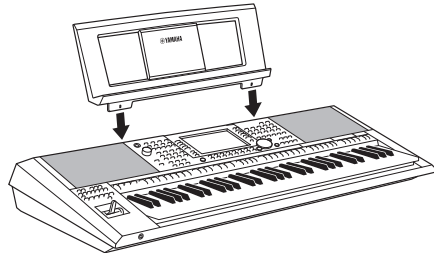

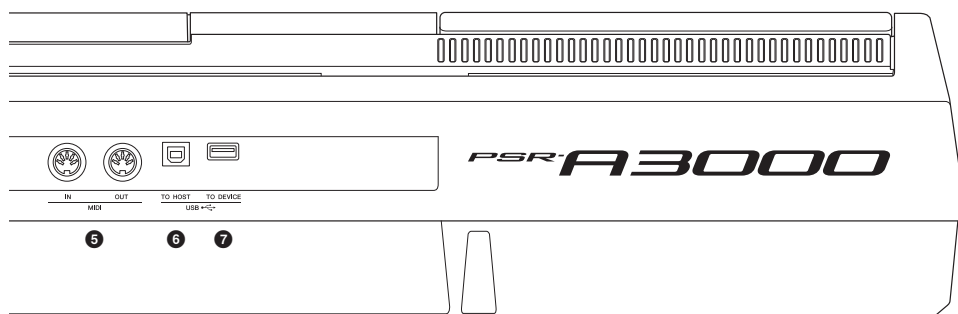

### Using the Headphones

Connect a pair of headphones to the [PHONES] jack.

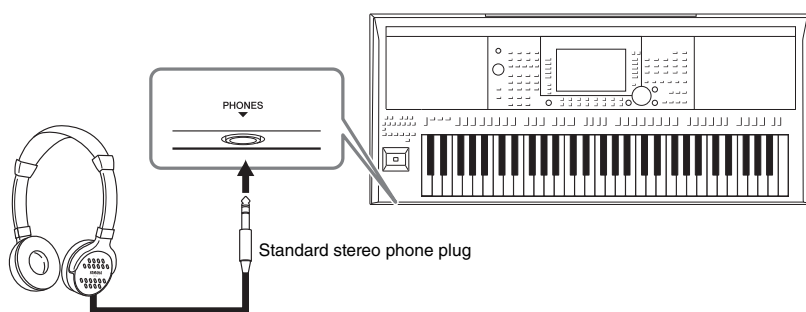

#### **CAUTION**

Do not listen with the headphones at high volume for long periods of time. Doing so may cause hearing loss.

# Starting Up

## Power Requirements

Connect the AC adaptor in the order shown in the illustration.

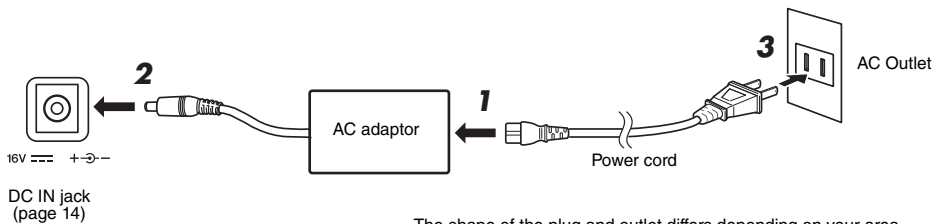

### **WARNING**

Use the specified AC adaptor (page 215) only. Using the wrong AC adaptor can result in damage to the instrument or overheating.

### **CAUTION**

When setting up the product, make sure that the AC outlet you are using is easily accessible. If some trouble or malfunction occurs, immediately turn the power off and disconnect the plug from the outlet.

### **NOTE**

Follow the order shown above in reverse when disconnecting the AC adaptor.

## Turning the Power On/Off

- 1 Turn down the [MASTER VOLUME] dial to "MIN".

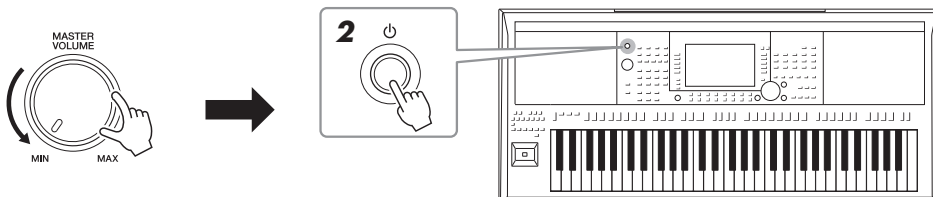

- 2 Press the [⏻] (Standby/On) switch to turn on the power.  
After the Main display appears, adjust the volume as desired while playing the keyboard.
- 3 After you finish using the instrument, turn off the power by pressing and holding the [⏻] (Standby/On) switch for about a second.

### **NOTE**

Do not press the foot pedal or move the joystick, etc. when turning the power on. Doing so may cause the instrument to malfunction.

### **NOTE**

Until the Main display appears, no operations can be carried out, including power-off and keyboard performance.



## CAUTION

Even when the power switch is turned off, electricity is still flowing to the product at the minimum level. When you are not using the product for a long time, make sure to unplug the power cord from the wall AC outlet.

## NOTICE

While recording or editing, or while a message is displayed, the power cannot be turned off even if you press the [⏻] (Standby/On) switch. If you want to turn off the power, press the [⏻] (Standby/On) switch after recording, editing, or after the message has disappeared. If you need to force-quit the instrument, hold down the [⏻] (Standby/On) switch for longer than three seconds. Note that the force-quit operation might cause data loss and damage to the instrument.

## Setting the Auto Power Off function

To prevent unnecessary power consumption, this instrument features an Auto Power Off function that automatically turns the power off if the instrument is not operated for a specified period of time. The amount of time that elapses before the power is automatically turned off is approximately 30 minutes by default; however, you can change the setting.

## NOTICE

Any data which has not been saved to the USER or USB drive will be lost if the power automatically turns off. Make sure to save your data before the power turns off (page 28).

### 1 Call up the operation display.

[FUNCTION] → TAB [◀] MENU 1 → [J] UTILITY → TAB [◀] CONFIG 1

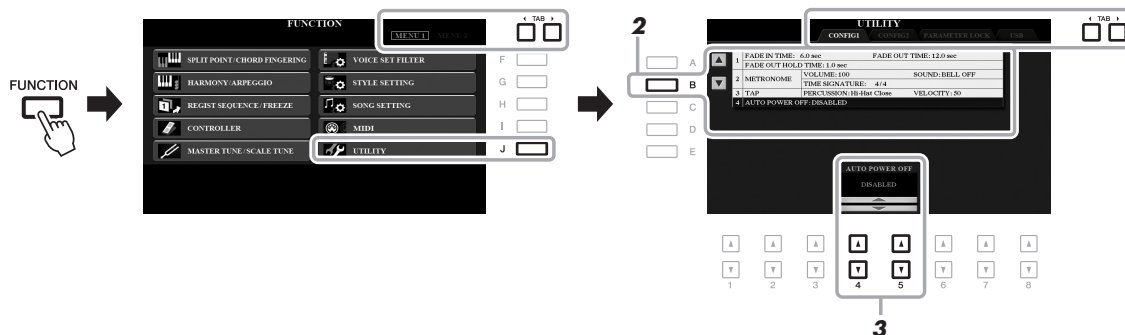

### 2 Press the [B] button several times to select “4 AUTO POWER OFF.”

### 3 Use the [4 ▲▼]/[5 ▲▼] buttons to set the value.

If you do not want to turn the power off automatically (disable the Auto Power Off), select DISABLED.

Press the [EXIT] button several times to exit from the display.

### Disabling Auto Power Off (simple method)

Turn the power on while holding down the lowest key on the keyboard. A message appears briefly, then the instrument starts up with the Auto Power Off function disabled.

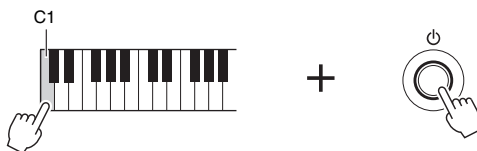

## Adjusting the Master Volume

To adjust the volume of the entire keyboard sound, use the [MASTER VOLUME] dial while playing the keyboard.

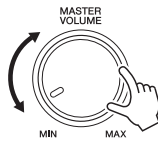

### CAUTION

Do not use the instrument at high volume for long periods of time. Doing so may cause hearing loss.

## Changing the Display Language

This determines the language (English, German, French, Spanish and Italian are available) used in the display for messages.

### 1 Call up the operation display.

[FUNCTION] → TAB [▶] MENU 2 → [G] SYSTEM → TAB [◀] OWNER

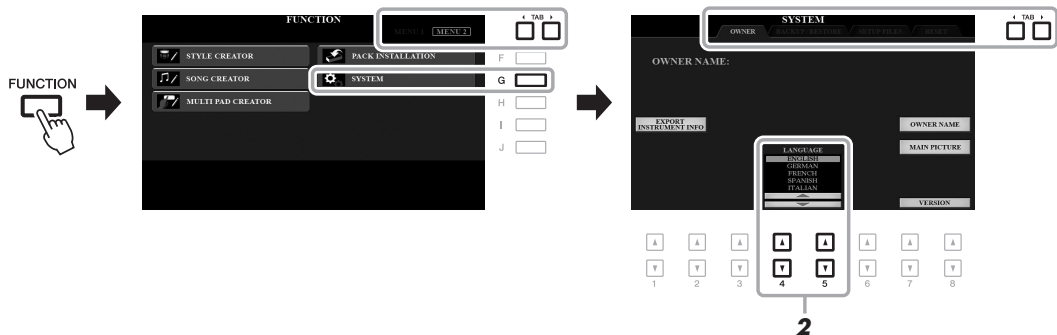

### 2 Use the [4 ▲▼]/[5 ▲▼] buttons to select the desired language.

Press the [EXIT] button several times to exit from the display.

## Playing the Demos

The Demos provide helpful, easy-to-understand introductions to the features and functions as well as dynamic demonstrations of the high-quality sounds.

### 1 Press the [DEMO] button to call up the Demo display.

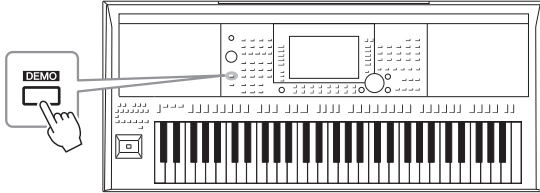

### 2 Press one of the [A] – [H] buttons to show a specific Demo.

Pressing one of the [I] – [J] buttons plays back the overview Demo continuously, calling up the various displays in sequence.

Sub menus may be shown on the display. Press one of the [A] – [J] buttons corresponding to the desired sub menu.

### 3 Press the [EXIT] button several times to exit from the Demo display.

#### **NOTE**

To return to the higher level menu, press the [EXIT] button.

# Display-based Controls

The LCD provides comprehensive at-a-glance information on all current settings. The displayed menu can be selected or changed by the controls around the LCD.

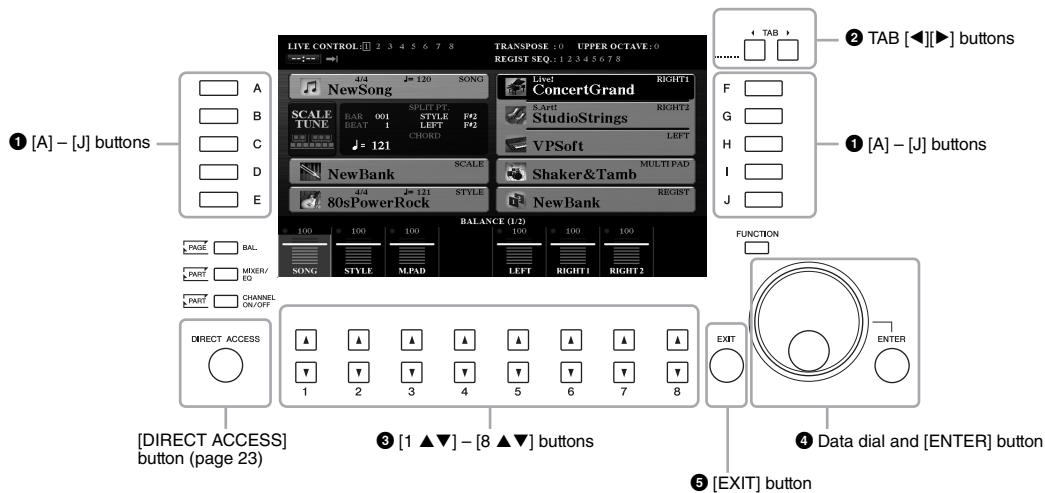

## 1 [A] - [J] buttons

The [A] - [J] buttons are used to select the corresponding menu items shown next to them.

### • Example 1

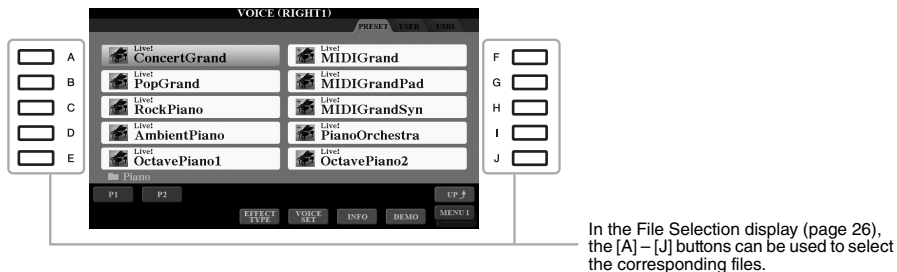

### • Example 2

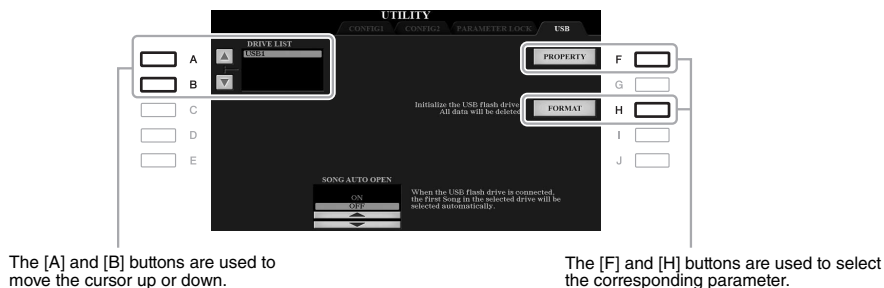

## 2 TAB [◀][▶] buttons

These buttons are used to change the pages of displays that have “tabs” at the top.

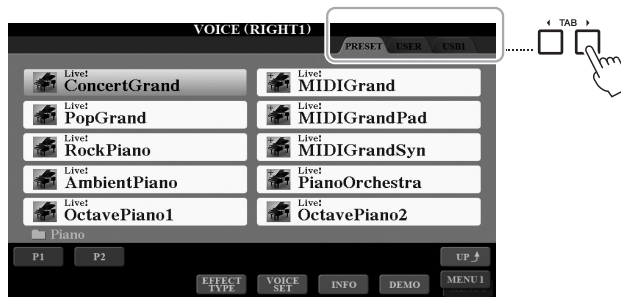

## 3 [1 ▲▼] – [8 ▲▼] buttons

The [1 ▲▼] – [8 ▲▼] buttons are used to make selections or adjust settings (up or down correspondingly) for functions shown directly above them.



For menus that appear in this section of the display, use the [1 ▲] – [8 ▲] buttons.

For menus that appear in this section of the display, use the [1 ▼] – [8 ▼] buttons.

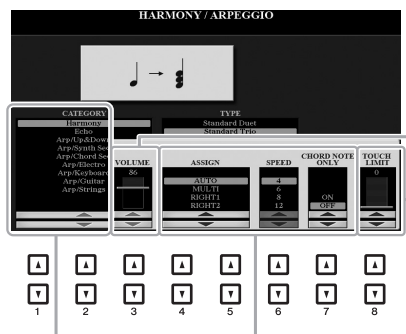

For list menus that appear, use the [1 ▲▼] – [8 ▲▼] buttons to select the desired item.

For parameters that appear in slider (or knob) form, use the [1 ▲▼] – [8 ▲▼] buttons to adjust the value.  
To reset the desired parameter value to its default, simultaneously press both the [▲] and [▼] buttons below it.

## 4 Data dial and [ENTER] button

Depending on the selected display, the Data dial can be used in the following two ways.

### • Selecting files (Voice, Style, Song, and so on)

When one of the File Selection displays (page 26) is shown, you can use the Data dial and the [ENTER] button to select a file.

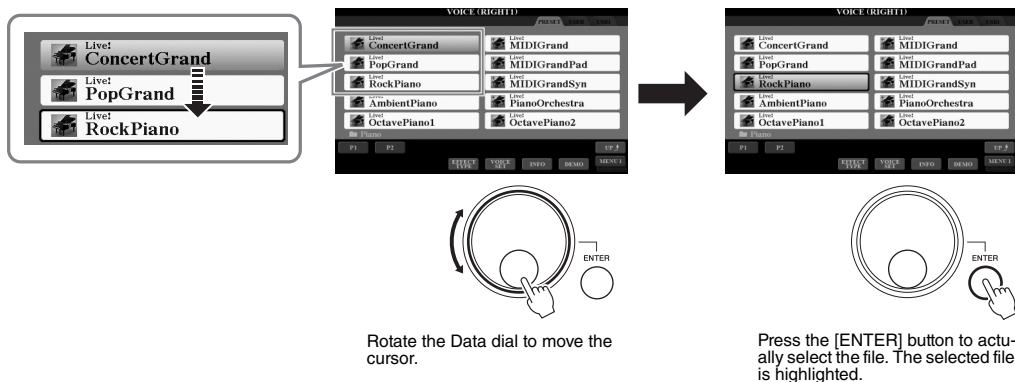

### • Adjusting parameter values

You can conveniently use the Data dial in tandem with the [1 ▲▼] – [8 ▲▼] buttons to adjust parameters indicated in the display.

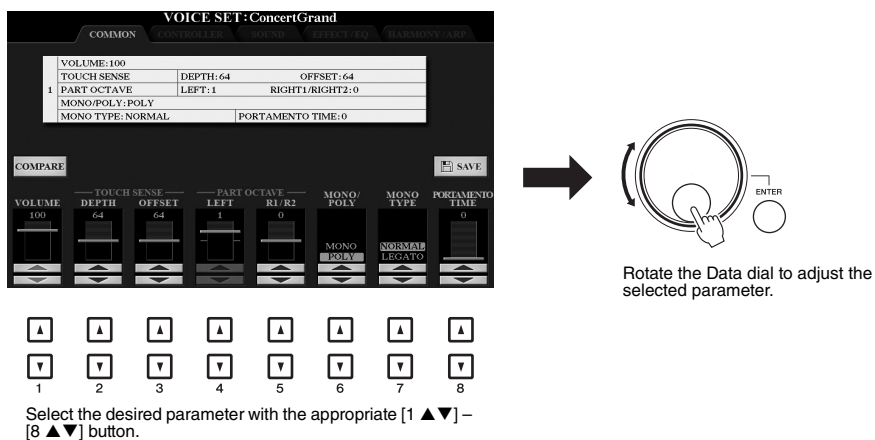

This convenient technique also works well with pop-up parameters such as Tempo and Transpose. Simply press the appropriate button (ex., TEMPO [+]), then rotate the Data dial to set the value.

## 5 [EXIT] button

Pressing the [EXIT] button returns to the previously indicated display. Pressing the [EXIT] button several times returns to the default Main display (page 24).



## Calling Up the Desired Display Instantly — Direct Access

With the convenient Direct Access function, you can instantly call up the desired display — with just a single additional button press. Refer to the “Direct Access Chart” on page 210 for a list of the displays that can be called up with the Direct Access function.

### 1 Press the [DIRECT ACCESS] button.

A message appears in the display prompting you to press the appropriate button.

### 2 Press the button (or move the joystick or connected pedal) corresponding to the desired setting display to instantly call up that display.

For example, pressing the [GUIDE] button calls up the display in which the Guide mode can be set.

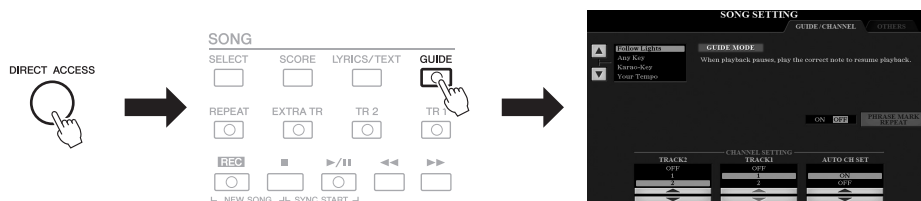

## Messages Shown in the Display

A message (information or confirmation dialog) sometimes appears on the screen to facilitate operation. When the message appears, simply press the appropriate button.

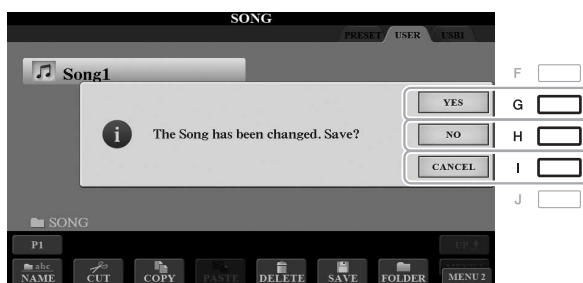

## Main Display Configuration

The display that appears when the power is turned on is the Main display. This display shows the current basic settings such as the currently selected Voice and Style, allowing you to see them at a single glance. The Main display is the one you'll usually see when you play the keyboard.

### NOTE

You can quickly call up the Main display by pressing the [DIRECT ACCESS] button, followed by the [EXIT] button.

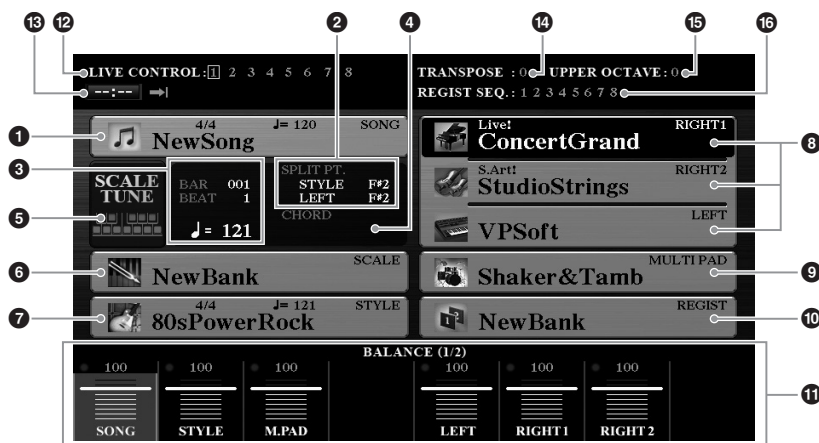

### 1 Song name and related information

Displays the currently selected Song name, time signature and tempo. Pressing the [A] button calls up the Song Selection display (page 62).

### 2 Split Point

Displays the Split Point positions (page 58).

### 3 BAR/BEAT/Tempo

Displays the current position (bar/beat/tempo) in Style playback or Song playback.

### 4 Current chord name

When the [ACMP] button is set to on, the chord specified in the chord section of the keyboard will be displayed. When the Song containing the chord data is played, the current chord name will be displayed.

### 5 Scale Tune setting button

Pressing the [B]/[C] buttons calls up the SCALE TUNE display (page 108) for making scale settings.

### 6 Scale Tune Bank name

Displays the currently selected Scale Tune Bank. Pressing the [D] button calls up the Scale Tune Bank Selection display (page 90).

### 7 Style name and related information

Displays the currently selected Style name, time signature and tempo. Pressing the [E] button calls up the Style Selection display (page 49).

### 8 Voice name

Displays the Voice names currently selected for RIGHT 1, RIGHT 2 and LEFT parts (page 36). Use the [F], [G] and [H] buttons to call up the Voice Selection



display for the corresponding part: Press the button once to highlight the part's Voice, then once more to call up the Voice Selection display.

**9 Multi Pad Bank name**

Displays the names of the selected Multi Pad Bank. Pressing the [I] button calls up the Multi Pad Bank Selection display (page 76).

**10 Registration Memory Bank name**

Displays the currently selected Registration Memory Bank name and Registration Memory number. Pressing the [J] button calls up the Registration Memory Bank Selection display (page 86).

**11 Volume Balance or Channel On/Off settings**

Displays the volume balance (page 57) or channel on/off settings (pages 56, 65) among the parts. Use the [1 ▲▼] – [8 ▲▼] buttons to change the settings.

**NOTE**

Press the [BAL.] button to call up the Volume Balance displays, and press the [CHANNEL ON/OFF] button to call up the CHANNEL ON/OFF displays.

**12 Joystick information**

Indicates the currently selected number of the eight available Joystick function assignments (page 40).

**13 USB Audio Player/Recorder information**

Displays information for the selected audio file in the connected USB flash drive (page 71), including the elapsed playback time, file name and Repeat mode icon. When the audio recording is in standby, a "WAITING" indication appears. While recording, "RECORDING" appears.

**14 Transpose**

Displays the amount of transposition in semitone units (page 39).

**15 Upper Octave**

Displays the amount that the octave value is shifted (page 39).

**16 Registration Sequence**

Appears when the Registration Sequence (page 178) is active.

## File Selection Display Configuration

The File Selection display is for selecting Voice, Styles, and other data. The File Selection display appears when you press one of the VOICE or STYLE category selection buttons, the SONG [SELECT] button, etc.

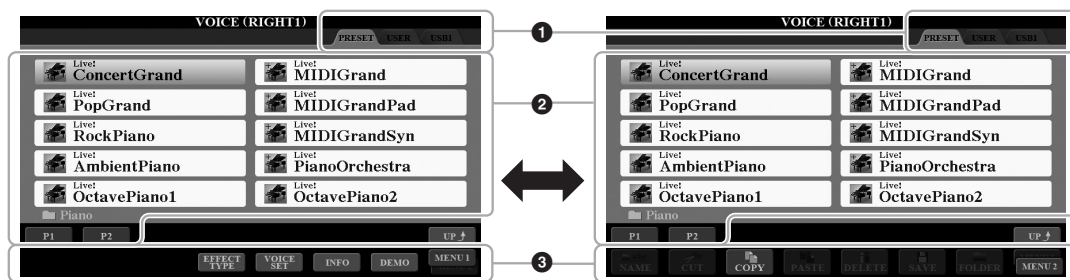

### 1 Location (drive) of data

- **PRESET** .....Location where pre-programmed (preset) data is stored.
- **USER** .....Location where recorded or edited data is saved. Installed Expansion Voices or Styles are also saved here in the Expansion folder.
- **USB** .....Location where data on USB flash drive is saved. This appears only when a USB flash drive is connected to the [USB TO DEVICE] terminal.

#### **NOTE**

Before using a USB flash drive, be sure to read "Connecting USB Devices" on page 95.

#### **NOTE**

By pressing the [USB] button, you can also access Voices, Styles, and other data files which are saved in the USB flash drive (page 96).

### 2 Selectable data (files)

The files that can be selected on this display are shown. If more than 10 files exist, the page numbers (P1, P2 ...) are shown below the files. Pressing the corresponding button changes the display page. When other pages follow, the "Next" button appears, and for the previous page, the "Prev." button appears.

#### **NOTE**

The data, both pre-programmed and your own original, are saved as "files."

### 3 MENU 1/MENU 2

At the bottom of the File Selection display, you can toggle the indication between MENU 1 and MENU 2 by pressing the [8 ▼] button. Selecting MENU 1 shows the function names related to the current file (Voice, Style, Song, etc.) while selecting MENU 2 shows the function names of the file/folder management (page 27).

### Calling up the higher level folder

When the files of a folder are displayed, “UP” is shown above the [8 ▲] button. Pressing this button calls up the next higher level folder.

### Example of the PRESET Voice Selection display

The PRESET Voices are categorized and contained in appropriate folders.

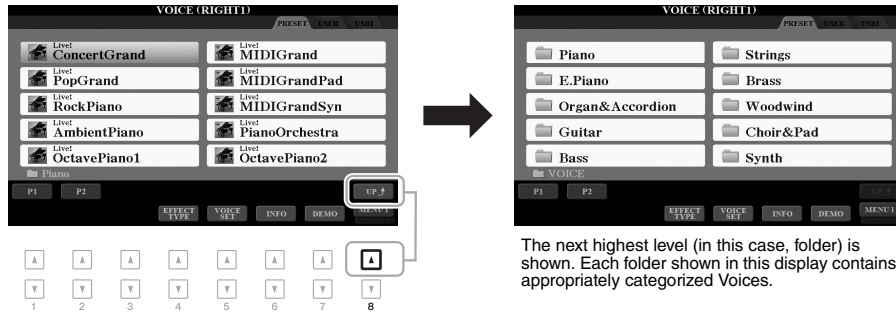

The next highest level (in this case, folder) is shown. Each folder shown in this display contains appropriately categorized Voices.

This display shows the Voices in a folder.

## File Management

You can save, name, copy, move, delete files, and you can create folders to manage the files with the buttons located lower area in the File Selection display. For information on the File Selection display, refer to page 26.

### NOTE

Before using a USB flash drive, be sure to read “Connecting USB Devices” on page 95.

### Restrictions for protected Songs

Preset Songs and most commercially available songs are copy protected to prevent illegal copying or accidental erasure. They are marked by the indications at the upper left side of the file names. The indications and relevant restrictions are detailed below.

- **Prot. 1:** Indicates Preset Songs copied to the USER drive. These only can be copied/moved/deleted in the USER drive.
- **Prot. 2 Orig:** Indicates Yamaha-protection-formatted Songs. These cannot be copied. These can be moved/saved only to the USER drive and USB flash drives with ID.
- **Prot. 2 Edit:** Indicates edited “Prot.2 Orig” Song. These cannot be copied. These can be moved/saved only to the USER drive and USB flash drives with ID.

### NOTE

- Make sure that the “Prot.2 Orig” Song and the corresponding “Prot.2 Edit” Song reside in the same folder. Otherwise, the “Prot.2 Edit” Song cannot be played back. If you move this type of Song, make sure to move both the “Prot.2 Orig” and “Prot.2 Edit” Songs to the same folder.
- Do not change the “Prot.2.Orig” Song name and icon on the display. Otherwise, the corresponding “Prot.2 Edit” Song cannot be played back.

## Saving a File

You can save your original data (such as Songs you've recorded) as a file to the USER or the USB drive in the File Selection display (page 26).

- 1 In the File Selection display, select the appropriate tab (USER or USB) to which you want to save the data by using the TAB [◀][▶] buttons.**

If you want to save the data within an existing folder, select the folder here.

### NOTE

Files cannot be saved to the PRESET tab or the "Expansion" folder (page 46) in the USER tab.

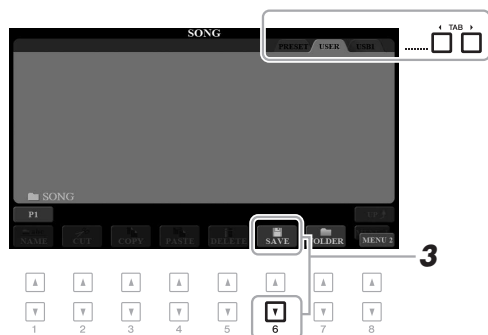

- 2 Make sure that MENU 2 is shown at the bottom right corner of the display.**

If necessary, press the [8 ▼] button to call up MENU 2.

- 3 Press the [6 ▼] (SAVE) button.**

The Character Entry window is called up.



- 4 Enter the file name (page 32).**

Even if you skip this step, you can rename the file at any time after saving it (page 30).

- 5 Press the [8 ▲] (OK) button to actually save the file.**

The saved file will be automatically located at the appropriate position among the files in alphabetical order.

### NOTE

To cancel the Save operation, press the [8 ▼] (CANCEL) button before step 5 below.

### NOTE

In the USER tab, the maximum total number of files which can be stored differs depending on the file size and the length of the file names.

# Creating a New Folder

You can create folders to make it easier to find your original data.

- 1 In the File Selection display, select the appropriate tab (USER or USB) to which you want to create a new folder by using the TAB [◀][▶] buttons.**

If you want to create a new folder within an existing folder, also select the folder here.

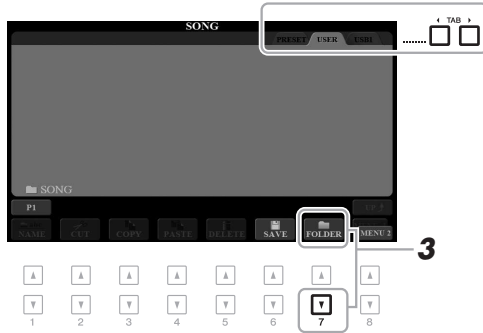

- 2 Make sure that MENU 2 is shown at the bottom right corner of the display.**

If necessary, press the [8 ▼] button to call up MENU 2.

- 3 Press the [7 ▼] (FOLDER) button.**

The Character Entry window is called up.



- 4 Enter the name of the new folder (page 32).**

The created folder will be automatically located at the appropriate position among the folders in alphabetical order.

## NOTE

A new folder cannot be made in the PRESET tab or the "Expansion" folder (page 46) in the USER tab.

## NOTE

The maximum number of files/folders which can be saved in a folder is 500.

## NOTE

In the USER tab, no more than three folder levels can be created. The maximum total number of files/folders which can be saved differs depending on the file size and the length of the file/folder names.

## NOTE

To cancel creating a new folder, press the [8 ▼] (CANCEL) button.

## NOTICE

Do not use "Expansion" for the folder name. Otherwise, all data contained in the "Expansion" folder will be lost when an Expansion Pack (page 46) is installed.

## Renaming a File/Folder

You can rename files/folders.

- 1 In the File Selection display, select the appropriate tab (USER or USB) which contains the file/folder you want to rename by using the TAB [◀][▶] buttons.**

### NOTE

Files and folders in the PRESET tab or the "Expansion" folder (page 46) in the USER tab cannot be renamed.

- 2 Make sure that MENU 2 is shown at the bottom right corner of the display.**

If necessary, press the [8 ▼] button to call up MENU 2.

- 3 Press the [1 ▼] (NAME) button.**

The window for the Rename operation appears at the bottom of the display.



- 4 Press one of the [A] – [J] buttons corresponding to the desired file/folder.**

- 5 Press the [7 ▼] (OK) button to confirm the file/folder selection.**

The Character Entry window is called up.

- 6 Enter the name of the selected file or folder (page 32).**

The renamed file/folder appears on the display at the appropriate position among the files in alphabetical order.

### NOTE

To cancel the Rename operation, press the [8 ▼] (CANCEL) button.

### NOTICE

Do not use "Expansion" for the folder name. Otherwise, all data contained in the "Expansion" folder will be lost when an Expansion Pack (page 46) is installed.

## Copying or Moving Files

You can copy or cut files and paste them to another location (folder). You can also copy folders (but not move them) by using the same procedure.

- 1 In the File Selection display, select the appropriate tab (PRESET, USER or USB) which contains the file/folder you want to copy by using the TAB [◀][▶] buttons.**

- 2 Make sure that MENU 2 is shown at the bottom right corner of the display.**

If necessary, press the [8 ▼] button to call up MENU 2.

### NOTE

- Files in the PRESET tab cannot be moved. They can only be copied.
- Files in the "Expansion" folder (page 46) in the USER tab cannot be copied/moved.
- Commercially available song data may be copy protected to prevent illegal copying.

### 3 Press the [3 ▼] (COPY) button to copy or [2 ▼] (CUT) to move.

The window for the Copy/Cut operation appears at the bottom of the display.

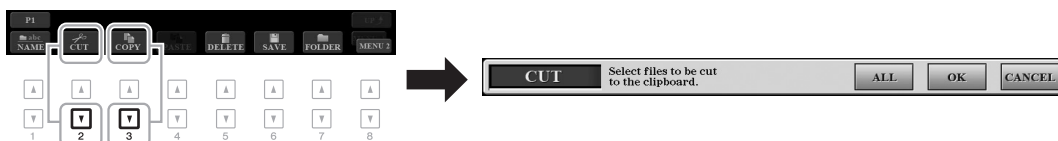

### 4 Press one of the [A] – [J] buttons corresponding to the desired file/folder.

Pressing a button selects (highlights) the file/folder. To cancel the selection, press the same [A] – [J] button again.

Press the [6 ▼] (ALL) button to select all files/folders indicated on the current display including the other pages. To cancel the selection, press the [6 ▼] (ALL OFF) button again.

#### NOTE

To cancel the Copy operation, press the [8 ▼] (CANCEL) button.

### 5 Press the [7 ▼] (OK) button to confirm the file/folder selection.

### 6 Select the destination tab (USER or USB) to paste the file/folder, by using the TAB [◀][▶] buttons.

If necessary, select the destination folder by using the [A] – [J] buttons.

### 7 Press the [4 ▼] (PASTE) button to paste the file/folder selected in step 4.

The pasted file/folder appears on the display at the appropriate position among the files in alphabetical order.

## Deleting Files/Folders

You can delete individual or multiple files/folders.

### 1 In the File Selection display, select the appropriate tab (USER or USB) which contains the file/folder you want to delete by using the TAB [◀][▶] buttons.

### 2 Make sure that MENU 2 is shown at the bottom right corner of the display.

If necessary, press the [8 ▼] button to call up MENU 2.

### 3 Press the [5 ▼] (DELETE) button.

The window for the Delete operation appears at the bottom of the display.



#### NOTE

Files and folders in the PRESET tab or the "Expansion" folder (page 46) in the USER tab cannot be deleted.

**4 Press one of the [A] – [J] buttons corresponding to the desired file/folder.**

Pressing a button selects (highlights) the file/folder. To cancel the selection, press the same [A] – [J] button again.

Press the [6 ▼] (ALL) button to select all files/folders indicated on the current display including the other pages. To cancel the selection, press the [6 ▼] (ALL OFF) button again.

**5 Press the [7 ▼] (OK) button to confirm the file/folder selection.**

**6 Follow the on-display instructions.**

- **YES** .....Delete the file/folder
- **YES ALL** .....Delete all selected files/folders
- **NO** .....Leave the file/folder as is without deleting
- **CANCEL** .....Cancel the Delete operation

**NOTE**

To cancel the Delete operation, press the [8 ▼] (CANCEL) button.

## Entering Characters

This section covers how to enter characters for naming your files/folders, inputting keywords on Music Finder (page 81), etc. Entering characters is done in the display shown below.

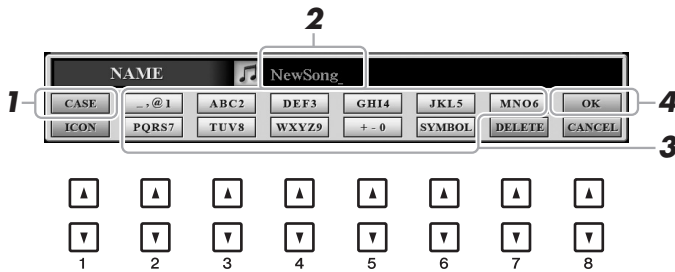

**1 Change the type of character by pressing the [1 ▲] button.**

- **CASE** .....Capital letters, numbers, marks
- **case** .....Lowercase letters, numbers, marks

**2 Use the Data dial to move the cursor to the desired position.**

**3 Press the [2 ▲▼] – [6 ▲▼] and [7 ▲] buttons, corresponding to the character you wish to enter.**

Several different characters are assigned to each button, and the characters change each time you press the button.

To actually enter the selected character, move the cursor or press another character-input button. Alternately, you can wait for a short time and the character will be entered automatically.

For more information on entering characters, refer to “Other character-entry operations” below.

**4 Press the [8 ▲] (OK) button to actually enter the new name and return to the previous display.**

**NOTE**

When inputting lyrics in the Song Creator function (page 165), you may also enter Japanese characters (kana and kanji).

**NOTE**

- The following marks cannot be entered for a file/folder name.  
\\ : \* ? " < >
- File names can contain up to 41 characters and folder names can contain up to 50 characters.

**NOTE**

To cancel the character-entering operation, press the [8 ▼] (CANCEL) button.



## Other Character-entry Operations

### • Deleting characters

Move the cursor to the character you wish to delete by using the Data dial, and press the [7 ▼] (DELETE) button. To delete all characters on the line at once, press and hold the [7 ▼] (DELETE) button.

### • Entering marks or spaces

1. Press the [6 ▼] (SYMBOL) button to call up the mark list.
2. Use the Data dial to move the cursor to the desired mark or space, then press the [8 ▲] (OK) button.

### • Selecting custom icons for files (shown at left of file name)

1. Press the [1 ▼] (ICON) button to call up the ICON SELECT display.
2. Select the icon by using the [A] – [J] buttons, [3 ▲▼] – [5 ▲▼] buttons or Data dial. The display includes several pages. Press the TAB [◀][▶] buttons to select different pages.
3. Press the [8 ▲] (OK) button to apply the selected icon.

#### NOTE

To cancel the operation, press the [8 ▼] (CANCEL) button.

## Resetting to the Factory-programmed Settings

While holding the right-most key (C6) on the keyboard, turn the power on. This resets the settings of the entire instrument (referred to as the System Setup parameters) to their factory default settings. Refer to the “Parameter Chart” in the Data List on the website for details about which parameters belong to System Setup.

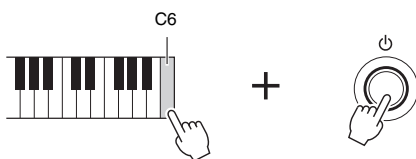

#### NOTE

The recorded Songs (page 68), Expansion Packs (page 46), and other files saved to this instrument are not deleted by this operation.

You can also reset specified settings to the factory default value or delete all files and folders in the USER drive. Call up the operation display: [FUNCTION] → TAB [▶] MENU 2 → [G] SYSTEM → TAB [▶] RESET. For details, refer to the Advanced Features section, Chapter 11 (page 208).

## Data Backup

You can back up all data saved in the USER drive (except Protected Songs and Expansion Voices/Styles) and all settings of the instrument to a USB flash drive as a single file.

**1** Connect a USB flash drive to the [USB TO DEVICE] terminal for the backup destination.

**2** Call up the operation display.

[FUNCTION] → TAB [▶] MENU 2 → [G] SYSTEM → TAB [◀][▶]  
BACKUP/RESTORE

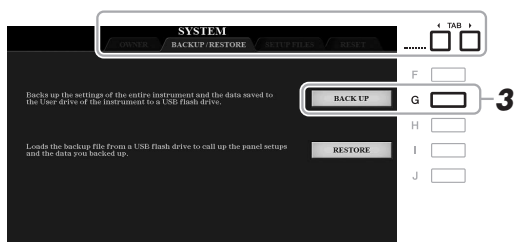

**3** Press the [G] (BACKUP) button to save the data to the USB flash drive.

When confirmation messages appear, follow the on-display instructions.

### NOTE

Before using a USB flash drive, be sure to read "Connecting USB Devices" on page 95.

### NOTE

You can also back up files in the USER drive, such as Voice, Song, Style, Multi Pad and Registration Memory, by copying them individually to a USB flash drive as desired. For instructions, refer to page 30.

### NOTE

You can also back up System settings, MIDI settings, User Effect settings, and Music Finder Records individually as desired. Call up the operation display: [FUNCTION] → TAB [▶] MENU 2 → [G] SYSTEM → TAB [◀][▶] SETUP FILES. For more information, refer to page 207.

### NOTE

Completing the back up/restore operation may take a few minutes.

## Restoring the Backup File

To do this, press the [I] (RESTORE) button in the BACKUP/RESTORE page (see above). When confirmation messages appear, follow the on-display instructions. When the operation is completed, the instrument will be restarted automatically.

### NOTICE

**Move the Protected Songs (saved to the USER drive) to a USB flash drive before restoring. If the Songs are not moved, the operation deletes the data.**

# Basic Operations

<i>Voices</i>	<b>1</b>
<i>Styles</i>	<b>2</b>
<i>Songs</i>	<b>3</b>
<i>USB Audio Player/Recorder</i>	<b>4</b>
<i>Multi Pads</i>	<b>5</b>
<i>Music Finder</i>	<b>6</b>
<i>Registration Memory</i>	<b>7</b>
<i>Oriental Scales</i>	<b>8</b>
<i>Mixing Console</i>	<b>9</b>
<i>Connections</i>	<b>10</b>
<i>Other Functions</i>	<b>11</b>

# Voices

## – Playing the keyboard –

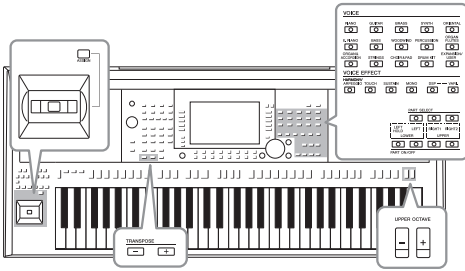

The instrument features a wide variety of exceptionally realistic instrumental Voices, including piano, guitar, strings, brass, wind instruments and more.

## Playing Voices

The Voices can be played via three keyboard parts: LEFT, RIGHT 1 and 2. You can combine these parts by using the PART ON/OFF buttons to create luscious instrument textures and convenient performance combinations.

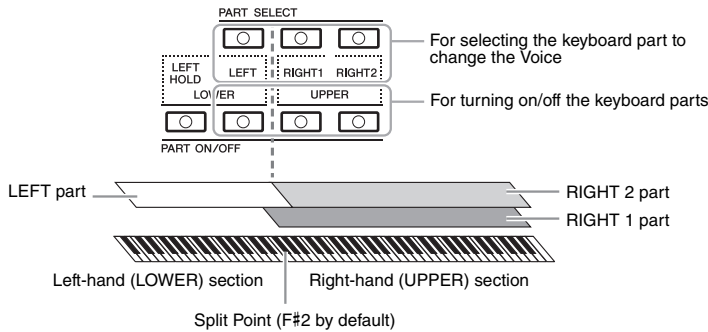

### NOTE

For a list of preset Voices of this instrument, refer to the "Voice List" in the Data List on the website.

- **To play one single Voice on the entire keyboard:**  
Turn on the RIGHT 1 or 2 part.
- **To play two different Voices in layer on the entire keyboard (Layer):**  
Turn on the RIGHT 1 and 2 parts.
- **To play different Voices in the right- and left-hand sections of the keyboard (Split):**  
Turn on the LEFT and RIGHT (1 and/or 2) parts. The F#2 and lower keys are used for the LEFT part while the upper keys (excluding F#2) are used for the RIGHT 1 and 2 parts. The key which divides the keyboard into the left-hand and right-hand sections is referred to as the "Split Point."

### NOTE

The Split Point can be changed (page 58).

## 1 Turn on the PART ON/OFF button corresponding to the part you want to use.

The corresponding PART SELECT button is automatically turned on.

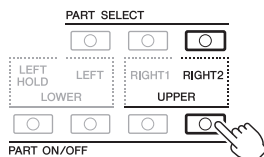

### NOTE

You can save the Voice selection and on/off setting for each part to Registration Memory (page 85).

- 2 Make sure that the **PART SELECT** button corresponding to the part you want to select the Voice is turned on.
- 3 Press one of the **VOICE** category selection buttons to select a Voice category and call up the Voice Selection display.

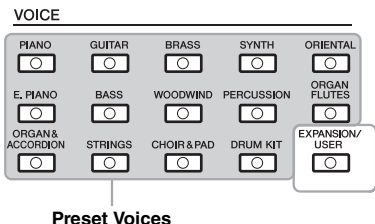

- **Expansion Voices**  
Voices additionally installed (page 46).
- **User Voices**  
Voices created with the Voice Set function (page 113), or Voices copied to the USER drive (page 30).

**NOTE**

By pressing the [8 ▲] (UP) button in the Voice Selection display, you can call up the Voice categories (folders), including "GM&XG" and "GM2," which do not have any VOICE category selection buttons.

The preset Voices are categorized and contained in appropriate folders. Voice category selection buttons correspond to the categories of the preset Voices. For example, press the [STRINGS] button to display various strings Voices.

**NOTE**

If you pressed the [ORGAN FLUTES] button in step 3, press the [I] (PRESETS) button before proceeding to step 4.

- 4 Press one of the [A] – [J] buttons to select the desired Voice.

You can call up the other pages by pressing the buttons that correspond to the page numbers (P1, P2 ...) or by pressing the same VOICE category selection button several times.

**NOTE**

The Voice characteristics are indicated above the Preset Voice name. For details on the characteristics, see page 38.



**NOTE**

You can call up the information for the selected Voice by pressing the [6 ▼] (INFO) button. (Some Voices do not have an information window.)

**To listen to the demo phrases for each Voice**

Press the [7 ▼] (DEMO) button to start the Demo for the selected Voice. To stop the demo, press the [7 ▼] button again.

**NOTE**

Make sure that MENU 1 is shown at the bottom right corner of the display (page 26).

- 5 If necessary, repeat steps 1 – 4 above to select the Voice for the other part.
- 6 Play the keyboard.



### Holding the LEFT part Voice (Left Hold)

By turning on the PART ON/OFF [LEFT HOLD] button when the LEFT part is ON, the LEFT part Voice is held even when the keys are released. Non-decaying Voices such as strings are held continuously, while decay-type Voices such as piano decay more slowly (as if the sustain pedal has been pressed).

This function is convenient when used along with Style playback since the sound of the chord matching Style playback is maintained. To stop the LEFT part Voice which is sounding, stop Style or Song playback, or turn the [LEFT HOLD] button off.

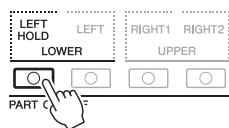

### Using the Metronome

You can start or stop the metronome by pressing the [METRONOME] button. The metronome tempo can be adjusted by the same procedure as with Style tempo (page 52).



#### **NOTE**

You can also change the time signature, volume and sound of the metronome: [FUNCTION] → TAB [◀] MENU 1 → [J] UTILITY → TAB [◀] CONFIG 1 → [A]/[B] 2 METRONOME

## Voice Characteristics

The Voice characteristics are indicated above the Voice name — S.Art!, MegaVoice, Live!, Cool!, Sweet!, etc.



#### • S.Art! (Super Articulation) Voices

The word “articulation” in music usually refers to the transition or continuity between notes. This is often reflected in specific performance techniques, such as staccato, legato and slur. You can call up helpful information on how to play these Voices by pressing the [6 ▼] (INFO) button on the Voice Selection display.

#### • Drums/Live!Drums/SFX/Live!SFX Voices (called up via the [DRUM KIT] button)

These let you play various drums and percussion instruments or SFX (sound effects) sounds on the keyboard, collected together in what are called Drum/SFX kits. For details, see the “Drum/SFX Kit List” of the Data List on the website.

#### • Organ Flutes Voices (called up via the [ORGAN FLUTES] button)

These let you recreate all of the classic organ sounds by adjusting the flute footage levels and the percussive sounds, just like on conventional organs. For details, refer to page 45.

For information about other Voice types, refer to the Advanced Features section (page 102).

#### **NOTE**

- S.Art! Voices are only compatible with other models which have those types of Voices installed. Any Song or Style data you’ve created on the instrument using these Voices will not sound properly when played back on other instruments.
- S.Art! Voices sound differently depending on the keyboard range, velocity, touch, etc. Hence, if you turn on HARMONY/ARPEGGIO (page 42), change the transpose setting (page 39) or change the Voice Set parameters (page 113), unexpected or undesired sounds may result.

# Changing the Pitch of the Keyboard

## Adjusting the Pitch in Semitones (Transpose)

The TRANSPOSE [-]/[+] buttons transpose the overall pitch of the instrument (the keyboard sound, Style playback, Song playback, and so on) between -12 and 12 in semitone steps. To instantly reset the transpose value to 0, press the [+] and [-] buttons simultaneously.

### NOTE

The Transpose functions do not affect the Drum Kit or SFX Kit Voices.

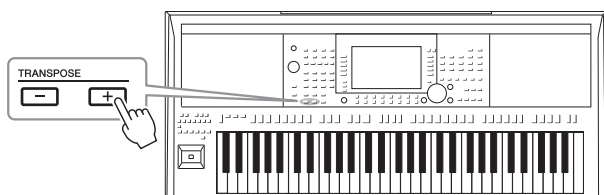

### Transposing the pitch in the MIXING CONSOLE display

You can also make detailed pitch settings (transpose, octave and tune) in the MIXING CONSOLE display called up via [MIXER/EQ] → TAB [◀][▶] TUNE.

## Adjusting the Pitch in Octaves

The UPPER OCTAVE [-]/[+] buttons allow you to shift the pitch of the RIGHT 1 and 2 parts up or down by one octave.

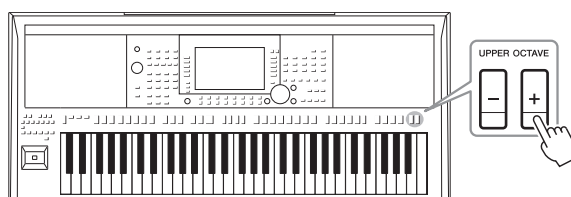

## Fine tuning the Pitch

By default, the pitch of the entire instrument is set to 440.0 Hz according to equal temperament. This basic tuning can be changed in the display called up via [FUNCTION] → TAB [◀] MENU 1 → [E] MASTER TUNE/SCALE TUNE. The pitch can be shifted up or down between 414.8Hz and 466.8Hz in approximately 0.2 Hz increments. For details, refer to the Advanced Features section (page 108).

## Using the Joystick

By moving the joystick in a horizontal (X) or vertical (Y) direction, you can bend the notes up or down, or apply modulation effects by default. You can also assign other functions such as filter control, or turning the Style channels on/off.

### 1 Press the [ASSIGN] button to call up the LIVE CONTROL display.

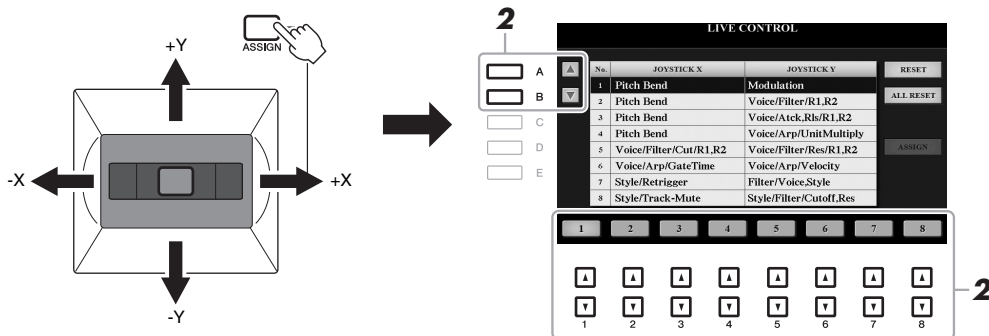

### 2 Use the [A]/[B] buttons or the [1 ▲▼] – [8 ▲▼] buttons to select the desired combination of functions.

The selected number is indicated on the Main display (page 24).

For details on the assignable functions, refer to the Advanced Features section (page 111). The function combinations can also be edited on the PARAMETER ASSIGN display called up by pressing the [I] (ASSIGN) button.

The functions of number 1 are always assigned as shown below and other functions cannot be assigned.

#### • X: Pitch Bend

Bends notes up (by moving the joystick to the right) or down (by moving the joystick to the left) while playing the keyboard. This is applied to all keyboard parts (RIGHT 1, 2 and LEFT). The maximum pitch bend range can be changed on the TUNE page of the Mixing Console display (page 183).

#### • Y: Modulation

Applies modulation effects, which are set on the CONTROLLER page of the VOICE SET display (page 115), to notes played on the keyboard. By default, this is applied to the keyboard parts RIGHT 1, 2 and LEFT. You can set whether the effects controlled by the joystick will be applied or not to each keyboard part independently: [FUNCTION] → TAB [◀] MENU 1 → [D] CONTROLLER → TAB [▶] KEYBOARD/PANEL → [A]/[B] 2 MODULATION (+), 3 MODULATION (-).

#### NOTE

Pressing the [ASSIGN] button repeatedly or rotating the Data dial also lets you select a combination of functions.

#### NOTE

The Pitch Bend effect may not be applied to the LEFT part during Style playback, depending on the Style setting.

#### NOTE

Modulation effects may not be applied to the LEFT part during Style playback, depending on the Style setting.



**3** Move the joystick to control the sound while playing the keyboard or playing back the Style, etc.

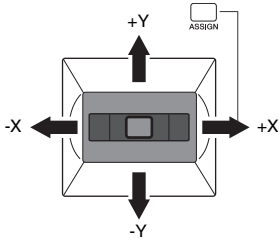

**NOTE**

Pressing the [F] (RESET) button resets the selected function's parameter value to the default, while pressing the [G] (ALL RESET) button resets all parameter values of the assignable functions.

## Applying Voice Effects

You can apply various effects to enhance or change the sound of the keyboard parts (LEFT, RIGHT 1 and 2). The effects can be turned on or off by using the following buttons.

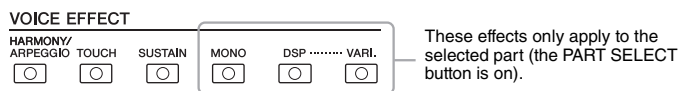

### • HARMONY/ARPEGGIO

The Harmony or Arpeggio is applied to the right-hand Voices. Refer to “Applying Harmony/Echo to Your Right-hand Melody” (see below) or “Triggering Arpeggios with Your Right Hand” (page 44).

### • TOUCH

This button turns the Touch Response of the keyboard on or off. When off, the same volume is produced no matter how strongly or softly you play the keyboard.

### • SUSTAIN

When this Sustain function is on, all notes played on the keyboard with right-hand part (RIGHT 1 and 2) have a longer sustain.

### • MONO

When this button is on, the part’s Voice is played monophonically (only one note at a time) with last note priority, letting you play single, lead sounds such as brass instruments more realistically. Depending on the Voice, Portamento may be produced when notes are played with legato.

When this button is off, the part’s Voice is played polyphonically.

### • DSP/DSP VARI.

With the digital effects built into the instrument, you can add ambience and depth to your music in a variety of ways — such as adding reverb that makes you sound like you are playing in a concert hall.

The [DSP] button is used to turn the DSP (Digital Signal Processor) effect on or off for the currently selected keyboard part.

The [DSP VARI.] button is used to change between variations of the DSP effect. For example, this could be used to change the rotating speed (slow/fast) of the rotary speaker effect while you play.

#### NOTE

You can change the Touch Response type. For instructions, see page 105.

#### NOTE

Portamento is a function that creates a smooth transition in pitch from the first note played on the keyboard to the next.

#### NOTE

The DSP type can be changed. On the Voice Selection display, select [5 ▼] (VOICE SET) → TAB [◀|▶] (EFFECT/EQ → [A]/[B] 2 DSP. For details, refer to page 117.

## Applying Harmony/Echo to Your Right-hand Melody

Performance effects such as harmony (duet, trio, etc.), echo, tremolo and trill can be applied to notes played in the right-hand section of the keyboard according to the chord specified in the left-hand section of the keyboard.

**1** Turn the [HARMONY/ARPEGGIO] button on.

**2** Select the desired Harmony or Echo type.

**2-1** Call up the operation display.

[FUNCTION] → TAB [◀] MENU 1 → [B] HARMONY/ARPEGGIO

**2-2** Use the [1 ▲▼] – [3 ▲▼] buttons to select “Harmony” or “Echo.”

#### NOTE

When you select another Voice, the Harmony/Echo/Arpeggio type is automatically set to the default which is memorized as the Voice Set. For details on the Voice Set function, refer to page 113.

2-3 Use the [4 ▲▼] – [6 ▲▼] buttons to select the desired type.

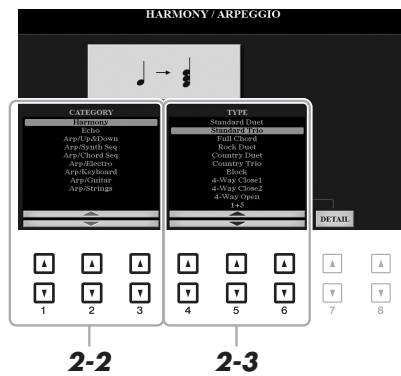

Pressing one of the [7 ▲▼] (DETAIL) buttons calls up the detail setting display. For more information, refer to the Advanced Features section (page 106).

## ■ Harmony Category

### • Standard Duet — Strum

The Harmony effect is applied to the note played in the right-hand section of the keyboard according to the chord specified in the chord or left-hand section shown below.

- When the [ACMP] button is on and the LEFT part is off:

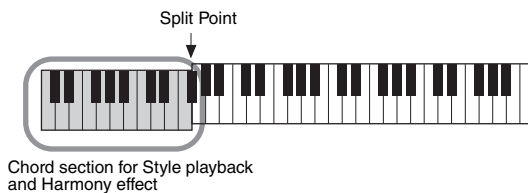

- When the [ACMP] button is off and the LEFT part is on:

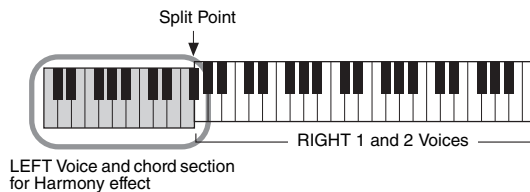

- When both the [ACMP] button and the LEFT part are on:

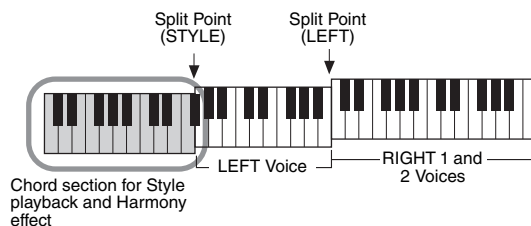

### • Multi Assign

The Multi Assign effect automatically assigns notes played simultaneously on the right-hand section of the keyboard to separate parts (Voices). Both of the keyboard parts [RIGHT 1] and [RIGHT 2] should be turned on when using the Multi Assign effect. The RIGHT 1 and RIGHT 2 Voices are alternately assigned to the notes in the order you play.

#### NOTE

For details on the Split Point, refer to page 58.

#### NOTE

The “1+5” and “Octave” settings are not affected by the chord.

## ■ Echo Category (Echo, Tremolo, Trill)

The Echo, Tremolo or Trill effect is applied to the note played in the right-hand section of the keyboard in time with the currently set tempo, regardless of the [ACMP] and the LEFT part on/off status. Keep in mind that Trill works when you hold down two notes on the keyboard simultaneously (or the last two notes, if more than two notes are held), and it plays those notes alternately.

### 3 Play the keyboard.

The effect selected in step 2 is applied to the right-hand melody.

To turn off the effect, turn the [HARMONY/ARPEGGIO] button off.

## Triggering Arpeggios with Your Right Hand

The Arpeggio function lets you play arpeggios (broken chords) by simply pressing the notes of the chord. For example, you could play the notes C, E and G to trigger interesting phrases. This feature can be used for music production as well as performance.

### 1 Turn the [HARMONY/ARPEGGIO] button on.

### 2 Select the desired Arpeggio type.

**2-1** Call up the operation display.

[FUNCTION] → TAB [◀] MENU 1 → [B] HARMONY/ARPEGGIO

**2-2** Use the [1 ▲▼] – [3 ▲▼] buttons to select a category other than “Harmony” and “Echo.”

**2-3** Use the [4 ▲▼] – [6 ▲▼] buttons to select the desired type.

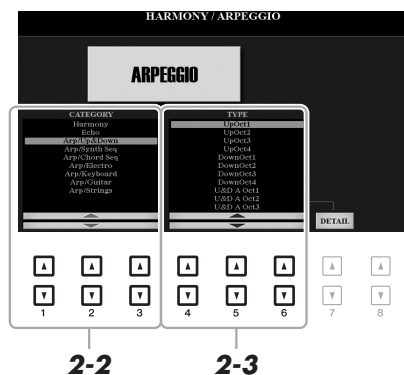

You can set the Arpeggio volume and select the part for playing the Arpeggio in the display called up via the [7 ▲▼] (DETAIL) buttons. For details, refer to the Advanced Features section (page 106).

### 3 Play a note or notes to trigger the Arpeggio.

The arpeggiated phrase differs depending on the notes played.

To turn off the effect, turn the [HARMONY/ARPEGGIO] button off.

#### NOTE

When you select another Voice, the Harmony/Echo/Arpeggio type is automatically set to the default which is memorized as the Voice Set. For details on the Voice Set function, refer to page 113.

#### NOTE

By using the Arpeggio Quantize function, Arpeggio playback can be synchronized with Song/Style playback, allowing any slight imperfections in the timing to be corrected. This can be set in the display: [FUNCTION] → TAB [◀] MENU 1 → [J] UTILITY → TAB [◀|▶] CONFIG 2.

#### NOTE

Arpeggio playback can be continued even after the note has been released, by assigning the Arpeggio Hold function to the footswitch. For instructions, refer to page 193.

#### NOTE

You can control the Arpeggio volume and the length of each note by using the joystick. For instructions on how to assign the functions to the joystick, refer to page 40.

# Creating Your Original Organ Flutes Voices

You can create original Organ Flutes Voices by editing the preset Organ Flutes Voices. Just as on a traditional organ, the original Voices can be created by increasing and decreasing the levels of the flute footages. The created Voices can be saved to internal memory (USER drive) or a USB flash drive for future recall.

## NOTE

The term "footage" is a reference to the sound generation of traditional pipe organs, in which the sound is produced by pipes of different lengths (in feet).

## 1 Press the [ORGAN FLUTES] button.

The FOOTAGE page of the Voice Set display of the last selected Organ Flutes Voice is called up.

If you want to edit another preset Organ Flutes Voice, press the [I] (PRESETS) button to call up the Organ Flutes Voice Selection display, and select as desired. Then, press the [5 ▼] (VOICE SET) button to return to the Voice Set display.

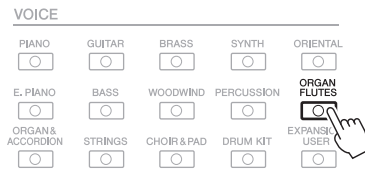

## 2 Use the [1 ▲▼] – [8 ▲▼] buttons to adjust the footage settings.

The footage settings determine the basic sound of the Organ Flutes.

The [1 ▲▼] buttons control two footages: 16' and 5 1/3'. Pressing the [D] button switches between these two footages.

## NOTE

Pressing the [D] button while holding down one of the [1 ▲▼] buttons can select both two footages, and lets you set the same value for them by using the Data dial.

For details on the VOLUME/ATTACK Page and EFFECT/EQ Page, see page 119.

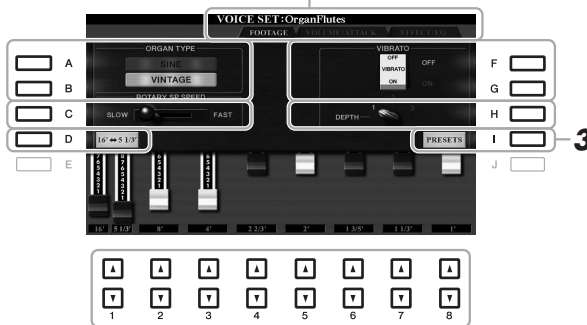

If you want, you can select the Organ type and change other settings, such as Rotary Speaker and Vibrato.

[A]/[B]	ORGAN TYPE	Specifies the type of organ tone generation to be simulated. <b>SINE:</b> Produces a clean, clear sound. <b>VINTAGE:</b> Produces a gritty, slightly distorted sound.
[C]	ROTARY SP SPEED	Alternately switches between the slow and fast rotary speaker speeds when a rotary speaker effect is selected for the Organ Flutes (DSP TYPE parameter in the EFFECT/EQ Page), and the VOICE EFFECT [DSP] button is turned on.
[F]/[G]	VIBRATO	Alternately turns the vibrato effect for the Organ Flutes Voice ON or OFF.
[H]	VIBRATO DEPTH	Sets the Vibrato depth to one of three levels: 1 (low), 2 (mid), or 3 (high).

- 3 Press the [I] (PRESETS) button to call up the Organ Flutes Voice Selection display.
- 4 Save your Organ Flutes Voice by following the procedure on page 28.

**NOTE**

To return to the Voice Set display, press the [5 ▼] (VOICE SET) button.

**NOTICE**

The settings will be lost if you select another Voice or turn the power to the instrument off without carrying out the Save operation.

## Adding New Contents — Expansion Packs

By installing Expansion Packs, you can add a variety of optional Voices and Styles to the “Expansion” folder in the USER drive. The installed Voices and Styles can be selected via the [EXPANSION/USER] button in the VOICE or STYLE category selection buttons, allowing you to expand your music performance and creation possibilities. You can get high quality Expansion Pack data created by Yamaha, or create your own original Expansion Pack data by using the “Yamaha Expansion Manager” software on your computer. This section covers the operations which may be necessary to add new contents to the instrument.

For more information about Expansion Packs, access the following website:

<http://www.yamaha.com/awk/>

To obtain the Yamaha Expansion Manager software and its manuals, access the following website:

<http://download.yamaha.com/>

## Installing the Expansion Pack data from the USB Flash Drive

The file which contains the bundled Expansion Packs (“\*.ppi” or “\*.cpi”) to be installed to the instrument is referred to as “Pack Installation file.” Only one Pack Installation file can be installed to the instrument. If you want to install multiple Expansion Packs, bundle the packs together on your computer by using the “Yamaha Expansion Manager” software. For information on how to use the software, refer to the accompanying manual.

**NOTICE**

You will need to restart the instrument after installation has been completed. Make sure to save all data currently being edited beforehand, otherwise it will be lost.

- 1 Connect the USB flash drive in which the desired Pack Installation file (“\*.ppi” or “\*.cpi”) is saved to the [USB TO DEVICE] terminal.
- 2 Call up the operation display.  
[FUNCTION] → TAB [▶] MENU 2 → [F] PACK INSTALLATION
- 3 Use the [A] – [J] buttons to select the desired Pack Installation file.
- 4 Press the [6 ▼] (INSTALL) button.
- 5 Follow the on-display instructions.

This installs the selected Pack data to the “Expansion” folder in the USER drive.

### Song, Style or Registration Memory containing Expansion Voices or Styles

Song, Style or Registration Memory containing any Expansion Voices or Styles will not sound properly or cannot be called up, if the Expansion Pack data does not exist in the instrument.

We recommend that you write down the name of the Expansion Pack when you create the data (Song, Style or Registration Memory) using Expansion Voices or Styles, so that you can easily find and install the Expansion Pack when necessary.

## Uninstalling the Expansion Pack data

You can uninstall the Expansion Pack data by carrying out the Reset operation for FILES & FOLDERS (see page 208).

### NOTICE

When you reset FILES & FOLDERS, not only the Expansion Pack data, but all other files and folders in the USER drive are deleted.

## Saving the Instrument Info File to the USB Flash Drive

If you use the “Yamaha Expansion Manager” software to manage the Pack data, you may need to retrieve the Instrument Info file from the instrument as described below. For information on how to use the software, refer to the accompanying manual.

**1** Connect the USB flash memory to the [USB TO DEVICE] terminal.

**2** Call up the operation display.

[FUNCTION] → TAB [▶] MENU 2 → [G] SYSTEM → TAB [◀] OWNER

### NOTE

Before using a USB flash drive, be sure to read “Connecting USB Devices” on page 95.



**3** Press the [D] (EXPORT INSTRUMENT INFO) button.

**4** Follow the on-display instructions.

This saves the Instrument Info file to the root directory in the USB flash drive. The saved file is named “PSR-A3000\_InstrumentInfo.n27.”

## Advanced Features

Refer to the Advanced Features section in this manual, **Chapter 1**.



### Selecting GM/XG or other Voices:

Voice Selection display → [8 ▲](UP) → [2 ▲] (P2)

### Touch Response and effect-related settings

- Setting the Touch Response of the keyboard:

[FUNCTION] → TAB [◀] MENU 1 → [D] CONTROLLER → TAB [▶] KEYBOARD/PANEL → [A] 1 TOUCH RESPONSE

- Making detailed settings for Harmony/Arpeggio:

[FUNCTION] → TAB [◀] MENU 1 → [B] HARMONY/ARPEGGIO → [7 ▲▼] (DETAIL)

### Pitch-related settings

- Fine-tuning the pitch of the entire instrument:

[FUNCTION] → TAB [◀] MENU 1 → [E] MASTER TUNE/SCALE TUNE → TAB [◀] MASTER TUNE

- Scale Tuning:

[FUNCTION] → TAB [◀] MENU 1 → [E] MASTER TUNE/SCALE TUNE → TAB [▶] SCALE TUNE

- Changing the part assignment of the TRANSPOSE buttons:

[FUNCTION] → TAB [◀] MENU 1 → [D] CONTROLLER → TAB [▶] KEYBOARD/PANEL → [B] 4 TRANSPOSE ASSIGN

### Editing parameters assigned to the joystick:

[ASSIGN] → [I] (ASSIGN)

### Editing Voices (Voice Set):

Voice Selection display → [8 ▼] MENU 1 → [5 ▼] (VOICE SET)

### Disabling automatic selection of Voice Sets (effects, etc.):

[FUNCTION] → TAB [◀] MENU 1 → [F] VOICE SET FILTER

### Editing Organ Flutes Voices:

[ORGAN FLUTES] → TAB [◀][▶] VOLUME/ATTACK or EFFECT/EQ



# Styles

## – Playing Rhythm and Accompaniment –

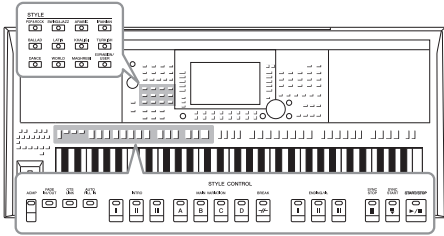

The instrument features various accompaniment and rhythmic backing patterns (called “Styles”) in a variety of different musical genres including pop, jazz, and many others. The Style features Auto Accompaniment, letting you produce automatic accompaniment playback simply by playing “chords” with your left hand. This lets you automatically recreate the sound of a full band or orchestra — even if you’re playing by yourself.

### Playing a Style with the Auto Accompaniment

- 1 Press one of the **STYLE** category selection buttons to call up the Style Selection display.

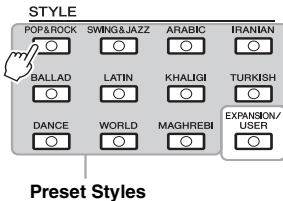

Preset Styles

- **Expansion Styles**  
Styles additionally installed (page 46).
- **User Styles**  
Styles created with the Style Creator function (page 125), or Styles copied to the USER drive (page 30).

#### NOTE

For a list of preset Styles of this instrument, refer to the “Style List” in the Data List on the website.

- 2 Press one of the **[A] – [J]** buttons to select the desired Style.

You can call up the other pages by pressing the buttons that correspond to the page numbers (P1, P2 ...) or by pressing the same STYLE category selection button several times.



- 3 Press the **[ACMP]** button to turn on the Auto Accompaniment.

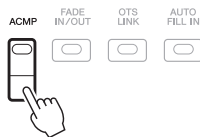

The specific left-hand section of the keyboard (page 58) becomes the chord section, and chords played in this section are automatically detected and used as a basis for fully automatic accompaniment with the selected Style.

#### NOTE

Although the chords will be detected according to the notes you play in the left hand section by default, you can change the chord detection area from the left hand section to the right hand section. For details, refer to page 59.

## 4 Press the [SYNC START] button to enable synchronized start.

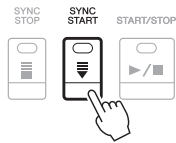

## 5 As soon as you play a chord with your left hand, the selected Style starts.

Try playing chords with your left hand and play a melody with your right hand.



## 6 Press the [START/STOP] button to stop Style playback.

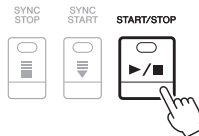

### NOTE

- For information on chords and Chord Fingering types, refer to page 53.
- The chord specified in the chord section is shown on the Main display (page 24).

### NOTE

You can transpose the Style playback (page 39).

### NOTE

You can use the Style Retrigger function by assigning it to the joystick. For instructions, refer to page 40.

## Style Characteristics

The particular type of Style is indicated at the upper left of the Style name in the Style Selection display. The defining characteristics of these Styles and their performance advantages are described below. For the Preset Style List, refer to the Data List on the website.



### • Pro

These Styles provide professional and exciting arrangements combined with perfect playability. The resulting accompaniment exactly follows the chords of the player. As a result, your chord changes and colorful harmonies are instantly transformed into lifelike musical accompaniment.

### • Session

These Styles provide even greater realism and authentic backing by mixing in original chord types and changes, as well as special riffs with chord changes, with the Main sections. These have been programmed to add “spice” and a professional touch to your performances of certain songs and in certain genres. Keep in mind, however, that the Styles may not necessarily be appropriate—or even harmonically correct—for all songs and for all chord playing. In some cases for example, playing a simple major triad for a country song may result in a “jazzy” seventh chord, or playing an on-bass chord may result in inappropriate or unexpected accompaniment.

### • DJ

These Styles can be selected from the category called up via the [DANCE] button. These contain their own special chord progressions, so you can add chord changes to your performance simply by changing the root key. The Multi Pad (page 76) data in the “DJ Phrase” folder are specially created for these Styles. You can call up the suitable Multi Pads by using the One Touch Setting function (page 54).

### NOTE

You cannot specify the chord type, such as major and minor, when using the DJ Styles.

### Style file compatibility

This instrument uses the SFF GE file format (page 8). This instrument can play back existing SFF files, but they will be saved in the SFF GE format when the file is saved (or pasted) in this instrument. Please keep in mind that the saved file can only be played back on instruments that are compatible with the SFF GE format.

# Operating Style Playback

## To Start/Stop Playing

- **[START/STOP] button**

Starts playback of the rhythm part of the current Style. To stop playback, press the button again.



- **[ACMP] button**

Turns the Auto Accompaniment on/off. When this button is on, both the rhythm part and Auto Accompaniment can be played back when playing chords in the chord section during Style playback.



- **[SYNC START] button**

This puts the Style playback in “standby.” The Style starts playing back when you press any note on the keyboard (when [ACMP] is off) or you play a chord with your left hand (when [ACMP] is on). While a Style is playing back, pressing this button stops the Style and puts playback in standby.



- **[SYNC STOP] button**

Make sure that the [ACMP] button is on, then press the [SYNC STOP] button, and play the keyboard. You can start and stop the Style anytime you want by simply playing or releasing the keys in the chord section of the keyboard.



**NOTE**

When the Chord Fingering type (page 53) is set to FULL KEYBOARD or AI FULL KEYBOARD, Sync Stop cannot be turned on.

- **INTRO [I] – [III] buttons**

The instrument features three different Intro sections to add an introduction before starting Style playback. After pressing one of the INTRO [I] – [III] buttons, start playback of the Style. When the Intro finishes playing, Style playback automatically shifts to the Main section.

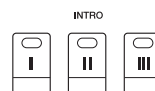

**NOTE**

The INTRO [I] section consists of only the Rhythm part while INTRO [II] and [III] consist of all the parts as well as the Rhythm part. When you play INTRO [II] or [III], in order to have the complete Intro section sound properly, you need to play chords in the chord section with the [ACMP] turned on.

- **ENDING/rit. [I] – [III] buttons**

The instrument features three different Ending sections to add an ending before stopping Style playback. When you press one of the ENDING/rit. [I] – [III] buttons while Style is playing back, the Style will automatically stop after the ending is played. You can have the ending gradually slow down (ritardando) by pressing the same ENDING/rit. button once again, while the ending is playing.

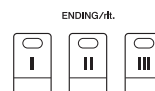

**NOTE**

If you press the ENDING/rit. [I] button when the Style is playing, a fill-in automatically plays before the ENDING/rit [I].

## Changing Pattern Variation (Sections) During Style Playback

Each Style features four different Main sections, four Fill-in sections and a Break section. By using these sections effectively, you can easily make your performance sound more dynamic and professional. The section can be freely changed while the Style is playing back.

### • MAIN VARIATION [A] – [D] buttons

Press one of the MAIN VARIATION [A] – [D] buttons to select the desired Main section (the button lights in red). Each is an accompaniment pattern of a few measures and it plays indefinitely. Pressing the selected MAIN VARIATION button again maintains the same section, but plays an appropriate fill-in pattern to spice up the rhythm and break the repetition.

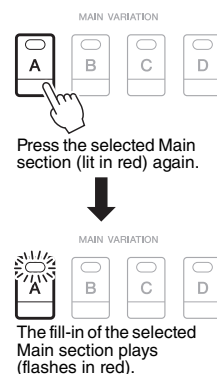

### AUTO FILL function

When the [AUTO FILL IN] button is turned on, pressing any of the MAIN VARIATION [A] – [D] buttons as you play automatically plays a fill-in section for a smooth, dynamic transition into the next (or same) section.



#### NOTE

You can turn the "Half bar fill-in" function on/off by using the pedal. When it is on, changing sections at the first beat of the current section starts the next section from the middle of it with automatic fill-in. For details, refer to the Advanced Features section (page 193).

### • [BREAK] button

This lets you add dynamic breaks in the rhythm of the accompaniment. Press the [BREAK] button during Style playback. When the one-measure Break pattern finishes playing, the Style playback automatically shifts to the Main section.



### About the lamp status of the section buttons (INTRO/MAIN VARIATION/BREAK/ENDING)

- **Red:** The section is currently selected.
- **Red (flashing):** The section will be played next, following the currently selected section.
  - \* The MAIN VARIATION [A] – [D] buttons also flash red during fill-in playback.
- **Green:** The section contains data but is not currently selected.
- **Off:** The section contains no data and cannot be played.

## Adjusting the Tempo

The TEMPO [-] and [+] buttons let you change the playback tempo of Style, Song and Metronome. The tempo of the Style and Song can also be adjusted via the [TAP TEMPO] button.

### • TEMPO [-]/[+] buttons

Press the TEMPO [-] or [+] button to call up the Tempo pop-up display. Use the TEMPO [-]/[+] buttons to decrease or increase the tempo over a range of 5 – 500 beats per minute. Holding down either button can change the value continuously. Pressing both TEMPO [-] and [+] buttons simultaneously lets you call up the default tempo of the last selected Style or Song.

#### NOTE

If you want to adjust the tempo of an Audio file, use the Time Stretch function on page 73.



### • [TAP TEMPO] button

During playback of a Style or Song, you can change the tempo by tapping the [TAP TEMPO] button twice at the desired tempo.

When Style and Song are stopped, tapping the [TAP TEMPO] button (four times for a 4/4 time signature) starts Style playback at the tempo you tapped.



## Fading In/Out

- **[FADE IN/OUT] button**

This produces smooth fade-ins and fade-outs when starting/stopping the playback of a Style or Song. Press the [FADE IN/OUT] button when playback is stopped and press the [START/STOP] button for Style (or the [PLAY/PAUSE] button for Song) to start playback with a fade in. To stop the playback with a fade out, press the [FADE IN/OUT] button during playback.



## Changing the Chord Fingering Type

By changing the Chord Fingering type, you can automatically produce appropriate accompaniment even if you don't press all of the notes which comprise a chord.

### 1 Call up the operation display.

[FUNCTION] → TAB [◀] MENU 1 → [A] SPLIT POINT/CHORD FINGERING → TAB [▶] CHORD FINGERING

### 2 Press the [1 ▲▼] – [3 ▲▼] buttons to select a Chord Fingering type.

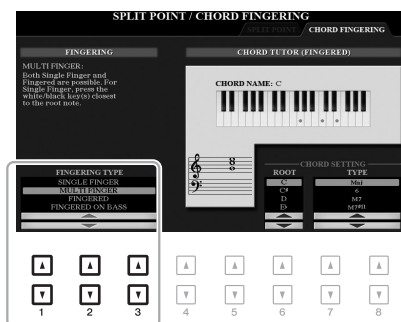

#### NOTE

When the chord detection area is set to "UPPER" (page 59), only "FINGERED\*" is available. This type is basically same as "FINGERED," except that "1+5," "1+8" and Chord Cancel are not available.

The following types can be selected, for example.

- **SINGLE FINGER**

This method lets you easily play chords in the accompaniment range of the keyboard using only one, two or three fingers.



**Major chord**

Press the root key only.



**Minor chord**

Simultaneously press the root key and a black key to its left.



**Seventh chord**

Simultaneously press the root key and a white key to its left.



**Minor seventh chord**

Simultaneously press the root key and both a white and black key to its left.

- **FINGERED**

This lets you specify the chord by pressing the notes making up a chord in the left hand section of the keyboard when [ACMP] is turned on or the LEFT part is turned on. For information on which notes to press for each chord, use the Chord Tutor function (page 54) or refer to page 121.

- **AI FULL KEYBOARD**

This lets you play just about anything, anywhere on the keyboard using both hands — like conventional playing of a piano — and still have appropriate accompaniment. You don't have to worry about specifying the chords. (Depending on the song arrangement, AI Full Keyboard may not always produce appropriate accompaniment.)

For other types, refer to the Advanced Features section (page 120).

## Using the Chord Tutor Function

With this function shown in the right half of this display, you can see which notes to press for specifying the chord. If you know a chord name but don't know how to play it, use this function. Although this function shows how to play a chord only in case of "FINGERED," the indication is useful also when a type other than "SINGLE FINGER" is selected.

Use the [6 ▲▼] buttons to select the chord root then use the [7 ▲▼] – [8 ▲▼] buttons to select the chord type. The notes you need to play are shown in the display.

### NOTE

Depending on the chord, some notes may be omitted.

## Calling up Appropriate Panel Settings for the Current Style (One Touch Setting)

One Touch Setting (OTS) is a powerful and convenient feature that automatically calls up the most appropriate panel settings (Voices or effects, etc.) for the currently selected Style, with the touch of a single button. If you've already decided which Style you wish to use, you can have One Touch Setting automatically select the appropriate Voice for you.

### NOTE

For information on the panel settings that are called up by One Touch Setting, refer to the OTS section of "Parameter Chart" in the Data List on the website.

**1** Select a Style (steps 1 – 2 on page 49).

**2** Press one of the ONE TOUCH SETTING [1] – [4] buttons.

Not only does this instantly call up all the settings (Voices, effects, etc.) that match the current Style, it also automatically turns on [ACMP] and [SYNC START], so that you can immediately start playing the Style.

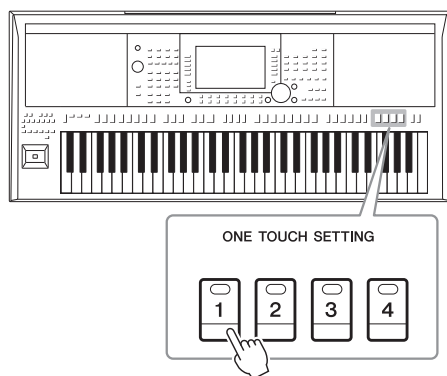

### Confirming the One Touch Setting contents

In the Style Selection display, press the [6 ▼] (OTS INFO) button (when MENU 1 is shown at the bottom right corner of the display) to call up the Information window that shows what Voices are assigned to the ONE TOUCH SETTING [1] – [4] buttons for the current Style.

### NOTE

If a Voice name is shown in gray, this indicates that the corresponding Voice part is turned off when pressing the ONE TOUCH SETTING [1] – [4] buttons.

To close the window, press the [F] (CLOSE) button.

**3** As soon as you play a chord in the chord section, the selected Style starts.

Each Style has four One Touch Setting setups. Press other ONE TOUCH SETTING [1] – [4] buttons to try out other setups.

### NOTE

You can memorize original settings to One Touch Setting. For instructions, refer to page 124

## Automatically changing One Touch Settings with the Main sections (OTS Link)

The convenient OTS (One Touch Setting) Link function lets you automatically have One Touch Settings change when you select a different Main section (A – D). The Main sections A, B, C and D correspond to One Touch Settings 1, 2, 3 and 4 respectively. To use the OTS Link function, turn the [OTS LINK] button on.

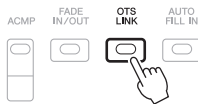

## Finding Suitable Music Pieces for the Current Style (Repertoire)

You can search for music pieces and songs that are most suitable for playing with the current Style by using the Music Finder Records (page 80). You can automatically call up appropriate settings such as Voice, effect and pedal by selecting the desired music piece.

**For optimum use of the Repertoire function, we recommend that you import Music Finder Records (page 82).**

**1** Select the desired Style (steps 1 – 2 on page 49).

**2** Press the [4 ▼] (REPertoire) button.

The MUSIC FINDER display is automatically called up, and the music pieces which can be played with the current Style are shown.

### NOTE

Make sure that MENU 1 is shown at the bottom right corner of the display (page 26).

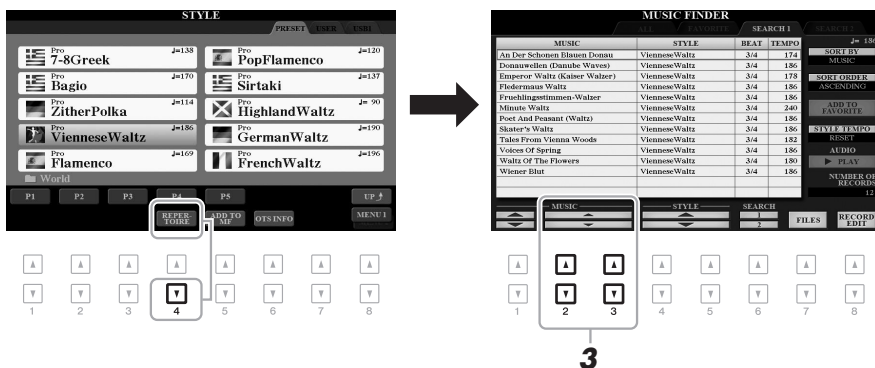

**3** Use the [2 ▲▼]/[3 ▲▼] buttons to select the desired music piece (Record).

The appropriate panel settings for playing the music piece are called up.

### NOTE

Depending on the particular selected Style, there may not be any Records called up.

**4** As soon as you play a chord in the chord section, the selected Style starts.

## Turning On/Off Each Channel of the Style

Each Style contains the channels listed below. You can add variations and change the feeling of a Style by selectively turning channels on/off as the Style plays.

### Style channels

- **RHY1, 2 (Rhythm 1, 2):** These are the basic parts of the Style, containing the drum and percussion rhythm patterns.
- **BASS:** The bass part uses various appropriate instrument sounds to match the Style.
- **CHD1, 2 (Chord 1, 2):** These are rhythmic chord backing parts, commonly used with piano or guitar Voices.
- **PAD:** This part is used for sustained instruments such as strings, organ, choir, etc.
- **PHR1, 2 (Phrase 1, 2):** These parts are used for punchy brass stabs, arpeggiated chords, and other extras that make the accompaniment more interesting.

- 1 Press the [CHANNEL ON/OFF] button repeatedly if necessary to call up the CHANNEL ON/OFF (STYLE) display which contains the desired channel.

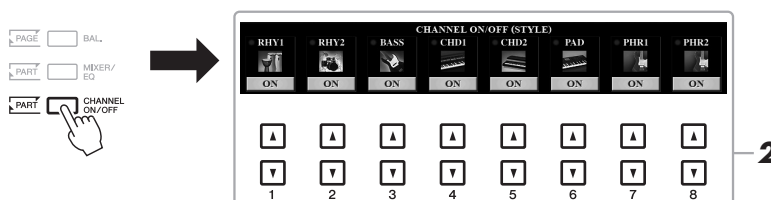

#### NOTE

For information on the CHANNEL ON/OFF (SONG) display, refer to page 65.

- 2 Use the [1 ▼] – [8 ▼] buttons to turn the channels on or off.

To listen to only one channel by itself, hold down the appropriate button for the channel to set the channel to SOLO. To cancel SOLO, simply press the appropriate channel button again.

#### NOTE

You can save the settings here to Registration Memory (page 85).

### To change the Voice for each channel

Press one of the [1 ▲] – [8 ▲] buttons corresponding to the desired channel to call up the Voice Selection display (page 37), then select the desired Voice.

- 3 Press the [EXIT] button to close the CHANNEL ON/OFF display.

#### NOTE

You can also turn Style channels on/off for dynamic effect by using the joystick. For instructions on how to assign the functions to the joystick, refer to page 40.



## Adjusting the Volume Balance Between the Parts

You can adjust the volume balance between the parts (Song, Style, LEFT, RIGHT 1/2, etc.).

- 1 Press the [BAL.] button once or twice to call up the desired page of the BALANCE display which contains the desired channel.**

There are two pages, 1/2 and 2/2.

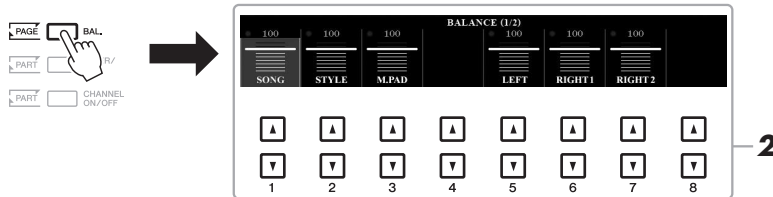

- 2 Use the [1 ▲▼] – [8 ▲▼] buttons to adjust the volume of the desired parts.**

In the BALANCE 1/2 page, you can adjust the volume balance between the Song (page 62), Style, Multi Pad (page 76) and keyboard parts (LEFT, RIGHT1 and 2).

In the BALANCE 2/2 page, you can adjust the volume balance between the Song (MIDI), Audio (page 71), sound input from the [AUX IN] jack, and all keyboard parts (KBD). For information on the [2 ▲▼] – [3 ▲▼] buttons, refer to page 74.

- 3 Press the [EXIT] button to close the BALANCE display.**

### NOTE

On the VOL/VOICE page of the MIXING CONSOLE display (page 91), you can adjust the volume for the Song and Style parts independently.

### NOTE

When the UD-WL01 USB Wireless LAN adaptor is connected to the instrument, "WLAN" appears in the BALANCE 2/2 page, and the volume of the audio input via an iPhone/iPad application tool (page 97) can also be adjusted.

# Setting the Split Point

The key which divides the keyboard into two sections is referred to as “Split Point.” There are two Split Points: Split Point (LEFT) and Split Point (STYLE).

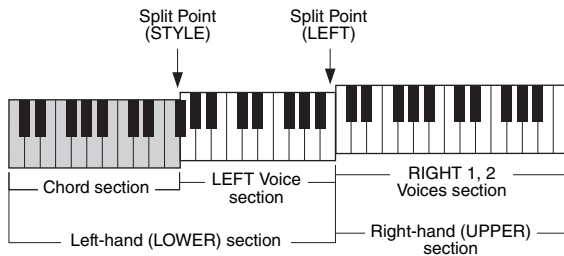

- **Split Point (LEFT):**

Divides the keyboard into the left-hand (LOWER) section and the right-hand (UPPER) section.

- **Split Point (STYLE):**

Divides the left-hand (LOWER) section into the chord section and the LEFT Voice section.

## 1 Call up the Split Point display.

[FUNCTION] → TAB [◀] MENU 1 → [A] SPLIT POINT/CHORD FINGERING → TAB [◀] SPLIT POINT

## 2 Set the Split Point.

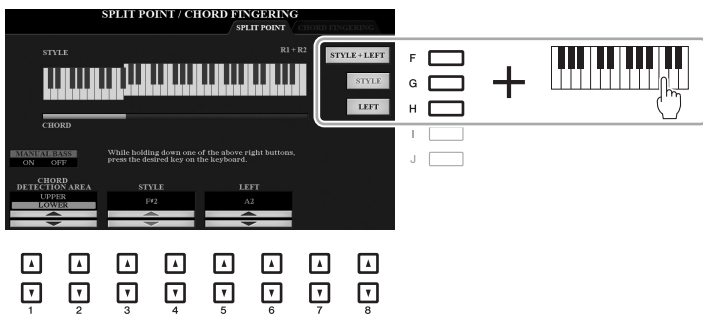

**NOTE**

You can also specify each Split Point by note name, using the [3 ▲▼]–[6 ▲▼] buttons.

[F]	STYLE + LEFT	Sets Split Point (STYLE) and Split Point (LEFT) to the same note. Press the [F] button and rotate the Data dial. You can also specify the Split Point directly from the keyboard by pressing the desired key on the keyboard while holding the [F] button.
[G]	STYLE	Sets each Split Point individually. Press one of the desired buttons and rotate the Data dial. You can also specify the Split Point directly from the keyboard by pressing the desired key on the keyboard while holding the appropriate button, [G] or [H].
[H]	LEFT	
		<p><b>NOTE</b></p> <p>Split Point (LEFT) cannot be set lower than Split Point (STYLE).</p>

## Specifying Chords with Your Right Hand while Playing Bass with Your Left Hand

By changing the chord detection area from the left-hand section to the right-hand section, you can play a bass line with your left hand while using your right hand to control Style playback.

### 1 Call up the Split Point display.

[FUNCTION] → TAB [◀] MENU 1 → [A] SPLIT POINT/CHORD FINGERING → TAB [◀] SPLIT POINT

### 2 Use the [1 ▲▼]/[2 ▲▼] buttons to set the CHORD DETECTION AREA to “UPPER.”

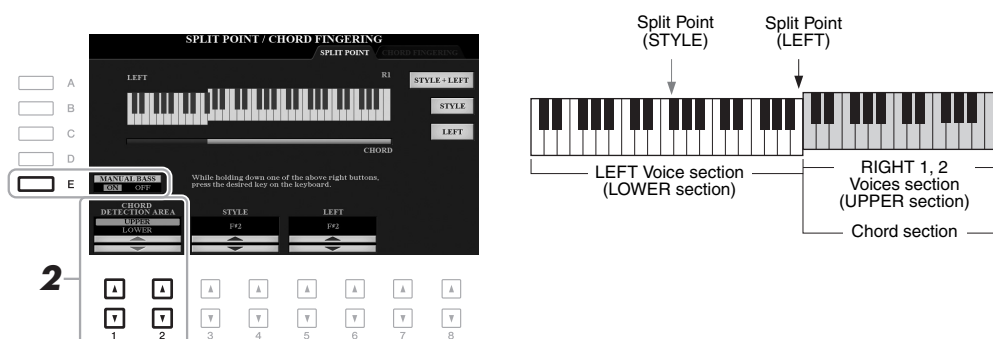

With this setting, the whole right-hand (UPPER) section functions as the Chord section as well as for melody performance. In this condition, note the following points:

- In the right-hand (UPPER) section, you can specify the chord type as you play the melody.
- When the Manual Bass function is turned on via the [E] button, the Voice for the Bass part of the current Style is muted and assigned to the left-hand (LOWER) section.
- The Chord Fingering setting (page 53) will be set to a specific type (“FIN-GERED\*”) automatically, in which case you should press three or more notes simultaneously to specify the chord. Pressing two or less notes does not change the chord type.
- Split Point (STYLE) is unavailable.

#### NOTE

This type is basically same as “FIN-GERED,” except that “1+5,” “1+8” and Chord Cancel are not available.

## Creating/Editing Styles (Style Creator)

The Style Creator function lets you create original Styles by recording rhythm patterns from the keyboard and using already-recorded Style data. Basically, select a preset Style that is closest to the type you want to create, then record the rhythm pattern, bass line, chord backing, or phrase (referred to as “Source Pattern” in the Style Creator) for each channel of each Section.

This section gives you a brief introduction of the Style Creator function. For instructions on how to use the function, refer to the Advanced Features section (page 125).

### Style Data Structure — Source Patterns

A Style is made up of the different Sections (Intro, Main, Ending, etc.) and each Section has eight separate channels, each of which is referred to as “Source Pattern.” With the Style Creator feature, you can create a Style by separately recording the Source Pattern for each channel, or by importing pattern data from other existing Styles.

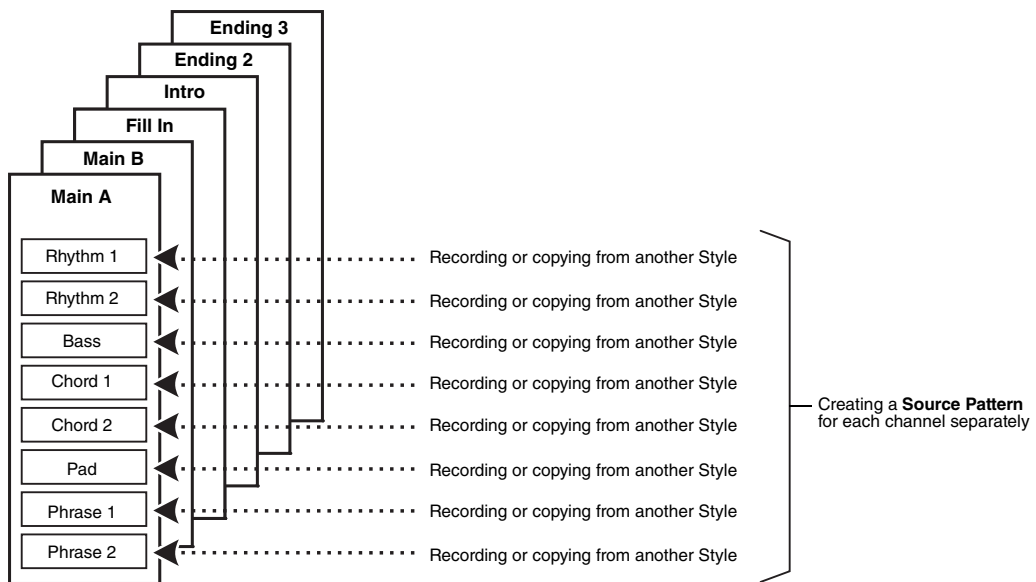

### Editing the Rhythm Part of a Style (Drum Setup)

The Rhythm parts of a preset Style consist of a preset Drum Kit, and each drum sound is assigned to a separate note. You may want to change the sound and the note assignments, or make more detailed settings such as volume balance, effect, etc. By using the Drum Setup function of the Style Creator, you can edit the Rhythm part of a Style and save it as an original Style. For details, refer to the Advanced Features section (page 140).

## Advanced Features

Refer to Advanced Features section in this manual, **Chapter 2**.



<b>Style playback related settings:</b>	[FUNCTION] → TAB [◀] MENU 1 → [G] STYLE SETTING
<b>Memorizing original One Touch Settings:</b>	[MEMORY] + ONE TOUCH SETTING [1] – [4]
<b>Creating/editing Styles (Style Creator):</b>	[FUNCTION] → TAB [▶] MENU 2 → [A] STYLE CREATOR
• Realtime Recording:	→ TAB [◀] BASIC
• Step Recording:	→ TAB [▶] EDIT → [G] STEP REC
• Style Assembly:	→ TAB [◀][▶] ASSEMBLY
• Editing the rhythmic feel:	→ TAB [◀][▶] GROOVE
• Editing data for each channel:	→ TAB [◀][▶] CHANNEL
• Making Style File Format settings:	→ TAB [◀][▶] PARAMETER
• Editing the rhythm part of a Style (Drum Setup)	→ TAB [◀] BASIC → [G] DRUM SETUP

# Songs

## – Playing, Practicing and Recording Songs –

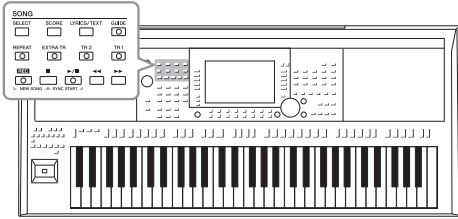

For the PSR-A3000, “Song” refers to the MIDI songs which include preset songs, commercially available MIDI format files, etc. Not only can you play back a Song and listen to it, but you can also play the keyboard along with Song playback and record your own performance as a Song.

### **NOTE**

For instructions on playback and recording of audio files, refer to page 71.

## Playback of Songs

You can play back the following types of Songs.

- Preset Songs (in the PRESET tab of the Song Selection display)
- Your own recorded Songs (page 68)
- Commercially available Song data: SMF (Standard MIDI File)

If you want to play back a Song in USB flash drive, connect the USB flash drive containing Song data to the [USB TO DEVICE] terminal beforehand.

### **NOTE**

For information on compatible data formats, refer to page 8.

### **NOTE**

Before using a USB flash drive, be sure to read “Connecting USB Devices” on page 95.

- 1 Press the SONG [SELECT] button to call up the Song Selection display.

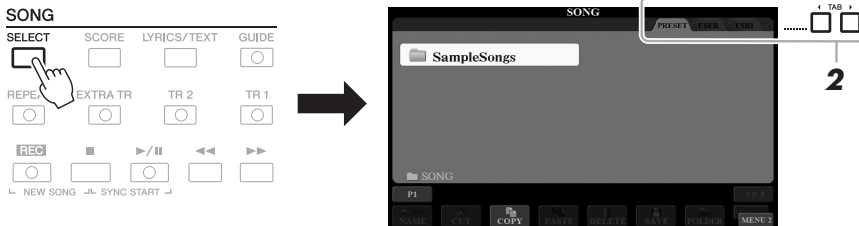

- 2 Use the TAB [◀][▶] buttons to select the location of the desired Song.
- 3 Select the desired Song by using the [A] – [J] buttons.

#### 4 Press the SONG [▶/||] (PLAY/PAUSE) button to start playback.



#### NOTE

You can transpose the Song playback (page 39).

#### Queuing the next Song for playback

While a Song is playing back, you can queue up the next Song for playback. This is convenient for chaining it to the next Song smoothly during live performance. Select the Song you want to play next in the Song Selection display, while a Song is playing back. The “NEXT” indication appears at the upper right of the corresponding Song name. To cancel this setting, press the [7 ▼] (NEXT CANCEL) button.

#### NOTE

Make sure that MENU 1 is shown at the bottom right corner of the display (page 26).

#### 5 Press the SONG [■] (STOP) button to stop playback.



## Playback-related Operations

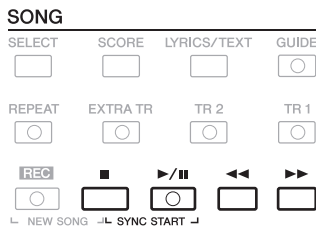

- Synchro Start** .....While playback is stopped, hold down the SONG [■] (STOP) button and press the [▶/||] (PLAY/PAUSE) button. The [▶/||] (PLAY/PAUSE) button flashes, indicating the standby status. You can start playback as soon as you play the keyboard.  
To cancel the Synchro Start function, press the SONG [■] (STOP) button.
- Pause** .....Press the [▶/||] (PLAY/PAUSE) button during playback. Pressing it again resumes Song playback from the current position.
- Rewind/Fast Forward** .....Press the [◀◀] (REW) or [▶▶] (FF) during playback or while the Song is stopped. Pressing either of them once moves back/forward one measure. Holding either of them scrolls backward/forward continuously.

#### NOTE

- You can adjust the volume balance between the Song and keyboard (page 57). On the VOL/VOICE page of the Mixing Console display (page 91), you can adjust the volume for each Song channel.
- You can also adjust the volume balance between the Song and Audio (page 74).

#### NOTE

You can also turn specific part(s) on or off (page 65).

Pressing the [◀◀] (REW) or [▶▶] (FF) button calls up a pop-up display showing the current measure number (or Phrase Mark number).

While the Song Position pop-up is shown on the display, you can also use the Data dial to adjust the value.

**For Songs not containing Phrase Marks**

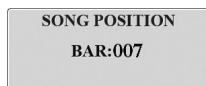

**For Songs containing Phrase Marks**  
You can change the unit for rewinding/fast-forwarding by pressing the [D] (BAR) or the [E] (PHRASE MARK) button.



**NOTE**

Phrase Mark is a pre-programmed marker in certain Song data, which indicates a specific location in the Song.

- **Adjusting the Tempo**  
.....Same procedure as with Style tempo. See page 52.
- **Fading In/Out** .....Same procedure as with Style. See page 53.

## Displaying Music Notation (Score)

You can view the music notation (score) of the selected Song.

**1 Select a Song (steps 1 – 3 on page 62).**

**2 Press the [SCORE] button to call up the SCORE display.**

You can look through the entire notation by using the TAB [◀][▶] buttons when the Song playback is stopped. As Song playback starts, the “ball” bounces along through the score, indicating the current position.

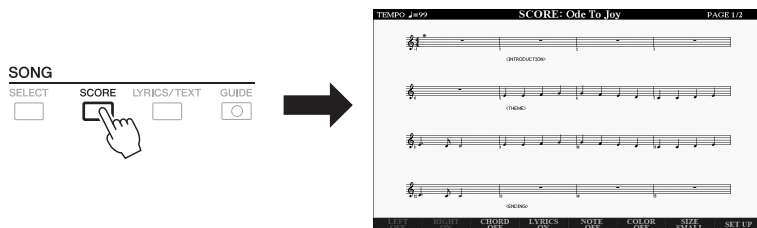

**NOTE**

This instrument can display the music notation of your recorded Song, or commercially available MIDI files (only those which allow devices to indicate notation).

**NOTE**

The displayed notation is generated by the instrument based on the Song data. As a result, it may not be exactly the same as commercially available sheet music of the same song — especially when displaying notation of complicated passages or many short notes.

You can change the displayed notation style by using the [1 ▲▼] – [8 ▲▼] buttons. For details, refer to the Advanced Features section (page 143).



## Displaying Lyrics/Text

When the selected Song contains lyrics data, you can view it on the instrument's display. Even if the Song does not contain lyrics data, you can view the lyrics on the display by loading the text file (.txt file less than 60 KB) created on a computer via USB flash drive. Text display allows for a variety of useful and convenient possibilities, such as the showing of lyrics, chord charts, and performance notes.

**1** Select a Song (steps 1 – 3 on page 62).

**2** Press the [LYRICS/TEXT] button to call up the LYRICS/TEXT display.

You can switch between the LYRICS display and the TEXT display by using the [1 ▲▼] buttons.

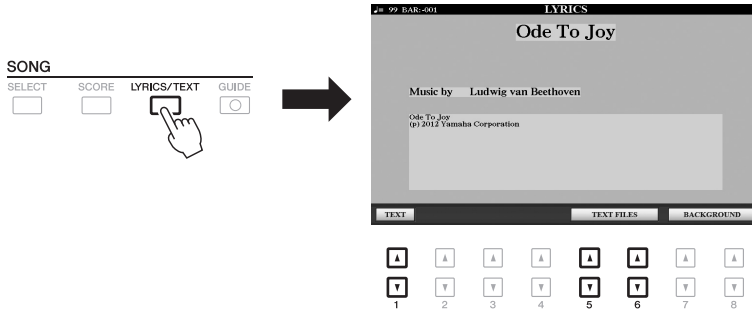

When the Song data contains lyrics data, the lyrics are shown on the LYRICS display. You can look through the entire lyrics by using the TAB [◀][▶] buttons when Song playback is stopped. As Song playback starts, the color of the lyrics changes, indicating the current position.

To view the text file on the TEXT display, press one of the [5 ▲▼]/[6 ▲▼] (TEXT FILES) buttons to call up the File Selection display and select the desired file created on your computer.

For more information about the LYRICS (TEXT) display, refer to the Advanced Features section (page 145).

### NOTE

When the lyrics are garbled or unreadable, you may need to change the Lyrics Language setting: [FUNCTION] → TAB [◀] MENU 1 → SONG SETTING → TAB [▶] OTHERS

### NOTE

Information about Text File selection can be memorized to the Registration Memory (page 85).

### NOTE

You can conveniently turn to the next/previous text page by assigning the function to the foot pedal: [FUNCTION] → TAB [◀] MENU 1 → [D] CONTROLLER → TAB [◀] FOOT PEDAL

## Turning Each Channel of the Song On/Off

A Song consists of 16 separate channels. You can independently turn each channel of the selected Song playback on or off.

**1** Press the [CHANNEL ON/OFF] button several times to call up the CHANNEL ON/OFF (SONG) display.

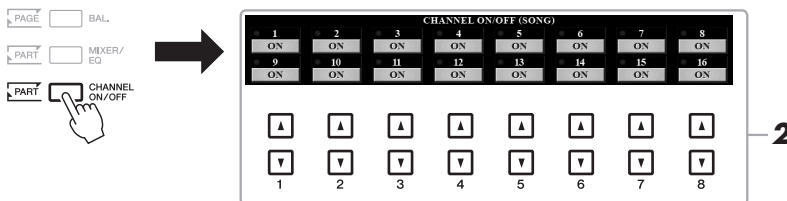

## 2 Use the [1 ▲▼] – [8 ▲▼] buttons to turn each channel on or off.

If you want to play back only one particular channel (solo playback), press and hold down one of the [1 ▲▼] – [8 ▲▼] buttons to set the desired channel to SOLO. Only the selected channel is turned on and others are off. To cancel solo playback, press the same button again.

### NOTE

Usually, each part is recorded to the following channels.  
Channels 1 – 3: keyboard parts (RIGHT 1, LEFT, RIGHT 2)  
Channels 5 – 8: Multi Pad parts  
Channels 9 – 16: Style parts

## One-handed Practice with the Guide Function

You can mute the right-hand part to try practicing that part on your own. The explanations here apply when you practice the right-hand part with “Follow Lights” of the Guide functions. You can practice at your own pace — since the accompaniment waits for you to play the notes correctly. In the SCORE display, you can see the note to play and the current position.

### 1 Select a Song and call up the SCORE display (page 64).

### 2 Turn the [GUIDE] button on.

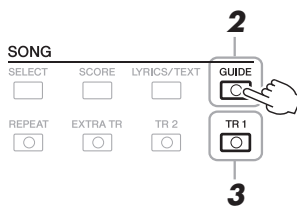

### 3 Turn the [TR 1] button off to mute the right-hand part.

You can now play that part by yourself.

### 4 Press the SONG [▶/||] (PLAY/PAUSE) button to start playback.

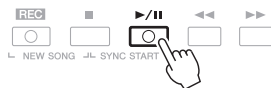

### NOTE

Usually, Ch 1 (right-hand part) is assigned to [TR 1] button, Ch 2 (left-hand part) is assigned to [TR 2] button, and Ch 3 – 16 are assigned to [EXTRA TR] button.

Practice the muted part while viewing the SCORE display. The playback of the left and extra parts will wait for you to play the notes correctly.

After your practice, turn the [GUIDE] button off.

#### Other Guide functions

In addition to the “Follow Lights” function explained above, there are more functions in the Guide features, for practicing the timing of playing the keys (Any Key), for Karaoke or for practicing a song at your own pace (Your Tempo).

[FUNCTION] → TAB [◀] MENU 1 → [H] SONG SETTING → TAB [◀] GUIDE/CHANNEL → [A]/[B] GUIDE MODE

For more information, refer to the Advanced Features section (page 148).

## Repeat Playback

The Song Repeat functions can be used to repeatedly play back a Song or a specific range of measures in a Song. This is useful for repeated practicing of difficult-to-play phrases.

To repeat a Song, turn the [REPEAT] button on and play back the desired Song. Turning the [REPEAT] button off cancels Repeat playback.



### NOTE

You can play multiple Songs repeatedly:  
[FUNCTION] → TAB [◀] MENU 1 →  
[H] SONG SETTING → TAB [▶] OTHERS → [G] REPEAT MODE.

## Specifying a Range of Measures and Playing them Back Repeatedly (A-B Repeat)

- 1 Select a Song (steps 1 – 3 on page 62).
- 2 Press the SONG [▶/||] (PLAY/PAUSE) button to start playback.
- 3 Specify the repeat range.

Press the [REPEAT] button at the starting point (A) of the range to be repeated. Press the [REPEAT] button again at the ending point (B). After an automatic lead-in (to help guide you into the phrase), the range from Point A to Point B is played back repeatedly.

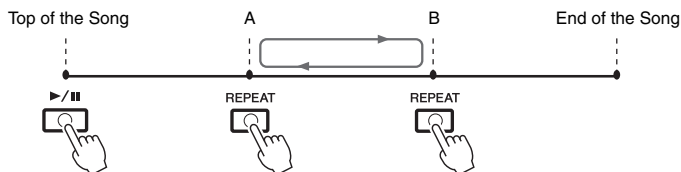

### NOTE

Specifying only Point A results in repeat playback between Point A and the end of the Song.

### NOTE

When you want to repeat from the top of the Song to the middle of the Song:

- 1 Press the [REPEAT] button, then start Song playback.
- 2 Press the [REPEAT] button again at the ending point (B).

- 4 To stop playback, press the SONG [■] (STOP) button.

The Song position returns to Point A and pressing the SONG [▶/||] (PLAY/PAUSE) button lets you start from that point again.

After you've finished practicing, press the [REPEAT] button to turn off Repeat playback.

### Specifying the repeat range while Songs are stopped

1. Fast-forward the Song to Point A, then press the [REPEAT] button.
2. Fast-forward the Song to Point B, then press the [REPEAT] button again.

# Recording Your Performance

You can record your performance and save it as a MIDI file (SMF format 0) to the USER drive or USB flash drive. Since the recorded data is MIDI, you can easily edit your Songs.

Two recording methods are available:

- **Quick Recording**.....see section below  
You can record all parts of your performance at once or a specific part (right-hand, left-hand or Style playback).
- **Multi Track Recording**.....page 69  
You can record data to each channel one by one, to create a single, multi-part Song. The channel/part assignments can be freely changed.

## NOTE

For instructions on the recording of audio songs (files), see page 74.

## NOTE

Audio data such as the rhythm channels created via the audio data of Audio Link Multi Pad (page 78) and audio files (page 71) cannot be recorded to the MIDI Songs.

## Quick Recording

Before recording, make the necessary settings such as Voice/Style selection. With this recording, each part will be recorded to the following channels.

- **Keyboard parts:** channels 1 – 3
- **Multi Pad parts:** channels 5 – 8
- **Style parts:** channels 9 – 16

### 1 Press the SONG [REC] button and the [■] (STOP) button simultaneously.



A blank Song for recording is automatically set, and the Song name on the Main display (page 24) is set to “NewSong.”

### 2 Press the SONG [REC] button.



The [REC] and [▶/||] (PLAY/PAUSE) buttons flashes, indicating the standby status.

### 3 Start recording.

You can start recording by playing the keyboard, starting a Style, playing a Multi Pad or pressing the SONG [▶/||] (PLAY/PAUSE) button.



### 4 After you finish your performance, press the SONG [■] (STOP) button to stop recording.



A message may appear prompting you to save the recorded data. Press the [EXIT] button to close the message.

## NOTE

To cancel the recording, press the [■] (STOP) button before going on to step 3.

## NOTE

You can use the metronome (page 38) while recording; however, the metronome sound will not be recorded.

- 5 Press the SONG [▶/||] (PLAY/PAUSE) button to play back the recorded performance.



- 6 Save the recorded performance as a Song.

- 6-1 Press the SONG [SELECT] button to call up the Song Selection display.
- 6-2 Save the recorded data as a file by following the instructions on page 28.

**NOTICE**

The recorded Song will be lost if you change to another Song or you turn the power off without carrying out the Save operation.

**Recording a specific part**

In place of step 2, pressing the SONG [TR1] (or [TR2]) button while holding the [REC] button enables you to record only the right-hand (or left-hand) part.  
Pressing the [EXTRA TR] button while holding the [REC] button enables recording of only Style and Multi Pad playback.

**Recording Each Channel Individually (Multi Track Recording)**

You can create a Song consisting of 16 channels by recording your performance to each channel one by one. In recording a piano piece, for example, you can record the right-hand part to channel 1 then record the left-hand part to channel 2, allowing you to create a complete piece which may be difficult to play live with both hands together. To record a performance with Style playback, for example, record the Style playback to channels 9 – 16, then record melodies to channel 1 while listening to the already recorded Style playback.  
Before recording, make the necessary settings such as Voice/Style selection.

- 1 Press the SONG [REC] button and the [■] (STOP) button simultaneously.

A blank Song for recording is automatically set, and the Song name on the Main display (page 24) is set to “NewSong.”

- 2 While holding down the SONG [REC] button, press the appropriate [1 ▲▼] – [8 ▲▼] buttons to set the desired channels to “REC.”

To cancel the REC status of the channel, press the desired channel button.

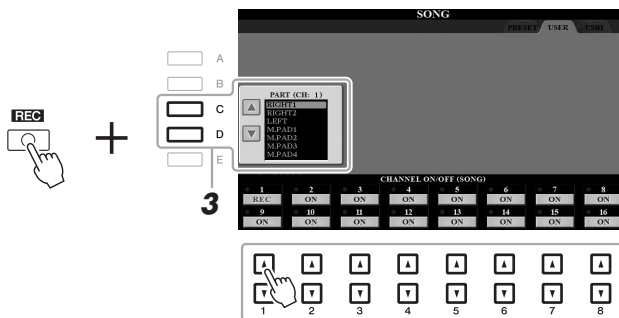

- 3 Use the [C]/[D] buttons to change the part assignment for the channel to be recorded.

**NOTE**

To cancel the recording, press the [■] (STOP) button before going on to step 4.

## 4 Start recording.

You can start recording by playing the keyboard, starting a Style, playing a Multi Pad or pressing the SONG [▶/■] (PLAY/PAUSE) button.



## 5 After you finish your performance, press the SONG [■] (STOP) button to stop recording.

A message may appear prompting you to save the recorded data. Press the [EXIT] button to close the message.

## 6 Press the SONG [▶/■] (PLAY/PAUSE) button to play back the recorded performance.

## 7 Record your performance to another channel by repeating steps 2 to 6 above.

## 8 Save the recorded performance as a Song.

**8-1** Press the SONG [SELECT] button to call up the Song Selection display.

**8-2** Save the recorded data as a file by following the instructions on page 28.

### NOTE

The Style Retrigger function (page 112) cannot be used when you are overdubbing to existing data.

### NOTICE

The recorded Song will be lost if you change to another Song or you turn the power off without carrying out the Save operation.

## Advanced Features

Refer to the Advanced Features section in this manual, **Chapter 3**.



### Editing Music Notation settings:

[SCORE] → [1 ▲▼] – [8 ▲▼] buttons

### Editing Lyrics/Text display settings:

[LYRICS/TEXT] → [1 ▲▼] – [8 ▲▼] buttons

### Using the Auto Accompaniment features with Song Playback:

SONG [■] + [▶/■] → [ACMP] → STYLE CONTROL [SYNC START] → STYLE CONTROL [START/STOP]

### Song Playback related parameters:

[FUNCTION] → TAB [◀] MENU 1 → [H] SONG SETTING

- Keyboard and vocal practice using the Guide function:

→ TAB [◀] GUIDE/CHANNEL

- Playing backing parts with the Performance Assistant Technology:

→ TAB [▶] OTHERS → [6 ▲▼]/[7 ▲▼] P.A.T.

### Creating/Editing Songs (Song Creator):

[FUNCTION] → TAB [▶] MENU 2 → [B] SONG CREATOR

- Recording melodies (Step Recording):
- Recording chords (Step Recording):
- Selecting the setup parameters recorded to the top position of the Song
- Re-recording a specific section — Punch In/Out:
- Editing channel events:
- Editing chord events, notes, System Exclusive events and lyrics:

→ TAB [◀][▶] 1-16

→ TAB [◀][▶] CHORD

→ TAB [◀][▶] SETUP

→ TAB [◀] REC MODE

→ TAB [◀][▶] CHANNEL

→ TAB [◀][▶] CHORD, 1-16, SYS/EX. or LYRICS

# USB Audio Player/Recorder

– Playing Back and Recording Audio Files –

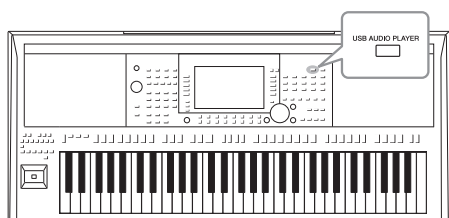

The convenient USB Audio Player/Recorder function allows you to play back audio files (WAV or MP3) saved to a USB flash drive — directly from the instrument. Moreover, since you can record your performances and recordings as audio files (WAV) to a USB flash drive, it is possible to play back the files on computer, share them with your friends, and record your own CDs to enjoy as well.

## NOTE

For instructions on playback and recording of MIDI Songs, refer to page 62.

## Playing Back Audio Files

You can play back audio files saved to the USB flash drive in the following formats.

- **WAV** .....44.1 kHz sample rate, 16 bit resolution, stereo
- **MP3** .....MPEG-1 Audio Layer-3: 44.1/48.0 kHz sample rate, 64 – 320 kbps with variable bit rate, mono/stereo

**1** Connect the USB flash drive containing the audio files to the [USB TO DEVICE] terminal.

**2** Press the [USB AUDIO PLAYER] button to call up the USB AUDIO PLAYER display.



**3** Press the [H] (FILES) button to call up the Audio File Selection display.

## NOTE

DRM (Digital Rights Management) protected files cannot be played back.

## NOTE

Before using a USB flash drive, be sure to read "Connecting USB Devices" on page 95.

## NOTE

While selecting the desired audio file (WAV) in the Audio Link Multi Pad function (step 5 on page 78), the [USB AUDIO PLAYER] button does not function.

#### 4 Press one of the [A] – [J] buttons to select the desired file.



#### NOTE

Audio files take a slightly longer time to load than other files.

#### Viewing Audio file information

Pressing the [6 ▼] (INFO) button calls up the Information window which you can view the file name, path, sample rate etc. of the selected red-framed file.

#### NOTE

Make sure that MENU 1 is shown at the bottom right corner of the display (page 26).

To close the window, press the [F] (OK) button.

#### 5 Press the [7 ▼] (AUDIO PLAY) button to start playback.

The display automatically returns to the USB AUDIO PLAYER display.

#### 6 To stop playback, press the [2 ▲▼] (STOP) button.



#### NOTE

Make sure that MENU 1 is shown at the bottom right corner of the display (page 26).

#### NOTICE

Do not attempt to disconnect the USB flash drive or turn the power off during playback. Doing so may corrupt the USB flash drive data.



## Playback-related Operations

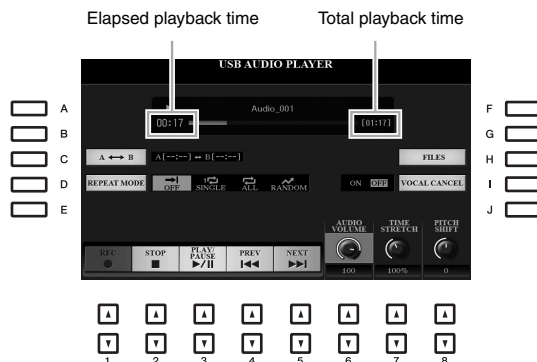





[2 ▲▼]	STOP	Stops playback.
[3 ▲▼]	PLAY/PAUSE	Starts or pauses playback at the current position.
[4 ▲▼]	PREV	Pressing this selects the previous file; holding it moves continuously back through the current file (in seconds).
[5 ▲▼]	NEXT	Pressing this selects the next file; holding it moves continuously forward through the current file (in seconds).
[6 ▲▼]	AUDIO VOLUME	Adjusts the volume of the current audio file. <b>NOTE</b> The volume balance between the Song playback and audio file playback can be adjusted via the [BAL.] button. For instructions, refer to page 74.
[7 ▲▼]	TIME STRETCH	Adjusts the playback speed by stretching/compressing the audio, compared to an original speed of 100%. Higher values result in a faster tempo. <b>NOTE</b> • The value can be adjusted from 70% to 160%. • Time Stretch cannot be applied to MP3 files of 48.0 kHz sample rate.
[8 ▲▼]	PITCH SHIFT	Shifts the pitch between -12 and 12 in semitone steps. <b>NOTE</b> Pitch Shift cannot be applied to MP3 files of 48.0 kHz sample rate.
[I]	VOCAL CANCEL	Cancels or attenuates the center position of the stereo sound. This lets you sing “karaoke” style with just instrumental backing, since the vocal sound is usually at the center of the stereo image in most recordings.

### A-B Repeat Playback via the [C] (A↔B) button

The specified section (between the A and B points) can be played back repeatedly.

- To set the A point, press the [C] button when playback reaches to the desired point.  
The time set as the A point is shown in at “A [---]” in the display, and is indicated by the first wedge mark in the playback progress bar.
- To set the B point, press the [C] button again when playback reaches to the desired point.  
The time set as the B point is shown in at “B [---]” in the display, and is indicated by the second wedge mark in the playback progress bar.  
The specified A-B section of the audio file will now play back repeatedly.
- To cancel Repeat playback, press the [C] button again.

## Repeat Playback mode via the [D] (REPEAT MODE) button

-  **Off** ..... Plays through the selected file, then stops.
-  **Single**..... Plays through the selected file repeatedly.
-  **All**..... Continues playback through all the files in the current folder repeatedly.
-  **Random** ..... Randomly and repeatedly plays back all files in the current folder.

### Adjusting the Volume Balance Between Song and Audio Playback

Pressing the [BAL.] button once or twice calls up the BALANCE (2/2) display. In this display, you can adjust the volume balance between the Song (MIDI) and Audio by using the [2 ▲▼] – [3 ▲▼] buttons. When this is set to CENTER, the levels of the Song and Audio are equal. To instantly reset the balance to CENTER, press the [2 ▲] and [3 ▲] (or [2 ▼] and [3 ▼]) buttons simultaneously.

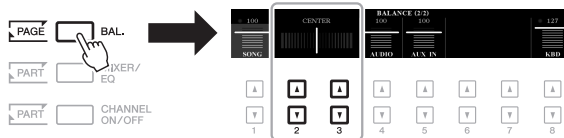

#### **NOTE**

For more information on the BALANCE displays, refer to page 57.

## Recording Your Performance as Audio

You can record your performance as an audio file (WAV format — 44.1 kHz sample rate, 16 bit resolution, stereo) directly to a USB flash drive.

### Sounds that can be recorded:

- Sounds that are generated via all the keyboard parts (LEFT, RIGHT 1, 2), Song parts, Style parts, and Multi Pad parts.
- Sounds of a portable audio player that are input via the [AUX IN] jack.

### Maximum amount of recording time:

- 80 minutes per recording, though this may differ depending on the capacity of the USB flash drive.

- 1** Connect the USB flash drive to the [USB TO DEVICE] terminal.
- 2** Make the necessary settings such as Voice/Style selection.
- 3** Press the [USB AUDIO PLAYER] button to call up the USB AUDIO PLAYER display.



#### **NOTE**

Before using a USB flash drive, be sure to read "Connecting USB Devices" on page 95.

#### **NOTE**

If you want to record various parts separately or edit the data after recording on this instrument, record as MIDI files (page 68).

#### **NOTE**

Data that cannot be recorded includes: Songs protected by copyright (such as Preset Songs) and the metronome sound.

#### **NOTE**

The USB flash drive of "USB1" is selected as the recording destination when multiple USB flash drives are connected.

#### 4 Use the [1 ▲▼] (REC) buttons to enter recording standby.

The [PLAY/PAUSE] button in the display flashes.

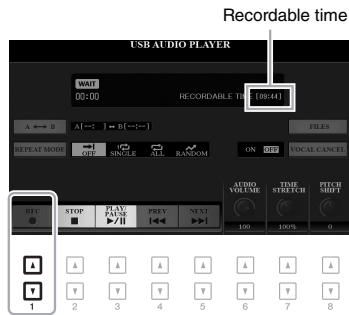

#### 5 Start recording by using the [3 ▲▼] (PLAY/PAUSE) buttons, then start your performance.

The elapsed recording time is shown in the display while recording.

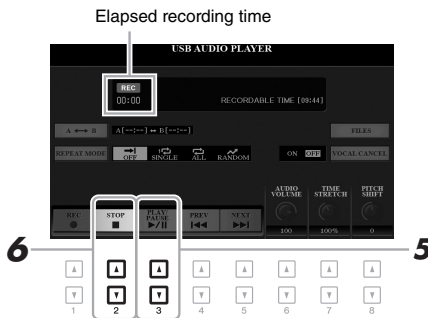

#### 6 After you finish your performance, use the [2 ▲▼] (STOP) buttons to stop recording.

Recorded data is automatically saved to the USB flash drive as a file with the name automatically set.

#### 7 Use the [3 ▲▼] (PLAY/PAUSE) buttons to play back the recorded performance.

To see the file of the recorded performance in the File Selection display, press the [H] (FILES) button.

#### NOTE

You can use the metronome (page 38) while recording; however, the metronome sound will not be recorded.

#### NOTICE

Do not attempt to disconnect the USB flash drive or turn the power off during recording. Doing so may corrupt the USB flash drive data or the recording data.

#### NOTE

The recording operation continues, even if you close the USB AUDIO PLAYER display by pushing the [EXIT] button. Press the [USB AUDIO PLAYER] button to call up the USB AUDIO PLAYER display again, then stop the recording by pressing the [2 ▲▼] (STOP) button.

#### NOTE

Keep in mind that if you make a mistake in your performance, you cannot correct it by overwriting an existing file. Delete the recorded file on the File Selection display, then record your performance again.

# Multi Pads

## – Adding Musical Phrases to Your Performance –

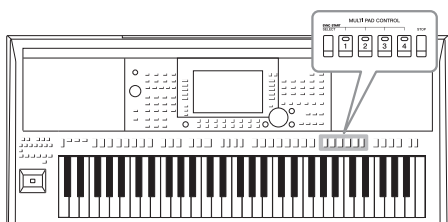

The Multi Pads can be used to play a number of short pre-recorded rhythmic and melodic sequences adding impact and variety to your keyboard performances.

Multi Pads are grouped in Banks of four each. The instrument features a variety of Multi Pad Banks in a variety of different musical genres.

Moreover, the Audio Link Multi Pad function allows you to create a new pad with your audio data (WAV files) to play back during your performance.

### Playing the Multi Pads

This section covers how to play back only Multi Pads. However, you can also play the Multi Pads during playback of a Style/Song to make your performance more interesting.

- 1 Press the **MULTI PAD CONTROL [SELECT]** button to call up the Multi Pad Bank Selection display.

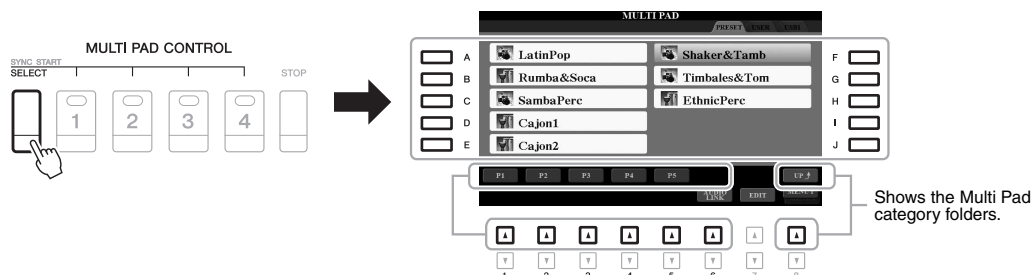

- 2 Press one of the **[A] – [J]** buttons to select the desired bank.

You can call up the other pages by pressing the buttons that correspond to the page numbers (P1, P2 ...) or pressing the **MULTI PAD CONTROL [SELECT]** button repeatedly.

Press the **[8 ▲] (UP)** button to call up the next higher level folder to which the Multi Pads are categorized.

- 3 Press any of the **MULTI PAD CONTROL [1] – [4]** buttons to play a Multi Pad phrase.

The corresponding phrase for the button starts playing back in its entirety at the currently set tempo. You can play up to four Multi Pads at the same time.

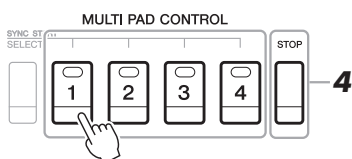

#### NOTE

There are two types of Multi Pad data. Some types will play back once and stop when they reach to the end. Others will be played back repeatedly (loop).

#### NOTE

Pressing the pad during its playback will stop playing and begin playing from the top again.

## 4 Press the [STOP] button to stop playback of the Multi Pad(s).

If you want to stop specific pads, simultaneously hold down the [STOP] button and press the pad(s) you wish to stop.

### About the lamp status of the MULTI PAD CONTROL [1] – [4] buttons

- **Green:** Indicates that the corresponding pad contains data (phrase).
- **Red:** Indicates that the corresponding pad is playing back.
- **Red (flashing):** Indicates that the corresponding pad is in standby (Synchro Start; see below).
- **Off:** Indicates the corresponding pad contains no data and cannot be played.

### NOTE

- While the Style or Song is playing back, pressing the Multi Pad button starts playback at the top of the next measure. When the Style or Song is stopped, pressing the Multi Pad button starts playback immediately.
- While the Style or Song is playing back, pressing the STYLE CONTROL [START/STOP] or SONG [■] (STOP) button also stops playback of the Multi Pad(s). While both the Style and Song is playing back, pressing the SONG [■] (STOP) button stops playback of the Song, Style and Multi Pad(s).

## Using Chord Match

When the [ACMP] or LEFT part is on, Multi Pad phrases automatically change the pitch to match the chord you play in the chord section.

Play the chord in the chord section before/after pressing any of the Multi Pads.

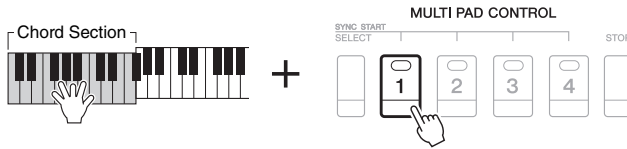

### NOTE

- Some Multi Pads are not affected by Chord Match.
- The Multi Pads categorized in the "DJ Phrase" folder are specially created for DJ Styles (page 50), and only the root key can be changed.

## Using the Multi Pad Synchro Start Function

You can start Multi Pad playback by playing the keyboard or by starting Style playback.

### 1 While holding the MULTI PAD CONTROL [SELECT] button, press the desired button or buttons from [1] – [4].

The corresponding buttons flash in red, indicating the standby status.

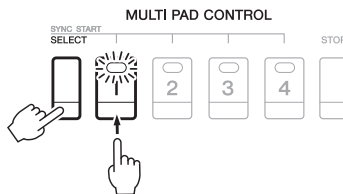

### NOTE

To cancel the standby status of the selected Pad, carry out the same operation, or simply press the [STOP] button to cancel the status of all Pads.

### 2 Start playback of the Multi Pad.

- When [ACMP] is off, press any note, or play back a Style.
- When [ACMP] is on, play a chord in the chord section, or play back a Style.

If you put a Multi Pad in standby during Style or Song playback, pressing any note (when [ACMP] is off) or playing a chord in the chord section (when [ACMP] is on) will start Multi Pad playback at the top of the next measure.

### NOTE

When two or more Multi Pads are in the standby status, pressing any one of them starts simultaneous playback of all of them.

## Creating a Multi Pad with Audio files (Audio Link Multi Pad)

You can create a new Multi Pad by making links with audio files (WAV format: 44.1 kHz sample rate, 16 bit resolution, stereo) in the USB flash drive to each of the Multi Pad. The audio files (WAV) can be data you've recorded on this instrument (page 74) as well as commercially available ones. Multi Pads to which audio files have been linked are called Audio Link Multi Pads. The new Audio Link Multi Pads can be saved to the USER drive or USB flash drive.

### NOTE

Audio Link Multi Pads can neither be created nor played back during playback, recording standby or recording of audio files.

**1** Connect the USB flash drive containing the audio files (WAV) to the [USB TO DEVICE] terminal.

### NOTE

Before using a USB flash drive, be sure to read "Connecting USB Devices" on page 95.

**2** Press the MULTI PAD CONTROL [SELECT] button to call up the Multi Pad Bank Selection display.

**3** Press the [6 ▼] (AUDIO LINK) button to call up the AUDIO LINK MULTI PAD display.

A confirmation message may appear here. If so, follow the on-display instructions.

### NOTE

Make sure that MENU 1 is shown at the bottom right corner of the display (page 26).

### NOTE

An audio file cannot be linked to a MIDI Multi Pad.

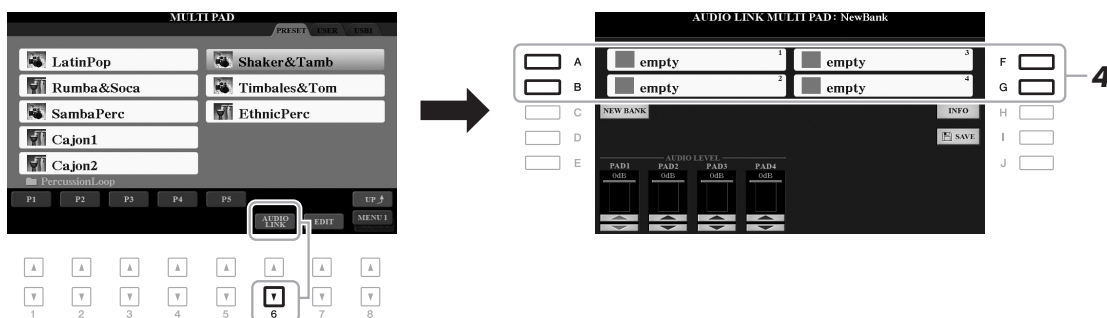

**4** Select the desired Pad by pressing any of the [A], [B], [F] and [G] buttons.

The WAVE File Selection display appears.

### NOTE

If an Audio Link Multi Pad has been selected when you press the [6 ▼] (AUDIO LINK) button in step 3, the links made for the selected Pad appear. In order to create a new Pad, make sure to press the [C] (NEW BANK) button. Otherwise, you are simply re-selecting the link in the selected Pad.

**5** Select the desired audio file by using the [A] – [J] buttons.

#### To confirm the information of the selected audio file

By pressing the [6 ▼] (INFO) button in the WAVE File Selection display, you can confirm the information (title name, bit rate and sample rate, etc.). Press the [F] (OK) button to close it.

**6** Press the [EXIT] button to return to the AUDIO LINK MULTI PAD display.

#### To confirm the path of the selected audio file

By pressing the [H] (INFO) button in the AUDIO LINK MULTI PAD display, you can confirm the path. Press the [F] (OK) button to close it.

**7** If you want to link other audio files to other pads, repeat steps 4 to 6.

**8** If desired, adjust the volume of each audio file by using the [1 ▲▼] – [4 ▲▼] buttons.

By pressing the desired MULTI PAD CONTROL [1] – [4] button, you can adjust the volume while playing the Multi Pad phrase.

**9** Save the settings as a Multi Pad Bank.

**9-1** Press the [I] (SAVE) button in the AUDIO LINK MULTI PAD display to call up the Multi Pad Bank Selection display.

**9-2** Save the settings as a bank file by following the instructions on page 28.

**NOTICE**

The setting will be lost if you select another Audio Link Multi Pad or turn the power to the instrument off without carrying out the Save operation.

**10** Press the [EXIT] button to check the new Audio Link Multi Pad in the Multi Pad Bank Selection display.

The newly created Audio Link Multi Pad is marked with “Audio Link” at the upper left of the file name.

**If you want to change the Link setting:**

Select the desired Audio Link Multi Pad, then carry out the same operations as in steps 3 to 10.

## Playing the Audio Link Multi Pads

You can play the Multi Pad to which the audio file is assigned by selecting them in the USER or USB tab of the Multi Pad Bank Selection display. Although you can play them via the same operations in page 76, note the following limitations.

- Make sure to connect the USB flash drive including the corresponding audio files (WAV).
- Automatic repeat playback is not available.
- Only one Pad can be played back at once.
- Chord Match cannot be applied.

**NOTE**

Audio files (WAV) take a slightly longer time than MIDI files to load.

### Advanced Features

Refer to the Advanced Features section in this manual, **Chapter 5**.



**Creating Multi Pads (Multi Pad Creator):**

[FUNCTION] → TAB [▶] MENU 2 → [C] MULTI PAD CREATOR

**Editing Multi Pads:**

Multi Pad Bank Selection display → [7 ▼] (EDIT)

# Music Finder

– Calling Up Ideal Panel Setups for Your Performance –

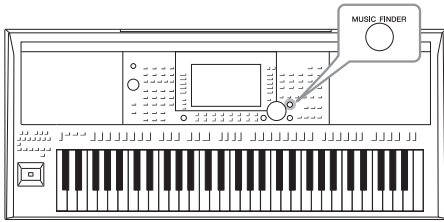

This feature helps you call up the panel settings ideal for the music you want to play simply by selecting a Music Finder “Record,” which includes Voice and Style settings. If you want to play a certain piece of music but don’t know which Style and Voice settings would be appropriate, you can search for relevant Records by the title of the piece.

Moreover, by registering the Song, audio and Style file saved in various locations into Music Finder, you can easily call up the desired file from the corresponding Record.

## Selecting the Desired Record (Panel Settings)

### 1 Press the [MUSIC FINDER] button to call up the MUSIC FINDER display.

As necessary, select the tab by using the TAB [◀][▶] buttons.

- **ALL**.....All Music Finder Records
- **FAVORITE**.....Favorite Records you’ve added (for details, refer to page 172)
- **SEARCH 1, 2**.....Search result (page 81)

Each entry is called a “Record.” This shows the song titles (MUSIC) and information of the Styles included.

MUSIC	STYLE	BEAT	TEMPO
Alr On The G String	Chillout	4/4	68
Alr On The G String	ClassiPianoIld	4/4	68
Amazola	60sGuitarPop	4/4	138
An Der Schonen Elisen Donau	ViennewWaltz	3/4	174
Beautiful Dreamer	GuitarSwonade	3/4	104
Beauty And The Beast	(SONG)		
Classi	Chillout	4/4	74
Danny Boop	ClassiPianoIld	4/4	66
Donauwallerl (Danube Waves)	ViennewWaltz	3/4	186
Easy Winners	Ragtime	4/4	176
El Condor Pasa	GuitarRumba	4/4	166
Elvira Madigan	6-8orchestral	6/8	62
Empress Waltz (Kaiser Waltzer)	ViennewWaltz	3/4	178

### 2 Use the [2 ▲▼]/[3 ▲▼] buttons to select the desired Record.

You can also use the Data dial and the [ENTER] button.

The panel settings in the Record are called up. When the Record including the Style name is selected, the [ACMP] and [SYNC START] buttons are turned on and the corresponding Style is called up. This lets you start Style playback immediately.

#### Sorting the Records

Press the [F] (SORT BY) button repeatedly if necessary to change how the Records are sorted: by MUSIC (music piece), STYLE, BEAT or TEMPO. Press the [G] (SORT ORDER) button to alternate the order, ascending or descending.

When sorting the Records by MUSIC, you can use the [1 ▲▼] button to skip up or down through the Song names alphabetically. When sorting the Records by STYLE, you can use the [4 ▲▼]/[5 ▲▼] button to skip up or down through the Style names alphabetically. Simultaneously press the [▲] and [▼] buttons to move the cursor to the first Record.



### 3 Start playback of the Style by specifying the chords in the chord section.

**To avoid changing the tempo during Style playback when selecting another Record**  
 Press the [I] (STYLE TEMPO) button to set the “STYLE TEMPO” to “HOLD” or “LOCK.” When set to “LOCK,” the tempo will be locked while stopping as well as playing. If you want to reset the tempo every time you select another Record, set to “RESET.”

## Searching for Records (Panel Settings)

You can search the Records by specifying a song title or keyword, using the Search function of the Music Finder.

### 1 In the MUSIC FINDER display, press the [6 ▲] (SEARCH 1) button to call up the MUSIC FINDER SEARCH 1 display.

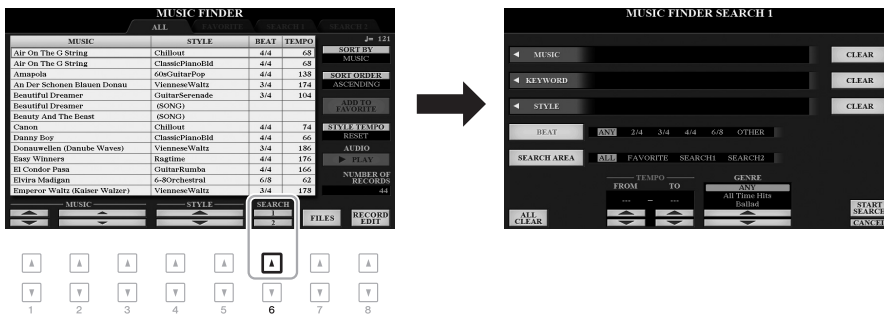

### 2 Enter the search criteria.

[A]	MUSIC	Calls up the Character Entry window (page 32) to enter the song title. To clear the entered title, press the corresponding [F] (CLEAR) button.
[B]	KEYWORD	Calls up the Character Entry window (page 32) to enter the keyword. To clear the entered keyword, press the corresponding [G] (CLEAR) button.
[C]	STYLE	Calls up the Style Selection display (page 49). After selecting the Style by the [A] – [J] buttons, press the [EXIT] button to return to the SEARCH 1 display. To clear the entered Style name, press the corresponding [H] (CLEAR) button.
[D]	BEAT	Specifies the time signature for the search. All beat settings are included in the search if you select ANY.
[E]	SEARCH AREA	Selects a specific location (the tab of the upper part of the MUSIC FINDER display) for searching.
[1 ▲▼]	ALL CLEAR	Clears all entered search criteria.
[3 ▲▼]	TEMPO FROM	Sets the range of the tempo you want to use for the search.
[4 ▲▼]	TEMPO TO	
[5 ▲▼]/ [6 ▲▼]	GENRE	Selects the desired music genre.

#### NOTE

If you want to input two or more keywords, insert a comma between each word.

#### NOTE

If you select a beat of 2/4 or 6/8, a Style suitable for performing a song in 2/4 and 6/8 beat can be searched, but the actual Style is created by using a 4/4 beat.

#### NOTE

To cancel searching, press the [8 ▼] (CANCEL) button.

- 3** Press the [8 ▲] (START SEARCH) button to start the search.  
After the Search is completed, the resulting Records appear in the SEARCH 1 tab of the MUSIC FINDER display. If no Records are listed, try steps 1 – 3 again with another song title or keyword.
- 4** Use the [2 ▲▼]/[3 ▲▼] buttons to select the desired Record.
- 5** Start playback of the Style by specifying the chords in the chord section.

**NOTE**

If you want to maintain the current search results and start another search, use the [6 ▼] (SEARCH 2) button in step 1. (The current search Records will remain in the SEARCH 1 tab.)

## Downloading Records (Panel Settings) from the Website

As a factory default, some sample Records are provided in the Music Finder. To use the Music Finder function more conveniently and effectively, we recommend that you download the Records from the Yamaha website, and load them to this instrument.

- 1** On the computer, access the following website and download the Music Finder file (\*\*\*.mfd) to the USB flash drive connected to a computer.  
<http://download.yamaha.com/>
- 2** Connect the USB flash drive which contains the Music Finder file (\*\*\*.mfd) to the [USB TO DEVICE] terminal of the instrument.
- 3** Press the [MUSIC FINDER] button to call up the MUSIC FINDER display.

**NOTE**

Before using a USB flash drive, be sure to read "Connecting USB Devices" on page 95.

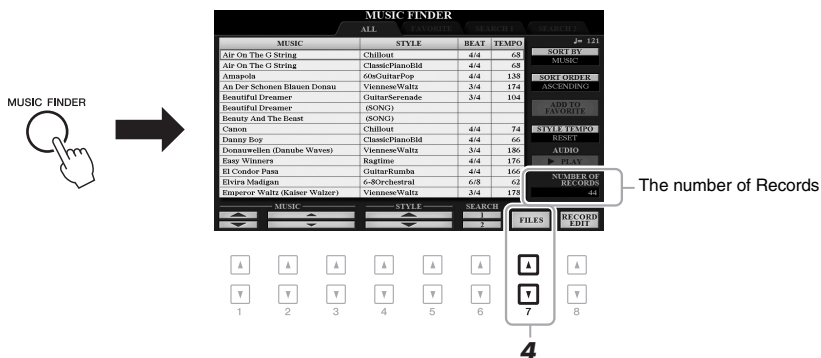

- 4** Use the [7 ▲▼] (FILES) buttons to call up the File Selection display.
- 5** Select the Music Finder file in the USB flash drive by pressing the [A] – [J] buttons to call up a message prompting you to select REPLACE or APPEND.
- 6** Press the [H] (APPEND) button if you want to add Records of the selected Music Finder file, or press the [G] (REPLACE) button if you want to replace all Records with the new ones.

## 7 When confirmation messages appear, follow the on-display instructions.

You can confirm the Records that have been appended by checking the number of Records in the right lower corner of the display.

### NOTE

Even after appending or replacing the Music Finder Records, you can reset them to their original factory settings by selecting the "MusicFinderPreset" file in PRESET tab of step 5.

## Registering a Song, Audio or Style File to a Record

By registering Song, audio or Style files in various locations (PRESET, USER and USB) into Music Finder, you can easily call up your favorite files.

### 1 In the Song, Audio or Style Selection display, select the desired file.

For instructions on Songs, refer to page 62; for audio, page 71; and for Styles, page 49.

### NOTE

- If you want to register files in the USB flash drive, connect the USB flash drive containing the data to the [USB TO DEVICE] terminal.
- Before using a USB flash drive, be sure to read "Connecting USB Devices" on page 95.



### 2 Press the [5 ▼] (ADD TO MF) button to call up the MUSIC FINDER RECORD EDIT display.

### NOTE

Make sure that MENU 1 is shown at the bottom right corner of the display (page 26).

### 3 Press the [8 ▲] (OK) button to register the file.

### NOTE

For details on the MUSIC FINDER RECORD EDIT display, refer to page 173.

### 4 Check that the registered Record is shown in the MUSIC FINDER display.

In the STYLE column of the Record, the Song is registered as "(SONG)," the audio file as "(AUDIO)" and the Style is registered according to its Style name.

### NOTE

To cancel the operation, press the [8 ▼] (CANCEL) button.

## Calling up the Song, Audio or Style registered to Music Finder

You can call up the registered Song, Audio or Style in the same way as done in the sections “Selecting the Desired Record” (page 80) and “Searching for Records” (page 81).

The selected file can be played back as follows.

- **Song:** Press the SONG [▶/||] (PLAY/PAUSE) button or play the keyboard. To stop playback, press the SONG [■] (STOP) button.
- **Audio:** Press the [J] (▶ PLAY) button in the MUSIC FINDER display. To stop playback, press the [J] (■ STOP) button.
- **Style:** Specify the chords with your left hand and play the melody with your right hand. To stop playback, press the STYLE CONTROL [START/STOP] button.

### NOTE

If you want to play back a Song, audio or Style file in the USB flash drive that has been registered as a Record, make sure to connect the same USB flash drive to the [USB TO DEVICE] terminal.

### NOTE

When searching for Songs or audio files (page 81), it is necessary to set the search criteria as follows.

STYLE: Blank  
BEAT: ANY  
TEMPO: “---” - “---”

### Advanced Features

Refer to the Advanced Features section in this manual, **Chapter 6**.



#### Creating a set of favorite Records:

[MUSIC FINDER] → TAB [◀|▶] ALL, SEARCH 1 or SEARCH 2 → [H] ADD TO FAVORITE

#### Editing Records:

[MUSIC FINDER] → [8 ▲▼] (RECORD EDIT)

#### Saving the Record as a single file:

[MUSIC FINDER] → [7 ▲▼] (FILES)

# Registration Memory

– Saving and Recalling Custom Panel Setups –

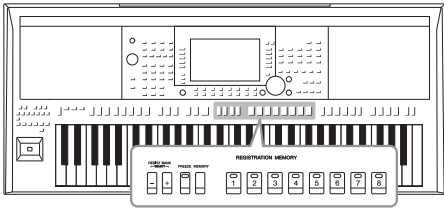

The Registration Memory function allows you to save (or “register”) virtually all panel settings to a Registration Memory button, and then instantly recall your custom panel settings by simply pressing a single button. The registered settings for eight Registration Memory buttons are saved as a single Bank (file).

## Registering Your Panel Setups

### 1 Make the desired panel settings, such as those for Voices, Styles and Effects.

For information on the panel settings that can be registered with the Registration Memory function, refer to the Registration section of the “Parameter Chart” in the Data List on the website.

### 2 Press the [MEMORY] button in the REGISTRATION MEMORY section.

The display for selecting the groups to be registered appears.

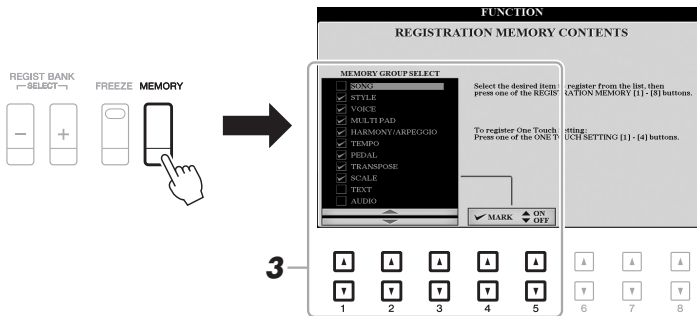

### 3 Determine the groups you want to register.

Select the desired item by using the [1 ▲▼] – [3 ▲▼] buttons, then enter or remove the checkmark by using the [4 ▲]/[5 ▲] (MARK ON)/[4 ▼]/[5 ▼] (MARK OFF) buttons.

#### NOTE

You can also use the Data dial to select items, and the [ENTER] button to enter or remove checkmarks.

- 4** Press one of the REGISTRATION MEMORY [1] – [8] buttons to which you wish to memorize the panel setup.

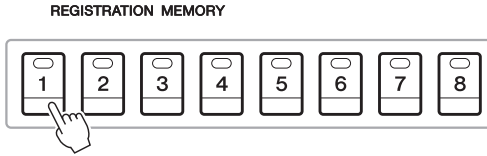

The memorized button becomes red, which indicates the number button contains data and its number is selected.

**About the lamp status**

- **Red:** Data registered and currently selected
- **Green:** Data registered but not currently selected
- **Off:** No data registered

- 5** Register various panel setups to other buttons by repeating steps 1 – 4.

The registered panel setups can be recalled by simply pressing the desired number button.

**NOTICE**

If you select the button whose lamp is lit in red or green here, the panel setup previously memorized to the button will be erased and replaced by the new settings.

**NOTE**

The panel setups registered in the numbered buttons are maintained even when you turn off the power. If you want to delete all the eight current panel setups, turn the power on while holding the B5 key (right-most B key on the keyboard).

## Saving the Registration Memory as a Bank file

You can save all eight registered panel setups as a single Registration Memory Bank file.

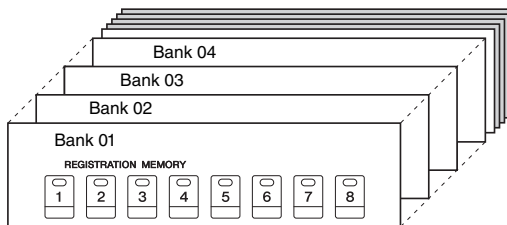

- 1** Press the REGIST BANK [+/-] and [-] buttons simultaneously to call up the Registration Bank Selection Display.

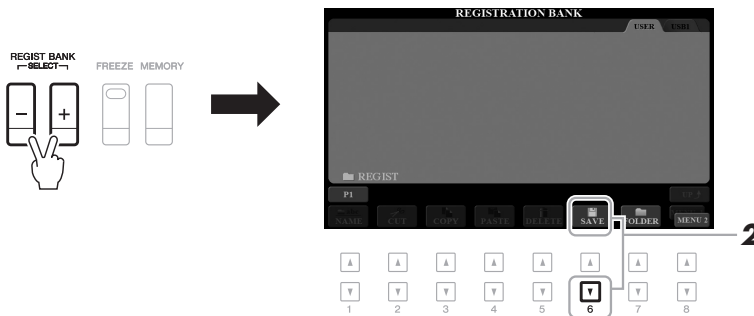

- 2** Press the [6 ▼] (SAVE) button to save the Bank file.

For instructions on saving, refer to page 28.

**NOTE**

Make sure that MENU 2 is shown at the bottom right corner of the display (page 26).

## Recalling a Registered Panel Setup

The saved Registration Memory Bank files can be recalled by using the REGIST BANK [-]/[+] buttons or the following procedure.

**1 Press the REGIST BANK [+] and [-] buttons simultaneously to call up the REGISTRATION BANK Selection display.**

**2 Press one of the [A] – [J] buttons to select a Bank.**

You can also use the REGIST BANK [-]/[+] buttons, or the Data dial and the [ENTER] button to select a Bank.

### Confirming the Registration Memory Information

In the REGISTRATION BANK Selection display, press the [6 ▼] (INFO) button to call up the Information window, showing which Voices and Style are memorized to the [1] – [8] buttons of a Registration Memory Bank.

#### NOTE

Make sure that MENU 1 is shown at the bottom right corner of the display (page 26).

#### NOTE

If a Voice name is shown in gray, this indicates that the corresponding Voice part is turned off when pressing the REGISTRATION MEMORY [1] – [8] buttons.

To close the window, press the [F] (CLOSE) button.

**3 Press one of the green-lit numbered buttons ([1] – [8]) in the Registration Memory section.**

#### NOTE

- When recalling the setups including file selection of Song, Style, text, etc. from a USB flash drive, make sure that the appropriate USB flash drive including the registered Song/Style is connected into the [USB TO DEVICE] terminal.
- Before using a USB flash drive, be sure to read "Connecting USB Devices" on page 95.

#### NOTE

Turning the [FREEZE] button on lets you disable recall of specific item(s) as desired. For instructions, refer to page 177.

### Advanced Features

Refer to the Advanced Features section in this manual, **Chapter 7**.



#### Disabling recall of specific items (Freeze):

[FUNCTION] → TAB [◀] MENU 1 → [C] REGIST SEQUENCE/FREEZE → TAB [▶] FREEZE

#### Calling up Registration Memory numbers in order (Registration Sequence):

[FUNCTION] → TAB [◀] MENU 1 → [C] REGIST SEQUENCE/FREEZE → TAB [◀] REGISTRATION SEQUENCE

# Oriental Scales

## – Setting Original Scales –

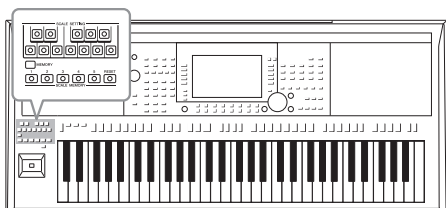

The Oriental Scales feature lets you simply and easily change the pitches of specific notes and create your own scales. You can call up the scale settings at any time—even when you are playing.

## Setting Oriental Scales

### Setting a Scale

The SCALE SETTING buttons let you easily lower the pitches of specific notes by 50 cents to create your own oriental scales. These buttons simulate a one-octave keyboard (C through B). Press the button corresponding to the key whose pitch you want to lower (the button lights). Press again to return to normal pitch (0 cent). The setting affects all notes with the same note name over all octaves.

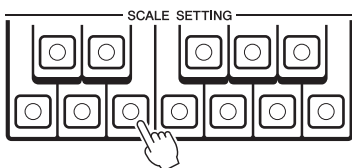

You can also use convenient scale templates (including oriental scales) and create your own scales by fine tuning the scale notes. The operation display can be called up via [FUNCTION] → TAB [◀] MENU 1 → [E] MASTER TUNE/SCALE TUNE → TAB [▶] SCALE TUNE. For details, refer to the Advanced Features section (page 108).

#### NOTE

In musical terms a "cent" is 1/100<sup>th</sup> of a semitone. (100 cents equal one semitone.)

#### NOTE

Since the scale is set to Equal Temperament with a base note of C by default, you should set the pitch for each key regarding C as the root.

#### NOTE

The Scale Setting function has no effect on some Voices such as the Drum Kit/SFX Kit Voices.

#### NOTE

The SCALE TUNE display can also be called up by pressing the [B] or [C] button on the Main display.

### Memorizing the Scale Settings

The settings you make (using the SCALE SETTING buttons or in the SCALE TUNE display) can be memorized to the SCALE MEMORY buttons for instant recall.

#### 1 Set up the scale settings as desired, using the SCALE SETTING buttons or the parameters in the SCALE TUNE display.

For instructions on the SCALE TUNE display, refer to the Advanced Features section (page 108).



- While holding the **SCALE MEMORY [MEMORY]** button, press one of the **SCALE MEMORY [1] – [5]** buttons (the desired one for memorizing the scale settings).

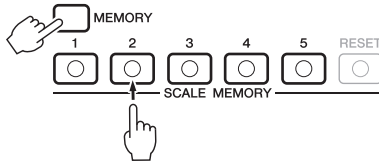

The corresponding **SCALE MEMORY** button lights. Any data that was previously in the selected location is erased and replaced by the new settings.

#### About the lamp status of the [1] – [5] buttons

- **On:** Data registered and currently selected
- **Off:** No data registered, or not currently selected

#### NOTE

The [RESET] button lights up when all notes are of normal pitch.

- Memorize scale settings to other buttons by repeating steps 1 and 2.

The memorized settings can be recalled by simply pressing the desired number button.

#### Instantly resetting the Scale Settings

Pressing the **SCALE MEMORY [RESET]** button can reset all notes to normal pitch (0 cent). This operation does not erase the settings memorized to the [1] – [5] buttons.

#### NOTE

The scale settings memorized to the numbered button will be lost if you turn the power to the instrument off without carrying out the Save operation (see below).

## Saving the Scale Memory as a Bank File

The scale settings memorized to the **SCALE MEMORY [1] – [5]** buttons can be saved as a single Scale Tune Bank file.

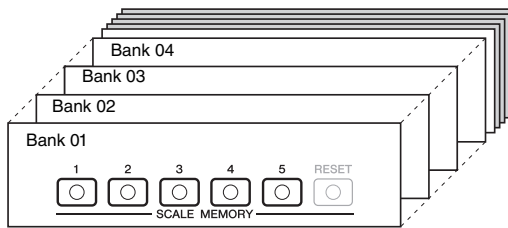

- Press the **[DIRECT ACCESS]** button, followed by the **[EXIT]** button to call up the Main display.

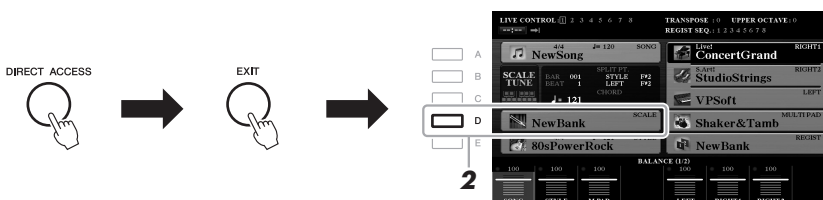

- 2 Press the [D] button to call up the Scale Tune Bank Selection display.
- 3 Press the [6 ▼] (SAVE) button to save the Bank file.  
For instructions on saving, refer to page 28.

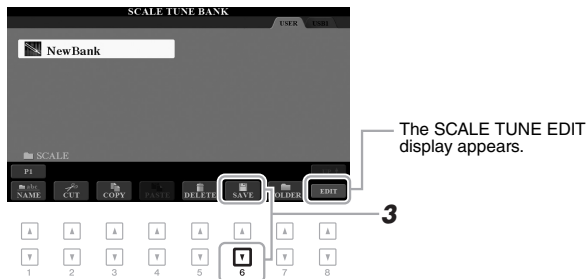

### SCALE TUNE EDIT display

The contents of the current Scale Tune Bank are listed in the SCALE TUNE EDIT display. The names of the Scale Settings memorized to the SCALE MEMORY [1] – [5] buttons are shown in the display. You can rename or delete each of the Scale Settings. For instructions on the rename or delete operations, refer to pages 30 – 32.

## Recalling a Memorized Scale Setting

The memorized scale settings can be recalled by selecting the Scale Tune Bank file as described below.

- 1 Press the [DIRECT ACCESS] button, followed by the [EXIT] button, to call up the Main display.
- 2 Press the [D] button to call up the Scale Tune Bank Selection display.
- 3 Press one of the [A] – [J] buttons to select a Bank.
- 4 Press one of the SCALE MEMORY [1] – [5] buttons to select a specific memory location.

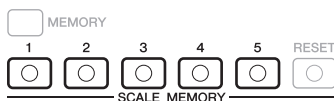

# Mixing Console

– Editing the Volume and Tonal Balance –

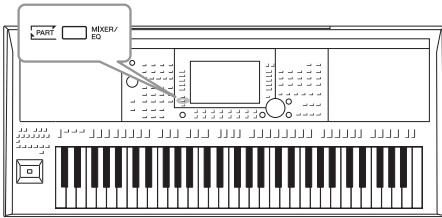

The Mixing Console gives you intuitive control over aspects of the keyboard parts and Style/Song channels, including volume balance and the timbre of the sounds. It lets you adjust the levels and stereo position (pan) of each Voice to set the optimum balance and stereo image, and lets you set how the effects are applied.

## Basic Procedure

- 1 Press the [MIXER/EQ] button to call up the MIXING CONSOLE display.



- 2 Press the [MIXER/EQ] button repeatedly to call up the MIXING CONSOLE display for the relevant parts.

The part category (Panel, Style, Song) is indicated at the top of the display.

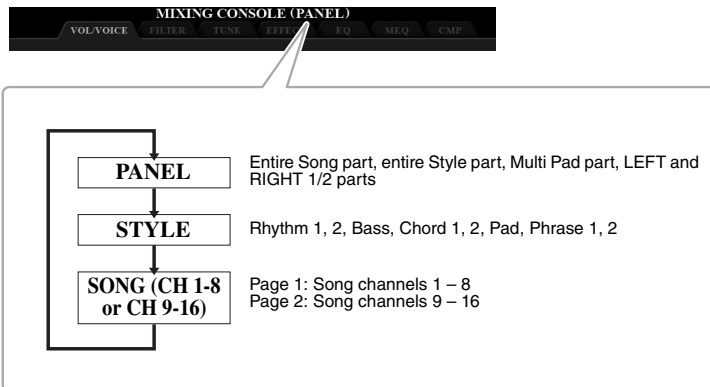

**NOTE**

You can switch between the pages of SONG by pressing the [A] (PART) button.

### 3 Use the TAB [◀][▶] buttons to call up the desired page.

For details about each page, refer to the Advanced Features section (page 181).

- **VOL/VOICE**.....Changes the Voice for each part and adjusts panning and volume for each part.
- **FILTER**.....Adjusts the Harmonic Content (resonance) and sound brightness.
- **TUNE** .....Pitch-related settings (tuning, transpose, etc.).
- **EFFECT**.....Selects the effect type and adjusts the depth for each part.
- **EQ** .....Boosts/cuts the high band or low band for each part to correct the tone or timbre of the sound.
- **MEQ** .....Selects the master equalizer type applied to the entire sound and edit the related parameters.
- **CMP** .....This is the Master Compressor setting which determines the dynamics of the overall sound.

#### **NOTE**

The MEQ and CMP settings are not applied to audio playback or the metronome sound.

### 4 Use the [A] – [J] buttons to select a parameter, then use the [1 ▲▼] – [8 ▲▼] buttons to set the value for each part.

### 5 Save your Mixing Console settings.

- **To save the PANEL display settings:**  
Register them to Registration Memory (page 85).
- **To save the STYLE display settings:**  
Save them as Style data. If you want to recall the settings for future use, select the Style file saved here.
  1. Call up the operation display.  
[FUNCTION] → TAB [▶] MENU 2 → [A] STYLE CREATOR
  2. Press the [EXIT] button to close the RECORD display.
  3. Press the [I] (SAVE) button to call up the Style Selection display, then save it (page 28).
- **To save the SONG display settings:**  
First register the edited settings as part of the Song data, then save the Song. If you want to recall the settings for future use, select the Song file saved here.
  1. Call up the operation display.  
[FUNCTION] → TAB [▶] MENU 2 → [B] SONG CREATOR
  2. Use the TAB [◀][▶] buttons to select the SETUP tab.
  3. Use the [8 ▲▼] (APPLY) buttons to actually apply the settings.
  4. Press the [I] (SAVE) button to call up the Song Selection display, then save it (page 28).

#### **NOTE**

You can instantly set the same value for the parameter to all of the parts, if you simultaneously hold down one of the [A] – [J] buttons and use the [1 ▲▼] – [8 ▲▼] buttons (or the Data dial).

## Advanced Features

Refer to the Advanced Features section in this manual, **Chapter 9**.



This chapter covers the connectors of this instrument. To see where the connectors are located on the instrument, refer to pages 14 – 15.

### **CAUTION**

Before connecting the instrument to other electronic components, turn off the power of all the components. Also, before turning any components on or off, make sure to set all volume levels to minimum (0). Otherwise, damage to the components, electrical shock, or even permanent hearing loss may occur.

## Connecting a Footswitch/Foot Controller (FOOT PEDAL jacks)

The FC4/FC4A or FC5 footswitches and the FC7 foot controller (sold separately) can be connected to one of the FOOT PEDAL jacks. A footswitch can be used for switching functions on and off, while a foot controller controls continuous parameters such as volume.

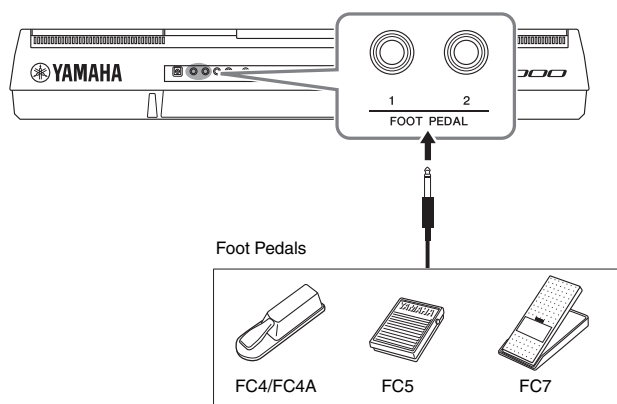

### **NOTE**

Do not connect or disconnect the pedal when the power is on.

By default, each jack features the following function. Use the FC4/FC4A or FC5 footswitch.

- **FOOT PEDAL [1]** ..... Switches sustain on or off.
- **FOOT PEDAL [2]** ..... Controls the Super Articulation Voices (page 38).

You can also change the function assignments to the pedals as desired.

### • Example: Controlling Song Start/Stop by footswitch

Connect a footswitch (FC4/FC4A or FC5) to one of the FOOT PEDAL jacks.

To assign the function to the connected pedal, select “SONG PLAY/PAUSE” in the operation display: [FUNCTION] → TAB [◀] MENU 1 → [D] CONTROLLER → TAB [◀] FOOT PEDAL.

### **NOTE**

For details on functions that can be assigned to the pedals, refer to page 192.

### Advanced Features

Refer to the Advanced Features section in this manual, **Chapter 10**.



**Assigning specific functions to each foot pedal:**

[FUNCTION] → TAB [◀] MENU 1 → [D] CONTROLLER → TAB [◀] FOOT PEDAL

## Connecting Audio Devices (OUTPUT [L/L+R]/[R] jacks, [AUX IN] jack)

### Using an External Stereo System for Playback

You can connect a stereo system to amplify the instrument's sound by using the OUTPUT [L/L+R]/[R] jacks.

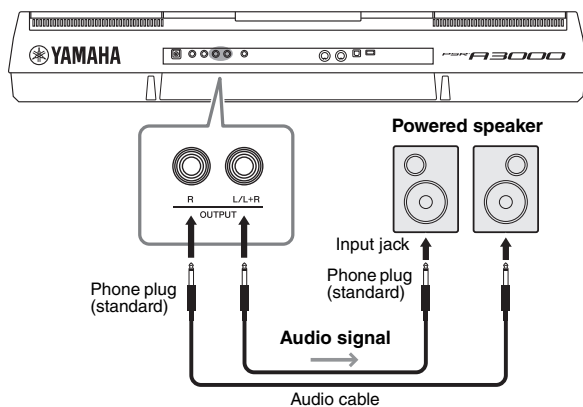

You can use the instrument's [MASTER VOLUME] dial to adjust the volume of the sound output to the external device.

#### NOTE

Use audio cables and adaptor plugs having no (zero) resistance.

#### NOTE

Use only the [L/L+R] jack for connection with a monaural device.

#### NOTICE

To avoid possible damage, first turn on the power to the instrument, then to the external device. When turning off the power, first turn off the power to the external device, then to the instrument. Since this instrument's power may automatically be turned off due to the Auto Power Off function (page 17), turn off the power to the external device, or disable Auto Power Off when you do not intend to operate the instrument.

#### NOTICE

Do not route the output from the OUTPUT jacks to the [AUX IN] jack. If you make this connection, the signal input at the [AUX IN] jack is output from the [OUTPUT] jacks and then back again, creating a feedback loop that could make normal performance impossible, and may even damage the equipment.

### Playing a Portable Audio Player with the Built-in Speakers

You can connect the headphone jack of a portable audio player to the instrument's [AUX IN] jack, letting you hear the sound of that portable audio player through the built-in speakers of the instrument.

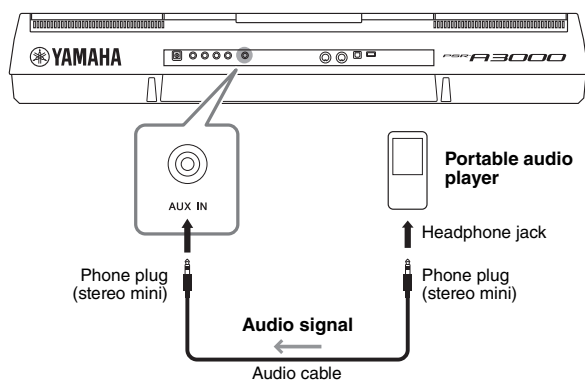

The input signal from the [AUX IN] jack is affected by the setting of the instrument's [MASTER VOLUME] dial, and the volume balance with other sounds played on the keyboard can be adjusted from the BALANCE display (page 57).

#### NOTICE

To avoid damage to the devices, first turn on the power to the external device, then to the instrument. When turning off the power, first turn off the power to the instrument, then to the external device.

## Connecting USB Devices ([USB TO DEVICE] terminal)

You can connect a USB flash drive or a USB wireless LAN adaptor (sold separately) to the [USB TO DEVICE] terminal. This lets you save data you've created on the instrument to the USB flash drive (page 28). You can also connect the instrument to a smart device such as iPad via wireless LAN (page 97).

### Precautions when using the [USB TO DEVICE] terminal

This instrument features a built-in [USB TO DEVICE] terminal. When connecting a USB device to the terminal, be sure to handle the USB device with care. Follow the important precautions below.

#### NOTE

For more information about the handling of USB devices, refer to the owner's manual of the USB device.

### Compatible USB devices

- USB flash drive
- USB hub
- USB wireless LAN adaptor (UD-WL01; may not be available depending on your area)

Other USB devices such as a computer keyboard or mouse cannot be used.

The instrument does not necessarily support all commercially available USB devices. Yamaha cannot guarantee operation of USB devices that you purchase. Before purchasing a USB device for use with this instrument, please visit the following web page:

<http://download.yamaha.com/>

Although USB devices 1.1 to 3.0 can be used on this instrument, the amount of time for saving to or loading from the USB device may differ depending on the type of data or the status of the instrument.

#### NOTE

The rating of the [USB TO DEVICE] terminal is a maximum of 5V/500mA. Do not connect USB devices having a rating above this, since this can cause damage to the instrument itself.

### Connecting a USB device

When connecting a USB device to the [USB TO DEVICE] terminal, make sure that the connector on the device is appropriate and that it is connected in the proper direction.

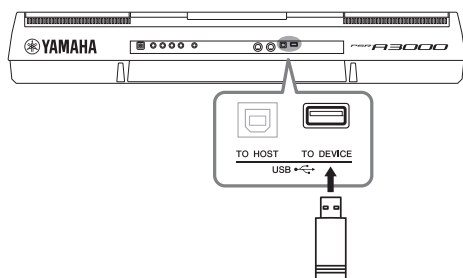

#### NOTICE

- Avoid connecting or disconnecting the USB device while executing playback/recording and file management operations (such as Save, Copy, Delete and Format), or when accessing the USB device. Failure to observe this may result in "freezing" of the operation of the instrument or corruption of the USB device and the data.
- When connecting then disconnecting the USB device (and vice versa), make sure to wait a few seconds between the two operations.

#### NOTE

- If you intend to connect two devices at the same time to a terminal, you should use a bus-powered USB hub. Only one USB hub can be used. If an error message appears while using the USB hub, disconnect the hub from the instrument, then turn on the power of the instrument and re-connect the USB hub.
- When connecting a USB cable, make sure that the length is less than 3 meters.

### Using a USB flash drive

By connecting the instrument to a USB flash drive, you can save data you've created to the connected device, as well as read data from the connected device.

### Maximum number of USB flash drives allowed

Up to two USB flash drives can be connected to the [USB TO DEVICE] terminal. (If necessary, use a USB hub. The number of USB flash devices that can be used simultaneously with musical instruments even when a USB hub is used is a maximum of two.)

### Formatting a USB flash drive

You should format the USB flash drive only with this instrument (page 96). A USB flash drive formatted on another device may not operate properly.

#### NOTICE

The format operation overwrites any previously existing data. Make sure that the USB flash drive you are formatting does not contain important data. Proceed with caution, especially when connecting multiple USB flash drives.

### To protect your data (write-protect)

To prevent important data from being inadvertently erased, apply the write-protect provided with each USB flash drive. If you are saving data to the USB flash drive, make sure to disable write-protect.

### Turning off the instrument

When turning off the instrument, make sure that the instrument is NOT accessing the USB flash drive by playback/recording or file management (such as during Save, Copy, Delete and Format operations). Failure to do so may corrupt the USB flash drive and the data.

## Formatting a USB Flash Drive

When a USB flash drive is connected, a message may appear prompting you to format the USB flash drive. If so, carry out the format operation.

**1** Connect a USB flash drive for formatting into the [USB TO DEVICE].

**2** Call up the operation display.

[FUNCTION] → TAB [◀] MENU 1 → [J] UTILITY → TAB [▶] USB

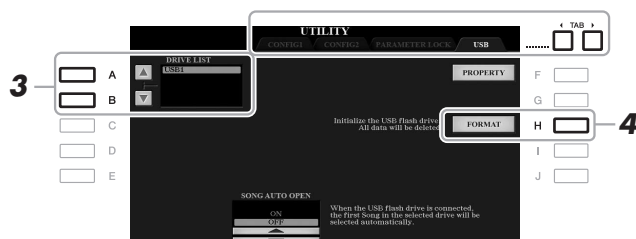

**3** Use the [A]/[B] buttons to select the drive to be formatted from the drive list.

The indications USB 1 and USB 2 will be displayed depending on the number of the connected drives.

**4** Press the [H] (FORMAT) button to format the USB flash drive.

**5** Press the [G] (YES) button to actually carry out the Format operation.

### NOTICE

The format operation deletes any previously existing data. Make sure that the USB flash drive you are formatting does not contain important data. Proceed with caution, especially when connecting multiple USB flash drives.

### NOTE

Playback of Style, Song and Multi Pads will stop when formatting is started.

### NOTE

To cancel the Format operation, press the [H] (NO) button.

### Confirming the remaining memory

You can check the remaining memory of the connected USB flash drive by pressing the [F] (PROPERTY) button.

## Selecting Files in a USB Flash Drive

By pressing the [USB] button, you can access the files which are saved in the USB flash drive.

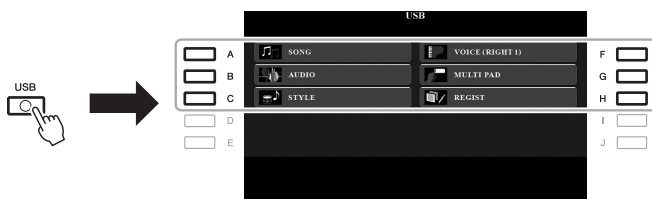

Select the desired category by using the [A] – [C] and [F] – [H] buttons, then select files by pressing one of the [A] – [J] buttons.



## Connecting to an iPhone/iPad ([USB TO DEVICE], [USB TO HOST] and MIDI terminals)

You can use a smart device, such as an iPhone or iPad, with the instrument for a variety of musical purposes by connecting it to the instrument. By using application tools on your smart device, you can take advantage of convenient functions and get more enjoyment out of this instrument.

You can make connections by one of the following methods.

- Connect to the [USB TO DEVICE] terminal via the USB wireless LAN adaptor (UD-WL01, sold separately).
- Connect to the [USB TO HOST] terminal via the USB MIDI Interface for iPhone/iPod touch/iPad (i-UX1, sold separately), etc.
- Connect to the MIDI terminals via the MIDI Interface for iPhone/iPod touch/iPad (i-MX1, sold separately).

\*These accessories may not be available depending on your area.

For details on connections, refer to the “iPhone/iPad Connection Manual” and the Advanced Features section (page 200).

For information about the compatible smart devices and application tools, access the following page:

<http://www.yamaha.com/kbdapps/>

### NOTICE

Do not place your iPhone/iPad in an unstable position. Doing so may cause the device to fall and result in damage.

### NOTE

- Before using the [USB TO DEVICE] terminal, be sure to read “Precautions when using the [USB TO DEVICE] terminal” on page 95.
- When you use the instrument along with an application on your iPhone/iPad, we recommend that you first set “Airplane Mode” to “ON” then set “Wi-Fi” to “ON” on your iPhone/iPad in order to avoid noise caused by communication.

## Connecting to a Computer ([USB TO HOST] terminal)

By connecting a computer to the [USB TO HOST] terminal, you can transfer data between the instrument and the computer via MIDI. For details on using a computer with this instrument, refer to the “Computer-related Operations” on the website.

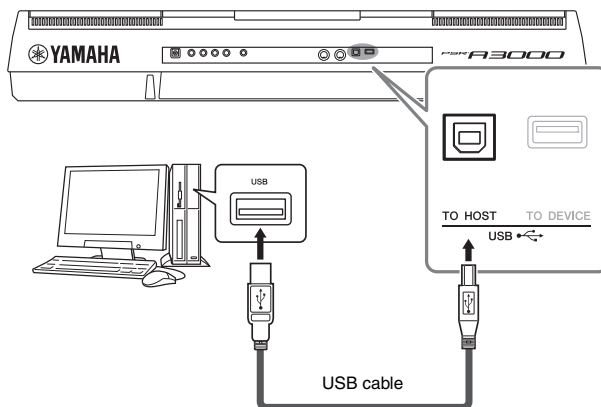

### NOTICE

Use an AB type USB cable of less than 3 meters. USB 3.0 cables cannot be used.

### NOTE

- When using a USB cable to connect the instrument to your computer, make the connection directly without passing through a USB hub.
- The instrument will begin transmission a short time after the USB connection is made.
- For information on setting up your sequence software, refer to the owner's manual of the relevant software.

## Connecting External MIDI Devices (MIDI [IN]/[OUT] terminals)

Use the MIDI [IN]/[OUT] terminals and standard MIDI cables to connect external MIDI devices (keyboard, sequencer, etc.).

- **MIDI IN** .....Receives MIDI messages from another MIDI device.
- **MIDI OUT** .....Transmits MIDI messages generated by the instrument to another MIDI device.

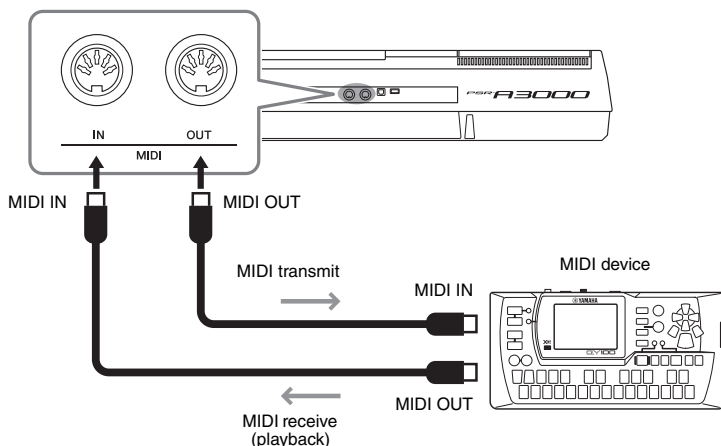

For detailed information about MIDI settings such as transmit/receive channels on the instrument, refer to the Advanced Features section (page 194).

### NOTE

For a general overview of MIDI and how you can effectively use it, refer to "MIDI Basics," which is downloadable from the website.

### Advanced Features

Refer to the Advanced Features section in this manual, **Chapter 10**.



**MIDI settings:**

[FUNCTION] → TAB [◀] MENU 1 → [I] MIDI

# Other Functions

– Making Global Settings and Using Advanced Features –

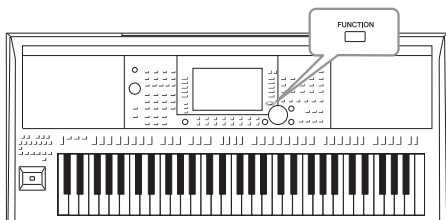

The Function menu provides a variety of convenient settings and tools for the instrument. These include general settings that affect the entire instrument, as well as detailed settings for specific functions. Also included are advanced Creator features, such as for Styles, Songs and Multi Pads.

## Basic Procedure

### 1 Call up the operation display.

[FUNCTION] → TAB [◀][▶] MENU 1/MENU 2



### 2 Press one of the [A] – [J] buttons to call up the desired function page.

For information on what you can do on each page, refer to the Function List on page 209.

### 3 Use the TAB [◀][▶] buttons to call up desired page.

### 4 Change the settings or carry out the operation.

Refer to the Function List on page 209 to see where you can find detailed information.

**Memo**

# Advanced Features

<i>Voices</i>	<b>1</b>
<i>Styles</i>	<b>2</b>
<i>Songs</i>	<b>3</b>
<i>USB Audio Player/Recorder</i>	<b>4</b>
<i>Multi Pads</i>	<b>5</b>
<i>Music Finder</i>	<b>6</b>
<i>Registration Memory</i>	<b>7</b>
<i>Oriental Scales</i>	<b>8</b>
<i>Mixing Console</i>	<b>9</b>
<i>Connections</i>	<b>10</b>
<i>Other Functions</i>	<b>11</b>

## Voice Types (Characteristics)

The particular type of Voice is indicated at the upper left of the Voice name in the Voice Selection display. The defining characteristics of these Voices and their performance advantages are described below.



S.Art! (Super Articulation)	<p>These Voices provide many benefits with great playability and expressive control in real time.</p> <p>For example, with the Saxophone Voice, if you play a C and then a D in a very legato way, you will hear the note change seamlessly, as though a saxophone player played it in a single breath.</p> <p>Similarly with the Concert Guitar Voice and play the D note strongly, the D note would sound as a “hammer on,” without the string being plucked again. Depending on how you play, other effects such as “shaking” or breath noises (for the Trumpet Voice), or finger noises (for the Guitar Voice) are produced.</p> <p>For details on how to best play each S.Art! Voice, call up the information window (pressing the [6 ▼] (INFO) button in the Voice Selection display).</p>
Live!	These acoustic instrument sounds were sampled in stereo, to produce a truly authentic, rich sound—full of atmosphere and ambience.
Cool!	These Voices use sophisticated programming to capture the dynamic textures and subtle nuances of electric instruments.
Sweet!	These acoustic instrument sounds also benefit from Yamaha’s sophisticated technology—and feature a finely detailed and natural sound.
Drums	Various drum and percussion sounds are assigned to individual keys, letting you play the sounds from the keyboard. For information about what sound is assigned to each key, refer to the “Drum/SFX Kit List” in the Data List on the website.
Live! Drums	These are high-quality drum sounds that take full advantage of Stereo Sampling and Dynamic Sampling.
SFX	Various special effect sounds and percussion sounds are assigned to individual keys, letting you play the sounds from the keyboard. For information about what sound is assigned to each key, refer to the “Drum/SFX Kit List” in the Data List on the website.
Live! SFX	These are various high-quality special effect sounds and percussion sounds that take full advantage of Stereo Sampling and Dynamic sampling.
Organ Flutes!	This authentic organ Voice lets you use the Voice Set to adjust the various footages and craft your own original organ sounds. See page 118 for details.

MegaVoice	<p>These Voices make special use of velocity switching. Each velocity range (the measure of your playing strength) has a completely different sound. For example, a guitar MegaVoice includes the sounds of various performance techniques. In conventional instruments, different Voices having those sounds would be called up via MIDI and played in combination to achieve the desired effect. However, now with MegaVoices, a convincing guitar part can be played with just a single Voice, using specific velocity values to play the desired sounds. Because of the complex nature of these Voices and the precise velocities need to play the sounds, they're not intended for playing from the keyboard. They are, however, very useful and convenient when creating MIDI data—especially when you want to avoid using several different Voices just for a single instrument part.</p> <p>The MegaVoices are in the “MegaVoices” folder in the Voice Selection display. For instructions on selecting MegaVoices, refer to the “Selecting GM&amp;XG or Other Voices” on page 104.</p>
-----------	---

**NOTE** S.Art! and MegaVoices are not compatible with other instrument models. For this reason, any Song or Style you've created on this instrument using these Voices will not sound properly when played back on the instruments which do not have these types of Voices.

**NOTE** S.Art! and MegaVoices sound differently depending on keyboard range, velocity, touch, etc. Hence, if you turn on the [HARMONY/ARPEGGIO] button, change the transpose setting or change the Voice Set parameters, unexpected or undesired sounds may result.

For a list of preset Voices of this instrument, refer to the “Voice List” in the Data List on the website.

## Selecting GM&XG or Other Voices

This instrument features Voices provided specially for Style playback and XG/GM compatibility. These Voices cannot be called up directly from the VOICE category selection buttons. However, they can be called up as described below.

- 1 Turn on the PART SELECT button corresponding to the part you want to use.
- 2 Press one of the VOICE category selection buttons (other than the [ORGAN FLUTES] and [EXPANSION/USER] buttons) to call up the Voice Selection display.
- 3 Press the [8 ▲] (UP) button to call up the Voice categories.

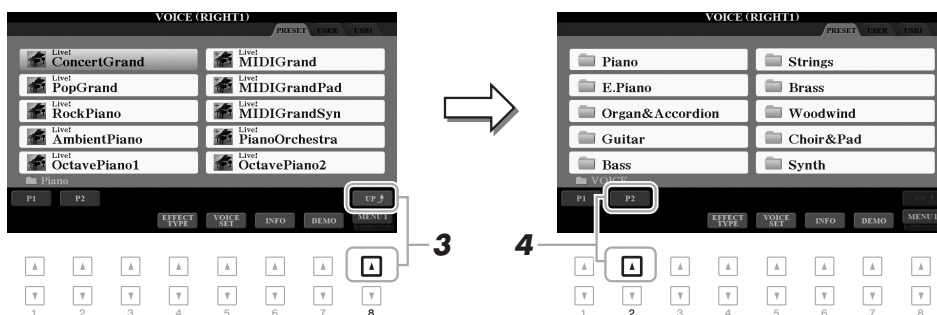

- 4 Press the [2 ▲] (P2) button to display page 2.
- 5 Press the desired [A]–[J] button to call up the Voice Selection display of GM&XG Voices, GM2 Voices, etc.

**NOTE** You can find the "Legacy" folder in this display. This folder contains previous Yamaha keyboards' Voices (such as PSR-A2000, etc.) for data compatibility with other models.

**NOTE** The "MegaVoices" folder contains the MegaVoices (page 103).

- 6 Select the desired Voice.



# Touch Response and Effect-Related Settings

## Setting the Touch Response of the Keyboard

Touch Response determines how the sound responds to your playing strength. The selected Touch Response type becomes the common setting for all Voices.

**NOTE** Some Voices are purposely designed without Touch Response, in order to emulate the true characteristics of the actual instrument (for example, conventional organs, which have no touch response).

### 1 Call up the operation display.

[FUNCTION] → TAB [◀] MENU 1 → [D] CONTROLLER → TAB [▶] KEYBOARD/PANEL

### 2 Use the [A] button to select “1 TOUCH RESPONSE.”

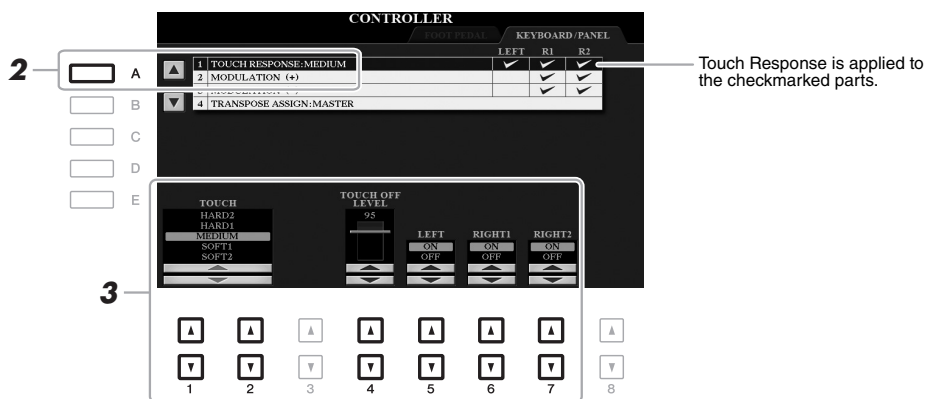

### 3 Use the [1 ▲▼], [2 ▲▼] and [4 ▲▼]–[7 ▲▼] buttons to set the Touch Response.

[1 ▲▼]/ [2 ▲▼]	TOUCH	Determines the Touch Response type. <b>HARD 2:</b> Requires strong playing to produce high volume. Best for players with a heavy touch. <b>HARD 1:</b> Requires moderately strong playing for higher volume. <b>MEDIUM:</b> Standard Touch Response. <b>SOFT 1:</b> Produces high volume with moderate playing strength. <b>SOFT 2:</b> Produces relatively high volume even with light playing strength. Best for players with a light touch.
[4 ▲▼]	TOUCH OFF LEVEL	Determines the fixed volume level when Touch is set to “OFF.”
[5 ▲▼]– [7 ▲▼]	LEFT–RIGHT2	Turns Touch on or off for each keyboard part.

## Making Detailed Settings for Harmony/Arpeggio

This lets you make detailed settings, including volume level.

### 1 Call up the operation display.

[FUNCTION] → TAB [◀] MENU 1 → [B] HARMONY/ARPEGGIO

### 2 Select the desired Harmony/Arpeggio category and type by using the [1 ▲▼]–[6 ▲▼] buttons.

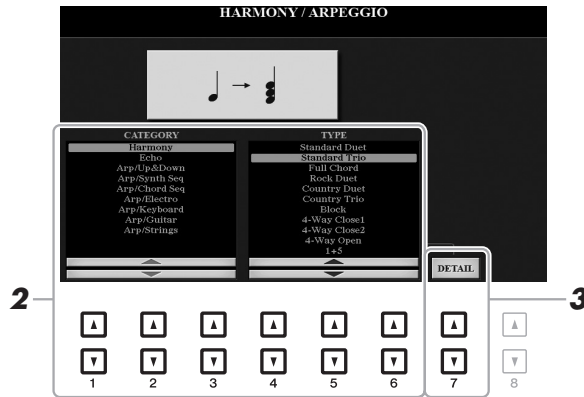

### 3 Use the [7 ▲▼] (DETAIL) buttons to call up the detailed setting window.

### 4 Use the [3 ▲▼]–[8 ▲▼] buttons to make various Harmony/Arpeggio settings.

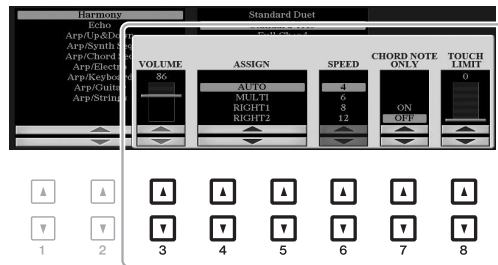

When any one of the Arpeggio types is selected, only the parameters indicated by “\*” in the list below can be set.

[3 ▲▼]	VOLUME*	Determines the volume level of the Harmony/Arpeggio notes generated by the Harmony/Arpeggio function.  <b>NOTE</b> When you are using certain Voices, such as Organ Voices, in which the TOUCH SENSE DEPTH is set to 0 in the VOICE SET display (page 114), the volume does not change.
--------	---------	---

<p>[4 ▲▼]/ [5 ▲▼]</p>	<p>ASSIGN*</p>	<p>Determines the keyboard part to which the effect is assigned.</p> <p><b>AUTO:</b> Applies the effect to the part (RIGHT 1/2) for which PART ON/OFF is on. If the Harmony/Echo category is selected, the RIGHT 1 part is given priority over the RIGHT 2 part when both parts are on.</p> <p><b>MULTI:</b> This parameter is available when the Harmony/Echo category is selected. When both parts are on, the note played on the keyboard is sounded by the RIGHT 1 part and the harmonies (effect) are divided to the RIGHT 1 and RIGHT 2 parts. When only one part is on, the note played on the keyboard and effect are sounded by that part.</p> <p><b>RIGHT 1, RIGHT 2:</b> Applies the effect to the selected part (RIGHT 1 or RIGHT 2).</p> <p><b>NOTE</b> When the “Harmony” category is selected, the keyboard part which is set to MONO and LEGATO is selected (page 114) for the Voice is regarded as off. For example, when RIGHT 1 is set to LEGATO (MONO) and RIGHT 2 is set to POLY, and both parts are turned on, turning the [HARMONY/ARPEGGIO] button on applies the Harmony effect only to the RIGHT 2 part.</p>
<p>[6 ▲▼]</p>	<p>SPEED</p>	<p>This parameter is only available when the “Echo” category (Echo, Tremolo, or Trill) is selected. It determines the speed of the Echo, Tremolo, and Trill effects.</p>
<p>[7 ▲▼]</p>	<p>CHORD NOTE ONLY</p>	<p>This parameter is only available when the “Harmony” category is selected. When this is set to “ON,” the Harmony effect is applied only to the note (played in the right-hand section of the keyboard) that belongs to a chord played in the chord section of the keyboard.</p>
<p>[8 ▲▼]</p>	<p>TOUCH LIMIT</p>	<p>It determines the lowest velocity value at which the Harmony, Echo, Tremolo, or Trill note will sound. This allows you to selectively apply the harmony by your playing strength, letting you create harmony accents in the melody. The harmony effect is applied when you play the key strongly (above the set value).</p>

**NOTE** The settings for the Arpeggio Quantize function and the Arpeggio Hold function can be made on the display called up via [FUNCTION] → TAB [◀] MENU 1 → [J] UTILITY → TAB [◀|▶] CONFIG 2 (page 204).

## Pitch-Related Settings

### Fine-tuning the Pitch of the Entire Instrument

You can fine-tune the pitch of the entire instrument such as keyboard, Style and Song parts (except the keyboard part played by the Drum Kit or SFX Kit Voices, and audio playback)—a useful feature when playing the PSR-A3000 along with other instruments or CD music.

#### 1 Call up the operation display.

[FUNCTION] → TAB [◀] MENU 1 → [E] MASTER TUNE/SCALE TUNE → TAB [◀] MASTER TUNE

#### 2 Use the [4 ▲▼]/[5 ▲▼] buttons to set the tuning in 0.2 Hz steps.

Press both [▲] and [▼] buttons (of 4 or 5) simultaneously to reset the value to the factory setting of 440.0 Hz.

### Scale Tuning

You can select various scales for playing in custom tunings for specific historical periods or music genres.

#### 1 Call up the operation display.

[FUNCTION] → TAB [◀] MENU 1 → [E] MASTER TUNE/SCALE TUNE → TAB [▶] SCALE TUNE

#### 2 Use the [A]/[B] buttons to select the desired scale.

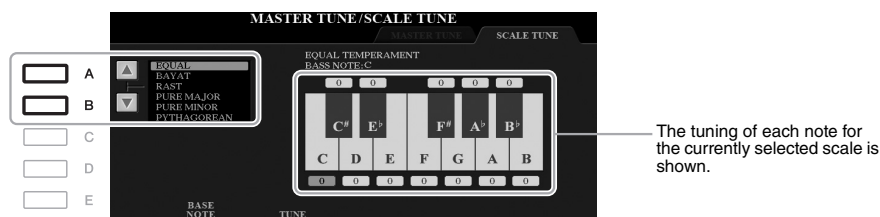

#### ■ Preset Scale types

EQUAL	The pitch range of each octave is divided equally into twelve parts, with each half-step evenly spaced in pitch. This is the most commonly used tuning in music today.
BAYAT, RAST	Use these tunings when playing Arabic music.
PURE MAJOR, PURE MINOR	These tunings preserve the pure mathematical intervals of each scale, especially for triad chords (root, third, fifth). You can hear this best in actual vocal harmonies—such as choirs and a cappella singing.
PYTHAGOREAN	This scale was devised by the famous Greek philosopher and is created from a series of perfect fifths, which are collapsed into a single octave. The 3rd in this tuning are slightly unstable, but the 4th and 5th are beautiful and suitable for some leads.
MEAN-TONE	This scale was created as an improvement on the Pythagorean scale, by making the major third interval more “in tune.” It was especially popular from the 16th century to the 18th century. Handel, among others, used this scale.
WERCKMEISTER, KIRNBERGER	This composite scale combines the Werckmeister and Kirnberger systems, which were themselves improvements on the mean-tone and Pythagorean scales. The main feature of this scale is that each key has its own unique character. The scale was used extensively during the time of Bach and Beethoven, and even now it is often used when performing period music on the harpsichord.

### 3 Change the following settings as necessary.

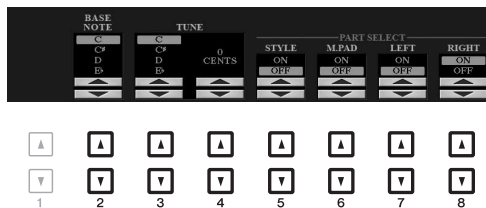

[2 ▲▼]	BASE NOTE	Determines the base note for each scale. When the base note is changed, the pitch of the keyboard is transposed, yet maintains the original pitch relationship between the notes.
[3 ▲▼]/ [4 ▲▼]	TUNE	Select the desired note to be tuned by using the [3 ▲▼] buttons and tune it in cents by using the [4 ▲▼] buttons.  <b>NOTE</b> In musical terms a "cent" is 1/100th of a semitone. (100 cents equal one semitone.) <b>NOTE</b> The note can also be selected by pressing one of the SCALE SETTING buttons.
[5 ▲▼]- [8 ▲▼]	PART SELECT	Determines whether the Scale Tune setting is applied to each part or not.

**NOTE** To register the Scale Tune settings to Registration Memory, be sure to checkmark the SCALE item in the REGISTRATION MEMORY CONTENTS display called up via the [MEMORY] button.

## Changing the Part Assignment of the TRANSPOSE Buttons

You can determine to which parts the TRANSPOSE [-]/[+] buttons are applied.

### 1 Call up the operation display.

[FUNCTION] → TAB [◀] MENU 1 → [D] CONTROLLER → TAB [▶] KEYBOARD/PANEL

### 2 Use the [B] button to select "4 TRANSPOSE ASSIGN."

### 3 Press the [4 ▲▼]/[5 ▲▼] buttons to select the desired part assignment.

KEYBOARD	The TRANSPOSE [-]/[+] buttons affect the pitch of keyboard played Voices, Style playback (controlled by the performance in the chord section of the keyboard), and Multi Pad playback (when Chord Match is on, and left-hand chords are indicated)—but they do not affect Song playback.
SONG	The TRANSPOSE [-]/[+] buttons affect only the pitch of Song playback.
MASTER	The TRANSPOSE [-]/[+] buttons affect the overall pitch of the instrument, except audio playback.

The assignment can be confirmed by the pop-up display called up via the TRANSPOSE [-]/[+] buttons.

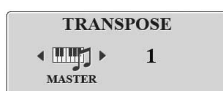

## Editing Parameters Assigned to the Joystick

The eight combinations of functions assigned to the joystick are provided by default, however, you can change the functions as desired from a variety of options.

### 1 Press the [ASSIGN] button to call up the LIVE CONTROL display.

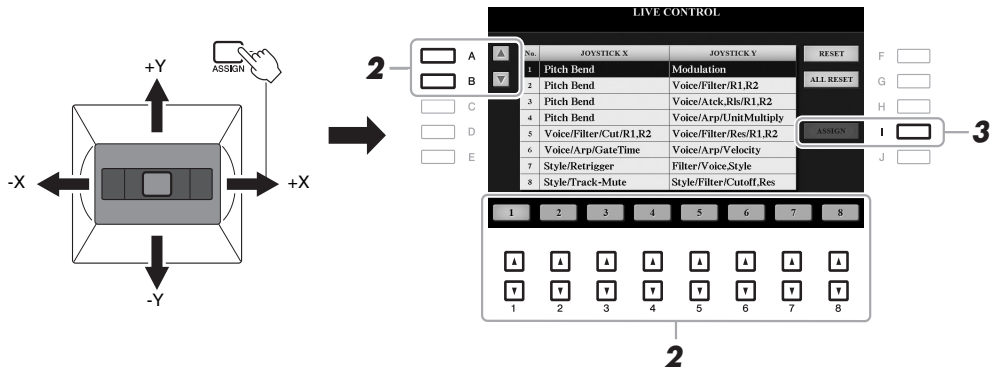

### 2 Use the [A]/[B] buttons or the [1 ▲▼]–[8 ▲▼] buttons to select the number (from 2 to 8) of the functions you want to change.

The Pitch Bend and the Modulation functions are always assigned to number 1 and other functions cannot be assigned.

### 3 Press the [I] (ASSIGN) button to call up the PARAMETER ASSIGN window.

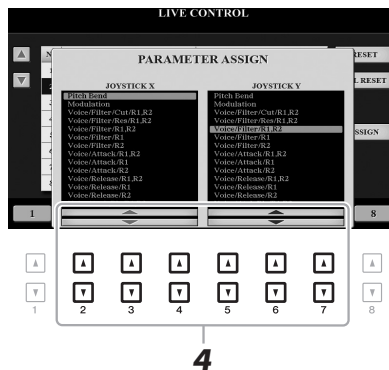

### 4 Use the [2 ▲▼]–[4 ▲▼] buttons for horizontal (X) directions and the [5 ▲▼]–[7 ▲▼] buttons for vertical (Y) directions to select the functions to be assigned.

For information on available functions, see pages 111–112.

### 5 Press the [EXIT] button to close the PARAMETER ASSIGN window.

### 6 If necessary, repeat steps 2–5 to change the functions for other numbers.

**NOTE** The settings here are maintained even when you turn off the power.

## ■ Assignable Joystick Functions

Pitch Bend	<p>Bends notes up or down while playing the keyboard. This is applied to all the keyboard parts (RIGHT 1, 2 and LEFT). The maximum pitch bend range can be changed on the Mixing Console display: [MIXER/EQ] → TAB [◀][▶] TUNE → [H] PITCH BEND RANGE.</p> <p><b>NOTE</b> The Pitch Bend effect may not be applied to the LEFT part during Style playback, depending on the Style setting.</p>
Modulation	<p>Applies modulation effects, which are set on the CONTROLLER page of the VOICE SET display (page 115), to notes played on the keyboard. By default, this is applied to the keyboard parts RIGHT 1, 2 and LEFT. You can set whether the effects controlled by the joystick will be applied independently or not to each keyboard part: [FUNCTION] → TAB [◀] MENU 1 → [D] CONTROLLER → TAB [▶] KEYBOARD/PANEL → [A]/[B] 2 MODULATION (+), 3 MODULATION (-).</p> <p><b>NOTE</b> Modulation effects may not be applied to the LEFT part during Style playback, depending on the Style setting.</p>
Voice/Filter/Cut/R1,R2	Adjusts the cutoff frequency of the filter for the RIGHT 1 and 2 parts. Moving the joystick in the + direction makes the sound brighter.
Voice/Filter/Res/R1,R2	Adjusts the resonance of the filter for the RIGHT 1 and 2 parts. Moving the joystick in the + direction makes the sound more pronounced.
Voice/Filter/R1,R2	Adjusts the cutoff frequency of the filter and the resonance for the RIGHT 1 and/or 2 parts to change the timbre or tone of the sound.
Voice/Filter/R1	
Voice/Filter/R2	
Voice/Attack/R1,R2	Adjusts the length of time (attack time) until the RIGHT 1 and/or 2 parts reach their maximum level after the key is played. Moving the joystick in the + direction increases it.
Voice/Attack/R1	
Voice/Attack/R2	
Voice/Release/R1,R2	Adjusts the length of time (release time) until the RIGHT 1 and/or 2 parts decay to silence after the key is released. Moving the joystick in the + direction increases it.
Voice/Release/R1	
Voice/Release/R2	
Voice/Atck,Rls/R1,R2	Adjusts both the attack and release time of the RIGHT 1 and/or 2 parts. Moving the joystick in the + direction increases both of the time parameters.
Voice/Atck,Rls/R1	
Voice/Atck,Rls/R2	
Voice/Arp/Velocity	Adjusts the volume of Arpeggio. Moving the joystick in the + direction increases it.
Voice/Arp/GateTime	Adjusts the length of each note of Arpeggio. Moving the joystick in the + direction increases it.
Voice/Arp/UnitMultiply	Adjust the speed of Arpeggio. Moving the joystick in the + direction makes it faster.
Style/Filter/Cutoff	Adjusts the cutoff frequency of the filter for the Style. Moving the joystick in the + direction makes the sound brighter.
Style/Filter/Resonance	Adjusts the resonance of the filter for the Style. Moving the joystick in the + direction makes the sound more pronounced.
Style/Filter/Cutoff,Res	Adjusts the cutoff frequency of the filter and the resonance for the Style to change the timbre or tone of the sound.

Style/Retrigger	<p>Turns on/off and adjusts the length of the Style Retrigger function, which repeats a specific length of the first part of the current Style. Moving the joystick turns on the Style Retrigger function and adjusts its length. Returning the joystick to the center position turns off the Style Retrigger function.</p> <p><b>NOTE</b> The Style Retrigger function is applied only to the Main section of the Style.</p>
Style/Track-Mute	<p>Turns playback of the Style channels on/off. Moving the joystick in the + direction turns off the channels in the order of Rhythm 1/2, Phrase 1/2, Bass/Pad, Chord 2, and only the Chord 1 is kept turned on at the end. Moving the joystick in the - direction turns off the channels in the order of Phrase 1/2/ Pad, Chord 1/2, Bass, Rhythm 1, and only the Rhythm 2 is kept turned on at the end. Returning the joystick to the center position turns all channels on.</p>
Filter/Voice,Style	<p>Adjusts the cutoff frequency and the resonance of the filter for all keyboard parts and the Style to change the timbre or tone of the sound.</p>
Master Tempo	<p>Changes the tempo of the currently selected Style or Song. Setting range is from 50% of the default tempo value to 150%. Returning the joystick to the center position resets the tempo to the default.</p>
<No Assign>	<p>No function is assigned.</p>



## Editing Voices (Voice Set)

The Voice Set function allows you to create your own Voices by editing some parameters of the existing Voices. Once you've created a Voice, you can save it as a file to internal memory (USER drive) or a USB flash drive for future recall.

### 1 Select the desired Voice (other than an Organ Flutes Voice).

Organ Flutes Voices have a different editing method than described here. For instructions on editing the Organ Flutes Voices, see page 118.

### 2 In the Voice Selection display, press the [5 ▼] (VOICE SET) button of MENU 1 to call up the VOICE SET display.

### 3 Use the TAB [◀][▶] buttons to call up the relevant setting page.

For information on the available parameters in each page, see the "Editable Parameters in the VOICE SET Displays" on page 114.

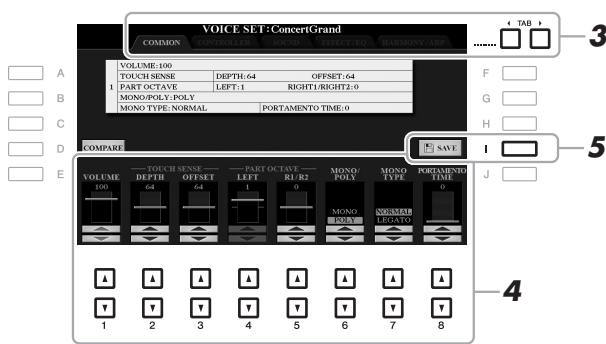

### 4 As necessary, use the [A]/[B] buttons to select the item (parameter) to be edited and edit the Voice by using the [1 ▲▼]–[8 ▲▼] buttons.

By pressing the [D] (COMPARE) button, you can compare the sound of the edited Voice with the original (unedited) Voice.

### 5 Press the [I] (SAVE) button to save your edited Voice.

For details on the Save operation, refer to page 28.

#### **NOTICE**

The settings will be lost if you select another Voice or turn off the power to the instrument without carrying out the Save operation.

## Editable Parameters in the VOICE SET Displays

The Voice Set parameters are organized into five different pages. The parameters in each page are described separately, below.

**NOTE** The available parameters differ depending on the Voice.

### ■ COMMON Page

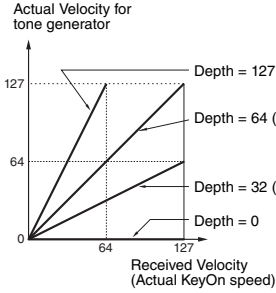
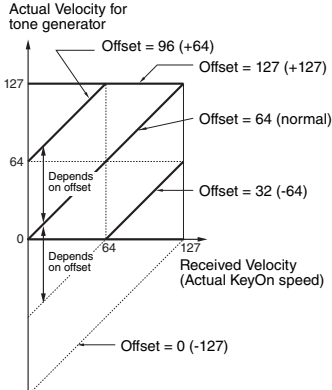
[1 ▲▼]	VOLUME	Adjusts the volume of the current edited Voice.
[2 ▲▼]/ [3 ▲▼]	TOUCH SENSE	<p>Adjusts the touch sensitivity (velocity sensitivity), or how greatly the volume responds to your playing strength.</p> <div style="display: flex; justify-content: space-around;"> <div style="width: 45%;"> <p><b>TOUCH SENSE DEPTH</b> Changes to velocity curve according to VelDepth (with Offset set to 64)</p>  </div> <div style="width: 45%;"> <p><b>TOUCH SENSE OFFSET</b> Changes to velocity curve according to VelOffset (with Depth set to 64)</p>  </div> </div> <p><b>DEPTH:</b> Determines the velocity sensitivity, or how much the level of the Voice changes in response to your playing strength (velocity).</p> <p><b>OFFSET:</b> Determines the amount by which received velocities are adjusted for the actual velocity effect.</p>
[4 ▲▼]/ [5 ▲▼]	PART OCTAVE	Shifts the octave range of the edited Voice up or down in octaves. When the edited Voice is used as any of the RIGHT 1–2 parts, the R1/R2 parameter is available; when the edited Voice is used as the LEFT part, the LEFT parameter is available.
[6 ▲▼]	MONO/POLY	Determines whether the edited Voice is played monophonically or polyphonically. This setting can also be made from the VOICE EFFECT [MONO] button on the panel.
[7 ▲▼]	MONO TYPE	<p>Determines the behavior of the notes of decaying sounds, such as a guitar, when they are played with legato with the edited Voice set to MONO above. When NORMAL is selected, the next note sounds after the previous note is stopped. When LEGATO is selected, the sound of the previously played note is maintained and only the pitch changes to that of the next note.</p> <p><b>NOTE</b> This parameter is unavailable for Super Articulation Voices, Organ Flute Voices and Drum/SFX Kit Voices, and behaves the same as the NORMAL setting when these Voices are selected.</p> <p><b>NOTE</b> When LEGATO is selected, the behavior (other than what is described here) may be different from NORMAL, depending on the panel settings.</p>
[8 ▲▼]	PORTAMENTO TIME	<p>Determines the pitch transition time when the edited Voice is set to MONO above.</p> <p><b>NOTE</b> Portamento is a function that creates a smooth transition in pitch from the first note played on the keyboard to the next.</p>

## ■ CONTROLLER Page

### 1 MODULATION (+), 2 MODULATION (-)

The joystick can be used to modulate the parameters below as well as the pitch (vibrato). Here, you can set the degree to which the joystick modulates each of the following parameters.

[2 ▲▼]	FILTER	Determines the degree to which the joystick modulates the Filter Cutoff Frequency. For details about the filter, see below.
[3 ▲▼]	AMPLITUDE	Determines the degree to which the joystick modulates the amplitude (volume).
[5 ▲▼]	PMOD	Determines the degree to which the joystick modulates the pitch, or the vibrato effect.
[6 ▲▼]	FMOD	Determines the degree to which the joystick modulates the Filter modulation, or the wah effect.
[7 ▲▼]	AMOD	Determines the degree to which the joystick modulates the amplitude, or the tremolo effect.

**NOTE** Make sure to assign the Modulation function to the joystick when using these effects (page 40).

## ■ SOUND Page

### FILTER

Filter is a processor that changes the timbre or tone of a sound by either blocking or passing a specific frequency range. The parameters below determine the overall timbre of the sound by boosting or cutting a certain frequency range. In addition to making the sound either brighter or mellower, Filter can be used to produce electronic, synthesizer-like effects.

[1 ▲▼]	BRIGHT. (Brightness)	Determines the cutoff frequency or effective frequency range of the filter (see diagram). Higher values result in a brighter sound.	
[2 ▲▼]	HARMO. (Harmonic Content)	Determines the emphasis given to the cutoff frequency (resonance), set in BRIGHT. above (see diagram). Higher values result in a more pronounced effect.	

## EG

The EG (Envelope Generator) settings determine how the level of the sound changes in time. This lets you reproduce many sound characteristics of natural acoustic instruments—such as the quick attack and decay of percussion sounds, or the long release of a sustained piano tone.

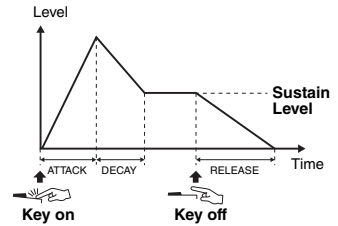

[3 ▲▼]	ATTACK	Determines how quickly the sound reaches its maximum level after the key is played. The lower the value, the quicker the attack.
[4 ▲▼]	DECAY	Determines how quickly the sound reaches its sustain level (a slightly lower level than maximum). The lower the value, the quicker the decay.
[5 ▲▼]	RELEASE	Determines how quickly the sound decays to silence after the key is released. The lower the value, the quicker the decay.

## VIBRATO

Vibrato is a quavering, vibrating sound effect that is produced by regularly modulating the pitch of the Voice.

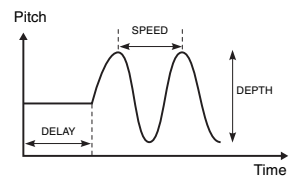

[6 ▲▼]	DEPTH	Determines the intensity of the Vibrato effect. Higher settings result in a more pronounced Vibrato.
[7 ▲▼]	SPEED	Determines the speed of the Vibrato effect.
[8 ▲▼]	DELAY	Determines the amount of time that elapses between the playing of a key and the start of the Vibrato effect. Higher settings increase the delay of the Vibrato onset.

## ■ EFFECT/EQ Page

### 1 REVERB DEPTH/CHORUS DEPTH/DSP DEPTH/PANEL SUSTAIN

[1 ▲▼]/ [2 ▲▼]	REVERB DEPTH	Adjusts the reverb depth.
[3 ▲▼]/ [4 ▲▼]	CHORUS DEPTH	Adjusts the chorus depth.
[5 ▲▼]	DSP ON/OFF	Determines whether the DSP effect is on or off. This setting can also be made from the VOICE EFFECT [DSP] button on the panel.
[6 ▲▼]	DSP DEPTH	Adjusts the DSP depth. If you want to re-select the DSP type, you can do so in the “2 DSP” menu explained on page 117.
[7 ▲▼]	PANEL SUSTAIN	Determines the sustain level applied to the edited Voice when the VOICE EFFECT [SUSTAIN] button on the panel is turned on.

## 2 DSP

[1 ▲▼]/ [2 ▲▼]	CATEGORY	Selects the DSP effect category and type. Select a type after selecting a category.
[3 ▲▼]/ [4 ▲▼]	TYPE	
[6 ▲▼]	VARIATION ON/OFF	Turns the DSP Variation on or off for the selected Voice. This setting can also be made from the VOICE EFFECT [DSP VARI.] button on the panel.
[5 ▲▼]/ [7 ▲▼]	DETAIL	Calls up a detailed setting display. Press the [5 ▲▼] button for editing the standard parameter value, and the [7 ▲▼] button for editing the Variation parameter value.
[2 ▲▼] -[4 ▲▼]	PARAMETER	Selects the DSP variation parameter to be set.
[5 ▲▼] -[6 ▲▼]	VALUE	Adjusts the value of the DSP variation parameter.

## 3 EQ

Determines the Frequency and Gain of the low and high EQ bands. Use the [2 ▲▼]-[4 ▲▼] buttons for the low EQ band, and the [5 ▲▼]-[7 ▲▼] buttons for the high EQ band.

### ■ HARMONY/ARP Page

Same as the display called up via [FUNCTION] → TAB [◀] MENU 1 → [B] HARMONY/ARPEGGIO (pages 106–107), with the exception of the following points:

- The details set via the [7 ▲▼] (DETAIL) buttons are shown on the top of the display.
- The [D] (COMPARE) and [I] (SAVE) buttons are available (see steps 4–5 on page 113).

## Disabling Automatic Selection of Voice Sets (Effects, etc.)

Each Voice is linked to its default VOICE SET parameter settings. Usually these settings are automatically called up when a Voice is selected. However, you can also disable this feature by the operation in the relevant display as explained below. For example, if you want to change the Voice yet keep the same effect, set the EFFECT parameter to OFF (in the display explained below).

### 1 Call up the operation display.

[FUNCTION] → TAB [◀] MENU 1 → [F] VOICE SET FILTER

### 2 Use the [A]/[B] buttons to select a keyboard part.

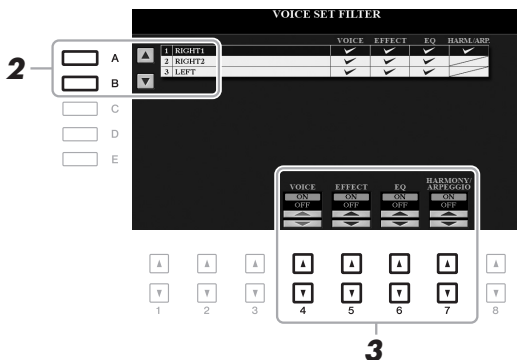

### 3 Use the [4 ▲▼]–[7 ▲▼] buttons to turn each item for the selected Part on or off.

When the button is set to ON, the corresponding parameter settings are called up automatically together with the Voice selection. For information on which parameters are linked to each item, see below.

[4 ▲▼]	VOICE	Corresponds to the parameter settings of the COMMON, CONTROLLER, and SOUND pages.
[5 ▲▼]	EFFECT	Corresponds to the parameter settings of 1 and 2 in the EFFECT/EQ page.
[6 ▲▼]	EQ	Corresponds to the parameter settings of 3 in the EFFECT/EQ page.
[7 ▲▼]	HARMONY/ ARPEGGIO	Corresponds to the HARMONY/ARP page.

## Editing Organ Flutes Voices

The Organ Flute Voices can be edited by adjusting the footage levers, adding the attack sound, applying effects and equalizer, etc.

### 1 Select the desired Organ Flutes Voice.

1-1 Press the [ORGAN FLUTES] button.

1-2 Press the [I] (PRESET) button to call up the Voice Selection display.

1-3 Press one of the [A]–[J] buttons to select the desired Voice.

### 2 Press the [5 ▼] (VOICE SET) button to call up the VOICE SET display.

### 3 Use the TAB [◀][▶] buttons to call up the relevant setting page (FOOTAGE, VOLUME/ATTACK or EFFECT/EQ).

For information on the available parameters in each page, see pages 45 and 119.

### 4 Edit the Organ Flutes Voice.

### 5 Press the [I] (PRESET) button to call up the Organ Flutes Voice Selection display.

### 6 Save your edited Voice.

For instructions on the Save operation, refer to page 28.

#### **NOTICE**

The settings will be lost if you select another Voice or turn off the power to the instrument without carrying out the Save operation.

#### ■ FOOTAGE Page

Refer to page 45.

## ■ VOLUME/ATTACK Page

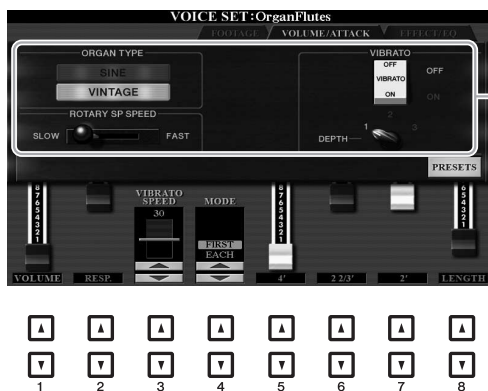

Same as the FOOTAGE page.





[1 ▲▼]	VOLUME	Adjusts the overall volume of the Organ Flutes. The longer the graphic bar, the greater the volume.
[2 ▲▼]	RESP. (Response)	Affects both the attack and release (page 116) portion of the sound, increasing or decreasing the response time of the initial swell and release, based on the FOOTAGE controls. The higher the value, the slower the swell and release.
[3 ▲▼]	VIBRATO SPEED	Determines the speed of the vibrato effect controlled by the Vibrato On/Off ([F]/[G] buttons) and Vibrato Depth ([H] button).
[4 ▲▼]	MODE	The MODE control selects between two modes: FIRST and EACH. In the FIRST mode, attack (percussive sound) is applied only to the first notes played and held simultaneously; while the first notes are held, any subsequently played notes have no attack applied. In the EACH mode, attack is applied equally to all notes.
[5 ▲▼]– [7 ▲▼]	4', 2 2/3', 2'	These determine the attack sound volume of the Organ Flutes Voice. The 4', 2-2/3' and 2' controls increase or reduce the volume of attack sound at the corresponding footages. The longer the graphic bar, the greater the attack sound volume.
[8 ▲▼]	LENGTH	Affects the attack portion of the sound producing a longer or shorter decay immediately after the initial attack. The longer the graphic bar, the longer the decay.

## ■ EFFECT/EQ Page

Same parameters as in the VOICE SET “EFFECT/EQ” page explained on page 116, except that PANEL SUSTAIN is not available for the Organ Flutes Voices.

## Chord Fingering Types

The Chord Fingering type determines how chords are specified for Style playback. The type can be changed from: [FUNCTION] → TAB [◀] MENU 1 → [A] SPLIT POINT/CHORD FINGERING → TAB [▶] CHORD FINGERING.

SINGLE FINGER	<p>Makes it simple to produce orchestrated accompaniment using major, seventh, minor and minor-seventh chords by pressing only one, two or three keys on the Chord section of the keyboard.</p> <div style="display: flex; justify-content: space-around;"> <div style="text-align: center;">  <p><b>C</b></p> </div> <div style="text-align: center;"> <p><b>For a major chord,</b> press the root key only.</p> </div> <div style="text-align: center;">  <p><b>C7</b></p> </div> <div style="text-align: center;"> <p><b>For a seventh chord,</b> simultaneously press the root key and a white key to its left.</p> </div> </div> <div style="display: flex; justify-content: space-around; margin-top: 10px;"> <div style="text-align: center;">  <p><b>Cm</b></p> </div> <div style="text-align: center;"> <p><b>For a minor chord,</b> simultaneously press the root key and a black key to its left.</p> </div> <div style="text-align: center;">  <p><b>Cm7</b></p> </div> <div style="text-align: center;"> <p><b>For a minor-seventh chord,</b> simultaneously press the root key and both a white and black key to its left.</p> </div> </div>
MULTI FINGER	Automatically detects Single Finger or Fingered chord fingerings, so you can use either type of fingering without having to switch fingering types.
FINGERED	Lets you specify the chord by pressing the notes making up a chord in the left hand section of the keyboard when [ACMP] is turned on or the Left part is turned on. For information on which notes to press for each chord, refer to page 121, or use the Chord Tutor function on the right-half of this display.
FINGERED ON BASS	Accepts the same fingerings as Fingered, but the lowest note played in the Chord section of the keyboard is used as the bass note, allowing you to play “on bass” chords. (In the Fingered type, the root of the chord is always used as the bass note.)
FULL KEYBOARD	Detects chords in the entire key range. Chords are detected in a way similar to Fingered, even if you split the notes between your left and right hands—for example, playing a bass note with your left hand and a chord with your right, or by playing a chord with your left hand and a melody note with your right.
AI FINGERED	Basically the same as Fingered, with the exception that less than three notes can be played to indicate the chords (based on the previously played chord, etc.).
AI FULL KEYBOARD	This type is similar to Full Keyboard, with the exception that less than three notes can be played to indicate the chords (based on the previously played chord, etc.). 9th, 11th and 13th chords cannot be played.

**NOTE** “AI” stands for “Artificial Intelligence.”



# Chord Types Recognized in the Fingered Mode

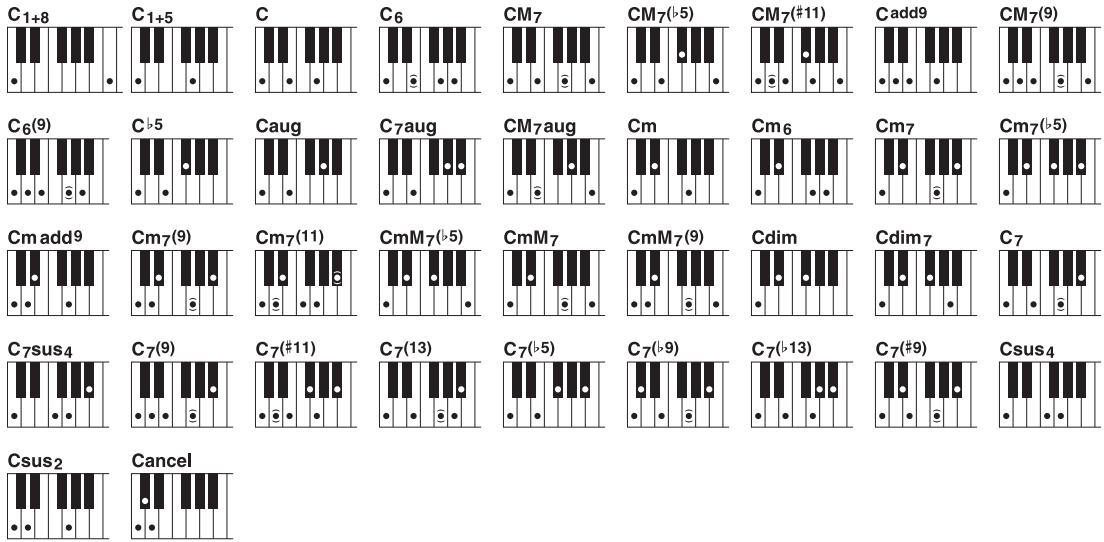

Chord Name [Abbreviation]	Normal Voicing*	Display for root "C"
1+8	1+8	C1+8
1+5	1+5	C1+5
Major [M]	1+3+5	C
Sixth [6]	1+(3)+5+6	C6
Major seventh [M7]	1+3+(5)+7	CM7
Major seventh flatted fifth [M7b5]	1+3+ $\flat$ 5+7	CM7( $\flat$ 5)
Major seventh add sharp eleventh [M7(#11)]	1+(2)+3+ $\sharp$ 4+5+7	CM7(#11)
Add ninth [(add9)]	1+2+3+5	Cadd9
Major seventh ninth [M7_9]	1+2+3+(5)+7	CM7(9)
Sixth ninth [6_9]	1+2+3+(5)+6	C6(9)
Flatted fifth [( $\flat$ 5)]	1+3+ $\flat$ 5	C $\flat$ 5
Augmented [aug]	1+3+ $\sharp$ 5	Caug
Seventh augmented [7aug]	1+3+ $\sharp$ 5+ $\flat$ 7	C7aug
Major seventh augmented [M7aug]	1+(3)+ $\sharp$ 5+7	CM7aug
Minor [m]	1+ $\flat$ 3+5	Cm
Minor sixth [m6]	1+ $\flat$ 3+5+6	Cm6
Minor seventh [m7]	1+ $\flat$ 3+(5)+ $\flat$ 7	Cm7
Minor seventh flatted fifth [m7b5]	1+ $\flat$ 3+ $\flat$ 5+ $\flat$ 7	Cm7( $\flat$ 5)
Minor add ninth [m(9)]	1+2+ $\flat$ 3+5	Cm add9
Minor seventh ninth [m7(9)]	1+2+ $\flat$ 3+(5)+ $\flat$ 7	Cm7(9)
Minor seventh eleventh [m7(11)]	1+(2)+ $\flat$ 3+4+5+( $\flat$ 7)	Cm7(11)
Minor major seventh flatted fifth [mM7b5]	1+ $\flat$ 3+ $\flat$ 5+7	CmM7( $\flat$ 5)
Minor major seventh [mM7]	1+ $\flat$ 3+(5)+7	CmM7
Minor major seventh ninth [mM7(9)]	1+2+ $\flat$ 3+(5)+7	CmM7(9)
Diminished [dim]	1+ $\flat$ 3+ $\flat$ 5	Cdim
Diminished seventh [dim7]	1+ $\flat$ 3+ $\flat$ 5+6	Cdim7
Seventh [7]	1+3+(5)+ $\flat$ 7	C7
Seventh suspended fourth [7sus4]	1+4+5+ $\flat$ 7	C7sus4
Seventh ninth [7(9)]	1+2+3+(5)+ $\flat$ 7	C7(9)
Seventh add sharp eleventh [7(#11)]	1+(2)+3+ $\sharp$ 4+5+ $\flat$ 7	C7(#11)
Seventh add thirteenth [7(13)]	1+3+(5)+6+ $\flat$ 7	C7(13)
Seventh flatted fifth [7b5]	1+3+ $\flat$ 5+ $\flat$ 7	C7( $\flat$ 5)
Seventh flatted ninth [7b9]	1+ $\flat$ 2+3+(5)+ $\flat$ 7	C7( $\flat$ 9)
Seventh add flatted thirteenth [7b13]	1+3+5+ $\flat$ 6+ $\flat$ 7	C7( $\flat$ 13)
Seventh sharp ninth [7(#9)]	1+ $\sharp$ 2+3+(5)+ $\flat$ 7	C7(#9)
Suspended fourth [sus4]	1+4+5	Csus4
One plus two plus five [sus2]	1+2+5	Csus2
cancel	1+ $\flat$ 2+2	Cancel

\* Notes in parentheses can be omitted.

## Style Playback Related Settings

The instrument has a variety of settings for Style playback which can be accessed in the display below.

### 1 Call up the operation display.

[FUNCTION] → TAB [◀] MENU 1 → [G] STYLE SETTING

### 2 Use the [C] and [1 ▲▼]/[8 ▲▼] buttons for each setting.

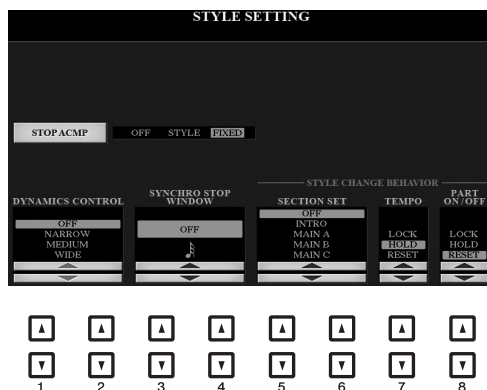

[C]	STOP ACMP	<p>When [ACMP] is turned on and [SYNC START] is off, you can play chords in the chord section of the keyboard with the Style stopped, and still hear the accompaniment chord. In this condition—called “Stop Accompaniment”—any valid chord fingerings are recognized and the chord root/type are shown in the display. Here, you can determine whether the chord played in the chord section will sound or not in the Stop Accompaniment status.</p> <p><b>OFF:</b> The chord played in the chord section will not sound.</p> <p><b>STYLE:</b> The chord played in the chord section will sound via the Voices for the Pad channel and the Bass channel of the selected Style.</p> <p><b>FIXED:</b> The chord played in the chord section will sound via the specified Voice, regardless of the selected Style.</p> <p><b>NOTE</b> When the selected Style contains MegaVoices, unexpected sounds may result when this is set to “STYLE.”</p> <p><b>NOTE</b> When you record a Song, the chord detected by playing the Stop Accompaniment can be recorded regardless of the setting here. Please note that both the sounding Voice and chord data is recorded when set to “STYLE,” and only the chord data is recorded when set to “OFF” or “FIXED.”</p>
[1 ▲▼]/ [2 ▲▼]	DYNAMICS CONTROL	<p>This determines how the Style playback volume changes depending on the playing strength.</p> <p><b>OFF:</b> The volume is kept the same regardless of playing strength.</p> <p><b>NARROW:</b> The volume changes over a narrow range.</p> <p><b>MEDIUM:</b> The volume changes over a medium range.</p> <p><b>WIDE:</b> The volume changes over a wide range.</p>

[3 ▲▼]/ [4 ▲▼]	SYNCHRO STOP WINDOW	This determines how long you can hold a chord before the Synchro Stop function is automatically cancelled. When the [SYNC STOP] button is turned on and this is set to a value other than “OFF,” this automatically cancels the Synchro Stop function if you hold a chord for longer than the time set here. This conveniently resets Style playback control to normal, letting you release the keys and still have the Style play. In other words, if you release the keys sooner than the time set here, the Synchro Stop function works.
[5 ▲▼]/ [6 ▲▼]	SECTION SET	Determines the default section that is automatically called up when selecting different Styles (when Style playback is stopped). When set to “OFF” and Style playback is stopped, the active section is maintained even if the different Style is selected. When any of the MAIN A–D sections is not included in the Style data, the nearest section is automatically selected. For example, when MAIN D is not contained in the selected Style, MAIN C will be called up.
[7 ▲▼]	TEMPO	This determines whether the tempo setting of the Style changes or not when you change Styles.  <b>LOCK:</b> The previous tempo setting is always maintained.  <b>HOLD:</b> During Style playback, the previous tempo setting is maintained. When Style playback is stopped, the tempo changes to that of the default tempo for the selected Style.  <b>RESET:</b> The tempo always changes to that of the default tempo for the selected Style.
[8 ▲▼]	PART ON/OFF	This determines whether the Style Channel On/Off status changes or not when you change Styles.  <b>LOCK:</b> The Channel On/Off status of the previous Style is always maintained.  <b>HOLD:</b> During Style playback, the Channel On/Off status of the previous Style is maintained. When Style playback is stopped, all Style Channels are set to On.  <b>RESET:</b> All Style Channels are set to On.

## Memorizing Original Settings to One Touch Setting

You can memorize your original panel settings to a One Touch Setting. The newly created One Touch Setting will be saved in the USER drive or a USB flash drive as a Style, and you can call up the One Touch Setting as a part of the Style.

- 1 Select the desired Style to memorize your One Touch Setting.**
- 2 Make the desired panel settings, such as those for Voices and effects.**
- 3 Press the [MEMORY] button in the REGISTRATION MEMORY section.**

The REGISTRATION MEMORY CONTENTS display appears. However you do not need to make any settings here, since the On/Off settings in this display do not affect the One Touch Setting function.

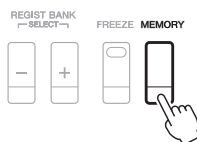

- 4 Press one of the ONE TOUCH SETTING [1]–[4] buttons to which you wish to memorize your panel settings.**

A message appears. If you are sure you want to memorize the current settings to the selected button, press the [F] (YES) button. If you want to change the settings, press the [G] (NO) button, then repeat steps 2–4 as necessary.

ONE TOUCH SETTING

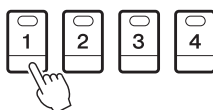

**NOTE** For ONE TOUCH SETTING buttons to which your original panel settings have not been memorized, the OTS settings of the original Style will be maintained.

- 5 Press the [F] (YES) button to call up the Style Selection display and save the One Touch Setting as a Style.**

For instructions on the Save operation, refer to page 28.

### **NOTICE**

The memorized panel settings (One Touch Settings) will be lost if you change the Style or turn the power off without carrying out the Save operation.

## Creating/Editing Styles (Style Creator)

A Style is made up of the different Sections (Intro, Main, Ending, etc.) and each Section has separate channels (rhythm pattern, bass line, chord backing, pad, or phrase, each of which is referred to as a “Source Pattern”). With the Style Creator function, you can create an original Style by separately recording the channels, or by copying pattern data from other existing Styles.

### Basic Procedure for Creating a Style

**1** Select the desired Style to be used as the basis for the new Style.

**2** Call up the Style Creator display.

[FUNCTION] → TAB [▶] MENU 2 → [A] STYLE CREATOR

**3** From the BASIC page, select a Section.

(If the RECORD display is shown in the lower half section of the display, press the [EXIT] button.) Press the [A] button to select “1 SECTION,” then use the [3 ▲▼]/[4 ▲▼] buttons to select a Section.

Carry out the following operations as necessary.

- If you create a Style entirely from scratch, press the [C] (NEW STYLE) button to call up an empty new Style.
- For the current Section, select the pattern length via the [5 ▲▼]/[6 ▲▼] buttons. After selecting, press the [D] (EXECUTE) button to actually enter the specified length.
- For the entire current Style, use the [A]/[B] buttons to select “2 TEMPO/BEAT,” then set the Tempo via the [3 ▲▼]/[4 ▲▼] buttons, and the Time Signature via the [5 ▲▼]/[6 ▲▼] buttons.

**NOTE** Even when you are editing an existing Style, changing the Time Signature (BEAT) clears the data from all sections, and you will need to create the Style from scratch.

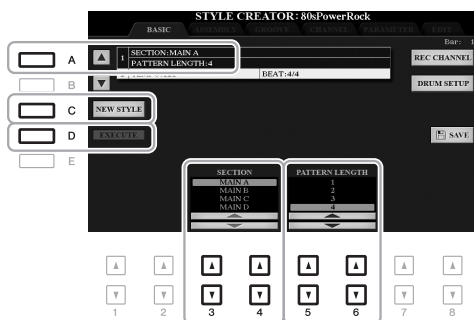

**4** Create the Source Pattern for each channel.

- **Realtime Recording on the BASIC page (page 126)**  
Lets you record the Style by simply playing the keyboard.
- **Step Recording on the EDIT page (page 130)**  
Lets you enter each note individually.
- **Style Assembly on the ASSEMBLY page (page 130)**  
Lets you copy various patterns from other preset Styles or Styles you have already created.

**5** Edit the already recorded channel data.

- **Editing the channel data on the GROOVE (page 132), CHANNEL (page 134), and EDIT (page 130) pages**  
Lets you change the rhythmic feel, quantizing and velocity, etc.
- **Editing the SFF parameters on the PARAMETER page (page 135)**  
Lets you edit the SFF (Style File Format) related parameters of the already recorded channels.
- **Editing the rhythm part on the BASIC page by using the Drum Setup function (page 140)**  
Lets you edit the rhythm part of the Style, such as changing the sounds of the individual instruments.

**6** Repeat steps 3–5 as desired.

**7** Press the [I] or [J] (SAVE) button on any of the pages to save the created Style.

For instructions, refer to page 28.

**NOTICE**

The created Style will be lost if you change to another Style or turn off the power to the instrument without carrying out the Save operation.

## Realtime Recording

In the BASIC page, you can record your original rhythm pattern from the keyboard.

### Realtime Recording Characteristics in the Style Creator

#### • Loop Recording

Style playback repeats the rhythm patterns of several measures in a “loop,” and Style recording is also done using loops. For example, if you start recording with a two-measure MAIN section, the two measures are repeatedly recorded. Notes that you record will play back from the next repetition (loop), letting you record while hearing previously recorded material.

#### • Overdub Recording

This method records new material to a channel already containing recorded data, without deleting the original data. In Style recording, the recorded data is not deleted, except when using functions such as Rhythm Clear (page 127) and Delete (pages 127, 129). For example, if you start recording with a two-measure MAIN section, the two measures are repeated many times. Notes that you record will play back from the next repetition, letting you overdub new material to the loop while hearing previously recorded material. When creating a Style based on an existing internal Style, overdub recording is applied only to the rhythm channels. For all other channels (except rhythm), you need to delete the original data before recording.

### ■ Recording Rhythm Channels 1–2

The procedure below applies to step 4 in the Basic Procedure on page 125.

**1** From the BASIC page, while holding down the [F] (REC CHANNEL) button, press the [1 ▼] or [2 ▼] button to select the desired channel as the recording target.

A Rhythm channel can be selected as the recording target no matter whether already recorded data is included or not. If already recorded data is included in the selected channel, you can record notes additionally to the existing data.



## 2 If necessary, select a Voice then practice the rhythm pattern to be recorded.

Press the [1 ▲] or [2 ▲] button (selected channel) to call up the Voice Selection display then select the desired Voice such as a Drum Kit. After selecting, press the [EXIT] button to return to the original Style Creator display. With the selected Voice, practice the rhythm pattern to be recorded.

- **Available Voices for recording**

For the RHY1 channel, any except the Organ Flutes Voices can be used for recording.

For the RHY2 channel, only Drum/SFX Kits can be used for recording.

**NOTE** For information on which key to play for each Drum/SFX sound, refer to the "Drum/SFX Kit List" in the Data List on the website.

## 3 Press the STYLE CONTROL [START/STOP] button to start recording.

As the already recorded data plays back, use the [1 ▼]–[8 ▼] buttons to turn each channel on or off as desired. If necessary, you can delete channel data. While holding down the [J] (DELETE) button, press one of the [1 ▲]–[8 ▲] (desired channel) buttons.

## 4 As soon as loop playback returns to the first beat in the first measure, start playing the rhythm pattern to be recorded.

If the rhythm is difficult to play in real time, break it up into individual parts and play each separately as the playback loops, as shown in the example below.

The diagram illustrates three sequential loops of drum recording, each shown in a separate box with a downward arrow indicating the flow from one to the next.

- Loop 1st round:** Shows a single staff for Bass Drum with a rhythmic pattern of quarter notes.
- Loop 2nd round:** Shows two staves: Snare Drum and Bass Drum. The Snare Drum part has a rhythmic pattern of quarter notes, and the Bass Drum part has a rhythmic pattern of quarter notes.
- Loop 3rd round:** Shows three staves: Hi-Hat, Snare Drum, and Bass Drum. The Hi-Hat part has a rhythmic pattern of quarter notes, the Snare Drum part has a rhythmic pattern of quarter notes, and the Bass Drum part has a rhythmic pattern of quarter notes.

### Deleting mistakenly recorded notes (Rhythm Clear)

If you make a mistake or play any wrong notes, you can delete those specific notes. While holding down the [E] (RHY CLEAR) button, press the corresponding key on the keyboard.

## 5 Press the [START/STOP] button to stop playback.

If you want to add more notes, press the [START/STOP] button again to continue recording.

## 6 Press the appropriate [1 ▼] or [2 ▼] button to disable recording.

### **NOTICE**

The created Style will be lost if you change to another Style or turn off the power to the instrument without carrying out the Save operation (step 7 on page 126).

## ■ Recording to the Bass, Chord 1–2, Pad and Phrase 1–2 Channels

The procedure below applies to step 4 in the Basic Procedure on page 125.

### 1 From the BASIC page, while holding down the [F] (REC CHANNEL) button, press one of the [3 ▼]–[8 ▼] buttons to select the desired channel as the recording target.

If a preset Style is selected, a confirmation message appears, prompting you whether or not to delete the already recorded data of the selected channel. Press the [G] (YES) button to delete data and the selected channel is specified as the recording target. Note that channel data other than the Rhythm channels of the preset Style cannot be overdubbed.



### 2 If necessary, select a Voice then practice the bass line, chord backing, or phrase to be recorded.

Press one of the [3 ▲]–[8 ▲] buttons (selected channel) to call up the Voice Selection display then select the desired Voice. After selecting, press the [EXIT] button to return to the original display. With the selected Voice, practice the phrase or chord backing to be recorded.

#### • Available Voices for recording

Any except for the Organ Flutes Voice/Drum Kit/SFX kit Voices can be used for recording.

#### • Record a phrase in CM7 (for playing appropriate notes while chords change during performance)

##### Rules when recording a Main or Fill

With the default initial settings, the Source Root/Chord (page 136) is set to CM7. This means that you should record a Source Pattern using a CM7 scale, which will change according to the chords you specify during normal performance. Record a bass line, phrase or chord backing which you want to hear when CM7 is specified. See below for details.

- Use only the CM7 scale tones when recording the BASS and PHRASE channels (i.e., C, D, E, G, A, and B).
- Use only the chord tones when recording the CHORD and PAD channels (i.e., C, E, G, and B).

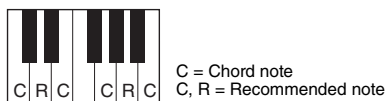

If you observe this rule, Style playback notes are appropriately converted depending on the chord changes you make during your performance.

##### Rules when recording an Intro or Ending

These Sections are designed assuming that the chord is not changed during playback. This is why you need not observe the rule for Main and Fill-in Sections described above, and you can create special chord progressions when recording. However, follow the rules below since the Source Root/Chord is set to CM7.

- When recording the Intro, make sure that the recorded phrase leads properly into a C scale.
- When recording the Ending, make sure that the recorded phrase begins with or properly follows a C scale.



- **Set the Source Root/Chord if necessary**

Although the Source Root/Chord is set to CM7 as described above, you can change this to any desired key or chord. Use the TAB [◀][▶] buttons to call up the PARAMETER page, and set the PLAY ROOT and CHORD to the favorite or desired Root and Chord type. Keep in mind that when you change the Source Chord from the default CM7 to another chord, the chord notes and recommended notes will also change. For details, refer to page 136.

### 3 Press the STYLE CONTROL [START/STOP] button to start recording.

Since already recorded data plays back, use the [1 ▼]–[8 ▼] buttons to turn on or off each channel as desired. If necessary, you can delete channel data. While holding down the [J] (DELETE) button, press one of the [1 ▲]–[8 ▲] (desired channel) buttons.

### 4 As soon as loop playback returns to the first beat in the first measure, start playing the bass line, chord backing or phrase to be recorded.

### 5 Press the [START/STOP] button to stop playback.

If you want to add more notes, press the [START/STOP] button again to continue recording.

- **To hear the playback sound of the already recorded channels with another Source Root/Chord:**

- 1) Use the TAB [◀][▶] buttons to call up the PARAMETER page.
- 2) Press the [F] (REC CHANNEL) button to call up the RECORD display, then use the [1 ▼]–[8 ▼] buttons to turn the desired channel ON/OFF.
- 3) Press the STYLE CONTROL [START/STOP] button to start playback.
- 4) On the PARAMETER page, set the PLAY ROOT and CHORD to the desired Chord root and Chord type.

The above operation lets you hear how the Source Pattern is played back via chord changes during normal performance.

### 6 Press the appropriate [3 ▼]–[8 ▼] button to disable recording.

#### **NOTICE**

The created Style will be lost if you change to another Style or turn off the power to the instrument without carrying out the Save operation (step 7 on page 126).

## Step Recording (EDIT)

This section applies to step 4 of the Basic Procedure on page 125. After selecting a Section and make other settings on the BASIC page, call up the STEP RECORD display via the instructions below, then carry out Step Recording.

- 1) From the BASIC page, while holding down the [F] (REC CHANNEL) button, press one of the [1 ▼]–[8 ▼] buttons to select the desired channel as the recording target.
- 2) Use the TAB [▶] button to call up the EDIT page.
- 3) If “SYS/EX.” is shown at the position corresponding to the [F] button, press the [F] button to call up the Channel Edit display.
- 4) Press the [G] (STEP REC) button to call up the STEP RECORD display.

The Step Recording procedure in the Style Creator is essentially same as that in Song Creator (pages 152–155), with the exception of the following points:

- Unlike in Song Creator, the “End” mark position cannot be changed in the Style Creator. This is because setting the Pattern Length on the BASIC page determines the “End” mark position. For example, if you select a Section of four measures or you set the Pattern Length to “4” on the BASIC page, the “End” mark position is automatically set to the end of the fourth measure, and cannot be changed.
- Unlike in Song Creator, a Recording channel can be set on the BASIC page. It cannot be set on the EDIT page.
- Unlike in Song Creator, Chord and Lyrics data cannot be entered. This is because such data is not necessary for Style playback.

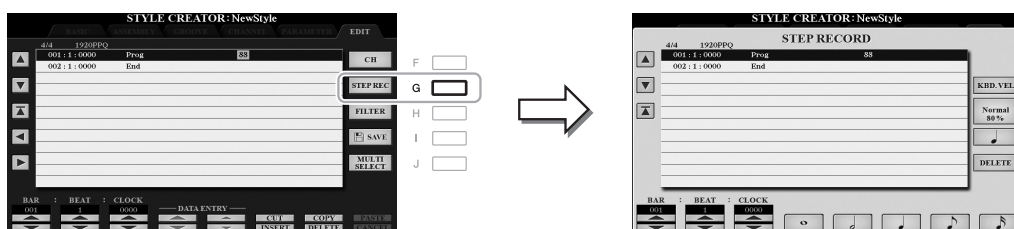

For instructions on Step Recording, refer to pages 152–155. For information on the EDIT page (called as Event List display in Song Creator), refer to page 165.

## Style Assembly (ASSEMBLY)

This allows you to copy channel data as a Source Pattern from another preset Style to the currently created Style. Use this function if you find a favorite rhythm pattern, bass line, chord backing or phrase from another Style. The instructions below apply to step 4 of the Basic Procedure on page 125. After selecting a Section and make other settings on the BASIC page, carry out the instructions below.

### 1 Call up the operation display.

[FUNCTION] → TAB [▶] MENU 2 → [A] STYLE CREATOR → TAB [◀][▶] ASSEMBLY

### 2 If necessary, select the Section to be edited.

Even if the Section to be edited has already been selected on the BASIC page, you can change the Section also on this page. Press the desired Section button on the panel to call up the SECTION window, then press the [8 ▲] (OK) button to actually enter the selection. If you want to select a fill-in section (which has no panel button), press any one of the Section buttons and use the [6 ▲▼]/[7 ▲▼] buttons to select a fill-in, then press the [8 ▲] (OK) button.

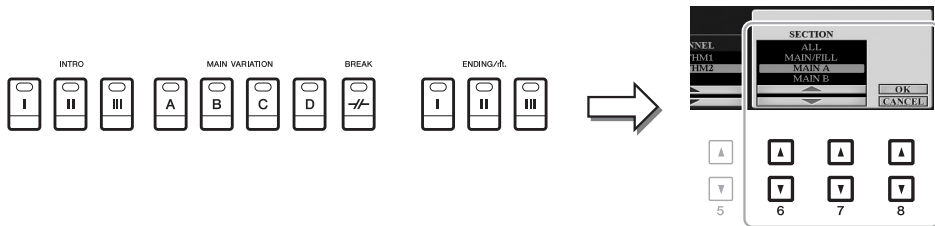

**NOTE** Intro 4 and Ending 4 can be selected on the display then created as your original Style although they are not available on the panel.

### 3 Replace the Source Pattern of the specific channel with that of another Style.

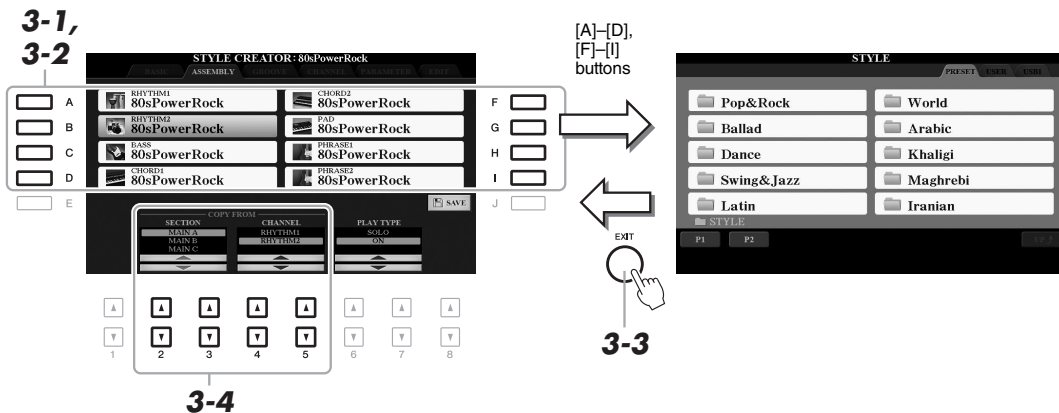

- 3-1** Select the desired channel to be replaced via the [A]–[D] and [F]–[I] buttons.
- 3-2** Press the same button of the selected channel to call up the Style Selection display.
- 3-3** Select the desired Style, then press the [EXIT] button to return to the original display.
- 3-4** Select the Section and Channel of the selected Style via the [2 ▲▼]–[5 ▲▼] buttons.
- 3-5** Confirm the sound with the newly assigned Source Pattern by pressing the STYLE CONTROL [START/STOP] button to play back the Style.

#### Playing the Style During Style Assembly

You can play back the Style while you are assembling a Style, and the playback method can be selected. In the ASSEMBLY page, use the [6 ▲▼]/[7 ▲▼] (PLAY TYPE) buttons to select the type.

- **SOLO:** Plays back the selected channel in the ASSEMBLY page. Any channels set to REC in the RECORD display on the BASIC page are played back simultaneously.
- **ON:** Plays back the selected channel in the ASSEMBLY page. Any channels set to other than OFF in the RECORD display on the BASIC page are played back simultaneously.
- **OFF:** Mutes the selected channel in the ASSEMBLY page.

### 4 As desired, repeat step 3 for another channel.

#### NOTICE

The created Style will be lost if you change to another Style or turn off the power to the instrument without carrying out the Save operation (step 7 on page 126).

## Editing the Rhythmic Feel (GROOVE)

By changing the timing of all the notes and velocities, you can edit the rhythmic feel for each channel of the current Section selected on the BASIC page or the panel button. The instructions below apply to step 5 of the Basic Procedure on page 125.



- In the GROOVE page, use the [A]/[B] buttons to select the edit menu, then edit the data by using the [1 ▲▼]–[8 ▲▼] buttons.

### 1 GROOVE

This lets you add swing to the music or change the “feel” of the beat by making subtle shifts in the timing (clock) of the Style. The Groove settings are applied to all channels of the Section selected on the BASIC page.

[1 ▲▼]/ [2 ▲▼]	ORIGINAL BEAT	Specifies the beats to which Groove timing is to be applied. In other words, if “8 BEAT” is selected, Groove timing is applied to 8th notes; if “12 BEAT” is selected, Groove timing is applied to 8th-note triplets.
[3 ▲▼]/ [4 ▲▼]	BEAT CONVERTER	Actually changes the timing of the beats (specified in the ORIGINAL BEAT parameter above) to the selected value. For example, when ORIGINAL BEAT is set to “8 BEAT” and BEAT CONVERTER is set to “12,” all 8th notes in the section are shifted to 8th-note triplet timing. The “16A” and “16B” Beat Converter which appear when ORIGINAL BEAT is set to “12 BEAT” are variations on a basic 16th-note setting.
[5 ▲▼]/ [6 ▲▼]	SWING	Produces a “swing” feel by shifting the timing of the back beats, depending on the ORIGINAL BEAT parameter above. For example, if the specified ORIGINAL BEAT value is “8 BEAT”, the Swing parameter will selectively delay the 2nd, 4th, 6th, and 8th beats of each measure to create a swing feel. The settings “A” through “E” produce different degrees of swing, with “A” being the most subtle and “E” being the most pronounced.
[7 ▲▼]/ [8 ▲▼]	FINE	Selects a variety of Groove “templates” to be applied to the selected section. The “PUSH” settings cause certain beats to be played early, while “HEAVY” settings delay the timing of certain beats. The numbered settings (2, 3, 4, 5) determine which beats are to be affected. All beats up to the specified beat—but not including the first beat—will be played early or delayed (for example, the 2nd and 3rd beats, if “3” is selected). In all cases, “A” types produce minimum effect, “B” types produce medium effect, and “C” types produce maximum effect.

## 2 DYNAMICS

This changes the velocity/volume (or accent) of certain notes in the Style playback. The Dynamics settings are applied to each channel or all channels of the Section selected on the BASIC page.

[1 ▲▼]/ [2 ▲▼]	CHANNEL	Selects the desired channel (part) to which Dynamics is to be applied. The selected channel is shown at the upper left of the display.
[3 ▲▼]/ [4 ▲▼]	ACCENT TYPE	Determines the type of accent applied—in other words, which notes in the part(s) are emphasized with the Dynamics settings.
[6 ▲▼]	STRENGTH	Determines how strongly the selected Accent Type (above) will be applied. The higher the value, the stronger the effect.
[7 ▲▼]	EXPAND/CMP.	Expands or compresses the range of velocity values. Values higher than 100% expand the dynamic range, while values lower than 100% compress it.
[8 ▲▼]	BOOST/CUT	Boosts or cuts all velocity values in the selected section/channel. Values above 100% boost the overall velocity, while values below 100% reduce it.

## 2 Press the [D] (EXECUTE) button to actually enter the edits for each display.

The values which are shown in the STRENGTH, EXPAND/CMP. and BOOST/CUT parameters are expressed as a percentage of the last set value.

After the operation is completed, this button changes to “UNDO,” letting you restore the original data if you are not satisfied with the Groove or Dynamics results. The Undo function only has one level; only the previous operation can be undone.

### **NOTICE**

The edited Style will be lost if you change to another Style or turn off the power to the instrument without carrying out the Save operation (step 7 on page 126).

## Editing Data for Each Channel (CHANNEL)

You can edit recorded data for each channel of the current Section selected on the BASIC page or via the panel buttons. The instructions below apply to step 5 of the Basic Procedure on page 125.

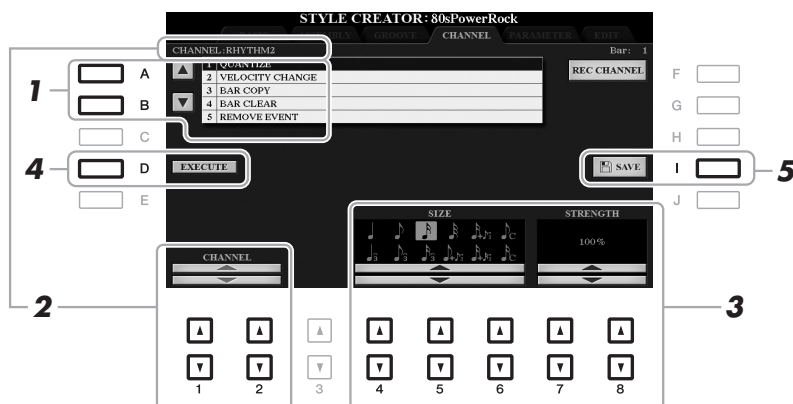

### 1 In the CHANNEL page, use the [A]/[B] buttons to select the edit menu.

#### 1 QUANTIZE

Same as in the Song Creator (page 163), with the exception of the two additional available parameters below.

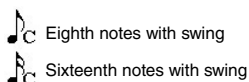

#### 2 VELOCITY CHANGE

Boosts or cuts the velocity of all notes in the specified channel, according to the percentage specified here.

#### 3 BAR COPY

This function allows data to be copied from one measure or group of measures to another location within the specified channel.

[4 ▲▼]	TOP	Specifies the first (TOP) and last (LAST) measures in the region to be copied.
[5 ▲▼]	LAST	
[6 ▲▼]	DEST	Specifies the first measure of the destination location, to which the data is to be copied.

#### 4 BAR CLEAR

This function clears all data from the specified range of measures within the selected channel.

#### 5 REMOVE EVENT

This function lets you remove specific events from the selected channel.

### 2 Use the [1 ▲▼]/[2 ▲▼] (CHANNEL) buttons to select the channel to be edited.

The selected channel is shown at the upper left of the display.

### 3 Use the [4 ▲▼]–[8 ▲▼] buttons to edit the data.

### 4 Press the [D] (EXECUTE) button to actually enter the edits for each display.

After the operation is completed, this button changes to “UNDO,” letting you restore the original data if you are not satisfied with the results of the edit. The Undo function only has one level; only the previous operation can be undone.

#### **NOTICE**

The edited Style will be lost if you change to another Style or turn off the power to the instrument without carrying out the Save operation (step 7 on page 126).

## Making Style File Format Settings (PARAMETER)

The Style File Format (SFF) combines all of Yamaha's auto accompaniment (Style playback) know-how into a single unified format. Setting the SFF related parameters determines how the original notes are converted to the actual sounded notes based on the chord you specify in the Chord area of the keyboard. The conversion flow is shown below.

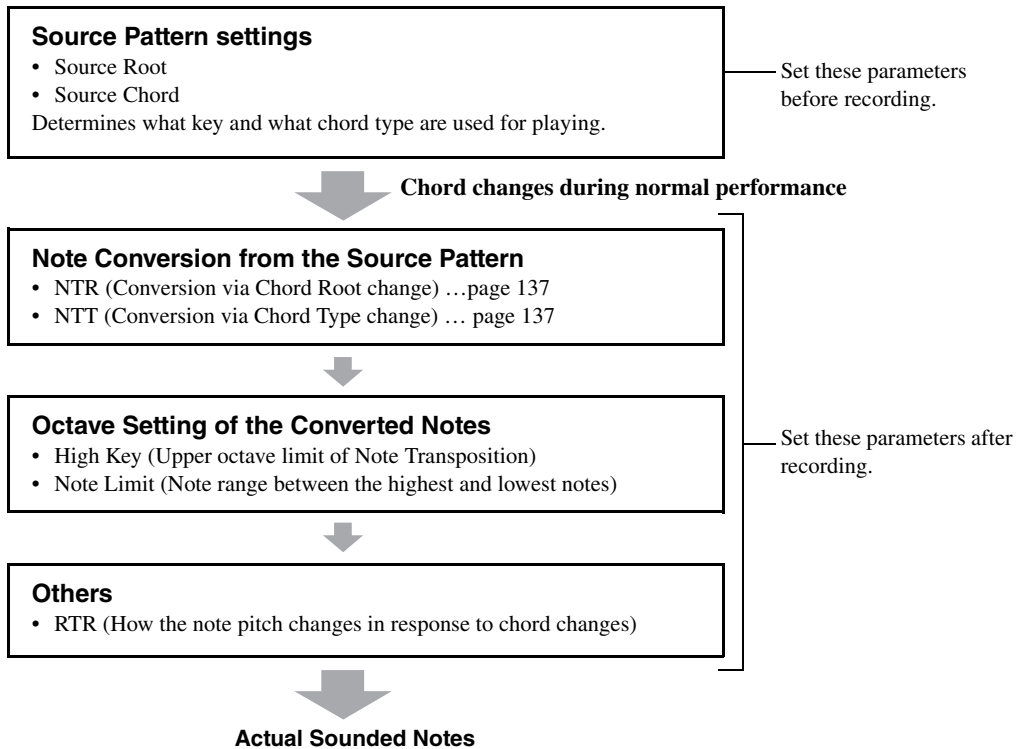

The instructions below apply to step 5 of the Basic Procedure on page 125.

**NOTE** The parameters you can set here are compatible with the SFF GE format. This is why the Style files created on this instrument can be played back only on instruments which are compatible with SFF GE.

### 1 In the PARAMETER page, use the [A]/[B] buttons to select the edit menu.

For details of the edit menu, see pages 136–139.



## 2 Use the [1 ▲▼]/[2 ▲▼] (CHANNEL) buttons to select the channel to be edited.

The selected channel is shown at the upper left of the display.

## 3 Use the [3 ▲▼]–[8 ▲▼] buttons to edit the data.

For details on editable parameters, see pages 136–139.

### **NOTICE**

The edited Style will be lost if you change to another Style or turn off the power to the instrument without carrying out the Save operation (step 7 on page 126).

## 1 SOURCE (PLAY) ROOT/CHORD

### **IMPORTANT**

The parameters here should be set before recording. If you change the settings after recording, the appropriate note conversion cannot be done even when you specify various chord types.

Before recording, you should set these parameters which determine what key is used for playing when you record the Source Pattern to the Bass, Chord, Pad or Phrase channel. If you set this to “Fm7,” your recorded original phrase (Source Pattern) will be triggered by specifying Fm7 during normal performance. CM7 (Source Chord Root = C and Source Chord Type = M7) is set by default. Depending on the settings here, the playable notes (chord notes and recommended scale notes) will differ. For details, see below.

### When the Source Root is C:

 C R C C R	 C R C C C R	 C R C C R C	 C R C C C R C	 C C C C C R	 C C C C C R C	 C C C C C R C
 C R C R C R	 C R R C C	 C R R C C	 C R R C C	 C R R C C	 C C R R C C	 C C R R C C
 C R C C C C	 C R R C C C	 C C R R C C	 C R R C C	 C R R C C	 C C C C C	 C C C C C
 C R C C C	 C C C C C C	 C R C C C R	 C R C C C C	 C C C C C C	 C R C C C C	 C C C R C C
 C R C R R C	 C R C R R C	 C C C C C	 C C C C C	 C R C C C	 C C R C C	

C = Chord notes

C, R = Recommended notes

**NOTE** When the parameters for the selected channel are set to NTR: ROOT FIXED, NTT: BYPASS, and NTT BASS: OFF, the parameters here are changed to “PLAY ROOT” instead of “SOURCE ROOT.” In this case, you can hear the resulting sound while you change the Chord Root/Type during playback.

**NOTE** The settings here are not applied when NTR is set to GUITAR.



## 2 NTR/NTT

The settings here determine how the original notes of the Source Pattern are converted in response to the Chord change during normal performance.

[3 ▲▼]/ [4 ▲▼]	NTR (Note Transposition Rule)	Determines the relative position of the root note in the chord, when converted from the Source Pattern in response to chord changes. Refer to the list below.
[5 ▲▼]- [7 ▲▼]	NTT (Note Transposition Table)	Sets the note transposition table for the source pattern. Refer to the list below.
[8 ▲▼]	NTT BASS ON/ OFF	The channel for which this is set to ON will be played back by the bass root note, when the on-bass chord is recognized by the instrument. When NTR is set to GUITAR and this parameter is set to ON, only the note which is assigned to bass will be played back by the bass root note.

**NOTE** Since the Rhythm channels should not be affected by chord changes, make sure that the parameters are set to NTR: ROOT FIXED, NTT: BYPASS, and NTT BASS: OFF. In this case, "SOURCE ROOT" is changed to "PLAY ROOT."

### NTR (Note Transposition Rule)

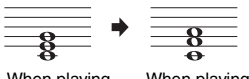
ROOT TRANS (Root Transpose)	When the root note is transposed, the interval between notes is maintained. For example, the notes C3, E3 and G3 in the key of C become F3, A3 and C4 when they are transposed to F. Use this setting for channels that contain melody lines.	 <p>When playing a C major chord. → When playing an F major chord.</p>
ROOT FIXED	The note is kept as close as possible to the previous note range. For example, the notes C3, E3 and G3 in the key of C become C3, F3 and A3 when they are transposed to F. Use this setting for channels that contain chord parts.	 <p>When playing a C major chord. → When playing an F major chord.</p>
GUITAR	This is exclusively for transposing guitar accompaniment. Notes are transposed to approximate the chords played with natural guitar fingering.	

### NTT (Note Transposition Table)

When NTR is set to ROOT TRANS or ROOT FIXED

BYPASS	When NTR is set to ROOT FIXED, the transposition table used does not do any note conversion. When NTR is set to ROOT TRANS, the table used only converts the notes by maintaining the pitch relationship between notes.
MELODY	Suitable for melody line transposition. Use this for melody channels such as Phrase 1 and Phrase 2.
CHORD	Suitable for chordal parts transposition. Use this for the Chord 1 and Chord 2 channels, especially when they contain piano or guitar-like chordal parts.
MELODIC MINOR	When the played chord changes from a major to a minor chord, this table lowers the third interval in the scale by a semitone. When the chord changes from a minor to a major chord, the minor third interval is raised by a semitone. Other notes are not changed. Use this for melody channels of Sections which respond only to major/minor chords, such as Intros and Endings.
MELODIC MINOR 5th	In addition to the Melodic Minor transposition above, augmented and diminished chords affect the 5th note of the Source Pattern.

HARMONIC MINOR	When the played chord changes from a major to a minor chord, this table lowers the third and sixth intervals in the scale by a semitone. When the chord changes from a minor to a major chord, the minor third and flatted sixth intervals are raised by a semitone. Other notes are not changed. Use this for chord channels of Sections which respond only to major/minor chords, such as Intros and Endings.
HARMONIC MINOR 5th	In addition to the Harmonic Minor transposition above, augmented and diminished chords affect the 5th note of the Source pattern.
NATURAL MINOR	When the played chord changes from a major to a minor chord, this table lowers the third, sixth and seventh intervals in the scale by a semitone. When the chord changes from a minor to a major chord, the minor third, flatted sixth and flatted seventh intervals are raised by a semitone. Other notes are not changed. Use this for chord channels of Sections which respond only to major/minor chords such as in Intros and Endings.
NATURAL MINOR 5th	In addition to the Natural Minor transposition above, augmented and diminished chords affect the 5th note of the Source pattern.
DORIAN	When the played chord changes from a major to a minor chord, this table lowers the third and seventh intervals in the scale by a semitone. When the chord changes from a minor to a major chord, the minor third and flatted seventh intervals are raised by a semitone. Other notes are not changed. Use this for chord channels of Sections which respond only to major/minor chords such as in Intros and Endings.
DORIAN 5th	In addition to the Dorian transposition above, augmented and diminished chords affect the 5th note of the Source pattern.

When NTR is set to GUITAR

ALL-PURPOSE	This table covers both stroke- and arpeggio-played sounds.
STROKE	Suitable for strumming sounds of the guitar. Some notes may sound as if they are muted—this is the normal condition when chords are played on guitar by strumming.
ARPEGGIO	Suitable for arpeggio-played sound of the guitar, resulting in beautiful four-note arpeggio sounds.

### 3 HIGH KEY / NOTE LIMIT

The settings here adjust the Octave of the notes converted from the original ones through NTT and NTR.

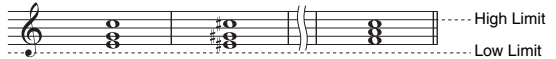
[4 ▲▼]/ [5 ▲▼]	HIGH KEY	<p>This sets the highest key (upper octave limit) of the note transposition for the chord root change. Any notes calculated to be higher than the highest key are transposed down to the next lowest octave. This setting is available only when the NTR parameter (page 137) is set to “Root Trans.”</p> <p><b>Example—When the highest key is F.</b></p> <p>Root changes → CM      C#M . . . FM      F#M . . .</p> <p>Notes played → C3-E3-G3    C#3-E#3-G#3      F3-A3-C4      F#2-A#2-C#3</p> 
[6 ▲▼]	NOTE LIMIT LOW	<p>These set the note range (highest and lowest notes) for Voices recorded to the Style channels. By judicious setting of this range, you can ensure that the Voices sound as realistic as possible—in other words, that no notes outside the natural range are sounded (e.g., high bass sounds or low piccolo sounds).</p> <p><b>Example—When the lowest note is C3 and the highest is D4.</b></p> <p>Root changes → CM      C#M . . . FM . . .</p> <p>Notes played → E3-G3-C4    E#3-G#3-C#4      F3-A3-C4</p> 
[7 ▲▼]	NOTE LIMIT HIGH	

### 4 RTR (Retrigger Rule)

These settings determine whether notes stop sounding or not and how they change pitch in response to chord changes.

STOP	The notes stop sounding.
PITCH SHIFT	The pitch of the note will bend without a new attack to match the type of the new chord.
PITCH SHIFT TO ROOT	The pitch of the note will bend without a new attack to match the root of the new chord. However, the octave of the new note remains the same.
RETRIGGER	The note is retriggered with a new attack at a new pitch corresponding to the next chord.
RETRIGGER TO ROOT	The note is retriggered with a new attack at the root note of the next chord. However, the octave of the new note remains the same.

## Editing the Rhythm Part of a Style (Drum Setup)

The Drum Setup function allows you to edit the rhythm part of the current Style, such as changing the drum instruments and make various settings. The procedure below applies to step 5 in the Basic Procedure on page 125.

- From the **BASIC** page, while holding down the [F] (REC CHANNEL) button, press the [1 ▼] or [2 ▼] button to select the desired channel to be edited.

**NOTE** If the different drum sounds are assigned to each section of the selected channel, the sounds are set to that of the current section in order to use the Drum Setup function.

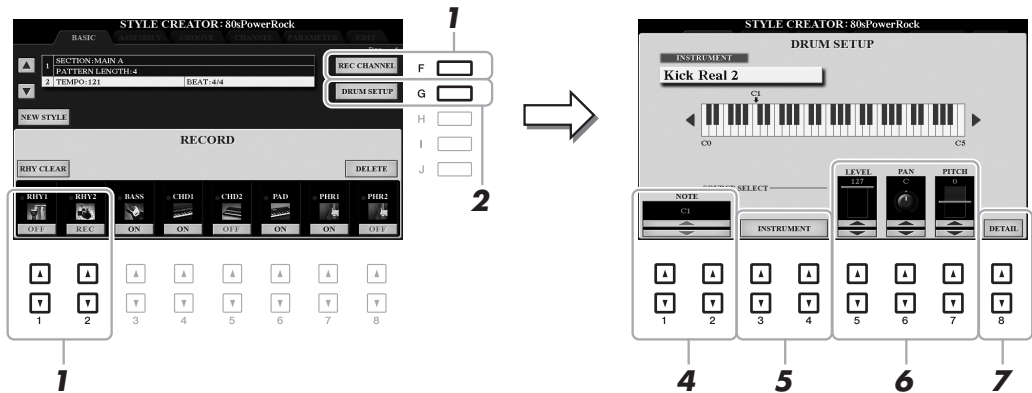

- Press the [G] (DRUM SETUP) button to call up the **DRUM SETUP** window.
- If necessary, press the **STYLE CONTROL [START/STOP]** button to start playback of the rhythm part.

The sounds played back are indicated on the display keyboard, letting you to check the note to edit.

- Use the [1 ▲▼]/[2 ▲▼] (**NOTE**) buttons to select the note to edit.

**NOTE** You can also select the note by pressing the note on the keyboard.

- Select the desired instrument to be used.

**5-1** Use the [3 ▲▼]/[4 ▲▼] (**INSTRUMENT**) buttons to call up the window to select the instrument.

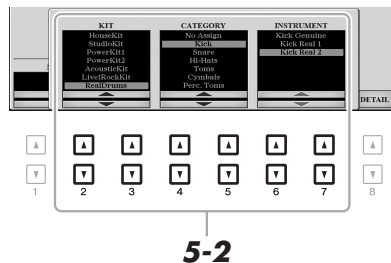

**5-2** Use the [2 ▲▼]–[7 ▲▼] buttons to select the Kit, Category and instrument in order.

**5-3** Press the [EXIT] button to close the window.

**6** If necessary, set the volume level, pan or pitch by using the [5 ▲▼]–[7 ▲▼] buttons.

**7** If necessary, make more detailed settings.

**7-1** Press the [8 ▲▼] (DETAIL) button to call up the detailed settings window.

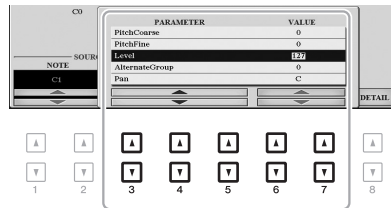

**7-2**

**7-2** Use the [3 ▲▼]–[5 ▲▼] buttons to select the parameter, then use the [6 ▲▼]/ [7 ▲▼] buttons to set the value.

The parameters with “\*” in the list below indicates that the settings here affect the settings in step 6.

Pitch Coarse*	For coarse tuning of the pitch in semitone increments.
Pitch Fine*	For fine tuning of the pitch in cent increments. <b>NOTE</b> In musical terms a “cent” is 1/100th of a semitone. (100 cents equal one semitone.)
Level*	For adjusting the volume level.
Alternate Group	Determines the Alternate Group. Any instruments in the same group number cannot sound at the same time. Playing any instrument within a numbered group will immediately stop the sound of any other instrument in the same group of the same number. If this is set to 0, the instruments in the group can sound at the same time.
Pan*	Determines the stereo position.
Reverb Send	For adjusting the reverb depth.
Chorus Send	For adjusting the chorus depth
Variation Send	For adjusting the variation effect (DSP1) depth. When the “Connection” parameter is set to “Insertion” on the Mixing Console display and this rhythm channel is selected as the assign part, this parameter affects as below. <ul style="list-style-type: none"> <li>• <b>When Variation Send is set to 0:</b> No effects are applied to the instrument (Insertion Off).</li> <li>• <b>When Variation Send is set to 1–127:</b> Effects are applied to the instrument (Insertion On).</li> </ul>
Key Assign	Determines the Key Assign mode. This parameter is effective only when the kit’s XG parameter “SAME NOTE NUMBER KEY ON ASSIGN” (see the Data List on the website) is set to “INST.” <ul style="list-style-type: none"> <li>• <b>Single:</b> Each successive playing of the same sound results in the previous being cut off or muted.</li> <li>• <b>Multi:</b> Each sound continues to its full decay, even when played successively multiple times.</li> </ul>
Rcv Note Off	Determines whether note-off messages are received or not.
Rcv Note On	Determines whether note-on messages are received or not.
Filter Cutoff	Determines the cutoff frequency or effective frequency range of the filter. Higher values result in a brighter sound.
Filter Resonance	Determines the emphasis given to the cutoff frequency (resonance), set in Filter Cutoff above. Higher values result in a more pronounced effect.

EG Attack	Determines how quickly the sound reaches its maximum level after the key is played. The higher the value, the quicker the attack.
EG Decay 1	Determines how quickly the sound reaches its sustain level (a slightly lower level than maximum). The higher the value, the quicker the decay.
EG Decay 2	Determines how quickly the sound decays to silence after the key is released. The higher the value, the quicker the decay.

**7-3** Press the [EXIT] button to close the window.

**8** Press the [EXIT] button to return to close the DRUM SETUP window.

**NOTICE**

The edited Style will be lost if you change to another Style or turn off the power to the instrument without carrying out the Save operation (step 7 on page 126).

## Editing Music Notation (Score) Settings

To view the music notation of the selected Song, press the [SCORE] button. You can change the Score display as desired to suit your personal preferences. The settings here are maintained even when the power is turned off.

**NOTE** You can save the settings here as a part of a Song by accessing [FUNCTION] → TAB [▶] MENU 2 → [B] SONG CREATOR → TAB [◀] [▶] SETUP. See page 158.

**NOTE** Depending on the particular commercially available Song, Score display may not be possible.

**NOTE** The score of an audio file cannot be shown because the score is created based only on MIDI events.

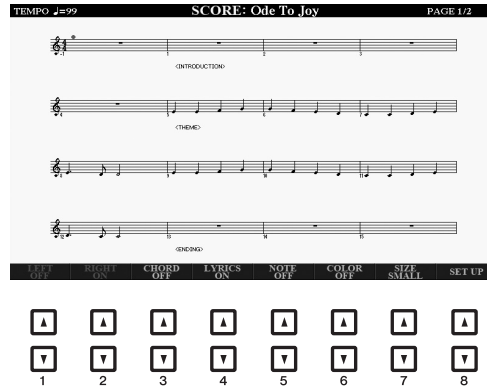

[1 ▲▼]	LEFT ON/OFF	Enables/disables display of the left-hand notation. Depending on other settings, this parameter may be unavailable and may appear grayed out. If this is the case, go to the detailed setting display (see below) and set the LEFT CH parameter to any channel except “AUTO.” Or, go to the display [FUNCTION] → TAB [◀] MENU 1 → [H] SONG SETTING → TAB [◀] GUIDE/CHANNEL and set the TRACK 2 parameter to any channel except “OFF” (page 147). RIGHT (next parameter) and LEFT cannot be turned off at the same time.
[2 ▲▼]	RIGHT ON/OFF	Enables/disables display of the right-hand notation. RIGHT and LEFT (above) cannot be turned off at the same time.
[3 ▲▼]	CHORD ON/OFF	Enables/disables display of the chords. If the selected Song does not contain chord data, chords are not displayed.
[4 ▲▼]	LYRICS ON/OFF	Enables/disables display of the lyrics. If the selected Song does not contain lyric data, lyrics are not displayed. When the Song contains Pedal events, pressing these buttons can display the Pedal events, instead of displaying Lyrics.
[5 ▲▼]	NOTE ON/OFF	Enables/disables display of the note name (pitch). The note name is indicated at the left of the note. When the space between the notes is too small, the indication may be moved to the top left of the note. When the Song contains Fingering events, pressing these buttons can display the fingering, instead of displaying note names.
[6 ▲▼]	COLOR ON/OFF	When this is set to ON, the notes in the display appear in color (C: red, D: yellow, E: green, F: orange, G: blue, A: purple, and B: gray).

[7 ▲▼]	SIZE	Determines the display zoom level of the notation.
[8 ▲▼]	SET UP	Calls up the detailed setting display. See below.

Pressing the [8 ▲▼] (SET UP) button calls up the detailed setting display. You can set the view type by using the [1 ▲▼]–[6 ▲▼] buttons, then press the [8 ▲] (OK) button.

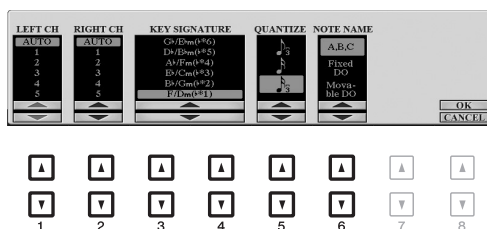

[1 ▲▼]	LEFT CH	Determines which MIDI channel in the Song data is used for the left-hand/ right-hand part. This setting returns to AUTO when a different Song is selected.  <b>AUTO:</b> The MIDI channels in the Song data for the right- and left-hand parts are assigned automatically—setting the parts to the same channel as the channel which is specified in the [FUNCTION] → TAB [◀] MENU 1 → [H] SONG SETTING → TAB [◀] GUIDE/CHANNEL (page 147).  <b>1–16:</b> Assigns the specified MIDI channel (1–16) to each of the left- and right-hand parts.  <b>OFF (Available setting only for LEFT CH):</b> Assigns no channel to the left-hand part. This disables display of the left-hand key range.
[2 ▲▼]	RIGHT CH	
[3 ▲▼]/ [4 ▲▼]	KEY SIGNATURE	This lets you enter key signature changes in the middle of a Song, at the stopped position. This menu is useful when the selected Song contains no key signature settings for displaying notation.
[5 ▲▼]	QUANTIZE	This gives you control over the note resolution in the notation, letting you shift or correct the timing of all displayed notes so that they line up to a particular note value. Make sure to select the smallest note value used in the Song.
[6 ▲▼]	NOTE NAME	Selects the type of the note name indicated at the left of the note in the notation from among the following three types. The settings here are available when the NOTE ON/OFF parameter above is set to ON.  <b>A, B, C:</b> Note names are indicated as letters (C, D, E, F, G, A, B).  <b>Fixed DO:</b> Note names are indicated in solfeggio, with the note of C fixed to DO. The notes “C, D, E, F, G, A, B” are always indicated as “Do, Re, Mi, Fa, So, La, Ti” when the language is set to English. Note that the note name indication differs depending on the current language (page 148).  <b>Movable DO:</b> Note names are indicated in solfeggio according to the key of the current Song. When a Song in the key of D Major is selected, for example, the notes “D, E, F#, G, A, B, C#” are indicated as “Do, Re, Mi, Fa, Sol, La, Ti” when the language is set to English. Note that the note name indication differs depending on the current language (page 148).



## Editing Lyrics/Text Display Settings

To view the lyrics of the selected Song or the text, press the [LYRICS/TEXT] button. You can change the Lyrics/Text display settings, such as background color, as desired.

**NOTE** When the lyrics are garbled or unreadable, you may need to change the Lyrics Language setting from the [FUNCTION] → TAB [◀] MENU 1 → [H] SONG SETTING → TAB [▶] OTHERS (page 148).

**NOTE** When you create a text file on a computer, make sure to enter line breaks manually. This is necessary because the auto line breaks cannot be entered on this instrument. If a sentence extends beyond the display and cannot be shown properly, revise the text data by manually entering appropriate line breaks.

### Lyrics display

The lyrics in the Song data are shown.



Press [1 ▲▼] buttons



### Text display

The texts created on a computer are shown.



Press the [5 ▲▼]/[6 ▲▼] button to actually call up desired text file.

[1 ▲▼]	TEXT/LYRICS	Switches the screen between the Lyrics display (lyrics data in the Song is shown) and the Text display (a text file selected via the [5 ▲▼]/[6 ▲▼] buttons).
[2 ▲▼]	CLEAR (only when a text file is selected)	Clears the text from the display. This operation does not delete the text file itself, but results in no text file being selected. If you want to restore the text indication, select the text file again via the [5 ▲▼]/[6 ▲▼] buttons.
[3 ▲▼]/ [4 ▲▼]	FIXED-16–28, PROPORTIONAL- 16–28 (only when a text file is selected)	Determines the text type (fixed or proportional) and font size. Fixed is suitable for displaying lyrics with chord names, since the positions of chord names are “fixed” to the corresponding lyrics. Proportional is suitable for displaying lyrics without chord names or explanatory notes. The numbers 16–28 indicate font sizes.
[5 ▲▼]/ [6 ▲▼]	TEXT FILES	Calls up the text File Selection display. After selecting, press the [EXIT] button to return back to the Lyrics/Text display.
[7 ▲▼]/ [8 ▲▼]	BACKGROUND	Allows changing of the background picture of the Lyrics/Text display. After making the setting, press the [EXIT] button to return back to the Lyrics/Text display.  <b>NOTE</b> When the background picture is specified in the Song data, the BACKGROUND setting cannot be changed.  <b>NOTE</b> For information on available image files, refer to the MAIN PICTURE parameter on page 206.

## Using the Auto Accompaniment Features with Song Playback

When playing back a Song and a Style at the same time, channels 9-16 in the Song data are replaced with Style channels—allowing you to play the accompaniment parts of the Song yourself. Try playing chords along with the Song playback as shown in the instructions below.

- 1 Select a Song.**
- 2 Select a Style.**
- 3 While holding down the SONG [■] (STOP) button, press the [▶/■] (PLAY/PAUSE) button to enable synchronized start of the Song.**

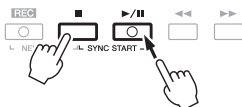

- 4 Press the STYLE CONTROL [ACMP] button to turn on the auto accompaniment function, then press the [SYNC START] button to enable synchronized start of the accompaniment.**

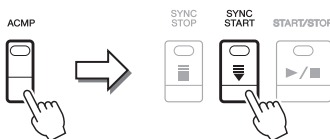

- 5 Press the STYLE CONTROL [START/STOP] button or play chords in the chord section.**

The Song and Style starts playing. When you play chords, pressing the [SCORE] button and turning CHORD on (page 143) allows you to see the chord information.

**NOTE** When playing back a Song and a Style at the same time, the tempo value set in the Song is automatically used.

**NOTE** The Style Retrigger function (page 112) cannot be used during Song playback.

When the Song playback is stopped, Style playback is also stopped at the same time.

## Song Playback Related Parameters (Guide Function, Channel settings, Repeat settings)

The instrument has a variety of Song playback functions—repeat playback, various guide settings, etc.—which can be accessed in the display below.

### Call up the operation display.

[FUNCTION] → TAB [◀] MENU 1 → [H] SONG SETTING → TAB[◀][▶] GUIDE/CHANNEL or OTHERS

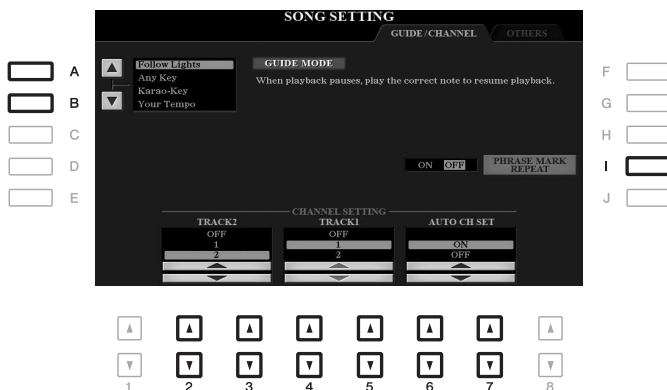

### ■GUIDE/CHANNEL Page

[A]/[B]	GUIDE MODE	See page 149.
[I]	PHRASE MARK REPEAT	This parameter is available only when the current Song contains Phrase Marks, which specify certain locations (of several measures each) in the Song. When this is set to ON, the section corresponding to the Phrase Mark (specified via the SONG [◀◀] (REW) and [▶▶] (FF) buttons) is played back repeatedly. Note that this parameter can be set only when the Song playback is stopped.
[2 ▲▼]/ [3 ▲▼]	TRACK 2	These parameters determine which MIDI channel in the Song data is assigned to the left- or right-hand part of the Guide function and the Song Score function. In addition, the setting here also determines which channels are assigned to the [TR1] (TRACK 1) and [TR2] (TRACK 2) buttons.
[4 ▲▼]/ [5 ▲▼]	TRACK 1	
[6 ▲▼]/ [7 ▲▼]	AUTO CH SET	When set to “ON,” this automatically sets the proper MIDI channels for the Right- and Left hand parts pre-programmed in the commercially available Song data. Normally, this should be set to “ON.”

## ■OTHERS Page

[G]	REPEAT MODE	<p>Determines the method of repeat playback.</p> <p><b>OFF:</b> Plays through the selected Song, then stops.</p> <p><b>SINGLE:</b> Plays through the selected Song repeatedly.</p> <p><b>ALL:</b> Continues playback through all the Songs in the specified folder repeatedly.</p> <p><b>RANDOM:</b> Continues playback at random through all the Songs in the specified folder repeatedly.</p>
[I]	FAST FORWARD TYPE	<p>Determines the fast forward type of when pressing [▶▶] (FF) button during Song playback.</p> <p><b>JUMP:</b> Pressing [▶▶] button once instantly sets the playback position to the next measure without sounding. Holding [▶▶] button scrolls forward continuously.</p> <p><b>SCRUB:</b> Pressing and holding [▶▶] plays and sounds the Song at high speed.</p>
[2 ▲▼]/ [3 ▲▼]	LYRICS LANGUAGE	<p>Determines the language displayed in the Lyrics display.</p> <p><b>AUTO:</b> When the language is specified in the Song data, the lyrics are displayed accordingly. When the language is not specified in the Song data, the lyrics language is regarded as INTERNATIONAL below.</p> <p><b>INTERNATIONAL:</b> Handles the displayed lyrics as a western language.</p> <p><b>JAPANESE:</b> Handles the displayed lyrics as Japanese.</p>
[4 ▲▼]/ [5 ▲▼]	QUICK START	<p>On some commercially available Song data, certain settings related to the Song (such as Voice selection, volume, etc.) are recorded to the first measure, before the actual note data. When Quick Start is set to “ON,” the instrument reads all initial non-note data of the Song at the highest possible speed, then automatically slows down to the appropriate tempo at the first note. This allows you to start playback as quickly as possible, with a minimum pause for reading of data.</p>
[6 ▲▼]/ [7 ▲▼]	P.A.T. (Performance Assistant Technology)	<p>See page 150.</p>

## Keyboard and Vocal Practice Using the Guide Function

With the Guide function, the instrument indicates the timing you need to play notes in the Score display for ease in learning. This instrument also features convenient vocal practice tools that let you adjust the timing of Song playback to match your vocal performance.

**1** Select the desired Song for practicing the keyboard or singing.

**2** Call up the setting display.

[FUNCTION] → TAB [◀] MENU 1 → [H] SONG SETTING → TAB[◀] GUIDE/CHANNEL

### 3 Use the [A]/[B] buttons to select the desired Guide mode.



#### Guide modes for keyboard practice

##### • Follow Lights

When this is selected, Song playback pauses, waiting for you to play the notes correctly. When you play the correct notes, Song playback continues. Follow Lights was developed for the Yamaha Clavinova series. This function is used for practicing purposes, with built-in lamps on the keyboard indicating the notes to be played. Even though the PSR-A3000 does not have these lamps, you can use the same function by following the indications in the displayed notation with the Song Score function.

##### • Any Key

With this function, you can play the melody of a Song just by pressing a single key (any key is OK) in time with the rhythm. Song playback pauses and waits for you to play any key. Simply play a key on the keyboard in time with the music and Song playback continues.

##### • Your Tempo

The same as Follow Lights, except that Song playback matches the speed at which you play.

#### Guide mode for singing

##### • Karao-Key

This function lets you control the Song playback timing with just one finger, while you sing along. This is useful for singing to your own performance. Song playback pauses, waiting for you to sing. Simply play any key on the keyboard (playing the keyboard produces no sound) and Song playback continues.

### 4 Turn the [GUIDE] button on.



### 5 Call up the Score display by pressing the [SCORE] button.

### 6 Press the SONG [▶/||] (PLAY/PAUSE) button to start playback.

Practice playing the keyboard or singing, along with the Guide mode selected in step 3.

### 7 Press the [■] (STOP) button to stop playback.

**NOTE** You can save the Guide settings as a part of the Song data (page 158). For Songs to which the Guide settings have been saved, the Guide function will be automatically turned on and the related settings will be recalled when the Song is selected.

## Playing Backing Parts with the Performance Assistant Technology

This feature lets you play your own backing parts on the keyboard along with Song playback, and have them sound perfectly appropriate (even though you might be playing wrong notes).

### 1 Select a Song containing chord data.

The Performance assistant technology is applied only to a Song containing chord data. To confirm whether the selected Song contains chord data or not, return to the Main display then start playback. If the current Song contains chord data, the Main display shows the current chord type. After stopping playback, go to the next step.

### 2 Call up the operation display.

[FUNCTION] → TAB [◀] MENU 1 → [H] SONG SETTING → TAB[▶] OTHERS

### 3 Use the [6 ▲]/[7 ▲] buttons to turn “P.A.T.” (performance assistant technology) on.

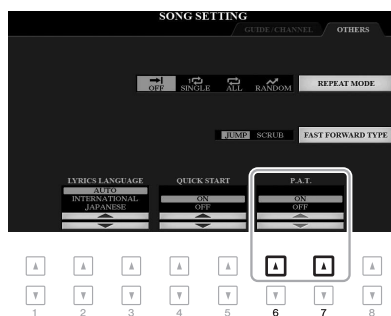

### 4 Press the SONG [▶/||] (PLAY/PAUSE) button to start playback.

### 5 Play the keyboard.

Along with Song playback, try playing the bass line with the left hand area while playing various phrases or chords with the right hand area. Even if you do not know what notes should be played, don't worry and play any keys as desired! Only the harmonically “correct” notes matching the current chord are sounded, regardless of the notes you actually play. The actual current chord is shown on the Main display.



### 6 Press the [■] (STOP) button to stop playback.

After you finish playing, make sure to turn P.A.T. off.

**NOTE** Selecting another Song resets P.A.T. to OFF.

# Creating/Editing Songs (Song Creator)

The Basic Operations section covers how to create an original Song by recording your keyboard performance (called “Realtime Recording”). This Advanced Features section shows how to create an original Song by entering notes one by one (called “Step Recording”) and how to improve an already created Song by editing the detailed parameters.

## ■ Realtime Recording and Step Recording

When creating a Song, these two Recording methods are available. With Realtime Recording, this instrument records the performance data as it is played. With Step Recording, you can compose your performance by “writing” it down one event at a time.

This chapter primarily covers the instructions for Step Recording.

## ■ Song Data Structure

A Song consists of 16 MIDI channels. You can create data of a Song by recording your performance to a specific channel or channels in realtime, or by executing the Step Recording.

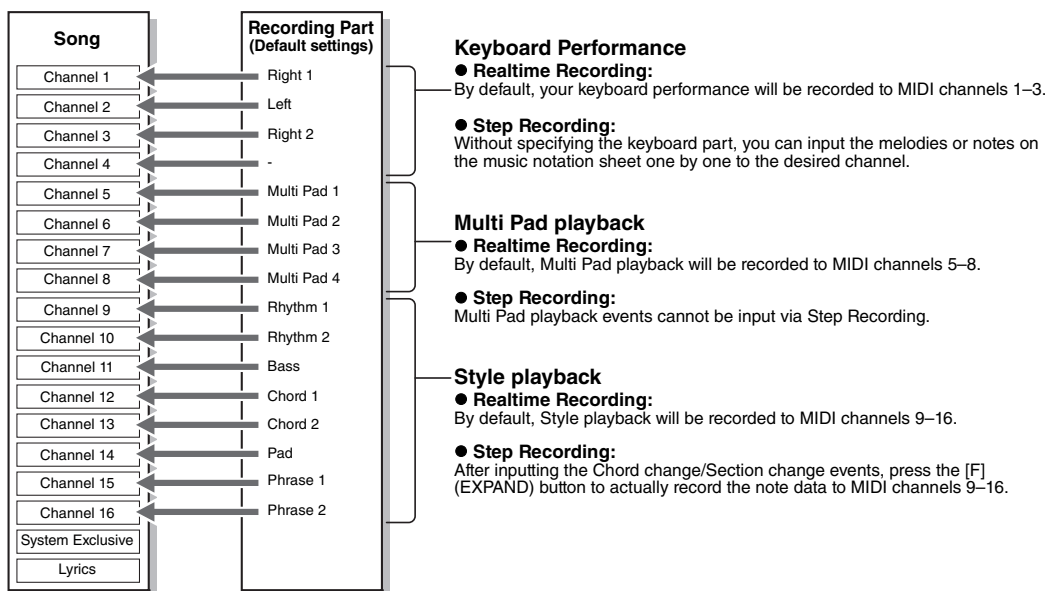

## ■ Song Creator Display Structure

The Song Creator display can be called up via [FUNCTION] → TAB [▶] MENU 2 → [B] SONG CREATOR

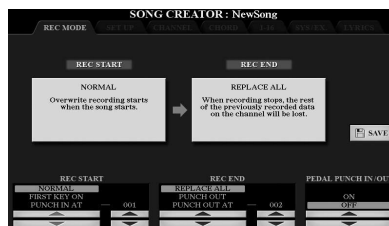

There are seven pages (tabs) in the Song Creator display.

- **REC MODE**..... For re-recording a Song. See page 159.
- **SETUP** ..... For selecting the panel setups to be recorded to the top position of the Song. See page 158.
- **CHANNEL**..... For editing Channel events. See page 162.
- **CHORD**..... For recording chords and Sections with precise timing (page 155) or editing them (page 165).

- **1-16**..... For recording melodies (Step Recording; see below) or editing the recorded melodies (page 165).
- **SYS/EX**..... For editing System Exclusive events (tempo, time signature, etc.). See page 165.
- **LYRICS**..... For inputting/editing a Song name and lyrics. See page 165.

## Recording Melodies (Step Recording)

### 1 Press the **SONG [REC]** and **SONG [■] (STOP)** buttons simultaneously.

A blank Song (“New Song”) is called up for recording.



### 2 Call up the operation display.

[FUNCTION] → TAB [▶] MENU 2 → [B] SONG CREATOR → TAB [◀][▶] 1-16



### 3 Press the [F] button to select the channel for recording.



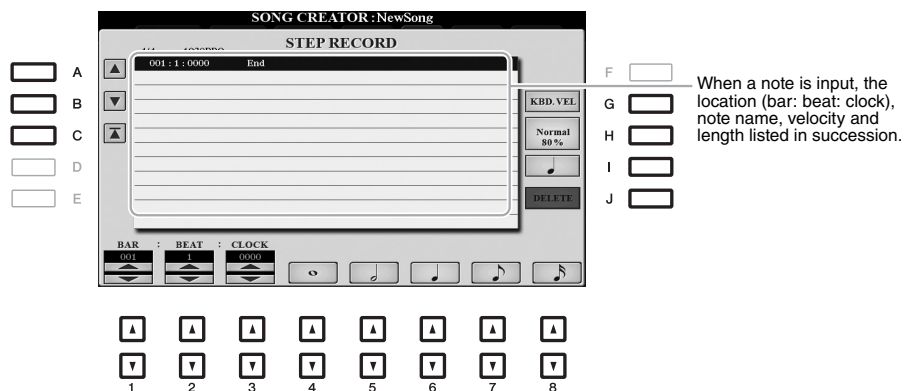

### 4 Press the [G] (STEP REC) button to call up the STEP RECORD display.

### 5 Start Step Recording by using the [A]–[J] buttons and [1 ▲▼]–[8 ▲▼] buttons, as well as the keyboard.

Refer to the example on page 154 for specific instructions.





[A]/[B]/ [C]		Moves the cursor in the list.
[G]		Determines the velocity (loudness) of the note to be entered. The velocity value can be specified within a range from 1 to 127. The higher the velocity value, the louder the actual sound.  <b>KBD.VEL:</b> Actual resulting velocity <b>fff:</b> 127 <b>ff:</b> 111 <b>f:</b> 95 <b>mf:</b> 79 <b>mp:</b> 63 <b>p:</b> 47 <b>pp:</b> 31 <b>ppp:</b> 15
[H]		Determines the gate time (actual length) of the note to be entered.  <b>Normal:</b> 80%  <b>Tenuto:</b> 99%  <b>Staccato:</b> 40%  <b>Staccatissimo:</b> 20%  <b>Manual:</b> The gate time can be set to any desired percentage by using the Data dial.
[I]		Determines the note type to be entered: normal, dotted or triplet.
[J]	DELETE	Deletes the data of the current line.
[1 ▲▼]	BAR	Sets the position of the note to be entered. Note that a quarter note has a resolution of 1,920 clocks.
[2 ▲▼]	BEAT	
[3 ▲▼]	CLOCK	
[4 ▲▼]- [8 ▲▼]		Determines the note length to be entered: whole-note, half-note, quarter-note, eighth-note or sixteenth-note.

- 6** Press the **SONG [■]** (STOP) button (or press the **[C]** button) to return to the top of the Song, then hear the newly entered Song by pressing the **[▶/■]** (PLAY/PAUSE) button.



- 7** Press the **[EXIT]** button to exit from the Step Recording display.

- 8** Press the **[I]** (SAVE) button to carry out the Save operation.

For details, refer to page 28.

**NOTICE**

The recorded Song data will be lost if you select another Song or turn off the power to the instrument without carrying out the Save operation.

## Example of Step Recording—Melodies (detailed instructions of step 5 on page 152)

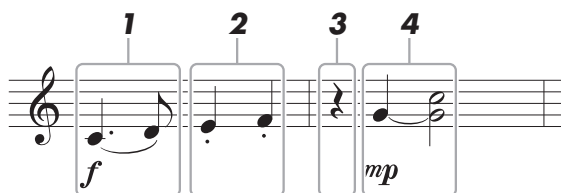

\* The numbers shown in the illustration correspond to the following operation step numbers.

In this example, keep in mind that one of the steps involves holding down a key on the keyboard while carrying out the operation.

Before carrying out the instructions below, select the desired Voice on the STEP RECORD display. Note that only the Voice selection and Note input operations are possible during Step Recording.

**NOTE** Since the actual note length (determined via the Gate Time) may differ from the note length on the notation, the Score of the Song recorded here may be different from the notation above.

### 1 Enter the first and second notes with a slur.

**1-1** Press the [G] button to select “f.”

**1-2** Press the [H] button to select “Tenuto.”

**1-3** Press the [I] button to select the “dotted” note type.

**1-4** Select the dotted quarter-note length by using the [6 ▲▼] buttons.

**1-5** Play the C3 key.

This enters the first note.

**1-6** Press the [I] button to select the “normal” note type.

**1-7** Press the [7 ▲▼] button to select the eight-note length.

**1-8** Play the D3 key.

This enters the second note.

### 2 Enter the next notes and apply staccato.

**2-1** Press the [H] button to select “Staccato.”

**2-2** Press the [6 ▲▼] button to select the quarter-note length.

**2-3** Play the keys E3 and F3 in order.

This completes the first measure.

### 3 To enter a quarter-note rest, press the [6 ▲▼] button again.

To enter the rest, use the [4 ▲▼]–[8 ▲▼] buttons. (Press the button once to select the rest value, and once again to actually enter it.) The BAR:BEAT:CLOCK indication lets you confirm that a rest having the specified note length has been entered.

## 4 Enter the next notes and apply a tie.

**4-1** Press the [G] button to select “mp.”

**4-2** Press the [H] button to select “Normal.”

**4-3** While holding G3 key on the keyboard, press the [6 ▲▼] button.

This operation advances the input position from the current 2nd beat to the next 3rd beat. Do not release the G3 key yet. Keep holding it while executing the following steps.

**4-4** While holding the G3 key, press the C4 key.

Do not release the G3 and C4 keys yet. Keep holding the notes while carrying out the following step.



**4-5** While holding the keys G3 and C4, press the [5 ▲▼] button.

After pressing the button, release the keys.

This enters the notes G3 and C4 notes have been entered as shown in the notation on the previous page.

## Recording Chords (Step Recording)

In Step Recording, you can record the precise change timing of chords and Sections (such as Intro, Main and Ending) of the current Style on the single display. After the operations are finished, the recorded information or events will be converted to the actual MIDI notes or Song data.

**1** Press the SONG [REC] and SONG [■] (STOP) buttons simultaneously.

A blank Song (“New Song”) is called up for recording.

**NOTE** Selecting a blank Song initializes the panel settings.



**2** Select the Style you want to use in the Song.

**3** Call up the operation display.

[FUNCTION] → TAB [▶] MENU 2 → [B] SONG CREATOR → TAB [◀][▶] CHORD

**4** Press the [G] (STEP REC) button to call up the STEP RECORD display.



**5 Start Step Recording by using the [A]–[J] buttons and [1 ▲▼]–[8 ▲▼] buttons, as well as the keyboard.**

Refer to the example below for specific instructions.

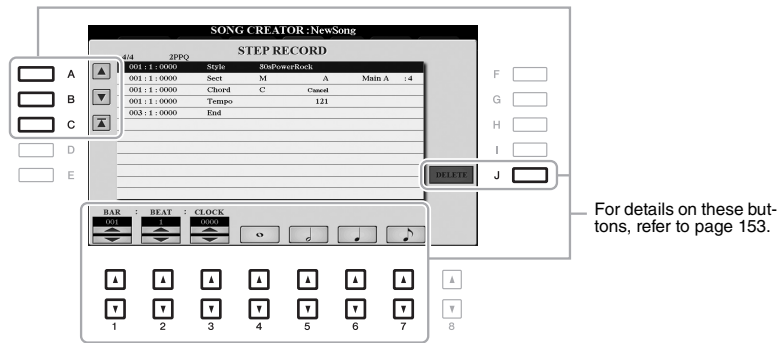

**6 Press the SONG [■] (STOP) button (or press the [C] button) to return to the top of the Song, then hear the newly entered Song by pressing the [▶/■] (PLAY/PAUSE) button.**



**7 Press the [EXIT] button to exit from the Step Recording display.**

**8 Press the [F] (EXPAND) button to convert the recorded data to the actual MIDI notes (Song data).**

**9 Press the [I] (SAVE) button to carry out the Save operation.**

For details, refer to page 28.

**NOTICE**

The recorded Song data will be lost if you select another Song or turn off the power to the instrument without carrying out the Save operation.

**Example of Step Recording—Chord (detailed instructions of step 5 above)**

**NOTE** This example uses a Style in 4/4 time.

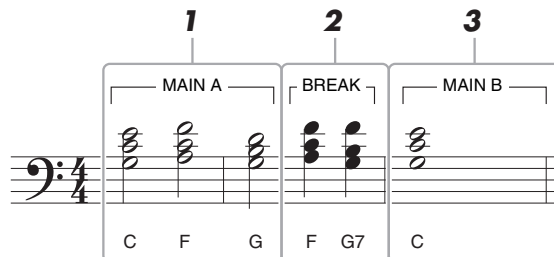

\* The numbers shown in the illustration correspond to the following operation step numbers.

Before executing the instructions below, make sure that [AUTO FILL IN] button is turned off since no Fill in is included in the notation example above.

## 1 Enter the chords for the Main A section.

**1-1** Press the STYLE CONTROL MAIN VARIATION [A] button.

**1-2** Press the [5 ▲▼] button to select the half-note length.

**1-3** Play the chords C, F and G in the chord section of the keyboard.

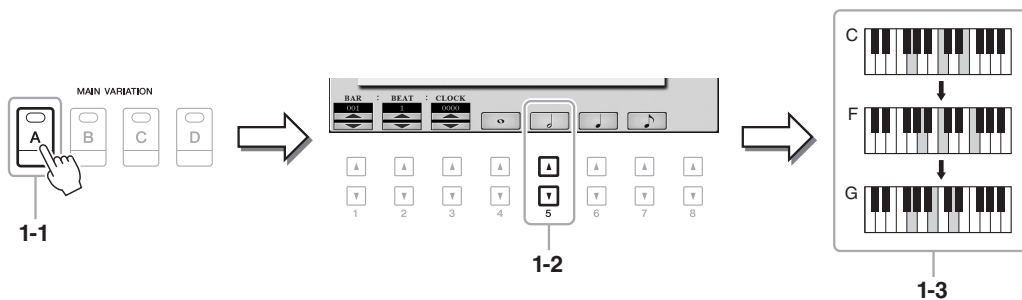

## 2 Enter the chords for the Break section.

**2-1** Press the STYLE CONTROL [BREAK] button.

**2-2** Press the [6 ▲▼] button to select the quarter-note length.

**2-3** Play the chords F and G7 in the chord section of the keyboard.

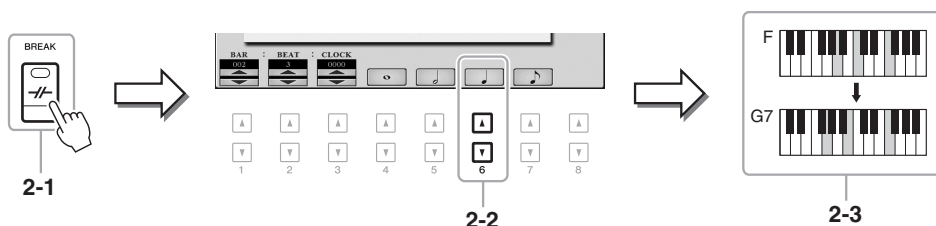

**NOTE** If you want to record the Fill In Section, turn on the [AUTO FILL IN] button, then press one of the MAIN VARIATION [A]–[D] buttons.

## 3 Enter the chords for the Main B section.

**3-1** Press the STYLE CONTROL MAIN VARIATION [B] button.

**3-2** Press the [4 ▲▼] button to select the whole-note length.

**3-3** Play the chord C in the chord section of the keyboard.

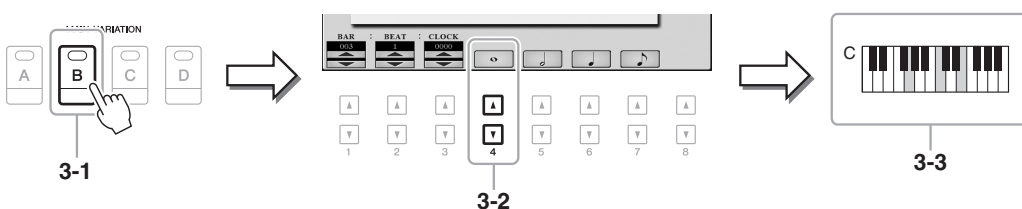

## Selecting the Setup Data to be Recorded to the Top Position of the Song

The current settings of the Mixing Console display and other panel settings you made can be recorded to the top position of the Song as Setup data. The panel settings recorded here are automatically recalled when the Song starts.

**1** Select the Song to which you want to record the Setup data.

**2** Call up the operation display.

[FUNCTION] → TAB [▶] MENU 2 → [B] SONG CREATOR → TAB[◀][▶] SETUP

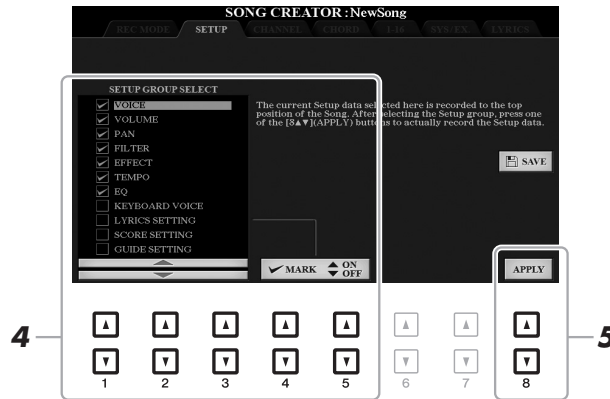

**3** Press the SONG [■] (STOP) button to move the Song position to the top of the Song.

**4** Determine the Setup data to be recorded.

[1 ▲▼]- [3 ▲▼]	SELECT	<p>Determines which playback features and functions will be automatically called up along with the selected Song. The items selected here can be recorded only to the top position of the Song, except for the KEYBOARD VOICE.</p> <p><b>VOICE, VOLUME, PAN, FILTER, EFFECT, TEMPO, EQ:</b> Records the tempo setting and all settings made from the Mixing Console.</p> <p><b>KEYBOARD VOICE:</b> Records the panel settings, including the Voice selection of the keyboard parts (RIGHT 1, 2, and LEFT) and their on/off status. Panel settings recorded here are same as the ones memorized to the One Touch Setting. This can be recorded at any point in a Song, letting you change Voices in the middle of a Song.</p> <p><b>LYRICS SETTING:</b> Records the settings in the Lyrics display.</p> <p><b>SCORE SETTING:</b> Records the settings in the Score display.</p> <p><b>GUIDE SETTING:</b> Records the settings of the Guide functions including the Guide ON/OFF setting.</p>
[4 ▲]/ [5 ▲]	MARK ON	Add or remove a checkmark to the selected item. Checked items are recorded to the Song.
[4 ▼]/ [5 ▼]	MARK OFF	

**5** Press the [8 ▲▼] (APPLY) button to record the data.

## 6 Press the [I] (SAVE) button to carry out the Save operation.

For details, refer to page 28.

### NOTICE

The edited Song data will be lost if you select another Song or turn off the power to the instrument without carrying out the Save operation.

## Re-recording a Specific Section—Punch In/Out

When re-recording a specific section of an already-recorded Song, use the Punch IN/OUT function. In this method, only the data between the Punch In point and the Punch Out point is overwritten with the newly recorded data. Keep in mind that the notes before and after the Punch In/Out points are not recorded over, although you will hear them play back normally to guide you in the Punch In/Out timing.

**NOTE** The Style Retrigger function (page 112) cannot be used when recording over existing data (overdubbing).

### 1 Select the desired Song for re-recording.

### 2 Call up the operation display.

[FUNCTION] → TAB [▶] MENU 2 → [B] SONG CREATOR → TAB [◀] REC MODE

### 3 Determine the settings for recording.

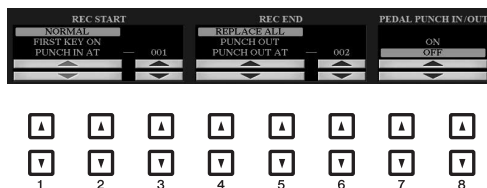

[1 ▲▼]– [3 ▲▼]	REC START (Punch In)	<p>Determines the Punch In timing.</p> <p><b>NORMAL:</b> Overwrite recording starts when the Song playback is started via the SONG [▶/  ] (PLAY/PAUSE) button or when you play the keyboard in the Synchro Standby mode.</p> <p><b>FIRST KEY ON:</b> The Song plays back normally, then starts overwrite recording as soon as you play the keyboard.</p> <p><b>PUNCH IN AT:</b> The Song plays back normally up to the beginning of the indicated Punch In measure, then starts overwrite recording at that point. You can set the Punch In measure by pressing the [3 ▲▼] button.</p>
[4 ▲▼]– [6 ▲▼]	REC END (Punch Out)	<p>Determines the Punch Out timing.</p> <p><b>REPLACE ALL:</b> This deletes all data after the point at which recording is stopped.</p> <p><b>PUNCH OUT:</b> The Song position at which recording is stopped is regarded as the Punch Out point. This setting maintains all data after the point at which recording is stopped.</p> <p><b>PUNCH OUT AT:</b> Actual overwrite recording continues until the beginning of the specified Punch Out measure (set with the corresponding display button), at which point recording stops and normal playback continues. This setting maintains all data after the point at which recording is stopped. You can set the Punch Out measure by pressing the [6 ▲▼] buttons.</p>

<p>[7 ▲▼]/ [8 ▲▼]</p>	<p>PEDAL PUNCH IN/OUT</p>	<p>When this is set to ON, you can use Foot Pedal 2 to control the Punch In and Punch Out points. While a Song is playing back, pressing (and holding) Foot Pedal 2 instantly enables Punch In recording, while releasing the pedal stops recording (Punch Out). You can press and release Foot Pedal 2 as often as you want during playback to punch in/out of overwrite recording. Note that the current function assignment of the Foot Pedal 2 is cancelled when the Pedal Punch In/Out function is set to ON.</p> <p><b>NOTE</b> Pedal Punch In/Out operation may be reversed depending on the particular pedal you've connected to the instrument. If necessary, change the pedal polarity to reverse the control (page 191).</p>
---------------------------	-------------------------------	---

**4 While holding the SONG [REC] button, press the desired track button.**

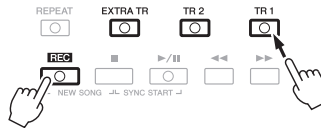

**5 Press the SONG [▶/||] (PLAY/PAUSE) button to start Punch In/Out recording.**

According to the settings in step 3, play the keyboard between the Punch In and Punch Out points. Refer to the examples of various settings illustrated below.

**6 Press the [I] (SAVE) button to carry out the Save operation.**

For details, refer to page 28.

**NOTICE**

The recorded Song data will be lost if you select another Song or turn off the power to the instrument without carrying out the Save operation.



## ■ Examples of re-recording with various Punch In/Out settings

This instrument features several different ways you use the Punch In/Out function. The illustrations below indicate a variety of situations in which selected measures in an eight-measure phrase are re-recorded.

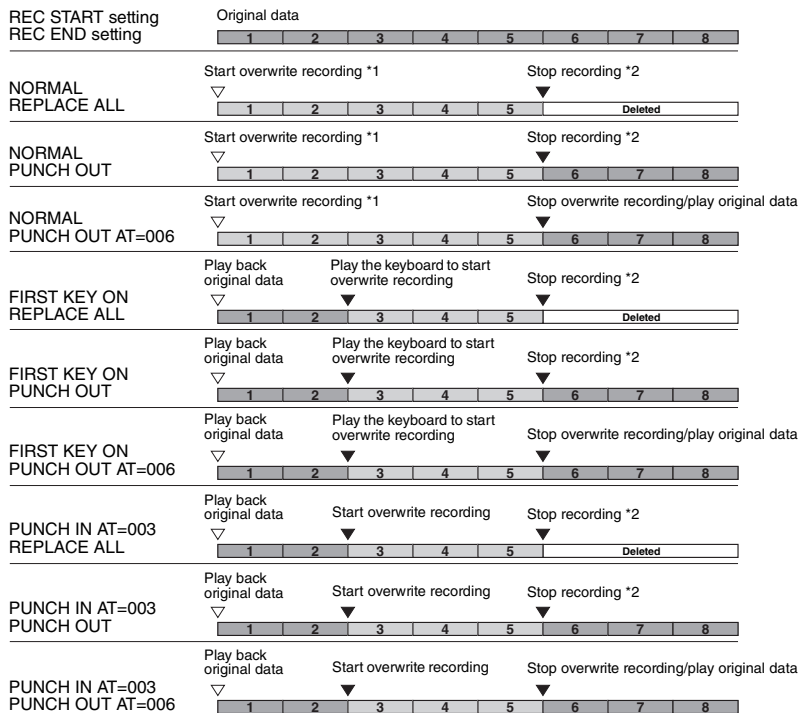

\*1 If you want to re-record from the 3rd measure in this setting, move the Song position to the 3rd measure then start recording to avoid overwriting measures 1–2.

\*2 To stop recording, press the [REC] button at the end of measure 5.

Previously recorded data  
 Newly recorded data  
 Deleted data

## Editing Channel Events of Existing Song Data

You can apply various useful functions to already recorded data, such as Quantize and Transpose, on the CHANNEL page.

**1** Select a Song to be edited.

**2** Call up the operation display.

[FUNCTION] → TAB [▶] MENU 2 → [B] SONG CREATOR → TAB [◀][▶] CHANNEL

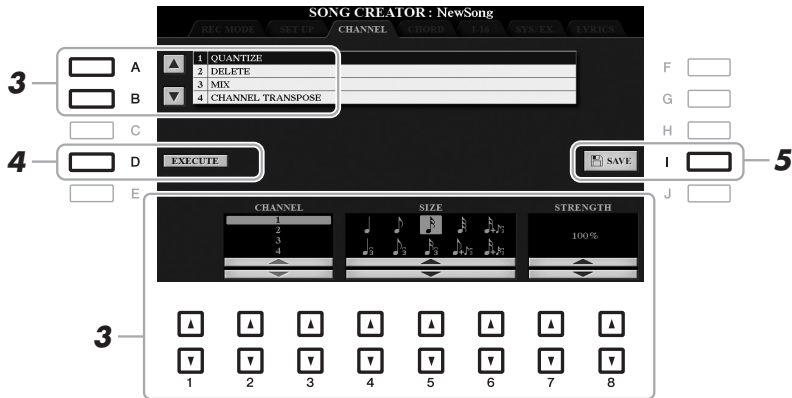

**3** Use the [A]/[B] buttons to select the edit menu, then edit the data by using the [1 ▲▼]–[8 ▲▼] buttons.

For details of the edit menu and available settings, see pages 163–164.

**4** Press the [D] (EXECUTE) button to carry out the operation for the current display.

After the operation is completed, this button changes to “UNDO,” letting you restore the original data if you are not satisfied with the operation results. The Undo function only has one level; only the previous operation can be undone.

**5** Press the [I] (SAVE) button to carry out the Save operation.

For details, refer to page 28.

### **NOTICE**

The edited Song data will be lost if you select another Song or turn off the power to the instrument without carrying out the Save operation.

## 1 QUANTIZE

The Quantize function allows you to align the timing of all the notes in a channel. For example, if you record the musical phrase shown below, you may not play it with absolute precision, and your performance may have been slightly ahead of or behind the precise timing. Quantize is a convenient way of correcting for this.



<p>[2 ▲▼]/ [3 ▲▼]</p>	<p>CHANNEL</p>	<p>Determines which MIDI channel in the Song data is to be quantized.</p>										
<p>[4 ▲▼]- [6 ▲▼]</p>	<p>SIZE</p>	<p>Selects the quantize size (resolution). For optimum results, you should set the Quantize size to the shortest note value in the channel. For example, if eighth notes are the shortest in the channel, you should use eighth note as the Quantize size.</p> <p>Settings:</p> <table border="0"> <tr> <td> 1/4 note</td> <td> 1/8 note</td> <td> 1/16 note</td> <td> 1/32 note</td> <td> 1/16 note+ 1/8 note triplet*</td> </tr> <tr> <td> 1/4 note triplet</td> <td> 1/8 note triplet</td> <td> 1/16 note triplet</td> <td> 1/8 note+ 1/8 note triplet*</td> <td> 1/16 note+ 1/16 note triplet*</td> </tr> </table> <p>The three Quantize settings marked with asterisks (*) are exceptionally convenient, since they allow you to quantize two different note values at the same time. For example, when the straight eighth notes and eighth-note triplets are contained in the same channel, if you quantize by the straight eighth notes, all notes in the channel are quantized to straight eighth notes—completely eliminating any triplet feel. However, if you use the eighth note + eighth note triplet setting, both the straight and triplet notes will be quantized correctly.</p>	1/4 note	1/8 note	1/16 note	1/32 note	1/16 note+ 1/8 note triplet*	1/4 note triplet	1/8 note triplet	1/16 note triplet	1/8 note+ 1/8 note triplet*	1/16 note+ 1/16 note triplet*
1/4 note	1/8 note	1/16 note	1/32 note	1/16 note+ 1/8 note triplet*								
1/4 note triplet	1/8 note triplet	1/16 note triplet	1/8 note+ 1/8 note triplet*	1/16 note+ 1/16 note triplet*								
<p>[7 ▲▼]/ [8 ▲▼]</p>	<p>STRENGTH</p>	<p>Determines how strongly the notes will be quantized. A setting of 100% produces exact timing. If a value less than 100% is selected, notes will be moved toward the specified quantization beats according to the specified percentage. Applying less than 100% quantization lets you preserve some of the “human” feel in the recording.</p>										

## 2 DELETE

You can delete the data of the specified channel in the Song. Select the channel whose data to be deleted by using the [1 ▲▼]–[8 ▲▼] buttons, then press the [D] (EXECUTE) button to carry out the operation.

## 3 MIX

This function lets you mix the data of two channels and place the results in a different channel. It also lets you copy the data from one channel to another.

[2 ▲▼]/ [3 ▲▼]	SOURCE 1	Determines the MIDI channel (1–16) to be mixed. All MIDI events of the channel specified here are copied to the destination channel.
[4 ▲▼]/ [5 ▲▼]	SOURCE 2	Determines the MIDI channel (1–16) to be mixed. Only note events of the channel specified here are copied to the destination channel. Besides the values 1–16, there is a “COPY” setting that allows you to copy the data from Source 1 to the destination channel.
[6 ▲▼]/ [7 ▲▼]	DESTINATION	Determines the channel into which the mix or copy results will be placed.

## 4 CHANNEL TRANSPOSE

This allows you to transpose the recorded data of individual channels up or down by a maximum of two octaves in semitone increments.

**NOTE** Make sure not to transpose channels 9 and 10. In general, Drum Kits are assigned to these channels. If you transpose the channels of Drum Kits, the instruments assigned to each key will be changed.

[F]	CH 1–8/CH 9–16	Toggles between the two channel displays: Channels 1–8, and Channels 9–16.
[G]	ALL CH	To simultaneously set all channels to the same value, adjust the Channel Transpose for one of the channels while holding down this button.

## Editing Chord Events, Notes, System Exclusive Events and Lyrics

You can edit chord events, note events, System Exclusive events and lyrics in the same manner on the corresponding displays: CHORD, 1-16, SYS/EX and LYRICS. These are called “Event List” displays because some events are shown in a list view.

**Event List display**

Indicates the location (position) of the corresponding event.

Indicates the event type. See page 166.

Indicates the event value.

[▲] [▲] [▲] [▲] [▲] [▲] [▲] [▲]  
[▼] [▼] [▼] [▼] [▼] [▼] [▼] [▼]  
 1 2 3 4 5 6 7 8

[A]/[B]		Moves the cursor up/down and selects the desired event.
[C]		Moves the cursor to the top (beginning of the Song).
[D]/[E]		Moves the cursor left/right and selects the desired parameter of the highlighted event.
[H]	FILTER	Calls up the Filter display (page 167), letting you select only the events you wish to be shown in the event list.
[I]	SAVE	Press to save the edited Song.
[J]	MULTI SELECT	Holding this button while using the [A]/[B] buttons lets you select multiple events.
[1 ▲▼]	BAR	Determines the position (bar/beat/clock) of the data. One clock is equal to 1/1920th of a quarter note.
[2 ▲▼]	BEAT	
[3 ▲▼]	CLOCK	
[4 ▲▼]/ [5 ▲▼]	DATA ENTRY	Adjusts the event value. For coarse adjustment, use the [4 ▲▼] buttons. For fine adjustment, use the [5 ▲▼] buttons or the Data dial.
[6 ▲]	CUT	Carries out the cut/copy/delete/paste operation.
[7 ▲]	COPY	
[7 ▼]	DELETE	
[8 ▲]	PASTE	
[6 ▼]	INSERT	Adds a new event.
[8 ▼]	CANCEL	Cancels editing and restores the original value.

**NOTE** After you edit events in the CHORD display, press the [F] (EXPAND) button to convert the data into Song data.

**NOTE** Chord section data recorded with Realtime Recording cannot be indicated and edited on this display.

### ■Chord Events (CHORD Page)

Style	Style
Tempo	Tempo
Chord	Chord root, Chord type, On Bass Chord
Sect	Style Section (Intro, Main, Fill In, Break, Ending)
OnOff	On/off status for each part (channel) of the Accompaniment Style
CH.Vol	Volume for each part (channel) of the Accompaniment Style
S.Vol	Overall volume of the Accompaniment Style

### ■Note Events (1-16 Page)

Note	An individual note within a Song. Includes the note number which corresponds to the key which was played, plus a velocity value based on how hard the key is played, and the gate time value (the length of a note).
Ctrl (Control Change)	Settings for controlling the Voice, such as volume, pan, filter and effect depth (edited via the Mixing Console described in chapter 8), etc.
Prog (Program Change)	MIDI program change number for selecting a Voice.
P.Bnd (Pitch Bend)	Data for changing the pitch of a Voice continuously. This event is generated by controlling the joystick (when the function is assigned; page 40).
A.T. (Aftertouch)	This event is generated when pressure is applied to a key after the note is played. Note that the keyboard of this instrument does not feature Aftertouch.

### ■System Exclusive Events (SYS/EX. Page)

ScBar (Score Start Bar)	Determines the top measure of a Song.
Tempo	Determines the tempo value.
Time (Time signature)	Determines the time signature.
Key (Key signature)	Determines the key signature, as well as the major/minor setting, for the music score shown on the display.
XGPrm (XG parameters)	Allows you to make various detailed changes to the XG parameters. For details, refer to “MIDI Data Format” in the Data List on the website.
SYS/EX. (System Exclusive)	Displays the System Exclusive data in the Song. Keep in mind that you cannot create new data or change the contents of the data here; however, you can delete, cut, copy, and paste the data.
Meta (Meta event)	Displays the SMF meta events in the Song. Keep in mind that you cannot create new data or change the contents of the data here; however, you can delete, cut, copy, and paste the data.

### ■Lyrics Events (LYRICS Page)

Name	Allows you to enter the Song name.
Lyrics	Allows you to enter lyrics.
Code	<b>CR:</b> Enters a line break in the lyrics text. <b>LF:</b> Clears the currently displayed lyrics and displays the next set of lyrics.

## Displaying Specific Types of Events

In the Event List displays, various types of events are shown. It may sometimes be difficult to pinpoint the ones you want to edit. This is where the Filter function comes in handy. It lets you determine which event types will be shown in the Event List displays.

1. Press the [H] (FILTER) button in the CHORD, 1-16, SYS/EX. or LYRICS displays.
2. Checkmark the desired item to be displayed.

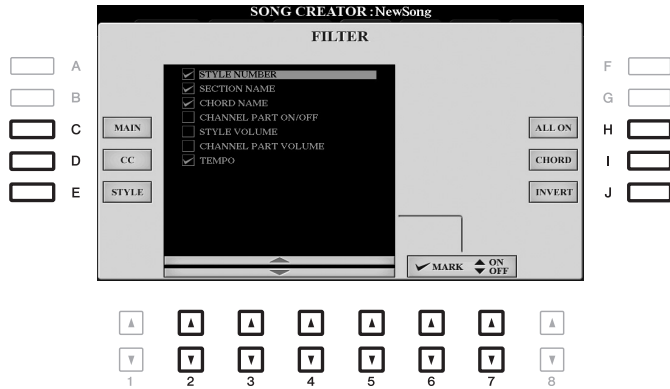

[C]	MAIN	Displays all main types of events.
[D]	CC	Displays all specific Control Change message events.
[E]	STYLE	Displays all types of Style playback related events.
[H]	ALL ON	Checkmarks all event types.
[I]	NOTE/ALL OFF/ CHORD	“NOTE” (shown when [C] (MAIN) is on) selects only the NOTE data. “CHORD” (shown when [E] (STYLE) is on) selects only the CHORD data. “ALL OFF” (shown when [D] (CC) is on) removes all checkmarks.
[J]	INVERT	Reverses the checkmark settings for all boxes. In other words, this enters checkmarks to all boxes that were previously unchecked and vice versa.
[2 ▲▼]– [5 ▲▼]		Select and event type to be checked or unchecked.
[6 ▲]/ [7 ▲]	MARK ON	Enters/removes the checkmark for the selected event type. The checked event types can be shown on the CHORD, 1-16, SYS/EX. or LYRICS page.
[6 ▼]/ [7 ▼]	MARK OFF	

3. Press the [EXIT] button to return to the Event List display in which only unfiltered Events are shown.

This function is fully explained in the Basic Operations section. Refer to page 71.

### ***Creating Multi Pads (Multi Pad Creator)***

This feature lets you create your original Multi Pad phrases, and also allows you to edit existing Multi Pad phrases to create your own. As with Song Creator, Multi Pad Creator features Realtime Recording and Step Recording. However, each Multi Pad consists of only one channel and convenient functions such as Punch In/Out are not available.

#### **Multi Pad—Realtime Recording via MIDI**

---

Before starting operation, note the following points:

- Since only the RIGHT 1 part performance will be recorded as Multi Pad phrases, you should select the desired Voice for the RIGHT 1 part beforehand.
- The Super Articulation Voices and the Organ Flutes Voices cannot be used for Multi Pad Recording. If one of these Voices is set for RIGHT 1 part, it will be replaced with the Grand Piano Voice when recording.
- Since recording can be done along with and synchronized to Style playback, you should select the desired Style beforehand. However, keep in mind that the Style is not recorded.

**1** If you want to create a new Multi Pad in the existing Bank, select the desired Multi Pad Bank via the MULTI PAD CONTROL [SELECT] button.

If you want to create a new Multi Pad in an empty new Bank, this step is unnecessary.



## 2 Call up the operation display.

[FUNCTION] → TAB [▶] MENU 2 → [C] MULTI PAD CREATOR → TAB [◀] RECORD

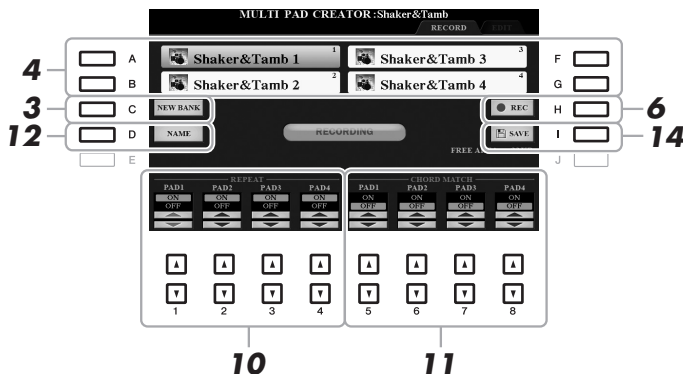

## 3 If you want to create a new Multi Pad in an empty new Bank, press the [C] (NEW BANK) button.

## 4 Select a particular Multi Pad for recording by pressing the corresponding [A], [B], [F] and [G] button.

## 5 If necessary, select the desired Voice with the VOICE category selection buttons.

After selecting the Voice, press the [EXIT] button to return to the previous display.

## 6 Press the [H] (REC) button to enter recording standby status for the Multi Pad selected in step 4.

## 7 Play the keyboard to start recording.

To ensure that your recording will be in sync with the tempo, press the [METRONOME] button to turn on the metronome.

If you want to insert silence before the actual phrase, press the STYLE CONTROL [START/STOP] to start both the Recording and rhythm playback (of the current Style). Keep in mind that the rhythm part of the current Style plays back during recording although it is not recorded.

### Recommended notes for the Chord Match phrase

If you intend to create a Chord Match phrase, use the notes of C, D, E, G, A and B, or in other words, play the phrase in the key of C major. This ensures that the phrase will stay harmonically constant and match whichever chord you play in the left hand section of the keyboard.

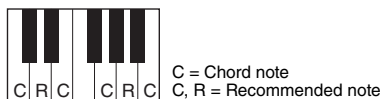

## 8 Stop recording.

Press the [H] (STOP) button or the panel MULTI PAD CONTROL [STOP] button or the STYLE CONTROL [START/STOP] button to stop recording when you've finished playing the phrase.

## 9 Listen back to your newly recorded phrase, by pressing the appropriate MULTI PAD button, [1]–[4]. To re-record the phrase, repeat steps 6–8.

## 10 Turn the Repeat parameter of each pad On or Off by using the [1 ▲▼]–[4 ▲▼] buttons.

If the Repeat parameter is on for the selected pad, playback of the corresponding pad will continue until the MULTI PAD [STOP] button is pressed. When you press a Multi Pad for which Repeat is turned on during Song or Style playback, playback will start and repeat in sync with the beat.

If the Repeat parameter is off for the selected pad, playback will end automatically as soon as the end of the phrase is reached.

## **11 Turn Chord Match of each pad On or Off by using the [5 ▲▼]–[8 ▲▼] buttons.**

If the Chord Match parameter is on for the selected pad, the corresponding pad is played back according to the chord specified in the chord section of the keyboard generated by turning [ACMP] on, or specified in the LEFT part of the keyboard generated by turning [LEFT] on (when turning the [ACMP] off).

## **12 Press the [D] (NAME) button, then enter the desired name for each Multi Pad.**

## **13 If you want to record other Multi Pads, repeat steps 4–12.**

## **14 Press the [I] (SAVE) button to save the Multi Pad, then save the Multi Pad data as a Bank containing a set of four Pads.**

### **NOTICE**

The edited Multi Pad data will be lost if you select another Multi Pad Bank or turn off the power to the instrument without carrying out the Save operation.

## **Multi Pad—Step Recording via MIDI**

---

Step Recording can be carried out in the EDIT page. After selecting a Multi Pad in step 4 on page 169, press the TAB [▶] button to select the EDIT page.

The EDIT page indicates the Event list, which lets you record notes with absolutely precise timing. This Step Recording procedure is essentially the same as that for Song Recording (pages 152–155), with the exception of the points listed below:

- There is no LCD button for selecting channels, since Multi Pads contain data for only a single channel.
- In the Multi Pad Creator, only channel events and System Exclusive messages can be entered. Chord and Lyrics events are not available. You can switch between the two types of Event Lists by pressing the [F] button.

## ***Editing Multi Pads***

You can manage (rename, copy, paste and delete) your created Multi Pad Bank and each of the Multi Pads belonging to the Bank. For instructions on managing the Multi Pad Bank file, refer to page 27. This section covers how to manage each Multi Pad.

### **1 Select the Multi Pad Bank containing the Multi Pad to be edited.**

Press the MULTI PAD CONTROL [SELECT] button to call up the Multi Pad Bank Selection display, use the TAB [◀][▶] buttons to call up “PRESET,” “USER” or “USB” (when USB flash drive is connected), then use the [A]–[J] buttons to select the desired Multi Pad Bank.

**NOTE** If you select a Preset Multi Pad Bank then edit the Multi Pads, save your edits to “USER” or “USB” (when USB flash drive is connected) as a User Bank.

### **2 Press the [7 ▼] (EDIT) button of MENU 1 to call up the MULTI PAD EDIT display.**

### **3 Select a particular Multi Pad to be edited by pressing any of the [A], [B], [F] and [G] buttons.**

## 4 Edit the selected Pad.

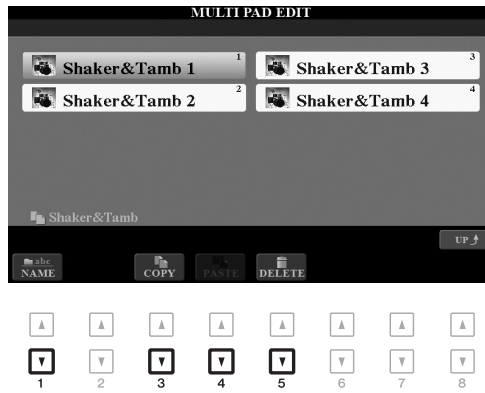

[1 ▼]	NAME	Changes the name of each Multi Pad.
[3 ▼]	COPY	Copies the Multi Pad(s). See below.
[4 ▼]	PASTE	Pastes the Multi Pad(s) copied by the [3 ▼] button.
[5 ▼]	DELETE	Deletes the selected Multi Pads.

### Copying the Multi Pad

1. Press the [3 ▼] (COPY) button in step 4 above.
2. Select the Multi Pads to be copied by using the [A], [B], [F] and [G] buttons, then press the [7 ▼] (OK) button.  
The selected Multi Pad(s) is copied to the clipboard.
3. Select the destination location by using the [A], [B], [F] and [G] buttons. If you want to copy the selected Pad(s) to another bank, press the [8 ▲] (UP) button to call up the Multi Pad Bank Selection display, select the desired bank, press the [7 ▼] (EDIT) button of MENU 1, then select the destination.
4. Press the [4 ▼] (PASTE) button to carry out the Copy operation.

## 5 Save the current Bank containing the edited Multi Pads.

Press the [8 ▲] button to call up the confirmation window, press the [F] (YES) button to call up the USER page, then press the [6 ▼] (SAVE) button to carry out the Save operation. For details, refer to page 28.

## Creating a Set of Favorite Records

Even though the Search function lets you efficiently look for Music Finder Records, you may want to create a custom “folder” of your favorite Records—so you can quickly call up the panel settings, song data and Style data you use frequently.

- 1 Select the desired Record from the MUSIC FINDER display.
- 2 Press the [H] (ADD TO FAVORITE) button, then press the [G] (YES) button to add the selected Record to the FAVORITE page.



- 3 Select the FAVORITE page by using the TAB [◀][▶] buttons, and check to see if the Record has been added.

As with the ALL page, you can select the Record in the FAVORITE page then start your performance.

### Deleting Records from the FAVORITE Page

1. Select the Record you want to delete from the FAVORITE page.
2. Press the [H] (DELETE FROM FAVORITE) button, then press the [G] (YES) button to actually delete the Record.

## Editing Records

You can create your original Record by editing an existing Record. Your edits can be replaced with those of the current Record, or can be saved as a new separate Record.

- 1 Select the desired Record to be edited in the MUSIC FINDER display.
- 2 Press the [8 ▲▼] (RECORD EDIT) button to call up the EDIT display.
- 3 Edit the Record.

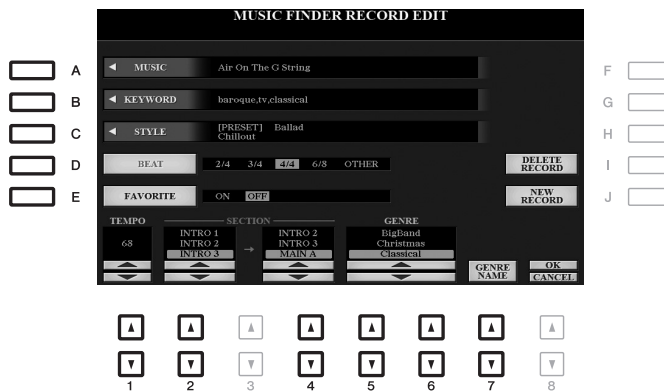

[A]	MUSIC	For entering the music title. Pressing the [A] button calls up the display for entering the music title.
[B]	KEYWORD	For entering the keyword to be used when executing the Search operation. Pressing the [B] button calls up the display for entering the keyword.
[C]	STYLE/SONG/ AUDIO	Changes the Style. Pressing the [C] button calls up the Style Selection display. After selecting the desired Style, press the [EXIT] button to return back to the EDIT display. For SONG or AUDIO Records, this field cannot be edited.
[D]	BEAT	Changes the beat (time signature) of the Record for search purposes. For SONG or AUDIO Records, this field cannot be edited.  <b>NOTE</b> Keep in mind that the Beat setting made here is only for the Music Finder search function; this does not affect the actual Beat setting of the Style itself.
[E]	FAVORITE	Selects whether the edited Record is added to the FAVORITE page or not.
[1 ▲▼]	TEMPO	Changes the Tempo. For SONG or AUDIO Records, this field cannot be edited.
[2 ▲▼]	SECTION	Selects the sections of Style that are called up as a set when the Record is selected. You can start the Record with the section selected by the [2 ▲▼] buttons. When the section finishes, Style playback automatically shifts to the section selected by the [4 ▲▼] buttons. For SONG or AUDIO Records, this field cannot be edited.
[4 ▲▼]		
[5 ▲▼]/ [6 ▲▼]	GENRE	Selects the desired genre.
[7 ▲▼]	GENRE NAME	Creates a new genre.

To cancel and quit the Edit operation, press the [8 ▼] (CANCEL) button.

#### **4 Save the edited Record.**

##### **When creating a new Record**

Press the [J] (NEW RECORD) button. The Record is added to the ALL page.

##### **When overwriting an existing Record**

Press the [8 ▲] (OK) button.

## **Deleting the Record**

---

By carrying out the Delete operation, the Record is deleted from all pages (ALL, FAVORITE and SEARCH 1/2).

#### **1 Select the Record to be deleted from the MUSIC FINDER display.**

#### **2 Press the [8 ▲▼] (RECORD EDIT) button to call up the EDIT display.**

#### **3 Press the [I] (DELETE RECORD) button.**

To cancel the Delete operation and return to the MUSIC FINDER display in step 1, press [H] (NO); to return to the EDIT display in step 2, press [I] (CANCEL).

#### **4 Press the [G] (YES) button to delete the current Record.**

## ***Saving the Records as a Single File***

The Music Finder feature handles all the Records including the presets and additionally created Records as a single file. Keep in mind that individual Records (panel settings, Song, audio and Style files) cannot be handled as separate files.

#### **1 Press the [7 ▲▼] (FILES) button in the MUSIC FINDER display to call up the File Selection display.**

#### **2 Press the TAB [◀][▶] buttons to select the location for saving (USER/USB).**

#### **3 Press the [6 ▼] (SAVE) button.**

The Character Entry window is called up. If necessary, rename the file. For instructions, refer to page 30.

#### **4 Press the [8 ▲] (OK) button to save the file.**

All Records are saved together as a single Music Finder file.

## Calling up the Records from a Music Finder file

---

By selecting a Music Finder file, you can recall the Records saved to the USER or USB drive as a file.

- 1** Press the [7 ▲▼] (FILES) button in the MUSIC FINDER display to call up the File Selection display.
- 2** Use the TAB [◀][▶] buttons to select the location to which the file is saved.
- 3** Press the [A]–[J] buttons to select the desired Music Finder file.

A message appears, prompting you to select one of the following options.

[G]	REPLACE	All Music Finder Records currently in the instrument are deleted and replaced with the Records of the selected file.  <b><u>NOTICE</u></b> Selecting "REPLACE" automatically deletes all your original Records from internal memory. Make sure that all important data has been archived to another location beforehand.
[H]	APPEND	The Records called up are added to the Records currently in the instrument.
[I]	CANCEL	Cancels the file selection operation.

## Editing the Registration Memory

You can edit (rename and delete) each of Registration Memories contained in the Bank.

- 1 Select the Registration Memory Bank containing the Registration Memory to be edited.**  
Press the REGISTRATION BANK [+]/[-] buttons simultaneously to call up the Registration Bank Selection display, then press one of the [A]–[J] buttons to select the desired Bank.
- 2 Press the [7 ▼] (EDIT) button of MENU 1 to call up the REGISTRATION EDIT display.**
- 3 Select a particular Registration Memory to be edited by pressing any of the [A]–[D] and [F]–[I] buttons.**
- 4 Press the [1 ▼] button to rename or the [5 ▼] button to delete the selected Registration Memory.**

For details on the Rename and Delete operations, refer to pages 30–31.

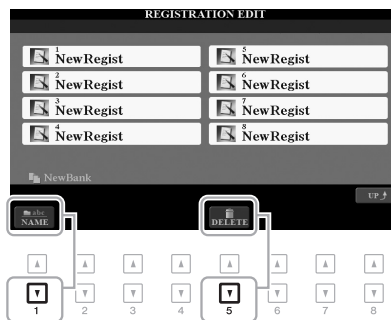

- 5 Save the current Bank containing the edited Registration Memories.**

Press the [8 ▲] (UP) button to call up the Registration Memory Selection display, then press the [6 ▼] (SAVE) button of MENU 2 to carry out the Save operation. For details, refer to page 28.



## Disabling Recall of Specific Items (Freeze)

Registration Memory lets you recall all the panel setups you made with a single button press. However, there may be times that you want certain items to remain the same, even when switching Registration Memory setups. When you want to switch the Voice settings but still maintain the Style settings, for example, you can “freeze” only the Style settings and have those Style settings remain, even when you select another Registration Memory number.

### 1 Call up the operation display.

[FUNCTION] → TAB [◀] MENU 1 → [C] REGIST SEQUENCE/FREEZE → TAB [▶] FREEZE

### 2 Use the [1 ▲▼]–[3 ▲▼] buttons to select the desired item, then use the [4 ▲▼]/[5 ▲▼] buttons to enter or remove the checkmark.

Items having checkmarks will be frozen when the [FREEZE] button on the panel is turned on.



### 3 Press the [EXIT] button to exit from the operation display.

#### **NOTICE**

Settings in the FREEZE display are automatically saved to the instrument when you exit from this display. However, if you turn the power off without exiting from this display, the settings will be lost.

### 4 Press the [FREEZE] button on the panel to turn the Freeze function on.

With this operation, you can “freeze” or maintain checkmarked items, even when you select another Registration Memory number. To turn off the Freeze function, press the [FREEZE] button again.

## Calling Up Registration Memory Numbers in Order (Registration Sequence)

As convenient as the Registration Memory buttons are, there may be times during a performance when you want to quickly switch between settings. The convenient Registration Sequence function lets you call up the eight setups in any order you specify, by simply using the TAB [◀][▶] buttons (in the Main display) or the pedal as you play.

### 1 If you intend to use a pedal or pedals to switch the Registration Memory number, connect the optional pedals to the appropriate FOOT PEDAL jacks.

For instructions, refer to page 93.

### 2 In the REGISTRATION BANK display, select the desired Bank to be programmed.

### 3 Call up the operation display.

[FUNCTION] → TAB [◀] MENU 1 → [C] REGIST SEQUENCE/FREEZE → TAB [◀] REGISTRATION SEQUENCE

### 4 If you use a pedal, specify here how the pedal will be used—to advance or to reverse through the sequence.

Use the [B] or [C] button to select the pedal for advancing or reversing through the Registration Sequence. For example, if two pedals are connected, Pedal 1 is used for advancing while Pedal 2 is used for reversing. Note that the pedal settings here (other than OFF) will take priority over the settings in the FOOT PEDAL display (page 191). If you want to use the pedal for a function other than Registration Sequence, make sure to set this to OFF.

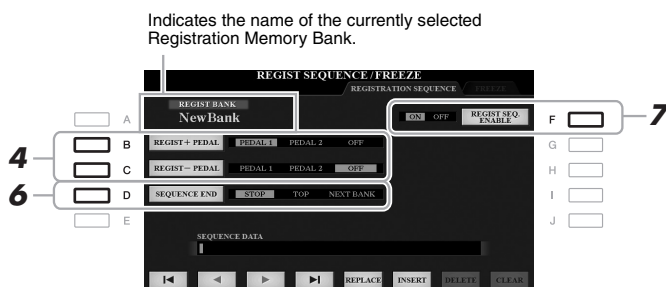

### 5 Program the Sequence order, from left to right.

Press one of the REGISTRATION MEMORY [1]–[8] buttons on the panel, then press the [6 ▲▼] (INSERT) button to input the number.

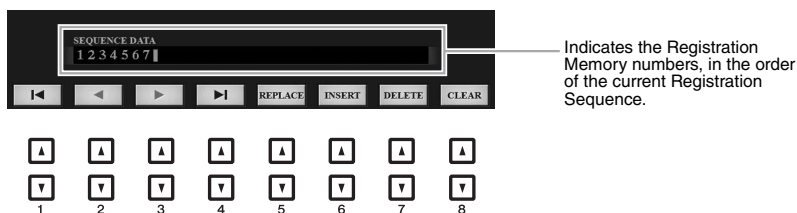

[1 ▲▼]- [4 ▲▼]		Moves the cursor.
[5 ▲▼]	REPLACE	Replaces the number at the cursor position with the currently selected Registration Memory number.
[6 ▲▼]	INSERT	Inserts the number of the currently selected Registration Memory number to the cursor position.
[7 ▲▼]	DELETE	Deletes the number at the cursor position.
[8 ▲▼]	CLEAR	Deletes all numbers in the sequence.

**6 Use the [D] (SEQUENCE END) button to determine how Registration Sequence behaves when reaching the end of the sequence.**

- **STOP** ..... Pressing the TAB [▶] button or the “advance” pedal has no effect. The sequence is “stopped.”
- **TOP** ..... The sequence starts again at the beginning.
- **NEXT BANK** ..... The sequence automatically moves to the beginning of the next Registration Memory Bank in the same folder.

**7 Press the [F] (REGIST SEQ. ENABLE) button to turn the Registration Sequence function on.**

**8 Press the [EXIT] button to exit from the operation display.**

After the confirmation message appears, press the [G] (YES) button to store the Registration Sequence program temporarily.

**NOTICE**

Keep in mind that all Registration Sequence data is lost when changing Registration Memory Banks, unless you’ve saved it with the Registration Memory Bank file. For instructions on saving, see the section below.

## Saving the Registration Sequence Settings

The settings for the Sequence order and how Registration Sequence behaves when reaching the end of the sequence (SEQUENCE END) are included as part of the Registration Memory Bank file. To store your newly programmed Registration Sequence, save the current Registration Memory Bank file.

**1 Press the REGIST BANK [+] and [-] buttons simultaneously to call up the REGISTRATION BANK Selection display.**

**2 Press the [6 ▼] button of MENU 2 to save the Bank file.**

For details, refer to page 28.

## Using the Registration Sequence

---

- 1 Select the desired Registration Bank.
- 2 At the upper right of the Main display, confirm the Registration Sequence.



- 3 Press the TAB [◀] or [▶] button, or press the Foot Pedal to select the first Registration Memory number.

The box appears around the left-most number, indicating that this Registration Memory number is currently selected.

- 4 Use the TAB buttons or Foot Pedal during your keyboard performance.

To return to the status in which no Registration Memory number is selected, press the TAB [◀] and [▶] buttons simultaneously while the Main display is called up.

**NOTE** The pedal can be used for Registration Sequence no matter which display is called up (except for the REGIST SEQUENCE display).

This function is fully explained in the Basic Operations section. Refer to page 88.

## Mixing Console

Regarding the Mixing Console, the Advanced Features section covers detailed descriptions of each parameter while the Basic Operations section covers the basic instructions including the Save operation. You can edit various parameters for the Parts called up via the [MIXER/EQ] button, then save your edits for future recall.

For a visual indication of the signal flow and configuration of the Mixing Console, refer to the Block Diagram on page 190.

Use the TAB [◀]/[▶] buttons to select the various pages that follow.

### Editing VOL/VOICE Parameters



[B]/[C] [G]/[H]	VOICE	<p>Allows you to re-select the Voices for each part.</p> <p><b>NOTE</b> Note the following operation limitations.</p> <ul style="list-style-type: none"> <li>• For each Style channel, you can select the Voices for recording on pages 127 and 128.</li> <li>• For each Style or Song channel, you cannot select Voices in the USER drive.</li> <li>• For each Multi Pad, you cannot change the Voice.</li> <li>• When a GM Song is selected, only a Drum Kit Voice can be selected for channel 10 (in the SONG CH9-16 page).</li> </ul> <p><b>NOTE</b> For a Style or Song channel, calling up a rhythm/percussion Voice (Drum Kit, etc.) will replace the channel settings with those for the new Voice. In such a case, the original settings may not be restored even if you re-select the original Voice. To restore the original sound, select the same Style or Song again without carrying out the Save operation.</p>
[D]/[I]	PANPOT	Determines the stereo position of the selected part (channel).
[E]/[J]	VOLUME	Determines the volume of each part or channel, giving you fine control over the balance of all the parts.

## Editing FILTER Parameters



[D]/[I]	HARMONIC CONTENT	Allows you to adjust the Resonance (page 115) for each part.
[E]/[J]	BRIGHTNESS	Determines the brightness of the sound for each part by adjusting the Cutoff Frequency (page 115).

# Editing TUNE Parameters



[A]/[B] [F]/[G]	PORTAMENTO TIME	Portamento is a function that creates a smooth transition in pitch from the first note played on the keyboard to the next. The Portamento Time determines the pitch transition time. Higher values result in a longer pitch change time. Setting this to “0” results in no effect. This parameter is available when the selected keyboard part is set to MONO (page 114).
[C]/[H]	PITCH BEND RANGE	Determines the pitch bend range for each keyboard part which is affected by controlling the joystick (when the Pitch Bend function is assigned; page 40). The range is from “0” to “12” with each step corresponding to one semitone.
[D]/[I]	OCTAVE	Determines the range of the pitch change in octaves, over two octaves up or down for each keyboard part. The value set here is added to the setting made via the UPPER OCTAVE [-]/[+] buttons.
[E]/[J]	TUNING	Determines the pitch of each keyboard part in cents. <b>NOTE</b> In musical terms a “cent” is 1/100th of a semitone. (100 cents equal one semitone.)
[1 ▲▼]- [3 ▲▼]	TRANSPOSE	Allows you to set transposition for the overall sound of the instrument (MASTER), Song playback (SONG), or the keyboard pitch (KBD), respectively. Please note that the “KBD” setting also transposes the pitch of Style playback and the Multi Pads (since these are also affected by keyboard play in the left-hand section).

## Editing EFFECT Parameters

This instrument features six Effect Blocks, giving you powerful tools to richly enhance the sounds of the instrument or completely transform them. The Effects are divided into the following groups:

### ■ Reverb, Chorus:

The Effects of these Blocks are applied to the overall sound or all Parts. In each of these Effect Blocks, you can select only one Effect Type at a time and adjust the Send Level (Depth) for each Part as well as the Return Level for all Parts.

### ■ DSP1:

When the “Connection” parameter is set to “System” in step 2 of page 186, the Effects of this Block are applied only to the Style and Song sounds. In this status, you can select only one Effect Type at a time and adjust the Send Level (Depth) for each Part as well as Return Level for all Parts. When the “Connection” parameter is set to “Insertion,” the Effect of this Block is applied to a specific channel of the Style and Song.

### ■ DSP2-4:

The Effects of these Blocks are applied to a specific Part or Channel, with the exception of the Multi Pads. Different Effect Types can be selected for each of the available Parts or Channels.

## Adjusting the Effect Depth for Each Part

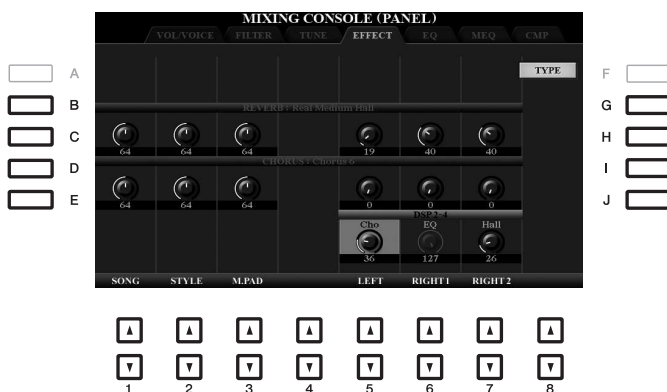

Use the [B]–[E] or [G]–[J] buttons to select the desired Effect Block, then use the [1 ▲▼]–[8 ▲▼] buttons to adjust the Effect Depth for each Part.

## Selecting an Effect Type for each Block

This section covers how to change the Effect Type of each Effect Block. The settings here can be saved to a Registration Memory, Song or Style.

- 1 Call up the desired page from **PANEL**, **STYLE** or **SONG** by pressing the [MIXER/EQ] button, repeatedly, if necessary.



**2** In the EFFECT page, press the [F] (TYPE) button to call up the Effect Type Selection display.

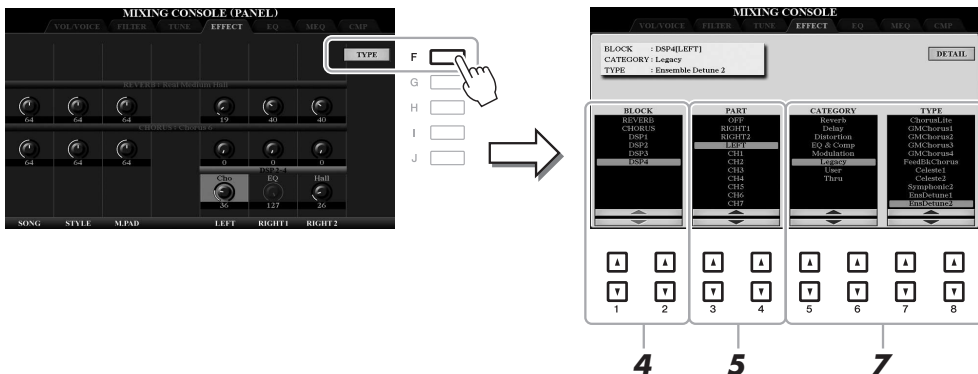

**3** Use the [1 ▲▼]/[2 ▲▼] buttons to select the Effect Block.

Effect Block	Effect-applicable parts	Effect characteristics
REVERB	All parts	Recreates the warm ambience of playing in a concert hall or jazz club.
CHORUS	All parts	Produces a richly textured sound as if several parts are being played simultaneously. In addition, other type effects (such as reverb, delay, etc.) can also be selected in this effect block.
DSP1	Style part, Song channel 1–16	In addition to Reverb and Chorus, a wide variety of Effect Types are provided, such as Distortion and Wah.
DSP2, DSP3, DSP4	RIGHT 1, RIGHT 2, LEFT, Song channel 1–16	In addition to Reverb and Chorus, a wide variety of Effect Types are provided, such as Distortion and Wah. For each of DSP2–4, you can select one of the Parts or Channels listed at left. When you select “RIGHT2” for DSP2, for example, the DSP2 Effect is applied only to the Right 2 part. Note that if you select a Song or Style which needs the DSP2–4 Blocks, the Part assignment of these three Blocks will be changed automatically with last priority according to the data.

**4** Use the [3 ▲▼]/[4 ▲▼] buttons to select the Part to which you want to apply the effect.

Note that a Part cannot be selected if “REVERB,” “CHORUS,” or “DSP1” (when the “Connection” parameter is set to “System;” see page 186) is selected. This is because only one of the Effect Types can be commonly applied to all available Parts.

**5** Use the [5 ▲▼]/[6 ▲▼] buttons to select the Category, and then use the [7 ▲▼]/[8 ▲▼] buttons to select the Effect Type.

Note that the Reverb Block is not divided into any Categories.

If you want to edit detailed Parameters of the selected Effect Type, press the [F] (DETAIL) button. For details, refer to the next section.

**6** Save the Effect Settings to a Registration Memory, Song or Style.

For instructions, refer to page 92.

## Editing and Saving Your Original Effect Type

You can edit detailed parameters of the selected Effect Type, and these settings can be saved as your original Effect Type as well as to a Registration Memory, Style or Song as described in the previous section. This section covers how to save the settings as an original Effect Type.

- 1 Once you've selected an Effect Block and Effect Type in the previous section, press the [F] (DETAIL) button to call up the display for editing the effect parameters.



- 2 Use the [3 ▲▼]–[5 ▲▼] buttons to select a parameter then use the [6 ▲▼]/[7 ▲▼] buttons to edit the value.

When Reverb, Chorus, or DSP is selected as the Effect Block, you can adjust the Return Level via the [8 ▲▼] (RETURN LEVEL) button. If you want to change the Effect Type, use the [1 ▲▼]/[2 ▲▼] buttons.

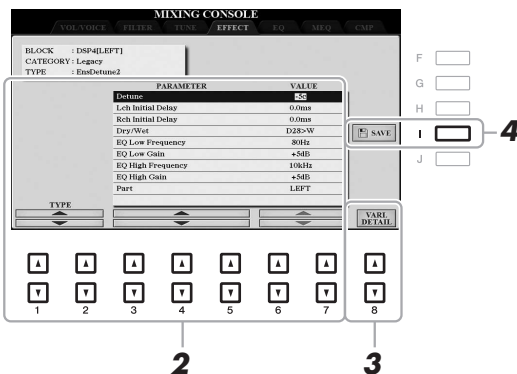

- 3 If DSP2, 3 or 4 is selected as the Effect Block, edit the Variation parameter if desired.

Press the [8 ▲▼] (VARI. DETAIL) button to call up the Variation parameter, select a parameter via the [2 ▲▼]–[4 ▲▼] buttons, and then use the [5 ▲▼]/[6 ▲▼] buttons to edit the value. This parameter is effective only when the [DSP VARI.] button lamp lights on the panel. To close this display, press the [EXIT] button.

**4** Press the [I] (SAVE) button to call up the display for the Save operation.

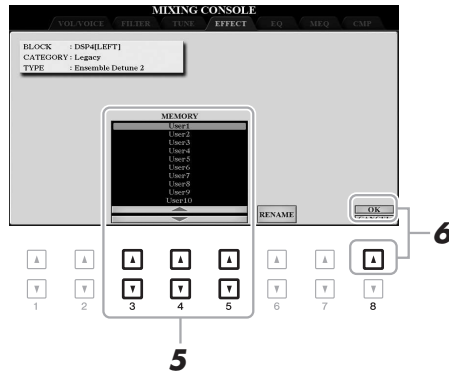

**5** Use the [3 ▲▼]–[5 ▲▼] buttons to select the destination for saving the settings as a User Effect.

If necessary, change the User Effect name. Press the [6 ▲▼] (RENAME) button to call up the Character Entry window, enter the name, and then press the [8 ▲] (OK) button.

**6** Press the [8 ▲] (OK) button to carry out the Save operation.

**7** Press the [EXIT] button to return to the previous display.

The saved User Effect can be selected from the “User” category of the corresponding Effect Block (page 185).

## Editing EQ Parameters

Equalizer (also called “EQ”) is a sound processor that divides the frequency spectrum into multiple bands that can be boosted or cut as required to tailor the overall frequency response.

The “EQ” page lets you adjust the EQ for each corresponding part, while the “MEQ” page lets you make overall EQ adjustments for the entire instrument.

### Editing Part EQ Parameters



[D]/[I]	EQ HIGH	Boosts or attenuates the high EQ band for each part.
[E]/[J]	EQ LOW	Boosts or attenuates the low EQ band for each part.

## Editing and Saving Your Original Master EQ (MEQ) Type

This instrument is equipped with a high-grade eight-band digital EQ. You can select one of the five preset EQ types, or can even create your own custom EQ settings by adjusting the frequency bands, and save the settings to one of two User Master EQ types.

**NOTE** This display can also be called up by pressing the [MASTER EQ] button.

**NOTE** Master EQ cannot be applied to audio playback or the metronome sound.

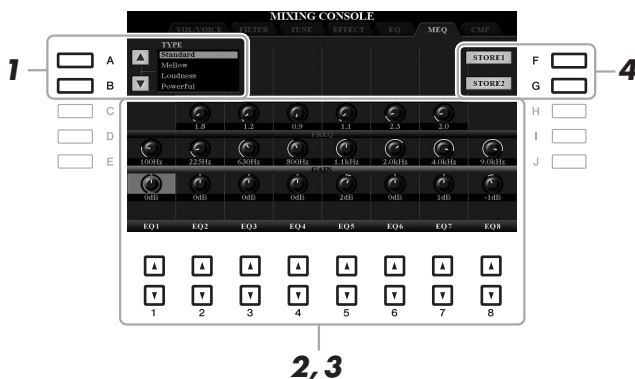

### 1 Use the [A]/[B] buttons to select the desired EQ type.

**Standard:** Standard EQ settings in which the instrument's characteristics are optimally brought out.

**Mellow:** Soft and mellow EQ settings in which high-frequency bands are reduced slightly.

**Loudness:** Clear EQ settings in which both the low- and high-frequency sounds are emphasized. This is a good match with up-tempo music.

**Powerful:** Powerful EQ settings in which all frequency sounds are emphasized. This can be used to boost the music for parties, etc.

**Flat:** Flat EQ settings. The gain of each frequency is set to 0dB.

**User1/2:** Your own custom EQ settings stored in step 4.

### 2 Use the [E]/[J] buttons to move the cursor to the GAIN row, then adjust the GAIN level to boost or cut each of the eight bands.

Use the [1 ▲▼]–[8 ▲▼] buttons to adjust the level. Changing the value while the [E] or [J] button is held lets you boost or cut all the eight bands at the same time.

### 3 If desired, adjust the Q (bandwidth) and the FREQ (center frequency) of each band.

To adjust the bandwidth (also called “Shape” or “Q”), use the [C]/[H] buttons to move the cursor to the Q row, then use the [2 ▲▼]–[7 ▲▼] buttons. The higher the value of Q, the narrower the band width.

To adjust the FREQ (center frequency), use the [D]/[I] buttons to move the cursor to the FREQ row, then use the [1 ▲▼]–[8 ▲▼] buttons. The available FREQ range is different for each band.

### 4 Press the [F] or [G] (STORE 1 or 2) button to carry out the Store operation.

In the Character Entry window called up via this operation, enter the name, and then press the [8 ▲] (OK) button to actually store your settings as a User Master EQ Type, which can be called up via the [A]/[B] buttons.

## Editing Master Compressor (CMP) Parameters

Compressor is an effect commonly used to limit and compress the dynamics (softness/loudness) of an audio signal. For signals that vary widely in dynamics, such as vocals and guitar parts, it “squeezes” the dynamic range, effectively making soft sounds louder and loud sounds softer. When used with gain to boost the overall level, this creates a more powerful, more consistently high-level sound.

This instrument features the Master Compressor applied to the entire sound of this instrument. Although the preset Master Compressor settings are provided, you can create and save your original Master Compressor by adjusting the related parameters.

**NOTE** Master Compressor cannot be applied to audio playback or the metronome sound.

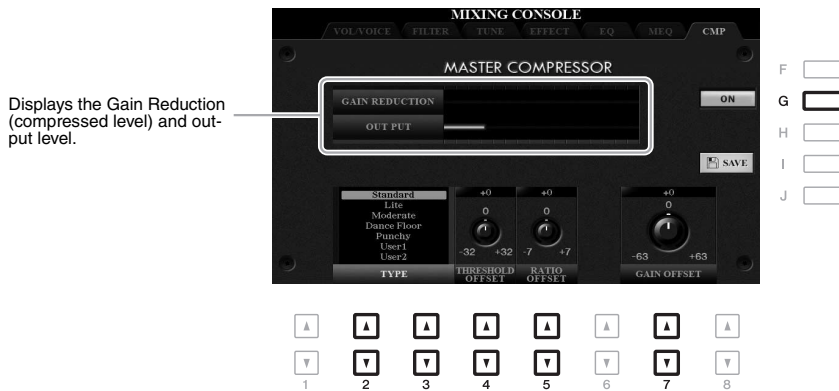

Displays the Gain Reduction (compressed level) and output level.

[G]	ON/OFF	Turns the Master Compressor effect on or off.
[2 ▲▼]/ [3 ▲▼]	TYPE	<p>Selects a Master Compressor type.</p> <p><b>Standard:</b> Standard Compressor settings.</p> <p><b>Lite:</b> Light Compressor settings in which the effect is slight.</p> <p><b>Moderate:</b> Moderate Compressor settings in which the effect is moderately pronounced.</p> <p><b>Dance Floor:</b> Relatively powerful Compressor settings to emphasize lower pitches.</p> <p><b>Punchy:</b> Highly exaggerated Compressor settings.</p> <p><b>User1–5:</b> Your own custom Compressor settings saved in the next section.</p>
[4 ▲▼]	THRESHOLD OFFSET	Determines the threshold (minimum level at which compression starts).
[5 ▲▼]	RATIO OFFSET	Determines the ratio of compression (how much the dynamic range is compressed).
[7 ▲▼]	GAIN OFFSET	Determines the output level.

## Saving Master Compressor Settings

The Master Compressor settings you have edited can be saved as a User Compressor type.

**1** Press the [I] (SAVE) button to enter the USER MASTER COMPRESSOR display.

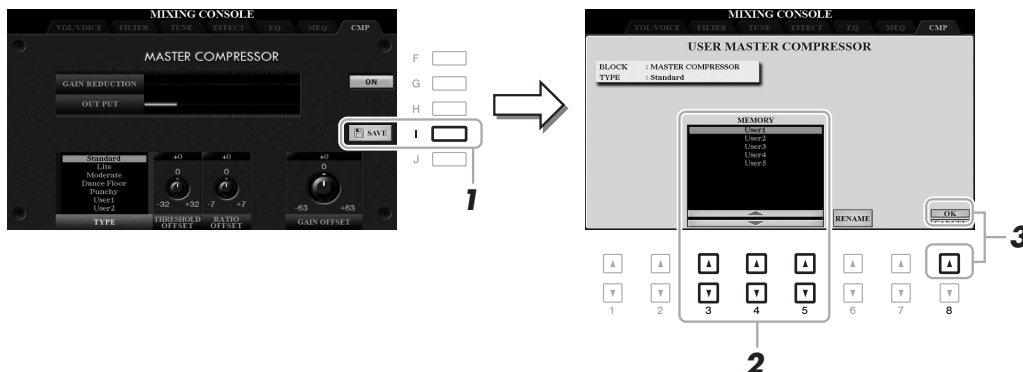

**2** Select the destination to which the User Master Compressor is to be saved, by using the [3 ▲▼]–[5 ▲▼] buttons.

If necessary, change the User Master Compressor name. Press the [6 ▲▼] (RENAME) button to call up the Character Entry window, enter the name then press the [8 ▲] (OK) button.

**3** Press the [8 ▲] (OK) button to carry out the Save operation.

**4** Press the [EXIT] button to return to the previous display.

The saved Master Compressor type is shown in the TYPE selection list.

## Block Diagram

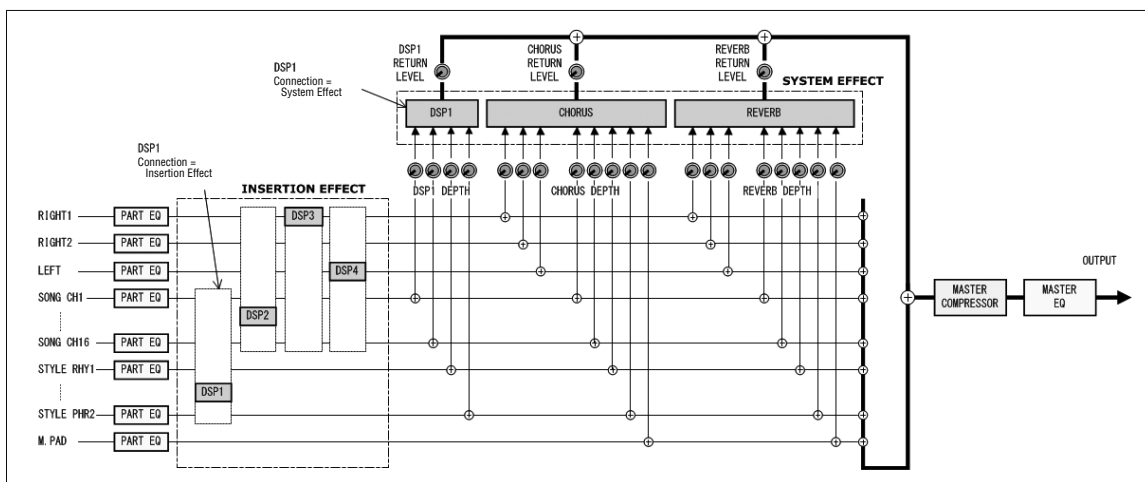

## Footswitch/Foot Controller Settings

### Assigning a Specific Function to Each Pedal

The functions of the foot pedals connected to the FOOT PEDAL [1]/[2] jacks can be changed individually from the default settings (sustain, etc.)—for example, letting you use the footswitch to start/stop Style playback, or use the foot controller to produce pitch bends.

**NOTE** For information on how to connect a foot pedal or what kinds of pedals can be connected, refer to page 93.

#### 1 Call up the operation display.

[FUNCTION] → TAB [◀] MENU 1 → [D] CONTROLLER → TAB [◀] FOOT PEDAL

#### 2 Use the [A]/[B] buttons to select one of the two foot pedals to which the function is to be assigned.

On the display, the numbers 1 and 2 correspond to the FOOT PEDAL jacks [1] and [2] respectively.

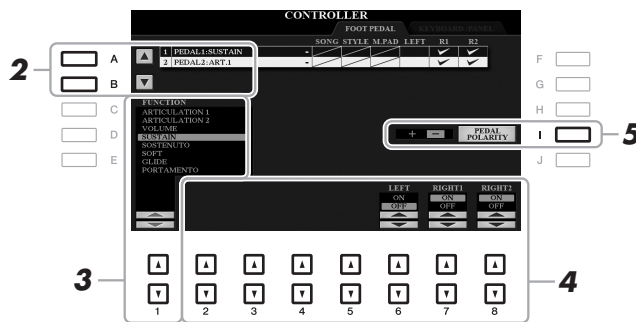

#### 3 Use the [1 ▲▼] buttons to select the function to be assigned to the pedal specified in step 2.

For information on available functions, see pages 192–193.

**NOTE** You can also assign other functions to the pedal—Punch in/out of Song (page 159) and Registration Sequence (page 178). If you assign multiple functions to the pedal, the priority is: Punch in/out of Song → Registration Sequence → Functions assigned here.

#### 4 Use the [2 ▲▼]–[8 ▲▼] buttons to set the details of the selected functions (the part for which the function is applied, etc.).

The available parameters differ depending on the function selected in step 3.

#### 5 If necessary, set the polarity of the pedal by using the [I] button.

Pedal on/off operation may differ depending on the particular pedal you've connected to the instrument. For example, pressing down on one pedal may turn the selected function on, while pressing a different make/brand of pedal may turn the function off. If necessary, use this setting to reverse the operation.

## ■ Assignable Pedal Functions

For functions indicated with “\*”, use only the foot controller; proper operation cannot be done with a footswitch.

ARTICULATION 1/2	When you use a Super Articulation Voice that has an effect assigned to the pedal/footswitch, you can enable the effect by pressing the pedal/footswitch. You can turn this pedal function on or off for each keyboard part on this display.
VOLUME*	Allows you to use a foot controller to control the volume. You can turn this pedal function on or off for each keyboard part on this display.
SUSTAIN	Allows you to use a pedal to control sustain. When you press and hold the pedal, all notes played on the keyboard have a longer sustain. Releasing the pedal immediately stops (damps) any sustained notes. You can turn this pedal function on or off for each keyboard part on this display.
SOSTENUTO	Allows you to use a pedal to control the Sostenuato effect. If you play a note or chord on the keyboard and press the pedal while holding the note(s), the notes will sustain as long as the pedal is held. However, all subsequent notes will not sustain. This makes it possible to sustain a chord, for example, while other notes are played staccato. You can turn this pedal function on or off for each keyboard part on this display. <b>NOTE</b> This function will not affect any of the Organ Flutes and only some of the Super Articulation Voices, even if this has been assigned to the foot pedals.
SOFT	Allows you to use a pedal to control the Soft effect. Pressing this pedal reduces the volume and changes the timbre of the notes you play. This is effective only for certain appropriate Voices. You can turn this pedal function on or off for each keyboard part on this display.
GLIDE	When the pedal is pressed, the pitch changes, and then returns to normal pitch when the pedal is released. You can turn this pedal function on or off for each keyboard part on this display. <b>UP/DOWN:</b> Determines whether the pitch change goes up (is raised) or down (is lowered). <b>RANGE:</b> Determines the range of the pitch change, in semitones. <b>ON SPEED:</b> Determines the speed of the pitch change when the pedal is pressed. <b>OFF SPEED:</b> Determines the speed of the pitch change when the pedal is released.
PORTAMENTO	The portamento effect (a smooth slide between notes) can be produced while the pedal is pressed. Portamento is produced when notes are played legato style (i.e., a note is played while the preceding note is still held). The portamento time can also be adjusted from the Mixing Console display (page 183). You can turn this pedal function on or off for each keyboard part on this display. <b>NOTE</b> This function will not affect any of the Organ Flutes and only some of the Super Articulation Voices, even if this has been assigned to the foot pedals.
PITCH BEND*	Allows you to bend the pitch of notes up or down by using the pedal. You can turn this pedal function on or off for each keyboard part on this display. <b>UP/DOWN:</b> Determines whether the pitch change goes up (is raised) or down (is lowered). <b>RANGE:</b> Determines the range of the pitch change, in semitones.
MODULATION (+)/(-) *	Applies modulation effects, such as vibrato, to notes played on the keyboard. You can turn this pedal function on or off for each keyboard part on this display.
MODULATION (ALT)	This is a slight variation on MODULATION above, in which the effects (waveform) can be alternately turned on/off by each press of the pedal/footswitch. You can turn this pedal function on or off for each keyboard part on this display.
DSP VARIATION	Same as the [DSP VARI.] button on the panel. You can turn this pedal function on or off for each keyboard part on this display.



PEDAL CONTROL (WAH)	Applies the wah effect to notes played on the keyboard when the [DSP] button is turned on. You can turn this pedal function on or off for each keyboard part on this display.
HARMONY/ARPEGGIO	Same as the [HARMONY/ARPEGGIO] button.
PEDAL (ARP. HOLD)	While the pedal is pressed, Arpeggio playback continues even after you release the keyboard, and then Arpeggio stops when the pedal is released. Make sure that any one of the Arpeggio type is selected and the [HARMONY/ARPEGGIO] button is turned on.
SCORE PAGE +/-	While the Song is stopped, you can turn to the next/previous score page (one page at a time).
LYRICS PAGE +/-	While the Song is stopped, you can turn to the next/previous lyrics page (one page at a time).
TEXT PAGE +/-	You can turn to the next/previous text page (one page at a time).
SONG PLAY/PAUSE	Same as the SONG [▶/■] (PLAY/PAUSE) button.
STYLE START/STOP	Same as the STYLE CONTROL [START/STOP] button.
TAP TEMPO	Same as the [TAP TEMPO] button.
SYNCHRO START	Same as the [SYNC START] button.
SYNCHRO STOP	Same as the [SYNC STOP] button.
INTRO 1–3	Same as the INTRO [I]–[III] buttons.
MAIN A–D	Same as the MAIN VARIATION [A]–[D] buttons.
FILL DOWN	Plays a fill-in, which is automatically followed by the previous Main section (that of the button on the immediate left).
FILL SELF	Plays a fill-in.
FILL BREAK	Plays a break.
FILL UP	Plays a fill-in, followed by the next Main section (that of the button on the immediate right).
ENDING1–3	Same as the ENDING/rit. [I]–[III] buttons.
HALF BAR FILL	While the pedal is pressed, the “Half bar fill-in” function is turned on and changing sections of a Style at the first beat of the current section starts the next section from the middle with automatic fill-in.
FADE IN/OUT	Same as the [FADE IN/OUT] button.
FING/ON BASS	The pedal alternately switches between the FINGERED and FINGERED ON BASS modes (page 120).
BASS HOLD	While the pedal is pressed, the Accompaniment Style bass note will be held even if the chord is changed during Style playback. If the fingering is set to “AI FULL KEYBOARD,” the function does not work.
PERCUSSION	The pedal plays a percussion instrument selected by the [4 ▲▼]–[8 ▲▼] buttons. You can use the keyboard to select the desired percussion instrument. <b>NOTE</b> When you select the percussion instrument by pressing a key on the keyboard, the velocity with which you press the key determines the percussion volume.
RIGHT 1 ON/OFF	Same as the PART ON/OFF [RIGHT 1] button.
RIGHT 2 ON/OFF	Same as the PART ON/OFF [RIGHT 2] button.
LEFT ON/OFF	Same as the PART ON/OFF [LEFT] button.
OTS +/-	Calls up the next/previous One Touch Setting.

## MIDI Settings

In this section, you can make MIDI-related settings for the instrument. The PSR-A3000 gives you a set of ten pre-programmed templates that let you instantly and easily reconfigure the instrument to match your particular MIDI application or external device. Also, you can edit the pre-programmed templates and save up to ten of your original templates to USER memory.

**NOTE** You can save all your original templates as a single file to internal memory (USER drive) or a USB flash drive: [FUNCTION] → TAB [▶] MENU 2 → [G] SYSTEM → TAB [◀][▶] SETUP FILES → [G] MIDI SETUP FILES. See page 207.

### 1 Call up the operation display.

[FUNCTION] → TAB [◀] MENU 1 → [I] MIDI

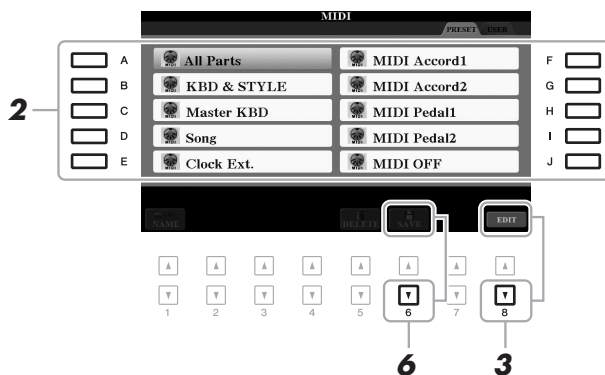

### 2 Select a pre-programmed template from the PRESET page (page 195).

If you have already created your original template and saved it to the USER page, you can also select that template from the USER page.

### 3 To edit the template, press the [8 ▼] (EDIT) button to call up the MIDI display.

### 4 Use the TAB [◀][▶] buttons to call up the relevant page, then set various parameters to edit the current MIDI template.

- **SYSTEM** ..... MIDI System Settings (page 196)
- **TRANSMIT** ..... MIDI Transmit Settings (page 197)
- **RECEIVE** ..... MIDI Receive Settings (page 198)
- **BASS** ..... Bass Note Settings for Style Playback via MIDI Receive (page 199)
- **CHORD DETECT** ..... Chord Type Settings for Style Playback via MIDI Receive (page 199)

### 5 When you've finished editing, press the [EXIT] button to return to the MIDI template Selection display.

### 6 Select the USER tab by pressing the TAB [▶] button, then press the [6 ▼] (SAVE) button to save the edited template.

## ■ Pre-programmed MIDI Templates

All Parts	Transmits all parts including the keyboard parts (RIGHT 1, 2, and LEFT), with the exception of Song parts.
KBD & STYLE	Basically the same as “All Parts” with the exception of how keyboard parts are managed. The right-hand parts are handled together as “UPPER” instead of RIGHT 1 and 2, and the left-hand part is handled as “LOWER.”
Master KBD	In this setting, the instrument functions as a “master” keyboard, playing and controlling one or more connected tone generators or other devices (such as a computer/sequencer).
Song	All transmit channels are set to correspond to Song channels 1–16. This is used to play Song data with an external tone generator and to record Song data to an external sequencer.
Clock Ext.	Playback or recording (Song, Style, Multi Pad, etc.) synchronizes with an external MIDI clock instead of the instrument’s internal clock. This template should be used when you wish to set the tempo on the MIDI device connected to the instrument.
MIDI Accord 1	MIDI accordions allow you to transmit MIDI data and play connected tone generators from the keyboard and bass/chord buttons of the accordion. This template lets you play melodies from the keyboard and control Style playback on the instrument with the left-hand buttons.
MIDI Accord 2	Basically the same as “MIDI Accord1” above, with the exception that the chord/bass notes you play with your left hand on the MIDI Accordion are recognized also as MIDI note events.
MIDI Pedal 1	MIDI pedal units allow you play connected tone generators with your feet (especially convenient for playing single note bass parts). This template lets you play/control the chord root in Style playback with a MIDI pedal unit.
MIDI Pedal 2	This template lets you play the bass part for Style playback by using a MIDI pedal unit.
MIDI OFF	No MIDI signals are sent or received.

# MIDI System Settings

The explanations here apply to the SYSTEM page in step 4 on page 194.

Use the [A]/[B] buttons to select the parameters (below), then set the ON/OFF status, etc. by using the [1 ▲▼]–[8 ▲▼] buttons.

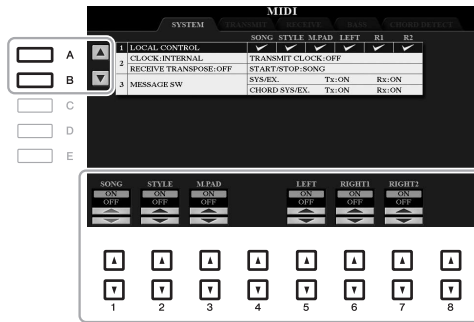

## 1 Local Control

Turns the Local Control for each part on or off. When Local Control is set to “ON,” the keyboard of the instrument controls its own (local) internal tone generator, allowing the internal Voices to be played directly from the keyboard. If you set Local to “OFF,” the keyboard and controllers are internally disconnected from the instrument’s tone generator section so that no sound is output when you play the keyboard or use the controllers. For example, this allows you to use an external MIDI sequencer to play the instrument’s internal Voices, and use the instrument keyboard to record notes to the external sequencer and/or play an external tone generator.

## 2 Clock setting, etc.

### ■ CLOCK

Determines whether the instrument is controlled by its own internal clock or a MIDI clock signal received from an external device. INTERNAL is the normal Clock setting when the instrument is being used alone or as a master keyboard to control external devices. If you are using the instrument with an external sequencer, MIDI computer, or other MIDI device, and you want to synchronize it to that device, set this parameter to the appropriate setting: MIDI, USB 1, or USB 2. In this case, make sure that the external device is connected properly (e.g., to the instrument’s MIDI IN terminal), and that it is properly transmitting a MIDI clock signal.

**NOTE** When CLOCK is set to a value other than INTERNAL, the tempo is indicated as “Ext.” on the Main display. This means that playback of this instrument is controlled only from an external MIDI device or computer. In this condition, Styles, Songs, Multi Pads or the Metronome cannot be played back even if you carry out the start operation.

**NOTE** When a USB wireless LAN adaptor is connected to the [USB TO DEVICE] terminal, the “WIRELESS LAN” parameter can also be selected.

### ■ TRANSMIT CLOCK

Turns MIDI clock (F8) transmission on or off. When set to OFF, no MIDI clock or Start/Stop data is transmitted even if a Song or Style is played back.

### ■ RECEIVE TRANSPOSE

Determines whether or not the instrument’s transpose setting is applied to the note events received by the instrument via MIDI.

### ■ START/STOP

Determines whether incoming FA (start) and FC (stop) messages affect Song or Style playback.

## 3 MESSAGE SW (Message Switch)

### ■ SYS/EX.

The “Tx” setting turns MIDI transmission of MIDI System Exclusive messages on or off. The “Rx” setting turns MIDI reception and recognition of MIDI System Exclusive messages generated by external equipment on or off.

### ■ CHORD SYS/EX.

The “Tx” setting turns MIDI transmission of MIDI chord exclusive data (chord detect. root and type) on or off. The “Rx” setting turns MIDI reception and recognition of MIDI chord exclusive data generated by external equipment on or off.

## MIDI Transmit Settings

The explanations here apply to the TRANSMIT page in step 4 on page 194. This determines which parts will be sent as MIDI data and over which MIDI channel the data will be sent.

PART	CHANNEL	NOTE	CC	PC	PB	AT
RIGHT1	OFF					
RIGHT2	OFF					
LEFT	OFF					
UPPER	PORT 1 CH1					
LOWER	PORT 1 CH2	✓	✓		✓	
MULTI PADD1	OFF					
MULTI PADD2	OFF					
MULTI PADD3	OFF					

1 Use the [A]/[B] buttons or [1 ▲▼]/[2 ▲▼] buttons to select the part for changing transmit settings.

The Parts listed on this display are the same as those shown in the MIXING CONSOLE display and CHANNEL ON/OFF display with the exception of the two parts below.

**UPPER:** A keyboard part played on the right side of the keyboard from the Split Point for the Voices (RIGHT 1 and/or 2).

**LOWER:** A keyboard part played on the left side of the keyboard from the Split Point for the Voices. This is not affected by the on/off status of the [ACMP] button.

2 Use the [3 ▲▼] buttons to select a channel via which the selected part will be transmitted.

**NOTE** If the same transmit channel is assigned to several different parts, the transmitted MIDI messages are merged to a single channel—resulting in unexpected sounds and possible glitches in the connected MIDI device.

**NOTE** Protected Songs cannot be transmitted even if the proper Song channels 1–16 are set to be transmitted.

3 Use the [4 ▲▼]–[8 ▲▼] button to determine the types of data to be sent.

For information on the MIDI messages which can be set here, see “Note Events” on page 166.

**NOTE** If “WLAN” is shown, this instrument can handle MIDI messages received via the USB wireless LAN adaptor connected to the [USB TO DEVICE] terminal. When “WLAN” is not shown although the USB wireless LAN adaptor is connected, turn the instrument off then on again.

### 1 Use the [A]/[B] buttons or [1 ▲▼]/[2 ▲▼] buttons to select the part for changing transmit settings.

The Parts listed on this display are the same as those shown in the MIXING CONSOLE display and CHANNEL ON/OFF display with the exception of the two parts below.

**UPPER:** A keyboard part played on the right side of the keyboard from the Split Point for the Voices (RIGHT 1 and/or 2).

**LOWER:** A keyboard part played on the left side of the keyboard from the Split Point for the Voices. This is not affected by the on/off status of the [ACMP] button.

### 2 Use the [3 ▲▼] buttons to select a channel via which the selected part will be transmitted.

**NOTE** If the same transmit channel is assigned to several different parts, the transmitted MIDI messages are merged to a single channel—resulting in unexpected sounds and possible glitches in the connected MIDI device.

**NOTE** Protected Songs cannot be transmitted even if the proper Song channels 1–16 are set to be transmitted.

### 3 Use the [4 ▲▼]–[8 ▲▼] button to determine the types of data to be sent.

For information on the MIDI messages which can be set here, see “Note Events” on page 166.

## MIDI Receive Settings

The explanations here apply to the RECEIVE page in step 4 on page 194. This determines which parts will receive MIDI data and over which MIDI channels the data will be received.

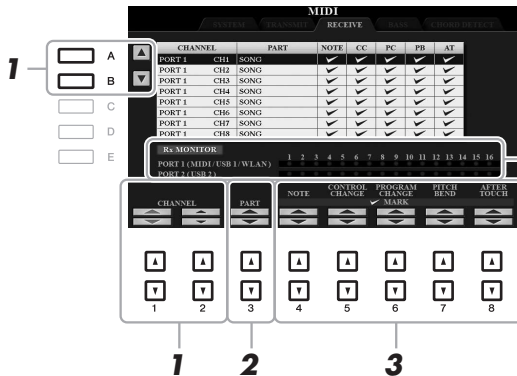

The dots corresponding to each channel (1-16) flash briefly whenever any data is received on the channel(s).

**NOTE** If "WLAN" is shown, this instrument can handle MIDI messages received via the USB wireless LAN adaptor connected to the [USB TO DEVICE] terminal. When "WLAN" is not shown although the USB wireless LAN adaptor is connected, turn the instrument off then on again.

### 1 Use the [A]/[B] buttons or [1 ▲▼]/[2 ▲▼] buttons to select the channel to be received.

The instrument can receive MIDI messages over 32 channels (16 channels x 2 ports) by USB connection.

### 2 Use the [3 ▲▼] buttons to select the part via which the selected channel will be received.

The Parts listed on this display are the same as those shown in the MIXING CONSOLE display and CHANNEL ON/OFF display with the exception of the following parts.

**KEYBOARD:** The received note messages control the instrument's keyboard performance.

**EXTRA PART 1-5:** There are five parts specially reserved for receiving and playing MIDI data. Normally, these parts are not used by the instrument itself. The instrument can be used as a 32-channel multi-timbral tone generator by using these five parts in addition to the parts.

### 3 Use the [4 ▲▼]–[8 ▲▼] button to determine the types of data to be received.

For information on the MIDI messages which can be set here, see "Note Events" on page 166.

#### MIDI transmission/reception via the USB terminals and MIDI terminals

The relationship between the MIDI terminals and the USB terminals which can be used for transmitting/receiving 32 channels (16 channels x 2 ports) of the MIDI messages is as follows:

##### • MIDI reception

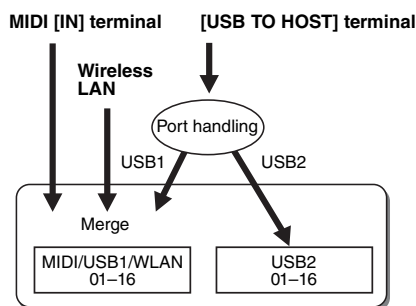

##### • MIDI transmission

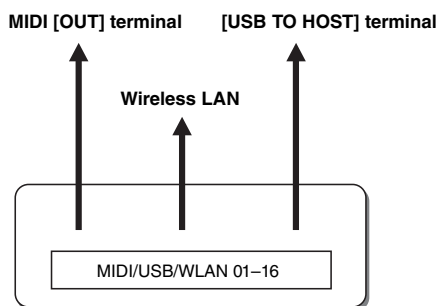

## Bass Note Settings for Style Playback via MIDI Receive

The explanations here apply to the BASS page in step 4 on page 194. These settings let you determine the bass note for Style playback, based on the note messages received via MIDI. The note on/off messages received at the channel(s) set to “ON” are recognized as the bass note of the chord of Style playback. The bass note will be detected regardless of the [ACMP] or split point settings. When several channels are simultaneously set to “ON,” the bass note is detected from merged MIDI data received over the channels.

The screenshot shows the MIDI BASS settings screen. On the left, a control panel has buttons A, B, C, D, E and a numeric keypad 1-8. On the right, another control panel has buttons F, G, H, I, J. The main screen displays two ports (PORT 1 and PORT 2) with 16 channels each. Below the ports are 8 channels (CH 1-8) with ON/OFF buttons. A note indicates that dots on the channels flash when data is received.

**NOTE** If “WLAN” is shown, this instrument can handle MIDI messages received via the USB wireless LAN adaptor connected to the [USB TO DEVICE] terminal. When “WLAN” is not shown although the USB wireless LAN adaptor is connected, turn the instrument off then on again.

**1** Use the [A]/[B] buttons to select the channel.

**2** Use the [1 ▲▼]–[8 ▲▼] button to set the desired channel to ON or OFF.

You can also set all channels to OFF by pressing the [F] (ALL OFF) button.

## Chord Type Settings for Style Playback via MIDI Receive

The explanations here apply to the CHORD DETECT page in step 4 on page 194. This page lets you select the MIDI channels over which the MIDI data from the external device will be used to detect the Chord Type for Style playback. The note on/off messages received at the channel(s) set to “ON” are recognized as the notes for detecting chords in Style playback. The chords to be detected depend on the fingering type. The chord types will be detected regardless of the [ACMP] or split point settings. When several channels are simultaneously set to “ON,” the chord type is detected from merged MIDI data received over the channels.

The screenshot shows the MIDI CHORD DETECT settings screen. On the left, a control panel has buttons A, B, C, D, E and a numeric keypad 1-8. On the right, another control panel has buttons F, G, H, I, J. The main screen displays two ports (PORT 1 and PORT 2) with 16 channels each. Below the ports are 8 channels (CH 1-8) with ON/OFF buttons.

The operation procedure is basically the same as that of the BASS display above.

## Connecting with an iPhone/iPad via Wireless LAN

By using a USB wireless LAN adaptor (sold separately), you can connect the PSR-A3000 with an iPhone/iPad via a wireless network. For general operating instructions, refer to the “iPhone/iPad Connection Manual” on the website. This section covers only operations that are specific to the PSR-A3000.

Before starting operations, make sure that the USB wireless LAN adaptor is connected to the [USB TO DEVICE] terminal and call up the setup display via [FUNCTION] → TAB [▶] MENU 2 → [H] WIRELESS LAN.

**NOTE** If the USB wireless LAN adaptor is not recognized by the instrument, “WIRELESS LAN” for the [H] button is not shown. When “WIRELESS LAN” is not shown even though a USB wireless LAN adaptor has been connected, turn the instrument off then on again.

### Infrastructure Mode

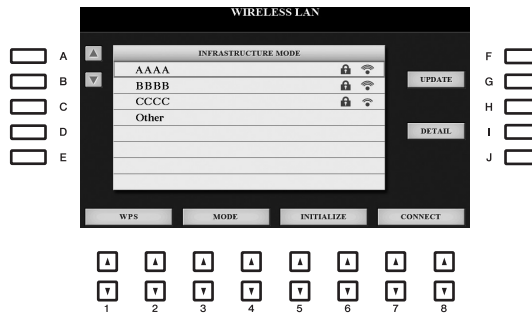

[A]/[B]		Selects the network.
[G]	UPDATE	Updates the network list on the display.
[I]	DETAIL	For setting the detailed parameters on the pages below. After making these settings, press one of the [7 ▲▼]/[8 ▲▼] (SAVE) button to actually save them.  <b>IP ADDRESS:</b> Sets the IP address and other related parameters.  <b>OTHERS:</b> When the instrument is connected to the network with the Infrastructure Mode, the current time is shown on the Main display. You can set the Time Zone via the [B] button and Daylight Saving Time via the [C] button for your local time. If you want to enter the host name, press the [A] button.
[1 ▲▼]/ [2 ▲▼]	WPS	Connects this instrument to the network via WPS. Press this button followed by the [G] (YES) button, then press the WPS button on your access point within two minutes.
[3 ▲▼]/ [4 ▲▼]	MODE	Switches to the Access Point Mode.
[5 ▲▼]/ [6 ▲▼]	INITIALIZE	Initializes the connection setup to the default factory status.
[7 ▲▼]/ [8 ▲▼]	CONNECT	Connects to the selected network. If you select “Other” by using the [A]/[B] buttons, this calls up the Manual Setup display in which you set the SSID, security method, and password. After entering those, press one of the [7 ▲▼]/[8 ▲▼] buttons in the Manual Setup display to connect to the network.



# Access Point Mode

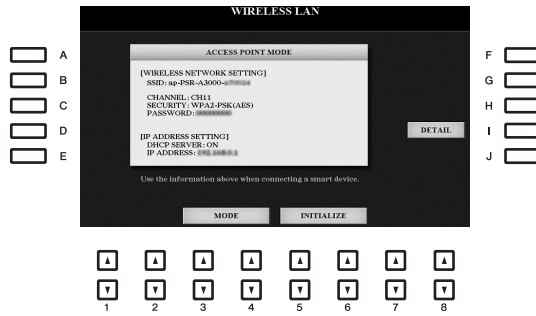

[1]	DETAIL	<p>For setting the detailed parameters on the pages below. After making these settings, press one of the [7 ▲▼]/[8 ▲▼] (SAVE) button to actually save them.</p> <p><b>WIRELESS NETWORK:</b> For setting the SSID, security, password, and channel.</p> <p><b>IP ADDRESS:</b> For setting the IP address and other related parameters.</p> <p><b>OTHERS:</b> For entering the Host name or showing MAC address, etc.</p>
[3 ▲▼]/ [4 ▲▼]	MODE	Switches to the Infrastructure Mode.
[5 ▲▼]/ [6 ▲▼]	INITIALIZE	Initializes the connection setup to the default factory status.

# Other Functions

This section covers only the UTILITY and SYSTEM displays in the FUNCTION menu. For other displays, refer to the “Function List” on page 209 to see where you can find the instructions.

## UTILITY

### CONFIG 1

Use the [A]/[B] buttons to select the desired parameter.

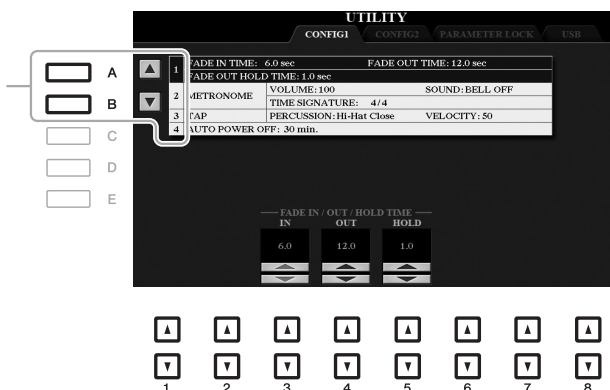

#### 1 Fade In/Out

These parameters determine how Style or Song playback is faded in/out when using the [FADE IN/OUT] button.

[3 ▲▼]	FADE IN TIME	Determines the time it takes for the volume to fade in, or go from minimum to maximum (range of 0–20.0 seconds).
[4 ▲▼]	FADE OUT TIME	Determines the time it takes for the volume to fade out, or go from maximum to minimum (range of 0–20.0 seconds).
[5 ▲▼]	FADE OUT HOLD TIME	Determines the time the volume is held at 0 following the fade out (range of 0–5.0 seconds).

#### 2 Metronome

[2 ▲▼]	VOLUME	Determines the volume of the metronome sound.
[3 ▲▼]– [5 ▲▼]	SOUND	Determines whether a bell accent is sounded or not at the first beat of each measure.
[6 ▲▼]/ [7 ▲▼]	TIME SIGNATURE	Determines the time signature of the metronome sound.

### 3 Tap

This allows you to set the percussion sound and the velocity which sounds when the [TAP TEMPO] button is tapped.

[2 ▲▼]- [4 ▲▼]	PERCUSSION	Selects the percussion sound.
[5 ▲▼]/ [6 ▲▼]	VELOCITY	Sets the velocity.

### 4 Auto Power Off

For details, refer to page 17.

## CONFIG 2

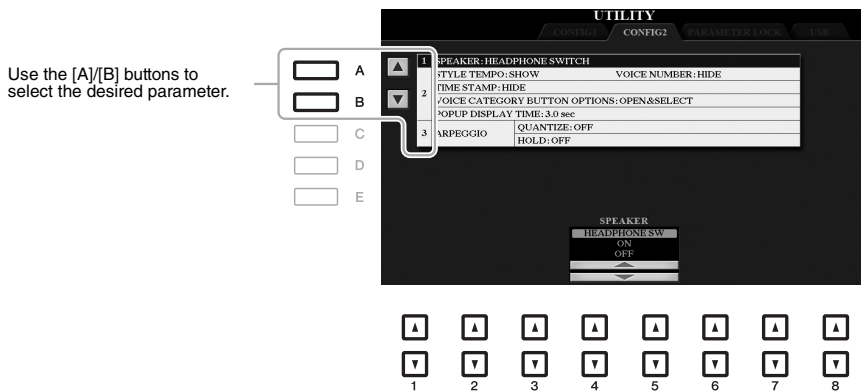

### 1 Speaker setting

[4 ▲▼]/ [5 ▲▼]	SPEAKER	<p>Determines whether or not the sound is output from the speaker of this instrument.</p> <p><b>HEADPHONE SW:</b> Speaker sounds normally, but is cut off when headphones are connected to the [PHONES] jack.</p> <p><b>ON:</b> Speaker sound is always on, even if headphones are connected.</p> <p><b>OFF:</b> Speaker sound is off. You can only hear the instrument sound via the headphones or an external device connected to the AUX OUT jacks.</p>
-------------------	---------	--

## 2 Display-related settings / Voice Category Button Options

[1 ▲▼]	STYLE TEMPO	Determines whether the default tempo of each preset Style is shown or hidden above the Style name in the Style Selection display.
[2 ▲▼]	VOICE NUMBER	Determines whether the Voice bank and number are shown or hidden in the Voice Selection display. Displaying these is helpful when you want to check which bank select MSB/LSB values and program change number you need to specify when selecting the Voice from an external MIDI device.  <b>NOTE</b> The numbers displayed here start from "1." Accordingly the actual MIDI program change numbers are one lower, since that number system starts from "0."  <b>NOTE</b> For the GS Voices, the program change numbers are not available even when this parameter is set to ON.
[3 ▲▼]	TIME STAMP	Determines whether the updated date and time are shown or hidden on the File Selection display. When you connect the instrument to the network with the Infrastructure Mode (page 200) by using the USB wireless adaptor (UD-WL01), the instrument gets the "clock" information and the current timestamp (date and time) is recorded to the files you save to the instrument. Once you turn the power off, the clock is set to the factory default and will not be updated unless the instrument is connected to the network.
[5 ▲▼]/ [6 ▲▼]	VOICE CATEGORY BUTTON OPTIONS	Determines how the Voice Selection display is opened when one of the VOICE buttons is pressed.  <b>OPEN &amp; SELECT:</b> Opens the Voice Selection display with the previously selected Voice in the Voice category automatically selected (when one of the VOICE buttons is pressed).  <b>OPEN ONLY:</b> Opens the Voice Selection display with the currently selected Voice (when one of the VOICE buttons is pressed).
[7 ▲▼]/ [8 ▲▼]	POPUP DISPLAY TIME	Determines the time in which the pop-up displays close. (Pop-up displays are shown when you press buttons such as TEMPO, TRANSPOSE or UPPER OCTAVE, etc.)

## 3 Arpeggio settings

[3 ▲▼]/ [4 ▲▼]	QUANTIZE	Determines the timing of the Arpeggio Quantize function. Arpeggio playback is synchronized with Song or Style playback, and any slight imperfections are corrected in this timing.
[5 ▲▼]/ [6 ▲▼]	HOLD ON/OFF	Turns on or off the Arpeggio Hold function. When this is set to ON, turning the [HARMONY/ARPEGGIO] button on makes Arpeggio playback continue even after the note has been released. To stop playback, press the [HARMONY/ARPEGGIO] button again.

## PARAMETER LOCK

This lets you lock or maintain the settings of specific parameters (such as Effect and Split Point), even when the panel setups are changed by Registration Memory, One Touch Setting, etc.

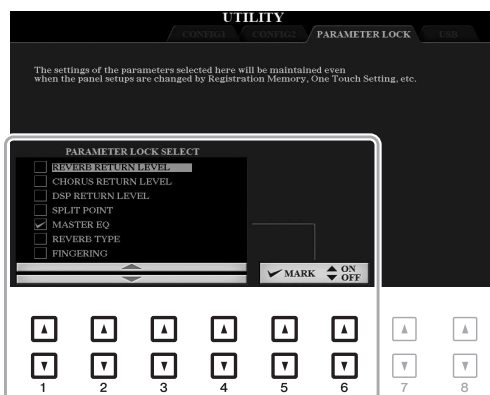

To set this function, use the [1 ▲▼]–[4 ▲▼] buttons to select the desired parameter then use the [5 ▲▼]/[6 ▲▼] buttons to enter or remove the checkmarks. Repeat this step as desired. Items having checkmarks will be locked.

## USB

You can set or carry out important USB flash drive-related operations for the instrument. Before using a USB flash drive, be sure to read “Connecting USB Devices” on page 95.

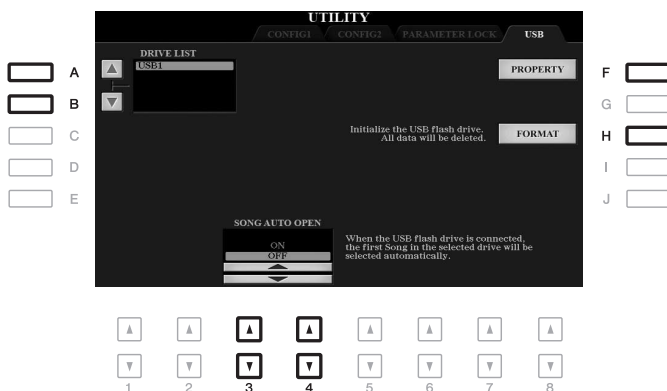

[A]/[B]	DRIVE LIST	Selects the desired drive to be formatted or to be checked for remaining memory.
[F]	PROPERTY	Opens the Property display of the device selected above by the [A]/[B] buttons. You can check the amount of remaining memory on the device. <b>NOTE</b> The displayed remaining memory value is an approximate value.
[H]	FORMAT	Formats the drive selected above by the [A]/[B] buttons. For instructions, refer to page 96.
[3 ▲▼]/ [4 ▲▼]	SONG AUTO OPEN	Turns the Song Auto Open function on or off. When this is set to “ON,” simply connecting the USB flash drive (selected in the Device List above) calls up the first Song in the USB flash drive.

# SYSTEM

## OWNER

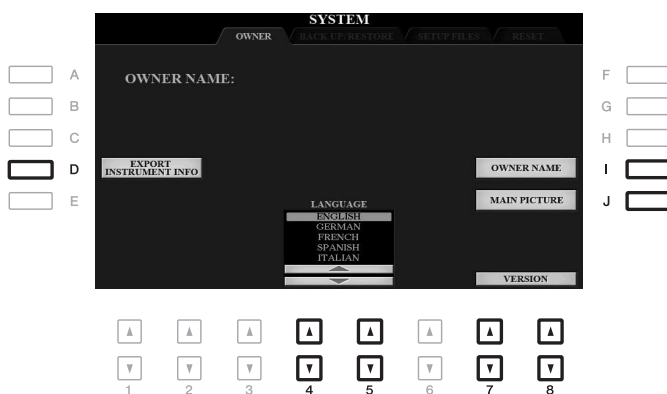

[D]	EXPORT INSTRUMENT INFO	For exporting identification information of the instrument, which may be necessary for using the “Yamaha Expansion Manager” software, to the root directory of the USB flash drive (page 47).
[I]	OWNER NAME	Lets you enter your name as the owner. The Owner name is indicated on the opening display when you turn the power on. For instructions on entering characters, refer to page 32.
[J]	MAIN PICTURE	Lets you select a background picture for the Main display. You can select a picture from among various pictures provided on the PRESET page. After selecting, press the [EXIT] button to close the Selection display. If you want to use an original picture, prepare the desired file (a bitmap “.BMP” file no greater than 800 x 480 pixels) in the USB flash drive, copy it from the USB flash drive to the USER page, then select it from the USER page. Due to access speed limitations, it is not recommended to select the desired file from the USB flash drive. <b>NOTE</b> The explanation about picture compatibility above applies also to the background of the Song Lyric display (page 145).
[4 ▲▼]/ [5 ▲▼]	LANGUAGE	Determines the language used for the display messages. Once you change this setting, all messages will be shown in the selected language.
[7 ▲▼]/ [8 ▲▼]	VERSION	Displays the program version and the hardware ID of this instrument.

## BACKUP/RESTORE

Refer to page 34.

## SETUP FILES

For the items below, you can save your original settings to USER or USB drive as a single file for future recall.

- 1 Make all desired settings on the instrument.**
- 2 Call up the operation display.**

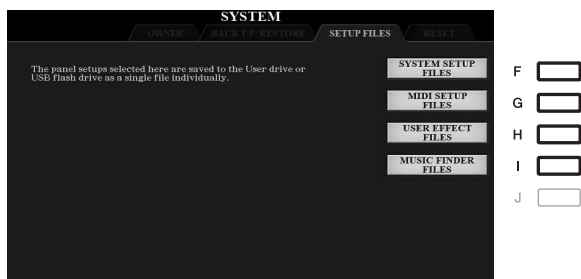

- 3 Use the [F]–[I] buttons to call up the relevant display for saving your data.**

[F]	SYSTEM SETUP FILES	Parameters set on the various displays such as the [FUNCTION] → TAB [◀] MENU 1 → [J] UTILITY are handled as a single System Setup file. Refer to the “Parameter Chart” in the Data List on the website for details on which parameters belong to System Setup.
[G]	MIDI SETUP FILES	The MIDI settings including the MIDI Setups on the USER tab display are handled as a single file.
[H]	USER EFFECT FILES	The following data can be managed as a single file. <ul style="list-style-type: none"> <li>• User Effect types ..... page 186</li> <li>• User Master EQ types ..... page 188</li> <li>• User Master Compressor types ..... page 189</li> </ul>
[I]	MUSIC FINDER FILES	All the preset and created Records of the Music Finder are handled as a single file.

- 4 Use the TAB [◀][▶] buttons to select one of the tabs (USER or USB) to which your settings will be saved.**
- 5 Press the [6 ▼] (SAVE) button to save your file.**
- 6 To recall your file, press the desired [F]–[I] button in the SETUP FILES display, then select the desired file.**

If you want to call up the factory default files, select the file in the PRESET tab.

When the file is selected, a message is displayed according to the content of the file. Press the desired button.

## RESET

This function lets you restore the status of the instrument to the original factory settings.

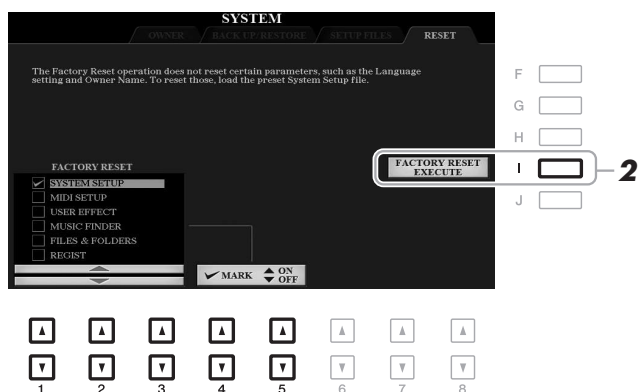

### 1 Use the [1 ▲▼]–[3 ▲▼] buttons to select the desired item then use the [4 ▲▼]/[5 ▲▼] buttons to enter or remove the checkmark.

When an item is checkmarked, the corresponding parameters will be reset as described below:

SYSTEM SETUP	Resets the System Setup parameters to the original factory settings. Refer to the “Parameter Chart” in the Data List on the website for details about which parameters belong to System Setup.
MIDI SETUP	Resets the MIDI settings including the MIDI Setups on the USER tab display to the original factory status.
USER EFFECT	Resets the current Effect settings and the following data: <ul style="list-style-type: none"> <li>• User Effect types ..... page 186</li> <li>• User Master EQ types ..... page 188</li> <li>• User Master Compressor types ..... page 189</li> </ul>
MUSIC FINDER	Resets the Music Finder data (all Records) to the original factory settings.
FILES & FOLDERS	Deletes all files and folders including the Expansion folder stored in the USER tab display.
REGIST	Turns off all the Registration Memory [1]–[8] lamps, indicating that no Registration Memory Bank is selected although all the Registration Memory Bank files are maintained. In this status, you can create Registration Memory setups from the current panel settings. <p><b>NOTE</b> The same operation can be done by turning the power on while holding the B5 key (rightmost B key). In this case, you can create Registration Memory setups from the default panel settings.</p>

### 2 Press the [I] (FACTORY RESET EXECUTE) button to carry out the Factory Reset operation for all checkmarked items.



# Function List

This list briefly explains what you can do in the displays which are called up via the [FUNCTION] button. For more information, refer to the page references indicated below.

MENU 1		Description	Page
A	SPLIT POINT/CHORD FINGERING	SPLIT POINT	page 58
		CHORD FINGERING	pages 53, 120
B	HARMONY/ARPEGGIO	For selecting the Harmony type or the Arpeggio type.	pages 42, 106
C	REGIST SEQUENCE/FREEZE	REGISTRATION SEQUENCE	Determines the order for calling up Registration Memory settings when using the TAB [◀ ▶] buttons or the pedal.
		FREEZE	Determines the setting groups (Voice, Style, etc.) that are to remain unchanged even when you call up panel setups via Registration Memory.
D	CONTROLLER	FOOT PEDAL	Determines the functions assigned to the pedals.
		KEYBOARD/PANEL	For setting the Touch Response of the keyboard, or selecting the part(s) to be affected by the joystick or the TRANSPOSE [-]/[+] buttons.
E	MASTER TUNE/SCALE TUNE	MASTER TUNE	For fine-tuning the pitch of the entire instrument in approx. 0.2 Hz steps.
		SCALE TUNE	Determines the scale type and tuning of the pitch of the desired note (key) in cents.
F	VOICE SET FILTER	For disabling automatic selection of Voice Sets (effects, etc.).	page 117
G	STYLE SETTING	For making Style playback related settings such as Stop Accompaniment, Dynamics Control, etc.	page 122
H	SONG SETTING	For making Song playback related settings such as Guide Function, Channel settings, Repeat settings, etc.	page 147
I	MIDI	For making MIDI-related settings.	page 194
J	UTILITY	CONFIG 1	For making general settings such as Fade in/out time, metronome sound, Tap Tempo sound, Auto Power Off.
		CONFIG 2	For making general settings such as speaker, display, etc.
		PARAMETER LOCK	Determines the parameters (effect, Split Point, etc.) that are to remain unchanged when the panel setups are changed via Registration Memory, One Touch Setting, etc.
		USB	Contains operations related to a connected USB flash drive, such as formatting and confirmation of memory size.
MENU 2		Description	Page
A	STYLE CREATOR	For creating a Style by editing the preset Style, or by recording Style channels one by one.	page 125
B	SONG CREATOR	For creating a Song by editing the recorded Song or by entering events one by one.	page 151
C	MULTI PAD CREATOR	For creating a Multi Pad by editing an existing preset Multi Pad, or by recording a new one.	page 168
F	PACK INSTALLATION	For installing Expansion Packs for adding extra contents downloaded from the website or created on your own by using the Yamaha Expansion Manager.	page 46
G	SYSTEM	OWNER	For setting the Owner name, Message language, etc.
		BACKUP/RESTORE	For backing up or restoring the settings and data saved in the USER drive of the instrument.
		SETUP FILES	For saving and recalling the specified settings of the instrument.
		RESET	For restoring instrument settings to their factory defaults.
H	WIRELESS LAN	For making settings for connecting the instrument to a smart device, such as an iPad, via wireless LAN. This appears only when a USB wireless LAN adaptor is connected.	page 200

# Direct Access Chart

Press the [DIRECT ACCESS] button, then press one of the buttons (or move the joystick or pedal) listed below to call up the desired display.

Control		Display called up with the Direct Access function				
STYLE CONTROL	[ACMP]	FUNCTION	SPLIT POINT/CHORD FINGERING	CHORD FINGERING		
	[AUTO FILL IN]			STYLE SETTING		
	[OTS LINK]					
	[BREAK]					
	INTRO [I], [II], [III]					
	MAIN VARIATION [A], [B], [C], [D]					
	ENDING/rit. [I], [II], [III]					
	[SYNC START]		SPLIT POINT/CHORD FINGERING	SPLIT POINT		
[SYNC STOP]	STYLE SETTING					
[START/STOP]						
STYLE	STYLE category selection buttons	FUNCTION	SONG SETTING	GUIDE/CHANNEL		
SONG	[GUIDE]			OTHERS		
	[SCORE]			GUIDE/CHANNEL		
	[LYRICS/TEXT]			OTHERS		
	[TR 1], [TR 2], [EXTRA TR]			GUIDE/CHANNEL		
	[REPEAT]			OTHERS		
	[▶▶] (FF)			GUIDE/CHANNEL		
	[◀◀] (REW)			OTHERS		
	[▶/■] (PLAY/PAUSE)			GUIDE/CHANNEL		
	[■] (STOP)			OTHERS		
	[REC]			GUIDE/CHANNEL		
	[SELECT]			OTHERS		
[TAP TEMPO]		UTILITY	CONFIG 1			
TEMPO	[+], [-]	FUNCTION	STYLE SETTING			
[METRONOME]		UTILITY	CONFIG 1	METRONOME		
[FADE IN/OUT]		CONTROLLER	FADE IN/OUT			
TRANSPOSE	[+], [-]	FUNCTION	KEYBOARD/PANEL	TRANSPOSE ASSIGN		
UPPER OCTAVE	[+], [-]	MIXING CONSOLE	TUNE			
MULTI PAD	[SELECT]	MULTI PAD Selection display		MULTIPAD EDIT		
	[STOP]					
	[1], [2], [3], [4]					
[DEMO]		FUNCTION	SYSTEM	OWNER		
[FUNCTION]		FUNCTION	MIDI			
[MIXER/EQ]		MIXING CONSOLE		VOL/VOICE		
[BAL.]						
[CHANNEL ON/OFF]						
[USB]		FUNCTION	UTILITY	USB		
[USB AUDIO PLAYER]		AUDIO File Selection display (called up only when a USB flash drive is connected.)				
TAB	[◀], [▶]	-				
[ENTER]		-				
[EXIT]		MAIN				
Data dial		-				
VOICE	PART SELECT [LEFT]	FUNCTION	VOICE SET FILTER	LEFT		
	PART SELECT [RIGHT1]			RIGHT1		
	PART SELECT [RIGHT2]			RIGHT2		
	PART ON/OFF [LEFT]			LEFT		
	PART ON/OFF [RIGHT1]			RIGHT1		
	PART ON/OFF [RIGHT2]			RIGHT2		
	[LEFT HOLD]			SPLIT POINT/CHORD FINGERING		SPLIT POINT
	VOICE category selection buttons			FUNCTION	VOICE SET FILTER	
[HARMONY/ARPEGGIO]	FUNCTION	HARMONY/ARPEGGIO				
[TOUCH]	FUNCTION	CONTROLLER	KEYBOARD/PANEL	TOUCH RESPONSE		
[SUSTAIN]	MIXING CONSOLE		EFFECT			
[MONO]			TUNE			
[DSP]			EFFECT			
[VARI.]			EFFECT	Effect Type Selection display		
[MUSIC FINDER]		MUSIC FINDER	MUSIC FINDER SEARCH 1			
ONE TOUCH SETTING	[1], [2], [3], [4]	OTS INFORMATION				
[MASTER EQ]		MIXING CONSOLE		CMP		
REGISTRATION MEMORY	REGIST BANK [+], [-]	FUNCTION	REGIST SEQUENCE/FREEZE	REGISTRATION SEQUENCE		
	[FREEZE]			FREEZE		
	[MEMORY]			REGISTRATION SEQUENCE		
	[1], [2], [3], [4], [5], [6], [7], [8]	REGIST INFORMATION				
FOOT PEDAL [1], [2]		FUNCTION	CONTROLLER	FOOT PEDAL		
SCALE SETTING buttons		SCALE TUNE BANK selection display		1, 2		
SCALE MEMORY buttons		SCALE TUNE BANK selection display		SCALE TUNE EDIT		
Joystick		LIVE CONTROL	PARAMETER ASSIGN			
[ASSIGN]						

# Troubleshooting

Overall	
A click or pop is heard when the power is turned on or off.	This is normal. Electrical current is being applied to the instrument.
The power is automatically turned off.	This is normal and due to the Auto Power Off function. If necessary, set the parameter of the Auto Power Off function (page 17).
Noise is heard from the instrument's speakers.	Noise may be heard if a mobile phone is used near the instrument or if the phone is ringing. Turn off the mobile phone, or use it further away from the instrument.
Noise is heard from the instrument's speakers or headphones when using the instrument with an iPhone/iPad application.	When you use the instrument along with the application on your iPhone/iPad, we recommend that you set "Airplane Mode" to "ON" on your iPhone/iPad in order to avoid noise caused by communication.
In the LCD, there are some specific points that are always lit or unlit.	These are the result of defective pixels and occasionally occur in TFT-LCDs; they do not indicate a problem in operation.
There is a slight difference in sound quality among different notes played on the keyboard.	This is normal and is a result of the instrument's sampling system.
Some Voices have a looping sound.	
Some noise or vibrato is noticeable at higher pitches, depending upon the Voice.	
The overall volume is too low or no sound is heard.	<p>The master volume may be set too low. Set it to an appropriate level with the [MASTER VOLUME] dial.</p> <p>All keyboard parts are set to off. Use the PART ON/OFF [RIGHT 1]/[RIGHT 2]/[LEFT] button to turn it on.</p> <p>The volume of the individual parts may be set too low. Raise the volume in the BALANCE display (page 56).</p> <p>Make sure the desired channel is set to ON (pages 57, 65).</p> <p>Headphones are connected, disabling the speaker output. Unplug the headphones.</p> <p>Make sure that the Speaker setting is set to ON: [FUNCTION] → TAB [◀] MENU 1 → [J] UTILITY → TAB [◀ ▶] CONFIG 2</p> <p>The [FADE IN/OUT] button is on, which mutes the sound. Press the [FADE IN/OUT] button to turn the function off.</p>
The sound is distorted or noisy.	<p>The volume may be turned up too high. Make sure all relevant volume settings are appropriate.</p> <p>This may be caused by certain effects or filter settings. Check the effect or filter settings and change them accordingly (pages 181–190).</p>
Not all simultaneously played notes sound.	You are probably exceeding the maximum polyphony (page 214) of the instrument. When the maximum polyphony is exceeded, the earliest played notes will stop sounding, letting the latest played notes sound.
The keyboard volume is lower than the Song/Style playback volume.	The volume of the keyboard parts may be set too low. Raise the volume in the BALANCE display (page 56).
The Main display does not appear even when turning the power on.	This may occur if a USB flash drive has been installed to the instrument. Installation of some USB flash drives may result in a long interval between turning the power on and appearance of the Main display. To avoid this, turn the power on after disconnecting the device.

Some characters of the file/folder name are garbled.	The language settings have been changed. Set the appropriate language for the file/folder name (page 18).
An existing file is not shown.	The file extension (.MID, etc.) may have been changed or deleted. Manually rename the file, adding the appropriate extension, on a computer.
	Data files with names of more than 50 characters cannot be handled by the instrument. Rename the file, reducing the number of characters to 50 or less.
<b>Voice</b>	
The Voice selected from the Voice Selection display does not sound.	Check whether or not the selected part is turned on (page 36). If necessary, press the appropriate PART ON/OFF button to turn the part on.
A strange “flanging” or “doubling” sound occurs. The sound is slightly different each time the keys are played.	The RIGHT 1 and RIGHT 2 parts are set to “ON,” and both parts are set to play the same Voice. Turn off the RIGHT 2 part or change the Voice of one of the parts.
Some Voices will jump an octave in pitch when played in the upper or lower registers.	This is normal. Some Voices have a pitch limit which, when reached, causes this type of pitch shift.
<b>Style</b>	
The Style does not start even when the [START/STOP] button is pressed.	The Rhythm channel of the selected Style may not contain any data. Turn the [ACMP] button on and play left-hand section on the keyboard to sound the accompaniment part of the Style.
Only the rhythm channel plays.	Make sure the Auto Accompaniment function is turned on; press the [ACMP] button.
	Make sure to play keys in the chord section of the keyboard (pages 57, 58).
Styles in a USB flash drive cannot be selected.	If the size of the Style data is large (about 120 KB or greater), the Style cannot be selected because the data is too large to be handled by the instrument.
<b>Song</b>	
Songs cannot be selected.	This may be because the language settings have been changed. Set the appropriate language for the Song file name.
	If the size of the Song data is large (about 300 KB or greater), the Song cannot be selected because the data is too large to be handled by the instrument.
Song playback does not start.	The Song has been stopped at the end of the Song data. Return to the beginning of the Song by pressing the SONG [■] (STOP) button.
	In the case of a Song to which write-protect has been applied, there are some restrictions and playback may not be possible. For details, refer to page 27.
Song playback stops before the Song is finished.	The Guide function is turned on. (In this case, playback is “waiting” for the correct key to be played.) Press the [GUIDE] button to turn off the Guide function.
The measure number is different from that of the score in the Song Position display, shown by pressing the [◀◀](REW)/[▶▶](FF) buttons.	This happens when playing back music data for which a specific, fixed tempo is set.
When playing back a Song, some channels do not play.	Playback of these channels may be set to “OFF.” Turn playback on for those channels that are set to “OFF” (page 65).
The tempo, beat, measure and music notation is not displayed correctly.	Some Song data for the instrument has been recorded with special “free tempo” settings. For such Song data, the tempo, beat, measure and music notation will not be displayed correctly.

<b>USB Audio Player/Recorder</b>	
A message indicating the USB flash drive is unavailable appears, and the recording is aborted.	Make sure to use a compatible USB flash drive (page 95).
	The USB flash drive may not have enough memory. Check the recordable time on the display (page 75).
	If you are using a USB flash drive to which data has already been recorded, check first that no important data remains on the device, then format it (page 96) and try recording again.
Audio files cannot be selected.	The file format may not be compatible with the instrument. The compatible formats are: MP3 and WAV. DRM protected files cannot be played back.
An existing recorded file is played back at a different volume compared to when it was recorded.	The audio playback volume has been changed. Setting the volume value to 100 plays back the file at the same volume as when it was recorded (page 73).
<b>Mixing Console</b>	
The sound seems strange or different than expected when changing a rhythm Voice (Drum Kit, etc.) of the Style or Song from the Mixer.	When changing the rhythm/percussion Voices (Drum Kits, etc.) of the Style and Song from the VOICE parameter, the detailed settings related to the drum voice are reset, and in some cases you may be unable to restore the original sound. In the case of Song playback, you can restore the original sound by returning to the beginning of the Song and playing back from that point. In the case of Style play, you can restore the original sound by selecting the same Style again.
<b>Foot Pedal</b>	
The on/off setting of the footswitch connected to the FOOT PEDAL jack is reversed.	Change the polarity settings: [FUNCTION] → TAB [◀] MENU 1 → [D] CONTROLLER → [I] (PEDAL POLARITY).

# Specifications

Product name		Digital Keyboard		
Size/Weight	Dimensions (W x D x H)		1,002 mm x 437 mm x 148 mm (39-7/16" x 17-3/16" x 5-13/16")	
	Weight		11.2 kg (24 lbs., 11 oz.)	
Control Interface	Keyboard	Number of Keys	61	
		Type	Organ	
		Touch Response	Hard 2, Hard 1, Medium, Soft 1, Soft 2	
	Other Controllers	Joystick	Yes (Assignable)	
		Type	TFT Color Wide VGA LCD	
	Display	Size	7 inch	
		Language	English, German, French, Spanish, Italian	
Panel	Language	English		
Voices	Tone Generation	Tone Generation Technology	AWM Stereo Sampling	
	Polyphony	Number of Polyphony (max.)	128	
	Preset	Number of Voices	997 Voices + 58 Drum/SFX Kits + 480 XG Voices	
		Featured Voices	107 S.Art!, 23 MegaVoices, 41 Sweet!, 64 Cool!, 90 Live!, 20 Organ Flutes! (including 171 Oriental Voices, 25 Oriental Kits)	
	Compatibility		XG, GS (for Song playback), GM, GM2	
	Part		Right 1, Right 2, Left	
Effects	Reverb Block		52 Preset + 3 User	
	Chorus Block		106 Preset + 3 User	
	DSP Block		295 Preset + 10 User	
	Master Compressor		5 Preset + 5 User	
	Master EQ		5 Preset + 2 User	
	Part EQ		27 Parts	
Styles	Preset	Number of Styles	400	
		Featured Styles	380 Pro, 10 Session, 10 DJ	
		Fingering	Single Finger, Fingered, Fingered On Bass, Multi Finger, AI Fingered, Full Keyboard, AI Full Keyboard	
		Style Control	INTRO x 3, MAIN VARIATION x 4, FILL x 4, BREAK, ENDING x 3	
	Other Features	Music Finder (Max.)	1,200	
		One Touch Setting (OTS)	4 for each Style	
Compatibility		Style File Format (SFF), Style File Format GE (SFF GE)		
Songs (MIDI)	Preset	Number of Preset Songs	4	
	Recording	Number of Tracks	16	
		Data Capacity	approx. 300 KB/Song	
		Recording Function	Quick Recording, Multi Track Recording, Step Recording	
	Data Format	Playback	SMF (Format 0 & 1), XF	
	Recording	SMF (Format 0)		
Multi Pads	Preset	Number of Multi Pad Banks	228 banks x 4 Pads	
	Audio	Audio Link	Yes	
Functions	Voices	Harmony	Yes	
		Arpeggio	Yes	
		Panel Sustain	Yes	
		Mono/Poly	Yes (with Mono Legato)	
		Voice Information	Yes	
	Styles	Style Creator	Yes	
		OTS Information	Yes	
	Songs	Song Creator	Yes	
		Score Display Function	Yes	
		Lyrics Display Function	Yes	
		Text Display Function	Yes	
		Wallpaper Customization	Yes	
		Guide	Follow Lights, Any Key, Karao-Key, Your Tempo	
		Performance Assistant Technology (P.A.T.)	Yes	
Multi Pads	Multi Pad Creator	Yes		

Functions	Registration Memory	Number of Buttons	8	
		Control	Registration Sequence, Freeze	
	USB Audio Player/Recorder	Playback Format	.wav (WAV format: 44.1 kHz sample rate, 16 bit resolution, stereo) .mp3 (MPEG-1 Audio Layer-3: 44.1/48.0 kHz sample rate, 64–320 kbps and variable bit rate, mono/stereo)	
		Recording Format	.wav (WAV format: 44.1 kHz sample rate, 16 bit resolution, stereo)	
		Recording Time (max.)	80 minutes/Song	
		Time Stretch	Yes	
		Pitch Shift	Yes	
		Vocal Cancel	Yes	
	Demonstration		Yes	
	Overall Controls	Metronome	Yes	
		Tempo	5 – 500	
		Transpose	-12 – 0 – +12	
		Tuning	414.8 – 440.0 – 466.8 Hz	
		Octave Button	Yes	
		Scale Type	9 types	
		Scale Setting	Yes	
	Miscellaneous	Scale Memory	Yes	
	Direct Access	Yes		
Expandability (Expansion Packs)	Expansion Voice		Yes (approx. 512 MB max.)	
	Expansion Style		Yes (internal memory)	
Storage and Connectivity	Storage	Internal Memory	Yes (approx. 13 MB max.)	
		External Drives	USB flash drive	
	Connectivity	DC IN	16 V	
		Headphones	Standard stereo phone jack	
		MIDI	IN, OUT	
		AUX IN	Stereo mini jack	
		OUTPUT	L/L+R, R	
		FOOT PEDAL	1 (SUSTAIN), 2 (ARTICULATION 1), Function assignable	
		USB TO DEVICE	Yes	
USB TO HOST	Yes			
Amplifiers/ Speakers	Amplifiers		15 W x 2	
	Speakers		13 cm x 2 + 5 cm x 2	
Power Supply	Power Supply	Adaptor	PA-300C or an equivalent recommended by Yamaha	
	Power Consumption		19 W	
	Auto Power Off		Yes	
Included Accessories			<ul style="list-style-type: none"> <li>• Owner's Manual (this book)</li> <li>• Online Member Product Registration</li> <li>• Music rest</li> <li>• AC adaptor* (PA-300C or an equivalent recommended by Yamaha), power cord*</li> </ul> <p>* May not be included depending on your area. Check with your Yamaha dealer.</p>	
Separately Sold Accessories (May not be available depending on your area.)			<ul style="list-style-type: none"> <li>• AC adaptor: PA-300C or an equivalent recommended by Yamaha</li> <li>• Headphones: HPH-50/HPH-100/HPH-150</li> <li>• Footswitches: FC4/FC4A/FC5</li> <li>• Foot controller: FC7</li> <li>• USB MIDI Interface for iPhone/iPod touch/iPad: i-UX1</li> <li>• MIDI Interface for iPhone/iPod touch/iPad: i-MX1</li> <li>• USB wireless LAN adaptor: UD-WL01</li> <li>• USB-MIDI Interface: UX16</li> <li>• Keyboard stand: L-6/L-7</li> </ul> <p>(The exterior size of the PSR-A3000 is beyond the limits as described in the L-6 Assembly Instructions. However, we have determined through tests that the stand can be safely used for the instrument.)</p>	

\* The contents of this manual apply to the latest specifications as of the printing date. To obtain the latest manual, access the Yamaha website then download the manual file. Since specifications, equipment or separately sold accessories may not be the same in every locale, please check with your Yamaha dealer.

# Index

- A**
- A-B Repeat ..... 67, 73
  - AC adaptor ..... 16
  - Access Point Mode ..... 201
  - Accompaniment ..... 49
  - Any Key ..... 149
  - Arpeggio ..... 44, 106, 204
  - Arpeggio Hold ..... 204
  - Arpeggio Quantize ..... 204
  - Audio Link Multi Pad ..... 78
  - Audio Player ..... 71
  - Audio Recorder ..... 74
  - Auto Fill ..... 52
  - Auto Power Off ..... 17
  - AUX IN ..... 94
- B**
- Backup ..... 34
  - Balance ..... 57, 74
  - Break (Style) ..... 52
- C**
- Channel (Song) ..... 65
  - Channel (Style) ..... 56
  - Character entry ..... 32
  - Chord detection area ..... 59
  - Chord Fingering ..... 53, 120
  - Chord Match ..... 77
  - Chord Tutor ..... 54
  - Chorus ..... 116
  - Compressor ..... 189
  - Computer ..... 97
  - Computer-related Operations ..... 7
  - Connection ..... 93
  - Copy ..... 30
- D**
- Data dial ..... 22
  - Data List ..... 7
  - Delete ..... 31
  - Demo ..... 19
  - Direct Access ..... 23, 210
- E**
- DJ Style ..... 50
  - Drum Kit ..... 38
  - Drum Setup ..... 140
  - DSP ..... 42, 116, 117
  - Dynamics Control ..... 122
- F**
- Factory Reset ..... 33, 208
  - Fade In/Out ..... 53, 202
  - Fast Forward ..... 63, 73
  - File ..... 26, 27
  - File Selection display ..... 26
  - Fill-in ..... 52
  - Filter ..... 115, 182
  - Fingering type ..... 53, 120
  - Folder ..... 29
  - Follow Lights ..... 149
  - Foot pedal ..... 191
  - Foot controller ..... 93, 191
  - Footswitch ..... 93, 191
  - Format (Compatibility) ..... 8
  - Format (USB flash drive) ..... 96, 205
  - Freeze ..... 177
  - Function List ..... 209
- G**
- GM ..... 8, 104
  - GS ..... 8
  - Guide ..... 66, 148
- H**
- Harmony ..... 42, 106
  - Headphones ..... 15
- I**
- Infrastructure Mode ..... 200
  - Intro (Style) ..... 51
  - iPhone/iPad ..... 97
  - iPhone/iPad Connection Manual ..... 7
- J**
- Joystick ..... 40, 110
- K**
- Karao-Key ..... 149
  - Keyboard part ..... 36
- L**
- Language ..... 18, 148, 206
  - Layer ..... 36
  - Left Hold ..... 38
  - Legato ..... 114
  - LOWER ..... 59
  - Lyrics ..... 65, 145
- M**
- Main (Style) ..... 52
  - Main display ..... 24
  - Master Compressor ..... 189
  - Master EQ ..... 188
  - MegaVoice ..... 103
  - MENU ..... 26
  - Metronome ..... 38, 202
  - MIDI ..... 98, 194
  - Mixing Console (Mixer) ..... 91
  - Modulation ..... 115
  - Mono ..... 42, 114
  - Move ..... 30
  - MP3 ..... 71
  - Multi Pad ..... 76
  - Multi Pad Creator ..... 168
  - Multi Track Recording ..... 69
  - Music Finder ..... 80, 172
  - Music notation ..... 64, 143
  - Music rest ..... 14



<b>N</b>	Reverb .....	116	Touch Sensitivity .....	105, 114	
NTR (Note Transposition Rule).....	137	Rewind .....	63, 73	Transpose.....	39, 109
NTT (Note Transposition Table) ....	137	RTR (Retrigger Rule).....	139	Troubleshooting.....	211
				Tuning.....	39, 88, 108, 183
<b>O</b>		<b>S</b>		<b>U</b>	
One Touch Setting (OTS).....	54, 124	S.Art! (Super Articulation Voice) ....	38	UPPER .....	59
Organ Flutes Voice.....	45, 118	Save .....	28	Upper Octave .....	39
OTS (One Touch Setting).....	54, 124	Scale .....	88, 108	USB (File Selection display) .....	26
OTS Link.....	55	Scale Tune Bank.....	89	USB Audio Player/Recorder .....	71
		Score.....	64, 143	USB flash drive.....	95, 96, 205
<b>P</b>		Section .....	52	USB wireless LAN adaptor .....	95, 97
Panpot .....	181	Setup data (Song).....	158	USER (File Selection display) .....	26
Parameter Lock.....	205	Setup file .....	207		
Part (Voice).....	36	SFF (Style File Format).....	8, 50, 135	<b>V</b>	
Part EQ.....	187	SFX Kit .....	38	Vibrato .....	116
Pause .....	63, 73	SMF (Standard MIDI File) .....	62	Vocal Cancel .....	73
Pedal .....	93, 191	Song.....	62	Voice.....	36
Performance Assistant Technology (P.A.T.) .....	150	Song Creator.....	151	Voice Set.....	113
Phrase Mark .....	64, 147	Song setting .....	147	Voice Set Filter.....	117
Pitch .....	39, 88, 108	Source Chord.....	136	Volume (Audio).....	73
Pitch Shift .....	73	Source Root .....	136	Volume (Master volume).....	18
Playback (Audio File) .....	71	Speaker.....	203	Volume balance.....	57, 74, 181
Playback (Song).....	62	Specifications .....	214		
Playback (Style) .....	49	Split .....	36	<b>W</b>	
Poly.....	114	Split Point .....	58	WAV .....	71
Portamento .....	114	Standard MIDI File (SMF) .....	62	Wireless LAN .....	200
Power .....	16	Step Recording (Multi Pad) .....	170		
PRESET (File Selection display).....	26	Step Recording (Song) .....	152, 155	<b>X</b>	
Protected Song .....	27	Step Recording (Style).....	130	XF.....	8
Punch In/Out (Song Creator).....	159	Stop Accompaniment .....	122	XG.....	8, 104
		Style .....	49		
<b>Q</b>		Style Assembly .....	130	<b>Y</b>	
Quick Recording .....	68	Style Creator .....	60, 125	Your Tempo .....	149
		Style File Format (SFF).....	8, 50, 135		
<b>R</b>		Style setting .....	122		
Realtime Recording (Multi Pad) ....	168	Super Articulation Voice .....	38		
Realtime Recording (Style) .....	126	Sustain .....	42		
Record (Music Finder) .....	80	Synchro Start (Multi Pad) .....	77		
Recording (Audio).....	74	Synchro Start (Song).....	63		
Recording (Song).....	68	Synchro Start (Style) .....	51		
Registration Memory .....	85, 176	Synchro Stop .....	51		
Registration Sequence.....	178				
Rename .....	30	<b>T</b>			
Repeat.....	67, 73, 74, 147	Tap Tempo.....	52, 203		
Repertoire.....	55	Tempo.....	52		
Reset .....	33, 208	Text .....	65, 145		
		Time Stretch.....	73		
		Touch Response.....	42, 105, 114		

**Memo**

### Information for Users on Collection and Disposal of Old Equipment



This symbol on the products, packaging, and/or accompanying documents means that used electrical and electronic products should not be mixed with general household waste.

For proper treatment, recovery and recycling of old products, please take them to applicable collection points, in accordance with your national legislation and the Directives 2002/96/EC.

By disposing of these products correctly, you will help to save valuable resources and prevent any potential negative effects on human health and the environment which could otherwise arise from inappropriate waste handling.

For more information about collection and recycling of old products, please contact your local municipality, your waste disposal service or the point of sale where you purchased the items.

#### [For business users in the European Union]

If you wish to discard electrical and electronic equipment, please contact your dealer or supplier for further information.

#### [Information on Disposal in other Countries outside the European Union]

This symbol is only valid in the European Union. If you wish to discard these items, please contact your local authorities or dealer and ask for the correct method of disposal.

(weee\_eu\_en\_01)

### IMPORTANT NOTICE FOR THE UNITED KINGDOM

#### Connecting the Plug and Cord

IMPORTANT. The wires in this mains lead are coloured in accordance with the following code:

BLUE : NEUTRAL

BROWN : LIVE

As the colours of the wires in the mains lead of this apparatus may not correspond with the coloured markings identifying the terminals in your plug proceed as follows:

The wire which is coloured BLUE must be connected to the terminal which is marked with the letter N or coloured BLACK.

The wire which is coloured BROWN must be connected to the terminal which is marked with the letter L or coloured RED.

Making sure that neither core is connected to the earth terminal of the three pin plug.

(2 wires)

### OBSERVERA!

Apparaten kopplas inte ur växelströmskällan (nätet) så länge som den är ansluten till vägguttaget, även om själva apparaten har stängts av.

**ADVARSEL:** Netspændingen til dette apparat er IKKE afbrudt, så længe netledningen sidder i en stikkontakt, som er tændt — også selvom der er slukket på apparatets afbryder.

**VAROITUS:** Laitteen toisiopiiriin kytketty käyttökytin ei irroita koko laitetta verkosta.

(standby)

# Important Notice: Guarantee Information for customers in European Economic Area (EEA) and Switzerland

<b>English</b>	<b>Important Notice: Guarantee Information for customers in EEA* and Switzerland</b> For detailed guarantee information about this Yamaha product, and Pan-EEA* and Switzerland warranty service, please either visit the website address below (Printable file is available at our website) or contact the Yamaha representative office for your country. * EEA: European Economic Area
<b>Deutsch</b>	<b>Wichtiger Hinweis: Garantie-Information für Kunden in der EWR* und der Schweiz</b> Für nähere Garantie-Information über dieses Produkt von Yamaha, sowie über den Pan-EWR*- und Schweizer Garantieservice, besuchen Sie bitte entweder die folgende angegebene Internetadresse (eine druckfähige Version befindet sich auch auf unserer Webseite), oder wenden Sie sich an den für Ihr Land zuständigen Yamaha-Vertrieb. *EWR: Europäischer Wirtschaftsraum
<b>Français</b>	<b>Remarque importante: informations de garantie pour les clients de l'EEE et la Suisse</b> Pour des informations plus détaillées sur la garantie de ce produit Yamaha et sur le service de garantie applicable dans l'ensemble de l'EEE, ainsi qu'en Suisse, consultez notre site Web à l'adresse ci-dessous (le fichier imprimable est disponible sur notre site Web) ou contactez directement Yamaha dans votre pays de résidence. * EEE : Espace Economique Européen
<b>Nederlands</b>	<b>Belangrijke mededeling: Garantie-informatie voor klanten in de EER* en Zwitserland</b> Voor gedetailleerde garantie-informatie over dit Yamaha-product en de garantieservice in heel de EER* en Zwitserland, gaat u naar de onderstaande website (u vindt een afprintbaar bestand op onze website) of neemt u contact op met de vertegenwoordiging van Yamaha in uw land. * EER: Europese Economische Ruimte
<b>Español</b>	<b>Aviso importante: información sobre la garantía para los clientes del EEE* y Suiza</b> Para una información detallada sobre este producto Yamaha y sobre el soporte de garantía en la zona EEE* y Suiza, visite la dirección web que se incluye más abajo (la versión del archivo para imprimir está disponible en nuestro sitio web) o póngase en contacto con el representante de Yamaha en su país. * EEE: Espacio Económico Europeo
<b>Italiano</b>	<b>Aviso importante: informazioni sulla garanzia per i clienti residenti nell'EEA* e in Svizzera</b> Per informazioni dettagliate sulla garanzia relativa a questo prodotto Yamaha e l'assistenza in garanzia nei paesi EEA* e in Svizzera, potete consultare il sito Web all'indirizzo riportato di seguito (è disponibile il file in formato stampabile) oppure contattare l'ufficio di rappresentanza locale della Yamaha. * EEA: Area Economica Europea
<b>Português</b>	<b>Aviso importante: informações sobre as garantias para clientes da AEE* e da Suíça</b> Para obter uma informação pormenorizada sobre este produto da Yamaha e sobre o serviço de garantia na AEE* e na Suíça, visite o site a seguir (o arquivo para impressão está disponível no nosso site) ou entre em contato com o escritório de representação da Yamaha no seu país. * AEE: Área Económica Europeia
<b>Ελληνικά</b>	<b>Σημαντική σημείωση: Πληροφορίες εγγύησης για τους πελάτες στον ΕΟΧ* και Ελβετία</b> Για λεπτομερείς πληροφορίες εγγύησης σχετικά με το παρόν προϊόν της Yamaha και την κάλυψη εγγύησης, σε όλες τις χώρες του ΕΟΧ* και την Ελβετία, επισκεψτείτε την παρακάτω ιστοσελίδα (εκτυρίσιμο αρχείο) μωρη ή ανατρέξτε στην ιστοσελίδα μας ή απευθείας στη αντιπροσωπεία της Yamaha στη χώρα σας. * ΕΟΧ: Ευρωπαϊκός Οικονομικός Χώρος
<b>Svenska</b>	<b>Viktigt: Garantierinformation för kunder i EES-området* och Schweiz</b> För detaljerad information om denna Yamaha-produkt samt garantier i hela EES-området* och Schweiz kan du antingen besöka nedanstående webbadress (en utskriftsvänlig fil finns på webbplatsen) eller kontakta Yamahas officiella representant i ditt land. * EES: Europeiska Ekonomiska Samarbetsområdet
<b>Norsk</b>	<b>Viktig merknad: Garantierinformasjon for kunder i EØS* og Sveits</b> Detaljert informasjon om dette Yamaha-produktet og garantier i hele EØS-området* og Sveits kan fås enten ved å besøke nettstedene nedenfor (utskriftsversjon finnes på våre nettsider) eller kontakte kontaktpunktet Yamaha-kontoret i landet der du bor. *EØS: Det europeiske økonomiske samarbeidsområdet
<b>Dansk</b>	<b>Vigtig oplysning: Garantierplysninger til kunder i EØO* og Schweiz</b> De kan finde detaljerede garantierplysninger om dette Yamaha-produkt og den fælles garantierplejeordning for EØO* (og Schweiz) ved at besøge det websted, der er angivet nedenfor (der findes en fil, som kan udskrives, på vores websted), eller ved at kontakte Yamahas nationale repræsentationskontor i det land, hvor De bor. * EØO: Det Europæiske Økonomiske Område

<b>Suomi</b>	<b>Tärkeä ilmoitus: Takuutiedot Euroopan talousalueen (ETA)* ja Sveitsin asiakkaille</b> Tämän Yamaha-tuotteen sekä ETA-alueen ja Sveitsin takuuta koskevat yksityiskohtaiset tiedot saatte alla olevasta nettosoitteesta. (Tulostettava tiedosto saatavissa sivustollamme.) Voitte myös ottaa yhteyttä paikalliseen Yamaha-edustajaan. *ETA: Euroopan talousalue
<b>Polski</b>	<b>Ważne: Warunki gwarancyjne obowiązujące w EOG* i Szwajcarii</b> Aby dowiedzieć się więcej na temat warunków gwarancyjnych tego produktu firmy Yamaha i serwisu gwarancyjnego w całym EOG* i Szwajcarii, należy odwiedzić wskazaną poniżej stronę internetową (plik gotowy do wydruku znajduje się na naszej stronie internetowej) lub skontaktować się z przedstawicielstwem firmy Yamaha w swoim kraju. * EOG — Europejski Obszar Gospodarczy
<b>Česky</b>	<b>Důležité oznámení: Zásadní informace pro zákazníky v EHS* a ve Švýcarsku</b> Podrobné zásadní informace o tomto produktu Yamaha a zaručeném servisu v celém EHS* a ve Švýcarsku naleznete na níže uvedené webové adrese (soubor k tisku je dostupný na našich webových stránkách) nebo se můžete obrátit na zastoupení firmy Yamaha ve své zemi. * EHS: Evropský hospodářský prostor
<b>Magyar</b>	<b>Fontos figyelmeztetés: Garancia-információk az EGT* területén és Svájcban élő vásárlók számára</b> A jelen Yamaha termékre vonatkozó részletes garancia-információk, valamint az EGT*-re és Svájcra, kiterjedő garanciális szolgáltatás tekintetében keressse fel webhelyünket az alábbi címen (a webhelyen nyomtatható fájl is talál), vagy pedig lépjen kapcsolatba az országában működő Yamaha képviselői irodával. * EGT: Európai Gazdasági Térség
<b>Eesti keel</b>	<b>Oluline märkus: Garantiteave Euroopa Majanduspiirkonna (EMP)* ja Šveitsi Klientidele</b> Täpsema teabe saamiseks selle Yamaha toote garantii ning kogu Euroopa Majanduspiirkonna ja Šveitsi garantiteeninduse kohta, külastage palun veebisaiti alljärgneval aadressil (meie saitil on saadaval printitav fail) või pöörduge Teie regiooni Yamaha esinduse poole. * EMP: Euroopa Majanduspiirkond
<b>Latviešu</b>	<b>Svarīgs paziņojums: garantijas informācija klientiem EEZ* un Šveicē</b> Lai saņemtu detaļizētā garantijas informāciju par šo Yamaha produktu, kā arī garantijas apkalpošanu EEZ* un Šveicē, lūdzam apmeklēt vietni, kur norādīts tīmekļa vietnes adresi (tīmekļa vietnē ir pieejams drukājams fails) vai sazināties ar jūsu valstī apkalpojošo Yamaha pārstāvēniecību. * EEZ: Eiropas Ekonomikas zona
<b>Lietuvių kalba</b>	<b>Dėmesio: informacija dėl garantijos priekšams EEE* ir Šveicarijoje</b> Jei reikia išsamios informacijos apie šį „Yamaha“ produktą ir jo techninę priežiūrą visoje EEE* ir Šveicarijoje, apsilankykite mūsų svetainėje toliau nurodytu adresu (svetainėje yra spausdinamas failas) arba kreipkitės į „Yamaha“ atstovybę savo šalyje. *EEE – Europos ekonominė erdvė
<b>Slovenščina</b>	<b>Določite upozornenje: Informacije o zaruke pre zákazníkov v EHP* a Švajcarijsku</b> Podrobne informacije o zaruke (kajkajuce sa tohto produktu od spoobnosti Yamaha a garancionem servisu v EHP* a Švajcarijsku) najdete na webovi strani uvedenej nižje (na naši webovi strani je na voljo na našem spletnem mestu), ali se obrnite na Yamahinega pooblaščenca v svoji državi. * EHP: Evropski gospodarski prostor
<b>Slovensščina</b>	<b>Pomembno obvestilo: Informacije o garanciji za kupce v EGP* in Švici</b> Za podrobnejše informacije o tem Yamahinem izdelku ter garancijskem servisu v celotnem EGP in Švici, obiščite spletno mesto, ki je navedeno spodaj (našijava datoteka je na voljo na našem spletnem mestu), ali se obrnite na Yamahinega predstavništva v svoji državi. * EGP: Evropski gospodarski prostor
<b>Български език</b>	<b>Важно съобщение: Информация за гаранцията за клиенти в ЕИП* и Швейцария</b> За подробна информация за гаранцията за този продукт на Yamaha и гаранционното обслужване в панаевропейската зона на ЕИП* и Швейцария или посетете посочения по-долу уеб сайт (на нашия уеб сайт има файл за печат), или се свържете с представителния офис на Yamaha във вашата страна. * ЕИП: Европейско икономическо пространство
<b>Limba română</b>	<b>Notificare importantă: Informații despre garanție pentru clienții din SEE* și Elveția</b> Pentru informații detaliate privind acces produs Yamaha și serviciul de garanție Pan-SEE* și Elveția, vizitați site-ul la adresa de mai jos (fișierul imprimabil este disponibil pe site-ul nostru) sau contactați biroul reprezentanței Yamaha din țara dumneavoastră. * SEE: Spațiul Economic European

<http://europe.yamaha.com/warranty/>



## 1-YEAR LIMITED WARRANTY ON ARRANGER WORKSTATION KEYBOARDS

Thank you for selecting a Yamaha product. Yamaha products are designed and manufactured to provide a high level of defect-free performance. Yamaha Corporation of America ("Yamaha") is proud of the experience and craftsmanship that goes into each and every Yamaha product. Yamaha sells its products through a network of reputable, specially authorized dealers and is pleased to offer you, the Original Owner, the following Limited Warranty, which applies only to products that have been (1) directly purchased from Yamaha's authorized dealers in the fifty states of the USA and District of Columbia (the "Warranted Area") and (2) used exclusively in the Warranted Area. Yamaha suggests that you read the Limited Warranty thoroughly, and invites you to contact your authorized Yamaha dealer or Yamaha Customer Service if you have any questions.

**Coverage:** Yamaha will, at its option, repair or replace the product covered by this warranty if it becomes defective, malfunctions or otherwise fails to conform with this warranty under normal use and service during the term of this warranty, without charge for labor or materials. Repairs may be performed using new or refurbished parts that meet or exceed Yamaha specifications for new parts. If Yamaha elects to replace the product, the replacement may be a reconditioned unit. You will be responsible for any installation or removal charges and for any initial shipping charges if the product(s) must be shipped for warranty service. However, Yamaha will pay the return shipping charges to any destination within the USA if the repairs are covered by the warranty. This warranty does not cover (a) damage, deterioration or malfunction resulting from accident, negligence, misuse, abuse, improper installation or operation or failure to follow instructions according to the Owner's Manual for this product; any shipment of the product (claims must be presented to the carrier); repair or attempted repair by anyone other than Yamaha or an authorized Yamaha Service Center; (b) any unit which has been altered or on which the serial number has been defaced, modified or removed; (c) normal wear and any periodic maintenance; (d) deterioration due to perspiration, corrosive atmosphere or other external causes such as extremes in temperature or humidity; (e) damages attributable to power line surge or related electrical abnormalities, lightning damage or acts of God; or (f) RFI/EMI (Interference/noise) caused by improper grounding or the improper use of either certified or uncertified equipment, if applicable. Any evidence of alteration, erasing or forgery of proof-of-purchase documents will cause this warranty to be void. This warranty covers only the Original Owner and is not transferable.

**In Order to Obtain Warranty Service:** Warranty service will only be provided for defective products within the Warranted Area. Contact your local authorized Yamaha dealer who will advise you of the procedures to be followed. If this is not successful, contact Yamaha at the address, telephone number or website shown below. Yamaha may request that you send the defective product to a local authorized Yamaha Servicer or authorize return of the defective product to Yamaha for repair. If you are uncertain as to whether a dealer has been authorized by Yamaha, please contact Yamaha's Service Department at the number shown below, or check Yamaha's website at [www.Yamaha.com](http://www.Yamaha.com). Product(s) shipped for service should be packed securely and must be accompanied by a detailed explanation of the problem(s) requiring service, together with the original or a machine reproduction of the bill of sale or other dated, proof-of-purchase document describing the product, as evidence of warranty coverage. Should any product submitted for warranty service be found ineligible therefore, an estimate of repair cost will be furnished and the repair will be accomplished only if requested by you and upon receipt of payment or acceptable arrangement for payment.

**Limitation of Implied Warranties and Exclusion of Damages:** ANY IMPLIED WARRANTIES, INCLUDING WARRANTIES OF MERCHANTABILITY AND FITNESS FOR A PARTICULAR PURPOSE SHALL BE LIMITED IN DURATION TO THE APPLICABLE PERIOD OF TIME SET FORTH ABOVE. YAMAHA SHALL NOT BE RESPONSIBLE FOR INCIDENTAL OR CONSEQUENTIAL DAMAGES OR FOR DAMAGES BASED UPON INCONVENIENCE, LOSS OF USE, DAMAGE TO ANY OTHER EQUIPMENT OR OTHER ITEMS AT THE SITE OF USE OR INTERRUPTION OF PERFORMANCES OR ANY CONSEQUENCES. YAMAHA'S LIABILITY FOR ANY DEFECTIVE PRODUCT IS LIMITED TO REPAIR OR REPLACEMENT OF THE PRODUCT, AT YAMAHA'S OPTION. SOME STATES DO NOT ALLOW LIMITATIONS ON HOW LONG AN IMPLIED WARRANTY LASTS OR THE EXCLUSION OR LIMITATION OF INCIDENTAL OR CONSEQUENTIAL DAMAGES, SO THE ABOVE LIMITATION OR EXCLUSION MAY NOT APPLY TO YOU. This Warranty gives you specific legal rights, and you may also have other rights which vary from state to state. This is the only express warranty applicable to the product specified herein; Yamaha neither assumes nor authorizes anyone to assume for it any other express warranty.

If you have any questions about service received or if you need assistance in locating an authorized Yamaha Servicer, please contact:



CUSTOMER SERVICE  
Yamaha Corporation of America  
6600 Orangethorpe Avenue, Buena Park, California 90620-1373  
Telephone: 800-854-1569  
[www.yamaha.com](http://www.yamaha.com)

**Do not return any product to the above address without a written Return Authorization issued by Yamaha.**

©2012 Yamaha Corporation of America.

For details of products, please contact your nearest Yamaha representative or the authorized distributor listed below.

Pour plus de détails sur les produits, veuillez-vous adresser à Yamaha ou au distributeur le plus proche de vous figurant dans la liste suivante.

Die Einzelheiten zu Produkten sind bei Ihrer unten aufgeführten Niederlassung und bei Yamaha Vertragshändlern in den jeweiligen Bestimmungsländern erhältlich.

Para detalles sobre productos, contacte su tienda Yamaha más cercana o el distribuidor autorizado que se lista debajo.

## NORTH AMERICA

### CANADA

**Yamaha Canada Music Ltd.**  
135 Milner Avenue, Toronto, Ontario M1S 3R1,  
Canada  
Tel: +1-416-298-1311

### U.S.A.

**Yamaha Corporation of America**  
6600 Orangethorpe Avenue, Buena Park, CA 90620,  
U.S.A.  
Tel: +1-714-522-9011

## CENTRAL & SOUTH AMERICA

### MEXICO

**Yamaha de México, S.A. de C.V.**  
Av. Insurgentes Sur 1647 Piso 9, Col. San José  
Insurgentes, Delegación Benito Juárez, México,  
D.F., C.P. 03900  
Tel: +52-55-5804-0600

### BRAZIL

**Yamaha Musical do Brasil Ltda.**  
Rua Fidêncio Ramos, 302 – Cj 52 e 54 – Torre B –  
Vila Olímpia – CEP 04551-010 – São Paulo/SP,  
Brazil  
Tel: +55-11-3704-1377

### ARGENTINA

**Yamaha Music Latin America, S.A.,  
Sucursal Argentina**  
Olga Cossetini 1553, Piso 4 Norte,  
Madero Este-C1107CEK,  
Buenos Aires, Argentina  
Tel: +54-11-4119-7000

### VENEZUELA

**Yamaha Music de Venezuela, C.A.**  
AV. Manzanares, C.C. Manzanares Plaza,  
Piso 4, Oficina 0401, Baruta, Caracas, Venezuela  
Tel: +58-212-943-1877

### PANAMA AND OTHER LATIN AMERICAN COUNTRIES/ CARIBBEAN COUNTRIES

**Yamaha Music Latin America, S.A.**  
Edif. Torre Banco General, F7, Urb. Marbella,  
Calle 47 y Aquilino de la Guardia, Panama,  
P.O.Box 0823-05863, Panama, Rep. de Panama  
Tel: +507-269-5311

## EUROPE

### THE UNITED KINGDOM/IRELAND

**Yamaha Music Europe GmbH (UK)**  
Sherbourne Drive, Tilbrook, Milton Keynes,  
MK7 8BL, U.K.  
Tel: +44-1908-366700

### GERMANY

**Yamaha Music Europe GmbH**  
Siemensstrasse 22-34, 25462 Rellingen, Germany  
Tel: +49-4101-303-0

### SWITZERLAND/LIECHTENSTEIN

**Yamaha Music Europe GmbH, Rellingen,  
Branch Switzerland in Zürich**  
Seefeldstrasse 94, 8008 Zürich, Switzerland  
Tel: +41-44-3878080

### AUSTRIA

**Yamaha Music Europe GmbH, Branch Austria**  
Schleiergasse 20, 1100 Wien, Austria  
Tel: +43-1-60203900

### CZECH REPUBLIC/HUNGARY/ ROMANIA/SLOVAKIA/SLOVENIA

**Yamaha Music Europe GmbH, Branch Austria**  
Schleiergasse 20, 1100 Wien, Austria  
Tel: +43-1-60203900

### POLAND/LITHUANIA/LATVIA/ ESTONIA

**Yamaha Music Europe GmbH**  
**Sp.z o.o. Oddział w Polsce**  
ul. Wrotkowa 14, 02-553 Warsaw, Poland  
Tel: +48-22-880-08-88

### BULGARIA

**Dinacord Bulgaria LTD.**  
Bul. Iskarsko Schose 7 Targowski Zentar Ewropa  
1528 Sofia, Bulgaria  
Tel: +359-2-978-20-25

### MALTA

**Olimpus Music Ltd.**  
Valletta Road, Mosta MST9010, Malta  
Tel: +356-2133-2093

### NETHERLANDS/BELGIUM/ LUXEMBOURG

**Yamaha Music Europe, Branch Benelux**  
Clarissenhof 5b, 4133 AB Vianen, The Netherlands  
Tel: +31-347-358040

### FRANCE

**Yamaha Music Europe**  
7 rue Ambroise Croizat, Zone d'activités de Pariest,  
77183 Croissy-Beaubourg, France  
Tel: +33-1-6461-4000

### ITALY

**Yamaha Music Europe GmbH, Branch Italy**  
Viale Italia 88, 20020, Lainate (Milano), Italy  
Tel: +39-02-93577-1

### SPAIN/PORTUGAL

**Yamaha Music Europe GmbH Ibérica, Sucursal  
en España**  
Ctra. de la Coruna km. 17,200, 28231  
Las Rozas de Madrid, Spain  
Tel: +34-91-639-88-88

### GREECE

**Philippou Nakas S.A. The Music House**  
19th klm. Leof. Lavriou 190 02 Peania – Attiki,  
Greece  
Tel: +30-210-6686260

### SWEDEN

**Yamaha Music Europe GmbH Germany filial  
Scandinavia**  
JA Wettergrensgata 1, 421 30 Västra Frölunda,  
Sweden  
Tel: +46-31-89-34-00

### DENMARK

**Yamaha Music Denmark,  
Filial of Yamaha Music Europe GmbH, Tyskland**  
Generatorvej 8C, ST. TH., 2860 Søborg, Denmark  
Tel: +45-44-92-49-00

### FINLAND

**F-Musiikki Oy**  
Kluuvikatu 6, P.O. Box 260,  
SF-00101 Helsinki, Finland  
Tel: +358-9-618511

### NORWAY

**Yamaha Music Europe GmbH Germany -  
Norwegian Branch**  
Grini Næringspark 1, 1361 Østerås, Norway  
Tel: +47-6716-7800

### ICELAND

**Skifan HF**  
Skeifan 17 P.O. Box 8120, IS-128 Reykjavik,  
Iceland  
Tel: 525 5000

### RUSSIA

**Yamaha Music (Russia) LLC.**  
Room 37, entrance 7, bld. 7, Kievskaya street,  
Moscow, 121059, Russia  
Tel: +7-495-626-5005

### TURKEY/CYPRUS

**Yamaha Music Europe GmbH**  
**Merkezi Almanya Türkiye Istanbul Şubesi**  
Maslak Meydanı Sodak No:5 Spring Giz Plaza  
Bağımsız Böl. No:3, 34398 Şişli, Istanbul, Turkey  
Tel: +90-212-999-8010

### OTHER EUROPEAN COUNTRIES

**Yamaha Music Europe GmbH**  
Siemensstrasse 22-34, 25462 Rellingen, Germany  
Tel: +49-4101-303-0

## AFRICA/MIDDLE EAST

### SOUTH AFRICA

**Yamaha Music Gulf FZE South Africa Office**  
19 Eastern Service Road, Eastgate Ext.6, Sandton,  
Johannesburg, Republic of South Africa  
Tel: +27-11-656-4468

### OTHER COUNTRIES

**Yamaha Music Gulf FZE**  
JAFZA-16, Office 512, P.O.Box 17328,  
Jebel Ali FZE, Dubai, UAE  
Tel: +971-4-801-1500

## ASIA

### THE PEOPLE'S REPUBLIC OF CHINA

**Yamaha Music & Electronics (China) Co., Ltd.**  
2F, Yunhedasha, 1818 Xinzha-lu, Jingan-qu,  
Shanghai, China  
Tel: +86-400-051-7700

### HONG KONG

**Tom Lee Music Co., Ltd.**  
11/F., Silvercord Tower 1, 30 Canton Road,  
Tsimshatsui, Kowloon, Hong Kong  
Tel: +852-2737-7688

### INDIA

**Yamaha Music India Private Limited**  
Spazedge Building, Ground Floor, Tower A,  
Sector-47, Gurgaon- Sohna Road, Gurgaon-122002,  
Haryana, India  
Tel: +91-124-485-3300

### INDONESIA

**PT. Yamaha Musik Indonesia (Distributor)**  
Yamaha Music Center Bldg. Jalan Jend. Gatot  
Subroto Kav. 4, Jakarta 12930, Indonesia  
Tel: +62-21-520-2577

### KOREA

**Yamaha Music Korea Ltd.**  
8F, Dongsung Bldg. 21, Teheran-ro 87-gil,  
Gangnam-gu, Seoul, 135-880, Korea  
Tel: +91-124-485-3300

### MALAYSIA

**Yamaha Music (Malaysia) Sdn. Bhd.**  
No.8, Jalan Perbandaran, Kelana Jaya, 47301  
Petaling Jaya, Selangor, Malaysia  
Tel: +60-3-78030900

### SINGAPORE

**Yamaha Music (Asia) Private Limited**  
Block 202 Hougang Street 21, #02-00,  
Singapore 530202, Singapore  
Tel: +65-6740-9200

### TAIWAN

**Yamaha Music & Electronics Taiwan Co., Ltd.**  
2F, No.1, Yuandong Rd. Banqiao Dist.  
New Taipei City 22063, Taiwan  
Tel: +886-2-7741-8888

### THAILAND

**Siam Music Yamaha Co., Ltd.**  
3, 4, 15, 16th Fl., Siam Motors Building,  
891/1 Rama 1 Road, Wangmai,  
Pathumwan, Bangkok 10330, Thailand  
Tel: +66-2215-2622

### VIETNAM

**Yamaha Music Vietnam Company Limited**  
15th Floor, Nam A Bank Tower, 201-203 Cach  
Mang Thang Tam St., Ward 4, Dist.3,  
Ho Chi Minh City, Vietnam  
Tel: +84-8-3818-1122

### OTHER ASIAN COUNTRIES

<http://asia.yamaha.com>

## OCEANIA

### AUSTRALIA

**Yamaha Music Australia Pty. Ltd.**  
Level 1, 99 Queensbridge Street, Southbank,  
Vic. 3006, Australia  
Tel: +61-3-9693-5111

### NEW ZEALAND

**Music Works LTD**  
P.O. BOX 6246 Wellesley, Auckland 4680,  
New Zealand  
Tel: +64-9-634-0099

### COUNTRIES AND TRUST TERRITORIES IN PACIFIC OCEAN

<http://asia.yamaha.com>





Yamaha Global Site  
<http://www.yamaha.com/>

Yamaha Downloads  
<http://download.yamaha.com/>

Manual Development Department  
© 2015 Yamaha Corporation

Published 07/2015 POZC\*.\*- 01A0  
Printed in Indonesia



ZQ09830

ZQ09830