



DIGITAL MIXING CONSOLE

TF5

TF3

TF1

TF-RACK

V3.1 Reference Manual

Overview	4
Using this document.....	4
The display	4
Universal operations	8
Library screen	8
Keyboard screen	10
Menu	10
Button and slider operations	10
Toolbar	11
SCENE screen	11
METER screen	13
RECORDER screen (INPUT/OUTPUT/TITLE LIST screen)	14
MONITOR screen	18
SETUP screen (V3.0 and later).....	21
LOGIN screen (V3.0 and later).....	38
OVERVIEW screen	42
CH STRIP section	42
FADER section.....	44
Configuration screens	47
INPUT screen.....	47
EQ screen	49
GATE screen	53
COMP screen	55
FX screen (FX1/2, InsFX1–6)	57
SEND TO AUX screen	62
ASSIGN screen.....	63
CH VIEW screen.....	64
CH NAME screen	71
GEQ screen.....	72
OUTPUT screen	74
SEND FROM screen	75
DCA ASSIGN screen.....	76
DELAY screen (V2.5 and later).....	78

Maintenance screen	79
Initialize All Memory screen	79
Initialize Current Memory screen	80
Initialize NY64-D screen (V3.0 and later)	80
Input Port Trim screen.....	81
Output Port Trim screen.....	81
Fader Calibration screen (TF5/TF3/TF1)	82
Channel Color Calibration screen (TF5/TF3/TF1)	83
Reference	84
List of parameters saved in Scenes and Presets.....	84
Access limitation parameter list.....	90
Quick Config Input and input channel relationships	92
Warnings and error messages	94
Index	96
Product dimensions	98

Procedures

Recalling a Preset.....	9
Editing a Preset.....	9
Displaying configuration screens	11
Saving the current settings as a new Scene.....	12
Recalling a Scene.....	12
Editing a Scene.....	12
Setting the input	15
Setting the output.....	16
Recording.....	17
Playing back files stored on a USB storage device	18
Checking the input signals	19
Setting the oscillator.....	20
Using Recall safe function	25
Configuring settings in the PREFERENCE screen.....	29
Assigning a feature to a [USER DEFINED KEY]	32
Assigning a feature to a [USER DEFINED KNOB]	33
Assigning a feature to the footswitch.....	33
Configuring the custom fader bank	34
Recalling the CUSTOM FADER BANK (TF5/TF3/TF1)	34
Applying access permissions.....	40
Resetting user settings.....	40
Loading user settings to other TF series consoles	40
OVERVIEW screen operations.....	44
Copying settings from one channel and applying them to another channel	45
Setting stereo link and the input source.....	48
Adjusting EQ in manual mode.....	51
Adjusting EQ in 1-knob EQ mode.....	51
Setting HPF	52
Setting LPF	52
Setting the gate.....	54
Setting the compressor.....	56
Setting an effect	58
Setting an insert effect.....	58
Adjusting the SEND TO AUX level.....	63
Using GEQ	73
Using faders to adjust GEQ (TF5/TF3/TF1).....	73
Adjusting the SEND FROM level	75

Adjusting the send level from AUX channels, STEREO channels, and SUB channel to a MATRIX channel (V2.5 and later).....	75
Assigning channels to a DCA group.....	77
Using the maintenance screen.....	79
Calibrating the faders	82
If a fader must be calibrated again.....	82
Adjusting channel colors.....	83

Using this document

You can search for keywords and view reference pages while using this document.

Searching for keywords

You can use the search function of your PDF viewing software to search for the desired text within the document.

When using Adobe Reader, enter the desired text in the search bar and press your computer's <Enter> key to begin the search.

Moving backward and forward in your viewing history

When viewing this document using Adobe Reader, you can easily move backward and forward in your viewing history. This is particularly useful when you click a link to jump to another page, and then want to return to the original page.

Using the index

An index of the keywords and topics in this document can be found on [page 96](#). You can use the index to easily jump to the desired explanation or topic.

The display

Here we will introduce the different screens displayed on the TF Series console display.

OVERVIEW screen

This screen is displayed when you first turn on the console.

From here you can move to other screens depending on the operations that you want to perform.

You can return to the OVERVIEW screen at any time by pressing the Home key (⌂).

For the TF5/TF3/TF1, the CH STRIP section is displayed.

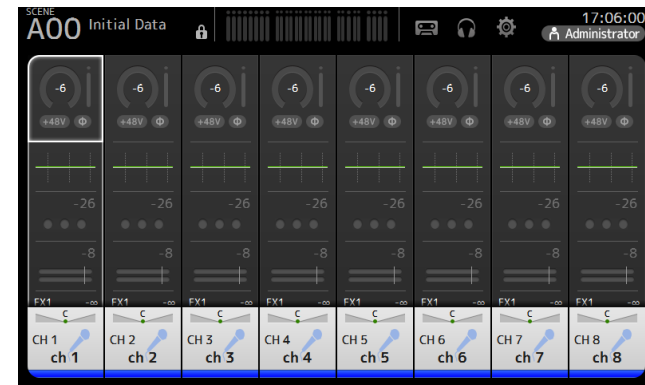

For the TF-RACK, the FADER section is displayed. You can switch between the CH STRIP section and FADER section by pressing the Home key (⌂).

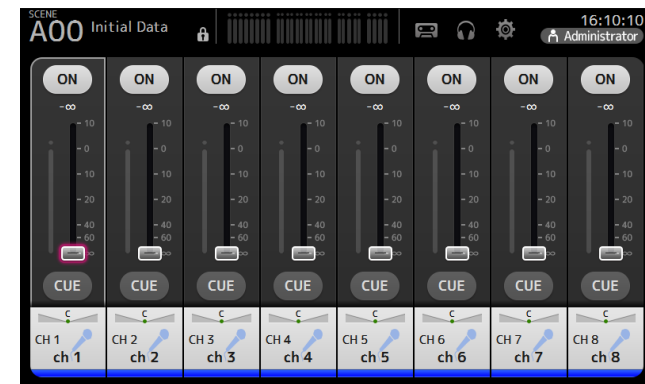

For more information about the OVERVIEW screen, see [page 42](#).

Configuration screens

You can touch an area of the OVERVIEW screen to display the configuration screen for the corresponding area.



- ① **Toolbar (→page 11)**
Displays buttons for frequently used features. When you touch a button, the corresponding configuration screen in the main area of the display.
- ② **Navigation area**
Allows you to select which screen is displayed in the main area of the display.
- ③ **Main area (→page 47)**
Displays the screen that you select using the toolbar or navigation area.

Navigation area

Displays the features of the currently selected channel.
You can drag the screen up and down to display other features.

CH1–CH32

- ① Displays the INPUT screen. (→page 47)
- ② Displays the EQ screen. (→page 49)
- ③ Displays the GATE screen. (→page 53)
- ④ Displays the COMP screen. (→page 55)
- ⑤ Displays the FX1 screen. (→page 57)
- ⑥ Displays the FX2 screen. (→page 57)
- ⑦ Displays the SEND TO AUX screen. (→page 62)
- ⑧ Displays the ASSIGN screen. (→page 63)
- ⑨ Displays the CH VIEW screen. (→page 64)

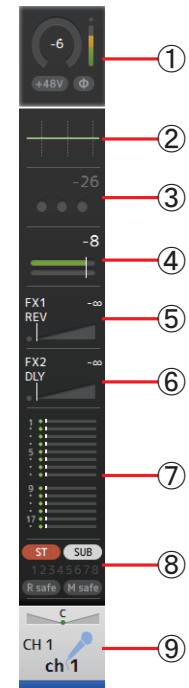

CH33-CH40

- ① Displays the INPUT screen. (→page 47)
- ② Displays the EQ screen. (→page 49)
- ③ Displays the FX1 screen. (→page 57)
- ④ Displays the FX2 screen. (→page 57)
- ⑤ Displays the SEND TO AUX screen. (→page 62)
- ⑥ Displays the ASSIGN screen. (→page 63)
- ⑦ Displays the CH VIEW screen. (→page 64)

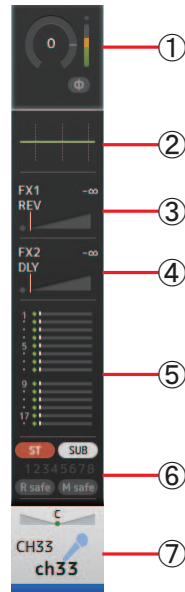

STIN1/2

- ① Displays the INPUT screen. (→page 47)
- ② Displays the EQ screen. (→page 49)
- ③ Displays the FX1 screen. (→page 57)
- ④ Displays the FX2 screen. (→page 57)
- ⑤ Displays the SEND TO AUX screen. (→page 62)
- ⑥ Displays the ASSIGN screen. (→page 63)
- ⑦ Displays the CH VIEW screen. (→page 64)

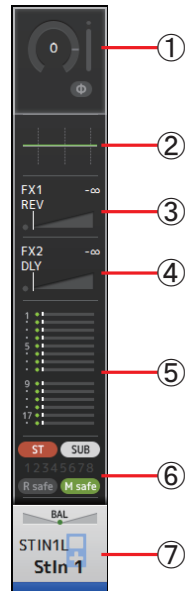

FX RTN 1/2

- ① Displays the SEND FROM screen. (→page 75)
- ② Displays the FX1 screen. (→page 57)
- ③ Displays the EQ screen. (→page 49)
- ④ Displays the SEND TO AUX screen. (→page 62)
- ⑤ Displays the ASSIGN screen. (→page 63)
- ⑥ Displays the CH VIEW screen. (→page 64)

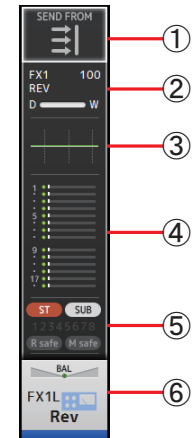

AUX1-AUX8

- ① Displays the SEND FROM screen. (→page 75)
- ② Displays the EQ screen. (→page 49)
- ③ Displays the GEQ screen. (→page 72)
- ④ Displays the COMP screen. (→page 55)
- ⑤ Displays the OUTPUT screen. (→page 74)
- ⑥ Displays the CH VIEW screen. (→page 64)

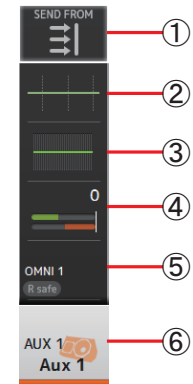

AUX9/10–AUX19/20

- ① Displays the SEND FROM screen. (→page 75)
- ② Displays the EQ screen. (→page 49)
- ③ Displays the COMP screen. (→page 55)
- ④ Displays the INSFX screen. (→page 57)
- ⑤ Displays the OUTPUT screen. (→page 74)
- ⑥ Displays the CH VIEW screen. (→page 64)

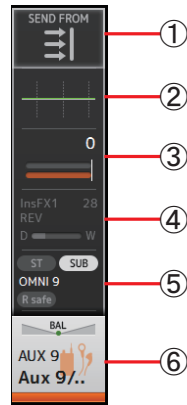

DCA1–DCA8

- ① Displays the DCA ASSIGN screen. (→page 76)
- ② Displays the CH VIEW screen. (→page 64)

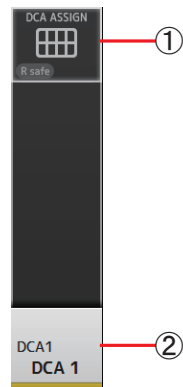

STEREO

- ① Displays the EQ screen. (→page 49)
- ② Displays the GEQ screen. (→page 72)
- ③ Displays the COMP screen. (→page 55)
- ④ Displays the OUTPUT screen. (→page 74)
- ⑤ Displays the CH VIEW screen. (→page 64)

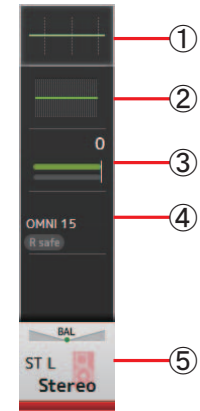

SUB

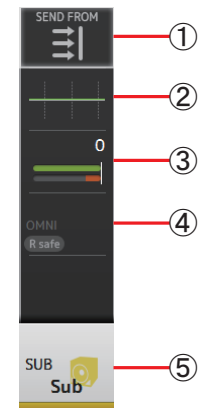

- ① Displays the SEND FROM screen. (→page 75)
- ② Displays the EQ screen. (→page 49)
- ③ Displays the COMP screen. (→page 55)
- ④ Displays the OUTPUT screen. (→page 74)
- ⑤ Displays the CH VIEW screen. (→page 64)

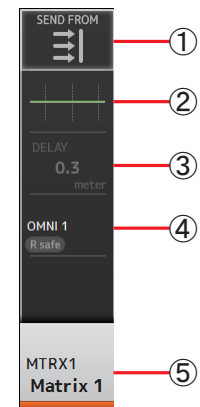

MATRIX1–MATRIX4

- ① Displays the SEND FROM screen. (→page 75)
- ② Displays the EQ screen. (→page 49)
- ③ Displays the DELAY screen. (→page 78)
- ④ Displays the OUTPUT screen. (→page 74)
- ⑤ Displays the CH VIEW screen. (→page 64)



In this section we will introduce the screens that are displayed when you press the Library key () and the Menu key (), which are found in the Display section of the console's top panel.

Library screen

Allows you to recall saved Presets.

A Preset is a collection of settings that are customized for a certain type of input, microphone, instrument, etc. By recalling a Preset, you can set up a channel quickly and easily according to the type of input, and then fine-tune the settings to your specific needs. You can even save your own Presets.

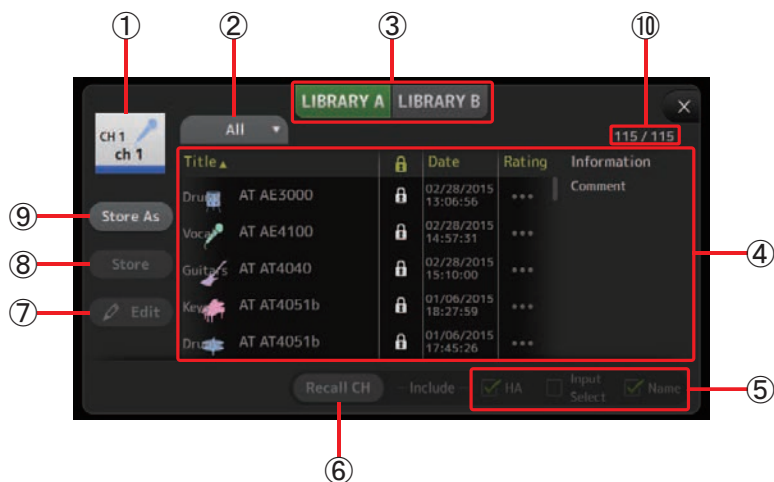

- ① **Channel name**
Displays the name of the channel.
- ② **Category selection button**
Allows you to select a category.
Presets that match the selected category are displayed in the Library list.
- ③ **Library selection button**
Allows you to switch between the available Libraries. The Presets that are stored in the selected Library are displayed in the list.
LIBRARY A: Displays the Presets stored in LIBRARY A.
LIBRARY B: Displays the Presets stored in LIBRARY B.

- ④ **List**
You can click a header in the list to sort the items by that header. (List items cannot be sorted by "Information".)
To select a Preset, simply touch it. The selected Preset is highlighted, and can then be saved, recalled, or edited.
A lock icon is displayed or cleared each time you touch the  column. When the icon is displayed, the Preset is write-protected.
The date on which the Preset was last saved is displayed in the Date column.

- ⑤ **Recall on/off checkboxes**
Allow you to determine which parameters will be recalled (checkbox on) and not be recalled (checkbox off).

Input channels

HA: Analog/digital gain setting, phantom power on/off, phase setting

Input Select: Input source settings

Name: Channel name, icon, and color

AUX 1–8, STEREO channels

GEQ: GEQ settings

Name: Channel name, icon, and color

FX RTN, AUX9/10–AUX19/20 channels

FX: Effect settings

Name: Channel name, icon, and color

SUB, MATRIX1–4 channels

Name: Channel name, icon, and color

- ⑥ **Recall CH button**
Recalls a Preset to the selected channel.
- ⑦ **Edit button**
Touch this button to display the keyboard so you can edit the title and comment. (Keyboard screen → [page 10](#))
- ⑧ **Store button**
Saves the settings for the current channel as a Preset. The settings will overwrite the Preset selected in the Library list.
- ⑨ **Store As button**
Saves the settings for the current channel as a new Preset.
Touch this button to display the keyboard so you can enter the Preset name. (Keyboard screen → [page 10](#))
- ⑩ **Preset number (V1.1 and later)**
Displays the Preset number. The first number indicates the number of Presets in the selected category (②), and the second number indicates the total number of Presets.

Displaying the Library screen from a configuration screen

When you display the Library screen from a configuration screen, one of the following buttons is added to the Library screen, depending on the configuration screen you were using.

Recall EQ button

Displayed when you enter the Library from the EQ screen, and recalls EQ settings only.

Recall Gate button

Displayed when you enter the Library from the GATE screen, and recalls GATE settings only.

Recall COMP button

Displayed when you enter the Library from the COMP screen, and recalls COMP settings only.

Recall FX button

Displayed when you enter the Library from the FX screen, and recalls FX settings only.

Recall GEQ button

Displayed when you enter the Library from the GEQ screen, and recalls GEQ settings only.

Recalling a Preset

1. Touch a Library selection button to select the Library that contains the desired Preset.

A list of Presets is displayed.

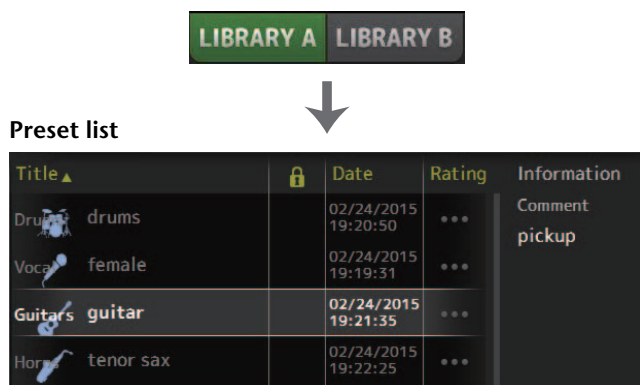

You can click a header in the list to sort the items by that header. (List items cannot be sorted by "Information".)

2. Touch the desired Preset.

The selected Preset is highlighted.

3. Select the items that will be recalled.

Turn the checkboxes on for items that you want to recall.

4. Touch the Recall CH button.

The Preset is recalled to the selected channel.

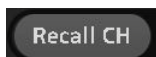

Editing a Preset

1. Recall the desired Preset.

2. Touch the Edit button.

Display the keyboard so you can edit the title and comment. (Keyboard screen → page 10)

Edit the desired items.

3. touch the Store or Store As button.

Store button: Saves the settings for the current channel as a Preset. The settings will overwrite the Preset selected in the Library list.

Store As button: Saves the settings for the current channel as a new Preset.

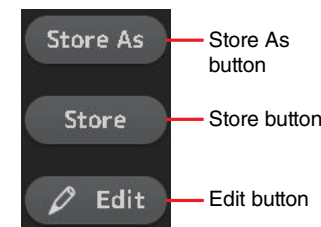

Library screen menu

Press the Menu key (☰) from the Library screen to display the following items.

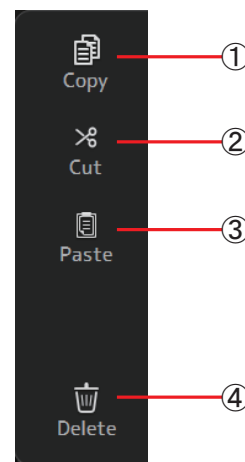

- ① **Copy**
Copies the selected Preset.
- ② **Cut**
Cuts the selected Preset.
- ③ **Paste**
Pastes the copied or cut Preset to the Library.
- ④ **Delete**
Deletes the selected Preset.

Keyboard screen

Allows you to edit titles and comments.

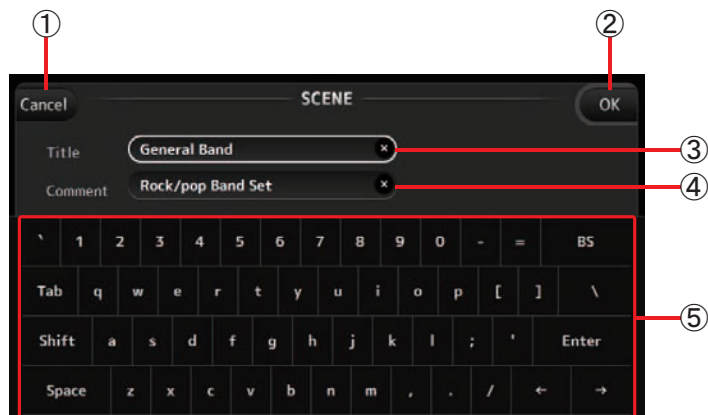

- ① **Cancel button**
Discards any changes you made and returns to the previous screen.
- ② **OK button**
Saves the changes you made.
- ③ **Title field**
Enter the name of the Scene here.
- ④ **Comment field**
Enter comments about the Scene here.
- ⑤ **Keyboard**
Touch to enter the desired text.

Menu

Displays a menu of options available in the current screen. The content of the menu varies depending on which screen is being displayed. For information about each menu, refer to the description for the corresponding page.

Button and slider operations

Item	Term	Description
	Close button [X]	Touch to close the current screen.
	OK button	Applies the current settings.
	Cancel button	Cancels the operation and returns to the previous screen.
	Clear button	Clears the information you entered.
	Jump icon	Displays the relevant screen.
	Slider	Flashes in pink when you touch it to indicate it can be operated. You can then drag the slider on the display or turn the [TOUCH AND TURN] knob to adjust the setting.
	Pan slider	Flashes in pink when you touch it to indicate it can be operated by the [TOUCH AND TURN] knob.
	Balance slider	
	Edit icon	Displays the screen where you can edit information, such as the keyboard screen.
	Menu	Touch a button with "▼" displayed on it to display the menu.
	Text box	When you touch a text box that can accept values, it flashes in pink to indicate that its content can be changed. Touch the box again to display the screen that allows you to enter values. You can also change the value by turning the [TOUCH AND TURN] knob. When you touch a text box that can accept text, the keyboard screen is displayed.
When on (example): When off (example): 	On and off	Switches between on and off when you touch the item.

Provides access to frequently used features and system settings.
The toolbar is displayed regardless of the screen content.

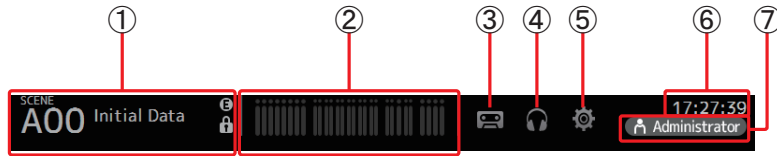

- ① Displays the SCENE screen.
- ② Displays the METER screen. (→page 13)
- ③ Displays the RECORDER screen. (→page 14)
- ④ Displays the MONITOR screen. (→page 18)
- ⑤ Displays the SETUP screen. (→page 21) (V3.0 and later)
- ⑥ Displays the current time. (→page 36)
- ⑦ Displays the LOGIN screen. (→page 38) (V3.0 and later)

The name of the user that is currently logged in is displayed with the icon. Additionally, the following items may be displayed to indicate the corresponding status.

- ACCESS:** The console is accessing the USB storage device that is connected to its USB connector.
- CUE:** The cue is turned on.
- OSCILLATOR:** The oscillator is turned on.
- Quick Config:** Quick Config is being used. (V2.0 and later)

Displaying configuration screens

When you touch an icon, the corresponding configuration screen is displayed.
To return to the previous screen, touch the icon again, or touch the close button ([X]) in the upper right of the screen.

SCENE screen

Allows you to manage previously saved mixer setups, or "Scenes".
When you recall a Scene, you can exempt certain settings from being replaced by the settings contained in the Scene; this is called "recall safe".

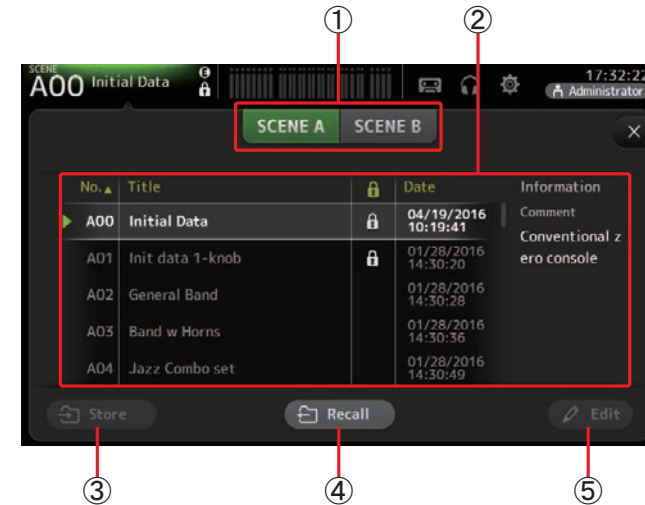

- ① **Scene list selection button**
Allows you to switch between the available Scene lists.
SCENE A: Displays Scene list A.
SCENE B: Displays Scene list B.
- ② **Scene list**
Displays the Scenes saved in the selected Scene list.
You can click a header in the list to sort the items by that header. (List items cannot be sorted by "Information".)
To select a Scene, simply touch it. The selected Scene is highlighted, and can then be saved, recalled, or edited.
A green triangle is displayed next to the Scene that is currently recalled.
A lock icon is displayed or cleared each time you touch the  column. When the icon is displayed, the Scene is write-protected.
The date on which the Scene was last saved is displayed in the Date column.

③ **Store button**

Saves the current mixer setup and assigns it to the Scene number selected in the Scene list.

Touch this button to display the keyboard so you can edit the title and comment. (Keyboard screen→page 10)

④ **Recall button**

Recalls the Scene that is selected in the Scene list.

⑤ **Edit button**

Touch this button to display the keyboard so you can edit the title and comment. (Keyboard screen→page 10)

Saving the current settings as a new Scene

1. Touch the Scene area of the Toolbar.



2. Touch a Scene list selection button to select the Scene list.

The Scene list is displayed.

3. Touch a blank Scene.

No.▲	Title	🔒	Date
A02	General Band		01/28/2016 14:30:28
A03	Band w Horns		01/28/2016 14:30:36
A04	Jazz Combo set		01/28/2016 14:30:49
A05			
A06			

Blank Scene

4. Touch the Store button.

Display the keyboard so you can edit the title and comment (Keyboard screen→page 10).

Enter the new Scene name and a comment.

5. Touch the OK button.

The settings will be saved as a new Scene.

Recalling a Scene

1. Touch a Scene list selection button to select the Scene list that contains the desired Scene.

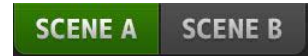

The Scene list is displayed.

2. Touch the desired Scene.

The selected Scene is highlighted.

You can click a header in the list to sort the items by that header. (List items cannot be sorted by "Information".)

Selected Scene

No.▲	Title	🔒	Date
A00	Room01		11/12/2014 17:43:24
A01	Room03		11/17/2014 09:29:22
A02	Live01		11/17/2014 09:29:49
A03	Live05		11/17/2014 09:30:00
A04			

3. Touch the Recall button.

The mixer settings saved in the Scene are recalled.

The name of the recalled Scene is displayed in the upper left of the screen.



Editing a Scene

1. Select the Scene that you want to edit.

2. Touch the Edit button.

Display the keyboard so you can edit the title and comment (Keyboard screen→page 10).

Edit the desired items.

3. Touch the OK button.

The settings will overwrite the Scene selected in the Scene list.

SCENE screen menu

Press the Menu key () from the Scene screen to display the following items.

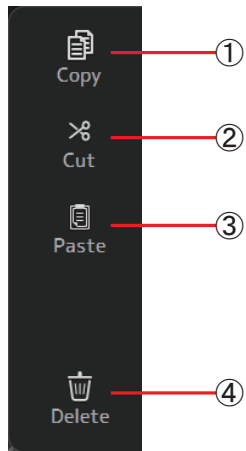

- ① **Copy**
Copies the selected Scene.
- ② **Cut**
Cuts the selected Scene.
- ③ **Paste**
Pastes the copied or cut Scene to the Scene list.
- ④ **Delete**
Deletes the selected Scene.

METER screen

Displays the input and output level of all the channels, and allows you to select the metering point (i.e., the point at which the level is detected).

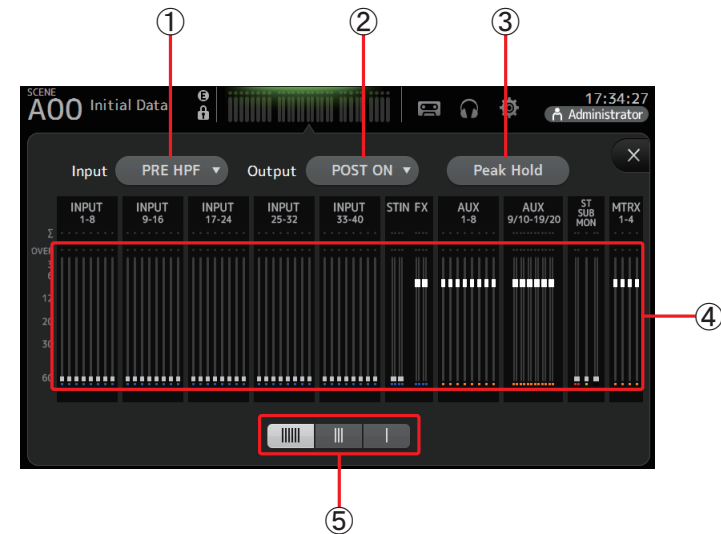

- ① **Input metering point selection menu**
Select the input level metering point from the menu.
PRE HPF: After the head amp; before the HPF
PRE FADER: Before the fader
POST ON: After the [ON] key
- ② **Output metering point selection menu**
Select the output level metering point from the menu.
PRE EQ: Before the EQ
PRE FADER: Before the fader
POST ON: After the [ON] key
- ③ **Peak Hold button**
Turn this button on to hold the peak level for each level meter. Turn this button off to remove the peak level that was being held. The Peak Hold on/off setting affects both input and output channels.

NOTE

You can assign the Peak Hold button to a [USER DEFINED KEY]. (→page 29)

④ **Meters**

Display the input and output levels of the channels.

⑤ **Meter display selection button**

Allows you to select how many meters are displayed. Three display modes are available.

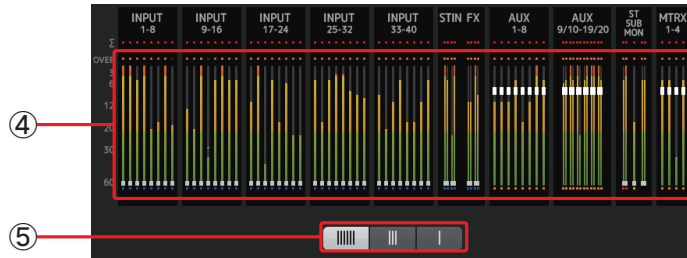

RECORDER screen (INPUT/OUTPUT/TITLE LIST screen)

You can connect a USB storage device to the console's iPad connector and use the console to record audio to the device, play back audio files stored on the device, and manage audio files stored on the device.

When a USB storage device is connected to the iPad connector, your TF series console can record its internal signals to the device as an audio file and play back files that are stored on the device.

You can also connect an iOS device to the console and use your iPad or iPhone as an audio input source for the mixer.

Recorded files are formatted as 48 kHz, 24-bit stereo WAV files.

Playback is supported for WAV and MP3 (MPEG-1 Audio Layer-3) files.

These features allow you to record signals from the STEREO and AUX buses to the USB storage device, and use audio files that are saved on your iPad or USB storage device as the source for the console's ST IN 1 channel.

NOTE

- Simultaneous recording and playback is not supported.
- While recording, the signal being recorded cannot be used as an INPUT channel.
- Compatible USB storage devices must be formatted in FAT32. If necessary, connect the device to the USB connector (on the right side of the top panel) and use the contextual menu in the SAVE/LOAD screen to format the device.
- Use only USB storage devices with a sector size of 512 bytes. (Certain large-capacity hard disk drives may not be compatible with the console.)
- USB storage devices with an allocation unit size under 4096 bytes are not supported. (This may apply to small-capacity USB memory devices.)
- For recording, we recommend using a high-speed device, such as a hard disk drive (HDD) or solid-state drive (SSD). USB memory devices and iOS devices can be used for playback only.
- For playback, MP3 files must be encoded at 44.1 kHz or 48 kHz, with a bit rate of 128 kbps–320 kbps. Files encoded using variable bit rate (VBR) can be played back, but file length and elapsed playback time may not be displayed properly.

INPUT/OUTPUT screen

Allows you to configure inputs and outputs for playback and recording.

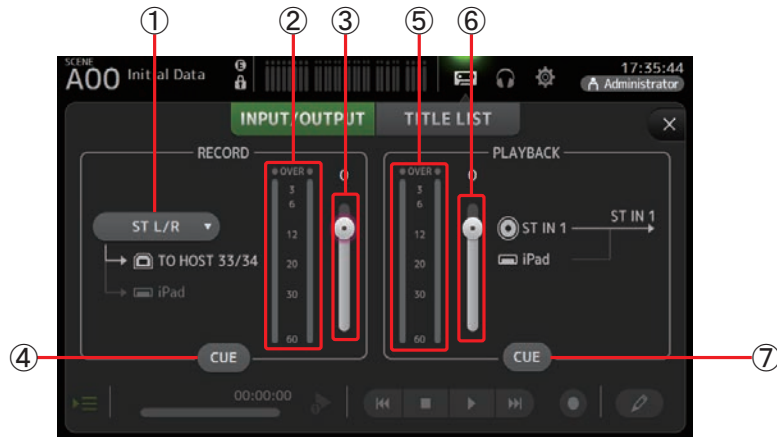

1 RECORD source selection menu

Allows you to select the source that will be recorded.

The source selected here is also output to CH33 and CH34 of the USB TO HOST connector.

2 RECORD level meter

Displays the recording level.

3 RECORD level slider

Adjusts the recording level.

4 RECORD CUE button

Turns the recording source cue on and off.

5 PLAYBACK level meter

Displays the playback level.

6 PLAYBACK level slider

Adjusts the playback level.

7 PLAYBACK CUE button

Turns the playback source cue on and off.

NOTE

When an iPad or other iOS device is connected, "iOS device is connected. Use transport control on the device." is displayed, and the playback button is not displayed. Use the corresponding app on the iOS device to control playback.

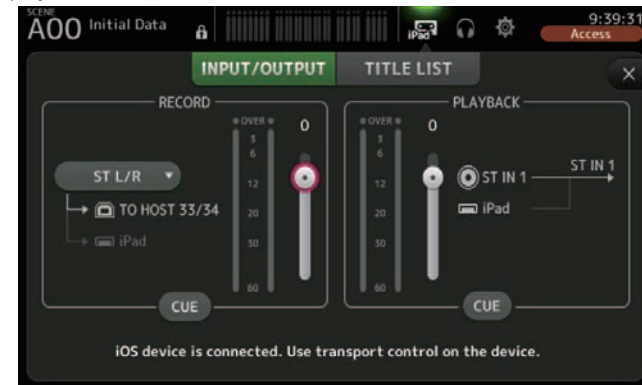

Setting the input

1. Touch the RECORD source selection menu and select the source you want to record.



2. Drag the RECORD level slider and adjust the recording level.

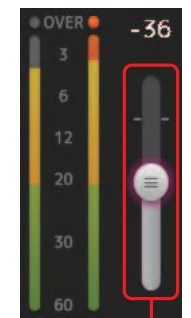

RECORD level slider

3. If you want to monitor the record source, touch the RECORD CUE button to turn the cue on.



Setting the output

1. Drag the PLAYBACK level slider and adjust the playback level.

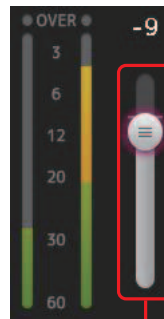

PLAYBACK level slider

2. Touch the PLAYBACK CUE button to turn the cue on.



TITLE LIST screen

When a USB storage device is connected to the console via the iPad connector, you can use this screen to play back audio files saved on the device and record the signal from the 2MIX source to the device.

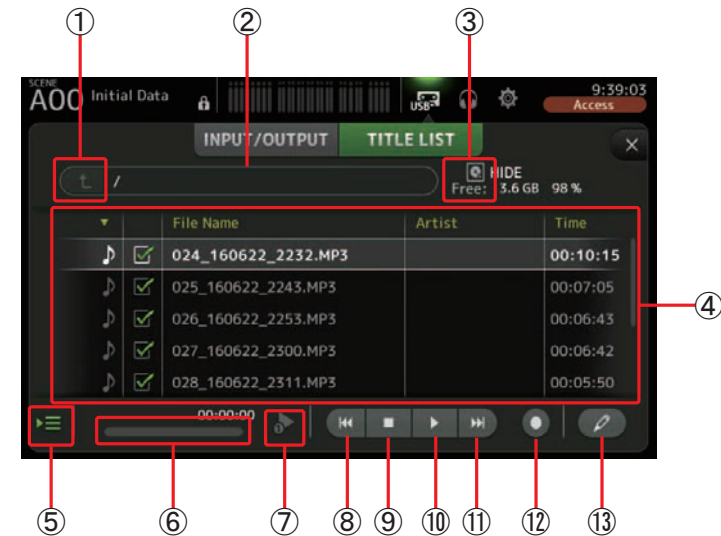

- 1 **Parent directory button**
Displays the directory that is one level above the current directory.
- 2 **Current directory**
Displays the path of the current directory on the USB storage device.
- 3 **USB storage device information**
Displays the volume name of the USB storage device.
The amount of available space (i.e., available capacity and available percentage of total capacity) on the USB storage device is also displayed.
- 4 **File list**
Displays a list of the files in the current directory.
You can click a header in the list to sort the items by that header.
Touch a file name to select the file for playback or editing.
Touch the music note icon to start and pause playback.
Files whose checkboxes are turned on will be played back-to-back during continuous playback.
The name of each file in the directory is displayed in the File Name column.
Artist information is displayed in the Artist column (MP3 files only) and the length of the file is displayed in the Time column.

⑤ **Follow playback button**

When this button is turned on during continuous playback, the file that is currently playing is highlighted in the file list.

⑥ **File information**

When playing back an MP3 file, the file's bit rate and the current playback location are displayed here.

When playing back a WAV file, the file's sample rate and the current playback location are displayed here.

When recording, the WAV file's sample rate and the elapsed recording time are displayed here.

⑦ **Playback mode selector button**

You can select the desired playback mode.

Touch the button to toggle through the available modes.



: SINGLE playback; the file is played and then playback stops.



: SINGLE REPEAT; the file plays repeatedly until you stop playback.



: ALL; all files with checkboxes turned on in the file list are played back one after another, and then playback stops.



: ALL REPEAT; all files with checkboxes turned on in the file list are played back one after another, and then playback repeats until you stop playback.

⑧ **Previous button**

Moves the playback location to the beginning of the current file or to the beginning of the previous file.

⑨ **Stop button**

Stops playback and recording.

⑩ **Play/pause button**

Starts and pauses playback.

⑪ **Next button**

Moves the playback location to the beginning of the next file.

⑫ **Record button**

Sets the console to record-ready mode.

⑬ **File name edit button**

Allows you to edit the file's name.

NOTE

When an iPad or other iOS device is connected, "iOS device is connected. Use transport control on the device." is displayed, and the playback button is not displayed. Use the corresponding app on the iOS device to control playback.

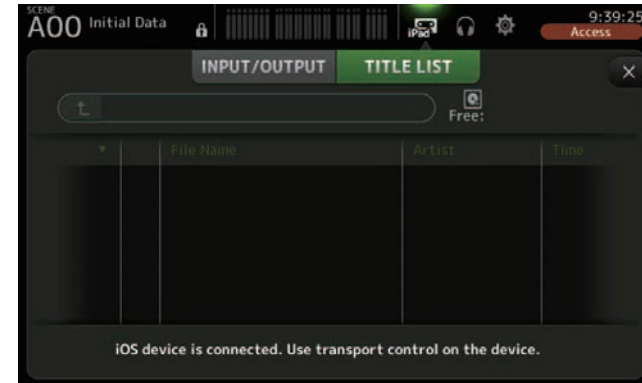

Recording

1. Connect a compatible USB storage device to the iPad connector.

2. Touch the record button.

The record button begins flashing to indicate that the console is in record-ready mode.

3. When you're ready to start recording, touch the play/pause button.

The record button remains lit during recording.

You can touch the play/pause button to pause and resume recording.

4. When you're ready to stop recording, touch the stop button.

The recorded file is named automatically based on the console's date and time setting.

5. If necessary, touch the file name edit button and change the file name.

Playing back files stored on a USB storage device

1. Touch the file that you want to play in the file list.

To play a file stored in a different directory, touch the parent directory button and navigate to the desired directory.

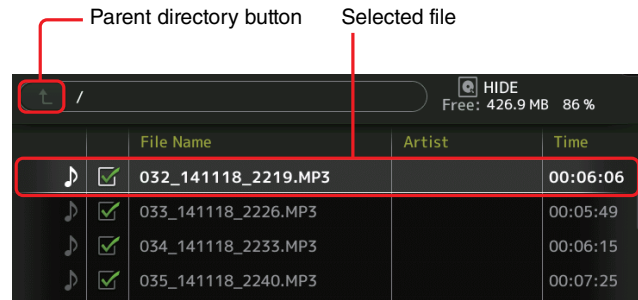

2. Touch the playback mode selector button and select the desired mode.

3. Touch the play button.

Playback begins.

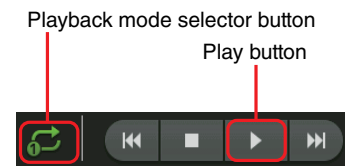

RECORDER screen menu

Press the Menu key (☰) from the RECORDER screen to display the following items.

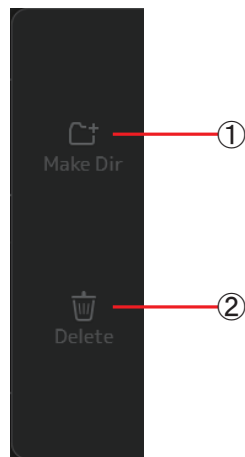

- ① **Make Dir**
Makes a new directory in the current directory.
- ② **Delete**
Deletes the selected file.

MONITOR screen

Allows you to manage cue and monitor signals and to control oscillators.

The CUE/MONITOR screen is used to control the signals that are monitored using headphones and near-field monitors. Here you can select the sources that will be continuously monitored, and select individual channels for monitoring using the CUE feature.

The OSCILLATOR screen is used to configure the oscillator and turn it on and off. The console has a built-in oscillator that can output a sine wave or pink noise to the desired bus, allowing you to check external devices or test the characteristics of a venue.

CUE/MONITOR screen

Allows you to monitor certain inputs using headphones or speakers. You can select which sources will be monitored, change the monitor signal to mono, or add a delay.

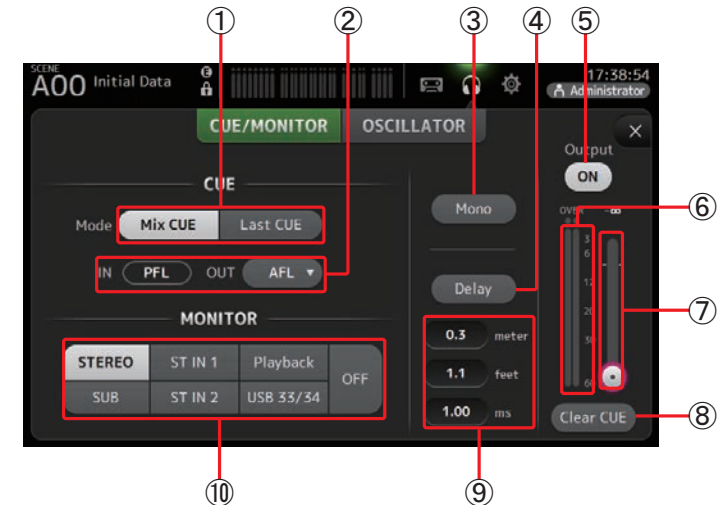

- ① **CUE mode button**
Used to select the CUE mode.
Mix CUE: Enables cue for multiple channels.
Last CUE: Enables cue for the last channel selected.
- ② **CUE point selection buttons**
Selects the point in the signal path that will be monitored.
PFL: Before the fader
AFL: After the fader (inputs are PFL only)
- ③ **Mono button**
Allows you to change the monitor signal to mono.

- ④ **Delay button**
Delays the monitor signal.
- ⑤ **Monitor output button**
Turns the monitor output on and off.
The signal is output from the [PHONES] jack regardless of this setting.
- ⑥ **Monitor level meter**
Displays the monitor level.
- ⑦ **Monitor level slider**
Adjusts the monitor output level.
The signal is output from the [PHONES] jack regardless of this setting.
- ⑧ **Clear CUE button**
Cancels all cue selections.
- ⑨ **Delay setting**
Determines the delay time by specifying distance (meters or feet) or time (milliseconds).
Touch a text box to display the keyboard and enter a value. (→page 10)
- ⑩ **Monitor selection buttons**
Allow you to select the sources that will be monitored.

TF5/TF3/TF1



TF-RACK

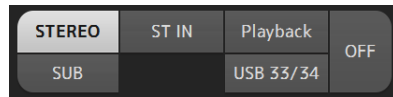

Checking the input signals

1. Touch a CUE mode button to select the desired cue mode.
2. Select the desired monitor sources by touching the corresponding monitor selection buttons.
3. Select the desired cue point by touching the corresponding CUE point selection button.
4. Touch the monitor output button to turn the monitor output on and off.
5. Drag the monitor level slider to adjust the monitor level.
6. Select the desired delay time.
Touch one of the delay setting text boxes to display the keyboard. You can set the delay time by specifying distance (meters and feet) or time (milliseconds).
7. Touch the delay button.
The delay is turned on.

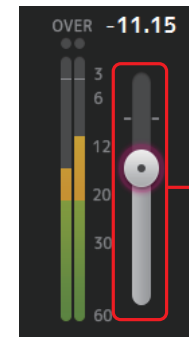

Monitor level slider

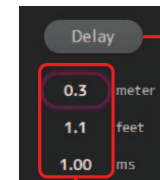

Delay button

Delay setting Text boxes

OSCILLATOR screen

Allows you to configure the oscillator.

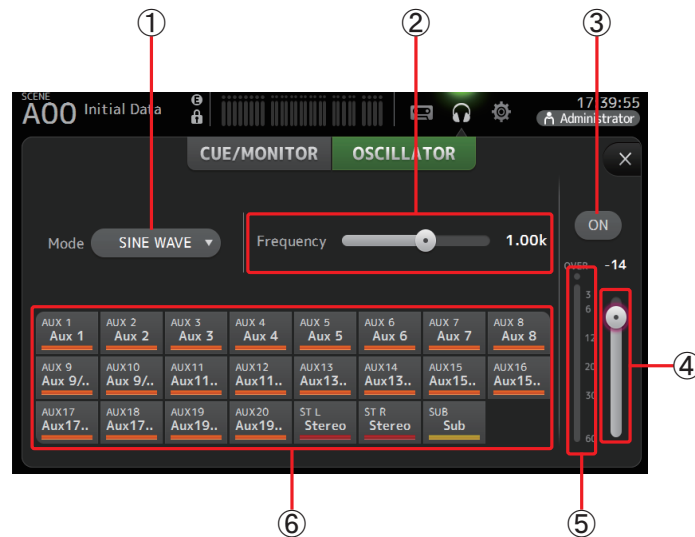

① Oscillator mode button

Allows you to select the oscillator mode.

SINE WAVE: A sine wave will be output continuously.

PINK NOISE: Pink noise will be output continuously.

BURST NOISE: Pink noise will be output intermittently.

② Parameter sliders

Allows you to adjust parameters for the oscillator.

When the oscillator mode is set to SINE WAVE, this setting determines the frequency of the sine wave.

When the oscillator mode is set to BURST NOISE, this setting determines the Width (duration of the noise) and Interval (length of silence between noise bursts).

When the oscillator mode is set to PINK NOISE, nothing is displayed here.

③ Oscillator output button

Turns the oscillator output on and off. When the oscillator is turned on, the oscillator signal is sent to the input channels that are selected by the oscillator assignment buttons.

④ Oscillator output level slider

Adjusts the oscillator output level.

⑤ Oscillator output meter

Displays the oscillator output level.

⑥ Oscillator assignment buttons

Determine which channels the oscillator is sent to. You can select multiple channels.

Setting the oscillator

1. Touch the oscillator mode button and select the desired mode.



2. Use the oscillator assignment buttons to determine which channels the oscillator signal will be sent to.

Channel is selected



3. Touch the oscillator output button to turn on the oscillator output.

4. While referring to the oscillator output level meter, drag the oscillator level slider to adjust the oscillator output level.

When the oscillator mode is set to SINE WAVE, you can also adjust the frequency of the oscillator.

When the oscillator mode is set to BURST NOISE, you can also adjust Width (duration of each noise burst) and the Interval (duration of each silence between noise bursts).

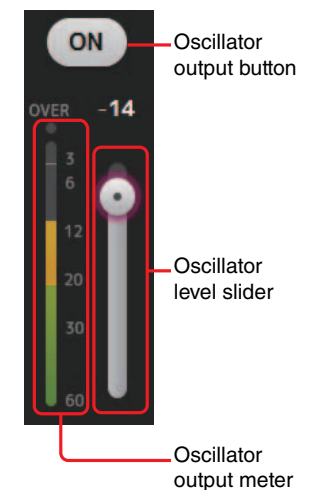

SETUP screen (V3.0 and later)

Allows you to configure general mixer settings, as well as settings for OMNI OUT, Recall Safe, [USER DEFINED KEYS], [USER DEFINED KNOBS], custom fader banks, and other preferences.

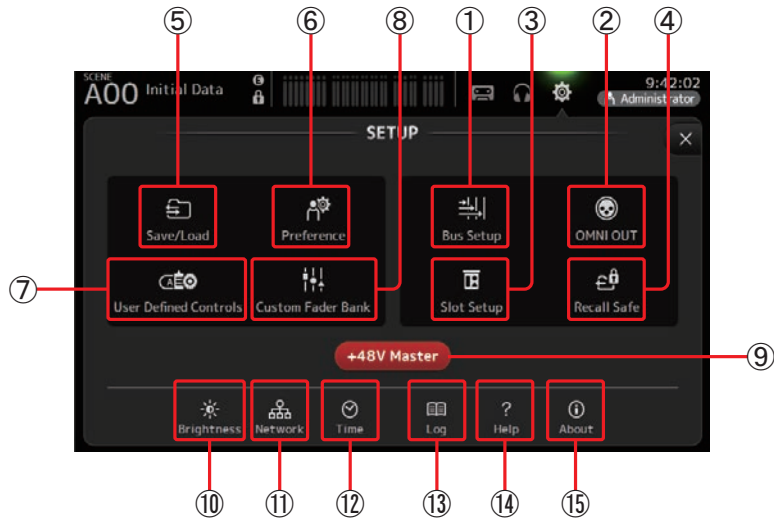

- ① **Bus Setup icon (→page 22)**
Displays the BUS SETUP screen.
- ② **OMNI OUT icon (→page 22)**
Displays the OMNI OUT screen.
- ③ **Slot Setup icon (→page 23) (V2.0 and later)**
Displays the SLOT SETUP screen.
- ④ **Recall Safe icon (→page 25)**
Displays the RECALL SAFE screen.
- ⑤ **Save/Load icon (→page 26)**
Displays the SAVE/LOAD screen.
- ⑥ **Preference icon (→page 28)**
Displays the PREFERENCE screen.
- ⑦ **User Defined Control icon (→page 29)**
Displays the USER DEFINED CONTROLS screen.
- ⑧ **Custom Fader Bank icon (→page 34)**
Displays the CUSTOM FADER BANK screen.

- ⑨ **+48V Master button**
Master button that turns the console's phantom power feature on and off. When this button is turned off, phantom power will not be supplied to any channels, even if their +48V buttons are turned on. (→page 47)
- ⑩ **Brightness icon (→page 35)**
Displays the BRIGHTNESS screen.
- ⑪ **Network icon (→page 35)**
Displays the NETWORK screen.
- ⑫ **Time icon (→page 36)**
Displays the TIME screen.
- ⑬ **Log icon (→page 37)**
Displays the LOG screen.
- ⑭ **Help icon (→page 37)**
Displays the HELP screen.
- ⑮ **About icon (→page 38)**
Displays the ABOUT screen.

BUS SETUP screen

Allows you to configure bus settings. You can change basic settings such as stereo/mono, Pan Link, etc. These settings are included when saving a Scene.

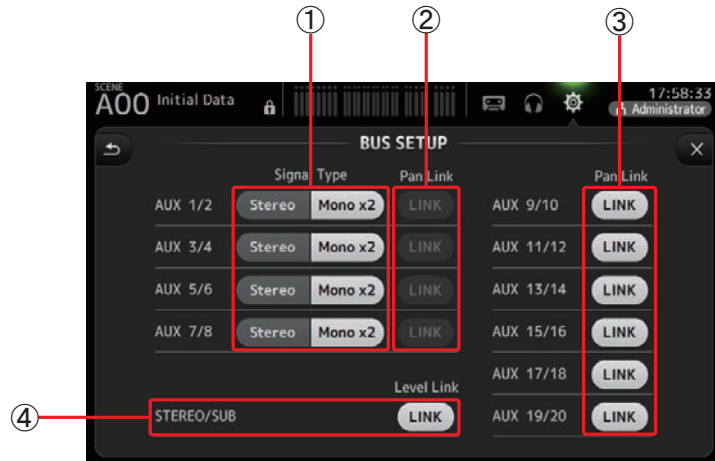

① **AUX1/2–AUX7/8 signal type buttons**

Determines how each pair of buses is processed. You can set each pair to be either Stereo (an odd and even numbered bus are paired and main parameters are shared between the two) or MONO x2 (two independent mono channels).

② **AUX1/2–AUX7/8 Pan Link buttons**

Turns pan link on and off for AUX1/2–AUX7/8.

These buttons are only displayed if the Signal Type of the corresponding bus is set to Stereo. When these buttons are turned on, the pan setting of signals sent from input channels to the corresponding two buses will link with the Stereo bus pan setting.

③ **AUX9/10–AUX19/20 Pan Link buttons**

Turns pan link on and off for AUX9/10–AUX19/20.

④ **STEREO/SUB Level Link button (V1.1 and later)**

When turned on, the levels of the STEREO channel and the SUB channel are linked. For V3.0 and later, when turned on, the gain for both channels can be adjusted together but the difference in gain between the two channels is maintained. Additionally, for TF5/TF3/TF1, you can adjust the difference in gain between the two channels by adjusting the faders while pressing the [SEL] key on the panel.

OMNI OUT screen

Allows you to configure the output channels that are sent to the OMNI OUT jacks.

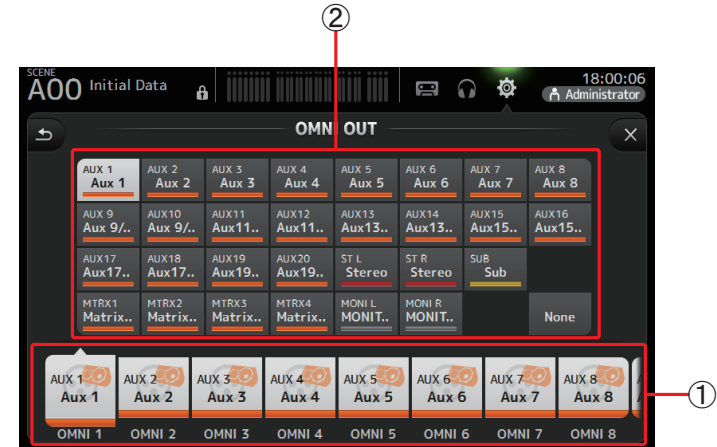

① **OMNI OUT1–16 buttons**

Allows you to select which OMNI OUT jack will be configured.

The name of the channel currently assigned to each OMNI OUT jack is also displayed in the buttons.

② **Output channel buttons**

Determines which output channel or monitor output will be assigned to the OMNI OUT jack you selected for ①. If you select None, nothing will be output to the corresponding OMNI OUT jack.

OMNI OUT screen menu

Press the Menu key () from the OMNI OUT screen to display the following items.

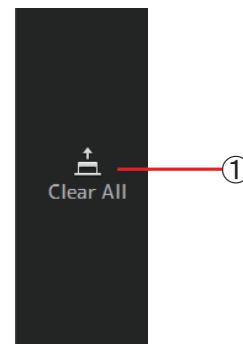

① **Clear All**

Clears all assignments for each OMNI OUT jack (all will be set to None).

SLOT SETUP screen (V2.0 and later)

Displays settings and information related to the Tio1608-D I/O Rack that is connected to the console via the NY64-D that is installed in the expansion slot.

The information that is displayed varies depending on the connection status of the Tio1608-D and the Quick Config settings.

NOTE

Quick Config automatically configures essential settings, making it easy to connect a Tio1608-D. It can automatically configure Dante Network settings and audio signal patching for connections between the console and up to three Tio1608-D units. For information about Tio1608-D settings, refer to the documentation for the Tio1608-D.

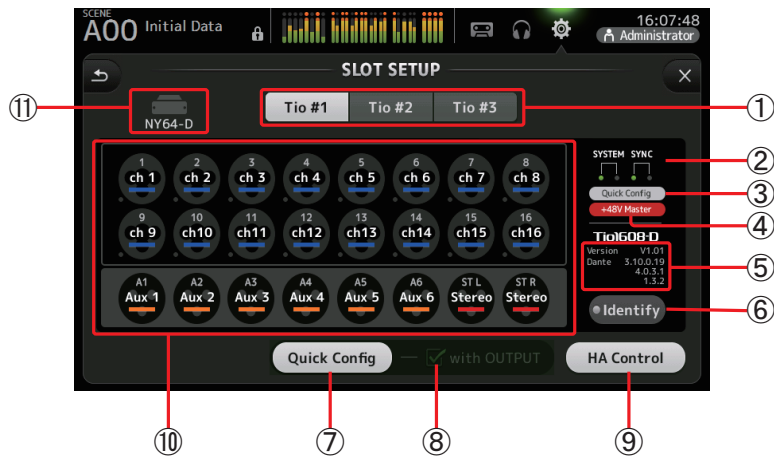

① UNIT ID button

Allows you to select the unit ID of the Tio1608-D whose information is displayed. If the Tio1608-D is operating in Dante AES67 mode, "AES67" is displayed above and to the right of the unit ID.

NOTE

Dante Controller (v3.10.0.19 and later) is required in order for the Tio1608-D to operate in AES67 mode.

② SYSTEM and SYNC indicators

Display the same information as the [SYSTEM] and [SYNC] indicators on the Tio1608-D. If an error occurs, details are displayed on the UNIT ID button.



If Dante Device Lock has been enabled for the corresponding Tio1608-D, a lock icon is displayed on the UNIT ID button. (V3.1 and later)



NOTE

Dante Device Lock is a feature that prevents unintended operation. Dante Controller (v3.10.0.19 and later) is required to use Dante Device Lock.

③ Quick Config status indicator

Indicates the status of the Tio1608-D's [QUICK CONFIG] switch. Displayed in gray when turned off, and white when turned on. Displayed in orange if the Dante settings set by Dante Controller differ from the Quick Config settings.

④ +48V Master status indicator

Indicates the status of the Tio1608-D's +48V Master switch. Displayed in gray when turned off, and red when turned on.

⑤ Version information

Displays the version of the Tio1608-D firmware, as well as the Dante firmware contained in the Tio1608-D.

⑥ Identify button

Helps you identify the connected Tio1608-D. While this button is being touched, the LED on the corresponding Tio1608-D flashes.

NOTE

If the audio signals of the Tio1608-D that corresponds to the UNIT ID button are patched, the Identify button and various information about the Tio1608-D (error details, status, and version) are displayed, regardless of the Quick Config button status.

⑦ Quick Config button

Turns the console's Quick Config feature on and off. Displayed in gray when turned off, and white when turned on. Displayed in orange if the Dante settings set by Dante Controller differ from the Quick Config settings.

For information about Tio1608-D channel support when using Quick Config, see "Quick Config Input and input channel relationships" (→page 92).

NOTE

- You can use Dante Controller to change Dante patches even when the Quick Config feature is enabled. However, Quick Config patching will be applied when you restart the console. If you want to use Dante Controller to change these settings, disable the Quick Config feature.
- If devices that are configured by Quick Config are also locked by Dante Device Lock, a message is displayed and the Quick Config may not be implemented. (V3.1 and later)
- Up to 24 I/O racks (Tio1608-D, R series, etc.) can be connected to the same Dante network. If more racks are connected, a message is displayed and the HA control may not operate properly.

⑧ **with OUTPUT checkbox**

Determines whether the Tio1608-D OUTPUT ports are connected to the console when the console is turned on and Quick Config is enabled.

When the checkbox is turned on and if Quick Config is enabled, the Tio1608-D and the console are patched automatically.

This checkbox can be turned on and off when the Quick Config button is turned off.

NOTE

- When Quick Config is enabled, only one TF series console on the network can use the Tio1608-D OUTPUT ports. If one or more other Tio1608-D units on the network have OUTPUT ports used by another TF series console, the with OUTPUT checkbox turns off automatically and a popup screen is displayed.
- When the with OUPUT checkbox is turned off and you are using Dante Controller for patching, refer to "Quick Config Input and input channel relationships" (→page 92) for information about output port assignments for channels.

⑨ **HA Control button**

Determines whether the head amp of the Tio1608-D is controlled by the console.

Displayed in gray when turned off, and white when turned on.

When turned off, analog gain and +48V phantom power is disabled for input channels set to SLOT, and the current setting is displayed.

NOTE

- When there are multiple host devices on the same network that can control the head amp, repeated operations could result, therefore we recommend having only one host device control the head amp.
- Even when Quick Config is turned off, you can use Dante Controller to patch into the corresponding SLOT input channel (refer to "Quick Config Input and input channel relationships" (→page 92)) and control the head amp for up to 8 I/O racks.

⑩ **Channel display area**



The following information is displayed when the console's Quick Config button is turned on and a Tio1608-D with the [QUICK CONFIG] switch turned on is connected.

- CH Name
- CH Color
- +48V setting for each channel (the indicator below and to the left of the channel icon lights in red when turned on)

⑪ **SLOT display area (V3.1 and later)**

Displays the status of the expansion slot.

If no NY card is installed, "No Card" is displayed.



If an NY64-D is installed and Dante Device Lock has been enabled, a lock icon is displayed.



If the NY64-D is operating in Dante AES67 mode, "AES67" is displayed above and to the right of the SLOT display area.



NOTE

Dante Controller (v3.10.0.19 and later) is required in order for the NY64-D to operating in AES67 mode.

RECALL SAFE screen

Allows you to configure which items are recalled and which items are not (i.e., recall safe) when recalling Scenes and Presets.

"Recall safe" allows you to select certain parameters, channels, DCA groups, etc. whose settings will not be replaced when recalling a Preset or Scene.



① Channel selection buttons

Allows you to select which types of channels will be configured.

When you select a channel type, the different parameters that can be configured as recall safe are displayed.

② Parameter names

Touch the ▼ button to turn SAFE parameters on and off for all channels of the same type.

The ▼ button turns green when all SAFE parameters are turned on. If turned off for a parameter on all channels, it is displayed in gray. Finally, if recall safe is turned on for a parameter but not for all channels, the ▼ button under the parameter name is displayed in blue.

③ Recall safe on/off buttons

Turns recall safe on and off for the corresponding parameter. When turned on, the corresponding parameter is recall safe, i.e., its setting will not be changed when a Preset or Scene is recalled.

For OMNI OUT assignments, recall safe can be turned on and off for OMNI OUT PATCH only.

④ Channel information

Displays the channel ID, name, and icon.

Touch the SAFE button to turn safe recall on and off for the corresponding channel. When turned on, parameters whose recall safe on/off buttons are in the "on" position will not be recalled.

Using Recall safe function

1. Touch a channel selection button to select the channels or DCA groups that you want to configure for recall safe.



2. Touch the recall safe on/off buttons according to the items you want to make recall safe.

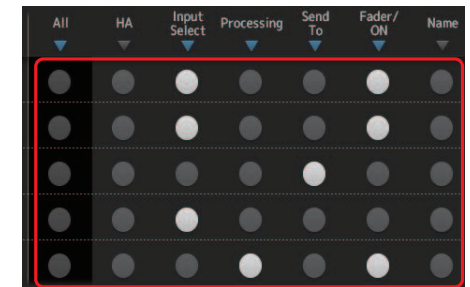

Recall safe on/off buttons

3. Touch the SAFE buttons for each channel to enable or disable the settings you made above.

4. Touch the [X] button to close the screen, and proceed to recall the desired Preset or Scene.



SAFE buttons

SAVE/LOAD screen

Displays a list of saved directories and files.

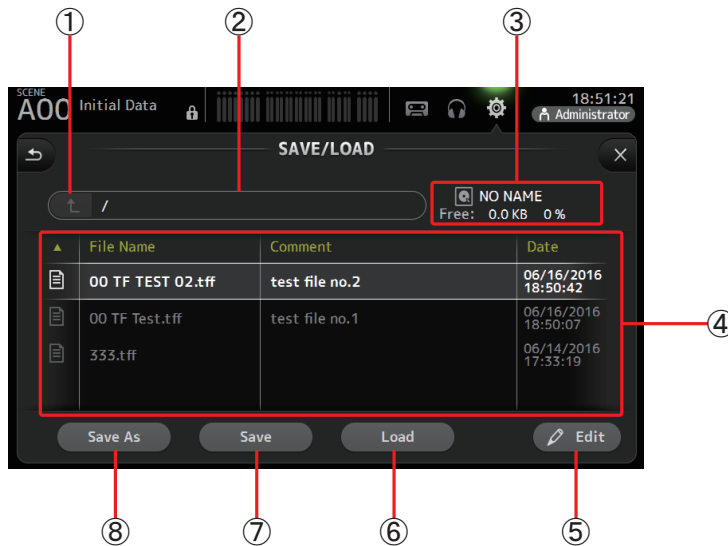

- ① **Parent directory button**
Displays the directory that is one level above the current directory. This button is grayed out if the current directory is the top directory.
- ② **Current directory**
Displays the name of the current directory.
- ③ **Volume name**
Displays the volume name of the USB storage device and the amount of available space.
- ④ **File list**
Displays a list of the directories and files stored on the USB storage device. When an item in the file list is selected, it is highlighted to indicate it will be the subject of any subsequent operations.
You can touch a header in the list to sort the items by that header. Touch the same header again to switch between ascending and descending order.
File Name: Displays directory and file names. An icon is displayed for each item so that you can distinguish between the two.
Comment: Displays any comments you have entered for TF Series console files. To edit a file's comment, select the file and then touch the Edit button to display the keyboard (→page 10).
Date: Displays each item's modified date.

- ⑤ **Edit button**
Allows you to edit the selected file's file name and comment.
- ⑥ **Load button**
Loads the file selected in the file list.
The LOAD SELECT screen is displayed when you press the Load button. (V2.0 and later)
- ⑦ **Save button**
Saves the current settings by overwriting them over the file selected in the file list.
- ⑧ **Save As button**
Saves the current settings by saving them as a new file.

SAVE/LOAD screen menu

Touch the Menu key (☰) from the SAVE/LOAD screen to display the following items.

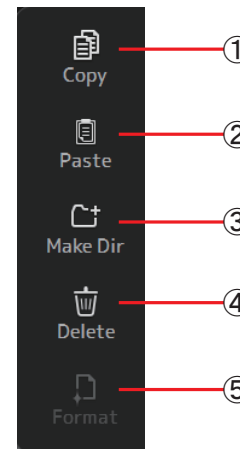

- ① **Copy**
Copies the selected file.
- ② **Paste**
Pastes the file into the current directory.
- ③ **Make Dir**
Creates a new directory.
- ④ **Delete**
Deletes the selected file.
- ⑤ **Format**
Formats the USB storage device that is connected to the console.

LOAD SELECT screen (V2.0 and later)

Allows you to select which data is loaded when you load a TF Series setup file.

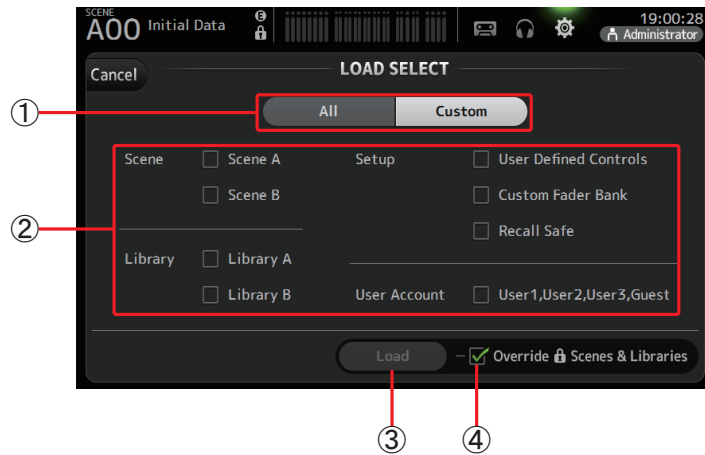

① All/Custom selection button

Allows you to select the type of data that will be loaded. When All is selected, all data will be loaded.

When Custom is selected, the checkboxes on this screen can be used to select the data that will be loaded.

② Data selection checkboxes

Turn on the checkboxes according to the type of data that you want to load.

The User Account checkbox is displayed for both All and Custom, but you can change the checkbox setting only when you are logged in as the Administrator.

③ Load button

Touch this button to load the data.

④ Override Protected Scenes & Libraries checkbox

When this checkbox is turned on, protected Scenes and Libraries will also be overwritten by loaded data. If you want to prevent protected Scenes and Libraries from being overwritten, turn off this checkbox.

Data that can be saved and loaded

The following data can be saved and loaded on the SAVE/LOAD screen.

Data that is saved/loaded	Description
Scene Memory	All Scenes and the current Scene
Channel Library	All channel Presets
+48V Master	
Mute Safe	
Mute Master	
Cue	Except channel cue settings
Oscillator	Except oscillator on
Monitor	
Meter	
Recall Safe	
User Defined Keys	
User Defined Knobs	
Foot Switch	
Custom Fader Bank	
Preference	Except the following settings: Help Language, Show Help at Startup, Touch Area Optimization, [Home] Key
Slot Setup	Quick Config, HA Control
User Account	Only when logged in as Administrator

Data that is not saved/loaded	Description
Cue	Channel cue settings
Oscillator	Oscillator on
Brightness	
Preference	Help Language, Show Help at Startup, Touch Area Optimization settings, [Home] Key
Date Time	
Network	
Console Lock	
Input Port Trim	
Output Port Trim	
Fader Calibration	
Channel Color Calibration	

PREFERENCE screen

Allows you to configure general operating settings regarding confirmation message display, [SEL] key behavior, etc.

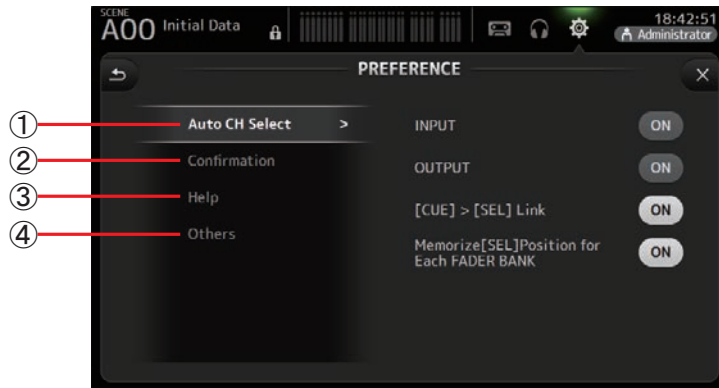

① Auto CH Select section

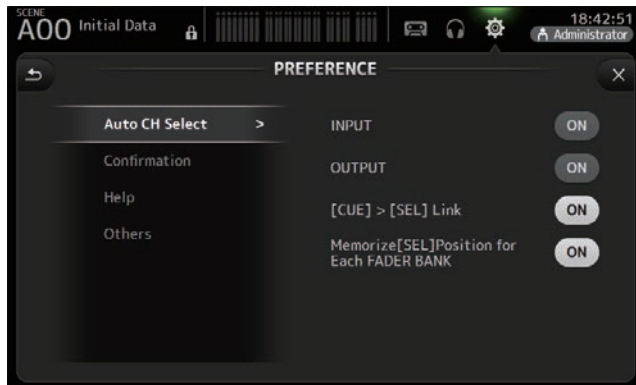

INPUT/OUTPUT: When turned on, a channel of the corresponding type will be selected automatically when you operate that channel's fader. You can turn this feature on and off independently for input channels and output channels.

[CUE] > [SEL] LINK: When turned on, a channel will be selected when you turn its CUE on.

Memorize [SEL] Position for Each FADER BANK: Determines whether channel positions are remembered in fader banks.

② Confirmation section

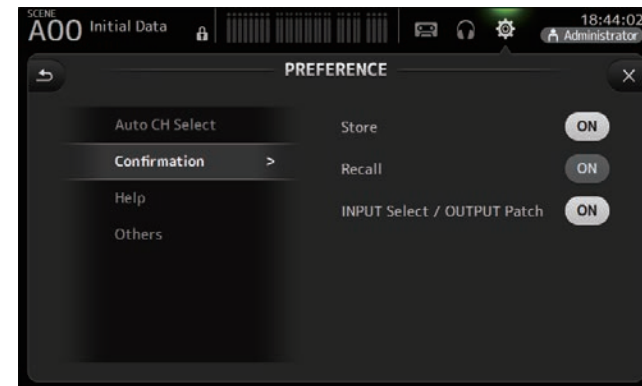

Store/Recall: When turned on, a confirmation message is displayed when you store and recall features.

INPUT Select/OUTPUT Patch: When turned on, a confirmation message is displayed when you change the input selection or OMNI OUT patching.

③ Help section

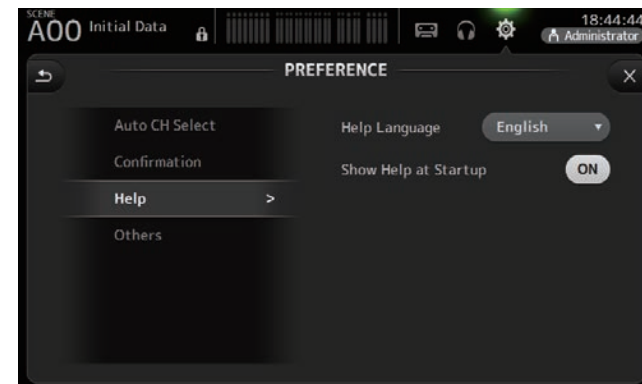

Help Language: Determines the language used when displaying the HELP screen.

Show Help at Startup: Determines whether the HELP screen is displayed automatically after the console starts up.

④ Others section

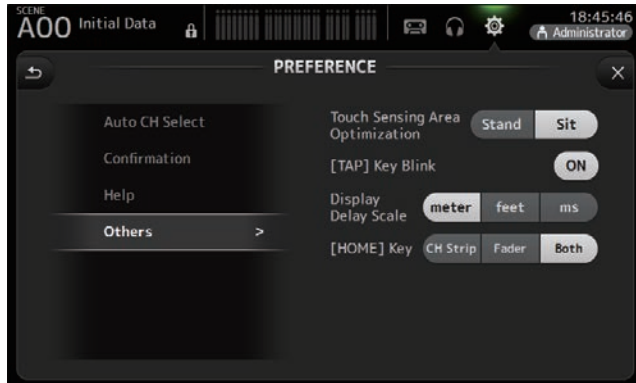

- Touch Sensing Area Optimization:** Allows you to optimize the touchscreen's sensitivity.
 - Stand:** Optimized for operating the touchscreen when you are positioned above it, such as when standing.
 - Sit:** Optimized for operating the touchscreen when you are positioned below it, such as when sitting.
- [TAP] Key Blink (V2.0 and later):** Allows you to turn the flashing [TAP] key on or off. The [TAP] key can be used to tap the tempo even when the flashing is turned off.
- Display Delay Scale (V2.5 and later):** You can select the desired units (meters, feet, milliseconds) that are displayed in the MATRIX channel DELAY box.
- [HOME] Key (V3.0 and later):** Allows you to choose what is displayed when you press the Home key (⌂) to display the OVERVIEW screen. You can choose CH Strip, Fader, or Both. When Both is selected, you can switch between the CH STRIP section and FADER section by pressing the Home key (⌂).

Configuring settings in the PREFERENCE screen

1. Use the buttons on the PREFERENCE screen to configure the settings as desired.
2. When finished, touch the close button ([X]).

USER DEFINED CONTROLS screen

This screen allows you to assign features to the [USER DEFINED KEYS], [USER DEFINED KNOBS], and to the footswitch.

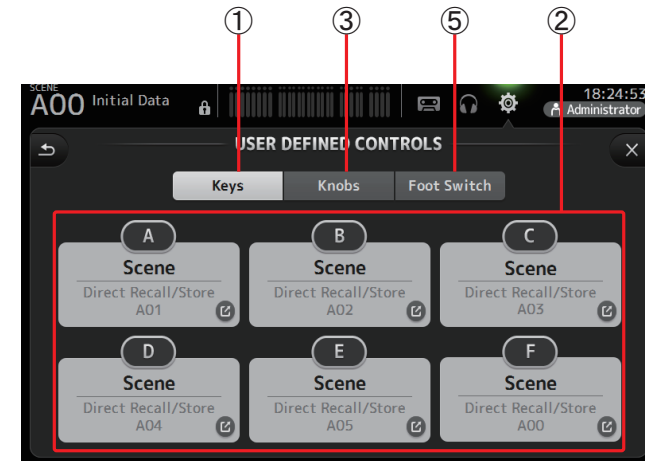

- ① **Keys button**
Allows you to assign features to the [USER DEFINED KEYS] on the top panel.
- ② **Key setup buttons (A–F)**
Touch the desired button to display the screen that allows you to assign features to the corresponding key.

Features that can be assigned to [USER DEFINED KEYS]

FUNCTION	PARAMETER1	PARAMETER2	Description
No Assign			No feature is assigned
Brightness	Bank Change		Switches the brightness setting bank. This feature is supported from V1.1.
CH ON	Specific CH	CH 1–40, ST IN 1, ST IN 2, FX 1, FX 2, DCA 1–8, AUX 1–8, AUX 9/10–19/20, STEREO, SUB MATRIX1–4 (V2.5 and later)	Turns the channel assigned to PARAMETER 2 on and off.

FUNCTION	PARAMETER1	PARAMETER2	Description
CH Select	Inc		Select channels in order of the direction selected for PARAMETER 1.
	Dec		
CH Select	Specific CH	CH 1–40, ST IN 1L–ST IN 2R FX1L–FX2R, AUX 1–8, AUX 9–20, STEREO L, STEREO R, SUB MATRIX1–4 (V2.5 and later)	Selects the channel assigned to PARAMETER 2.
CUE	Specific CH	CH 1–40, ST IN 1, ST IN 2, FX 1, FX 2, DCA 1–8, AUX 1–8, AUX 9/10–19/20, STEREO, SUB MATRIX1–4 (V2.5 and later)	Turns the cue on and off for the channel assigned to PARAMETER 2.
Effect	Bypass	FX 1, FX 2, INS FX 1–6	Bypasses the effect assigned to PARAMETER 2.
EQ	Band Select	HPF, LPF, Low, Low-Mid, High-Mid, High	Selects the band assigned to PARAMETER 2. (V3.0 and later)
Help			Displays help information.
Meter	Peak Hold ON		Turns the peak hold on and off.
Monitor	Output		Turns the monitor out on and off.
	Source Select	STEREO, SUB, STIN 1, STIN 2, STIN (TF-RACK), USB 33/34, Playback	Selects the monitor source assigned to PARAMETER 2.
Oscillator	Oscillator On		Turns the oscillator on and off.
	Specific CH	AUX 1–20, STEREO L, STEREO R, SUB	Turns the oscillator sent to the channel assigned to PARAMETER 2 on and off.
Page Change	Bookmark		Press and hold for more than 2 seconds to bookmark the current screen. Press and hold for less than two seconds to display the bookmarked screen.
	Bookmark with "SEL"		The selected channel is saved with the bookmark. Same as above.
	Close Popup		Closes the popup screen.
Recorder	Transport	Play/Pause	Same as the Play/Pause button on the RECORDER screen.
		Stop	Same as the Stop button on the RECORDER screen.
		Next	Same as the Next button on the RECORDER screen.
		Previous	Same as the Previous button on the RECORDER screen.
		Rec	Same as the Rec button on the RECORDER screen.
		Auto Rec	Recording stops and the file is saved, and then recording resumes immediately as a new file.
		Rec & Start	Recording starts immediately without entering record-ready mode.

FUNCTION	PARAMETER1	PARAMETER2	Description
SCENE	Inc		Same as the INC, DEC, STORE, and RECALL keys.
	Dec		
	Store		
	Recall		
	Inc Recall		Recalls the next numbered Scene.
	Dec Recall		Recalls the previous numbered Scene.
	Direct Recall/Store	A00–99, B00–99	Recalls the Scene number assigned to PARAMETER 2. Press and hold for more than two seconds to assign the current settings to that Scene number.

③ **Knobs button**

Allows you to assign features to the [USER DEFINED KNOBS].

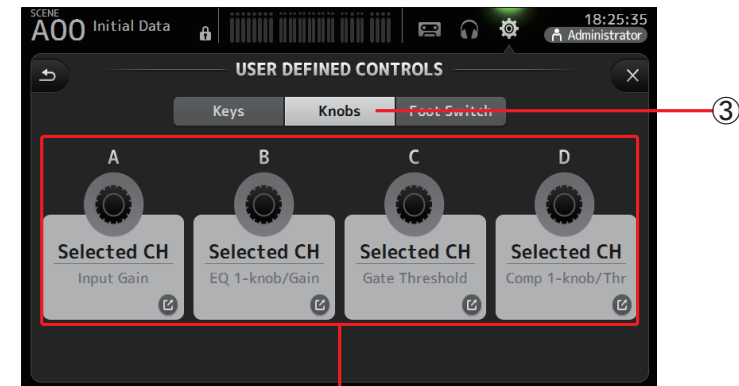

④ Knob setup buttons

④ **Knob setup buttons**

Touch the desired button to display the screen that allows you to assign features to the corresponding [USER DEFINED KNOBS].

Features that can be assigned to [USER DEFINED KNOBS]

Features	Description	
No Assign	No feature is assigned	
Brightness	CH Name	Adjusts the brightness of the CH NAME. (TF5/TF3/TF1 only)
	CH Color	Adjusts the brightness of the CH COLOR indicator. (TF5/TF3/TF1 only)
	Screen	Adjusts the brightness of the touchscreen.
	Panel	Adjusts the brightness of the panel LEDs.
CH Level	Specific CH	Adjusts the level of the channel assigned to PARAMETER 2. (V3.0 and later)
CH Select	Inc/Dec	Selects the channel. (V3.0 and later)
Monitor Level		Adjusts monitor level.

Features	Description
CH Level	Adjusts the level of the selected channel. (V3.0 and later)
Comp 1-knob/Thr	Adjusts 1-knob or threshold for the selected channel's COMP. When 1-knob COMP is turned on, adjusts 1-knob; when 1-knob COMP is turned off, adjusts threshold.
Digital Gain	Adjusts the DIGITAL GAIN of the selected channel. (V3.0 and later)
EQ 1-knob/Gain	Adjusts 1-knob or gain for the selected channel's EQ. When 1-knob EQ is turned on, adjusts 1-knob; when 1-knob EQ is turned off, adjusts gain.
EQ Band Select	Selects the band for the selected channel. (V3.0 and later)
EQ Frequency	Adjusts EQ frequency for the selected channel.
EQ Q	Adjusts EQ Q for the selected channel.
Gate Threshold	Adjusts gate threshold for the selected channel.
HPF	Adjusts HPF for the selected channel. Turn the knob to adjust the frequency.
Input Gain	Adjusts analog gain or digital gain for the selected channel. When the channel's input is an analog source, adjusts analog gain. When the channel's input is a digital source (i.e., USB, iPad, or STIN), adjusts digital gain.
Send Level	Adjusts the send level to the bus selected for PARAMETER2 (FX, AUX, SUB) for the selected channel. (V3.0 and later)
Pan/BAL	Adjusts pan or balance for the selected channel.

Features that can be assigned to the footswitch

FUNCTION	PARAMETER1	PARAMETER2	Description
No Assign			No feature is assigned
Brightness	Bank Change		Switches the brightness setting bank. This feature is supported from V1.1.
CH ON	Specific CH	CH 1-40, ST IN 1, ST IN 2, FX 1, FX 2, DCA 1-8, AUX 1-8, AUX 9/10-19/20, STEREO, SUB MATRIX1-4 (V2.5 and later)	Turns the channel assigned to PARAMETER 2 on and off.
		Inc Dec	
CH Select	Specific CH	CH 1-40, ST IN 1L-ST IN 2R, FX1L-FX2R, AUX 1-8, AUX 9-20, STEREO L, STEREO R, SUB MATRIX1-4 (V2.5 and later)	Selects the channel assigned to PARAMETER 2.
Clear Cue			Clears all cue selections. Same as the CLEAR CUE key on the top panel.
CUE	Specific CH	CH 1-40, ST IN 1, ST IN 2, FX 1, FX 2, DCA 1-8, AUX 1-8, AUX 9/10-19/20, STEREO, SUB MATRIX1-4 (V2.5 and later)	Turns the cue on and off for the channel assigned to PARAMETER 2.
Effect	Bypass	FX 1, FX 2, INS FX 1-6	Bypasses the effect assigned to PARAMETER 2.
EQ	Band Select	HPF, LPF, Low, Low-Mid, High-Mid, High	Selects the band assigned to PARAMETER 2. (V3.0 and later)
Help			Displays help information.
Meter	Peak Hold ON		Turns the peak hold on and off.
	Output		Turns the monitor out on and off.
Monitor	Source Select	STEREO, SUB, ST IN 1, ST IN 2, STIN (TF-RACK), USB 33/34, Playback	Selects the monitor source assigned to PARAMETER 2.
Mute Master	Input		Same as the corresponding MUTE key on the top panel.
	FX		
Oscillator	Oscillator On		Turns the oscillator on and off.
	Specific CH	AUX 1-20, STEREO L, STEREO R, SUB	Turns the oscillator sent to the channel assigned to PARAMETER 2 on and off.
Page Change	Bookmark		Press and hold for more than 2 seconds to bookmark the current screen. Press and hold for less than two seconds to display the bookmarked screen.
	Bookmark with "SEL"		The selected channel is saved with the bookmark. Same as above.
	Close Popup		Closes the popup screen.

⑤ Foot Switch button

Allows you to assign features to the footswitch.

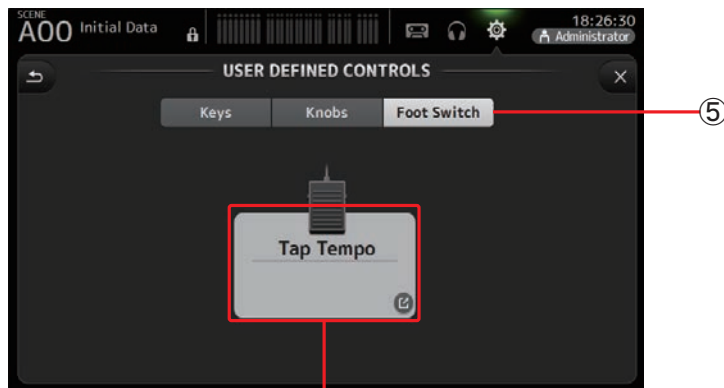

⑥ Foot Switch setup button

⑥ Foot Switch setup button

Displays the features that can be assigned to the footswitch.

FUNCTION	PARAMETER1	PARAMETER2	Description
Recorder	Transport	Play/Pause	Same as the Play/Pause button on the RECORDER screen.
		Stop	Same as the Stop button on the RECORDER screen.
		Next	Same as the Next button on the RECORDER screen.
		Previous	Same as the Previous button on the RECORDER screen.
		Rec	Same as the Rec button on the RECORDER screen.
		Auto Rec	Recording stops and the file is saved, and then recording resumes immediately as a new file.
		Rec & Start	Recording starts immediately without entering record-ready mode.
SCENE	Inc		Same as the INC, DEC, STORE, and RECALL keys.
	Dec		
	Store		
	Recall		
	Inc Recall		Recalls the next numbered Scene.
	Dec Recall		Recalls the previous numbered Scene.
	Direct Recall/Store	A00–99, B00–99	Recalls the Scene number assigned to PARAMETER 2. Press and hold for more than two seconds to assign the current settings to that Scene number.
TAP TEMPO			Same as the TAP key on the top panel.

Feature assignment screen

When you select a Function, the items available for Parameter 1 are displayed. Likewise, when you select an item for Parameter 1, the items available for Parameter 2 are displayed. Some Functions may not have items available for Parameter 1; some Parameter 1 items may not have items available for Parameter 2.

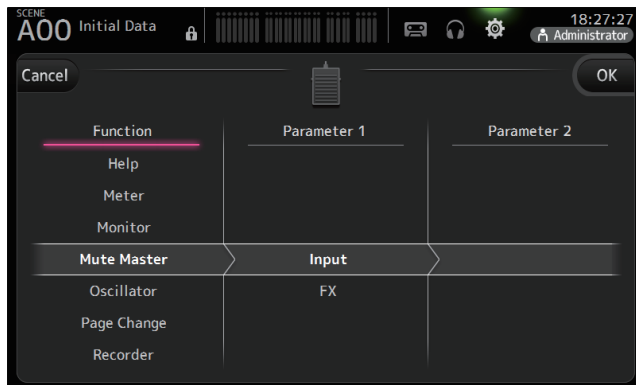

Assigning a feature to a [USER DEFINED KEY]

1. Touch the Keys button.



The screen where you can select the desired [USER DEFINED KEY] is displayed.

Buttons A–F correspond to [USER DEFINED KEYS] A–F.

2. Touch the Key button that corresponds to the [USER DEFINED KEY] that you want to configure.

The configuration screen is displayed.

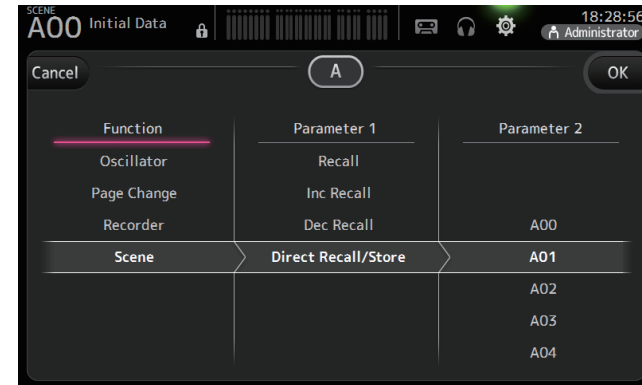

3. Scroll through the Function list and select the desired feature.

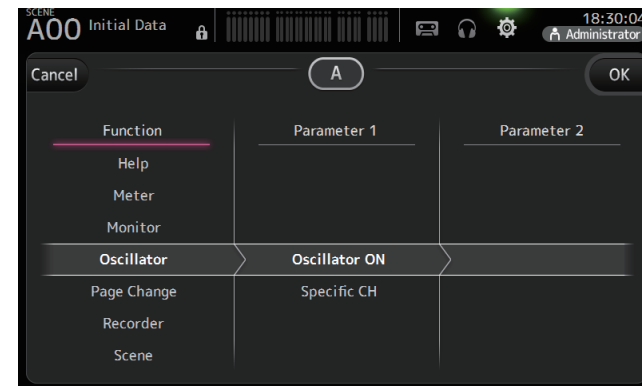

4. Scroll through the Parameter 1 list and select the desired item.

If items are available in the Parameter 2 list, select the desired item.

5. Touch the OK button.

Assigning a feature to a [USER DEFINED KNOB]

1. Touch the Knobs button.

The screen where you can select the desired [USER DEFINED KNOB] is displayed.



Buttons A–D correspond to [USER DEFINED KNOBS] A–D.

2. Touch the Knob button that corresponds to the [USER DEFINED KNOB] that you want to configure.

The configuration screen is displayed.

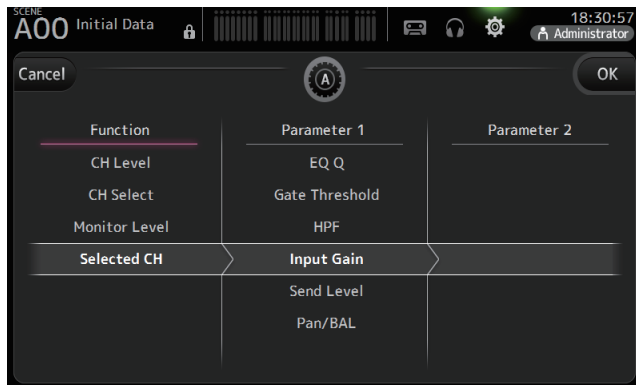

3. Scroll through the Function list and select the desired feature.

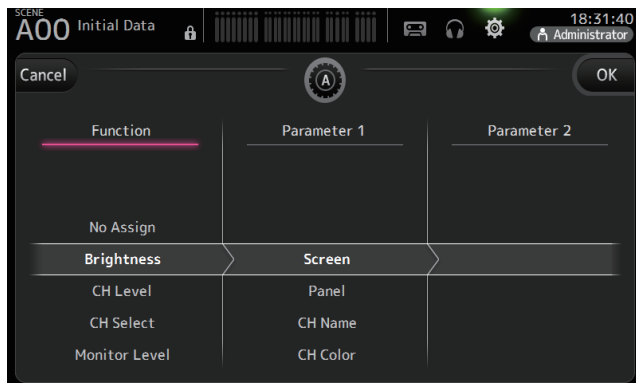

4. Scroll through the Parameter 1 list and select the desired item.

If items are available in the Parameter 2 list, select the desired item.

5. Touch the OK button.

Assigning a feature to the footswitch

1. Touch the Foot Switch button.



2. Touch the Foot Switch setup button.

The configuration screen is displayed.

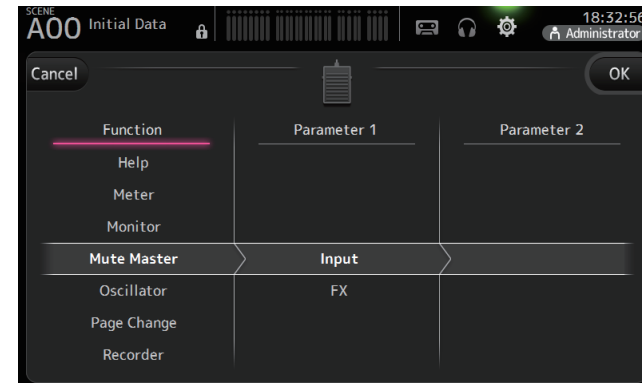

3. Scroll through the Function list and select the desired feature.

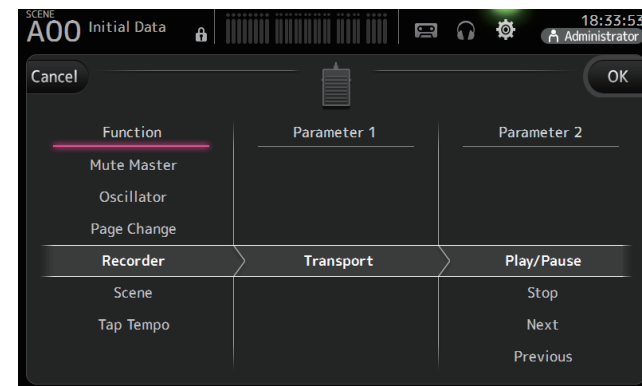

4. Scroll through the Parameter 1 list and select the desired item.

If items are available in the Parameter 2 list, select the desired item.

5. Touch the OK button.

CUSTOM FADER BANK screen

The custom fader bank allows you to choose different channels, regardless of type (input channels, AUX buses, MATRIX (V2.5 and later), DCA groups, etc.), and group them into a bank of faders.

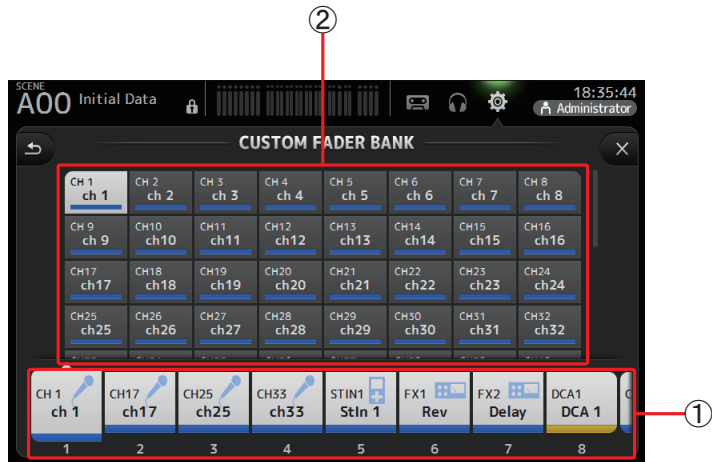

- ① **Fader buttons**
Allow you to select which fader will be configured.
- ② **Channel buttons**
Determines which channel will be assigned to the fader you selected for ①. If you select None, nothing will be assigning to the corresponding fader.

Configuring the custom fader bank

1. Touch a fader button to select the fader that you want to configure.

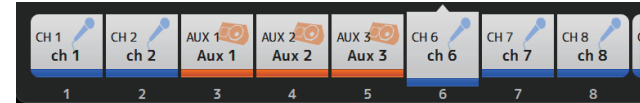

2. Touch the desired the channel button according to which channel you want to assign to the fader you selected in step 1.

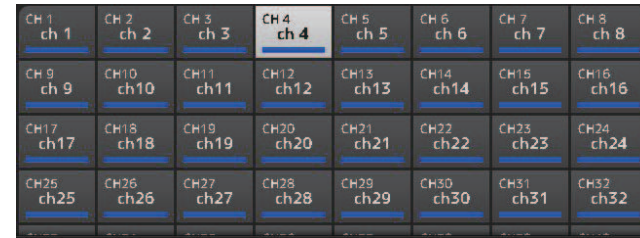

3. Repeats steps 1–2 and configure other faders as desired.

CUSTOM FADER BANK screen menu

Touch the Menu key (☰) from the CUSTOM FADER BANK screen to display the following items.

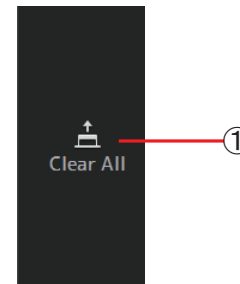

- ① **Clear All**
Clears all assignments for each fader bank (all will be set to None).

Recalling the CUSTOM FADER BANK (TF5/TF3/TF1)

1. Press the [INPUT2] and [OUTPUT] keys on the top panel at the same time.

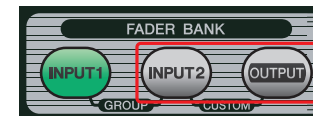

BRIGHTNESS screen

Allows you to adjust the brightness of the touchscreen, as well as the LEDs, name display, and channel colors on the top panel. You can save brightness settings into BANK A and BANK B, allowing you to recall the desired brightness settings to suit your work conditions.

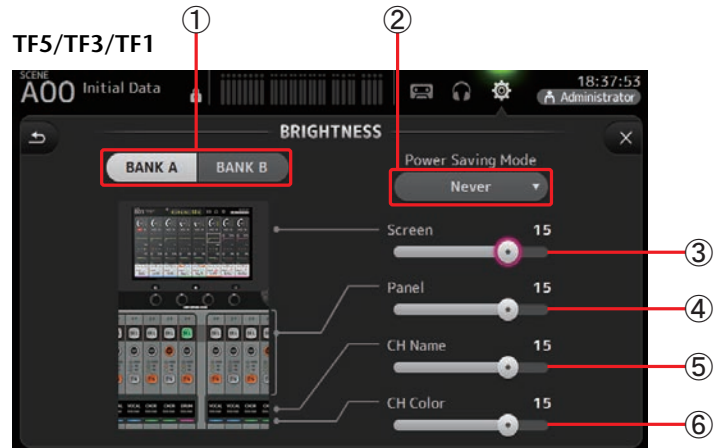

1 Bank selection buttons

Allow you to switch between BANK A and BANK B.

BANK A: Selects BANK A brightness settings.

BANK B: Selects BANK B brightness settings.

For V1.1 and later, you can switch between the banks using [USER DEFINED KEYS] or a footswitch.

2 Power Saving Mode button

Allows you to set the amount of time that passes before console switches to power saving mode.

You can choose 30 seconds, 2 minutes, 5 minutes, 10 minutes, 15 minutes, or never.

3 Screen brightness slider

Adjusts the brightness of the touchscreen.

4 Panel brightness slider

Adjusts the brightness of the LEDs on the top panel.

1–10: In low lighting conditions, an auxiliary light lights, which makes the key top easier to read.

11–20: In bright lighting conditions, an auxiliary light does not light, which helps emphasize contrast.

5 CH Name brightness slider (TF5/TF3/TF1)

Adjusts the brightness of the channel names displayed on the top panel.

6 CH Color brightness slider (TF5/TF3/TF1)

Adjusts the brightness of the channel colors on the top panel.

NETWORK screen

Allows you to configure the console's network address, which is needed when you connect a computer to the NETWORK connector.

Configure these settings according to the connected computer or network.

NOTE

When connecting the console to a LAN, refer to the TF Editor Installation Guide.

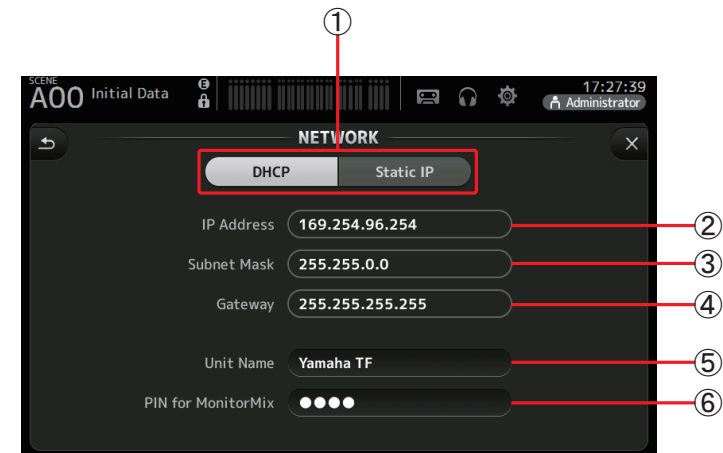

① **IP address provisioning method button**

Select the setting that matches how the console will configure its IP address.

DHCP: The console receives its IP address automatically.

Static IP: The console's IP address is set manually.

② **IP Address**

Determines the unique address that identifies the console on the network.

③ **Subnet Mask**

Defines how many bits are used for network addresses on the connected network.

④ **Gateway**

The address of the network device (gateway) that facilitates communication between different devices on the network.

⑤ **Unit Name**

Allows you to specify a name that can be used to identify the console on the network.

⑥ **PIN for MonitorMix (V1.1 and later)**

This is a 4-digit password that is required when accessing the console using the MonitorMix app.

MonitorMix is an application that allows performers to adjust the levels of the monitor mix directly from the stage.

NOTE

When the DHCP button is selected, items ②–④ are not needed.

②–④ are only needed when you select the Static IP button. Configure these parameters as needed.

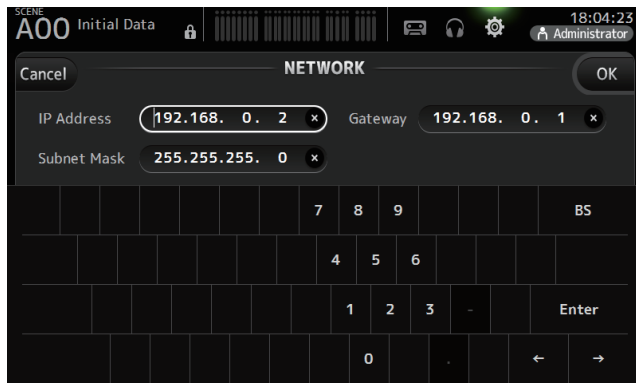

TIME screen

Allows you to set the console's internal clock and change the date and time format. The date and time set here are used as a timestamp when saving Scenes.

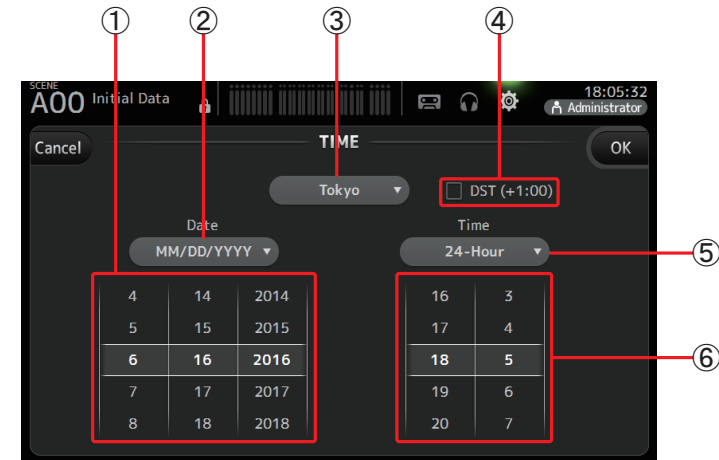

① **Date setting**

Determines the console's date setting.

② **Date format setting**

Allows you to select the date format.

The following formats are available.

MM/DD/YYYY

DD/MM/YYYY

YYYY/MM/DD

③ **Region**

Allows you to change the region.

④ **DST (+1:00)**

Enables daylight saving time.

When turned on, the current time advances by one hour.

⑤ **Time format setting**

Allows you to select the time format.

24-Hour

12-Hour (uses AM and PM)

⑥ **Time setting**

Determines the console's time setting.

LOG screen

When messages are displayed while using the console, they are logged by date and time and can be viewed later on this screen.

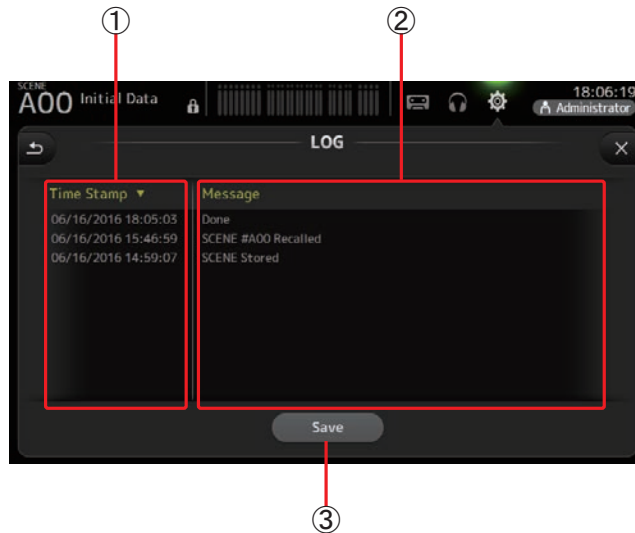

① **Time Stamp field**

Displays the date and time of each message.
You can touch the header to sort messages by date and time.

② **Message field**

Displays messages.
You can touch the header to sort messages alphabetically by message.

③ **Save button**

Allows you to save the log to a USB storage device.
This button is not available when no USB storage device is connected.

HELP screen

Displays information about console operations. If "Show Help at Startup" is turned on in the PREFERENCE screen, the HELP screen is displayed automatically after the console starts up.

You can swipe left and right to view different pages.

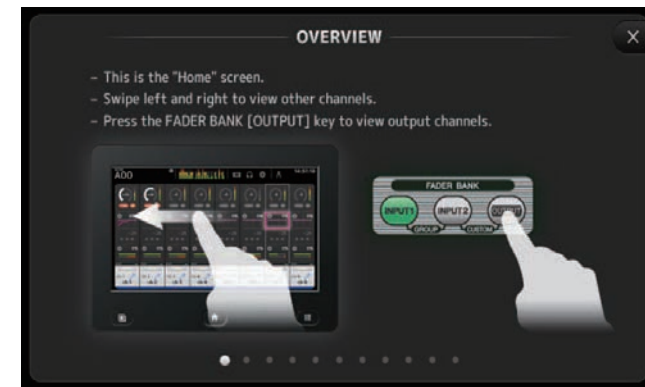

ABOUT screen

Displays system software version information and license information.



① Version button

Displays the console's system software version number.
(V2.0 and later) Displays the Dante version of the connected NY64-D, if installed.

② License button

Displays system software license information.

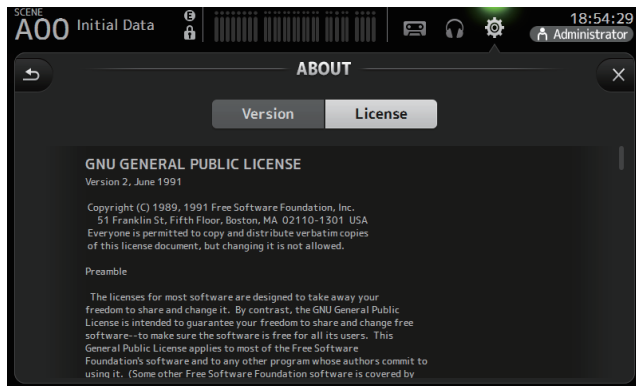

LOGIN screen (V3.0 and later)

Allows you to assign permissions for accessing the TF series console.

By limiting which parameters can be operated by different users, you can prevent improper operation and specify what guest engineers can and cannot do when operating the console.

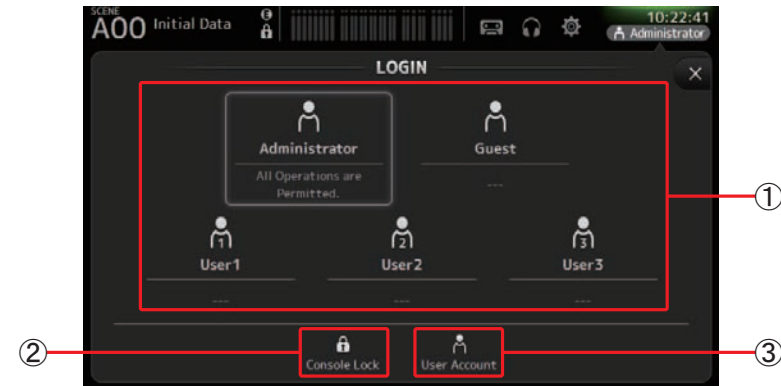

① User icons

Display the icon, name, and comments for each user.
When you touch an item, the console prompts you to enter the password for the corresponding user.
If there is no password assigned to a user, you can log in by simply touching the user's icon.

Administrator

Can use all features. Only one administrator can be configured for the console. The administrator is the only user that can set the access permissions of other users. If another user has locked the console, the administrator can release the console lock. The only setting that must be set for the administrator is the password.

Guest

Can use features according to the access permissions set by the administrator. Only one guest can be configured for the console. Access permissions and comments can be assigned to the guest.

User

Can use features according to the access permissions set by the administrator. Three users can be configured for the console. A user name, password, access permissions, and comments can be assigned to each user.

NOTE

- There is no password saved for the administrator in the factory default settings. (All users have full access.)
In order to set permissions for other users, you must first set a password for the administrator.
- If a user with a password assigned is logged in to the console when the console is turned off, the console will prompt the user to enter that password when the console is turned on the next time. If another user wants to log in, press the cancel button when prompted to enter the password, and then select the desired user in the LOGIN screen.

② **Console lock icon**

Prompts you to enter the password for the current user.
If the correct password is entered, the CONSOLE LOCK screen is displayed. (→page 41)

③ **User account icon**

Displays the USER ACCOUNT screen.

USER ACCOUNT screen (V3.0 or later)

Allows the administrator to set the access permissions for the other users.

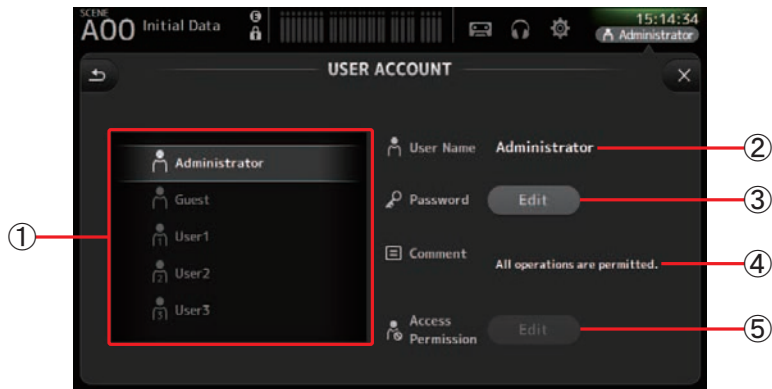

① **User selection area**

Allows you to select which user's settings you will configure.
Information about the selected user is displayed on the right side of the screen.

② **User Name text box**

Displays the keyboard screen so that you can edit the user name.
You cannot edit the user name of the administrator and guest accounts.

③ **Password Edit button**

Displays the keyboard screen so that you can edit the password.

When setting a password for the first time, enter the desired password in the New Password text box, and then enter the password again in the Verify text box. When changing a password, enter the current password in the Old Password text box, and then set the new password.

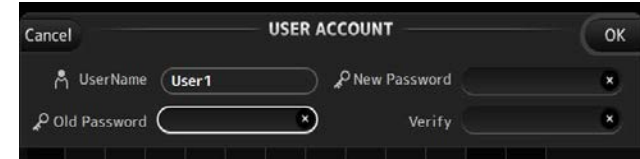

④ **Comment text box**

Displays the keyboard screen so that you can enter a comment.

⑤ **Access Permission Edit button**

Displays the ACCESS PERMISSION screen.
When logged in as the administrator, you can set the access permissions of the selected user for each parameter.

ACCESS PERMISSION screen (V3.0 and later)

Allows you to select which parameters can be used and not used by each user.
This screen is only displayed when logged in as the administrator.

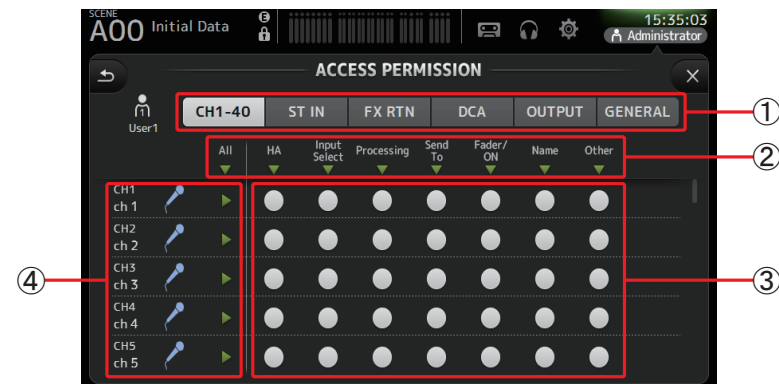

① **Selection buttons**

Allows you to select a channel to assign access permission to.
According to which button you have selected, the different parameters that can be assigned access permissions are displayed.
You can set access permissions for operations that are not associated with channels, such as the SETUP screen or the SCENE screen, by touching the GENERAL button.

② **Parameter names**

Touch the ▼ button to allow/restrict access to the parameters for all channels of the same type. The ▼ button turns green when access is allowed for all channels. If access is allowed for only some channels, it is displayed in blue, and if access is restricted for all channels, it is displayed in gray.

③ **Access permission on/off buttons**

Allow (on) and restrict (off) access to the corresponding parameters. The selected user can only use the parameters that are allowed here. For details about each parameter, refer to the parameter list. (→page 84)

④ **Channel information**

Displays the channel ID, name, and icon. Touch the ► button to allow/restrict access to the parameters for the corresponding channel. The ► button turns green when access is allowed for all parameters. If access is allowed for only some parameters, it is displayed in blue, and if access is restricted for all parameters, it is displayed in gray.

ACCESS PERMISSION screen menu

Press the Menu key (☰) from the ACCESS PERMISSION screen to display the following options.

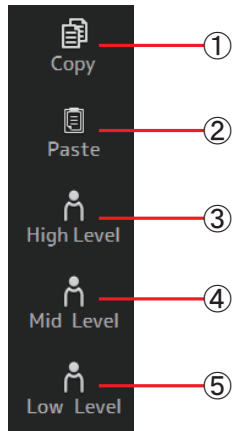

- ① **Copy**
Copies the ACCESS PERMISSION settings of the selected user to the clipboard.
- ② **Paste**
Pastes the ACCESS PERMISSION settings in the clipboard to the selected user.
- ③ **High Level**
- ④ **Mid Level**
- ⑤ **Low Level**
Applies ACCESS PERMISSION settings to the selected user based on their proficiency.
High Level: For advanced users. Only network and clock settings are restricted. All other parameters are allowed.
Mid Level: For moderately proficient users. System settings are restricted. All other parameters, such as channel operations, are allowed.
Low Level: For beginners. Most parameters are restricted. Channel on/off and fader level adjustments are allowed.

Applying access permissions

1. From the LOGIN screen, log in as the administrator.
2. From the LOGIN screen, touch the User Account icon to display the USER ACCOUNT screen.
3. Select the desired user, then set the user name, password, and comments.
4. Touch the Access Permission Edit button to display the ACCESS PERMISSION screen.
5. Restrict (turn off) the parameters that you do not want the user to access.
6. To confirm whether the access permissions were set as desired, return to the LOGIN screen and log in as the user you set access permissions for.
7. Operate a parameter that you restricted. "Permission Denied!" is displayed if the parameter is restricted.

Resetting user settings

If the console is reset, all user passwords are deleted and all restrictions are released. (→page 79)

Loading user settings to other TF series consoles

1. From the SAVE/LOAD screen, save the console's internal settings.
2. Log in as the administrator using the console to which you want load the user settings.
3. From the SAVE/LOAD screen, select the settings file you saved in step 1 and touch the Load button.
4. From the LOAD SELECT screen, select user accounts on the CUSTOM tab and touch the Load button.

CONSOLE LOCK screen

You can lock the console to prevent it from being operated accidentally.

While the CONSOLE LOCK screen is displayed, controls are disabled and the console cannot be operated.

To unlock the console, touch and hold the CONSOLE LOCK screen. If you are prompted to enter a password, enter the password of the current user or the administrator.

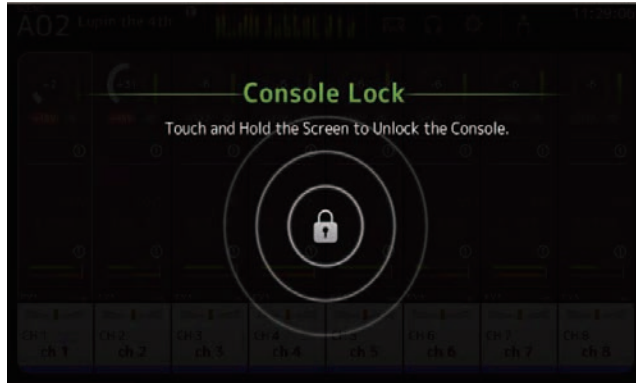

Displays information about the channel strips.

You can display the OVERVIEW screen by pressing the Home key (🏠).

For the TF5/TF3/TF1, the CH STRIP section is displayed as the home screen; for the TF-RACK, the FADER section is displayed. Additionally, for the TF-RACK, you can switch between the CH STRIP section and FADER section by pressing the Home key.

NOTE

For the TF5/TF3/TF1, the FADER section is displayed on the OVERVIEW screen when SETUP→PREFERENCE→Other→[HOME] key is set to "Both". In this case, you can switch between the CH STRIP section and FADER section by pressing the Home key while the OVERVIEW screen is displayed.

CH STRIP section

Input channels



- ① Displays the INPUT screen. (→page 47)
- ② Displays the EQ screen. (→page 49)
- ③ Displays the GATE screen. (→page 53)

- ④ Displays the COMP screen. (→page 55)
- ⑤ Displays the FX1 screen. (→page 57)
- ⑥ Displays the FX2 screen. (→page 57)
- ⑦ Displays the SEND TO AUX screen. (→page 62)
- ⑧ Displays the ASSIGN screen. (→page 63)
- ⑨ Displays the CH VIEW screen. (→page 64)

Stereo channels

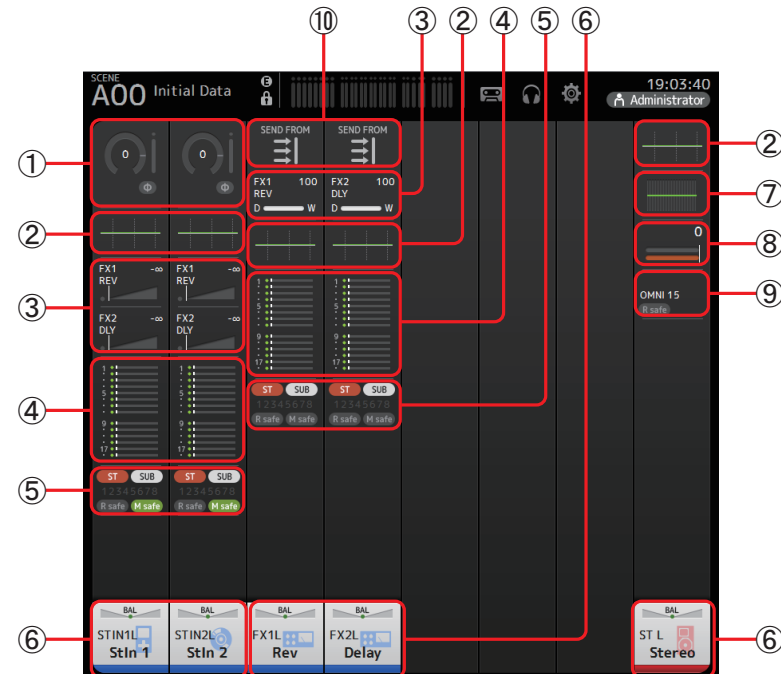

- ① Displays the INPUT screen. (→page 47)
- ② Displays the EQ screen. (→page 49)
- ③ Displays the FX1/FX2 screen. (→page 57)
- ④ Displays the SEND TO AUX screen. (→page 62)
- ⑤ Displays the ASSIGN screen. (→page 63)
- ⑥ Displays the CH VIEW screen. (→page 64)
- ⑦ Displays the GEQ screen. (→page 72)
- ⑧ Displays the COMP screen. (→page 55)

- ⑨ Displays the OUTPUT screen. (→page 74)
- ⑩ Displays the SEND FROM screen (→page 75) (V3.0 and later)

AUX1–AUX8 channels

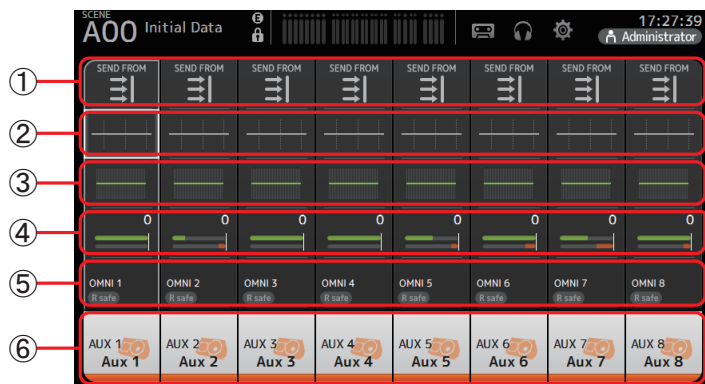

- ① Displays the SEND FROM screen. (→page 75)
- ② Displays the EQ screen. (→page 49)
- ③ Displays the GEQ screen. (→page 72)
- ④ Displays the COMP screen. (→page 55)
- ⑤ Displays the OUTPUT screen. (→page 74)
- ⑥ Displays the CH VIEW screen. (→page 64)

AUX9/10–19/20 channels, SUB channel

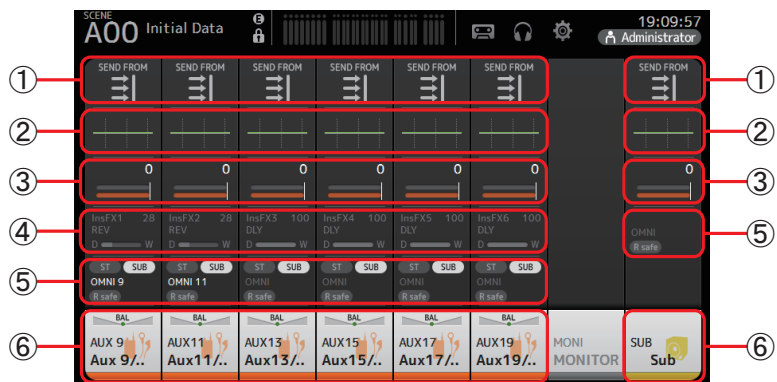

- ① Displays the SEND FROM screen. (→page 75)
- ② Displays the EQ screen. (→page 49)
- ③ Displays the GEQ screen. (→page 72)
- ④ Displays the COMP screen. (→page 55)
- ⑤ Displays the OUTPUT screen. (→page 74)
- ⑥ Displays the CH VIEW screen. (→page 64)

MATRIX1–4 channels (V2.5 and later)

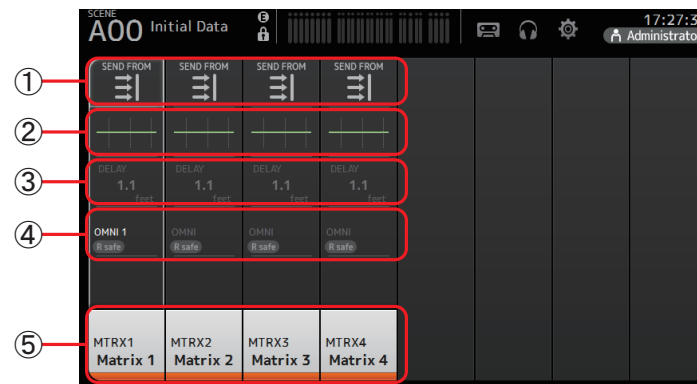

- ① Displays the SEND FROM screen. (→page 75)
- ② Displays the EQ screen. (→page 49)
- ③ Displays the DELAY screen. (→page 78)
- ④ Displays the OUTPUT screen. (→page 74)
- ⑤ Displays the CH VIEW screen. (→page 64)

NOTE

- MATRIX channels 1–4 are in the OUTPUT FADER BANK. To use the faders on the top panel to control these channels, press the [OUTPUT] key in the FADER BANK section, and then display the OUTPUT BANK in the channel strip.
- For TF1, MATRIX channels 1–4 are not controlled by the faders, and are displayed only. Scroll the displayed area to the right. To control these channels using the faders, register them to the CUSTOM FADER BANK.

Group channels

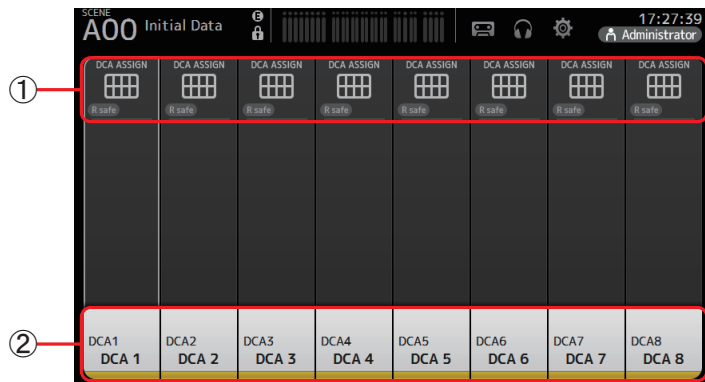

- ① Displays the DCA ASSIGN screen. (→page 76)
- ② Displays the CH VIEW screen. (→page 64)

FADER section

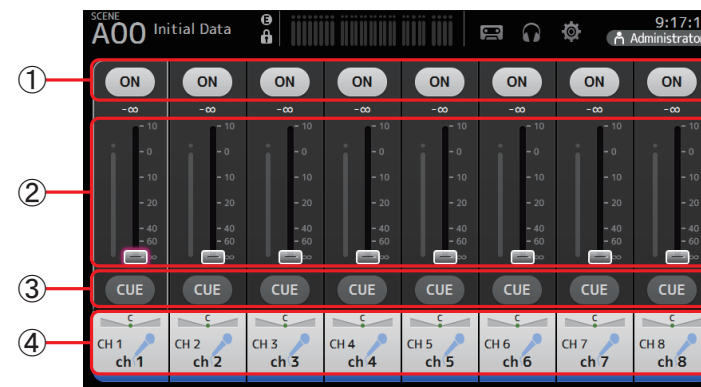

- ① **ON button**
Turns the channel on and off.
- ② **Fader**
Adjusts the channel's fader level.
- ③ **CUE button**
Turns the cue on and off for the assigned channel.
- ④ Displays the CH VIEW screen. (→page 64)

OVERVIEW screen operations

When you touch an item on the screen, a pink box is displayed around the item to highlight it. When an item is highlighted, you can adjust it using the [TOUCH AND TURN] knob. If you touch a highlighted item, its configuration screen is displayed. You can drag or swipe up, down, left, and right to display other areas of the screen.

OVERVIEW screen menu

Press the Menu key () from the OVERVIEW screen to display the following items.

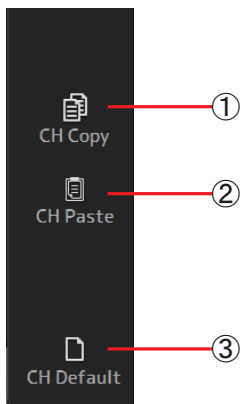

- ① **CH Copy**
Copies the settings of the current channel.
- ② **CH Paste**
Pastes settings from another channel and applies them to the current channel.
- ③ **CH Default**
Resets the settings of the current channel to their default values.

Copying settings from one channel and applying them to another channel

1. Select the channel whose settings you want to copy.

Copy settings from this channel



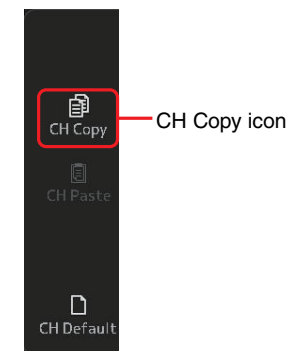

2. Press the Menu key ().
Displays the menu.
3. Touch the CH Copy icon.
The settings are copied and the menu closes.

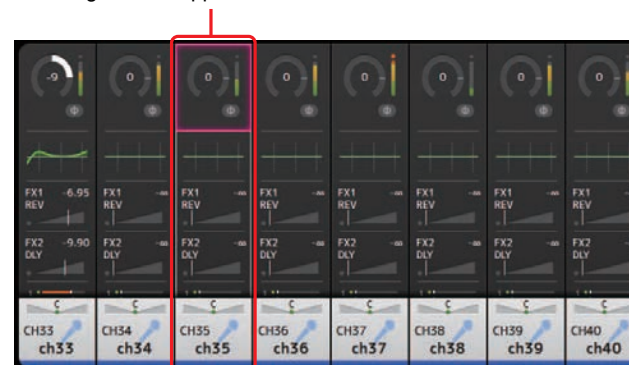

4. Select the channel that you want to apply the settings to.

Settings will be applied to this channel



5. Press the Menu key ().
Displays the menu.
6. Touch the CH Paste icon.

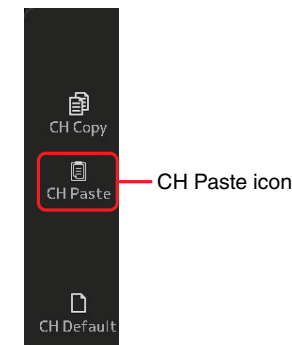

The settings from the first channel you selected are applied to the second channel you selected, and then the menu closes.

Paste completed



INPUT screen

Allows you to change the stereo link setting, select an input source, turn phantom power on and off, turn phasing on and off, and adjust input gain.

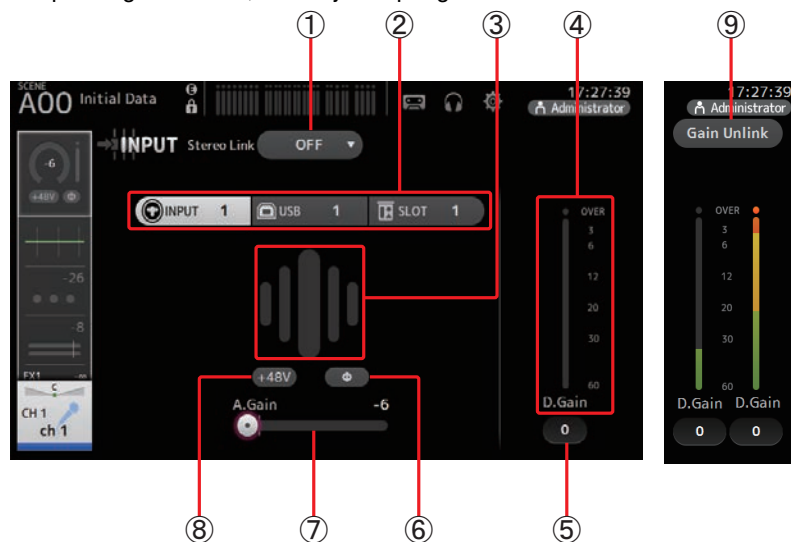

① Stereo link selection button

Allows you to select whether two adjacent mono input channels are linked as a stereo pair, or behave as two separate mono channels. Touch to display the popup menu.

OFF: Stereo link is disabled.

CH1&2: Stereo link is enabled. When stereo link is enabled, the odd numbered channel is the left side of the stereo pair, and the even numbered one is the right. The channel numbers displayed in the popup menu depend on the channel whose settings you are editing.

CH2&3: Stereo link is enabled. When stereo link is enabled, the even numbered channel is the left side of the stereo pair, and the odd numbered one is the right. The channel numbers displayed in the popup menu depend on the channel whose settings you are editing.

② Input selection buttons

Allows you to select the channel's input source. The available sources depend on the channel whose settings you are editing.

INPUT: The device connected to the INPUT jack will be used as the input source.

USB: The computer connected to the USB TO HOST connector will be used as the input source.

SLOT (V2.0 and later): Allows you to select an input from the NY64-D installed in the expansion slot. Use this button when selecting an input from a Tio1608-D or stage box connected to the NY64-D and the Dante network. See [page 92](#) for information about SLOT port numbers and channels.

Playback: Displayed for ST IN1. Allows you to select a USB storage device that is connected to the USB connector on the top panel as an input.

NOTE

When USB is selected, the gain slider (⑦) adjusts digital gain, and the +48V button (⑧) is not displayed. When SLOT is selected, analog gain adjustment and the +48V button cannot be used if the HA Control button on the SLOT SETUP screen is not turned on. Additionally, for inputs from a device whose head amp cannot be controlled, the gain slider (⑦) becomes a digital gain adjustment, and the +48V button (⑧) is not displayed.

Even if you select SLOT as the input source, if a source is not actually available (such as when there is no NY64-D installed, no Tio1608-D or stage box connected, no Dante patching, etc.), this "virtual HA" state is displayed in the HA box area of this screen, the OVERVIEW screen, and the CH VIEW screen.

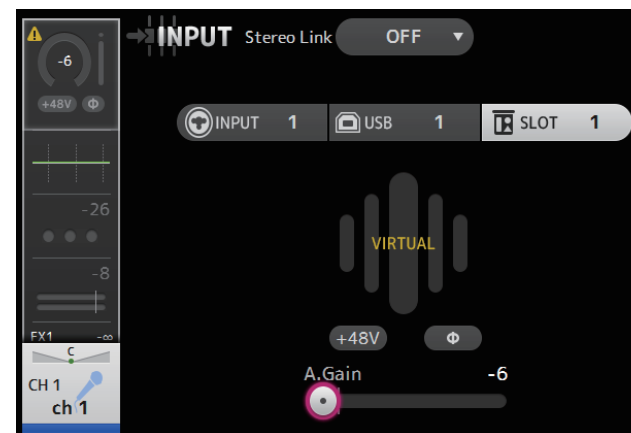

③ GainFinder

Displays the input's gain adjusted level. When adjusting the input gain, adjust it so that the center of the GainFinder lights up. When the input source is set to INPUT, the GainFinder displays the digital input's gain.

④ **Level meter**

Displays the gain adjusted level.

⑤ **Digital gain text box**

Allows you to adjust the digital gain. It is set to 0 dB by default. You can touch the text box to highlight it, then use the [TOUCH AND TURN] knob to adjust the setting. You can also touch the text box again to adjust the setting using the keyboard screen.

⑥ **Φ (phase) button**

Allows you to reverse the phase.
When turned on, the input signal's phase is reversed.

⑦ **Gain slider**

When the INPUT button is selected, the slider adjusts the analog gain of the head amp. The PAD (-24 dB) will be switched on or off when the analog gain is adjusted between +17 dB and +18 dB.

When the USB button is selected, the slider adjusts digital gain.

⑧ **+48V button**

Turns phantom power (+48 V) to the head amp on and off.

On: Phantom power is turned on.

Off: Phantom power is turned off.

When the USB button is selected, the +48V button is not displayed.

NOTICE

Information about phantom power

When phantom power is not needed, set the +48V button to the off position. Observe the following when using phantom power to prevent damage to the console or connected devices, and signal noise.

- Do not set the +48V button to the on position when the device connected to the input jack does not require phantom power.
- Do not connect or disconnect cables when the +48V button is set to the on position.
- Before turning phantom power on or off for a channel, first set the channel's volume to the minimum level.

NOTE

When using phantom power, noise may be generated if there is a difference in the impedance between the hot and cold of the device connected to an input jack.

⑨ **Gain Unlink button (V1.1 and later)**

Displayed for stereo channels and for channels that have stereo link turned on.

While you are touching the button, gain for the left and right channels can temporarily be adjusted individually. When you release the button, the gain for both channels can be adjusted together but the difference in gain between the two channels is maintained.

Setting stereo link and the input source

1. Display the INPUT screen. (→page 5)
2. Touch the stereo link selection button that corresponds to the desired setting.



3. Touch the input selection button that corresponds to the desired setting.



4. Use the gain slider to adjust the head amp gain.

Adjust the gain slider so that the center of the GainFinder lights up.



Gain finder level display

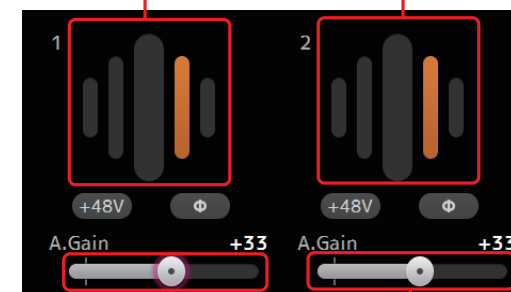

Gain slider

5. Touch the digital gain text box to highlight it, then use the [TOUCH AND TURN] knob to adjust the setting.



Digital gain text boxes

INPUT screen menu (V1.1 and later)

Touch the Menu key (☰) from the INPUT screen to display the following items.

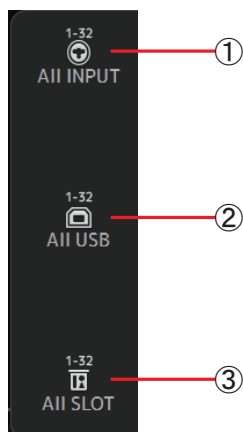

- ① **AII INPUT**
Allows you to assign the INPUT jacks as the input source for all input channels.
- ② **AII USB**
Allows you to assign the USB TO HOST connector as the input source for all input channels.
- ③ **AII SLOT (V2.0 and later)**
Switches all inputs to input sources of Dante network devices that are connected to the NY64-D installed in the expansion slot.

The input source for the following channels will be changed.

TF5:

CH 1–32 (when CH 1–32 are selected)
CH 33–40 (when CH 33–40 are selected)

TF3:

CH 1–24 (when CH 1–24 are selected)
CH 25–32 (when CH 25–32 are selected)
CH 33–40 (when CH 33–40 are selected)

TF1/TF-RACK:

CH 1–16 (when CH 1–16 are selected)
CH 17–32 (when CH 17–32 are selected)

EQ screen

Controls the EQ for each channel. 4-band parametric EQ is available for CH 1–32, AUX 1–20, STEREO and MATRIX1-4; 2-band parametric EQ is available for CH 33–40, ST IN 1, ST IN 2, FX1, FX2, and SUB. You can adjust settings using 1-knob mode, which allows you to use the [TOUCH AND TURN] knob to easily adjust settings, or manual mode, which allows you to adjust each parameter individually.

4-band parametric EQ

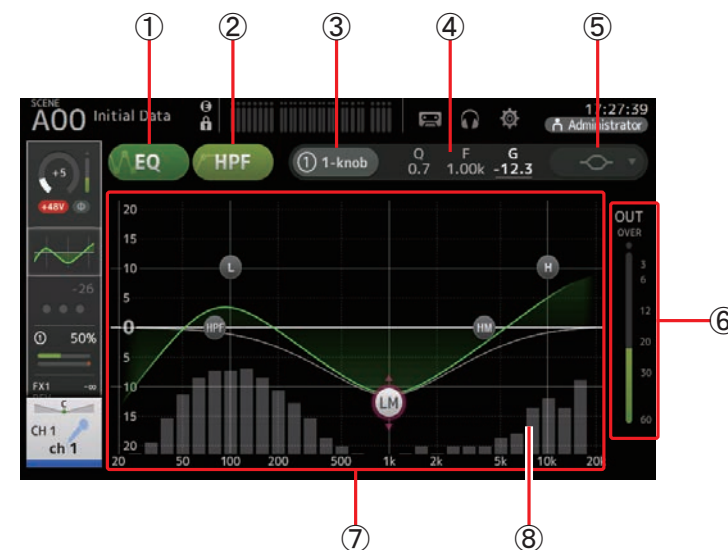

- ① **EQ button**
Turns the EQ on and off.
- ② **HPF button**
Turns the HPF (high-pass filter) on and off.
Displayed for CH 1–40.
- ③ **1-knob button**
Switches between 1-knob EQ mode and manual mode.
When using 1-knob EQ mode, the 1-knob level slider is displayed.
- ④ **1-knob level slider**
Adjusts the intensity of 1-knob EQ.
When using manual mode, information about the selected band's Q, F, and G is displayed here.

⑤ **EQ mode type selection button**

When using 1-knob EQ mode, allows you to select the 1-knob EQ mode type. Select [Vocal] for vocal channels, otherwise select [Intensity].
 When set to [Intensity], you can adjust the EQ to a setting between flat and double the intensity of the EQ settings you made using manual mode.
 For output channels, [Loudness] is available. This setting allows you to boost low and high tones.
 The available types depend on the channel whose settings you are editing.

Type	Channel								
	CH1-32 HPF + 4-band	CH33-40 HPF + 2-band	ST IN 2-band	FX 2-band	STEREO 4-band	AUX1-8 4-band	AUX9/10- AUX19/20 4-band	MATRIX 1-4 4-band	SUB 2-band + LPF
Intensity	○	○	○	○	○	○	○	○	×
Vocal	○	×	×	×	×	×	×	×	×
Loudness	×	×	×	×	○	○	○	○	×

In manual mode, this button switches the filter type. Low-band and high-band filter are available.
 For CH 1-40, the available low-band filters are low-shelving type and bell type.
 For other channels (i.e., for channels that do not have an HPF), the available low-band filters are HPF, low-shelving type, and bell type.
 The available high-band filters are LPF, high-shelving type, and bell type.

⑥ **EQ output level meter**

Displays the post-EQ level.

⑦ **EQ graph**

Displays the parameter settings of the EQ and filter. As you adjust the settings of each band, the results are reflected in the graph.
 When using 1-knob EQ mode, you can touch the level slider and then adjust the slider using the slider itself or the [TOUCH AND TURN] knob.
 When using manual mode, you can drag the handles displayed in the graph to adjust the corresponding settings.
 When HPF is turned on, you can drag the HPF handle to adjust the cutoff frequency. You can also adjust HPF independently when using the Intensity type for 1-knob EQ mode.



How does 1-knob EQ mode work?

1-knob EQ mode allows you to adjust several parameters at once with just the turn of a knob. It makes EQ adjustment quick and easy.
 The console contains Presets that are configured for a variety of instruments. You can use 1-knob EQ mode to adjust the EQ settings that are saved in Presets without disturbing the overall balance of your mix.
 You can even configure EQ settings using manual mode, then switch to 1-knob EQ mode and use the Intensity type to adjust the amount of EQ applied to the channel. In this case you can use the [TOUCH AND TURN] knob to adjust from 0% (no EQ applied) to 50% (the EQ settings you made using manual mode) and 100% (double the intensity of the EQ settings you made using manual mode). This makes it very easy to fine-tune your EQ settings with just one knob.
 If 1-knob EQ mode type is set to Vocal or Loudness, you can adjust the EQ between 0% (no EQ applied) and 100% (maximum EQ applied).

⑧ RTA/Keyboard display

You can touch the bottom of the graph where no parameters are displayed to display RTA or a keyboard. RTA is a graph that displays the frequencies of the input signal after the EQ is applied. The keyboard display is helpful for understanding the relationship between frequencies and musical pitches.



Adjusting EQ in manual mode

1. Display the EQ screen. (→page 5)
2. Touch the EQ button and turn on the EQ.
3. Touch the 1-knob button and turn 1-knob mode off.
4. Use the handles in the EQ graph to adjust the EQ as desired.

Drag to adjust

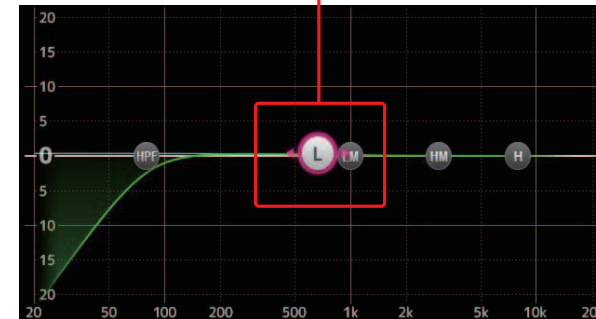

When you touch an EQ parameter to select it, you can then adjust it using the [TOUCH AND TURN] knob. You can press the [SHIFT] key to switch to a different parameter. Each time you press the [SHIFT] key, you can switch between gain (G) and frequency (F). You can also switch between G and F by touching the corresponding area to the right of the 1-knob button.

To adjust Q, pinch in or out on the touchscreen, or touch the Q area to the right of the 1-knob button and then use the [TOUCH AND TURN] knob to adjust the setting.

5. Turn HPF on as desired.

When using a vocal mic, you can reduce low-frequency noise (rumble noise, etc.) by turning on HPF.

Adjusting EQ in 1-knob EQ mode

1. Display the EQ screen. (→page 5)
2. Turn on the EQ and select 1-knob mode.
3. Select the desired 1-knob mode type.
4. Use the [TOUCH AND TURN] knob to adjust the EQ.

Setting HPF

1. Display the EQ screen. ([→page 5](#))
2. Touch the HPF button and turn on the HPF.
3. Touch the HPF handle.
4. Use the [TOUCH AND TURN] knob to adjust the HPF.

You can also drag the HPF handle in the EQ graph.



Drag to adjust

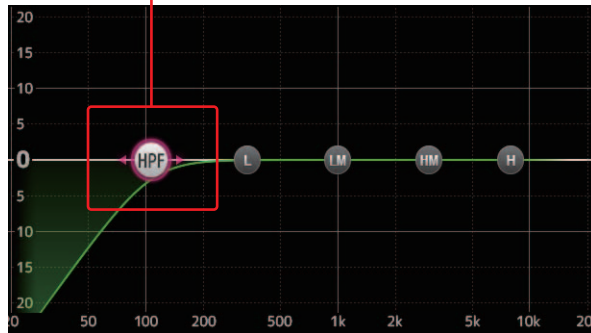

The value that corresponds to your adjustments is displayed in the upper right of the screen.

Adjusted value



Setting LPF

The SUB channel can use the LPF to cut high frequencies independent of the EQ, ideal for adjusting the signal sent to a sub-woofer.

1. Display the SUB channel's EQ screen. ([→page 5](#))
2. Touch the EQ button and turn on the EQ.



3. Use the LPF handle in the EQ graph to adjust the LPF as desired.

Drag to adjust

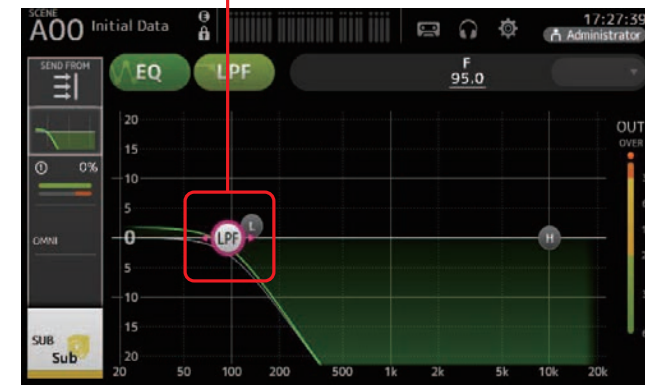

EQ screen menu

Press the Menu key () from the EQ screen to display the following options.

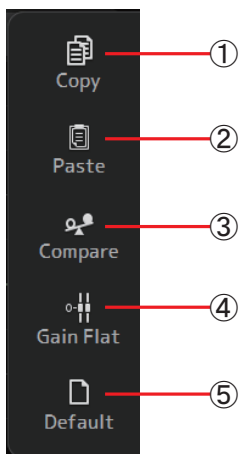

- ① **Copy**
Copies the EQ parameters of the selected channel to the clipboard.
- ② **Paste**
Pastes the EQ parameters in the clipboard to the selected channel.
- ③ **Compare**
Allows you to compare the EQ parameters of the selected channel with the EQ parameters in the clipboard by switching between the two.
- ④ **Gain Flat**
Sets the EQ gain for all bands to 0.
- ⑤ **Default**
Resets EQ settings to their default values.

GATE screen

Allows you to configure the noise gate for each channel. When the input signal level is lower than a specified amount (threshold), the output signal is reduced by a specified amount (range). GATE is available for CH 1–32.

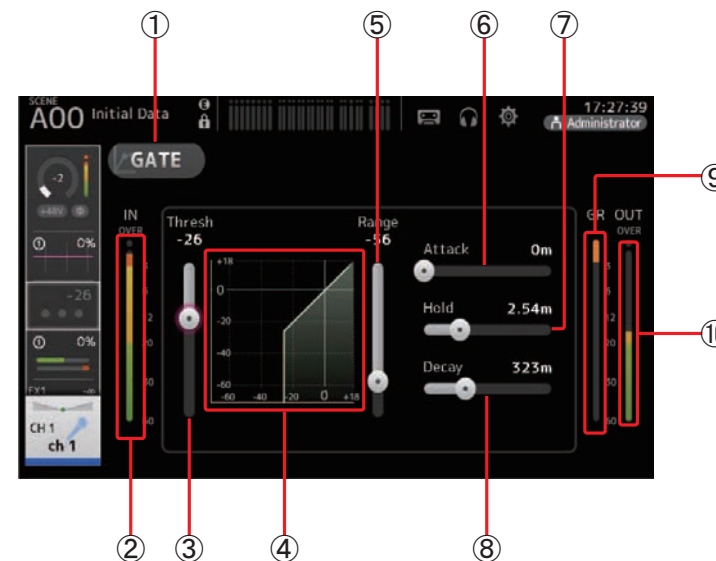

- ① **GATE button**
Turns the gate on and off.
- ② **Gate input level meter**
Displays the gate input level.
- ③ **Threshold slider**
Determines the level at which the gate is applied.
- ④ **Gate graph**
Displays a visual representation of the gate level.
- ⑤ **Range slider**
Determines the amount by which the signal will be lowered when the gate is applied.
- ⑥ **Attack slider**
When the input signal exceeds the threshold, this setting determines how quickly the gate opens.
- ⑦ **Hold slider**
Determines how long the gate remains open after the signal drops below the threshold.
- ⑧ **Decay slider**
Determines how long it takes for the gate to close after the signal drops below the threshold.
- ⑨ **Output level meter**
Displays the gate output level.
- ⑩ **Output level meter**
Displays the gate output level.

⑦ **Hold slider**

When the input signal drops below the threshold, this setting determines how much time passes before the gate closes.

⑧ **Decay slider**

After the hold time passes, this setting determines how quickly the gate closes. The value here is expressed as the time required for the level to change by 6 dB.

⑨ **GR (gain reduction) meter**

Displays the amount by which the signal's gain is reduced.

⑩ **OUT (gate output) meter**

Displays the gate output level.

Setting the gate

1. Display the GATE screen. (→page 5)
2. Turn on the gate and then touch the slider that you want to adjust.

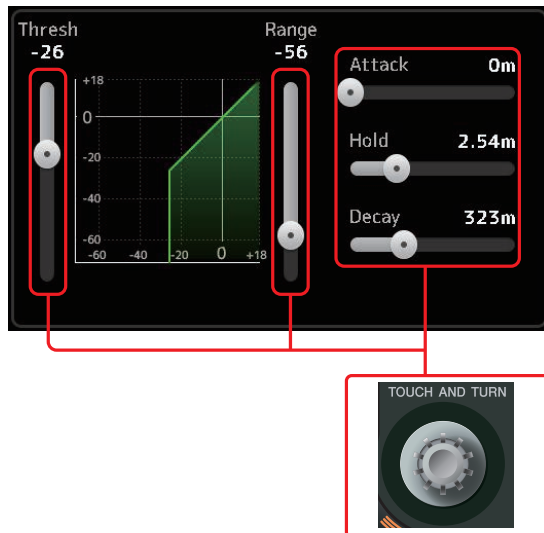

③. Use the [TOUCH AND TURN] knob to adjust the setting.

Refer to the gate graph and each meter while making adjustments.

You can also drag the slider on the touchscreen to adjust the setting.

GATE screen menu

Press the Menu key () from the GATE screen to display the following options.

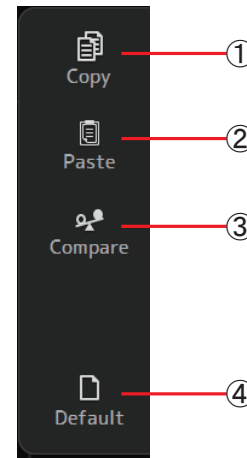
① **Copy**

Copies the GATE parameters of the selected channel to the clipboard.

② **Paste**

Pastes the GATE parameters in the clipboard to the selected channel.

③ **Compare**

Allows you to compare the GATE parameters of the selected channel with the GATE parameters in the clipboard by switching between the two.

④ **Default**

Resets the GATE settings for the current channel to their default values.

COMP screen

Allows you to configure the compressor for each channel. You can adjust settings using 1-knob mode, which allows you to use the [TOUCH AND TURN] knob to easily adjust settings, or manual mode, which allows you to adjust each parameter individually.

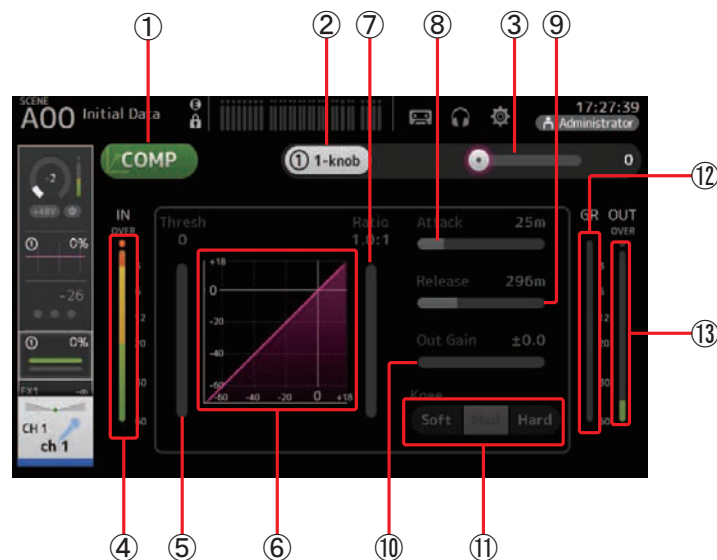

- ① **COMP button**
Turns the compressor on and off.
- ② **1-knob button**
Switches between 1-knob mode and manual mode.
- ③ **1-knob level slider (1-knob mode only)**
Adjusts the amount of 1-knob COMP applied.
Not displayed during manual mode.
- ④ **Compressor input level slider**
Displays the compressor output level.
- ⑤ **Threshold slider**
Determines the level at which compression is applied.
- ⑥ **Compressor graph**
Displays a visual representation of the current settings.
- ⑦ **Ratio slider**
Determines the amount of compression that is applied.

- ⑧ **Attack slider**
When the input signal exceeds the threshold, this setting determines how quickly the maximum amount of compression is applied.
- ⑨ **Release slider**
When the input signal drops below the threshold, this setting determines how much time passes before compression is no longer applied. The value here is expressed as the time required for the level to change by 6 dB.
- ⑩ **Out Gain slider**
Adjusts the output level.
- ⑪ **Knee button**
Determines how gradual or sudden the curve is at the threshold. A soft knee means that compression is applied gradually as the signal exceeds the threshold; a hard knee means a more sudden transition.
- ⑫ **GR (gain reduction) meter**
Displays the amount by which the signal's gain is reduced.
- ⑬ **OUT (compressor output) meter**
Displays the compressor output level.

How does 1-knob COMP mode work?

1-knob COMP mode allows you to adjust the amount of compression applied to the signal with just the turn of a knob.

By turning the [TOUCH AND TURN] knob to the right (or sliding the 1-knob level slider to the right), more compression is applied. In situations where raising the fader or gain could cause clipping at louder points in the signal, compression can deliver a more consistent sound.

1-knob COMP takes some of the worry out of compression by allowing you to adjust the balance between threshold, ratio, and out gain easily.

Setting the compressor

1. Display the COMP screen. (→page 5)
2. If the compressor is turned off, touch the COMP button to turn compression on.



3. Touch the 1-knob button and turn 1-knob COMP mode off.



4. Adjust the desired slider.

Drag the sliders to adjust each parameter.

When you touch an item, you can also use the [TOUCH AND TURN] knob to adjust the setting.

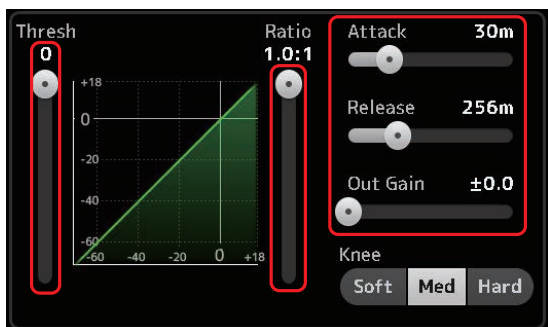

Adjusting the compressor in 1-knob COMP mode

1. Turn 1-knob COMP mode on.



2. Turn the [TOUCH AND TURN] knob.

Attack, Release, and Knee settings are fixed at their current settings, and the Threshold, Ratio, and Out Gain settings are adjusted automatically.

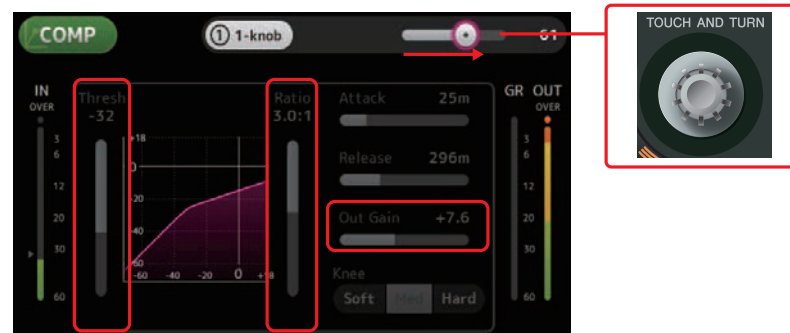

COMP screen menu

Press the Menu key (☰) from the COMP screen to display the following options.

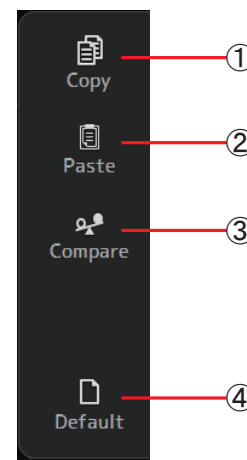

- ① **Copy**
Copies the COMP parameters of the selected channel to the clipboard.
- ② **Paste**
Pastes the COMP parameters in the clipboard to the selected channel.
- ③ **Compare**
Allows you to compare the COMP parameters of the selected channel with the COMP parameters in the clipboard by switching between the two.
- ④ **Default**
Resets the COMP settings for the current channel to their default values.

FX screen (FX1/2, InsFX1–6)

Allows you to select an effect and edit its parameters.

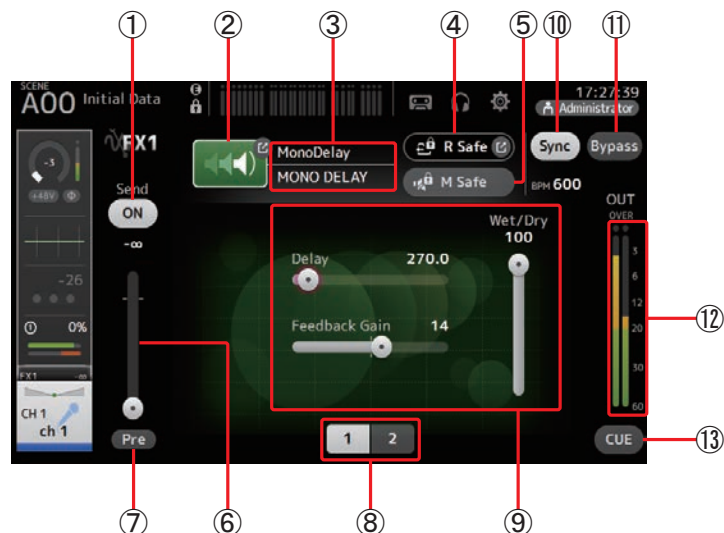

- ① **Send button**
Displayed for CH 1–40, ST IN 1 and ST IN 2.
Determines whether a signal is sent (on) or not sent (off) to the FX return channel.
- ② **EFFECT TYPE button**
Displays the EFFECT TYPE screen (→page 58), where you can select an effect type.
- ③ **Effect type and name**
Displays the type and name of the current effect.
- ④ **R safe (recall safe) indicator**
Displays the recall safe status of the effects module.
Displays the RECALL SAFE screen. (→page 25)
- ⑤ **M safe (mute safe) button**
Turns mute safe on and off for the effects module.
- ⑥ **FX send level slider**
Displayed for CH 1–40, ST IN 1 and ST IN 2.
Allows you to adjust the amount of signal that is sent to the effects module.

- ⑦ **Pre button**
Displayed for CH 1–40, ST IN 1 and ST IN 2.
Allows you to select whether the pre-fader or post-fader signal is processed by the effect module.
On: Before the fader
Off: After the fader
- ⑧ **Parameter selection buttons**
Touch to display other parameters available for the current effect.
- ⑨ **Parameter sliders**
Allow you to adjust the parameters available for the current effect.
- ⑩ **Sync button**
Displayed for effects that have a tempo setting, such as delays. When this button is turned on, the effect's tempo setting can be controlled with the [TAP] button found in the SENDS ON FADER section of the top panel.
- ⑪ **Bypass button**
Allows you to bypass the effects module.
- ⑫ **Effects output level meter**
Displays the effects output level.
- ⑬ **CUE button**
Turns cue on and off for the effects module.

Setting an effect

1. Touch the effects type button.

When the EFFECTS TYPE screen is displayed, select the desired effect type.



2. Touch the Send button.



3. Adjust the parameter sliders as desired.

You can adjust the characteristics of the effect, the wet/dry balance, etc.

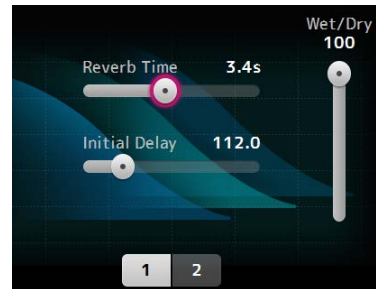

4. Adjust the effects send level slider.

This allows you to adjust how much of the channel's signal is sent to the effects module.

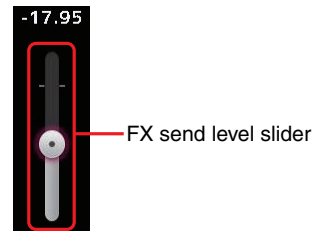

5. Adjust the FX RTN1/2 levels.

FX RTN1/2 channels are in the INPUT FADER BANK. (Stereo Channels → [page 42](#))

Setting an insert effect

You can configure insert effects for AUX9/10–AUX19/20.

1. Touch the effects type button.

When the EFFECTS TYPE screen is displayed, select the desired effect type.

2. Touch the bypass button.

Bypass is turned on by default; turn the bypass off.

3. Adjust the parameter sliders as desired.

Adjust the characteristics of the effect.

FX screen menu

Press the Menu key () from the FX screen to display the following options.

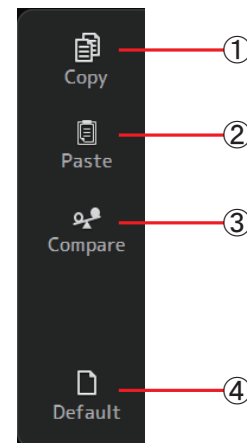

① Copy

Copies the effect parameters of the selected effect to the clipboard.

② Paste

Pastes the effect parameters in the clipboard to the selected effect.

③ Compare

Allows you to compare the effect parameters of the selected effect with the effect parameters in the clipboard by switching between the two.

④ Default

Resets the selected effect's settings to their default values.

EFFECT TYPE screen

Allows you to select the effect type. Touch the desired button to make a selection.

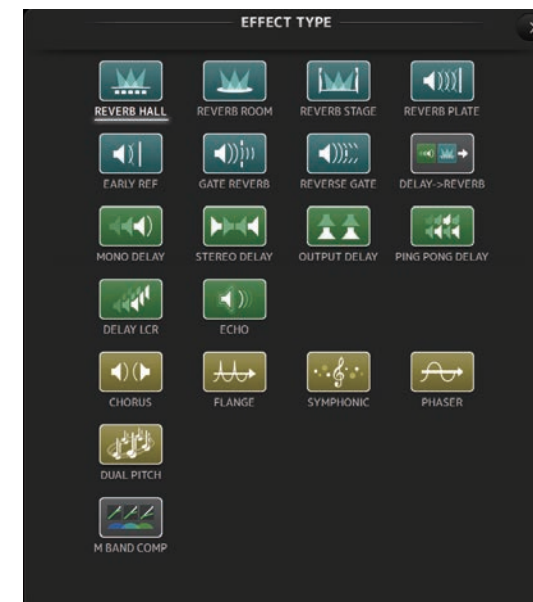

Effect parameters

REVERB HALL, REVERB ROOM, REVERB STAGE, REVERB PLATE

One-input, two-output hall, room, stage, and plate reverbs.

Parameter	Range	Description
Reverb Time	0.3s–20.0s	Determines the length of the reverberation.
Initial Delay	1.0ms–500.0ms	Determines the amount of time that passes before the initial reverberation is heard.
High Ratio	0.1–1.0	Ratio of high frequency reverberations to the Reverb Time.
Diffusion	0–10	Left and right spread of the reverberation.
Density	0% – 100%	Density of the reverberation.
HPF	Thru, 21.2Hz–8.00kHz	High-pass filter cutoff frequency.
LPF	50.0Hz–16.0kHz, Thru	Low-pass filter cutoff frequency.

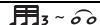
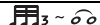

MONO DELAY

One-input, two-output basic repeating-type delay.

Parameter	Range	Description
Delay	1.0ms–2700.0ms	Delay time.
Feedback Gain	-99 – +99	Amount of feedback.
High Ratio	0.1–1.0	Amount of high-frequency feedback.
HPF	Thru, 21.2Hz–8.00kHz	High-pass filter cutoff frequency.
LPF	50.0Hz–16.0kHz, Thru	Low-pass filter cutoff frequency.
Sync	Off, On	Delay time tempo sync.
Note	----,  ~ 	Value used to calculate the delay time based on the tempo.



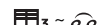
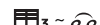





STEREO DELAY

Two-input, two-output basic stereo delay.

Parameter	Range	Description
Delay L	1.0ms–1350.0ms	Left channel delay time.
Delay R	1.0ms–1350.0ms	Right channel delay time.
Feedback Gain L	-99 – +99	Left channel feedback gain.
Feedback Gain R	-99 – +99	Right channel feedback gain.
High Ratio	0.1–1.0	Amount of high-frequency feedback.
HPF	Thru, 21.2Hz–8.00kHz	High-pass filter cutoff frequency.
LPF	50.0Hz–16.0kHz, Thru	Low-pass filter cutoff frequency.
Sync	Off, On	Delay time tempo sync.
Note L	----,  ~ 	Value used to calculate the left channel delay time based on the tempo.
Note R	----,  ~ 	Value used to calculate the right channel delay time based on the tempo.









DELAY LCR

One-input, two-output 3-tap delay.

Parameter	Range	Description
Delay L	1.0ms–2700.0ms	Left channel delay time.
Delay C	1.0ms–2700.0ms	Center channel delay time.
Delay R	1.0ms–2700.0ms	Right channel delay time.
Delay FB	1.0ms–2700.0ms	Feedback delay time.
Feedback Gain	-99 – +99	Amount of feedback.
High Ratio	0.1–1.0	Amount of high-frequency feedback.
HPF	Thru, 21.2Hz–8.00kHz	High-pass filter cutoff frequency.
LPF	50.0Hz–16.0kHz, Thru	Low-pass filter cutoff frequency.
Level L	-100 – +100	Left channel level.
Level C	-100 – +100	Center channel level.
Level R	-100 – +100	Right channel level.
Sync	Off, On	Delay time tempo sync.
Note L	----,  ~ 	Value used to calculate the left channel delay time based on the tempo.
Note C	----,  ~ 	Value used to calculate the center channel delay time based on the tempo.
Note R	----,  ~ 	Value used to calculate the right channel delay time based on the tempo.
Note FB	----,  ~ 	Value used to calculate the delay feedback time based on the tempo.



ECHO

Two-input, two-output stereo delay with a crossed feedback loop.

Parameter	Range	Description
Delay L	1.0ms–1350.0ms	Left channel delay time.
Delay R	1.0ms–1350.0ms	Right channel delay time.
Delay FB L	1.0ms–1350.0ms	Left channel feedback delay time.
Delay FB R	1.0ms–1350.0ms	Right channel feedback delay time.
Feedback Gain L	-99 – +99	Left channel feedback gain.
Feedback Gain R	-99 – +99	Right channel feedback gain.
XFeedback Gain	-99 – +99	Left-to-right, right-to-left feedback gain.
High Ratio	0.1–1.0	Amount of high-frequency feedback.
HPF	Thru, 21.2Hz–8.00kHz	High-pass filter cutoff frequency.
LPF	50.0Hz–16.0kHz, Thru	Low-pass filter cutoff frequency.
Sync	Off, On	Delay time tempo sync.
Note L	----,  ~ 	Value used to calculate the left channel delay time based on the tempo.
Note R	----,  ~ 	Value used to calculate the right channel delay time based on the tempo.
Note FBL	----,  ~ 	Value used to calculate the left channel feedback delay time based on the tempo.
Note FBR	----,  ~ 	Value used to calculate the right channel feedback delay time based on the tempo.

DELAY-REVERB (V1.1 and later)

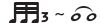
One-input, two-output effect that has a delay and reverb connected in series.

Parameter	Range	Description
Delay	1.0ms - 2700.0ms	Delay time.
Feedback Gain	-99% - 99%	Amount of feedback.
DLY BAL	0% - 100%	Delay mix balance.
Reverb Time	0.3s - 20.0s	Determines the length of the reverberation.
High Ratio	0.1 - 1.0	Ratio of high frequency reverberations to the Reverb Time.
Diffusion	0 - 10	Left and right spread of the reverberation.
Density	0% - 100%	Density of the reverberation.
HPF	Thru, 21.2Hz - 8.00kHz	High-pass filter cutoff frequency.
LPF	50.0Hz - 16.0kHz, Thru	Low-pass filter cutoff frequency.
REV BAL	0% - 100%	Reverb mix balance.
Sync	Off, On	Parameter tempo sync.
Note	---,  ~ 	Value used to calculate the delay time based on the tempo.

EARLY REF (V1.1 and later)

One-input, two-output early reflection effect.

Parameter	Range	Description
Type	S-Hall, L-Hall, Random, Reverse, Plate, Spring	Early reflection type.
Room Size	0.1 - 20.0	Room size; determines interval between early reflections.
Liveness	0 - 10	Decay of the early reflections (0: dead, 10: live).
Initial Delay	1.0ms - 500.0ms	Delay before the early reflection.
Diffusion	0 - 10	Width of the reflections in the stereo field.
Density	0% - 100%	Density of the reflections.
ER Number	1 - 19	Number of reflections.
Feedback Gain	-99% - 99%	Amount of feedback.
High Ratio	0.1 - 1.0	Amount of high-frequency feedback.
HPF	Thru, 21.2Hz - 8.00kHz	High-pass filter cutoff frequency.
LPF	50.0Hz - 16.0kHz, Thru	Low-pass filter cutoff frequency.



GATE REVERB, REVERSE GATE (V1.1 and later)

One-input, two-output early reflection with gate, and an early reflection with reverse gate.

Parameter	Range	Description
Type	Type-A, Type-B	Early reflection type.
Room Size	0.1 - 20.0	Room size; determines interval between early reflections.
Liveness	0 - 10	Decay of the early reflections.
Initial Delay	1.0ms - 500.0ms	Delay before the early reflection.
Diffusion	0 - 10	Width of the reflections in the stereo field.
Density	0% - 100%	Density of the reflections.
ER Number	1 - 19	Number of reflections.
Feedback Gain	-99% - 99%	Amount of feedback.
High Ratio	0.1 - 1.0	Amount of high-frequency feedback.
HPF	Thru, 21.2Hz - 8.00kHz	High-pass filter cutoff frequency.
LPF	50.0Hz - 16.0kHz, Thru	Low-pass filter cutoff frequency.



CHORUS (V1.1 and later)

Two-input, two-output chorus effect.

Parameter	Range	Description
Frequency	0.05Hz - 10.00Hz	Modulation speed
AM Depth	0% - 100%	Depth of amplitude modulation.
PM Depth	0% - 100%	Depth of pitch modulation.
MOD. Delay	1.0ms - 500.0ms	Delay time of modulation.
Sync	Off, On	Parameter tempo sync.
Note	 ~ 	Value used to calculate the frequency based on the tempo.

FLANGE (V1.1 and later)

Two-input, two-output flanger effect.

Parameter	Range	Description
Frequency	0.05Hz - 10.00Hz	Modulation speed
Depth	0% - 100%	Depth of modulation.
MOD. Delay	1.0ms - 500.0ms	Delay time of modulation.
Feedback Gain	-99% - 99%	Amount of feedback.
Sync	Off, On	Parameter tempo sync.
Note	 ~ 	Value used to calculate the frequency based on the tempo.

SYMPHONIC (V1.1 and later)

Two-input, two-output symphonic effect.

Parameter	Range	Description
Frequency	0.05Hz - 10.00Hz	Modulation speed
Depth	0% - 100%	Depth of modulation.
MOD. Delay	1.0ms - 500.0ms	Delay time of modulation.
Sync	Off, On	Parameter tempo sync.
Note		Value used to calculate the frequency based on the tempo.

PHASER (V1.1 and later)

Two-input, two-output 16-stage phase-shift effect.

Parameter	Range	Description
Frequency	0.05Hz - 10.00Hz	Modulation speed
Depth	0% - 100%	Depth of modulation.
Feedback Gain	-99% - 99%	Amount of feedback.
Offset	0 - 100	Offset of the phase shifted frequency.
Phase	0° - 355°	Left/right balance of modulation.
Stage	2 - 16	Number of phase shift stages.
HPF	Thru, 21.2Hz - 8.00kHz	High-pass filter cutoff frequency.
LPF	50.0Hz - 16.0kHz, Thru	Low-pass filter cutoff frequency.
Sync	Off, On	Parameter tempo sync.
Note		Value used to calculate the frequency based on the tempo.

M BAND COMP (V1.1 and later)

Two-input, two-output three-band compressor. Each band has solo and gain reduction metering.

Parameter	Range	Description
Low Gain	-12.0dB - +12.0dB	Low-band gain.
Mid Gain	-12.0dB - +12.0dB	Mid-band gain.
High Gain	-12.0dB - +12.0dB	High-band gain.
Total Gain	-72dB - +12dB	Overall gain.
L-M XOver	21.2Hz - 8.00kHz	Low-to-mid crossover frequency.
M-H XOver	21.2Hz - 8.00kHz	Mid-to-high crossover frequency.
Knee	0 - 5	Compressor knee (all bands).
Low/Mid/High Link	Off, On	When turned on, the difference in the threshold for low, mid, and high is maintained. (V3.0 and later)
Low Thr	-54dB - 0dB	Low threshold.
Low Ratio	1:1 - ∞:1	Low ratio.
Low Attack	0ms - 120ms	Low attack time.
Low Release	3.34ms - 42.7s	Low release time.
Low Bypass	Off, On	Compression bypass feature for low.
Low Solo	Off, On	Solo feature for low.
Mid Thr	-54dB - 0dB	Mid threshold.
Mid Ratio	1:1 - ∞:1	Mid ratio.
Mid Attack	0ms - 120ms	Mid attack time.
Mid Release	3.34ms - 42.7s	Mid release time.
Mid Bypass	Off, On	Compression bypass feature for mid.
Mid Solo	Off, On	Solo feature for mid.
High Thr	-54dB - 0dB	High threshold.
High Ratio	1:1 - ∞:1	High Ratio
High Attack	0ms - 120ms	High attack time.
High Release	3.34ms - 42.7s	High release time.
High Bypass	Off, On	Compression bypass feature for high.
High Solo	Off, On	Solo feature for high.

NOTE

The Make Up parameter is omitted for V3.0 and later.

PING PONG DELAY (V2.0 and later)

One-input, two-output ping pong delay. The delayed sound alternates between left and right at equal intervals.

Parameter	Range	Description
Delay	1.0ms - 1350.0ms	Delay time.
Feedback Gain	-99% - 99%	Amount of feedback.
High Ratio	0.1 - 1.0	Amount of high-frequency feedback.
HPF	Thru, 21.2Hz - 8.00kHz	High-pass filter cutoff frequency.
LPF	50.0Hz - 16.0kHz, Thru	Low-pass filter cutoff frequency.
Sync	Off, On	Parameter tempo sync.
Note	---, ♩ - ♪	Value used to calculate the delay time based on the tempo.

DUAL PITCH (V2.0 and later)

Two-input, two-output pitch-shift effect.

Parameter	Range	Description
Pitch 1	-24 - 24	Pitch of Ch1 (semitone increments).
Fine 1	-50 - 50	Pitch of Ch1 (1 cent increments).
Level 1	-100 - 100	Volume of Ch1.
Pan 1	L63 - R63	Pan of Ch1.
Delay 1	1.0ms - 1000.0ms	Delay time of Ch1.
Feedback Gain 1	-99 - 99	Feedback level of Ch1.
Pitch 2	-24 - 24	Pitch of Ch2 (semitone increments).
Fine 2	-50 - 50	Pitch of Ch2 (1 cent increments).
Level 2	-100 - 100	Volume of Ch2.
Pan 2	L63 - R63	Pan of Ch2.
Delay 2	1.0ms - 1000.0ms	Delay time of Ch2.
Feedback Gain 2	-99 - 99	Feedback level of Ch2.
Mode	1 - 10	Width of pitch shift.
Sync	Off, On	Parameter tempo sync.
Note 1	---, ♩ - ♪	Value used to calculate Delay 1 based on the tempo.
Note 2	---, ♩ - ♪	Value used to calculate Delay 2 based on the tempo.

OUTPUT DELAY (V2.5 and later)

Two-input, two-output single delay. When used for INS FX 1–6, this delay is good for delay compensation.

Parameter	Range	Description
LR LINK	On, Off	Links the left and right delays.
Delay	0.3 – 343.6 meter 1.1 – 1127.3 feet 1.00 – 1000.00ms	You can specify the delay time in meters, feet, or milliseconds.

SEND TO AUX screen

Allows you to configure the amount of signal that is sent from each channel to the AUX buses. You can swipe left and right to view other buses.

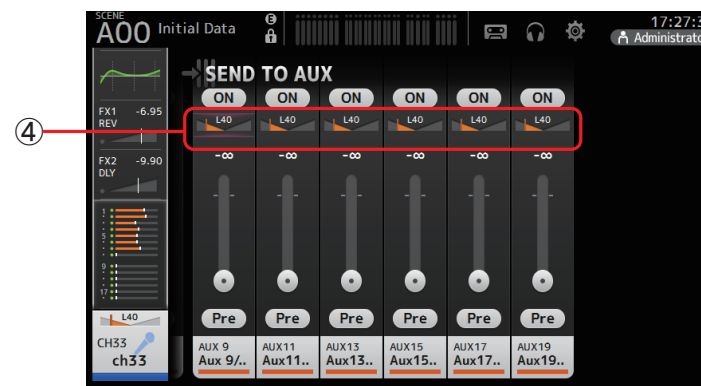
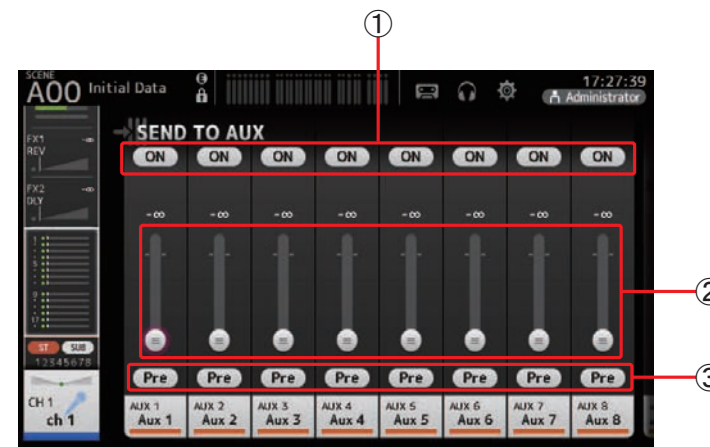

- ① **Send button**
Determines whether a signal is sent (on) or not sent (off) to the corresponding AUX bus.
- ② **Send level slider**
Determines the amount of signal sent to the corresponding AUX bus.

③ Pre button

Allows you to select whether the pre-fader or post-fader signal is sent to the corresponding AUX bus.

On: Before the fader

Off: After the fader

④ Send pan slider

Displayed for stereo AUX buses. Allows you to adjust the pan of the signal sent to the corresponding AUX bus.

Adjusting the SEND TO AUX level**1. Adjust the level sliders as desired.**

Each level slider determines the amount of signal sent from the selected channel to the corresponding AUX bus.

**2. Turn the Pre button on or off depending on your needs.**

Send the pre-fader signal when using the AUX bus for on-stage floor monitors—this allows you to create a mix that is separate from the main mix.

Send the post-fader signal when using external effects processors or when you want to maintain the same mix balance as the main mix.

3. Turn the send button on or off.

When turned on, the signal is sent to the corresponding AUX bus.

**4. Touch the send pan slider and then adjust it using the [TOUCH AND TURN] knob.**

When sending the signal to a stereo AUX bus, you can adjust the pan of the signal that is sent.

ASSIGN screen

Allows you configure recall safe and mute safe settings, DCA group assignments, signals sent to the SUB bus, etc.

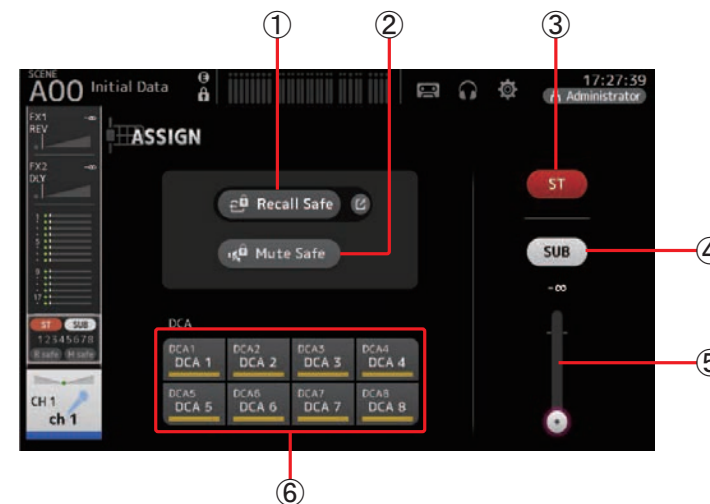
**① Recall Safe button**

Turns Recall Safe on and off for the corresponding channel.

You can display the RECALL SAFE screen by touching the jump button in the right corner of the Recall Safe button. (→page 25)

② Mute Safe button

You can temporarily exclude certain channels from a mute group.

If you mute a mute group, any channels in that group that have mute safe enabled will not be muted.

③ ST button

Turns the channel's assignment to the stereo channel on and off.

④ SUB button

Determines whether the channel's signal is sent (on) or not sent (off) to the SUB bus.

⑤ SUB level slider

Determines the amount of signal sent from the selected channel to the SUB bus.

⑥ DCA buttons

Turns the channel's assignment to each DCA group (1–8) on and off.

You can assign a channel to multiple DCA groups if desired.

CH VIEW screen

Provides an overview of all the settings for a channel.

You can change settings using this screen, in addition to the corresponding feature's configuration screen.

Items displayed on this screen vary depending on the type of channel selected.

CH1–CH32

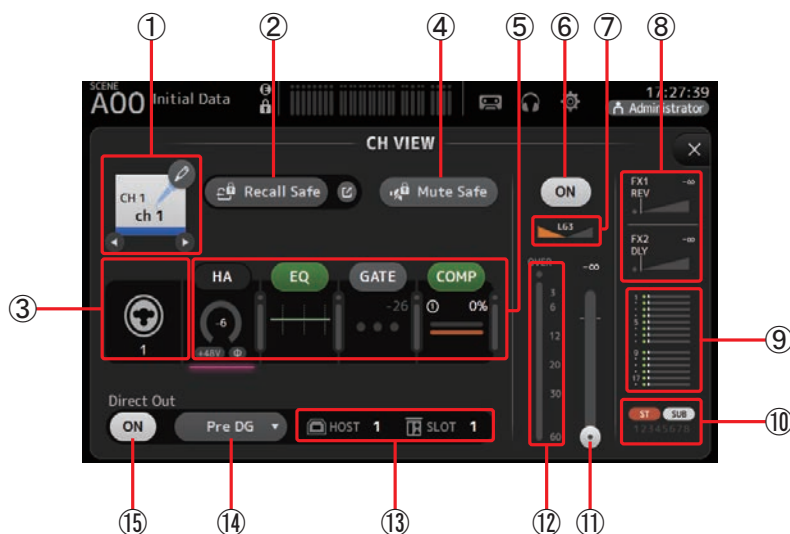

- ① **Channel name**
Touch to display the CH NAME screen.
Touch ◀ / ▶ to display information for a different channel.
- ② **Recall Safe button**
Turns recall safe on and off for the corresponding channel.
You can display the RECALL SAFE screen (→page 25) by touching the jump button in the right corner of the Recall Safe button.
- ③ **Input source indicator**
Displays the input channel's input source. You can select the input source on the INPUT screen.
- ④ **Mute Safe button**
Touch to temporarily exclude the selected channel from the input mute group.
If you mute the input mute group, any channels in that group that have mute safe enabled will not be muted.

- ⑤ **Boxes**
Touch to display the configuration screen for the corresponding feature.
You can touch the EQ, GATE, and COMP buttons displayed here to turn the corresponding feature on and off.
HA box: Displays the INPUT screen. (→page 47)
EQ box: Displays the EQ screen. (→page 49)
GATE box: Displays the GATE screen. (→page 53)
COMP box: Displays the COMP screen. (→page 55)
- ⑥ **Channel on/off button**
Turns the selected channel on and off.
- ⑦ **Channel pan slider**
Adjusts the pan for the selected channel.
- ⑧ **FX1/FX2 boxes**
Displays the effect type.
When selected, you can use the [TOUCH AND TURN] knob to adjust the effects send level. You can also display the corresponding effect's configuration screen by touching again.
Each box displays the amount of signal from the selected channel that is sent to the corresponding effects module.
Send level, the selected channel's fader level, and the actual send level grouped with the DCA is displayed in the triangular bar.
The information displayed here indicates whether the signal sent to the effects module is the pre-fader or post-fader signal. Pre-fader signal is displayed in green; post-fader signal is displayed in gray.
- ⑨ **SEND TO AUX box**
Touch when selected to display the SEND TO AUX screen.
Displays the amount of signal from the selected channel that is sent to each AUX bus.
Send level, the selected channel's fader level, and the actual send level grouped with the DCA is displayed in the horizontal bar.
The information displayed here indicates whether the signal sent to the AUX bus is the pre-fader or post-fader signal. Pre-fader signal is displayed in green; post-fader signal is displayed in gray.
- ⑩ **ASSIGN box**
Displays the ASSIGN screen. (→page 63)
- ⑪ **Channel output level slider**
Adjusts the fader level for the selected channel.
- ⑫ **Channel output level meter**
Displays the channel's output signal level.

13 **Direct out port indicator**

Indicates the channel's direct out port.

For information about channels and output ports, see "Quick Config Input and input channel relationships" (→page 92).

14 **Direct out point button**

Allows you to set the point of the direct out signal.

Pre DG: Before the digital gain

Pre HPF: Before the high-pass filter

Pre Fader: Before the fader

Post Fader: After the fader

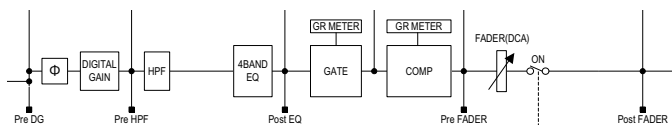

15 **Direct out on/off button**

Turns the direct out on and off.

CH33-CH40

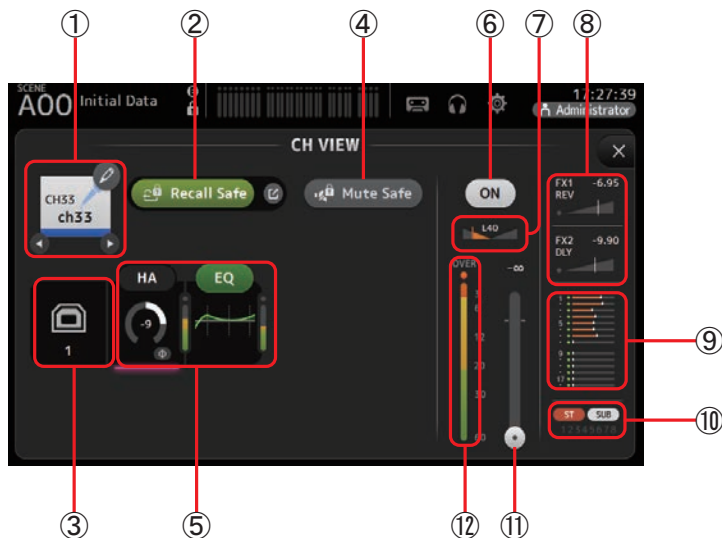

1 **Channel name**

Touch to display the CH NAME screen.

Touch ◀ / ▶ to display information for a different channel.

2 **Recall Safe button**

Turns recall safe on and off for the corresponding channel.

You can display the RECALL SAFE screen (→page 25) by touching the jump button in the right corner of the Recall Safe button.

3 **Input source indicator**

Displays the input channel's input source. You can select the input source on the INPUT screen.

4 **Mute Safe button**

Touch to temporarily exclude the selected channel from the input mute group.

If you mute the input mute group, any channels in that group that have mute safe enabled will not be muted.

5 **Boxes**

Touch to display the configuration screen for the corresponding feature.

You can touch the EQ button displayed here to turn EQ on and off.

HA box: Displays the INPUT screen. (→page 47)

EQ box: Displays the EQ screen. (→page 49)

6 **Channel on/off button**

Turns the selected channel on and off.

7 **Channel pan slider**

Adjusts the pan for the selected channel.

8 **FX1/FX2 boxes**

Displays the effect type.

When selected, you can use the [TOUCH AND TURN] knob to adjust the effects send level. You can also display the corresponding effect's configuration screen by touching again.

Each box displays the amount of signal from the selected channel that is sent to the corresponding effects module.

Send level, the selected channel's fader level, and the actual send level grouped with the DCA is displayed in the triangular bar.

The information displayed here indicates whether the signal sent to the effects module is the pre-fader or post-fader signal. Pre-fader signal is displayed in green; post-fader signal is displayed in gray.

9 **SEND TO AUX box**

Touch when selected to display the SEND TO AUX screen.

Displays the amount of signal from the selected channel that is sent to each AUX bus. Send level, the selected channel's fader level, and the actual send level grouped with the DCA is displayed in the horizontal bar.

The information displayed here indicates whether the signal sent to the AUX bus is the pre-fader or post-fader signal. Pre-fader signal is displayed in green; post-fader signal is displayed in gray.

- ⑩ **ASSIGN box**
Displays the ASSIGN screen. (→page 63)

- ⑪ **Channel output level slider**
Adjusts the fader level for the selected channel.

- ⑫ **Channel output level meter**
Displays the channel's output signal level.

ST IN 1L-ST IN 2R

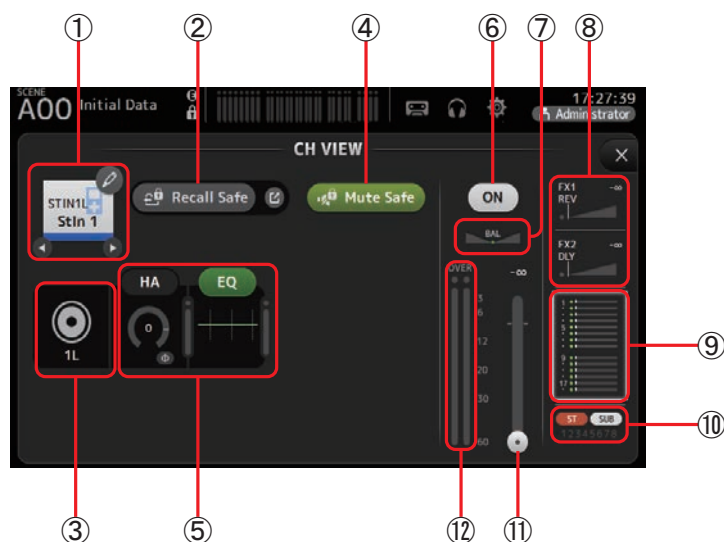

- ① **Channel name**
Touch to display the CH NAME screen.
Touch ◀ / ▶ to display information for a different channel.
- ② **Recall Safe button**
Turns recall safe on and off for the corresponding channel.
You can display the RECALL SAFE screen (→page 25) by touching the jump button in the right corner of the Recall Safe button.
- ③ **Input source indicator**
Displays the input channel's input source. You can select the input source on the INPUT screen.

- ④ **Mute Safe button**
Touch to temporarily exclude the selected channel from the input mute group.
If you mute the input mute group, any channels in that group that have mute safe enabled will not be muted.

- ⑤ **Boxes**
Touch to display the configuration screen for the corresponding feature.
You can touch the EQ button displayed here to turn EQ on and off.
HA box: Displays the INPUT screen. (→page 47)
EQ box: Displays the EQ screen. (→page 49)

- ⑥ **Channel on/off button**
Turns the selected channel on and off.

- ⑦ **Channel pan slider**
Adjusts the pan for the selected channel.

- ⑧ **FX1/FX2 boxes**
Displays the effect type.
When selected, you can use the [TOUCH AND TURN] knob to adjust the effects send level. You can also display the corresponding effect's configuration screen by touching again.
Each box displays the amount of signal from the selected channel that is sent to the corresponding effects module.
Send level, the selected channel's fader level, and the actual send level grouped with the DCA is displayed in the triangular bar.
The information displayed here indicates whether the signal sent to the effects module is the pre-fader or post-fader signal. Pre-fader signal is displayed in green; post-fader signal is displayed in gray.

- ⑨ **SEND TO AUX box**
Touch when selected to display the SEND TO AUX screen.
Displays the amount of signal from the selected channel that is sent to each AUX bus.
Send level, the selected channel's fader level, and the actual send level grouped with the DCA is displayed in the horizontal bar.
The information displayed here indicates whether the signal sent to the AUX bus is the pre-fader or post-fader signal. Pre-fader signal is displayed in green; post-fader signal is displayed in gray.

- ⑩ **ASSIGN box**
Displays the ASSIGN screen. (→page 63)

- ⑪ **Channel output level slider**
Adjusts the fader level for the selected channel.

- ⑫ **Channel output level meter**
Displays the channel's output signal level.

FX1L–FX2R

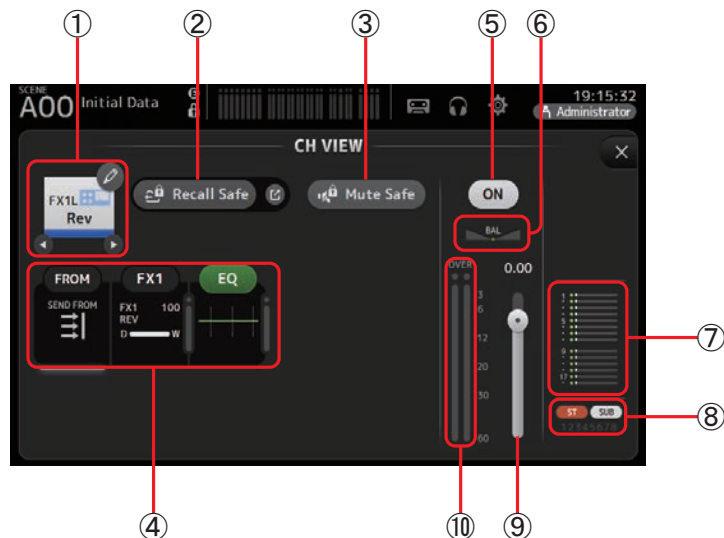

- ① **Channel name**
Touch to display the CH NAME screen.
Touch ◀ / ▶ to display information for a different channel.
- ② **Recall Safe button**
Turns recall safe on and off for the corresponding channel.
You can display the RECALL SAFE screen (→page 25) by touching the jump button in the right corner of the Recall Safe button.
- ③ **Mute Safe button**
Touch to temporarily exclude the selected channel from the effects mute group.
If you mute the effects mute group, any channels in that group that have mute safe enabled will not be muted.
- ④ **Boxes**
Touch to display the configuration screen for the corresponding feature.
You can touch the EQ button displayed here to turn EQ on and off.
FROM box: Displays the SEND FROM screen. (→page 75) (V3.0 and later)
FX1 (FX2) box: Displays the FX screen. (→page 57)
EQ box: Displays the EQ screen. (→page 49)

- ⑤ **Channel on/off button**
Turns the selected channel on and off.
- ⑥ **Channel pan slider**
Adjusts the pan for the selected channel.
- ⑦ **SEND TO AUX box**
Touch when selected to display the SEND TO AUX screen.
Displays the amount of signal from the selected channel that is sent to each AUX bus. Send level, the selected channel's fader level, and the actual send level grouped with the DCA is displayed in the horizontal bar.
The information displayed here indicates whether the signal sent to the AUX bus is the pre-fader or post-fader signal. Pre-fader signal is displayed in green; post-fader signal is displayed in gray.
- ⑧ **ASSIGN box**
Displays the ASSIGN screen. (→page 63)
- ⑨ **Channel output level slider**
Adjusts the fader level for the selected channel.
- ⑩ **Channel output level meter**
Displays the channel's output signal level.

DCA 1–DCA 8

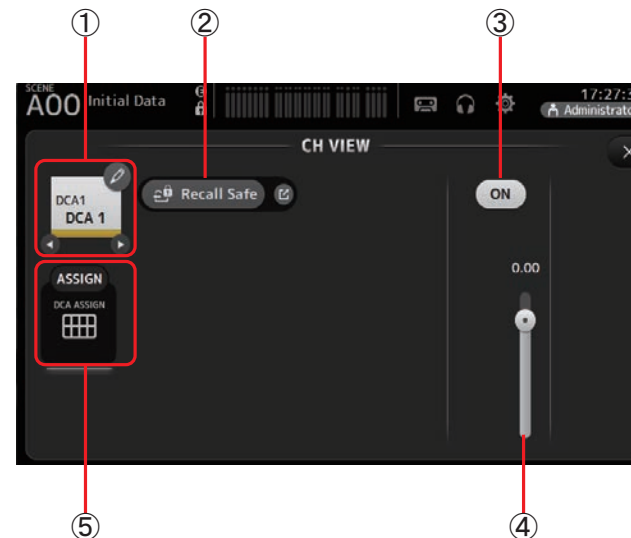

- ① **Channel name**
Touch to display the CH NAME screen.
Touch ◀ / ▶ to display information for a different channel.
- ② **Recall Safe button**
Turns recall safe on and off for the corresponding channel.
You can display the RECALL SAFE screen (→page 25) by touching the jump button in the right corner of the Recall Safe button.
- ③ **Channel on/off button**
Turns the selected channel on and off.
- ④ **Channel output level slider**
Adjusts the fader level for the selected channel.
- ⑤ **ASSIGN box (V1.1 and later)**
When this area is selected, touch this area to display the DCA ASSIGN screen. (→page 76)

AUX1–AUX8

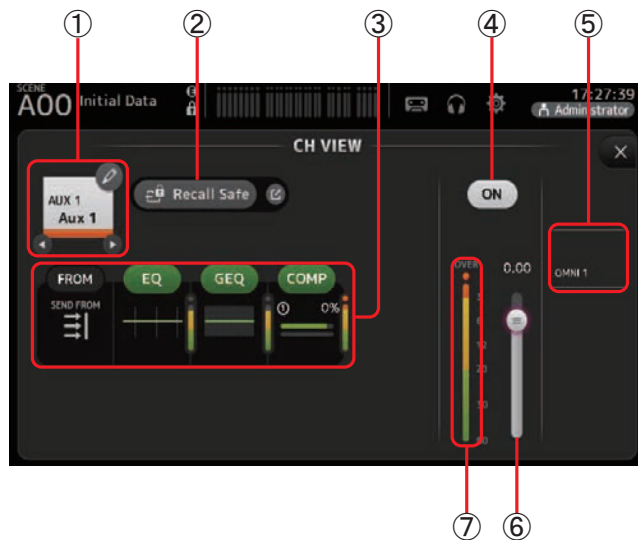

- ① **Channel name**
Touch to display the CH NAME screen.
Touch ◀ / ▶ to display information for a different channel.

- ② **Recall Safe button**
Turns recall safe on and off for the corresponding channel.
You can display the RECALL SAFE screen (→page 25) by touching the jump button in the right corner of the Recall Safe button.
- ③ **Boxes**
Touch to display the configuration screen for the corresponding feature.
You can touch the EQ, GEQ, and COMP buttons displayed here to turn the corresponding feature on and off.
FROM box: Displays the SEND FROM screen. (→page 75)
EQ box: Displays the EQ screen. (→page 49)
GEQ box: Displays the GEQ screen. (→page 72)
COMP box: Displays the COMP screen. (→page 55)
- ④ **Channel on/off button**
Turns the selected channel on and off.
- ⑤ **OUTPUT box**
Displays the OUTPUT screen. (→page 74)
- ⑥ **Channel output level slider**
Adjusts the fader level for the selected channel.
- ⑦ **Channel output level meter**
Displays the channel's output signal level.

AUX 9–AUX 20

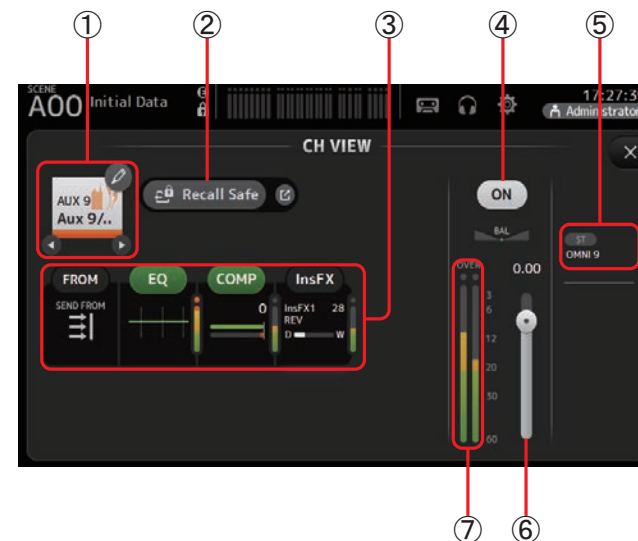

① **Channel name**

Touch to display the CH NAME screen.

Touch ◀/▶ to display information for a different channel.

② **Recall Safe button**

Turns recall safe on and off for the corresponding channel.

You can display the RECALL SAFE screen (→page 25) by touching the jump button in the right corner of the Recall Safe button.

③ **Boxes**

Touch to display the configuration screen for the corresponding feature.

You can touch the EQ and COMP buttons displayed here to turn the corresponding feature on and off.

FROM box: Displays the SEND FROM screen. (→page 75)

EQ box: Displays the EQ screen. (→page 49)

COMP box: Displays the COMP screen. (→page 55)

InsFX box: Displays the FX screen. (→page 57)

④ **Channel on/off button**

Turns the selected channel on and off.

⑤ **OUTPUT box**

Displays the OUTPUT screen. (→page 74)

⑥ **Channel output level slider**

Adjusts the fader level for the selected channel.

⑦ **Channel output level meter**

Displays the channel's output signal level.

SUB

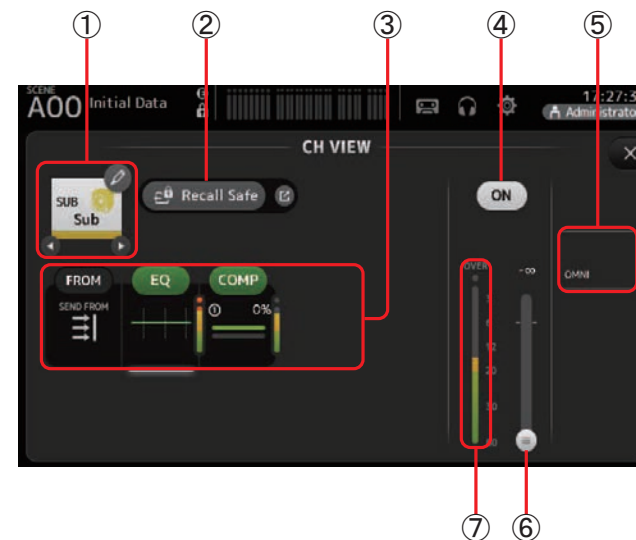
① **Channel name**

Touch to display the CH NAME screen.

Touch ◀/▶ to display information for a different channel.

② **Recall Safe button**

Turns recall safe on and off for the corresponding channel.

You can display the RECALL SAFE screen (→page 25) by touching the jump button in the right corner of the Recall Safe button.

③ **Boxes**

Touch to display the configuration screen for the corresponding feature.

You can touch the EQ and COMP buttons displayed here to turn the corresponding feature on and off.

FROM box: Displays the SEND FROM screen. (→page 75)

EQ box: Displays the EQ screen. (→page 49)

COMP box: Displays the COMP screen. (→page 55)

④ **Channel on/off button**

Turns the selected channel on and off.

⑤ **OUTPUT box**

Displays the OUTPUT screen. (→page 74)

⑥ **Channel output level slider**

Adjusts the fader level for the selected channel.

- ⑦ **Channel output level meter**
Displays the channel's output signal level.

ST L, ST R

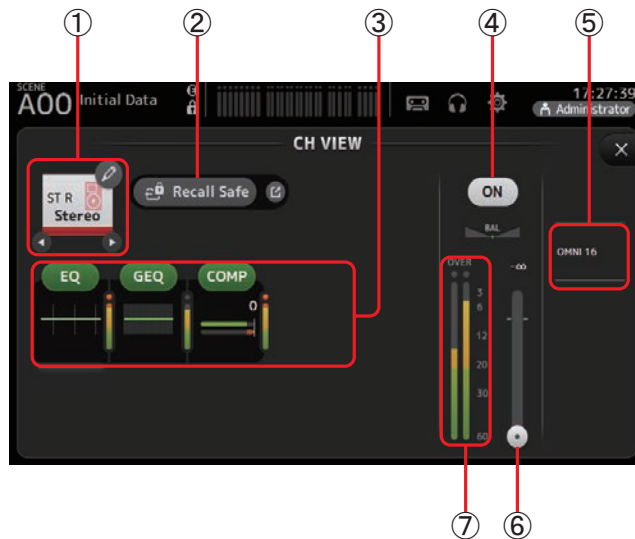

- ① **Channel name**
Touch to display the CH NAME screen.
Touch ◀ / ▶ to display information for a different channel.
- ② **Recall Safe button**
Turns recall safe on and off for the corresponding channel.
You can display the RECALL SAFE screen (→page 25) by touching the jump button in the right corner of the Recall Safe button.
- ③ **Boxes**
Touch to display the configuration screen for the corresponding feature.
You can touch the EQ, GEQ, and COMP buttons displayed here to turn the corresponding feature on and off.
EQ box: Displays the EQ screen. (→page 49)
GEQ box: Displays the GEQ screen. (→page 72)
COMP box: Displays the COMP screen. (→page 55)
- ④ **Channel on/off button**
Turns the selected channel on and off.

- ⑤ **OUTPUT box**
Displays the OUTPUT screen. (→page 74)
- ⑥ **Channel output level slider**
Adjusts the fader level for the selected channel.
- ⑦ **Channel output level meter**
Displays the channel's output signal level.

MATRIX1– MATRIX4 (V2.5 and later)

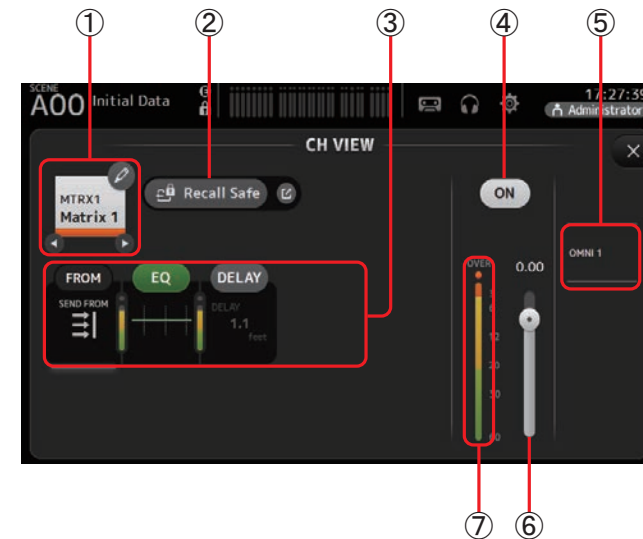

- ① **Channel name**
Touch to display the CH NAME screen.
Touch ◀ / ▶ to display information for a different channel.
- ② **Recall Safe button**
Turns recall safe on and off for the corresponding channel.
You can display the RECALL SAFE screen (→page 25) by touching the jump button in the right corner of the Recall Safe button.

③ **Boxes**

Touch to display the configuration screen for the corresponding feature.
 You can touch the EQ, and COMP buttons displayed here to turn the corresponding feature on and off.

FROM box: Displays the SEND FROM screen. (→page 75)

EQ box: Displays the EQ screen. (→page 49)

DELAY box: Displays the DELAY screen. (→page 78)

④ **Channel on/off button**

Turns the selected channel on and off.

⑤ **OUTPUT box**

Displays the OUTPUT screen. (→page 74)

⑥ **Channel output level slider**

Adjusts the fader level for the selected channel.

⑦ **Channel output level meter**

Displays the channel's output signal level.

CH VIEW screen menu

Press the Menu key () from the CH VIEW screen to display the following options.

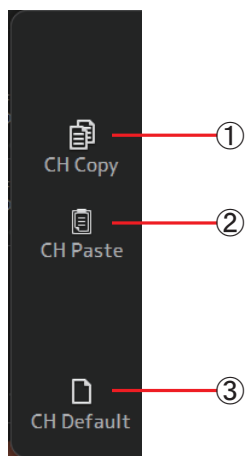

- ① **CH Copy**
Copies the settings of the current channel.
- ② **CH Paste**
Pastes settings from another channel and applies them to the current channel.
- ③ **CH Default**
Resets the settings of the current channel to their default values.

CH NAME screen

Allows you to set the channel name, icon, and channel color.



- ① **Name text box**
Enter the channel name here.
Touch the text box to enter the name using the KEYBOARD screen. (→page 10)
- ② **Icon button**
Touch to display a list of available channel icons.
- ③ **Category button**
Allows you to select a different category of channel icons.
The available categories vary depending on the type of channel.
- ④ **Channel icon list**
Touch to apply the channel icon.
You can drag this area up and down to display all of the available icons.
- ⑤ **Sample Name button**
Displays a list of commonly used channel names based on the selected channel icon.
Touch on a sample name to use it as the channel name.

⑥ **Color button**

Touch to display a list of available channel colors.



Touch the desired color to use that color as the channel color.

GEQ screen

You can use the internal graphic equalizer (GEQ) to process AUX 1–8 and STEREO channel signals.

The GEQ is a mono, 12-band EQ. Each band is 1/3 octave wide, with an adjustable gain range of ± 15 dB.

31 bands are available; you can adjust gain for up to 12 bands.

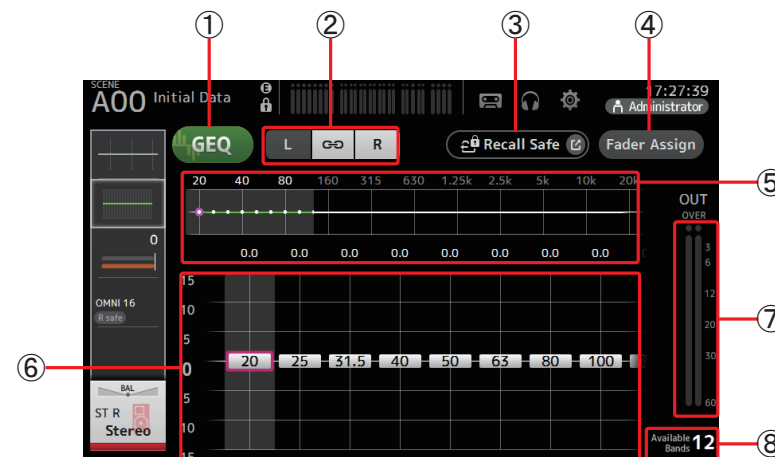

- ① **GEQ button**
Turns the GEQ on and off.
- ② **GEQ channel selection buttons**
These buttons are displayed only when configuring the GEQ for stereo AUX buses or the STEREO channels.
They are not displayed for mono AUX buses.
 : Turns the GEQ left/right channel link on and off.
L/R: Allows you select the left and right GEQ channels.
- ③ **Recall Safe button**
Displays the RECALL SAFE screen. (→page 25)
- ④ **Fader Assign button (V2.0 and later)**
This feature is available for TF5/TF3/TF1.
When this button is turned on, you can use the faders to adjust each band of the GEQ.
- ⑤ **EQ graph, RTA display, band selection**
Displays the EQ settings with RTA (real-time analysis).
Swipe left or right or touch an area to display the gain sliders for other bands.

When the Fader Assign button is turned on, you can use this area to change which bands can be adjusted by the faders. (TF3 and TF1 only.)

- ⑥ **Gain slider**
Adjusts the gain for the corresponding band.
Swipe left or right to display the gain sliders for other bands.
When the Fader Assign button is turned on, you can use this area to change which bands can be adjusted by the faders. (TF3 and TF1 only.)
- ⑦ **Output level meter**
Displays the GEQ output level.
- ⑧ **Available bands display**
Displays the number of additional bands that you can adjust.

Using GEQ

1. Touch the GEQ button to turn GEQ on.



2. Swipe left or right on the gain sliders to display the desired bands.
3. Drag sliders up and down to adjust the gain of the corresponding bands.

You can confirm the overall output using the output level meter.

Once you have adjusted gain for 12 bands, the gain sliders for the remaining bands are displayed in gray. If you want adjust gain for other bands, you must first set the gain to 0 for one of the bands you have already adjusted.

Touch the gain slider quickly two times to reset it to its default value (0 dB).

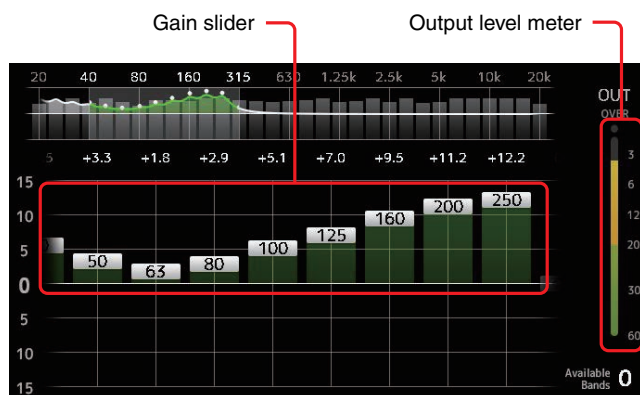

Using faders to adjust GEQ (TF5/TF3/TF1)

1. Touch the Fader Assign button to turn it on.

The current gain setting for each band is applied to the faders in the channel strip section of the console.

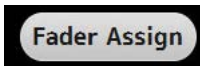

You can confirm the frequency and gain for each band in the channel display.

2. For TF3 and TF1, swipe left or right on the gain sliders in the GEQ screen to select other bands.

You can swipe the EQ graph, RTA display, or band selection area left or right to select other bands. For TF5, all bands are applied to the faders.

3. Use the console's faders to adjust the gain.

If you turn on a channel's [ON] key, you can reset the gain of frequencies assigned to that channel to 0 dB.

4. When you are finished making adjustments, touch the Fader Assign button to turn it off.

Fader Assign also turns off when you switch another screen or enter SENDS ON FADER mode.

GEQ screen menu

Press the Menu key (☰) from the GEQ screen to display the following options.

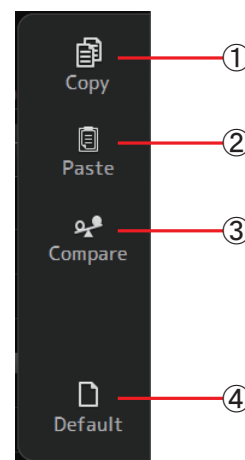

- ① **Copy**
Copies the GEQ parameters of the selected channel to the clipboard.
- ② **Paste**
Pastes the GEQ parameters in the clipboard to the selected channel.
- ③ **Compare**
Allows you to compare the GEQ parameters of the selected channel with the GEQ parameters in the clipboard by switching between the two.
- ④ **Default**
Resets the GEQ settings for the current channel to their default values.

OUTPUT screen

Allows you to configure how output channels will be output. The buttons displayed vary depending on the type of output channel selected.

Output channel	Buttons					
	ST button	SUB button SUB slider	Out Gain Buttons	Φ button	OMNI OUT Indicator	OMNI OUT Buttons
AUX 1–8	–	–	○	○	○	○
AUX9/10–AUX19/20	○	○	○	○	○	○
SUB	–	–	○	○	○	○
STEREO	–	–	○	○	○	○
MATRIX1–4	–	–	○	○	○	○

○ : Displayed
– : Not displayed

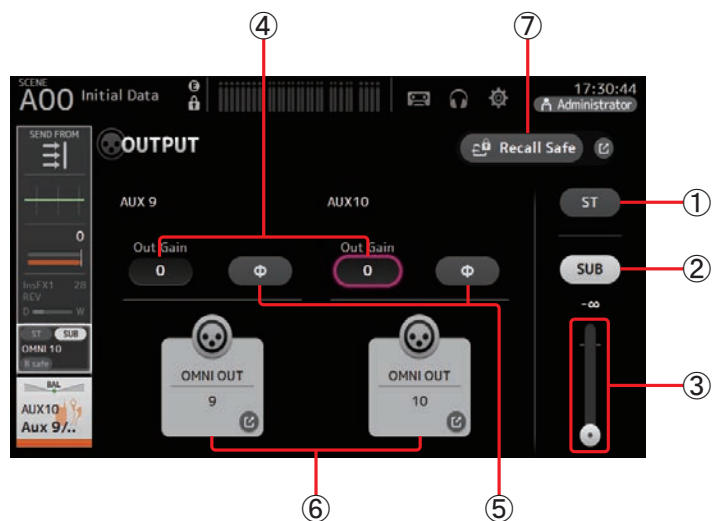

- ① **ST button**
Determines whether the stereo channel is output or not.
- ② **SUB button (V3.0 and later)**
Determines whether the channel's signal is sent (on) or not sent (off) to the SUB bus.
- ③ **SUB slider (V3.0 and later)**
Determines the amount of signal sent from the selected channel to the SUB bus.

- ④ **Out Gain text box**
Allows you to adjust the output gain.
When selected, you can use the [TOUCH AND TURN] knob to adjust the setting. Touch again to display the keyboard and enter a value.
- ⑤ **Φ (phase) button**
Allows you to reverse the phase.
When turned on, the output signal's phase is reversed.
- ⑥ **OMNI OUT button**
Displays the number of the OMNI OUT to which the channel is directed.
Up to two numbers can be displayed. For three or more numbers, "+" is displayed.
Displays the OMNI OUT screen. (→page 22)
For information about channels and output ports, see "Quick Config Input and input channel relationships" (→page 92).
- ⑦ **Recall Safe button (V1.1 and later)**
Turns recall safe on and off for the corresponding channel.
You can display the RECALL SAFE screen by touching the jump button in the right corner of the Recall Safe button.

SEND FROM screen

Allows you to send signals from the each channels.

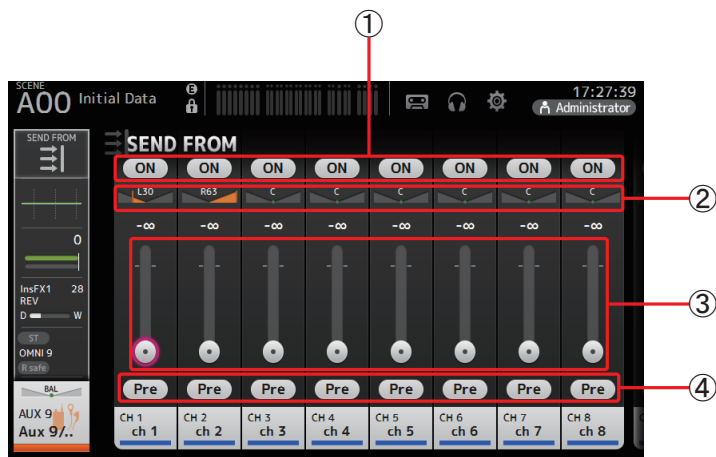

- ① **ON button**
Determines whether a signal is sent (on) or not sent (off) from the corresponding each channel.
- ② **Send pan slider**
Adjusts the pan of the input channel signal that is sent.
For AUX 1–8, this slider is only displayed if the signal type is set to stereo.
Not displayed for MATRIX 1–4 or FX1L–FX2R.
- ③ **Send level slider**
Determines the amount of signal sent from the corresponding each channel.
- ④ **Pre button**
Allows you to select whether the pre-fader or post-fader signal is sent from the corresponding input channel.
On: Before the fader
Off: After the fader
Not displayed for MATRIX 1–4.

Adjusting the SEND FROM level

1. Touch the ON button for the input channels that you want to send.
2. Touch the send pan slider, and then use the [TOUCH AND TURN] knob to adjust the pan of the input channel signal that is sent.
3. Drag the send level sliders to adjust the amount of input channel signal that is sent.

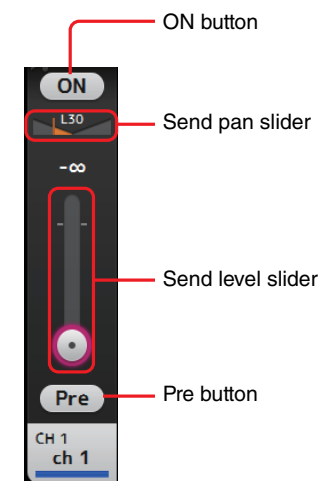

Adjusting the send level from AUX channels, STEREO channels, and SUB channel to a MATRIX channel (V2.5 and later)

1. Touch the ON button for the AUX channel, STEREO channel, or SUB channel that you want to send. (It is turned on by default.)
2. Drag the send level sliders to adjust the amount of AUX channel, STEREO channel, and SUB channel signal that is sent.

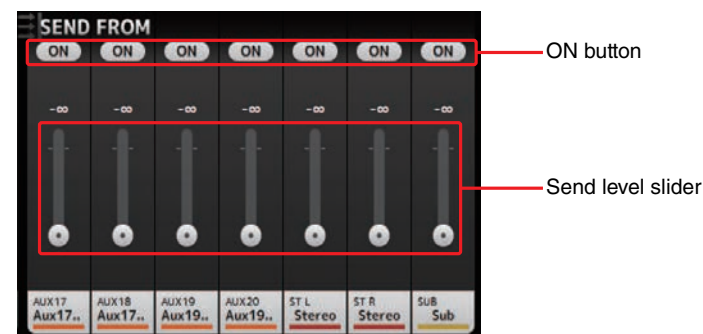

NOTE

- You can send the post-on signal of an AUX channel, STEREO channel, or SUB channel to a MATRIX channel.
- Left and right channel SEND levels can be adjusted independently for stereo channels such as AUX 9/10 and STEREO.

SEND FROM screen menu

Press the Menu key () from the SEND FROM screen to display the following options.

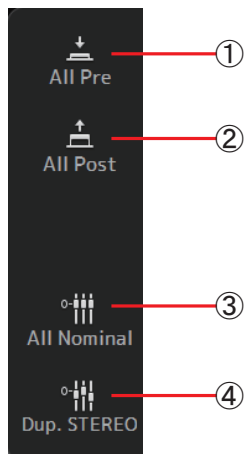

- ① **All Pre**
Turns on all Pre buttons.
- ② **All Post**
Turns off all Pre buttons.
- ③ **All Nominal (V2.0 and later)**
Sets all SEND levels to nominal (0 dB).
- ④ **Dup. STEREO (V2.0 and later)**
Duplicate STEREO. Copies each channel's fader level and applies it to the SEND level.

NOTE

This menu is not available for MATRIX channels 1–4.

DCA ASSIGN screen

Allows you to group channels together by assigning them to DCA groups.

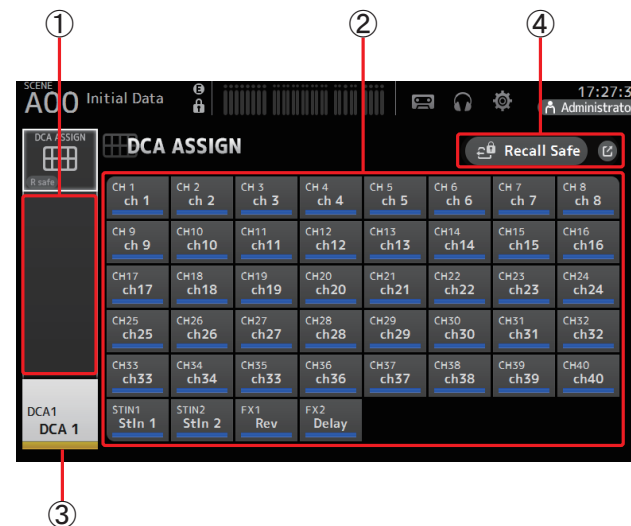

- ① **Channel display area**
Displays the channels that are assigned to the current DCA group.
- ② **DCA ASSIGN buttons**
Allow you to select which channels are assigned to the current DCA group. Selected channels are highlighted.
- ③ **CH VIEW button**
Displays the CH VIEW screen. (→page 64)
- ④ **Recall Safe button (V1.1 and later)**
Turns recall safe on and off for the corresponding channel. You can display the RECALL SAFE screen by touching the jump button in the right corner of the Recall Safe button.

Assigning channels to a DCA group

1. Press the [INPUT1] and [INPUT2] buttons on the top panel simultaneously to display the GROUP channels.
2. Press a [SEL] button on the top panel that corresponds to the DCA group that you want to configure.
3. Touch the DCA buttons that correspond to the channels you want to assign to the group. (You can select multiple channels.)

The selected channels are displayed in the channel display area.

Channel is selected

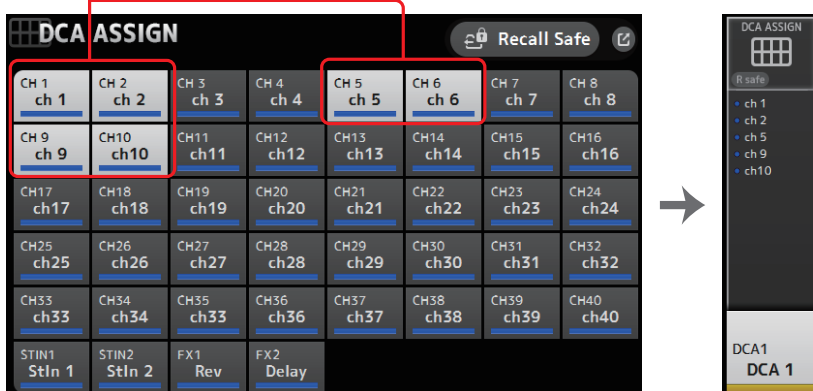

DCA ASSIGN screen menu

Press the Menu key () from the DCA ASSIGN screen to display the following options.

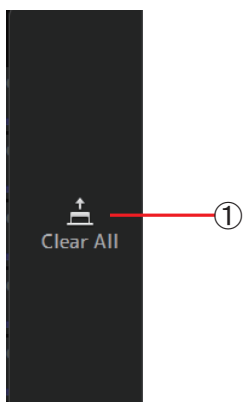

- ① **Clear All**
Removes all channels from the group.

DCA roll out

You can assign DCA groups 1–8 to the last 8 channel strips on the right side of the console's top panel.

(TF5: channel strips 25–32; TF3: 17–24; TF1: 9–16)

You can then assign the channels of a DCA group to the channel strips on the left side of the console's top panel by pressing the corresponding DCA group's [SEL] key.

(TF5: channel strips 1–24; TF3: 1–16; TF1: 1–8)

The number of channels in the group that will be assigned to the channels strips depends on the model number. For the TF5 console, the 24 lowest numbered channels in the group are assigned; the lowest 16 for the TF 3, and the lowest 8 for the TF1.

This feature allows you to manipulate the channels strips for both the DCA group master and the group's "member" channels at the same time.

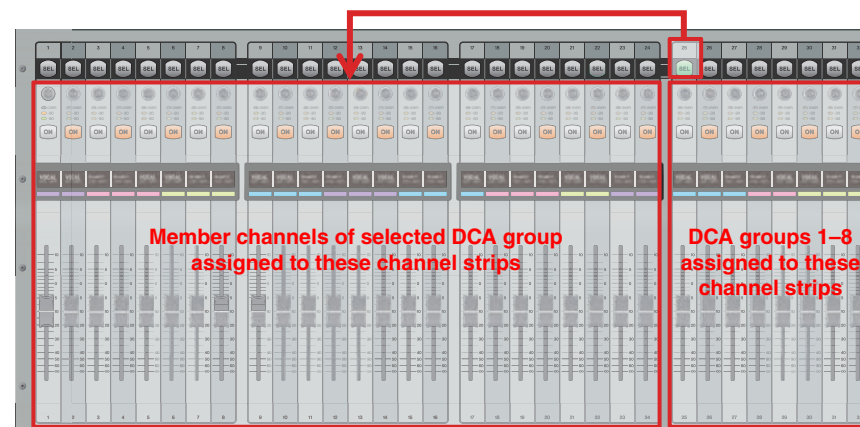

NOTE

For TF-RACK, this item is displayed only in the OVERVIEW screen. The channels assigned to the faders are the same as for the TF1.

DELAY screen (V2.5 and later)

Allows you to configure the delay applied to the signal output from the MATRIX channels. This works well for delay compensation for speakers that are placed far away.

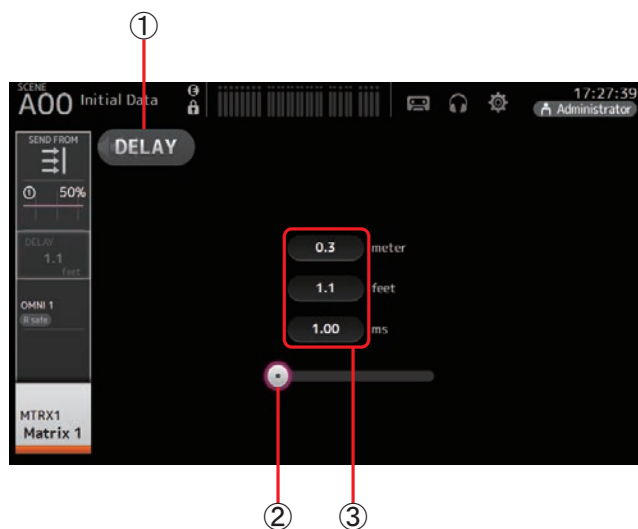

- ① **DELAY button**
Turns the DELAY on and off.
- ② **DELAY slider**
Allows you to adjust the delay time.
You can specify the delay time in meters, feet, or milliseconds.
- ③ **DELAY setting**
Determines the delay time by specifying distance (meters or feet) or time (milliseconds).
Touch a text box to display the keyboard and enter a value.

Allows you to access maintenance features.

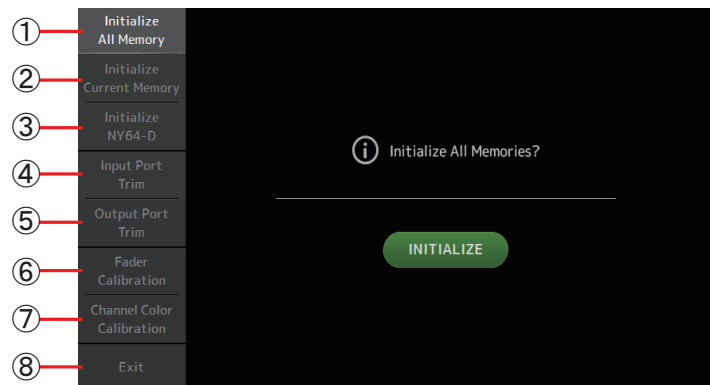

- ① Displays the Initialize All Memory screen.
- ② Displays the Initialize Current Memory screen. (→page 80)
- ③ Displays the Initialize NY64-D screen. (→page 80) (V3.0 and later)
- ④ Displays the Input Port Trim screen. (→page 81)
- ⑤ Displays the Output Port Trim screen. (→page 81)
- ⑥ Displays the Fader Calibration screen. (→page 82) (TF5/TF3/TF1)
- ⑦ Displays the Channel Color Calibration screen. (→page 83) (TF5/TF3/TF1)
- ⑧ Closes the maintenance screen.

Using the maintenance screen

1. Turn on the console while pressing the Home key (⏠).

The maintenance screen is displayed.

Touch the button that corresponds to the desired maintenance feature.

Touch the Exit button to exit the maintenance mode.

Initialize All Memory screen

Resets the console's memory, including Scene memory and Libraries, to the factory default settings.

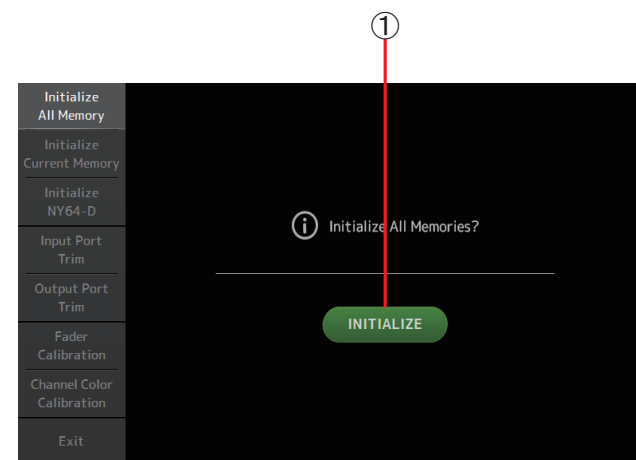

① INITIALIZE button

Initializes the internal memory.

The following data is initialized: all Scene data, all Preset data, mixing data, and setup data.

Touch to display the confirmation message. Touch the OK button to perform the operation.

Do not touch any buttons until the initialization is complete.

When initialization is complete, you can continue to use other maintenance features without exiting.

NOTE

- When initializing the internal memory, all data stored in the memory will be lost. Use caution when performing this operation.
- The internal clock, network settings, and brightness settings are not initialized by this operation.
- If an NY64-D is installed, we recommend you turn the TF series console off and on again so the console will be set up correctly with the connected Dante devices.

Initialize Current Memory screen

Resets the console's current memory to the factory default settings. Scene memory and Libraries are not reset.

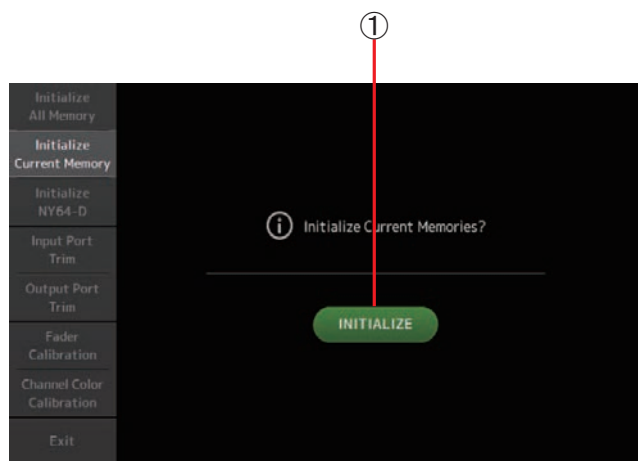

① INITIALIZE button

Initializes the current memory.

The following data is initialized: mixing data and setup data.

Touch to display the confirmation message. Touch the OK button to perform the operation.

Do not touch any buttons until the initialization is complete.

When initialization is complete, you can continue to use other maintenance features without exiting.

NOTE

When initializing the current memory, all data in the current memory will be lost. Use caution when performing this operation.

Initialize NY64-D screen (V3.0 and later)



① INITIALIZE button

Resets the settings of the NY64-D installed in the expansion slot. After initializing, in order to reconfigure the connected Dante device, we recommend first turning the TF series console off and then on again.

NOTE

A NY64-D card will be initialized even if Dante Device Lock has been enabled for it. In this case, Dante Device Lock will be disabled after the card is initialized.

Input Port Trim screen

Allows you to adjust the gain of each INPUT jack in 0.01 dB increments.

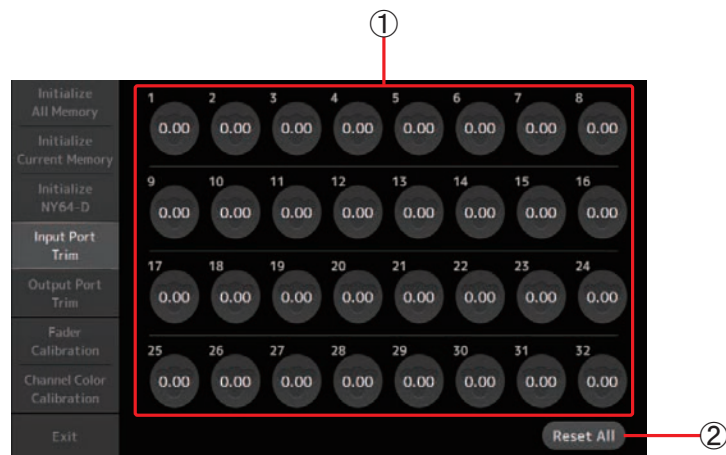

① INPUT jack selection buttons

Select the INPUT jack that you want to configure here.

Select the button that corresponds to the INPUT jack you want to configure, and then use the [TOUCH AND TURN] knob to adjust the value.

After making adjustments, start up the console as usual.

② Reset All button

Resets all values to 0.00 dB. The factory default setting is also 0.00 dB.

Touch to display the confirmation message. Touch the OK button to perform the operation.

NOTE

When the reset is complete, you can continue to use other maintenance features without exiting.

Output Port Trim screen

Allows you to adjust the gain of each OMNI OUT jack in 0.01 dB increments.

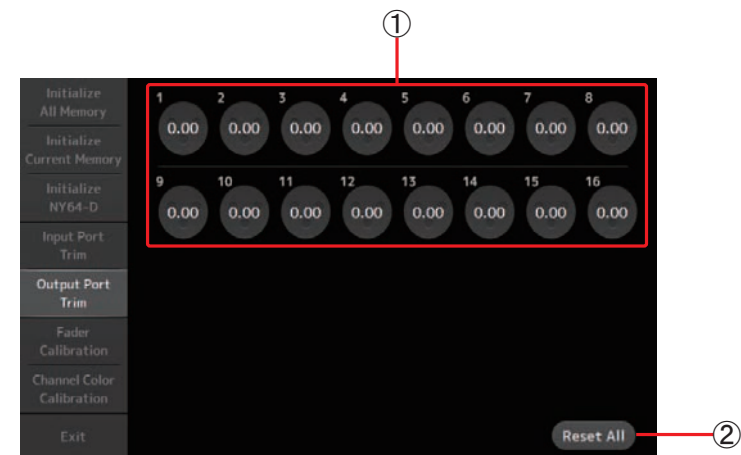

① OMNI OUT jack selection buttons

Select the OMNI OUT jack that you want to configure here.

Select the button that corresponds to the OMNI OUT jack you want to configure, and then use the [TOUCH AND TURN] knob to adjust the value.

After making adjustments, start up the console as usual.

② Reset All button

Resets all values to 0.00 dB. The factory default setting is also 0.00 dB.

Touch to display the confirmation message. Touch the OK button to perform the operation.

NOTE

When the reset is complete, you can continue to use other maintenance features without exiting.

Fader Calibration screen (TF5/TF3/TF1)

In some usage environments, discrepancies may occur in the motion of the motor faders. You can use this screen to correct these discrepancies

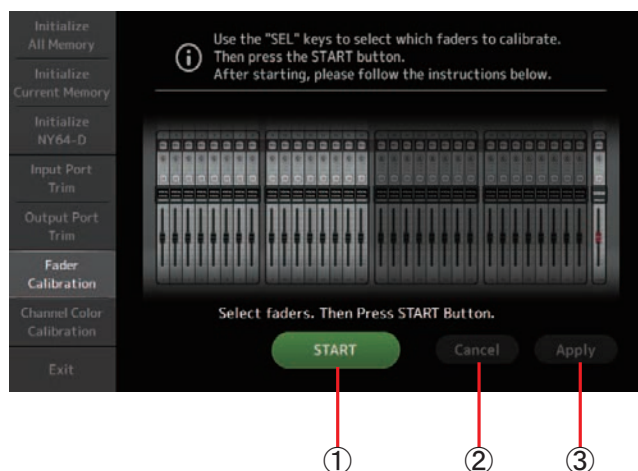

① START button

Starts the calibration.

Touch to display the confirmation message. Touch the OK button to perform the operation.

② Cancel button

Stops the calibration.

③ Apply button

Applies the settings and exits.

Calibrating the faders

1. Press the [SEL] key on the top panel that corresponds to the fader you want to calibrate.
2. Touch the START button on the FADER CALIBRATION MODE screen.
3. Touch the OK button when the confirmation message is displayed.
4. When calibration has finished, touch the APPLY button.
5. Touch the Exit button in the maintenance menu and start up the console as usual.

NOTE

- This feature automatically calibrates the specified fader (channel strip or master section fader).
- When calibration is complete, you can continue to use other maintenance features without exiting.

If a fader must be calibrated again

If a fader must be calibrated again, the [ON] or [CUE] key of the corresponding fader will flash. Use the following procedure to recalibrate.

1. When the message "Found faders requiring adjustment. Please calibrate faders again." is displayed, touch the Close button to close the popup.
2. Touch the Apply button displayed on the screen.
The [SEL] key of the fader that was flashing begins to flash.
3. Slide the corresponding fader to the highest and lowest positions several times.
Make sure the fader's slide action is smooth and not getting stuck.
4. Perform the procedure described in "Calibrating the faders" beginning at step 2.

If you perform this procedure multiple times and the popup message is still displayed, contact your Yamaha dealer.

Channel Color Calibration screen (TF5/TF3/TF1)

You can adjust the colors of the LEDs as desired. LED colors are adjusted one at a time.

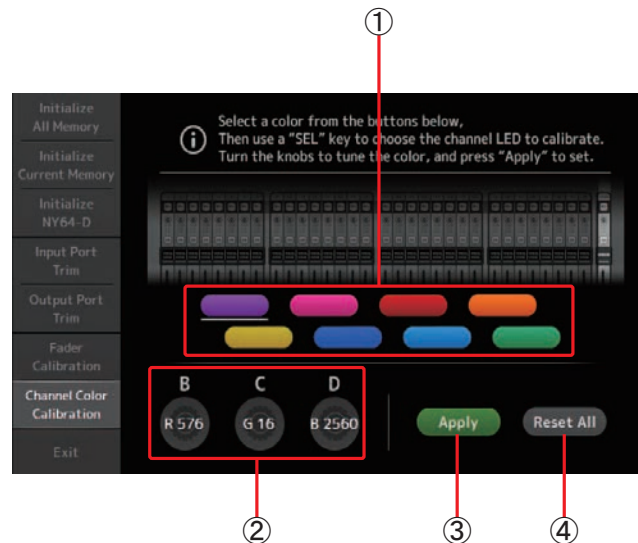

① Color buttons

Allow you to select a color.

② RGB knobs

Allow you to adjust the color.

③ Apply button

Applies the settings and exits.

④ Reset All button

Starts the calibration.

Touch to display the confirmation message. Touch the OK button to perform the operation.

Adjusting channel colors

1. Press the [SEL] key on the top panel that corresponds to the channel color you want to adjust.
2. Touch a color button to choose a color.
3. While comparing the [SEL] you selected with the other indicators on the top panel, use the [TOUCH AND TURN] knob or the [USER DEFINED KNOBS] B, C, and D to adjust the color.
4. When finished, touch the Apply button to apply the settings.
5. Touch the Exit button in the maintenance menu and start up the console as usual.

NOTE

- For TF3 and TF1, channels not supported by the console are not displayed.
- Only one channel color can be adjusted at a time.
- The Apply button is only displayed after you begin adjusting the channel's color.
- To reset all channel color's to their factory default values, touch the Reset All button.
- When the reset is complete, you can continue to use other maintenance features without exiting.

List of parameters saved in Scenes and Presets

CH 1–40

		Channel Library Recall ^{*3}							Scene	Can use Scene Recall Safe						Stereo Link	
		Recall CH				Recall EQ	Recall Gate	Recall Comp		All	HA	Input Select	Processing	Send To	Fader/On		Name
		(All)	(Exclude)														
			HA	Input Select	Name												
HA	Gain	<input type="checkbox"/>		<input type="checkbox"/>	<input type="checkbox"/>			<input type="checkbox"/>	<input type="checkbox"/>	<input type="checkbox"/>					<input type="checkbox"/>		
	+48V	<input type="checkbox"/>		<input type="checkbox"/>	<input type="checkbox"/>			<input type="checkbox"/>	<input type="checkbox"/>	<input type="checkbox"/>							
	Φ	<input type="checkbox"/>		<input type="checkbox"/>	<input type="checkbox"/>			<input type="checkbox"/>	<input type="checkbox"/>	<input type="checkbox"/>							
	Digital Gain	<input type="checkbox"/>		<input type="checkbox"/>	<input type="checkbox"/>			<input type="checkbox"/>	<input type="checkbox"/>	<input type="checkbox"/>					<input type="checkbox"/>		
Input Select		<input type="checkbox"/>	<input type="checkbox"/>		<input type="checkbox"/>			<input type="checkbox"/>	<input type="checkbox"/>		<input type="checkbox"/>				<input type="checkbox"/>		
Channel Name		<input type="checkbox"/>	<input type="checkbox"/>	<input type="checkbox"/>				<input type="checkbox"/>	<input type="checkbox"/>					<input type="checkbox"/>			
Category, Color, Icon		<input type="checkbox"/>	<input type="checkbox"/>	<input type="checkbox"/>				<input type="checkbox"/>	<input type="checkbox"/>					<input type="checkbox"/>	<input type="checkbox"/>		
Stereo Link								<input type="checkbox"/>	<input type="checkbox"/>						<input type="checkbox"/>		
Direct Out ^{*1}	ON	<input type="checkbox"/>	<input type="checkbox"/>	<input type="checkbox"/>	<input type="checkbox"/>			<input type="checkbox"/>	<input type="checkbox"/>						<input type="checkbox"/>		
	Point	<input type="checkbox"/>	<input type="checkbox"/>	<input type="checkbox"/>	<input type="checkbox"/>			<input type="checkbox"/>	<input type="checkbox"/>						<input type="checkbox"/>		
HPF		<input type="checkbox"/>	<input type="checkbox"/>	<input type="checkbox"/>	<input type="checkbox"/>	<input type="checkbox"/>		<input type="checkbox"/>	<input type="checkbox"/>		<input type="checkbox"/>				<input type="checkbox"/>		
PEQ		<input type="checkbox"/>	<input type="checkbox"/>	<input type="checkbox"/>	<input type="checkbox"/>	<input type="checkbox"/>		<input type="checkbox"/>	<input type="checkbox"/>		<input type="checkbox"/>				<input type="checkbox"/>		
GATE ^{*1}		<input type="checkbox"/>	<input type="checkbox"/>	<input type="checkbox"/>	<input type="checkbox"/>		<input type="checkbox"/>	<input type="checkbox"/>	<input type="checkbox"/>		<input type="checkbox"/>				<input type="checkbox"/> ^{*2}		
COMP ^{*1}		<input type="checkbox"/>	<input type="checkbox"/>	<input type="checkbox"/>	<input type="checkbox"/>			<input type="checkbox"/>	<input type="checkbox"/>		<input type="checkbox"/>				<input type="checkbox"/> ^{*2}		
TO AUX	Level							<input type="checkbox"/>	<input type="checkbox"/>			<input type="checkbox"/>			<input type="checkbox"/>		
	Pan							<input type="checkbox"/>	<input type="checkbox"/>								
	ON							<input type="checkbox"/>	<input type="checkbox"/>			<input type="checkbox"/>			<input type="checkbox"/>		
	Pre							<input type="checkbox"/>	<input type="checkbox"/>			<input type="checkbox"/>			<input type="checkbox"/>		
TO FX	Level							<input type="checkbox"/>	<input type="checkbox"/>			<input type="checkbox"/>			<input type="checkbox"/>		
	ON							<input type="checkbox"/>	<input type="checkbox"/>			<input type="checkbox"/>			<input type="checkbox"/>		
	Pre							<input type="checkbox"/>	<input type="checkbox"/>			<input type="checkbox"/>			<input type="checkbox"/>		
TO ST	Assign	<input type="checkbox"/>	<input type="checkbox"/>	<input type="checkbox"/>	<input type="checkbox"/>			<input type="checkbox"/>	<input type="checkbox"/>						<input type="checkbox"/>		
	Pan	<input type="checkbox"/>	<input type="checkbox"/>	<input type="checkbox"/>	<input type="checkbox"/>			<input type="checkbox"/>	<input type="checkbox"/>								
TO SUB	Level	<input type="checkbox"/>	<input type="checkbox"/>	<input type="checkbox"/>	<input type="checkbox"/>			<input type="checkbox"/>	<input type="checkbox"/>			<input type="checkbox"/>			<input type="checkbox"/>		
	ON	<input type="checkbox"/>	<input type="checkbox"/>	<input type="checkbox"/>	<input type="checkbox"/>			<input type="checkbox"/>	<input type="checkbox"/>			<input type="checkbox"/>			<input type="checkbox"/>		
ON								<input type="checkbox"/>	<input type="checkbox"/>				<input type="checkbox"/>		<input type="checkbox"/>		
Fader								<input type="checkbox"/>	<input type="checkbox"/>				<input type="checkbox"/>		<input type="checkbox"/>		
DCA Assign								<input type="checkbox"/>	<input type="checkbox"/>						<input type="checkbox"/>		
Mute Safe															<input type="checkbox"/>		
Recall Safe															<input type="checkbox"/>		
CUE															<input type="checkbox"/>		

*1 CH 1–32 only

*2 Only parameters are linked. (Gain reduction control is not linked.)

*3 Libraries created for CH 1–32 cannot recall to CH 33–40. Similarly, libraries created for CH 33–40 cannot recall to CH 1–32.

ST IN 1, ST IN 2

		Channel Library Recall					Scene	Can use Scene Recall Safe						Stereo Link	
		Recall CH				Recall EQ		All	HA	Input Select	Processing	Send To	Fader/On		Name
		(All)	(Exclude)												
			HA	Input Select	Name										
HA	Φ	<input type="checkbox"/>	<input type="checkbox"/>	<input type="checkbox"/>	<input type="checkbox"/>	<input type="checkbox"/>	<input type="checkbox"/>	<input type="checkbox"/>	<input type="checkbox"/>	<input type="checkbox"/>	<input type="checkbox"/>	<input type="checkbox"/>	<input type="checkbox"/>		
	Digital Gain	<input type="checkbox"/>	<input type="checkbox"/>	<input type="checkbox"/>	<input type="checkbox"/>	<input type="checkbox"/>	<input type="checkbox"/>	<input type="checkbox"/>	<input type="checkbox"/>	<input type="checkbox"/>	<input type="checkbox"/>	<input type="checkbox"/>	<input type="checkbox"/>		
Input Select		<input type="checkbox"/> *1	<input type="checkbox"/> *1	<input type="checkbox"/>	<input type="checkbox"/> *1	<input type="checkbox"/>	<input type="checkbox"/>	<input type="checkbox"/>	<input type="checkbox"/>	<input type="checkbox"/>	<input type="checkbox"/>	<input type="checkbox"/>	<input type="checkbox"/>		
Channel Name		<input type="checkbox"/>	<input type="checkbox"/>	<input type="checkbox"/>	<input type="checkbox"/>	<input type="checkbox"/>	<input type="checkbox"/>	<input type="checkbox"/>	<input type="checkbox"/>	<input type="checkbox"/>	<input type="checkbox"/>	<input type="checkbox"/>	<input type="checkbox"/>		
Category, Color, Icon		<input type="checkbox"/>	<input type="checkbox"/>	<input type="checkbox"/>	<input type="checkbox"/>	<input type="checkbox"/>	<input type="checkbox"/>	<input type="checkbox"/>	<input type="checkbox"/>	<input type="checkbox"/>	<input type="checkbox"/>	<input type="checkbox"/>	<input type="checkbox"/>		
PEQ		<input type="checkbox"/>	<input type="checkbox"/>	<input type="checkbox"/>	<input type="checkbox"/>	<input type="checkbox"/>	<input type="checkbox"/>	<input type="checkbox"/>	<input type="checkbox"/>	<input type="checkbox"/>	<input type="checkbox"/>	<input type="checkbox"/>	<input type="checkbox"/>		
TO AUX	Level	<input type="checkbox"/>	<input type="checkbox"/>	<input type="checkbox"/>	<input type="checkbox"/>	<input type="checkbox"/>	<input type="checkbox"/>	<input type="checkbox"/>	<input type="checkbox"/>	<input type="checkbox"/>	<input type="checkbox"/>	<input type="checkbox"/>	<input type="checkbox"/>		
	Pan	<input type="checkbox"/>	<input type="checkbox"/>	<input type="checkbox"/>	<input type="checkbox"/>	<input type="checkbox"/>	<input type="checkbox"/>	<input type="checkbox"/>	<input type="checkbox"/>	<input type="checkbox"/>	<input type="checkbox"/>	<input type="checkbox"/>	<input type="checkbox"/>		
	ON	<input type="checkbox"/>	<input type="checkbox"/>	<input type="checkbox"/>	<input type="checkbox"/>	<input type="checkbox"/>	<input type="checkbox"/>	<input type="checkbox"/>	<input type="checkbox"/>	<input type="checkbox"/>	<input type="checkbox"/>	<input type="checkbox"/>	<input type="checkbox"/>		
	Pre	<input type="checkbox"/>	<input type="checkbox"/>	<input type="checkbox"/>	<input type="checkbox"/>	<input type="checkbox"/>	<input type="checkbox"/>	<input type="checkbox"/>	<input type="checkbox"/>	<input type="checkbox"/>	<input type="checkbox"/>	<input type="checkbox"/>	<input type="checkbox"/>		
TO FX	Level	<input type="checkbox"/>	<input type="checkbox"/>	<input type="checkbox"/>	<input type="checkbox"/>	<input type="checkbox"/>	<input type="checkbox"/>	<input type="checkbox"/>	<input type="checkbox"/>	<input type="checkbox"/>	<input type="checkbox"/>	<input type="checkbox"/>	<input type="checkbox"/>		
	ON	<input type="checkbox"/>	<input type="checkbox"/>	<input type="checkbox"/>	<input type="checkbox"/>	<input type="checkbox"/>	<input type="checkbox"/>	<input type="checkbox"/>	<input type="checkbox"/>	<input type="checkbox"/>	<input type="checkbox"/>	<input type="checkbox"/>	<input type="checkbox"/>		
	Pre	<input type="checkbox"/>	<input type="checkbox"/>	<input type="checkbox"/>	<input type="checkbox"/>	<input type="checkbox"/>	<input type="checkbox"/>	<input type="checkbox"/>	<input type="checkbox"/>	<input type="checkbox"/>	<input type="checkbox"/>	<input type="checkbox"/>	<input type="checkbox"/>		
TO ST	Assign	<input type="checkbox"/>	<input type="checkbox"/>	<input type="checkbox"/>	<input type="checkbox"/>	<input type="checkbox"/>	<input type="checkbox"/>	<input type="checkbox"/>	<input type="checkbox"/>	<input type="checkbox"/>	<input type="checkbox"/>	<input type="checkbox"/>	<input type="checkbox"/>		
	Balance	<input type="checkbox"/>	<input type="checkbox"/>	<input type="checkbox"/>	<input type="checkbox"/>	<input type="checkbox"/>	<input type="checkbox"/>	<input type="checkbox"/>	<input type="checkbox"/>	<input type="checkbox"/>	<input type="checkbox"/>	<input type="checkbox"/>	<input type="checkbox"/>		
TO SUB	Level	<input type="checkbox"/>	<input type="checkbox"/>	<input type="checkbox"/>	<input type="checkbox"/>	<input type="checkbox"/>	<input type="checkbox"/>	<input type="checkbox"/>	<input type="checkbox"/>	<input type="checkbox"/>	<input type="checkbox"/>	<input type="checkbox"/>	<input type="checkbox"/>		
	ON	<input type="checkbox"/>	<input type="checkbox"/>	<input type="checkbox"/>	<input type="checkbox"/>	<input type="checkbox"/>	<input type="checkbox"/>	<input type="checkbox"/>	<input type="checkbox"/>	<input type="checkbox"/>	<input type="checkbox"/>	<input type="checkbox"/>	<input type="checkbox"/>		
ON		<input type="checkbox"/>	<input type="checkbox"/>	<input type="checkbox"/>	<input type="checkbox"/>	<input type="checkbox"/>	<input type="checkbox"/>	<input type="checkbox"/>	<input type="checkbox"/>	<input type="checkbox"/>	<input type="checkbox"/>	<input type="checkbox"/>	<input type="checkbox"/>		
Fader		<input type="checkbox"/>	<input type="checkbox"/>	<input type="checkbox"/>	<input type="checkbox"/>	<input type="checkbox"/>	<input type="checkbox"/>	<input type="checkbox"/>	<input type="checkbox"/>	<input type="checkbox"/>	<input type="checkbox"/>	<input type="checkbox"/>	<input type="checkbox"/>		
DCA Assign		<input type="checkbox"/>	<input type="checkbox"/>	<input type="checkbox"/>	<input type="checkbox"/>	<input type="checkbox"/>	<input type="checkbox"/>	<input type="checkbox"/>	<input type="checkbox"/>	<input type="checkbox"/>	<input type="checkbox"/>	<input type="checkbox"/>	<input type="checkbox"/>		
Mute Safe		<input type="checkbox"/>	<input type="checkbox"/>	<input type="checkbox"/>	<input type="checkbox"/>	<input type="checkbox"/>	<input type="checkbox"/>	<input type="checkbox"/>	<input type="checkbox"/>	<input type="checkbox"/>	<input type="checkbox"/>	<input type="checkbox"/>	<input type="checkbox"/>		
Recall Safe		<input type="checkbox"/>	<input type="checkbox"/>	<input type="checkbox"/>	<input type="checkbox"/>	<input type="checkbox"/>	<input type="checkbox"/>	<input type="checkbox"/>	<input type="checkbox"/>	<input type="checkbox"/>	<input type="checkbox"/>	<input type="checkbox"/>	<input type="checkbox"/>		
CUE		<input type="checkbox"/>	<input type="checkbox"/>	<input type="checkbox"/>	<input type="checkbox"/>	<input type="checkbox"/>	<input type="checkbox"/>	<input type="checkbox"/>	<input type="checkbox"/>	<input type="checkbox"/>	<input type="checkbox"/>	<input type="checkbox"/>	<input type="checkbox"/>		

*1 Input Select can only recall Libraries for the same channel.

FX 1, FX 2

		Channel Library Recall				Scene	Can use Scene Recall Safe						Stereo Link		
		Recall CH			Recall FX		Recall EQ	With Send*1	All	FX	Processing	Send To		Fader/On	Name
		(All)	(Exclude)												
		FX	Name												
Channel Name		<input type="checkbox"/>	<input type="checkbox"/>			<input type="checkbox"/>		<input type="checkbox"/>					<input type="checkbox"/>	<input type="checkbox"/>	
Category, Color, Icon		<input type="checkbox"/>	<input type="checkbox"/>			<input type="checkbox"/>		<input type="checkbox"/>					<input type="checkbox"/>	<input type="checkbox"/>	
FX		<input type="checkbox"/>		<input type="checkbox"/>	<input type="checkbox"/>	<input type="checkbox"/>		<input type="checkbox"/>	<input type="checkbox"/>				<input type="checkbox"/>	-	
PEQ		<input type="checkbox"/>	<input type="checkbox"/>	<input type="checkbox"/>		<input type="checkbox"/>		<input type="checkbox"/>		<input type="checkbox"/>				<input type="checkbox"/>	
TO AUX	Level					<input type="checkbox"/>		<input type="checkbox"/>			<input type="checkbox"/>			<input type="checkbox"/>	
	Pan					<input type="checkbox"/>		<input type="checkbox"/>							
	ON					<input type="checkbox"/>		<input type="checkbox"/>			<input type="checkbox"/>			<input type="checkbox"/>	
	Pre					<input type="checkbox"/>		<input type="checkbox"/>			<input type="checkbox"/>			<input type="checkbox"/>	
TO ST	Assign	<input type="checkbox"/>	<input type="checkbox"/>	<input type="checkbox"/>		<input type="checkbox"/>		<input type="checkbox"/>						<input type="checkbox"/>	
	Balance	<input type="checkbox"/>	<input type="checkbox"/>	<input type="checkbox"/>		<input type="checkbox"/>		<input type="checkbox"/>						<input type="checkbox"/>	
TO SUB	Level	<input type="checkbox"/>	<input type="checkbox"/>	<input type="checkbox"/>		<input type="checkbox"/>		<input type="checkbox"/>			<input type="checkbox"/>			<input type="checkbox"/>	
	ON	<input type="checkbox"/>	<input type="checkbox"/>	<input type="checkbox"/>		<input type="checkbox"/>		<input type="checkbox"/>			<input type="checkbox"/>			<input type="checkbox"/>	
ON						<input type="checkbox"/>		<input type="checkbox"/>				<input type="checkbox"/>		<input type="checkbox"/>	
Fader						<input type="checkbox"/>		<input type="checkbox"/>				<input type="checkbox"/>		<input type="checkbox"/>	
DCA Assign						<input type="checkbox"/>		<input type="checkbox"/>						<input type="checkbox"/>	
Mute Safe														<input type="checkbox"/>	
Recall Safe														<input type="checkbox"/>	
CUE														<input type="checkbox"/>	

*1 For With Send, TO FX signals from CH 1–40, ST IN 1, and ST IN 2 can be recall safe.

AUX

	Channel Library Recall								Scene	Can use Scene Recall Safe							Stereo Link	
	Recall CH ^{*4}				Recall EQ	Recall GEQ ^{*1}	Recall COMP ^{*1}	Recall FX ^{*2}		With Send	All	FX ^{*2}	GEQ ^{*1}	Processing	Fader/On	Gain/Φ		Name
	(All)	(Exclude)																
	GEQ ^{*1}	FX ^{*2}	Name															
Channel Name	<input type="checkbox"/>	<input type="checkbox"/>	<input type="checkbox"/>					<input type="checkbox"/>		<input type="checkbox"/>					<input type="checkbox"/>	<input type="checkbox"/>		
Category, Color, Icon	<input type="checkbox"/>	<input type="checkbox"/>	<input type="checkbox"/>					<input type="checkbox"/>		<input type="checkbox"/>					<input type="checkbox"/>	<input type="checkbox"/>		
Signal Type ^{*1}								<input type="checkbox"/>		<input type="checkbox"/>						<input type="checkbox"/>		
Pan Link	<input type="checkbox"/>	<input type="checkbox"/>	<input type="checkbox"/>	<input type="checkbox"/>				<input type="checkbox"/>		<input type="checkbox"/>						<input type="checkbox"/>		
PEQ	<input type="checkbox"/>	<input type="checkbox"/>	<input type="checkbox"/>	<input type="checkbox"/>	<input type="checkbox"/>			<input type="checkbox"/>		<input type="checkbox"/>		<input type="checkbox"/>				<input type="checkbox"/>		
GEQ ^{*1}	<input type="checkbox"/>		<input type="checkbox"/>	<input type="checkbox"/>		<input type="checkbox"/>		<input type="checkbox"/>		<input type="checkbox"/>	<input type="checkbox"/>					<input type="checkbox"/>		
COMP	<input type="checkbox"/>	<input type="checkbox"/>	<input type="checkbox"/>	<input type="checkbox"/>			<input type="checkbox"/>	<input type="checkbox"/>		<input type="checkbox"/>		<input type="checkbox"/>				<input type="checkbox"/>		
Ins FX ^{*2}	<input type="checkbox"/>	<input type="checkbox"/>		<input type="checkbox"/>			<input type="checkbox"/>	<input type="checkbox"/>		<input type="checkbox"/>	<input type="checkbox"/>					<input type="checkbox"/>		
TO ST Assign ^{*2}	<input type="checkbox"/>	<input type="checkbox"/>	<input type="checkbox"/>	<input type="checkbox"/>				<input type="checkbox"/>		<input type="checkbox"/>						<input type="checkbox"/>		
TO SUB ^{*2}	Level	<input type="checkbox"/>						<input type="checkbox"/>		<input type="checkbox"/>						<input type="checkbox"/>		
	ON	<input type="checkbox"/>						<input type="checkbox"/>		<input type="checkbox"/>						<input type="checkbox"/>		
ON								<input type="checkbox"/>		<input type="checkbox"/>			<input type="checkbox"/>			<input type="checkbox"/>		
Fader								<input type="checkbox"/>		<input type="checkbox"/>			<input type="checkbox"/>			<input type="checkbox"/>		
Send From	Level							<input type="checkbox"/>	<input type="checkbox"/>							<input type="checkbox"/>		
	Pan							<input type="checkbox"/>	<input type="checkbox"/>							<input type="checkbox"/>		
	ON							<input type="checkbox"/>	<input type="checkbox"/>							<input type="checkbox"/>		
	Pre							<input type="checkbox"/>	<input type="checkbox"/>							<input type="checkbox"/>		
OUTPUT	Balance	<input type="checkbox"/>	<input type="checkbox"/>	<input type="checkbox"/>	<input type="checkbox"/>			<input type="checkbox"/>		<input type="checkbox"/>						<input type="checkbox"/>		
	Out Gain	<input type="checkbox"/>	<input type="checkbox"/>	<input type="checkbox"/>	<input type="checkbox"/>			<input type="checkbox"/>		<input type="checkbox"/>				<input type="checkbox"/>		<input type="checkbox"/>		
	Φ	<input type="checkbox"/>	<input type="checkbox"/>	<input type="checkbox"/>	<input type="checkbox"/>			<input type="checkbox"/>		<input type="checkbox"/>				<input type="checkbox"/>		<input type="checkbox"/>		
Recall Safe															<input type="checkbox"/>			
CUE															<input type="checkbox"/>			

*1 AUX 1–8 only

*2 AUX 9/10–19/20 only

*3 Only when L/R LINK for GEQ is turned on

*4 Libraries created for AUX 1–8 cannot recall to AUX 9/10–19/20. Similarly, libraries created for AUX 9/10–19/20 cannot recall to AUX 1–8.

STEREO, SUB

	Channel Library Recall						Scene	Can use Scene Recall Safe						Stereo Link ^{*1}	
	Recall CH			Recall EQ	Recall GEQ ^{*1}	Recall COMP		With Send ^{*2}	All	GEQ ^{*1}	Processing	Fader/On	Gain/ Φ		Name
	(All)	(Exclude)													
		GEQ ^{*1}	Name												
Channel Name	<input type="checkbox"/>	<input type="checkbox"/>				<input type="checkbox"/>		<input type="checkbox"/>				<input type="checkbox"/>	<input type="checkbox"/>		
Category, Color, Icon	<input type="checkbox"/>	<input type="checkbox"/>				<input type="checkbox"/>		<input type="checkbox"/>				<input type="checkbox"/>	<input type="checkbox"/>		
LPF ^{*2}	<input type="checkbox"/>					<input type="checkbox"/>		<input type="checkbox"/>	<input type="checkbox"/>						
PEQ	<input type="checkbox"/>	<input type="checkbox"/>	<input type="checkbox"/>	<input type="checkbox"/>		<input type="checkbox"/>		<input type="checkbox"/>	<input type="checkbox"/>				<input type="checkbox"/>		
GEQ ^{*1}	<input type="checkbox"/>		<input type="checkbox"/>		<input type="checkbox"/>	<input type="checkbox"/>		<input type="checkbox"/>	<input type="checkbox"/>				<input type="checkbox"/> ^{*3}		
COMP	<input type="checkbox"/>	<input type="checkbox"/>	<input type="checkbox"/>			<input type="checkbox"/>		<input type="checkbox"/>	<input type="checkbox"/>				<input type="checkbox"/>		
ON						<input type="checkbox"/>		<input type="checkbox"/>		<input type="checkbox"/>			<input type="checkbox"/>		
Fader						<input type="checkbox"/>		<input type="checkbox"/>		<input type="checkbox"/>			<input type="checkbox"/>		
STEREO/SUB Level Link ^{*2}						<input type="checkbox"/>		<input type="checkbox"/> ^{*2}		<input type="checkbox"/> ^{*2}			-		
Send From ^{*2}	Level					<input type="checkbox"/>	<input type="checkbox"/>						<input type="checkbox"/>		
	ON					<input type="checkbox"/>	<input type="checkbox"/>						<input type="checkbox"/>		
OUTPUT	Balance ^{*1}	<input type="checkbox"/>	<input type="checkbox"/>	<input type="checkbox"/>		<input type="checkbox"/>		<input type="checkbox"/>					<input type="checkbox"/>		
	Out Gain	<input type="checkbox"/>	<input type="checkbox"/>	<input type="checkbox"/>		<input type="checkbox"/>		<input type="checkbox"/>			<input type="checkbox"/>		<input type="checkbox"/>		
	Φ	<input type="checkbox"/>	<input type="checkbox"/>	<input type="checkbox"/>		<input type="checkbox"/>		<input type="checkbox"/>			<input type="checkbox"/>		<input type="checkbox"/>		
Recall Safe													<input type="checkbox"/>		
CUE													<input type="checkbox"/>		

*1 STEREO only

*2 SUB only

*3 Only when L/R LINK for GEQ is turned on

*4 Libraries created for STEREO cannot recall CH/EQ to SUB. Similarly, libraries created for SUB cannot recall CH/EQ to STEREO.

MATRIX (V2.5 and later)

		Channel Library Recall			Scene	Can use Scene Recall Safe							Stereo Link	
		Recall CH		Recall EQ		With Send	All	FX	GEQ	Processing	Fader/On	Gain/ Φ		Name
		(All)	(Exclude) Name											
Channel Name		<input type="checkbox"/>			<input type="checkbox"/>	<input type="checkbox"/>						<input type="checkbox"/>		
Category, Color, Icon		<input type="checkbox"/>			<input type="checkbox"/>	<input type="checkbox"/>						<input type="checkbox"/>		
PEQ		<input type="checkbox"/>	<input type="checkbox"/>	<input type="checkbox"/>	<input type="checkbox"/>	<input type="checkbox"/>			<input type="checkbox"/>					
DELAY		<input type="checkbox"/>	<input type="checkbox"/>		<input type="checkbox"/>	<input type="checkbox"/>			<input type="checkbox"/>					
ON					<input type="checkbox"/>	<input type="checkbox"/>				<input type="checkbox"/>				
Fader					<input type="checkbox"/>	<input type="checkbox"/>				<input type="checkbox"/>				
Send From	Level				<input type="checkbox"/>	<input type="checkbox"/>								
	ON				<input type="checkbox"/>	<input type="checkbox"/>								
OUTPUT	Out Gain	<input type="checkbox"/>	<input type="checkbox"/>		<input type="checkbox"/>	<input type="checkbox"/>					<input type="checkbox"/>			
	Φ	<input type="checkbox"/>	<input type="checkbox"/>		<input type="checkbox"/>	<input type="checkbox"/>					<input type="checkbox"/>			
Recall Safe														
CUE														

DCA

	Scene	Can use Scene Recall Safe		
		All	Fader/On	Name
Channel Name	<input type="checkbox"/>	<input type="checkbox"/>		<input type="checkbox"/>
Category, Color, Icon	<input type="checkbox"/>	<input type="checkbox"/>		<input type="checkbox"/>
ON	<input type="checkbox"/>	<input type="checkbox"/>	<input type="checkbox"/>	
Fader	<input type="checkbox"/>	<input type="checkbox"/>	<input type="checkbox"/>	
DCA Assign	<input type="checkbox"/>	<input type="checkbox"/>		
Recall Safe				
CUE				

OMNI OUT

	Scene	Can use Scene Recall Safe
OMNI OUT Patch	<input type="checkbox"/>	<input type="checkbox"/> (All OMNI OUT)

Access limitation parameter list

CH1-40

		HA	Input Select	Processing	Send To	Fader/ON	Name	Other
CH1-40	High Level	O	O	O	O	O	O	O
	Mid Level	O	O	O	O	O	X	O
	Low Level	X	X	X	X	O	X	X

ST IN

		HA	Input Select	Processing	Send To	Fader/ON	Name	Other
ST IN 1-2	High Level	O	O	O	O	O	O	O
	Mid Level	O	X	O	O	O	X	O
	Low Level	X	X	X	X	O	X	X

FX RTN

		With Send	FX	Processing	Send To	Fader/ON	Name	Other
FX RTN 1-2	High Level	O	O	O	O	O	O	O
	Mid Level	O	O	O	O	O	X	X
	Low Level	X	X	X	X	O	X	X

DCA

		Fader/ON	Name	DCA Assign
DCA 1-8	High Level	O	O	O
	Mid Level	O	X	X
	Low Level	O	X	X

OUTPUT

		With Send	FX	GEQ	Processing	Fader/ON	Gain/ Φ	Name	Other
AUX1-8	High Level	O	–	O	O	O	O	O	O
	Mid Level	O	–	O	O	O	X	X	O
	Low Level	X	–	X	X	O	X	X	X
AUX9/10-19/20	High Level	O	O	–	O	O	O	O	O
	Mid Level	O	O	–	O	O	X	X	O
	Low Level	X	X	–	X	O	X	X	X
STEREO	High Level	–	–	O	O	O	O	O	O
	Mid Level	–	–	X	X	O	X	X	X
	Low Level	–	–	X	X	O	X	X	X
SUB	High Level	O	–	–	O	O	O	O	–
	Mid Level	O	–	–	X	O	X	X	–
	Low Level	X	–	–	X	O	X	X	–
MATRIX1-4	High Level	O	–	–	O	O	O	O	–
	Mid Level	X	–	–	X	X	X	X	–
	Low Level	X	–	–	X	X	X	X	–

GENERAL

		High Level	Mid Level	Low Level
Scene A	Store	O	O	X
	Recall	O	O	O
Scene B	Store	O	O	X
	Recall	O	O	O
Library A	Store	O	O	X
	Recall	O	O	X
Library B	Store	O	O	X
	Recall	O	O	X
Setup	+48V Master	O	X	X
	Bus Setup	O	O	X
	Brightness	O	O	O
	Custom Fader Bank	O	O	X
	File Load	O	X	X
	Network	X	X	X
	OMNI OUT Patch	O	X	X
	Preference	O	O	O
	Recall Safe	O	X	X
	Slot Setup	O	X	X
	Time	X	X	X
User Defined Control	O	X	X	
Other	Monitor Delay	O	X	X
	Mute Safe	O	X	X
	Oscillator	O	O	X
	Stereo Link	O	O	X

Quick Config Input and input channel relationships

Tio1608-D: TF INPUT	SLOT: TF INPUT CHANNEL	
Tio1608-D UNIT ID 1: INPUT1	SLOT IN 1	CH1 Input Select
Tio1608-D UNIT ID 1: INPUT2	SLOT IN 2	CH2 Input Select
Tio1608-D UNIT ID 1: INPUT3	SLOT IN 3	CH3 Input Select
Tio1608-D UNIT ID 1: INPUT4	SLOT IN 4	CH4 Input Select
Tio1608-D UNIT ID 1: INPUT5	SLOT IN 5	CH5 Input Select
Tio1608-D UNIT ID 1: INPUT6	SLOT IN 6	CH6 Input Select
Tio1608-D UNIT ID 1: INPUT7	SLOT IN 7	CH7 Input Select
Tio1608-D UNIT ID 1: INPUT8	SLOT IN 8	CH8 Input Select
Tio1608-D UNIT ID 1: INPUT9	SLOT IN 9	CH9 Input Select
Tio1608-D UNIT ID 1: INPUT10	SLOT IN 10	CH10 Input Select
Tio1608-D UNIT ID 1: INPUT11	SLOT IN 11	CH11 Input Select
Tio1608-D UNIT ID 1: INPUT12	SLOT IN 12	CH12 Input Select
Tio1608-D UNIT ID 1: INPUT13	SLOT IN 13	CH13 Input Select
Tio1608-D UNIT ID 1: INPUT14	SLOT IN 14	CH14 Input Select
Tio1608-D UNIT ID 1: INPUT15	SLOT IN 15	CH15 Input Select
Tio1608-D UNIT ID 1: INPUT16	SLOT IN 16	CH16 Input Select
Tio1608-D UNIT ID 2: INPUT1	SLOT IN 17	CH17 Input Select
Tio1608-D UNIT ID 2: INPUT2	SLOT IN 18	CH18 Input Select
Tio1608-D UNIT ID 2: INPUT3	SLOT IN 19	CH19 Input Select
Tio1608-D UNIT ID 2: INPUT4	SLOT IN 20	CH20 Input Select
Tio1608-D UNIT ID 2: INPUT5	SLOT IN 21	CH21 Input Select
Tio1608-D UNIT ID 2: INPUT6	SLOT IN 22	CH22 Input Select
Tio1608-D UNIT ID 2: INPUT7	SLOT IN 23	CH23 Input Select
Tio1608-D UNIT ID 2: INPUT8	SLOT IN 24	CH24 Input Select
Tio1608-D UNIT ID 2: INPUT9	SLOT IN 25	CH25 Input Select
Tio1608-D UNIT ID 2: INPUT10	SLOT IN 26	CH26 Input Select
Tio1608-D UNIT ID 2: INPUT11	SLOT IN 27	CH27 Input Select
Tio1608-D UNIT ID 2: INPUT12	SLOT IN 28	CH28 Input Select
Tio1608-D UNIT ID 2: INPUT13	SLOT IN 29	CH29 Input Select
Tio1608-D UNIT ID 2: INPUT14	SLOT IN 30	CH30 Input Select
Tio1608-D UNIT ID 2: INPUT15	SLOT IN 31	CH31 Input Select
Tio1608-D UNIT ID 2: INPUT16	SLOT IN 32	CH32 Input Select
Tio1608-D UNIT ID 3: INPUT1* ¹	SLOT IN 33	CH33 Input Select* ¹
Tio1608-D UNIT ID 3: INPUT2* ¹	SLOT IN 34	CH34 Input Select* ¹
Tio1608-D UNIT ID 3: INPUT3* ¹	SLOT IN 35	CH35 Input Select* ¹
Tio1608-D UNIT ID 3: INPUT4* ¹	SLOT IN 36	CH36 Input Select* ¹
Tio1608-D UNIT ID 3: INPUT5* ¹	SLOT IN 37	CH37 Input Select* ¹
Tio1608-D UNIT ID 3: INPUT6* ¹	SLOT IN 38	CH38 Input Select* ¹
Tio1608-D UNIT ID 3: INPUT7* ¹	SLOT IN 39	CH39 Input Select* ¹
Tio1608-D UNIT ID 3: INPUT8* ¹	SLOT IN 40	CH40 Input Select* ¹

*1 No connection for TF1, TF-RACK.

TF OUTPUT CHANNEL: SLOT		Tio1608-D: TF OUTPUT
CH1 Direct Out	SLOT OUT 1	No connection
CH2 Direct Out	SLOT OUT 2	No connection
CH3 Direct Out	SLOT OUT 3	No connection
CH4 Direct Out	SLOT OUT 4	No connection
CH5 Direct Out	SLOT OUT 5	No connection
CH6 Direct Out	SLOT OUT 6	No connection
CH7 Direct Out	SLOT OUT 7	No connection
CH8 Direct Out	SLOT OUT 8	No connection
CH9 Direct Out	SLOT OUT 9	No connection
CH10 Direct Out	SLOT OUT 10	No connection
CH11 Direct Out	SLOT OUT 11	No connection
CH12 Direct Out	SLOT OUT 12	No connection
CH13 Direct Out	SLOT OUT 13	No connection
CH14 Direct Out	SLOT OUT 14	No connection
CH15 Direct Out	SLOT OUT 15	No connection
CH16 Direct Out	SLOT OUT 16	No connection
CH17 Direct Out	SLOT OUT 17	No connection
CH18 Direct Out	SLOT OUT 18	No connection
CH19 Direct Out	SLOT OUT 19	No connection
CH20 Direct Out	SLOT OUT 20	No connection
CH21 Direct Out	SLOT OUT 21	No connection
CH22 Direct Out	SLOT OUT 22	No connection
CH23 Direct Out	SLOT OUT 23	No connection
CH24 Direct Out	SLOT OUT 24	No connection
CH25 Direct Out	SLOT OUT 25	No connection
CH26 Direct Out	SLOT OUT 26	No connection
CH27 Direct Out	SLOT OUT 27	No connection
CH28 Direct Out	SLOT OUT 28	No connection
CH29 Direct Out	SLOT OUT 29	No connection
CH30 Direct Out	SLOT OUT 30	No connection
CH31 Direct Out	SLOT OUT 31	No connection
CH32 Direct Out	SLOT OUT 32	No connection
AUX1 Output	SLOT OUT 33	Tio1608-D UNIT ID 1: OUTPUT1
AUX2 Output	SLOT OUT 34	Tio1608-D UNIT ID 1: OUTPUT2
AUX3 Output	SLOT OUT 35	Tio1608-D UNIT ID 1: OUTPUT3
AUX4 Output	SLOT OUT 36	Tio1608-D UNIT ID 1: OUTPUT4
AUX5 Output	SLOT OUT 37	Tio1608-D UNIT ID 1: OUTPUT5
AUX6 Output	SLOT OUT 38	Tio1608-D UNIT ID 1: OUTPUT6
AUX7 Output	SLOT OUT 39	Tio1608-D UNIT ID 2: OUTPUT1
AUX8 Output	SLOT OUT 40	Tio1608-D UNIT ID 2: OUTPUT2

Tio1608-D: TF INPUT	SLOT: TF INPUT CHANNEL	
No connection	SLOT IN 41	No connection
No connection	SLOT IN 42	No connection
No connection	SLOT IN 43	No connection
No connection	SLOT IN 44	No connection
No connection	SLOT IN 45	No connection
No connection	SLOT IN 46	No connection
No connection	SLOT IN 47	No connection
No connection	SLOT IN 48	No connection
No connection	SLOT IN 49	No connection
No connection	SLOT IN 50	No connection
No connection	SLOT IN 51	No connection
No connection	SLOT IN 52	No connection
No connection	SLOT IN 53	No connection
No connection	SLOT IN 54	No connection
No connection	SLOT IN 55	No connection
No connection	SLOT IN 56	No connection
No connection	SLOT IN 57	No connection
No connection	SLOT IN 58	No connection
No connection	SLOT IN 59	No connection
No connection	SLOT IN 60	No connection
No connection	SLOT IN 61	No connection
No connection	SLOT IN 62	No connection
No connection	SLOT IN 63	ST IN 2L Input Select
No connection	SLOT IN 64	ST IN 2R Input Select

TF OUTPUT CHANNEL: SLOT		Tio1608-D: TF OUTPUT
AUX9 Output	SLOT OUT 41	Tio1608-D UNIT ID 2: OUTPUT3
AUX10 Output	SLOT OUT 42	Tio1608-D UNIT ID 2: OUTPUT4
AUX11 Output	SLOT OUT 43	Tio1608-D UNIT ID 2: OUTPUT5
AUX12 Output	SLOT OUT 44	Tio1608-D UNIT ID 2: OUTPUT6
AUX13 Output	SLOT OUT 45	Tio1608-D UNIT ID 3: OUTPUT1
AUX14 Output	SLOT OUT 46	Tio1608-D UNIT ID 3: OUTPUT2
AUX15 Output	SLOT OUT 47	Tio1608-D UNIT ID 3: OUTPUT3
AUX16 Output	SLOT OUT 48	Tio1608-D UNIT ID 3: OUTPUT4
AUX17 Output	SLOT OUT 49	Tio1608-D UNIT ID 3: OUTPUT5
AUX18 Output	SLOT OUT 50	Tio1608-D UNIT ID 3: OUTPUT6
AUX19 Output	SLOT OUT 51	Tio1608-D UNIT ID 3: OUTPUT7
AUX20 Output	SLOT OUT 52	Tio1608-D UNIT ID 3: OUTPUT8
MATRIX1 OUT (V2.5 and later)	SLOT OUT 53	No connection
MATRIX2 OUT (V2.5 and later)	SLOT OUT 54	No connection
MATRIX3 OUT (V2.5 and later)	SLOT OUT 55	No connection
MATRIX4 OUT (V2.5 and later)	SLOT OUT 56	No connection
STEREO L Output	SLOT OUT 57	Tio1608-D UNIT ID 1: OUTPUT7, Tio1608-D UNIT ID 2: OUTPUT7
STEREO R Output	SLOT OUT 58	Tio1608-D UNIT ID 1: OUTPUT8 Tio1608-D UNIT ID 2: OUTPUT8
SUB Output	SLOT OUT 59	No connection
No connection	SLOT OUT 60	No connection
MONITOR L Output	SLOT OUT 61	No connection
MONITOR R Output	SLOT OUT 62	No connection
No connection	SLOT OUT 63	No connection
No connection	SLOT OUT 64	No connection

* When quick config is turned off, this table also applies for mixer SLOT channels.

Warnings and error messages

Message	Description
Item Already Exists. Replace it?	Displayed when you are about to store (overwrite) a Library.
File Already Exists, Replace it?	When using Save As, the name of the file you tried to save was the same name as an existing file. Displayed when you are about to save (overwrite) data.
Exceed Maximum Number! Library A:XXXX items, Library B:XXXX items	The Library exceeds the maximum number of items and cannot be loaded.
File System is Not Ready. This Operation can Overwrite Existing Files or Directories.	You tried to start recording immediately after connecting a USB storage device (i.e., while a list was being generated). You tried to change the name of a file or directory.
Over Current Error! This USB Device is Not Supported. Please Disconnect.	The USB device was disconnected because overcurrent was detected in the USB connection.
Tio OUTPUT is in Use by Another TF. "with OUTPUT" in Quick Config is Turned off.	The OUTPUT of the Tio1608-D is already in use by a console using Quick Config, therefore the "with OUTPUT" in Quick Config was turned off for this console.
Operation Failed!	An error occurred during the operation. (This is a general error.) Less severe than "Unknown". (Between "Unknown" and "Ignore".)
Invalid Name!	Name violates naming convention.
Operation Ignored.	The feature assigned to the knob was not operated. The operation had no effect. This message refers to Tips operations for User Defined Knobs. This message is displayed when the feature assigned to a User Defined Knob cannot be operated.
SCENE #XX is Empty!	No data is stored in the Scene you tried to recall, or the data is damaged.
SCENE #XX is Read Only!	You tried to overwrite a Scene that is write-protected.
Cannot Store!	Could not save the data in the Scene memory or in the Library.
Cannot Recall!	Could not recall the data from the Scene memory or from the Library.
Operation Failed. Library X Memory Full.	You tried to add data when the memory was full. A or B will be entered into X.
Wrong Word Clock! (Slot)	The sample rate setting of the NY64-D is incorrect, therefore it cannot sync with the console.
Turn Off 1-knob Mode to Adjust.	1-knob mode is enabled; turn 1-knob mode off.
Nothing to Paste!	You tried to paste data when the copy buffer was empty.
Cannot Bookmark This Screen.	You tried to bookmark a screen that cannot be bookmarked.
Page Does not Exist.	
Cannot Close This Popup.	
Not Bookmarked.	The item is not bookmarked.
File Busy! Operation Denied.	The operation could not be performed because the USB memory was being accessed.

Message	Description
Unsupported File Format!	You tried to read an unsupported file format from the USB memory.
Storage Not Found!	The USB memory could not be recognized.
Couldn't Write File.	The file could not be saved to the USB memory.
File Protected!	Could not overwrite the file on the USB memory because the file is write-protected.
Already Exists!	The name of the directory you tried to create matches the name of an existing directory. This message may also be displayed when editing a file or directory name.
Couldn't Access File.	Could not access the file on the USB memory for some reason.
File Error!	An internal file access error occurred.
Format Error!	An error occurred during formatting.
USB Storage Unmounted! Recorder Stopped.	Recording stopped because the USB memory was removed during recording.
USB Storage Full! Recorder Stopped.	Recording stopped because the USB memory became full during recording.
Maximum Number of Audio Files Exceeded!	The number of files supported by the USB recorder was exceeded.
USB Storage Busy: Recorder Stopped!	Recording or playback stopped because time is required for a USB storage device process.
Illegal Storage Format! Format USB Device with the Other USB Port.	A USB memory device with an allocation unit size under 4096 bytes was connected. If you record in this situation, the format may become damaged.
Low Battery!	The backup battery's voltage is low.
Illegal IP Address!	The IP address setting or gateway setting is incorrect.
USB Sample Rate Mismatch on USB. Console:44100Hz	The same rates of the console and the computer that is connected to the USB TO HOST connector are different. (Console: 44.1 kHz, PC; 44.1kHz) Set the sample rate of the computer to 44.1 kHz.
USB Sample Rate Mismatch on USB. Console:48000Hz	The same rates of the console and the computer that is connected to the USB TO HOST connector are different. (Console: 48kHz, PC; 44.1kHz) Set the sample rate of the computer to 48kHz.
Two or More Devices Have Same Unit ID!	Two or more devices connected to the NY64-D via the Dante network have the same UNIT ID.
Dante Module Error!	An error occurred with the Dante module of the NY64-D or Tio1608-D.
Illegal Dante Module MAC Address!	The MAC address of the NY64-D is damaged and communication is not possible.
Dante Module Memory Error!	An memory error occurred with the Dante module of the Tio1608-D.
Dante Audio Resource Overflow	An excessive amount of audio data was sent over the Dante network connected to the NY64-D.

Message	Description
Under Synchronization	Settings are being performed for a Tio1608-D on the Dante network connected to the NY64-D. When the Tio1608-D is in Resume mode, this message may be displayed continuously on the SLOT SETUP screen. This is not a malfunction.
Wrong Word Clock! (Dante Device)	The sample rate setting of a device on the Dante network connected to the NY64-D is incorrect, therefore the device cannot sync to the NY64-D.
Linked at 10/100Mbps. Check Cables or Switches.	A switch or cable that does not support Gigabit Ethernet is connected to the Dante network connected to the NY64-D.
Error on the Dante Primary Port	When using a redundancy network, an error has occurred on the PRIMARY network and the SECONDARY network is being used.
Error on the Dante Secondary Port	When using a redundancy network, an error has occurred on the SECONDARY network.
Dante Patch or Setting Modified	A setting that is different from the values determined by Quick Config has been set, perhaps by Dante Controller.
Dante Setting Mismatch	The UNIT ID switch on the Tio1608-D panel does not match the actual unit ID. This is displayed when you change the Tio1608-D's UNIT ID while the Tio1608-D is locked using Dante Device Lock, or when you change the switch after turning the unit on.
Restart Tio to Complete Quick Config	The Tio1608-D Device Config or other settings do not equal Quick Config values. Restart the Tio1608-D.
No Option Card Installed	There is no NY64-D card installed in the expansion slot. This message is displayed when the Quick Config button is ON and there is no NY64-D card installed.
TF Controls First 24 Dante Devices Found	The maximum number of I/O Racks (Tio1608-D, R series, etc.) on the Dante network connected to the NY64-D has been exceeded.
TF Controls HAs of Maximum of 8 Dante Devices	The maximum number of Dante devices with HA on the Dante network connected to the NY64-D has been exceeded.
Unknown Option Card Installed!	An unsupported card has been found in the console's expansion slot.
Overcurrent Detected (Slot)	Overcurrent was detected in the card installed in the expansion slot.
Slot Communication Error!	A communication error occurred in the card installed in the expansion slot.
Dante Module Restarted!	The Dante module of the NY64-D was restarted.
Dante Setting Error! Please Restart the Console.	An error occurred in the Dante module of the NY64-D that requires you to restart the console. If this message is displayed, restart the console.
Dante I/O Device Disconnected	A Dante device was disconnected from the NY64-D.
Two or More HA Controllers may Cause Conflict	More than one device on the Dante network can control the same device's HA, therefore operational conflicts may occur. This message is displayed every time the HA Control on the SLOT SETUP screen is turned on, but it does not indicate a malfunction.

Message	Description
Dante devices are locked. Use Dante Controller to unlock devices.	This is displayed when you touch the Quick Config button while the Tio1608-D or NY64-D are locked using Dante Device Lock. In this case, patching is not performed automatically by Quick Config, but it does not indicate a malfunction. Dante Controller (v3.10.0.19 and later) is required to unlock the devices.
Permission Denied!	The user does not have permission to perform the operation, therefore the operation was ignored.
Operation ignored, you are not logged-in.	The user is not logged in, therefore the operation cannot be performed.
Incorrect password entered.	The password that was entered is incorrect.

Numerics

1-knob COMP	55
1-knob EQ	50
Intensity	50
Loudness	50
Vocal.....	50

A

ACCESS PERMISSION screen	39
ASSIGN screen	63
Audio file.....	14
Auto CH Select.....	28
AUX1–AUX8 channels	43
AUX9/10–19/20 channels.....	43
AUX9/10–AUX19/20.....	7

C

CH STRIP section	42
CH VIEW screen	64
Channel Color Calibration screen ...	83
COMP screen	55
Configuration screens	5, 47
CUE	18
CUSTOM FADER BANK screen menu	34

D

Daylight saving time (summer time)	36
DCA ASSIGN screen	76
DCA group.....	76
DELAY screen.....	78
Digital gain.....	48
Direct out	65
Displaying configuration screens.....	11

E

EQ screen	49
EQ screen menu	53

F

Fader Calibration screen.....	82
FADER section	44
File information	17
Footswitch.....	31
FX screen (FX1/2, InsFX1–6)	57

G

GainFinder	47
GATE screen	53
Gateway	36
GEQ screen	72
Group channels.....	44

I

Initialize (internal memory)	79
Initialize (NY64-D).....	80
Initialize All Memory screen	79
Initialize Current Memory screen ...	80
Input channels.....	42
Input Port Trim screen	81
INPUT screen	47
Internal clock.....	36
IP address.....	36

K

Keyboard screen.....	10
----------------------	----

L

Level meter	13
Library	8
Library screen	8
License information	38
LOGIN screen	38

M

Maintenance screen.....	79
MATRIX1–MATRIX4 channels	43
Menu	10
METER screen.....	13
Metering point	13
Monitor	18
MONITOR screen	18
MP3.....	14

O

OMNI OUT.....	22
OMNI OUT screen menu	22
Oscillator.....	20
Output Port Trim screen	81
OUTPUT screen	74
OVERVIEW screen	42
OVERVIEW screen operations.....	44

P

Peak Hold.....	13
Phantom power	48
Phase	48
PHONES jack	19
Playback	14
Playback mode	17
Preset	8

R

Recall on/off checkboxes.....	8
RECORDER screen (INPUT/ OUTPUT/TITLE LIST screen)	14
RECORDER screen menu	18
Recording	14
RTA display	72

S

SAVE/LOAD screen menu	26
Scene	11
SCENE screen	11
SCENE screen menu	13
SEND FROM screen	75
Send pan	75
SEND TO AUX screen	62
SETUP screen.....	21
Stereo channels.....	42
Stereo link.....	47
SUB channels	43
Subnet mask.....	36

T

Time stamp	37
Toolbar	11

U

USER ACCOUNT screen.....	39
USER DEFINED KEYS	29
USER DEFINED KNOBS	29

V

Version information	38
---------------------------	----

W

Warnings and error messages	94
WAV	14

■ Operations and settings

A

- Access
 - Applying access permissions 40

B

- Button and slider operations..... 10

C

- Checking the input signals 19
- Copying and pasting channel settings..... 45
- CUSTOM FADER BANK
 - Recalling..... 34
- Custom fader bank
 - Configuring 34

D

- DCA groups
 - Assigning channels..... 77

E

- Editing a Preset..... 9
- Editing a Scene 12
- EQ
 - 1-knob EQ mode 51
 - GEQ..... 73
 - HPF 52
 - LPF 52
 - Manual mode..... 51

F

- Feature assignments
 - Assigning to footswitch..... 33
 - Assigning to [USER DEFINED KEYS]..... 32
 - Assigning to [USER DEFINED KNOBS]..... 33

P

- Playback
 - Files on USB storage device 18

R

- Recall safe
 - Using recall safe..... 25
- Recalling a Preset..... 9
- Recalling a Scene 12
- Recording
 - Recording..... 17

S

- Setting
 - Adjust the send level 75
 - Channel colors 83
 - Compressor..... 56
 - Effects 58
 - Fader calibration 82
 - Gate 54
 - Input 15
 - Insert effects..... 58
 - Oscillator 20
 - Output 16
 - PREFERENCE screen..... 29
 - SEND FROM level 75
 - SEND TO AUX level 63
 - Stereo link, input source..... 48

TF5

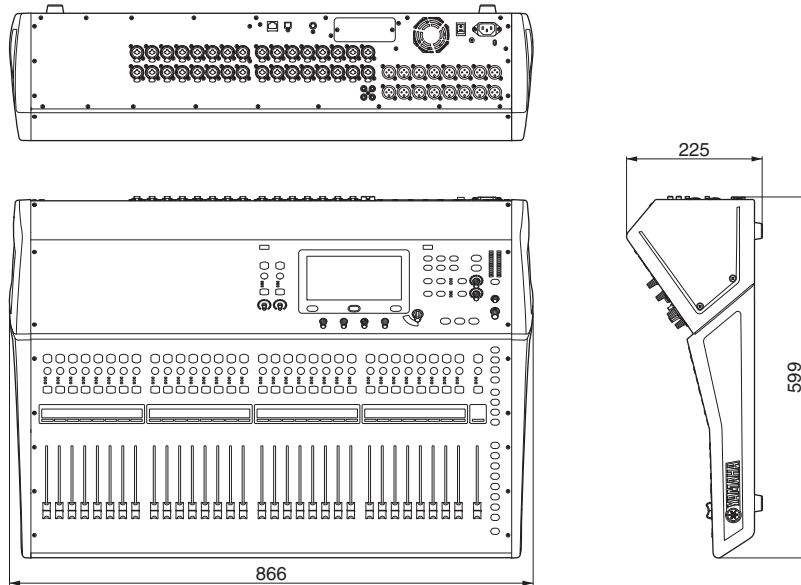

TF3

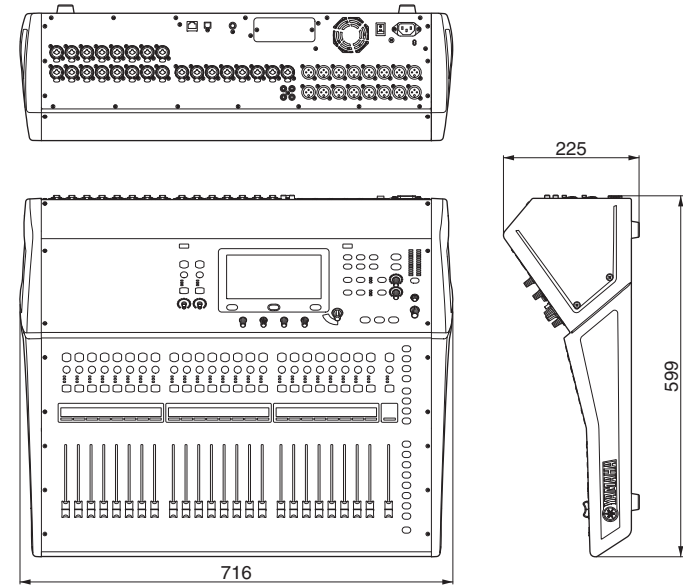

TF1

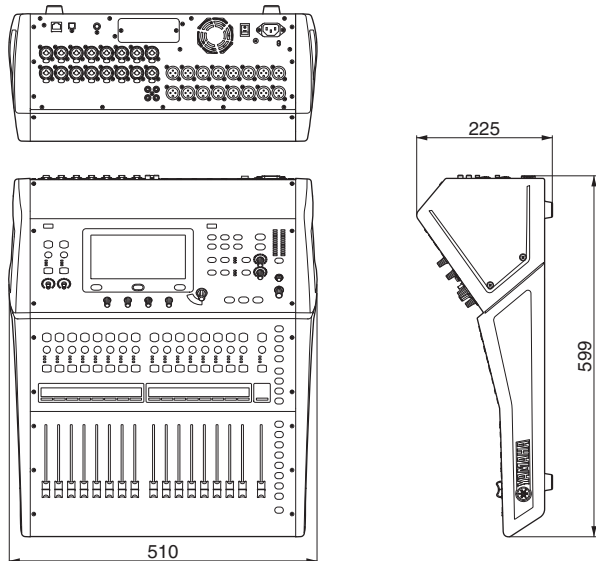

TF1 rack mount (14U)

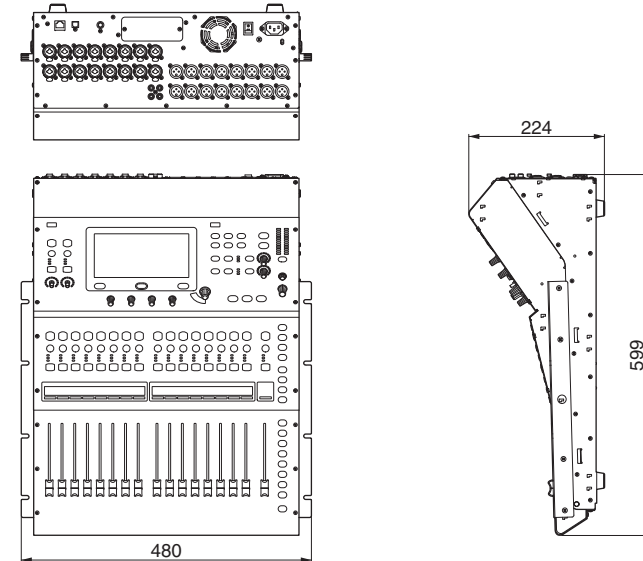

Unit: mm

TF-RACK

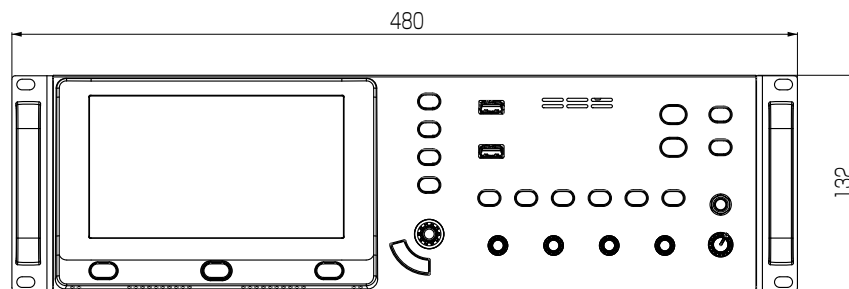
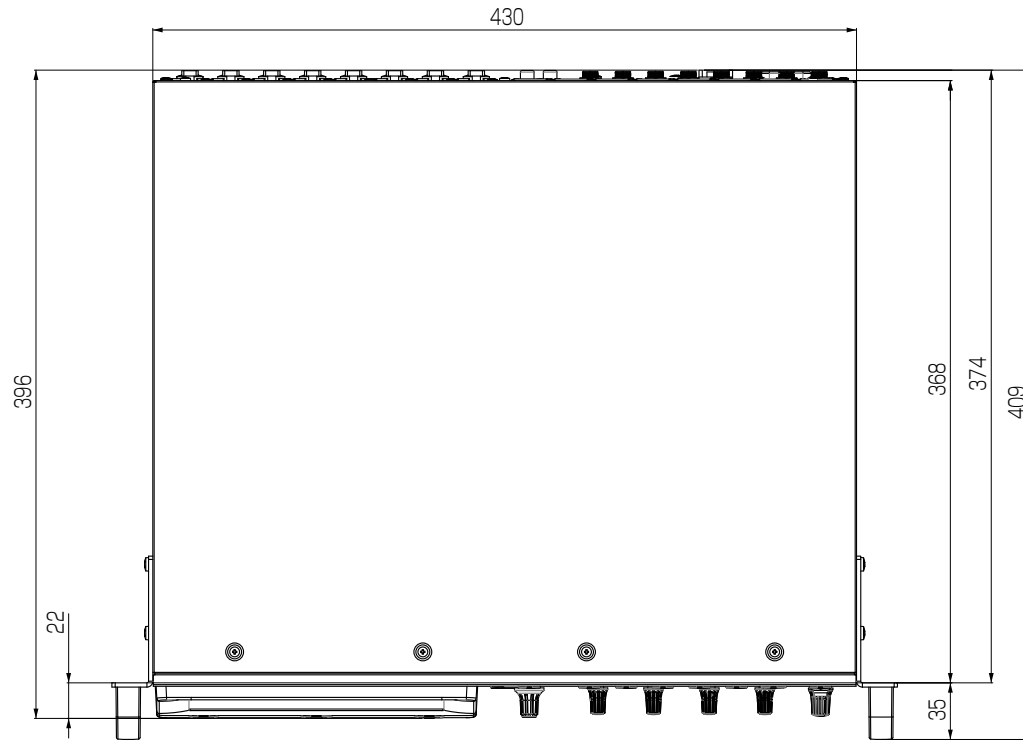

Unit: mm

Block diagram

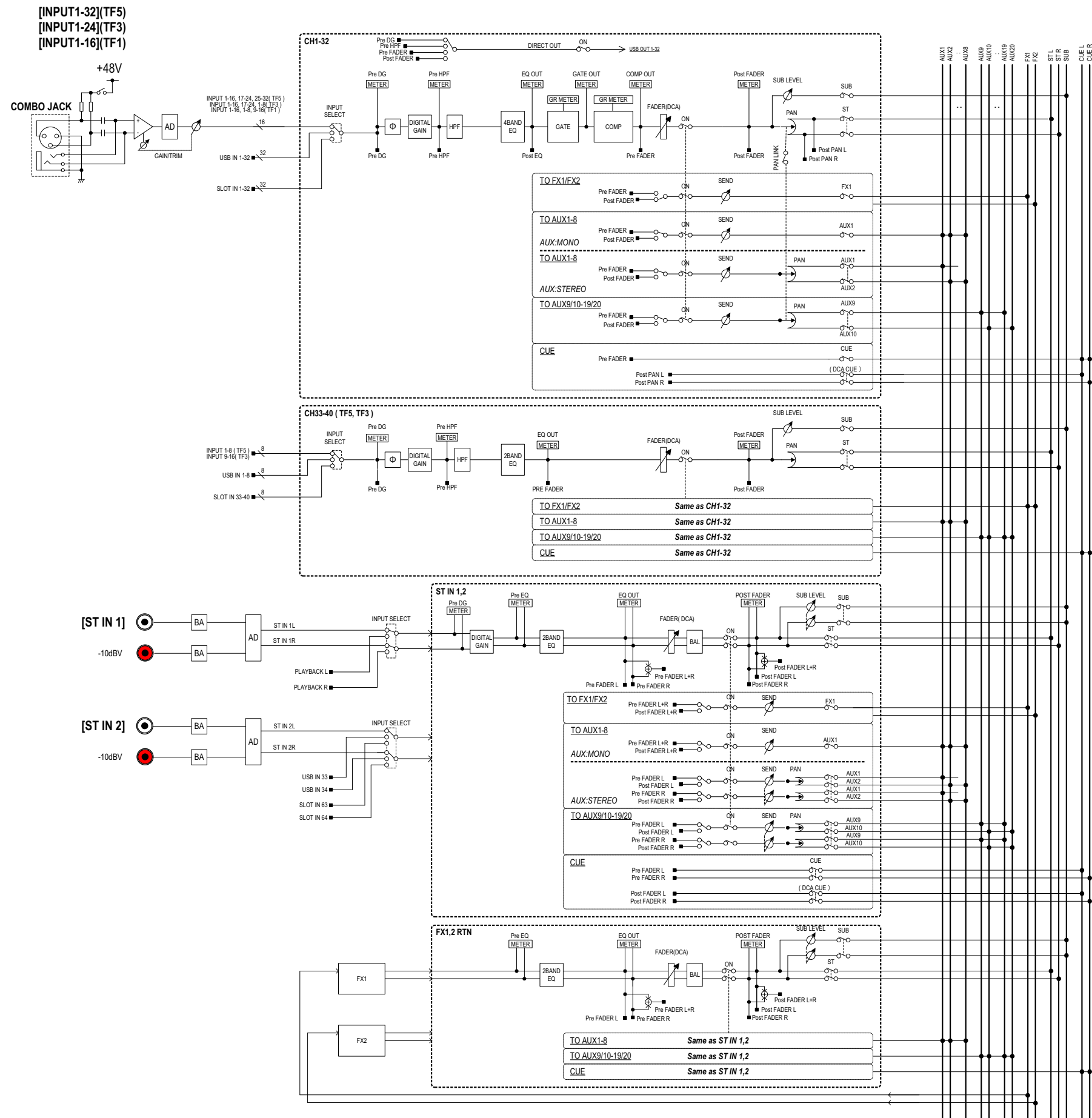

TF5,3,1 Mixer Block Diagram 1/2

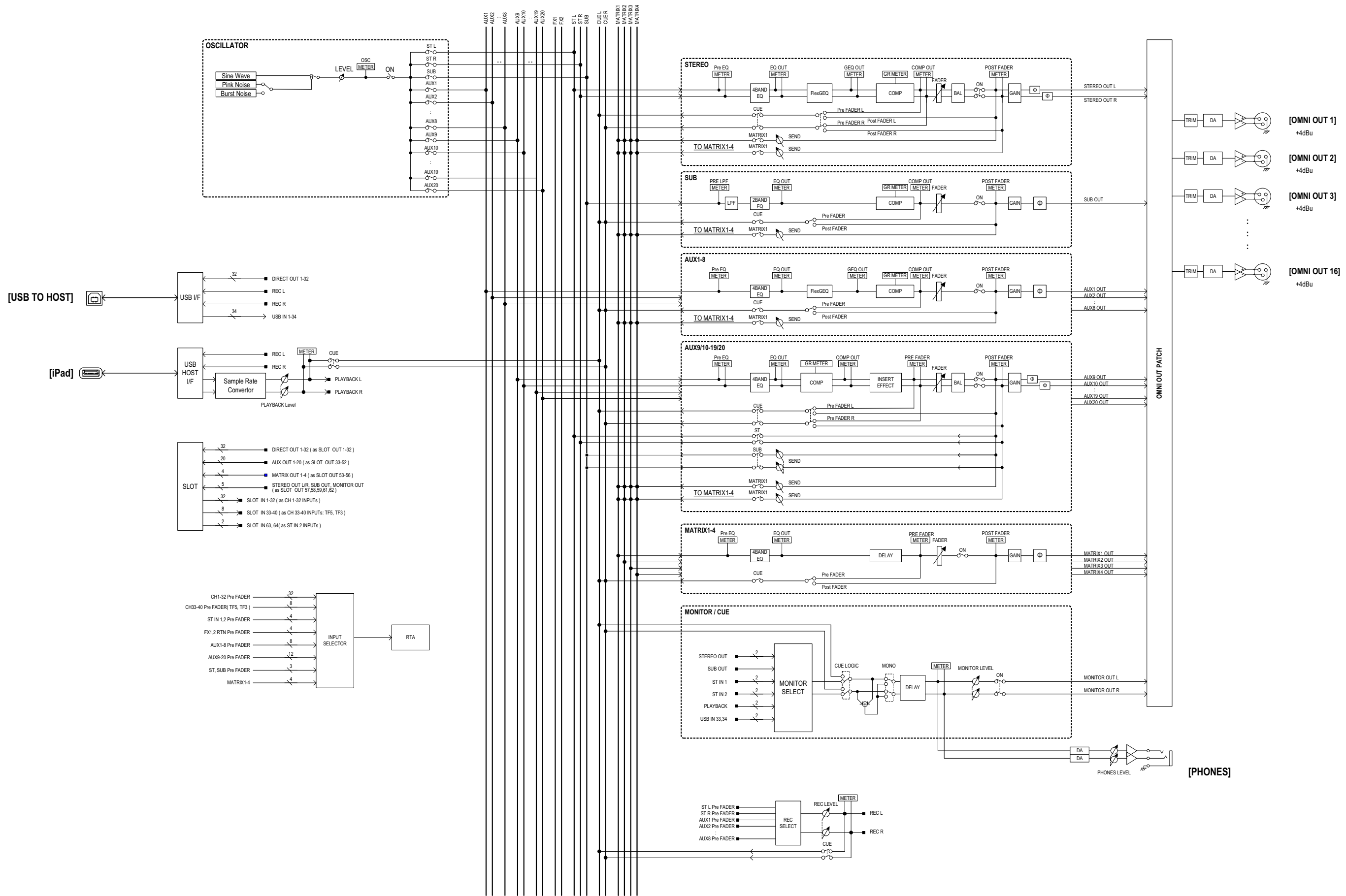

TF5,3,1 Mixer Block Diagram 2/2

[INPUT1-16]

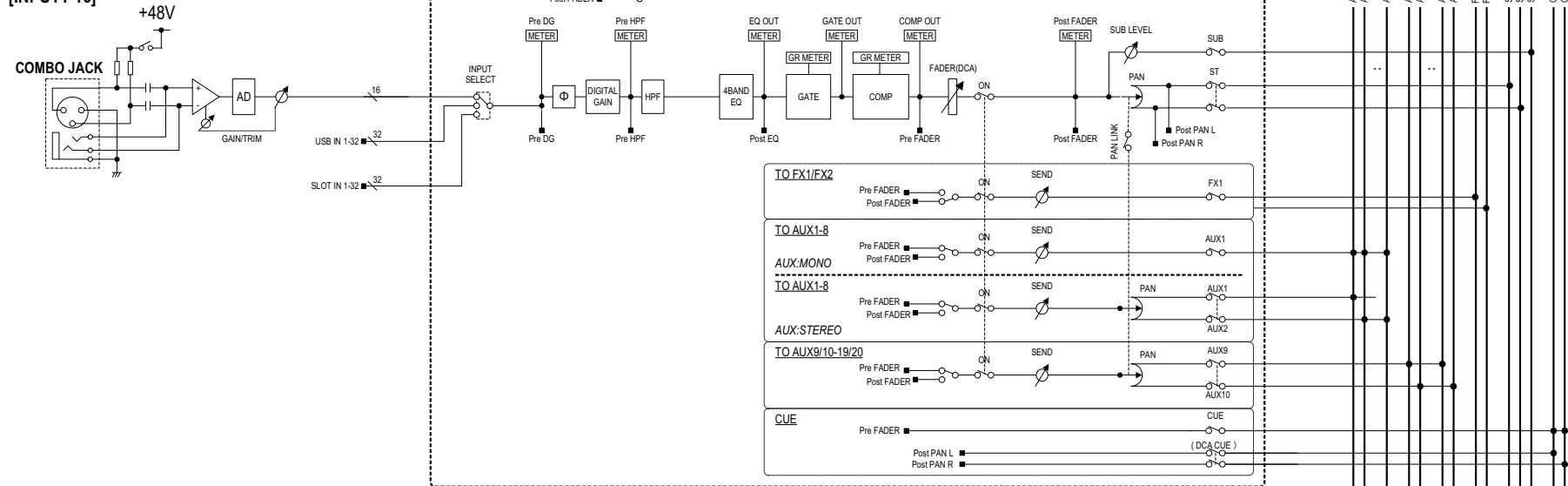

[ST IN]

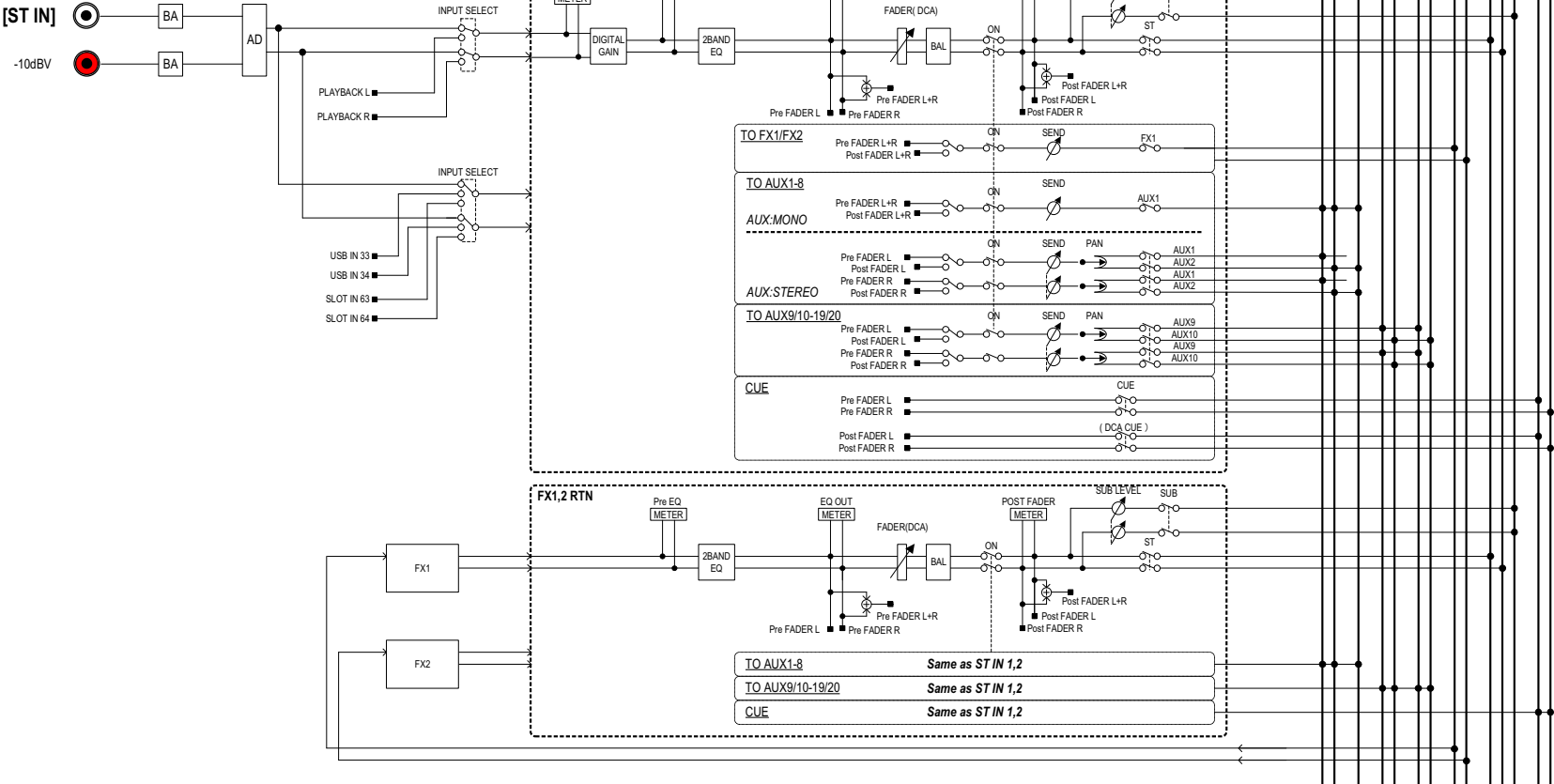

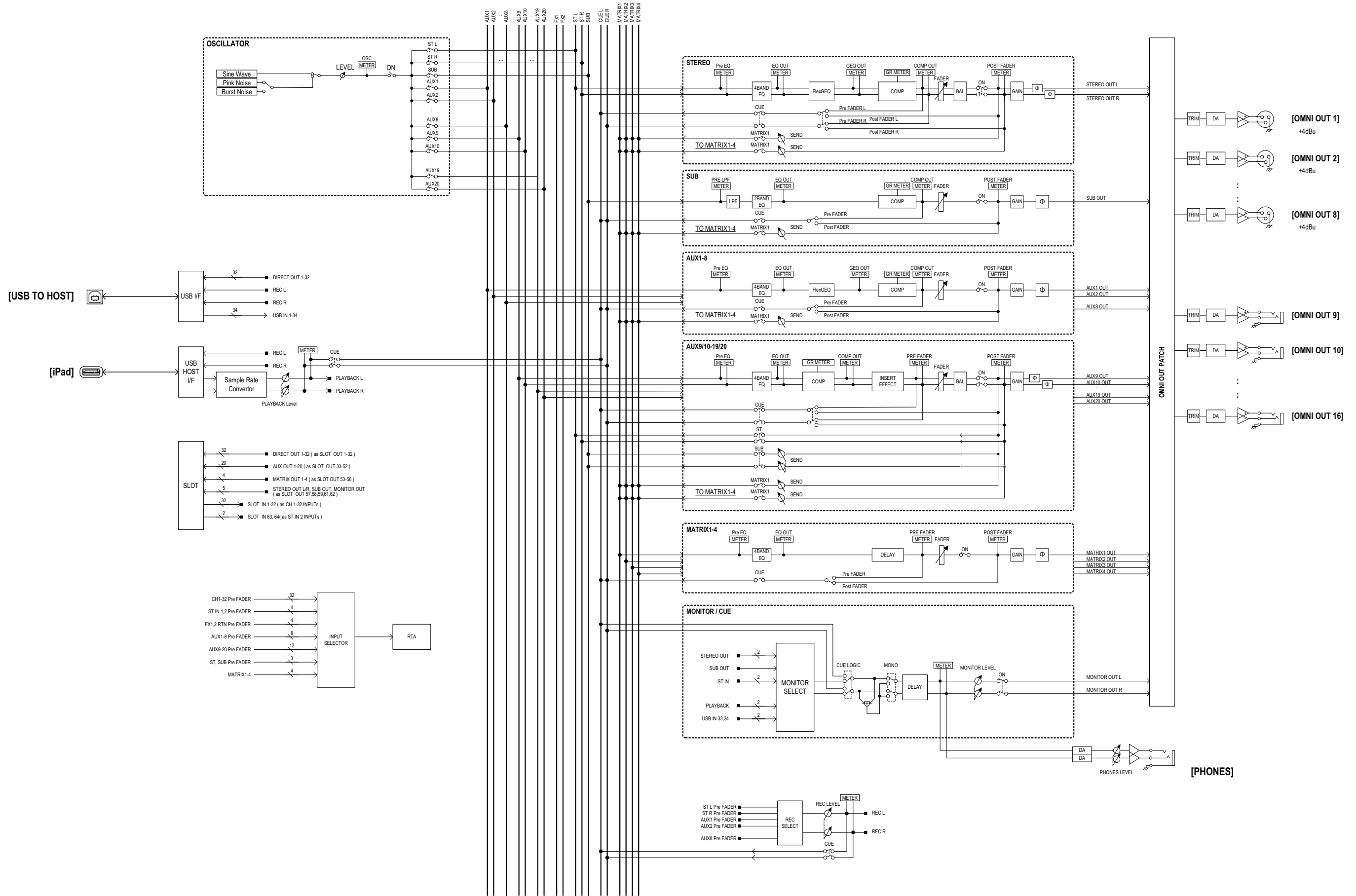

TF-RACK Mixer Block Diagram 2/2

Yamaha Pro Audio global website
<http://www.yamahaproaudio.com/>
Yamaha Downloads
<http://download.yamaha.com/>

Manual Development Group
© 2015 Yamaha Corporation

Published 01/2017 CR-F0