



**Digital Sound Projector**

# YSP-2700

[YSP-CU2700 + NS-WSW121]

## Owner's Manual

musicCast

---

Read the supplied booklet "Quick Reference Guide" before using the unit.

**English**

**EN**

# CONTENTS

## FEATURES 4

What you can do with this unit .....	4
Supplied accessories .....	6
Preparing remote control .....	7
Controls and functions .....	8

## PREPARATIONS 12

General setup procedure .....	12
<b>1 Installation</b> .....	<b>13</b>
<b>2 Connecting a TV</b> .....	<b>24</b>
<b>3 Connecting playback devices</b> .....	<b>25</b>
<b>4 Connecting to a network</b> .....	<b>27</b>
Wired network connections .....	27
<b>5 Connecting the power cable</b> .....	<b>28</b>
Connecting the subwoofer .....	29
<b>6 Initial settings</b> .....	<b>30</b>
Displaying the menu screen on the TV .....	30
Selecting a language for menu display .....	31
Auto setup for appropriate surround effects (IntelliBeam) .....	32
Operating the unit by TV's remote control (HDMI control) .....	37

## PLAYBACK 39

Basic operation for playback .....	39
Enjoying sound based on your preference .....	40
Playback with surround sound .....	40
Enjoying three-dimensional surround sound (CINEMA DSP) .....	41
2-channel playback (stereo playback mode) .....	42
Delivering sound to a specified location (target playback mode) .....	42
Playing back digitally compressed formats (such as MP3, etc.) with enriched sound (Compressed Music Enhancer) .....	43
Clear playback of human voices (CLEAR VOICE) .....	43
Adjusting volume for each channel .....	43
Adjusting tones .....	44
Using useful features .....	45
Saving energy with the Eco function .....	45
Switching information displayed in the front panel display .....	45
Saving this unit's settings to system memory .....	46
Wireless playback of audio via Bluetooth connection .....	47
Listening to music from a Bluetooth device (Receiving) .....	48
Listening to audio through Bluetooth speakers or headphones (transmitting) .....	49

## NETWORKS 50

<b>Network functions and the MusicCast CONTROLLER app</b> .....	50
Connecting with the MusicCast CONTROLLER app (registering the unit as a MusicCast-enabled device) .....	50
Using connection methods other than the MusicCast CONTROLLER app (wireless network) .....	53
Connecting a mobile device to the unit directly (Wireless Direct) .....	60
<b>Playing back music stored on media servers (PCs/NAS)</b> .....	62
Media sharing setup .....	62
Playing music files .....	63
<b>Listening to Internet radio</b> .....	64
Playback of Internet radio .....	64
Registering favorite Internet radio stations .....	64
<b>Playing back music with AirPlay</b> .....	66
Playback of iTunes/iPod music contents .....	66
<b>Playing back music stored on mobile devices</b> .....	68
Using a mobile device to play songs .....	68

## SETTINGS 69

<b>Setup menu</b> .....	69
Setting the setup menu .....	69
Setup menu list .....	70
Beam .....	72
Sound .....	77
HDMI .....	80
Bluetooth .....	81
Network .....	82
Function .....	85
Information .....	86
<b>Settings each input source (Option menu)</b> .....	87
Setting the option menu .....	87
Option menu list .....	88
<b>Advanced setup</b> .....	89
Setting the advanced setup .....	89
Advanced setup list .....	90
<b>Updating the unit's firmware</b> .....	92
Using "Network Update" in the setup menu to update firmware .....	92
Updating firmware with connection of a USB flash drive .....	93

## APPENDIX 94

<b>Troubleshooting</b> .....	94
General .....	94
Bluetooth .....	98
Remote control .....	99
Network .....	100
<b>Messages in the front panel display</b> .....	102
<b>When surround effect is not enough</b> .....	103
Installing and adjusting the sound reflection board YRB-100 .....	103
<b>Pairing the center unit and subwoofer</b> .....	105
<b>Basic knowledge of surround sound</b> .....	106
What is Surround Sound? .....	106
What is a Digital Sound Projector? .....	106
Yamaha's audio technologies .....	106
<b>Glossary</b> .....	107
Audio/video information .....	107
Network information .....	108
<b>Specifications</b> .....	109
<b>Index</b> .....	112

# FEATURES

## What you can do with this unit

Sound beams are reflected off walls using unique real surround sound formats and techniques, allowing listeners to enjoy their preferred acoustic environment.

- Automatically and quickly adjusts surround sound effects for the listening room setup (IntelliBeam) ➔ p. 32
- Reproducing stereo or multichannel sounds with the sound fields like actual movie theaters and concert halls (CINEMA DSP) ➔ p. 41
- Enjoying compressed music with enhanced sound (Compressed Music Enhancer) ➔ p. 43
- Delivering sound to a specified location (Target playback mode) ➔ p. 42

Sequential operation of a TV, this unit, and BD/DVD player (HDMI Control) ➔ p. 37

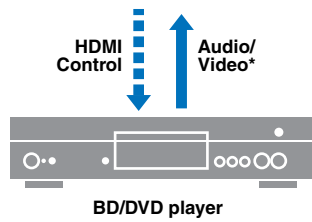
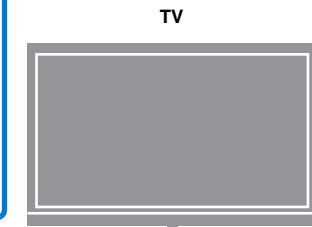
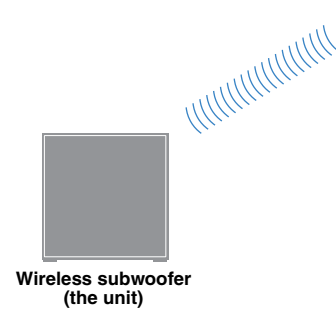
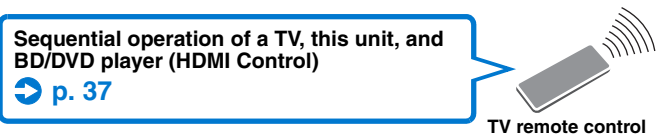

Dedicated apps for mobile devices ➔ p. 5

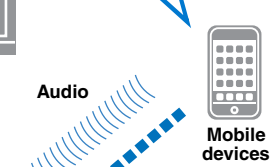

Wide variety of supported content

- Media server (PC/NAS) ➔ p. 62
- Internet radio ➔ p. 64
- AirPlay ➔ p. 66
- Music stored on mobile devices ➔ p. 68

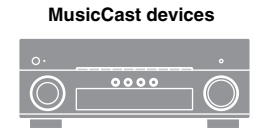
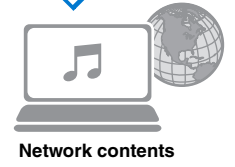

Share music via your home network ➔ p. 5



Plays back audio content from Bluetooth® devices ➔ p. 48



Listen to audio input to the unit with Bluetooth headphones or speakers ➔ p. 49

\* Supports 4K video and HDCP version 2.2



## Unrestricted playback of music over a network using MusicCast CONTROLLER

The free dedicated app for mobile devices, MusicCast CONTROLLER, allows you to listen to music stored on mobile devices such as smartphones, or on servers, or to listen to Internet radio stations and many kinds of major streaming services.

This app also allows you to distribute content to other MusicCast-enabled devices for synchronized playback.

The MusicCast CONTROLLER app can also be used to perform such tasks as selecting the input source and adjusting volume.

See the "MusicCast Setup Guide", or visit the Yamaha website for details.

Search for "MusicCast CONTROLLER" on the App Store or Google Play.



## Bluetooth functions

You can receive and play audio from a *Bluetooth* device, such as a mobile device over a wireless connection. You can also transmit audio input to the unit to a *Bluetooth* headphones.



- In this manual, iOS and Android mobile devices are collectively referred to as "mobile devices". The specific type of mobile device is noted in explanations as needed.

### About this manual

- In this manual, operations that can be performed using either the front panel keys or the remote control are explained using the remote control.
-  indicates supplementary explanations for better use.
-  indicates precautions for use of the unit and its feature limitations.

## Supplied accessories

Before using the unit, make sure you have received all of the following items.

### The YSP-2700

Center unit (YSP-CU2700)



Wireless subwoofer (NS-WSW121)



### Supplied accessories

Remote control



Batteries (AAA, R03, UM-4) (x2)

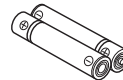

Optical digital audio cable\* (1.5 m (4.9 ft))



IntelliBeam microphone (6 m (19.7 ft))

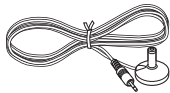

Cardboard microphone stand

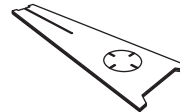

Stands (x2)



• Owner's Manual CD-ROM

• Quick Reference Guide

• MusicCast Setup Guide

\* The China model comes with a coaxial digital audio cable rather than an optical digital audio cable.



• The supplied optical digital audio cable may not be needed depending upon connections.

### Supplied accessories for SPM-K20

Spacers (x2)



Pads (x3)



Screws (M4, 22 mm) (x2)



Mounting template



## Preparing remote control

Before installing batteries or using the remote control, be sure to read battery and remote control precautions in "Quick Reference Guide" (separate booklet).

### ■ Installing the batteries

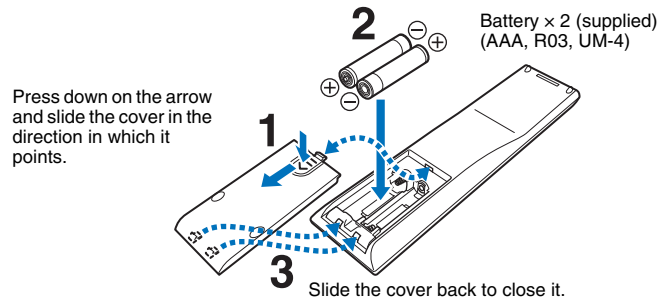

### ■ Operation range

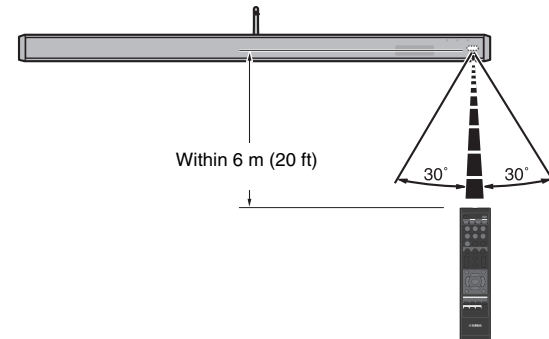

# Controls and functions

## Center unit (front, top)

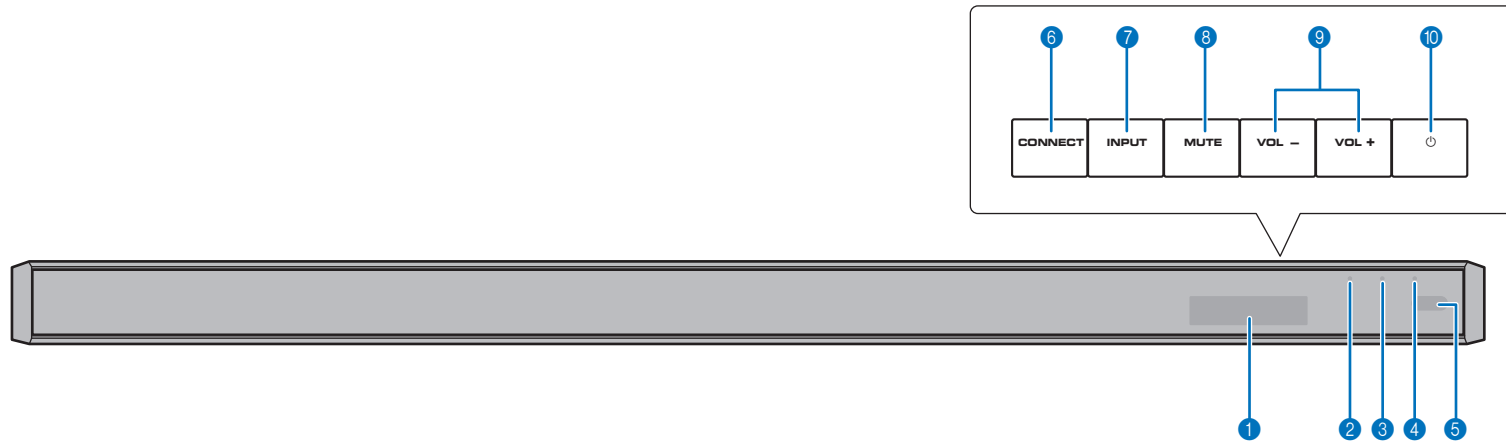

### 1 Front panel display

Displays the unit's settings, such as the name of an audio input source or surround mode (p. 45). The setting values are also displayed.

### 2 indicator

Lights to show the system condition.

Glowes green: Power on

Glowes red: Power off (when the HDMI control or network standby is activated)

Turns off: Power off

### 3 (Wi-Fi) indicator

Shows the status of wireless network connection (p. 27).

### 4 (Bluetooth) indicator

Shows the status of *Bluetooth* connection (p. 47, 49).

### 5 Remote control sensor

Receives infrared signals from the remote control (p. 10).

### 6 CONNECT key

Use to connect the unit to a network using the MusicCast CONTROLLER app (p. 50).

### 7 INPUT key

Select an audio input source.

### 8 MUTE key

Mute the sound (p. 39).

### 9 VOLUME (+/-) keys

Adjust the volume of the unit (p. 39).

### 10 key

Turn on/off the unit.



- When the unit is turned off, this unit consumes a small amount of power in order to search for HDMI signals or to receive signals from a network device.



- The front panel display turns on for about 3 seconds only when the unit is operated.
- "Dimmer" can adjust the brightness of the front panel display and indicators in the setup menu (p. 85).



## Center unit (rear)

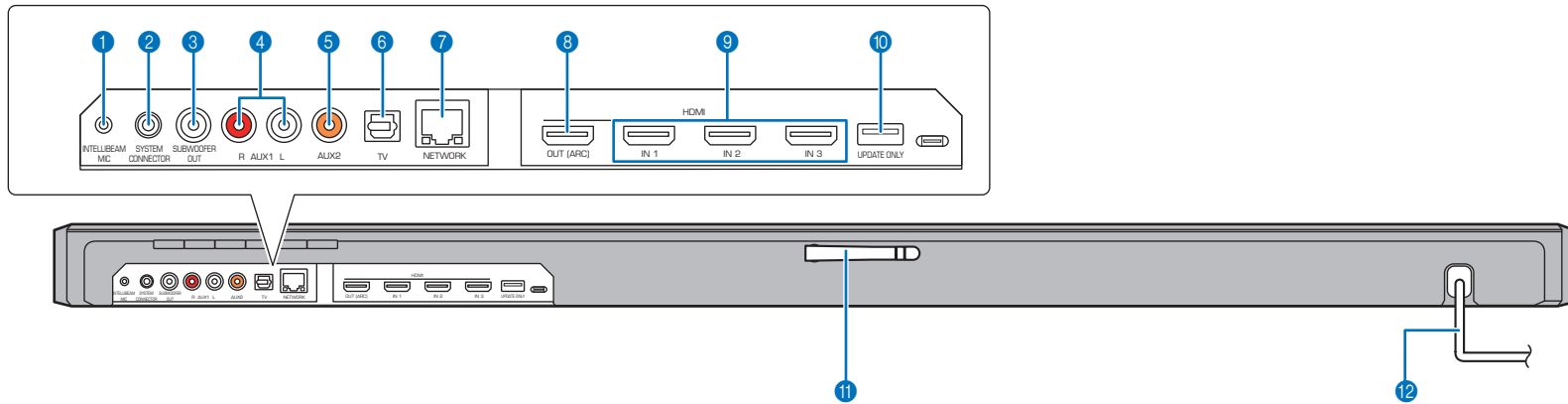

### 1 INTELLIBEAM MIC jack

For connecting the supplied IntelliBeam microphone (p. 33).

### 2 SYSTEM CONNECTOR jack

For connecting to the supplied subwoofer using a wired connection (p. 29).

### 3 SUBWOOFER OUT jack

For connecting to the supplied subwoofer using a wired connection (p. 29).

### 4 AUX1 input jacks

For connecting to a playback device equipped with the analog audio output jacks (p. 26).

### 5 AUX2 input jack

For connecting to a playback device equipped with a coaxial digital audio output jack (p. 25).

### 6 TV input jack

For connecting to a TV equipped with an optical digital audio output jack (p. 24).

### 7 NETWORK jack

For connecting to a network with a network cable (p. 27).

### 8 HDMI OUT (ARC) jack

For connecting to an HDMI-compatible TV and outputting video/audio signals (p. 24).

### 9 HDMI IN 1–3 jacks

For connecting an HDMI-compatible playback device such as a BD/DVD player, a satellite and cable TV tuner, and a game console (p. 25).

### 10 UPDATE ONLY jack

Use to update this unit's firmware (p. 92).

### 11 Antenna

Raise the antenna after the unit is installed (p. 23).

### 12 Power cable

For connecting to an AC wall outlet (p. 28).

## Remote control

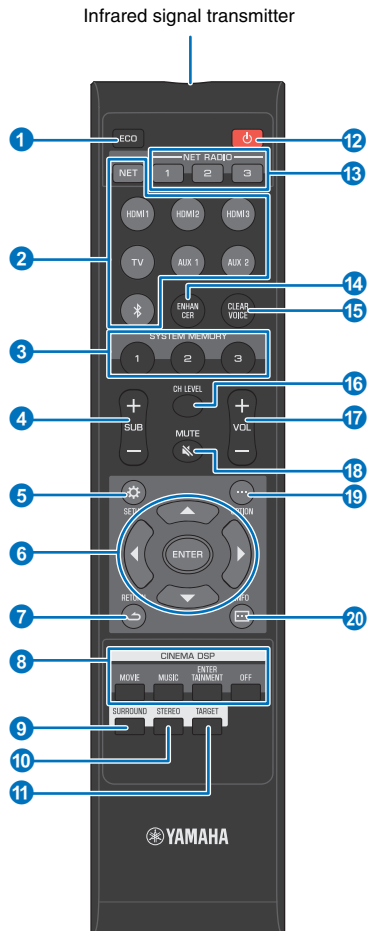

### 1 ECO key

Turn the Eco function on or off (p. 45).

### 2 Input selector keys

Select an audio input source to be played back (p. 39).

- **NET key:** Select an audio input via a network (p. 50). Each time the key is pressed, the input source is selected as follows:  
SERVER → NET RADIO → AirPlay → Streaming music service (if available) → MusicCast Link → SERVER → ...

- **HDMI 1–3 keys:** For devices connected to the HDMI 1–3 jacks (p. 39)

**TV key:** For a device connected to the TV input jack (p. 39)

**AUX 1 and 2 keys:** For devices connected to the AUX 1 and 2 input jacks (p. 39)

- **⌘ key:** For a *Bluetooth* device (p. 48)

### 3 SYSTEM MEMORY keys

Save IntelliBeam measurements, speaker volume, and other settings (p. 46).

### 4 SUB (+/-) key

Adjust the volume of the subwoofer (p. 39).

### 5 SETUP (⚙) key

Display the setup menu (p. 69).

### 6 ▲/▼/◀/▶ keys, ENTER key

Change the setting (p. 69).

### 7 RETURN (↵) key

Return to the previous menu screen.

### 8 CINEMA DSP program keys

When playback is in surround playback mode, select the CINEMA DSP programs (p. 41).

### 9 SURROUND key

Switch to surround playback mode (p. 41).

### 10 STEREO key

Switch to stereo playback mode (p. 42).

### 11 TARGET key

Switch to target playback mode (p. 42).

### 12 ⏻ key

Turn on/off the unit (p. 39).

### 13 NET RADIO (1–3) keys

Register and play streaming services such as Internet radio stations via the unit (p. 64).

### 14 ENHANCER key

Turn Compressed Music Enhancer to on or off (p. 43).

### 15 CLEAR VOICE key

Turn the CLEAR VOICE function on or off (p. 43).

### 16 CH LEVEL key

Adjust the volume balance during playback (p. 43).

### 17 VOL (+/-) key

Adjust the volume of the unit (p. 39).

### 18 MUTE (🔇) key

Mute the sound (p. 39).

### 19 OPTION (...) key

Display the option menu for each input source (p. 87).

### 20 INFO (ℹ) key

Switch the information display on the front panel (p. 45).

## Subwoofer (rear)

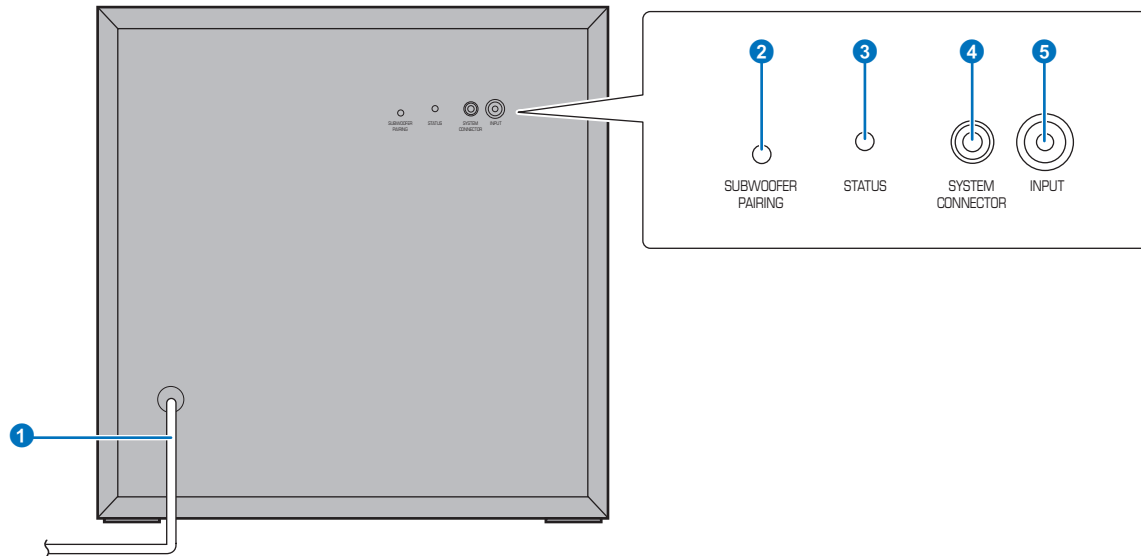

### 1 Power cable

For connecting to an AC wall outlet (p. 28).

### 2 SUBWOOFER PAIRING button

Used to pair the center unit with the subwoofer manually (p. 105). Use a pin or other pointed object to press this key.

### 3 STATUS indicator

Shows subwoofer's connection status (p. 29).

Glow green: Power on

Glow red: Power off

### 4 SYSTEM CONNECTOR jack

For connecting to the center unit using a wired connection (p. 29).

### 5 INPUT jack

For connecting to the center unit using a wired connection (p. 29).

# PREPARATIONS

## General setup procedure

- 1 Installation (p. 13)** Position the unit to achieve the optimal surround sound effects.
- 2 Connecting a TV (p. 24)** Connect a TV to the unit.
- 3 Connecting playback devices (p. 25)** Connect video devices (such as BD/DVD players) to the unit.
- 4 Connecting to a network (p. 27)** Use a network cable to connect the unit to a router in preparation for wired network connection. Information regarding connection to a wireless network is also provided.
- 5 Connecting the power cable (p. 28)** After all the connections are complete, plug in the power cable.
- 6 Initial settings (p. 30)** Perform initial setup, such as adjusting surround sound effects, before attempting playback.

This completes all the preparations. Enjoy playing movies, music and other content with the unit!



- See "NETWORKS" (p. 50) for information regarding network connection and audio playback via a network.

## 1 Installation

This unit reflects sound beams off of walls to create the surround sound effect. The position of this unit in relation to the listening position and walls is important to achieving the desired surround sound effects. Refer to pages 13 to 17 when installing the unit. When installing this unit on a rack behind which there is limited space, for example, it may be easier to connect external devices to this unit first. This will depend upon the installation location. See pages 24 to 27 for information regarding the connection of external devices.

### Caution

- Be sure to install the center unit on a large, stable stand where it does not fall subject to vibrations, such as from an earthquake, and where it is out of the reach of children.

### Notes

- The subwoofer speaker is not magnetically shielded. Do not install hard disk drives or similar devices near the subwoofer.
- Do not stack the center unit and subwoofer directly on top of other playback devices, or vice versa. Heat and vibrations may result in damage or malfunction.

## Recommended place for installation

- Install the unit in the center of the left and right walls.
- If the antenna is raised (p. 23), position the center unit so that the antenna does not obstruct the TV screen.
- Attach the stands if the center unit does not sit high enough (p. 18)\*.
- The center unit can be mounted on a wall using the optional Wall Mount Bracket SPM-K20 (p. 19).

\* If the center unit will be installed on a TV stand, attach the center unit stands to increase its height. Position the center unit so that it does not obstruct the TV's remote control sensor or signal transmitter for 3D glasses.

- The listening position (such as sofa, etc.) should be located at the front of the unit.
- The distance between the listening position and the unit should be more than 1.8 m (6 ft).

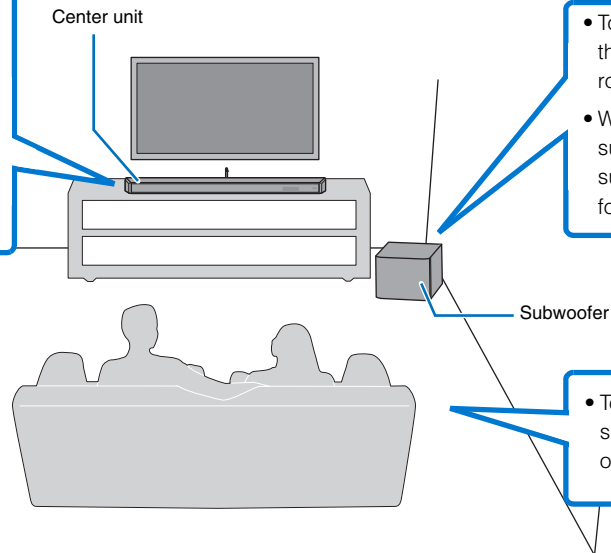

- To prevent sound reflecting off of walls, angle the subwoofer slightly toward the center of the room.
- When installing the subwoofer on a rack, be sure the rack is strong enough to support the subwoofer and that it leaves sufficient space for heat discharge.

- To achieve desired surround sound effects, be sure that obstacles such as furniture may not obstruct the path of sound beams (p. 14).

## Connecting the center unit and subwoofer via a wireless connection

The center unit and subwoofer communicate wirelessly. Subwoofer performance may be affected if the subwoofer is placed on a metal rack, or if there is a metal plate between the subwoofer and the center unit. Use a wired connection to connect the subwoofer to the center unit if sounds are interrupted due to the installation condition (p. 29).

## Example of installing the unit

This unit outputs sound beam as shown in the illustrations below. Install this unit where there are no obstacles such as furniture obstructing the path of sound beams. Otherwise, the desired surround sound effects may not be achieved.

If the unit is installed so that it is parallel to a wall, install it as close to the exact center of the wall as possible.

If the unit is installed in a corner of a room, position it at a 40–50° angle to the adjacent walls.

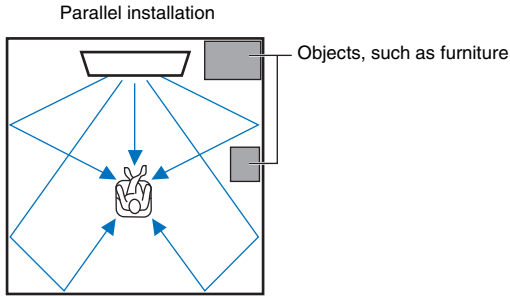

Sound beam output varies depending upon the surround setting (p. 40) and the channel output setting (p. 75). The illustration above shows the path of sound beams when surround playback is enabled and “Front” in the Channel Out setting is set to “Beam”.

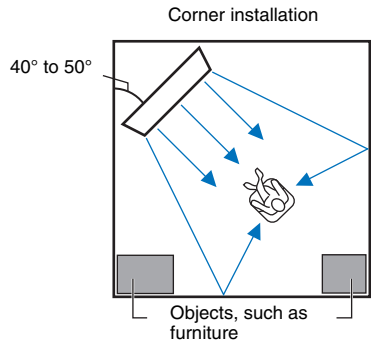

The illustrations above show the path of sound beams when surround playback is enabled (p. 40) and “Front” in the Channel Out setting is set to “Stereo” (p. 75).

### Parallel installation

Install this unit as close to the exact center of the wall as possible.

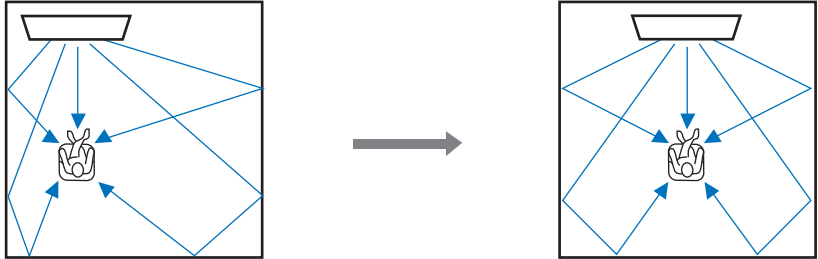

- If the unit cannot be installed evenly between the left and right walls, sound beams can be adjusted to achieve natural surround sound effects (p. 17).

### Ideal installation condition

Install this unit as close to the exact front of your normal listening position as possible.

The distance between listening position and the unit should be more than 1.8 m (6 ft).

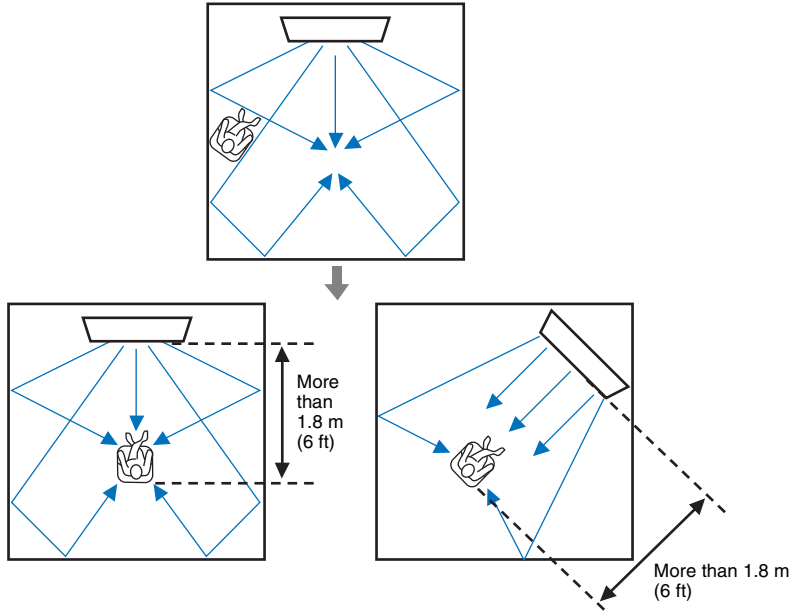

### Installing in a non-square room

Install this unit so that the sound beams can be reflected off the walls.

Irregularly shaped rooms with solid walls on all sides

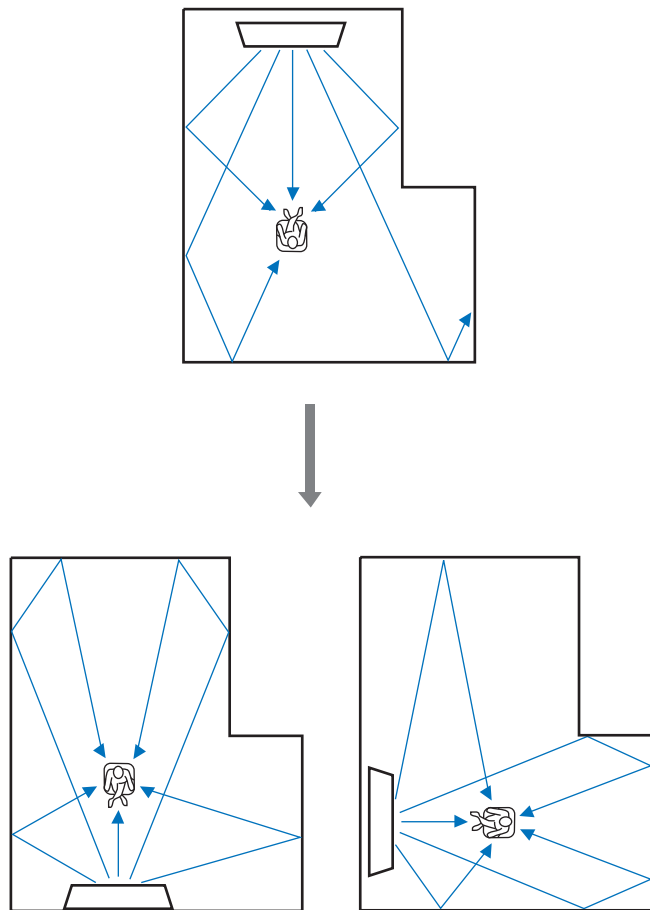

Irregularly shaped rooms that are open to a hallway on one side

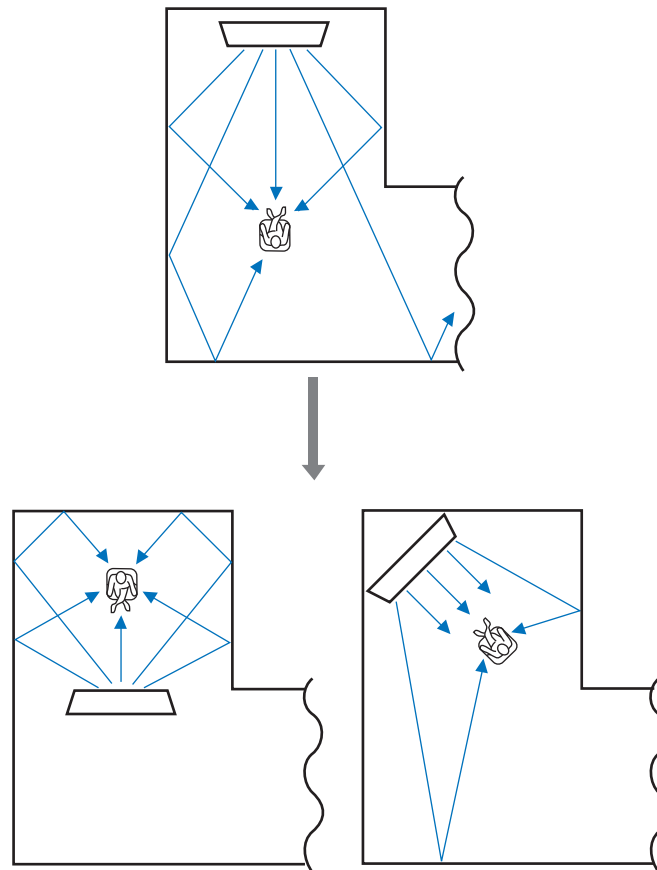

- If this unit cannot be repositioned, or the listening position cannot be changed, the optional YRB-100 sound reflection board may be installed for a better surround sound experience (p. 103).

### Example of installing the unit in a living room

- The legs on a table are not considered obstacles as sound beams normally pass through them. A cupboard installed facing the wall reflects sounds.
- As the heavy curtains absorb sounds, the sound features of the listening room is different from the case with the curtain opened and the case with the curtain closed. Using saving settings function enables to save the best settings for each case of listening room (p. 46).

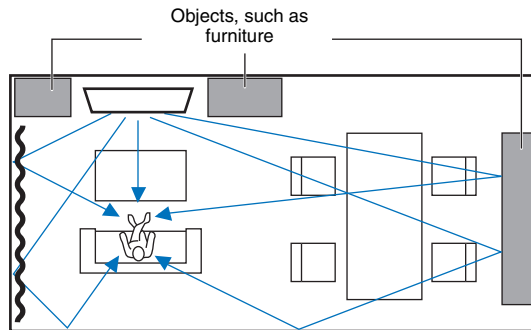

### Unrecommended listening environments

This unit creates surround sound by reflecting projected sound beams off the walls of your listening room. The surround sound effects produced by this unit may not be sufficient when this unit is installed in the following locations.

- Rooms with walls inadequate for reflecting sound beams
- Rooms with acoustically absorbent walls
- Rooms with measurements outside the following range:  
W (3 to 7 m (10 to 23 ft)) × H (2 to 3.5 m (7 to 11.5 ft)) × D (3 to 7 m (10 to 23 ft))
- Rooms where objects such as furniture are likely to obstruct the path of sound beams
- Rooms with less than 1.8 m (6 ft) from the listening position to this unit
- Rooms where the listening position is close to the walls
- Rooms where the listening position is not in front of this unit

### Enjoying surround effects regardless of conditions (My Surround)

The My Surround function creates rich surround sound effects in rooms with less than optimal surround sound conditions. See "Channel Out" (p. 75) for more information.



## Adjusting sound beams to achieve optimal surround sound effects

This unit's AUTO SETUP (p. 32) can be used to automatically adjust sound beams to achieve the optimal surround playback environment according to the listening room setup. In addition to using AUTO SETUP, sound beams can be adjusted manually to achieve surround sound effects best suited to the listening room setup when the unit is installed as described below.

### Installing the unit near a corner of the room

When installing the unit near a corner of the room as shown in the illustration below, front channel sound may seem to come from an unnatural direction if beam settings are configured using AUTO SETUP.

Should this occur, adjust the left and right front channels using "Image Location" (p. 74) in the setup menu to achieve more natural sound.

When left front channel sound is unnatural

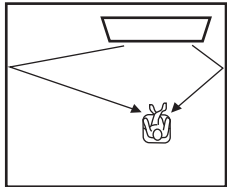

Left front channel adjusted

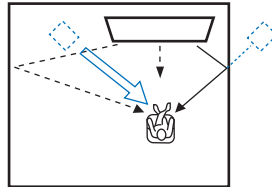

### Installing the unit in an irregularly shaped room

When the unit is installed in a room that is not rectangular, sound beams may not be properly reflected off the walls as shown in the illustration below.

Should this occur, perform AUTO SETUP, and then adjust the angle of beam from the channel from which sound is not properly heard using "Horizontal Angle" (p. 72) in the setup menu to achieve even distribution of sound.

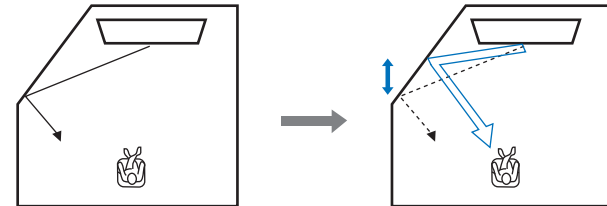

## Installing the stands

If the center unit does not sit high enough, attach the stands supplied with the unit to the center unit to increase the height at which it sits.

### 1 Remove the seal from the stand.

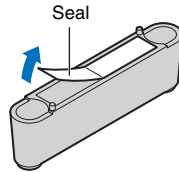

### 2 Align the protrusions on the stand with, and insert them into, the holes on the rear panel.

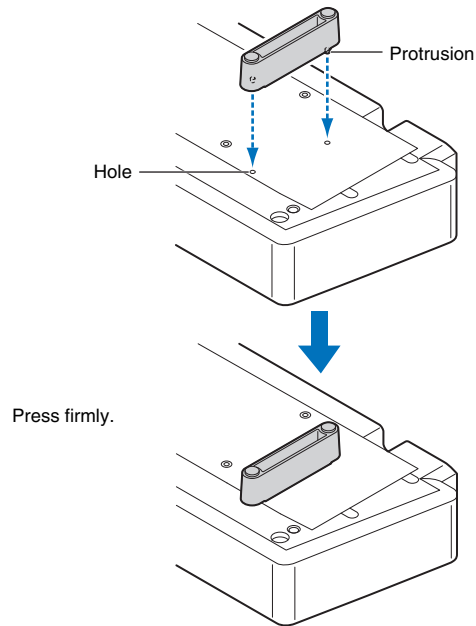

Install the left and right stands.

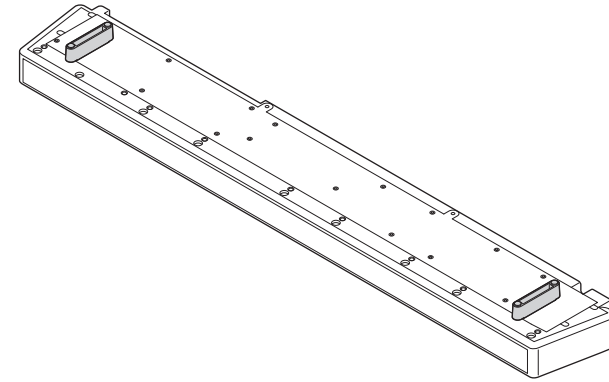

### Removing the stands

Pull the stands straight out.

## Mounting the center unit on a wall

If your TV is mounted on a wall, the optional Wall Mount Bracket SPM-K20 can be used to mount this unit on the wall under the TV.

See "Dimensions" (p. 22) for this unit and SPM-K20 dimensions.



- Be sure to read "SAFETY INSTRUCTIONS" in the Installation Manual supplied with the SPM-K20 before mounting it.
- The template and screws supplied with the SPM-K20 are not used with this unit.
- SPM-K20 may not be available in some countries or regions.



- Space between this unit and the wall is limited. Therefore, use of a flexible HDMI cable, or right-angle connector, (neither supplied) is strongly recommended.

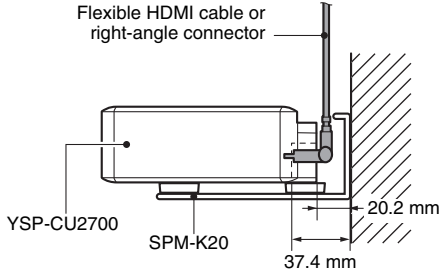

## Mounting the SPM-K20

Be sure that there is enough space on the wall to mount the wall mount bracket and this unit. Follow the instructions below to mount both.

### 1 Attach the three supplied pads to the wall mount bracket as shown in the illustration.

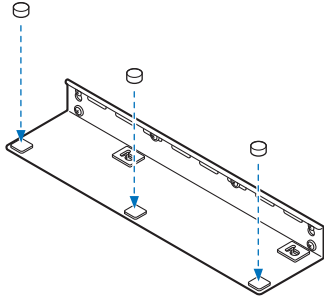

Follow instructions provided from this page through page 22.

**2 Attach the template supplied with this unit to the wall and use a thumbtack or pin to mark the position where screws will be inserted in the wall.**

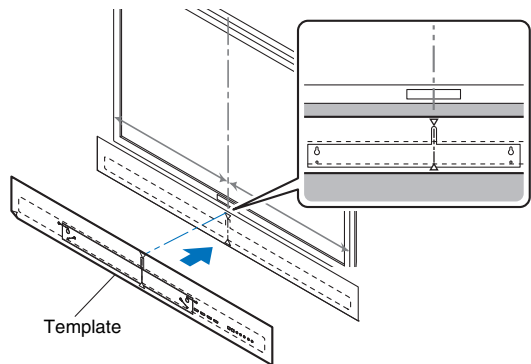

Attach the template to the wall so that the center of the template is aligned with the center of the TV.

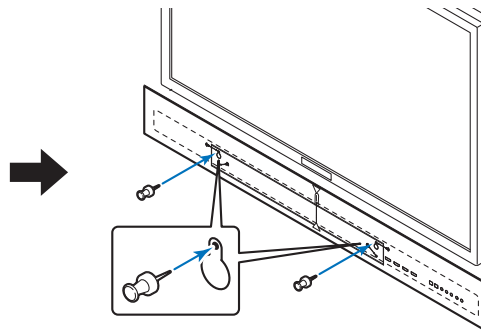

The wall mount bracket is designed to be offset slightly to the right of the center of this unit.

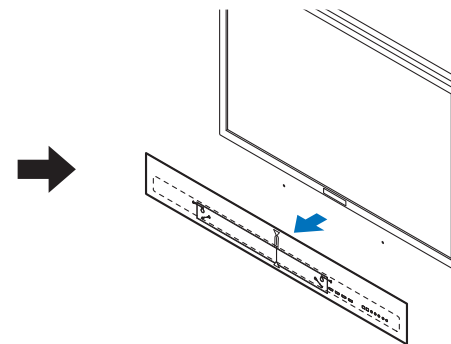

Once screw position has been marked, remove the template.

**3 Mount the wall mount bracket on the wall.**

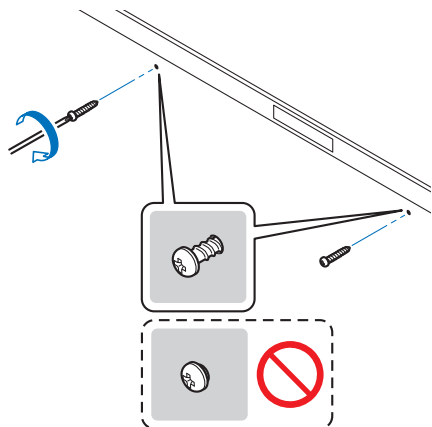

Screw self-tapping screws (not supplied) partway into the wall where marked using the template.

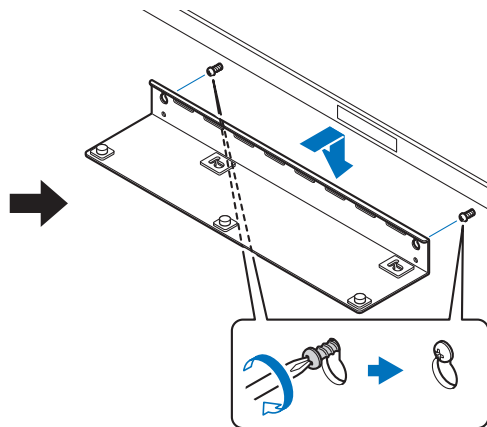

Mount the wall mount bracket on these screws, and then tighten the screws.

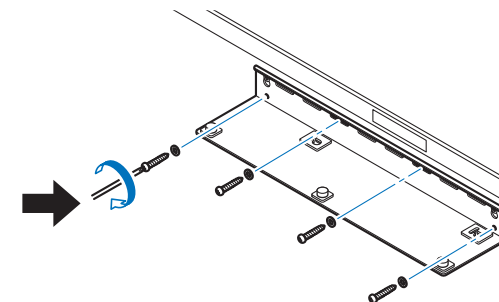

Screw self-tapping screws, at least six including the two previously used, into as many holes around the outer edges of the wall mount bracket as possible to ensure sufficient strength.



- Be sure that screws are inserted in a sturdy portion of the wall or pillar. Do not mount the bracket on a wall made of materials such as mortar or veneer, which may chip or peel. If screws fall out, the wall mount bracket will also fall, resulting in damage or injury.

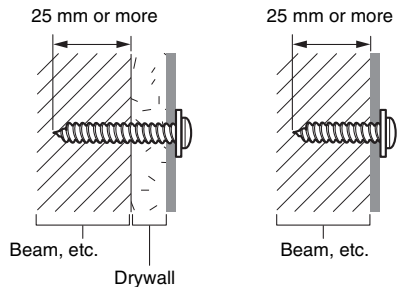

**4 Attach the spacer supplied with this unit to the bottom of this unit using the screws also supplied with this unit.**

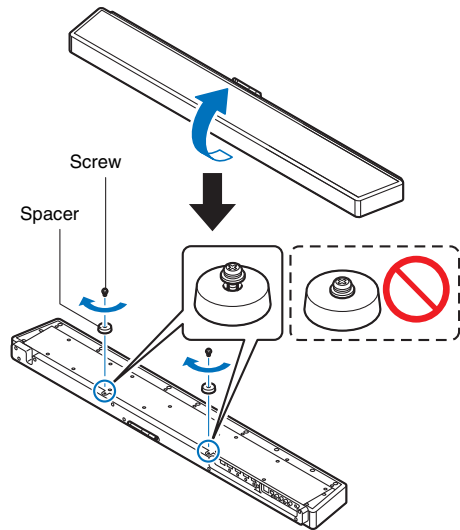

Do not tighten the screws until this unit has been mounted on the wall mount bracket.

**5 Connect commercial cables to this unit.**

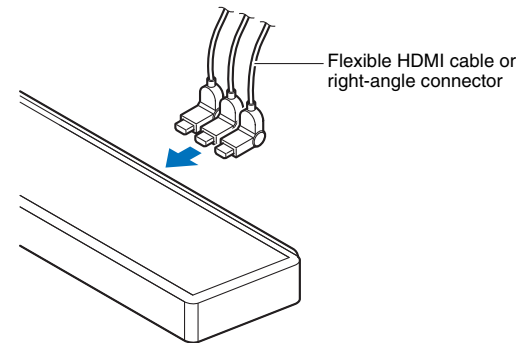

**6 Mount this unit on the wall.**

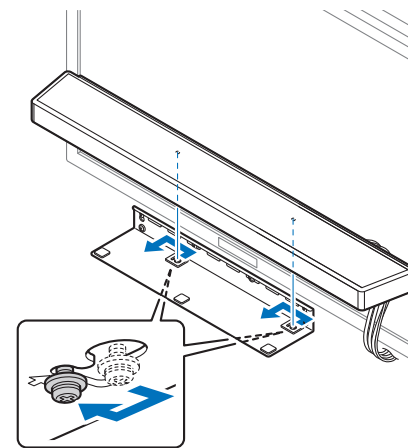

Insert the screws on this unit into the mounting holes on the left and right sides of the wall mount bracket, and then slide this unit to the left.



- When mounting or removing it, hold this unit firmly with both hands. If this unit falls, damage or injury could occur.

**7 Tighten screws.**

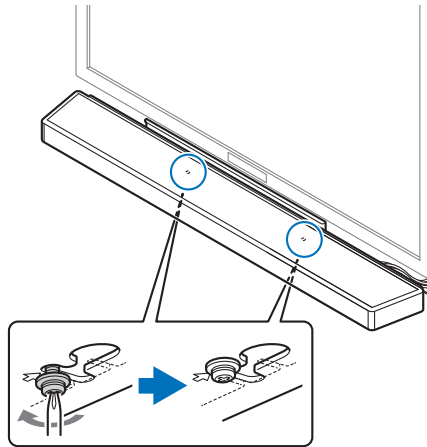

Tighten the screws used to attach the spacer to this unit in step 4.

**Dimensions**

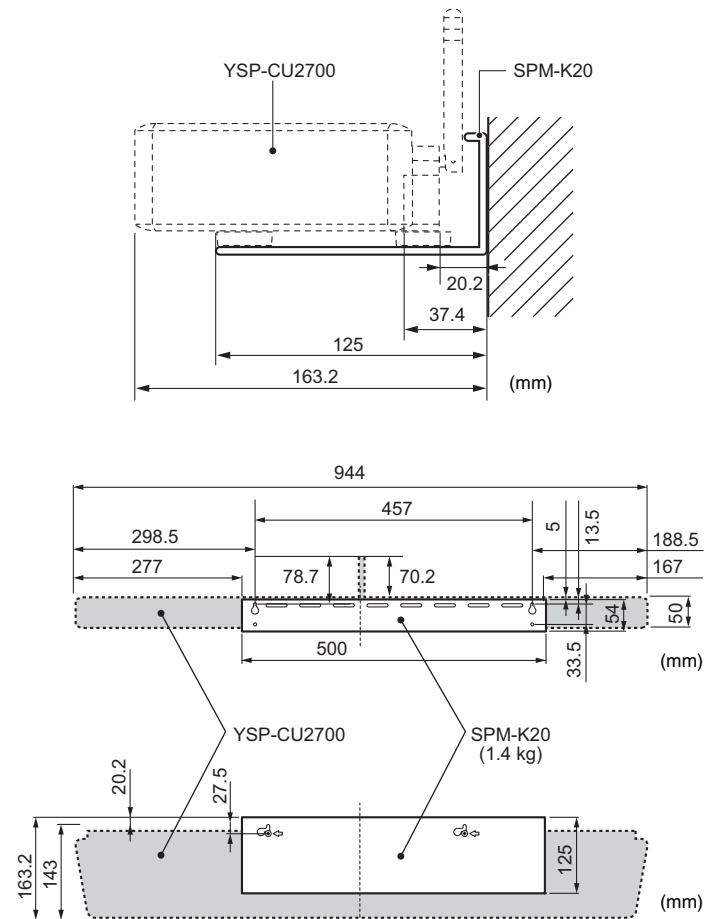

## Raising the antenna

Raise the antenna on the rear panel of the unit when connecting a wireless router (access point) to use a network.

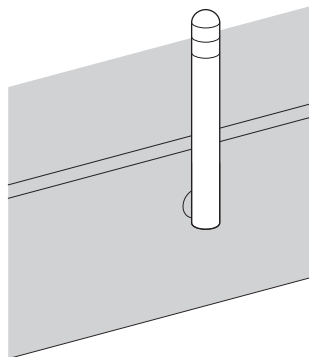

Hold the base of the antenna while raising it to its upright position.



- Do not apply excessive force on the antenna. Doing so may damage it.
- Be sure to check the direction in which the antenna moves, and angle it in the proper direction.
- Do not remove the antenna.



- For details on the wireless connection, refer to p. 27.

## 2 Connecting a TV

Connect a TV to the unit so that video input to the unit can be output to the TV. You can also enjoy playback of TV audio on the unit.



- Use a 19-pin HDMI cable with the HDMI logo printed on it. A cable with a maximum length of 5 m (16 ft) is recommended to prevent degradation of signal quality.
- For playback of 3D and 4K video content, use a high-speed HDMI cable.
- This unit supports HDCP version 2.2, a copy protection technology. For playback of 4K video, connect the unit to the HDMI input jack (one compatible with HDCP 2.2) on an HDCP 2.2-compliant TV.
- To play 4K (4:4:4) video content, set "4K MODE" in advanced setup to "MODE 1" (p. 90).

### TVs that support Audio Return Channel (ARC)

Connect the TV to the unit with an HDMI cable (not supplied).

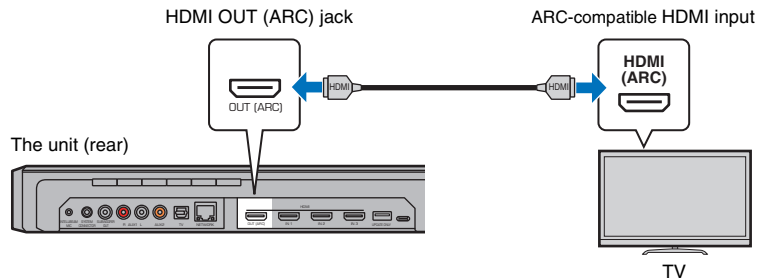

When connecting a TV that supports Audio Return Channel (ARC), enable the HDMI control function (p. 80).

#### What is Audio Return Channel (ARC)?

In order for the unit to play audio from a TV, the TV must usually be connected to the unit via an audio cable as well as an HDMI cable. If, however, the TV supports Audio Return Channel (ARC), TV audio signals can be input to the unit via the HDMI cable that outputs video signals from the unit to the TV.



- Use an ARC-compatible HDMI cable.

### TVs that do not support Audio Return Channel (ARC)

Connect the TV to the unit with an HDMI cable (not supplied) and an optical digital audio cable.

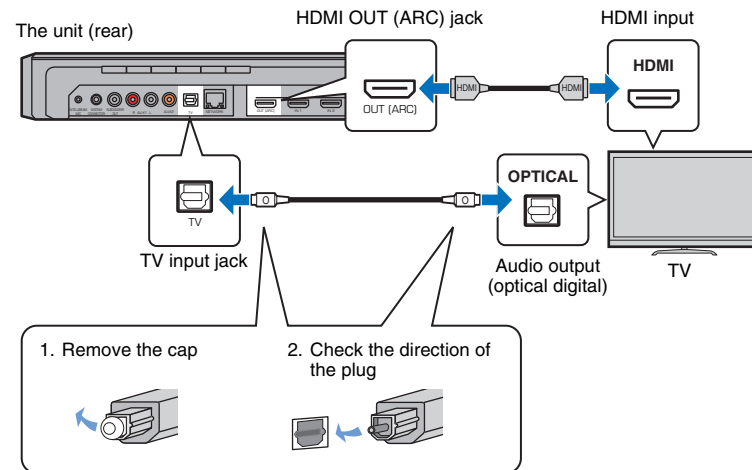

#### If the TV has no optical jack

- Connect the audio output jack on the unit to the AUX1 (analog) input jacks or AUX2 (coaxial digital) input jack on the unit, and set "TV Input" in the setup menu to "Analog [AUX 1]" or "Coaxial [AUX 2]" accordingly (p. 80). TV audio can be played through the unit by pressing the TV key on the remote control.



### 3 Connecting playback devices

Connect video devices such as BD/DVD players, set-top boxes (STBs) and game consoles to the unit. Depending on the video/audio output jacks available on your video device, choose one of the following connections. We recommend using an HDMI connection if the video device has an HDMI output jack.

#### HDMI connection

Connect a video device to the unit with an HDMI cable (not supplied).



- This unit supports HDCP version 2.2, a copy protection technology.

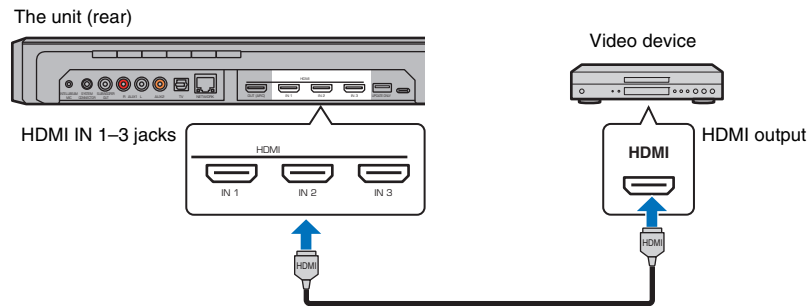

The audio/video played on the video device will be output through the unit by switching input to HDMI 1-3 using the HDMI 1-3 key on the remote control.



- Once the HDMI control function has been activated (p. 37), video and audio content from playback devices can be output from the TV even when this unit is off (HDMI signal pass-through).
- Use a 19-pin HDMI cable with the HDMI logo printed on it. A cable with a maximum length of 5 m (16 ft) is recommended to prevent degradation of signal quality.
- For playback of 3D and 4K video content, use a high-speed HDMI cable.
- When audio from the video device cannot be output via the HDMI jack, use an optical digital audio cable to connect the video device to the unit via the optical digital output jack on the video device and the TV jack on the unit. If the video device is connected to the unit in this way, change "Audio Assign" to "Optical" in option menu (p. 88).

#### Coaxial connection

Connect a video device to this unit via a coaxial digital cable. Next, connect the video device's video output to the TV's video input.

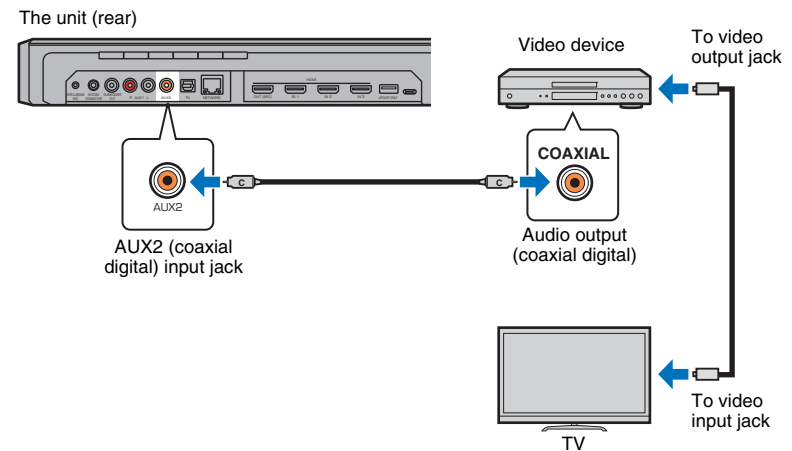

The audio played on the video device will be output through the unit by switching input to AUX2 using the AUX 2 key on the remote control.

## Analog connection

Connect a video device to this unit via a stereo cable (not supplied). Next, connect the video device's video output to the TV's video input.

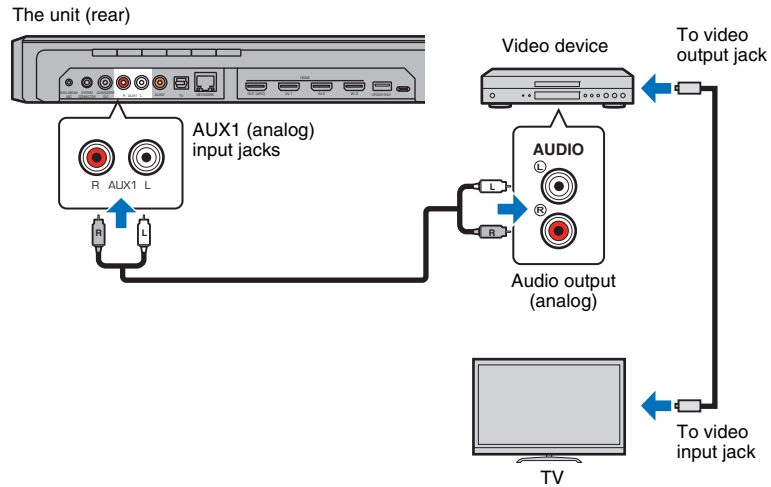

The audio played on the video device will be output through the unit by switching input to AUX1 using the AUX 1 key on the remote control.

## 4 Connecting to a network

### Wired network connections

To use a wired network connection, connect the unit to a router via an STP network cable (category 5 or higher straight cable; not supplied).

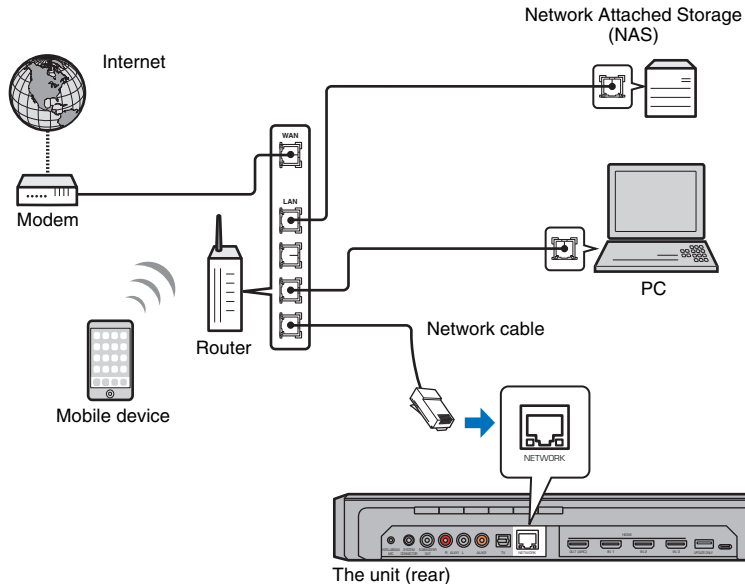

- If the unit is already connected to a wireless network and you would like to switch to a wired connection, change "Network" in the setup menu to "Wired".

### Wireless network

To connect to a network, be sure that the unit is plugged into an AC wall outlet, and then connect the unit to a wireless router (access point).

Refer to the following for instructions on connecting to a wireless router (access point).

- Using the MusicCast CONTROLLER app (p. 50)
- Using connection methods other than the MusicCast CONTROLLER app (p. 53 to 59)

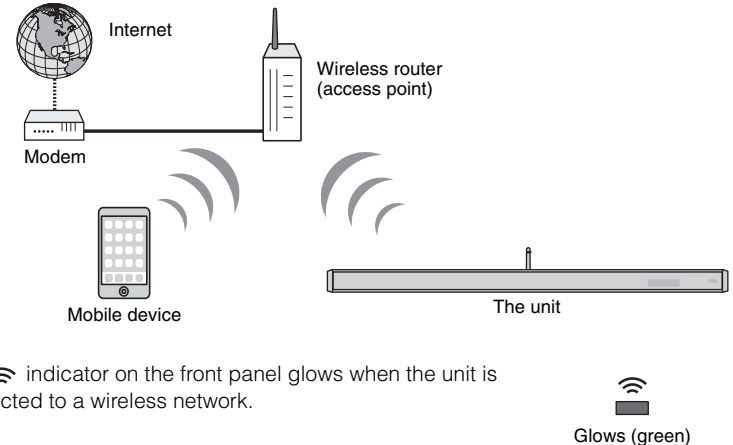

The  indicator on the front panel glows when the unit is connected to a wireless network.



- You cannot use the wireless network connection simultaneously with the wired network connection or Wireless Direct (p. 60).
- If the unit and the wireless router (access point) are too far apart, the unit may not connect to a wireless router (access point). In such case, place them close to each other.



- If the unit will not be connected to a wireless router (access point), Wireless Direct (p. 60) can be used to connect the unit directly to a mobile device to control the unit using the MusicCast CONTROLLER app installed on that mobile device.

## 5 Connecting the power cable

After all the connections are complete, plug in the power cable of the center unit and the subwoofer.

Center unit

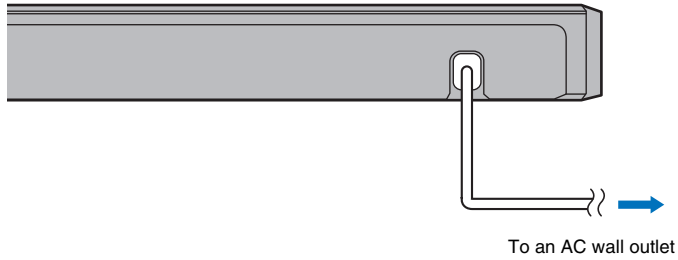

Subwoofer

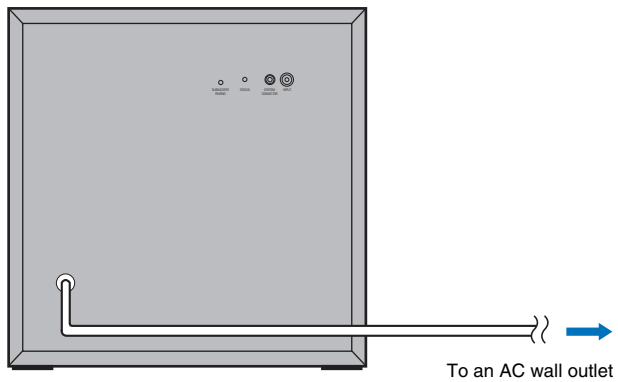

## Connecting the subwoofer

Plug the subwoofer's power cable into a wall outlet. When the center unit is turned on, the center unit and subwoofer are automatically connected via wireless connection. Once the connection has been successfully established, the STATUS indicator on the subwoofer glows as shown in the illustration below, and the unit is ready for play back.

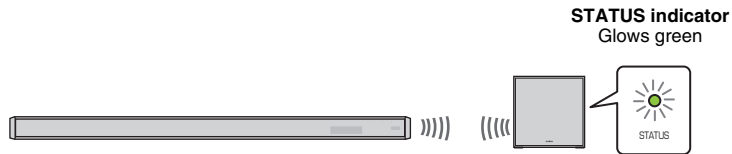

- If the STATUS indicator does not glow properly the first time the unit is turned on, pair the center unit and subwoofer manually. See "Pairing the center unit and subwoofer" (p. 105).

If there is no sound coming from the subwoofer, or if sound is intermittent, due to the influence of radio waves from other devices, connecting the center unit and subwoofer via cables will solve the problem. Connect the center unit and subwoofer via an RCA mono cable and a 3.5 mm monaural mini plug cable. A 3.5 mm monaural mini plug cable is required to turn the center unit and subwoofer on and off at the same time.

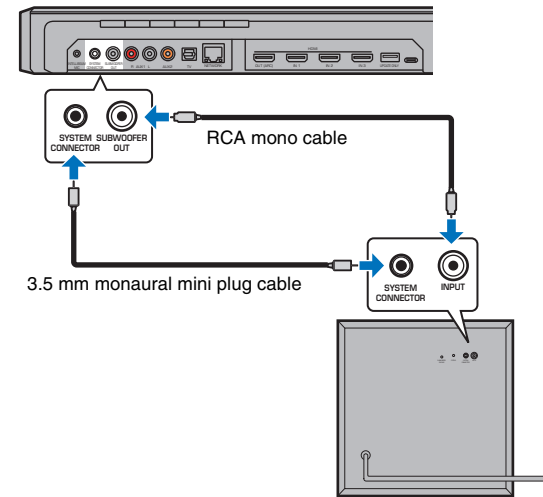

To connect the center unit and subwoofer using a wired connection, set "Bass Out" of "Subwoofer" in the setup menu to "Wired" (p. 76).

When the center unit is turned on, the subwoofer turns on and its STATUS indicator glows green.



- Be sure the center unit is turned off before connecting the subwoofer.
- The subwoofer supplied with the unit can only be connected.

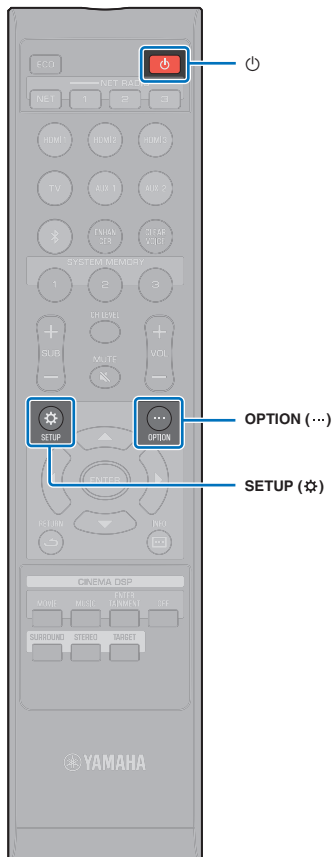

## 6 Initial settings

### Displaying the menu screen on the TV

Visual operation of this unit is possible by displaying its menu screen on the TV.

Turn on the unit and the TV, and then use the input button on the TV's remote control to switch input so that video input from this unit is displayed.

When this unit and the TV are connected as shown below, select "HDMI 1" using the TV's remote control.

TV remote control (example)

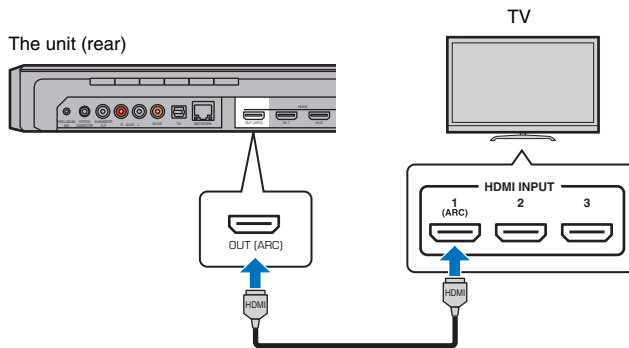
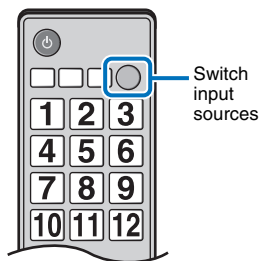

### The menu display

The menu is displayed on the TV screen when the SETUP (⚙️) key or OPTION (...) key is pressed. When the TV is receiving HDMI signals, the menu is superimposed over video content. Press the SETUP (⚙️) key or OPTION (...) key a second time to cancel menu display.

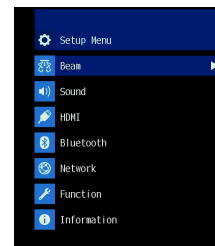

- The setup menu (p. 69) can only be displayed on a TV screen. It cannot be shown in the front panel display.

### Initial screen display

When the unit is turned on for the first time after purchase, the screen below will be displayed. ("ViewScreen" is shown in the front panel display.)

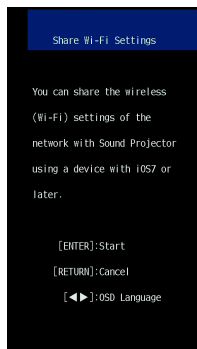

Follow the on-screen instructions to use an iOS device (iPhone, etc.) to connect the unit to a wireless network.

Connecting the unit to a wireless network is simpler when the MusicCast CONTROLLER app installed on your mobile device is used. Press the RETURN (↵) key to cancel this screen, and then refer to p. 50.



- This screen will not be displayed if the unit is connected to a router via its NETWORK jack (wired connection).
- Be aware that if the IntelliBeam microphone is connected while the screen shown above is displayed (p. 32), setup will be canceled, and the screen will switch to the auto measurement screen.

## Selecting a language for menu display

- 1 Turn the unit and TV on.
- 2 Switch the TV's input to display video input from this unit (p. 30).
- 3 Press and hold the SETUP (⚙) key until the "OSD Language" menu appears on the TV.



### When the menu is not displayed

- Confirm the following cases.
  - The HDMI input jack of your TV and the HDMI OUT (ARC) jack of the unit are connected.
  - The input of your TV is set to "HDMI 1" (example).

- 4 Use the ▲/▼ key to select the desired language and press the ENTER key.

### Settings

日本語, ENGLISH (default), DEUTSCH, FRANÇAIS, ESPAÑOL, ITALIANO, NEDERLANDS, РУССКИЙ, SVENSKA, TÜRK

- 5 Press the SETUP (⚙) key to exit the setup menu.

## Auto setup for appropriate surround effects (IntelliBeam)

First use the “IntelliBeam” function to adjust each channel so that this unit provides the optimal viewing and listening environment.



- The AUTO SETUP procedure may not be run successfully if this unit is installed in one of the rooms described in “Unrecommended listening environments” (p. 16). The My Surround function can be used to enjoy rich surround sound in these types of rooms as well. See “Channel Out” (p. 75) for more information.
- Do not connect the IntelliBeam microphone to an extension cable as doing so may result in an inaccurate sound optimization.

### Installing the IntelliBeam microphone

#### 1 Assemble the supplied cardboard microphone stand, and then position the IntelliBeam microphone.

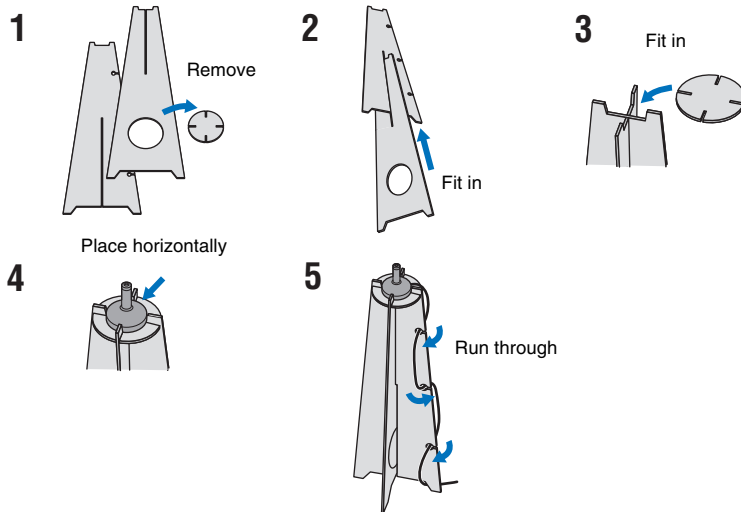

#### 2 Position the supplied cardboard microphone stand and IntelliBeam microphone at your listening position.



- Position the IntelliBeam microphone at the same height as your ears would be when you are seated.
- Position the IntelliBeam microphone so that it is parallel with the floor.
- A camera tripod or stool may also be used instead of the supplied cardboard microphone stand.

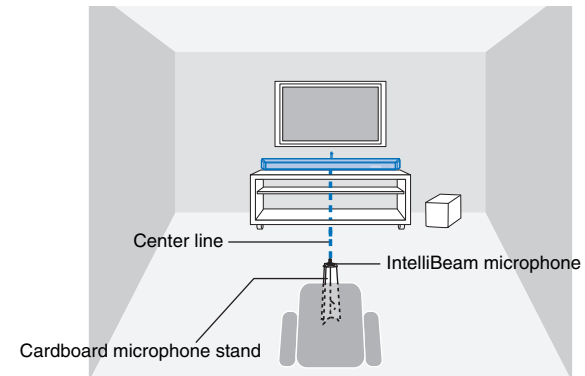
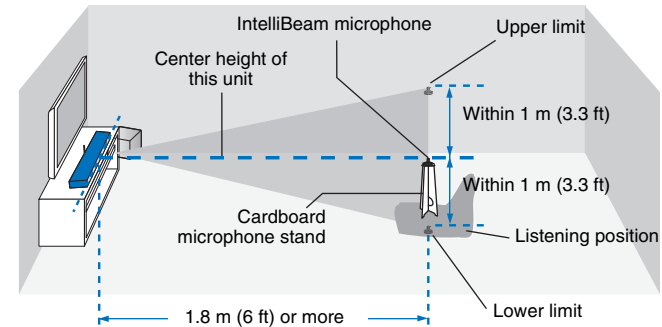

Make sure that there are no obstacles between the IntelliBeam microphone and the walls in your listening room as these objects obstruct the path of sound beams. However, any objects that are in contact with the walls will be regarded as a protruding part of the walls.



## Using AUTO SETUP (IntelliBeam)



- Test tones output during measurement are loud. Perform AUTO SETUP when no children are around and there is no possibility of their entering the listening room, as their hearing may be impaired.
- If there are curtains in your listening room, we recommend following the procedure below.
  1. Open the curtains to improve sound reflection.
  2. Run “Beam optimize only” (p. 35).
  3. Close the curtains.
  4. Run “Sound optimize only” (p. 35).
- Make sure that your listening room is as quiet as possible. For accurate measurement, turn off air conditioner or other devices that make noises.

### 1 Turn the unit and your TV on.

### 2 Switch TV input to the input jack (HDMI 1, etc.) to which this unit is connected (p. 30).

### 3 Connect the IntelliBeam microphone to the INTELLIBEAM MIC jack on the rear panel of the unit.

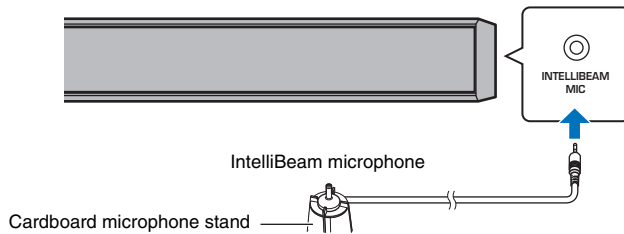

The screen below is displayed after connecting IntelliBeam microphone to the unit.

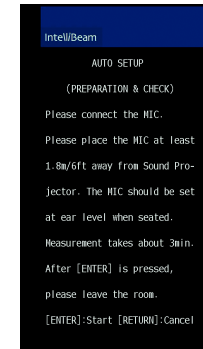

“AUTO SETUP” in the “IntelliBeam” menu can automatically adjust the following two settings.

<b>Beam optimize only</b>	This feature optimizes the beam angle so that the parameter best matches your listening environment.
<b>Sound optimize only</b>	This feature optimizes sound quality for each channel by measuring the acoustic characteristics of the listening environment.

“Beam optimize only” or “Sound optimize only” can be measured separately in the setup menu (p. 35).



- Follow the instructions below and then leave the room. If you remain in the room, you may obstruct the beam, or the microphone may pickup any sounds you make, possibly resulting in improper measurement.

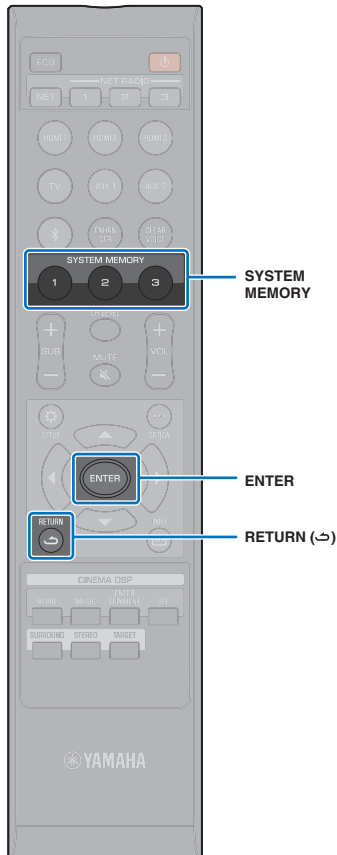

#### 4 Press the ENTER key to start the AUTO SETUP procedure and then leave the room within 10 seconds.

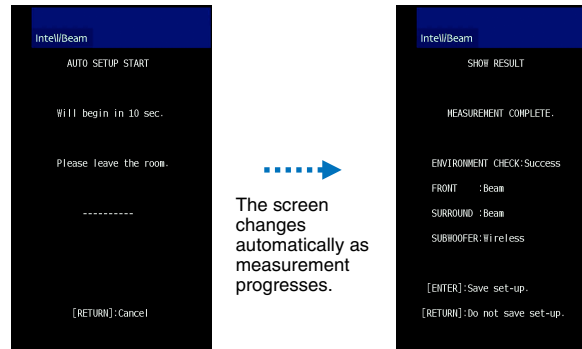

If the AUTO SETUP procedure is complete, this unit rings the chimes.



- The AUTO SETUP procedure takes about 3 minutes.
- To cancel the AUTO SETUP procedure after it is started, or if you do not want to apply the results, press the RETURN (↵) key.
- If an error occurs, an error buzzer sounds and an error message is displayed. For details on error messages, see "If an error message is displayed" (p. 36).

#### 5 Press the ENTER key.

The measurement results are applied and saved in the unit.

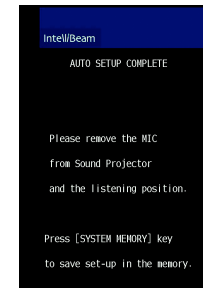

- You can save several measurement results by pressing the SYSTEM MEMORY 1, 2, or 3 key. When the SYSTEM MEMORY 1 key is pressed, "M1 Saving" is displayed, and settings are saved.
- If ambient noise is picked up after measurement begins, an error message is displayed in the "AUTO SETUP COMPLETE" screen prompting you to begin measurement again. Press the ENTER key to exit the error message screen, and begin measurement again.



- See page 46 for more information on the system memory function.

#### 6 Remove the IntelliBeam microphone.

The "AUTO SETUP COMPLETE" screen closes.

The IntelliBeam microphone is sensitive to heat, so should not be placed anywhere where it could be exposed to direct sunlight or high temperatures (such as on top of AV equipment).

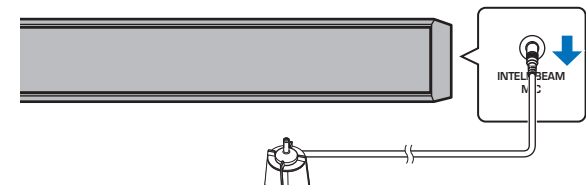

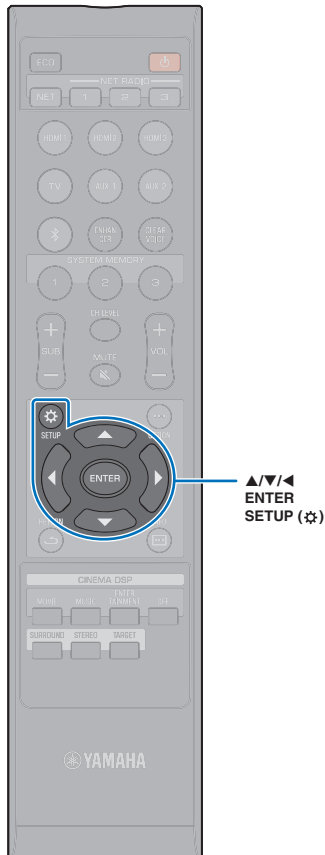

**❑ AUTO SETUP via the setup menu**

“Beam optimize only” or “Sound optimize only” can be measured separately in the setup menu.

- 1 Place the IntelliBeam microphone at your normal listening position, and press the SETUP (⚙️) key.**  
See “Installing the IntelliBeam microphone” (p. 32) for instructions on positioning the IntelliBeam microphone.
- 2 Press the ▲/▼ key to select “Beam” and then press the ENTER key.**
- 3 Press the ▲/▼ key to select “IntelliBeam” and then press the ENTER key.**
- 4 Press the ▲/▼ key to select one of the items below and then press the ENTER key.**

**Settings**

<b>Beam+Sound optimize</b>	Select this optimization feature if you make settings for the first time. This menu takes about 3 minutes.
<b>Beam optimize only</b>	Use to optimize the beam angle so that the parameter best matches your listening environment. This menu takes about 1 minute.
<b>Sound optimize only</b>	Use to optimize the beam delay, volume, and quality so that the parameters best match your listening environment. This menu takes about 2 minutes. You must optimize the beam angle with “Beam optimize only” before starting “Sound optimize only”. Select this optimization feature in the following cases: <ul style="list-style-type: none"> <li>• If you have opened or closed the curtains in your listening room before using this unit</li> <li>• If you have manually set the beam angle with “Beam optimize only”.</li> </ul>

**5 Connect the IntelliBeam microphone to this unit after “AUTO SETUP (PREPARATION & CHECK)” screen is displayed.**

For details on connecting IntelliBeam microphone, refer to “Using AUTO SETUP (IntelliBeam)” (p. 33).

**6 Follow steps 4, 5, and 6 under “Using AUTO SETUP (IntelliBeam)” to configure settings, and then remove the microphone.**



- When the AUTO SETUP procedure is performed from the setup menu, the menu selection screen of the setup menu appears. Press the SETUP (⚙️) key to exit the setup menu.

## ❑ If an error message is displayed

If an error message is displayed on the TV screen, see “Error messages” below to determine the cause and resolve the problem. Follow the instructions displayed on the TV screen to begin measurement again.

### Error messages

Error message		Cause	Remedy
<b>ERROR E-1</b>	<b>Please test in quieter environment.</b>	There is too much noise in your listening room.	Turn off devices, such as an air condition, that make noise, or move the unit away from such devices. You may want to choose certain hours during the day when there is not much noise coming from outside.
<b>ERROR E-2</b>	<b>No MIC detected. Please check MIC connection and re-try.</b>	The IntelliBeam microphone is disconnected.	Connect the IntelliBeam microphone to the INTELLIBEAM MIC jack on the front of this unit and begin measurement again.
<b>ERROR E-3</b>	<b>Unexpected control is detected. Please re-try.</b>	Some other operations were performed on this unit.	Begin measurement again. Do not perform any other operations with this unit during measurement.
<b>ERROR E-4</b>	<b>Please check MIC position. MIC should be set in front of Sound Projector. Please re-try.</b>	The IntelliBeam microphone is not placed in front of this unit.	Position the IntelliBeam microphone in front of this unit and begin measurement again.
<b>ERROR E-5</b>	<b>Please check MIC position. MIC should be set above 1.8m/ 6.0ft and re-try.</b>	The IntelliBeam microphone is not placed in the right distance from this unit.	Position the IntelliBeam microphone at a distance of more than 1.8 m (6 ft) from this unit and begin measurement again.
<b>ERROR E-6</b>	<b>Volume level is lower than expected. Please check MIC position/connection and re-try.</b>	The IntelliBeam microphone cannot collect the sound produced by this unit.	Position the IntelliBeam microphone properly, check the connection, and then begin measurement again.
<b>ERROR E-7</b>	<b>Unexpected error happened. Please turn off and re-try.</b>	An internal system error occurred.	Press the ⏻ key to turn off this unit, then run AUTO SETUP procedure again after turning this unit on.
<b>ERROR E-9</b>	<b>Please check the connection with subwoofer.</b>	The subwoofer is not connected properly.	<ul style="list-style-type: none"> <li>• Be sure that the subwoofer is connected (p. 29).</li> <li>• According to the subwoofer connection method (wired/ wireless), select “Subwoofer” from “Beam” and set “Bass Out” in the setup menu, and then begin measurement again.</li> </ul>

## Operating the unit by TV's remote control (HDMI control)

### What is the HDMI control function?

The HDMI control function (link function) coordinates operation of a TV and the unit so that the unit can be operated using the TV's remote control.

When a TV is connected to the unit with an HDMI cable, the TV's remote control can be used to perform the following operations.

#### Coordinated functions via the TV remote control

Remote control of TV (Example)

##### 1. Turn on/off

Both the TV and this unit turn on/off at the same time.

##### 2. Switch input sources

- The unit's input source switches accordingly when the TV's input source is switched.

Examples

- When a TV program is selected on the TV, the unit's audio input source is switched to the HDMI OUT (ARC) jack using the ARC function or TV input jack.
- When a BD/DVD player is connected to the HDMI IN 1 jack on the unit, the unit's input source switches to HDMI 1 when the BD/DVD player is selected with the TV's remote control.

- The input source can be switched while the unit is off.

##### 3. Switch the audio output device (TV or this unit (amplifier))

##### 4. Adjust volume

This unit's volume can be adjusted when the TV's audio output is set to this unit (amplifier).

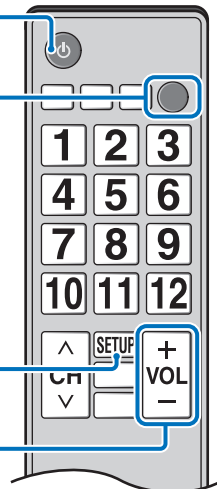

In addition to the functions in the left column, the unit's menus displayed on the TV can be operated with some TV.



- Even if your TV supports the HDMI control function, some functions may not be available. For details, refer to documentation supplied with your TV.
- We suggest using devices (TV, BD/DVD player, etc.) from the same manufacturer.



- If, after several attempts, you are unable to operate the unit with your TV's remote control, change the HDMI control setting for the unit, the TV, and any playback devices (p. 38).

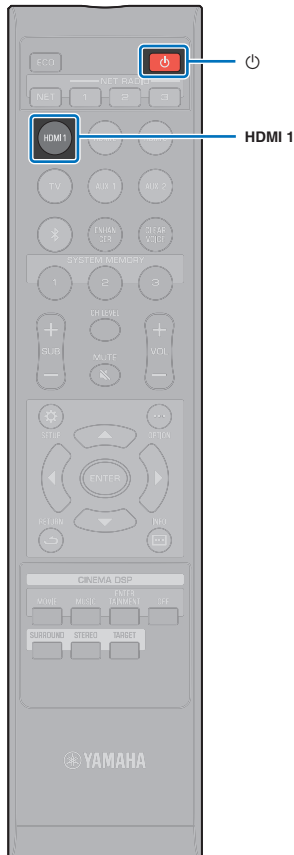

## Changing the HDMI control function

If you are unable to operate the unit with your TV's remote control, configure the HDMI control function as follows.

- 1 Turn on the unit, TV, and playback devices.
- 2 Enable the HDMI control function on the unit, TV, and playback devices such as BD/DVD players that support this function.

For this unit, confirm that "HDMI Control" is set to "On" (default setting) (p. 80).

Enable the HDMI control function on the TV and playback devices. Refer to documentation supplied with the TV or playback devices for details.

- 3 Turn off the main power of the TV and then turn off the unit and playback devices.
- 4 Turn on the unit and playback devices and then turn on the TV.
- 5 Switch TV input to the input jack (HDMI 1, etc.) to which this unit is connected.
- 6 Select HDMI 1–3 as an input source and confirm that the video of the playback device is displayed on the TV.

When the playback device is connected to the HDMI IN 1 jack, press the HDMI IN 1

HDMI 1 — Input source name

- 7 Check that the unit is properly coordinated with the TV by turning off the TV or adjusting the TV volume with the TV remote control.

### If devices are not coordinated

Confirm the settings are properly configured as described below.

- "HDMI Control" (p. 80) is set to "On" in the setup menu.
- The HDMI control function is enabled on the TV.

#### Examples of TV settings

- From the setup menu on your TV, select "Link setting" → "HDMI control setting", then set a setting such as "HDMI control function" to "ON".
- Set audio output to any option other than TV.
- Contact the manufacturer of your television for TV settings.

If devices fail to coordinate even after the settings described above have been applied correctly:

- Turn off this unit and the TV, and then turn them back on again.
- Disconnect the power cable of the unit and external devices connected to the unit via HDMI cable. Plug them in again after about 30 seconds.
- If devices fail to coordinate after TV, AUX1, or AUX2 is input, repeat steps 5 and 6 under "Changing the HDMI control function".

## Changing the connection method and connected devices

When changing connected devices, or the jacks via which devices are connected, reconfigure settings as follows.

- 1 Disable the HDMI control function of the TV and BD/DVD player, turn off all connected devices, and change the connections.
- 2 Perform steps 1 to 7 of "Changing the HDMI control function".

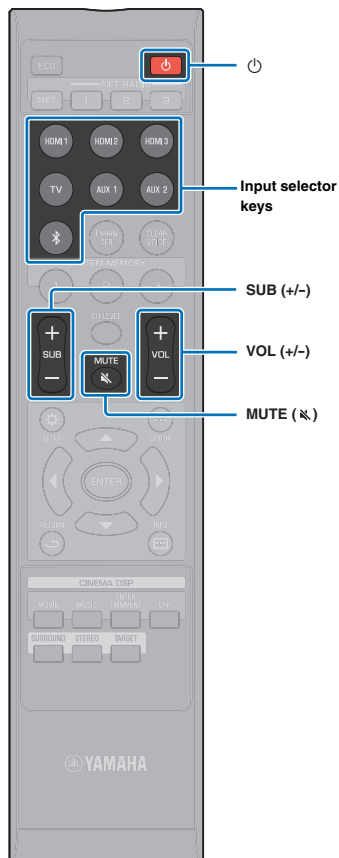

# PLAYBACK

## Basic operation for playback

### 1 Press the key to turn on this unit.

It may take a few seconds for sound to play from the center unit and subwoofer after the unit is turned on.

### 2 Turn on devices (TV, BD/DVD player, game console, etc.) connected to this unit.

### 3 Select a device by pressing the input selector key or NET key corresponding to the connection of external devices.

Press the HDMI1 key to play audio/video content from a BD/DVD player connected via the HDMI IN1 jack.

**HDMI 1** — Input source name

For playback from a *Bluetooth* device, refer to p. 47. For audio playback via a network, refer to p. 62 to 68.



- You can also select an input source with the MusicCast CONTROLLER app installed on your mobile device (p. 50).

### 4 Play back a device selected in step 3.

### 5 Press the VOL (+/-) key to adjust the volume. Press the SUB (+/-) key to adjust the volume of the subwoofer.

- When audio is output from both TV speaker and this unit, mute the TV sound.
- When sound input to HDMI IN jack is output from the TV, the volume level does not change even if you press the VOL (+/-) key or the MUTE (🔇) key.
- To mute the sound, press the MUTE (🔇) key. "MUTE ON" is shown in the front panel display. To resume the volume, press the MUTE (🔇) key again or press VOL (+/-) key. When the MUTE (🔇) key is pressed, "MUTE OFF" is shown in the front panel display.



- The subwoofer volume can be adjusted separately from the whole volume.
- Lowering the subwoofer volume is recommended at night.



- You can also adjust the volume with the MusicCast CONTROLLER app installed on your mobile device (p. 50).

### 6 Select surround playback, stereo playback, or target playback mode, and configure sound setting according to your preferences (p. 40).



SURROUND

## Enjoying sound based on your preference

This unit supports the following capabilities to enjoy sound based on your preference.

- Surround playback mode (p. 40)
- CINEMA DSP (p. 41)
- Stereo playback mode (p. 42)
- Target playback mode (p. 42)
- Compressed Music Enhancer (p. 43)
- CLEAR VOICE (p. 43)
- Volume adjustment for each channel (p. 43)

## Playback with surround sound

5-channel sound beams create a sound field for surround sound playback.

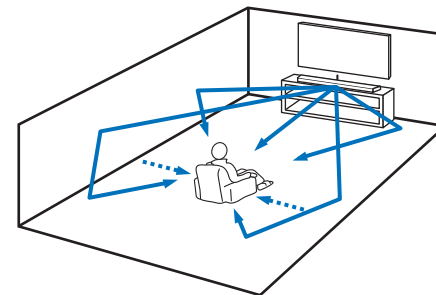

← Sound beams

←····· Channels created from the front and rear sound beams (p. 75)

### 1 Press the SURROUND key to switch to surround mode.

“SURROUND” is shown in the front panel display.

SURROUND



- Configuring Channel Out settings (p. 75) in the setup menu allows for more precise configuration of beam settings in accordance with the audio source and listening room setup.





CINEMA DSP

## Enjoying three-dimensional surround sound (CINEMA DSP)

Select the desired CINEMA DSP program according to the audio source and your preferences. Yamaha's exclusive sound field reproduction technology (CINEMA DSP) easily reproduces realistic sound fields comparable to those found in movie theaters and concert halls, allowing users to enjoy a natural and three-dimensional listening environment.

### 1 Press the CINEMA DSP (MOVIE, MUSIC, or ENTERTAINMENT) key repeatedly to select the desired program.

The CINEMA DSP program name appears in the front panel display.



- The CINEMA DSP programs are not available in the following conditions.
  - In stereo playback mode (p. 42) or target playback mode (p. 42)
  - Audio signals with sampling frequency of higher than 48 kHz are being played.
  - My Surround function is used (p. 76).
- This unit memorizes a program assigned to each input source. When you select another input, the unit automatically recalls the last program for the selected input.

## CINEMA DSP options

### MOVIE (use the MOVIE key to select)

<b>Sci-Fi</b>	This program clearly reproduces dialogs and special sound effects of the latest science fiction films and lets you feel a broad and expansive cinematic space.
<b>Adventure</b>	This program reproduces the thrilling environment of the latest action films and lets you feel the dynamic and excitement of fast-moving scenes.
<b>Spectacle</b>	This program reproduces the wide and grand environment and lets you have added impressions on spectacular scenes with strong visual impacts.

### MUSIC (use the MUSIC key to select)

<b>Music Video</b>	This program produces a vibrant environment and lets you feel as if you are at an actual jazz or rock concert.
<b>Concert</b>	This program creates a rich surround effect of a large round concert hall with a great deal of presence, emphasizing the extension of sounds, and lets you feel as if you are seated close to the center of the stage.
<b>Jazz Club</b>	This program recreates the acoustic environment of "The Bottom Line", a famous jazz club in New York once and lets you feel as if you are seated right in front of the stage.

### ENTERTAINMENT (use the ENTERTAINMENT key to select)

<b>Sports</b>	This program reproduces the energetic environment of live sports broadcasting, converging a commentator's voice on the center and broadening the overall atmosphere of the stadium, and lets you feel as if you are seated at an actual stadium or a ball park.
<b>Talk Show</b>	This program reproduces excitement of live talk shows. It enhances the ambience of gaiety while keeping the conversations at a comfortable volume.
<b>Drama</b>	This program stables reverberations that match a wide range of movie genres from serious dramas to musicals and comedies, and offers an optimum 3D feeling, reproducing effects tones and background music softly but cubically around clear words.
<b>Game</b>	This program is suitable for role-playing and adventure games. It utilizes the sound field effects for movies to represent the depth and spatial feeling of the field during play, while offering movie-like surround effects in the movie scenes in the game.

### Playback without using CINEMA DSP (press the OFF key)

<b>DSP Off</b>	CINEMA DSP is not used and audio content is played in surround mode.
----------------	--

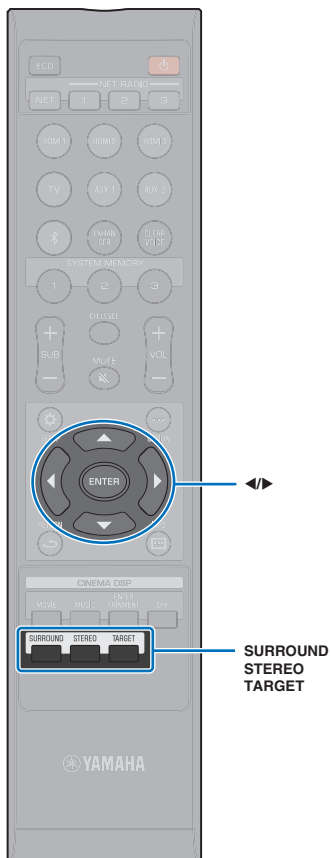

## 2-channel playback (stereo playback mode)

2-channel stereo playback using the right front and left front channels is enabled. When multi-channel audio signals are input, they are down-mixed to 2 channels.

- 1 Press the **STEREO** key to switch to stereo playback mode.

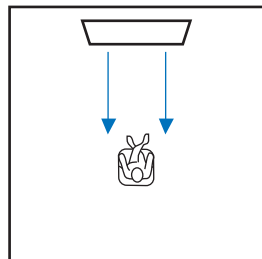

## Delivering sound to a specified location (target playback mode)

Target playback mode outputs sound beams from a single channel for optimal listening from a specific position. Refer to the illustrations below.

For listening at low volumes, such as at night

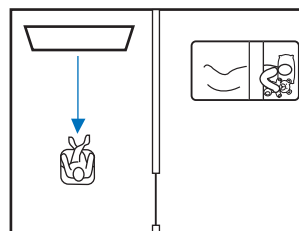

For clear sound at a distance

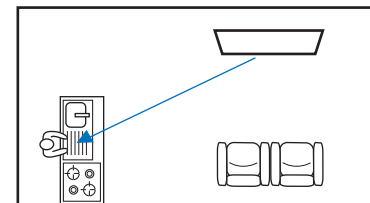

Play an input source, and adjust the beam angle.

- 1 Press the **TARGET** key.
- 2 Use the **◀▶** key to adjust beam angle.

The angle to the left increases by 2 degrees each time the **◀** key is pressed; the angle to the right increases by 2 degrees each time the **▶** key is pressed.

A maximum angle of 90 degrees in either direction is possible.

Beam angle adjusted 16 degrees to the left



### Disabling target playback mode

Press the **SURROUND** key or **STEREO** key to turn target playback mode off.



- The **CINEMA DSP** programs are not enabled in target playback mode.
- Bass output is controlled to prevent sounds from spreading in other directions.

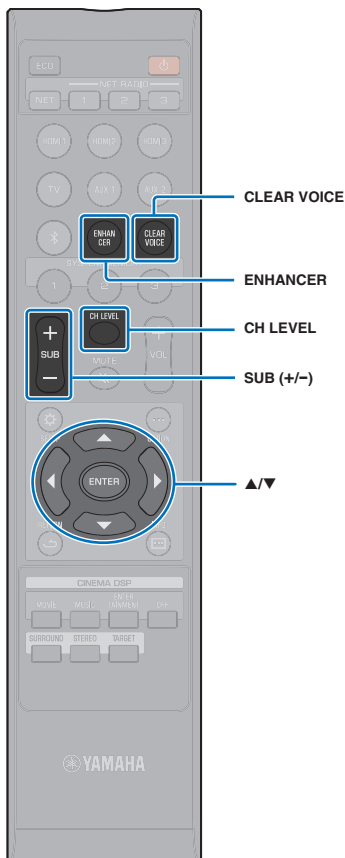

## Playing back digitally compressed formats (such as MP3, etc.) with enriched sound (Compressed Music Enhancer)

Play back digitally compressed formats such as MP3, with emphasis on bass and treble for extended dynamic sounds.

### 1 Press the ENHANCER key to turn on the Compressed Music Enhancer function.

Press the key again to turn off the function.



- Compressed Music Enhancer is disabled when digital audio signal with a sampling rate greater than 48 kHz is input.
- By default, this function is set to "ON" when the input source is *Bluetooth*. It is set to "OFF" with any other input source.
- This unit memorizes the "ON" or "OFF" setting assigned to each input source. When you select another input, the unit automatically recalls the last setting for the selected input.

## Clear playback of human voices (CLEAR VOICE)

Human voices, such as lines in movies and TV shows, or news and sports commentary, are played back very clearly.

### 1 Press the CLEAR VOICE key to turn on the CLEAR VOICE function.

Press the key again to turn off the function.

## Adjusting volume for each channel

Adjust the volume of playback for each channel (audio in each direction) so that sounds are evenly distributed in their respective directions.



- Refer to "Channel Level" (p. 77) when adjusting the volume of each channel with the test sound.

### 1 Hold down the CH LEVEL key for more than 3 seconds.

### 2 Press the CH LEVEL key to select the channel.

FL: Front left

FR: Front right

C: Center

SL: Surround left

SR: Surround right

SUB: Subwoofer

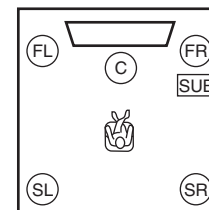

- Adjusting the channel level is not available in target playback mode.
- SUB (subwoofer) volume can only be adjusted in stereo playback mode (p. 42).
- Volume for the following channels can be adjusted when "My Surround" is set to "On" (p. 76).

C: Center

SL/SR: Surround (left/right)

SUB: Subwoofer

### 3 Press the ▲/▼ key to adjust the volume.

Adjustable range: -20 to +20



#### Examples of volume balance adjustment

- If you have problems hearing words: Select C (center) to increase the level. When the sound is not like surround sound: Select SL (surround left) or SR (surround right) to increase the level.
- The volume of the subwoofer can also be adjusted by using the SUB (+/-) key.



▲/▼/◀  
ENTER  
OPTION (...)

## Adjusting tones

Use the option menu to adjust the level at which high (treble) and low (bass) tones are output while listening to sound.

Tones can be set for each of the following input sources.

HDMI 1–3, TV, AUX 1–2, *Bluetooth*, NET



- The option menu is displayed on, and operated from, the TV screen or front panel display. This section uses illustrations of the front panel display as examples.

- 1** Press the **OPTION (...)** key.
- 2** Press the **▲/▼** key to select “**TREBLE**” or “**BASS**”, and press the **ENTER** key.

TREBLE

- 3** Press the **▲/▼** key to adjust the output level.

The adjustable range is -12 to +12 (default: 0).

0

- 4** Press the **◀** key.
- 5** Repeat steps 2 and 3 to adjust the output level for treble and bass.
- 6** Press the **OPTION (...)** key to exit the option menu.

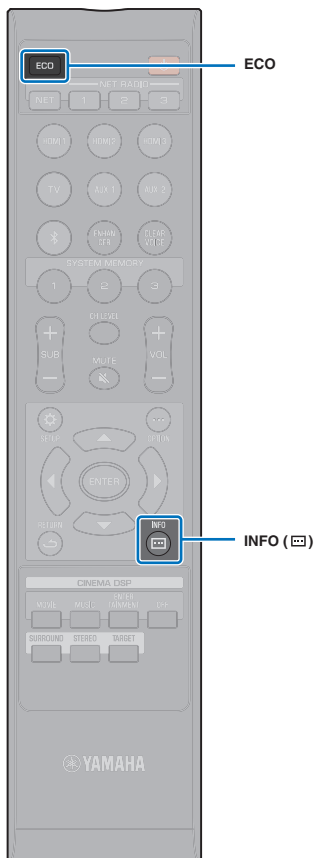

## Using useful features

### Saving energy with the Eco function

Using the Eco function to reduce the amount of power consumed by this unit.

When this function is enabled, the brightness of the front panel display is minimized and the maximum volume is reduced.

#### 1 Press the ECO key.

“ECO ON” is displayed and the front panel display turns off.

ECO ON

The brightness of STATUS indicator is minimized.

#### Disabling the Eco function

Press the ECO key.

“ECO OFF” is displayed in the front panel display.



- Disable this function for louder playback.
- When this function is enabled, “Dimmer” in the setup menu (p. 85) and “MAX VOLUME” in the advanced setup menu (p. 89) cannot be configured.

### Switching information displayed in the front panel display

Information regarding the input source, surround sound, and subwoofer is displayed.

#### 1 Press the INFO ( ) key.

Display changes as follows each time the INFO ( ) key is pressed. The information varies according to the input source.

Input: Name of the input source  
 (“BLUETOOTH”, or the name of the connected device, is displayed with *Bluetooth* input.)

Beam: Playback mode

Decoder: Current decoder (p. 78)

Cinema DSP: CINEMA DSP program (p. 41)

SUB Status: Subwoofer status



- Display in playback mode (Beam)
  - SURROUND: Playback in surround mode (p. 40)
  - MY SUR.: Playback using the My Surround function (p. 76)
  - STEREO: Stereo playback (p. 42)
  - TARGET: Playback in target playback mode (p. 42)
- Subwoofer status display (SUB Status)
  - Wireless: The center unit is connected to the subwoofer via a wireless connection (p. 29).
  - None: No subwoofer is connected to the unit.
  - Wired: When “Bass Out” in the setup menu is set to “Wired” (p. 76).

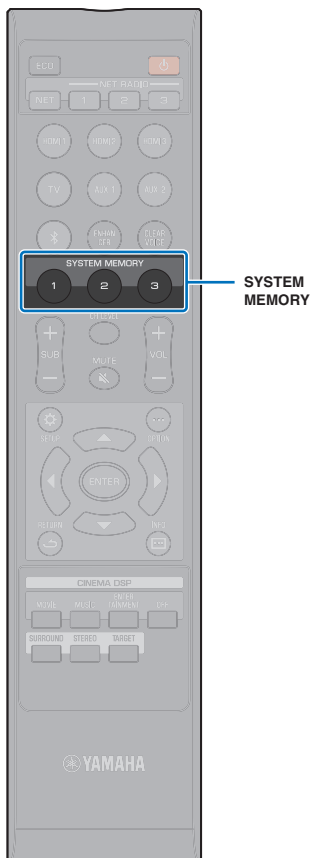

## Saving this unit's settings to system memory

Three sets of settings can be saved to this unit's memory, enabling quick loading of settings optimized for specific listeners or environmental changes as needed. Refer to the examples below to save IntelliBeam measurement results and settings such as surround setting to system memory, or to load a pre-defined settings.

### Example 1 Saving the IntelliBeam measurements for different environments to system memory

If materials that absorb sound, such as curtains, obstruct sound beams, the effectiveness of those beams decreases. Measure with the curtains open and again with them closed. Save both sets of settings to SYSTEM MEMORY 1 and 2, and load the appropriate settings as needed.

### Example 2 Saving frequently used settings to system memory

**SYSTEM MEMORY 1:** Surround setting

**SYSTEM MEMORY 2:** A target playback mode setting that projects sound beams toward the kitchen

**SYSTEM MEMORY 3:** A target playback mode setting that projects sound beams toward the living room

### Example 3 Saving preferred listener settings to system memory

**SYSTEM MEMORY 1:** Settings configured for Dad

**SYSTEM MEMORY 2:** Settings configured for Mom

**SYSTEM MEMORY 3:** Settings configured for parties

The following settings can be saved to system memory.

- IntelliBeam measurement results (p. 33)

See page 35 for instructions on saving measurement results for IntelliBeam.

(When "Horizontal Angle", "Beam Travel Length", "Focal Length", "Image Location", and "Channel Level" are configured in the setup menu (p. 69), these settings are applied to IntelliBeam's AUTO SETUP measurements.)

- Surround playback (p. 40), stereo playback (p. 42), or target playback mode (p. 42)  
(The Channel Out settings (p. 75) can also be saved for surround playback mode.)
- Surround: CINEMA DSP (p. 41)
- Tone control (p. 44)
- Subwoofer settings (p. 76)

## Saving settings to system memory

**1 Hold down the SYSTEM MEMORY 1, 2, or 3 key until "M1 Save?", "M2 Save?", or "M3 Save?", corresponding to the button pressed, is displayed.**

**2 Press the same SYSTEM MEMORY key again.**

When the SYSTEM MEMORY 1 key is pressed, "M1 Saving" is displayed, and settings are saved.



- If system settings are already stored in the selected memory number, this unit overwrites the old settings.
- The memory function cannot be set when "MEMORY PROTECT" is set to "ON" in the advanced setup menu (p. 89).

## Loading settings

**1 Press the SYSTEM MEMORY 1, 2, or 3 key corresponding to settings to be loaded.**

If the SYSTEM MEMORY 1 key is pressed, "M1 Load?" will be displayed.

**2 Press the same SYSTEM MEMORY key again.**

When the SYSTEM MEMORY 1 key is pressed, "M1 Loading" is displayed, and settings are loaded.

## Wireless playback of audio via *Bluetooth* connection

The unit can be used to receive and play audio from a *Bluetooth* device, and to transmit audio for playback on a *Bluetooth* device.

See documentation supplied with your *Bluetooth* device for more information.

### □ Receiving audio from a *Bluetooth* device

Audio from a *Bluetooth* device, such as a mobile device or a digital music player, can be played over a wireless connection.

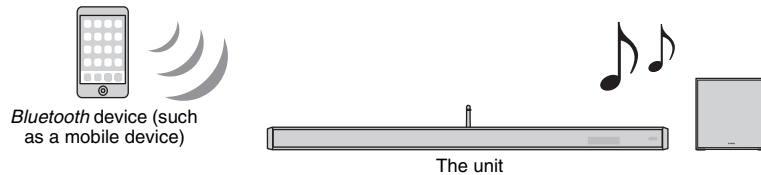

### □ Transmitting audio to a *Bluetooth* device

Use *Bluetooth* wireless headphones and the like to listen to audio.

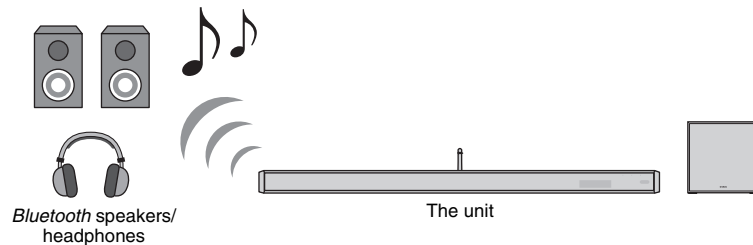

- Audio cannot be received by the unit from mobile devices and the like, and transmitted to speakers or headphones at the same time.



- "Bluetooth" in the setup menu must be set to "On" (default; p. 81) to use *Bluetooth* functions.
- A *Bluetooth* device that has been assigned a passkey (PIN) other than "0000" cannot be connected to the unit.
- Be sure that the *Bluetooth* device is no farther than 10 m (33 ft) from the unit when connecting the two.
- Refer to "Bluetooth" (p. 98) in "Troubleshooting" if a *Bluetooth* connection cannot be established.
- Adjust the *Bluetooth* device's volume as needed.



## Listening to music from a *Bluetooth* device (Receiving)

### 1 Press the key on the remote control.

*Bluetooth* is selected as an input source, and “BLUETOOTH” is shown in the front panel display.

BLUETOOTH



- If a *Bluetooth* device has been connected before, the unit will connect to the last connected device when the  key is pressed. Terminate this connection to connect a new device.

### 2 Turn on the *Bluetooth* function on the *Bluetooth* device.

The operation varies depending on the device. Refer to documentation supplied with the device.

### 3 Select “YSP-2700”\* in the *Bluetooth* device list on the device.

\* If the unit is registered as a MusicCast-enabled device (p. 50), the room name (network name) is displayed.

If a passkey (PIN) is required, enter the number “0000”.

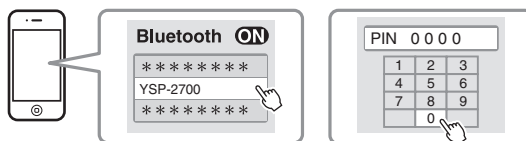

The  indicator in the front panel display flashes while the unit and *Bluetooth* device are being connected, and glows steadily when the connection is established.



“Connect” is shown in the front panel display.

The  indicator or a completion message is displayed on the *Bluetooth* device.

### 4 Play back a song on the *Bluetooth* device.

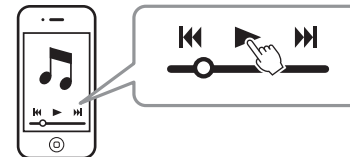

- With some *Bluetooth* devices, this unit must be specified as the destination for audio output.
- Setting “Network Standby” in the setup menu to “On” allows the unit to be turned on and off with *Bluetooth* device operations (p. 84).

## Terminating *Bluetooth* connection

Perform one of the following operations to terminate *Bluetooth* connection.

The  indicator on the unit’s front panel turns off when the connection is terminated.

- Turn off the *Bluetooth* function on the *Bluetooth* device.
- Press the  key for more than 3 seconds.
- Switch the unit’s input source to any input source other than *Bluetooth*.
- Turn off the unit.



- When *Bluetooth* connection is terminated, “Disconnect” is shown in the front panel display.



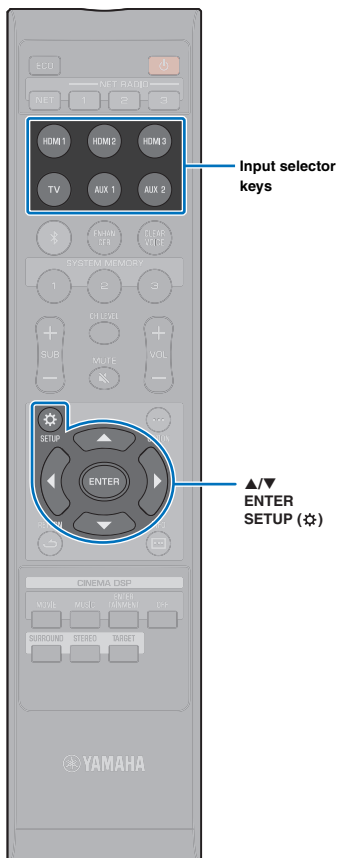

## Listening to audio through *Bluetooth* speakers or headphones (transmitting)



- Music input using AirPlay cannot be output to *Bluetooth* devices.



- The MusicCast CONTROLLER app installed on your mobile device (p. 50) can also be used to transmit audio to a *Bluetooth* device.

- 1 Turn on the *Bluetooth* device.
- 2 Select the input source (other than *Bluetooth*) with the input selector keys.



- If a *Bluetooth* device has been connected before, the unit will connect to the last connected device when the input source is selected in step 2. Terminate this connection to connect a new device.

- 3 Press the **SETUP** (⚙) key.  
The setup menu is displayed on the TV screen.

- 4 Use the **▲/▼** keys to select “*Bluetooth*”, and then press the **ENTER** key.

- 5 Use the **▲/▼** keys to select “*Transmission*”, and then press the **ENTER** key.

- 6 Use the **▲/▼** keys to select “*On*”, and then press the **ENTER** key.

- 7 Use the **▲/▼** keys to select “*Device Search*”, and then press the **ENTER** key.

- 8 Use the **▲/▼** keys to select a *Bluetooth* device, and then press the **ENTER** key.

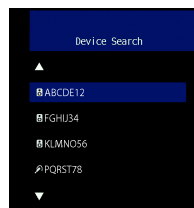

The  indicator in the front panel display flashes while the unit and *Bluetooth* device are being connected, and glows steadily when the connection is established.



“Completed” is shown in the front panel display.

- 9 Play an audio source, and enjoy music via the *Bluetooth* device.



- “Not found” is displayed on the screen with step 8 if the unit was unable to find a device to which to connect.
- “No Device Name” replaces the device name on the screen with step 8 if the unit is unable to recognize the name of the device.
- Audio will also be output from the unit.

### Terminating *Bluetooth* connection

Perform one of the following operations to terminate *Bluetooth* connection.

The  indicator on the unit’s front panel turns off when the connection is terminated.

- Terminate *Bluetooth* connection from the *Bluetooth* device, or turn off the *Bluetooth* device.
- Set “*Transmission*” in the setup menu to “*Off*”.
- Turn off the unit.

# NETWORKS

## Network functions and the MusicCast CONTROLLER app

A network connection allows you to listen to Internet radio stations or music streaming services, and to use AirPlay to play music files, or to play music files stored on your computer (media server) via this unit.

Most playback requires the “MusicCast CONTROLLER” app for mobile devices. Install and use the MusicCast CONTROLLER app on your mobile device to play music files.



- To use network function, the unit, your PC and mobile device must be connected to the same router. Make sure whether the network parameters (such as the IP address) are properly assigned to the unit in “Information” (p. 82) in the setup menu.
- When using a multiple SSID router, access to the unit might be restricted depending on the SSID to connect. Connect the unit and mobile device to the same SSID.
- Some security software installed on your computer, or network device settings (such as a firewall), may block the unit’s access to your computer or Internet radio stations. Should this occur, change security software and/or network device settings.
- A network connection cannot be established if the MAC address filter on your router is enabled. Check your router’s settings.
- To configure your router’s subnet mask manually, apply the same subnet used by this unit to all devices.
- Use of a broadband connection is recommended when using Internet services.



- If your router supports DHCP, network settings for the unit need not be configured. Network parameters (such as the IP address) will be assigned automatically. If your router does not support DHCP, or if you prefer to configure network parameters manually, you must configure network settings yourself (p. 83).
- You can verify that network parameters (such as the IP address) have been properly assigned to the unit by selecting “Information” (p. 82) from the setup menu.

## Connecting with the MusicCast CONTROLLER app (registering the unit as a MusicCast-enabled device)

Install the MusicCast CONTROLLER app on your mobile device to connect the unit to a network and register it as a MusicCast-enabled device.



- Confirm that your mobile device is connected to your home router before beginning.
- This section uses MusicCast CONTROLLER app screens displayed in English on an iPhone as examples.
- MusicCast CONTROLLER app screens and menu labels are subject to change without prior notice.

### 1 Install the MusicCast CONTROLLER app on your mobile device, and open the app.

Search for “MusicCast CONTROLLER” on the App Store or Google Play.

## 2 Tap “Setup”.

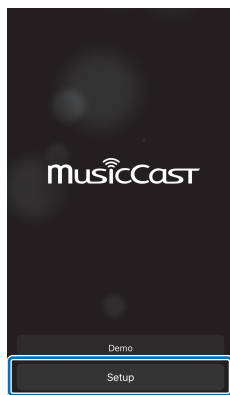

## 3 Turn on the unit, and then tap “Next”.

## 4 Hold down the CONNECT key on the unit until “CONNECT” is displayed on the front panel display, and tap “Next”.



- When a screen like that below is displayed, follow the on-screen instructions to configure network settings.

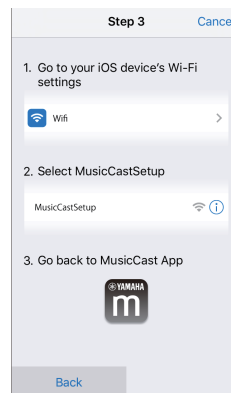

1. Use the Home button on your mobile device to return to the Home screen.
2. Select “Wi-Fi” from “Settings”.
3. Select “MusicCastSetup” from “CHOOSE A NETWORK...”.
4. Use the Home button to return to the MusicCast CONTROLLER app.

- When a screen like that at left below is displayed, select the network to which the unit will be connected and enter the router's password.

The router's password is often noted on the router itself. Refer to documentation supplied with the router for details.

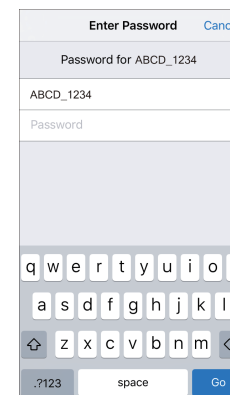
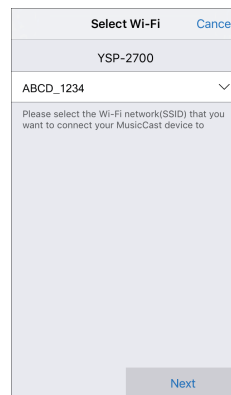

## 5 To register the unit as a MusicCast-enabled device, configure the following items.

- Location name (“home”, “John’s house”, etc.)
- Name and photo of the room where the unit is installed

The location name, and the name and photo of the room where the unit is installed can be changed later.

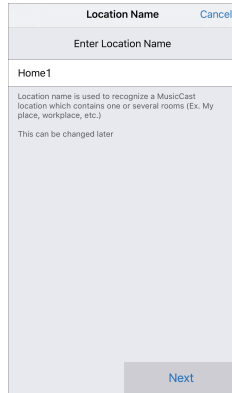

The screenshot shows a configuration screen titled "Location Name" with a "Cancel" button in the top right. Below the title is a text input field labeled "Enter Location Name" containing the text "Home 1". Underneath the input field, there is explanatory text: "Location name is used to recognize a MusicCast location which contains one or several rooms (Ex. My place, workplace, etc.)" and "This can be changed later". A "Next" button is located at the bottom right of the screen.

Network connection with the MusicCast CONTROLLER app is now complete, and the unit has been registered as a MusicCast-enabled device.



- If a different MusicCast-enabled device is already registered with the MusicCast CONTROLLER app, tap  (Setup) in the room selection screen, and then select “Add New Device” to add the unit to the app.

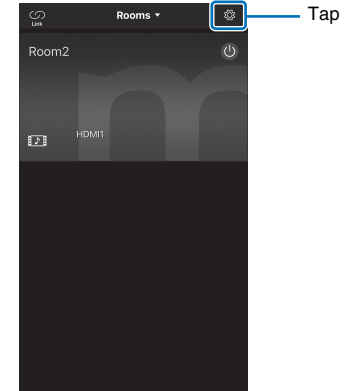

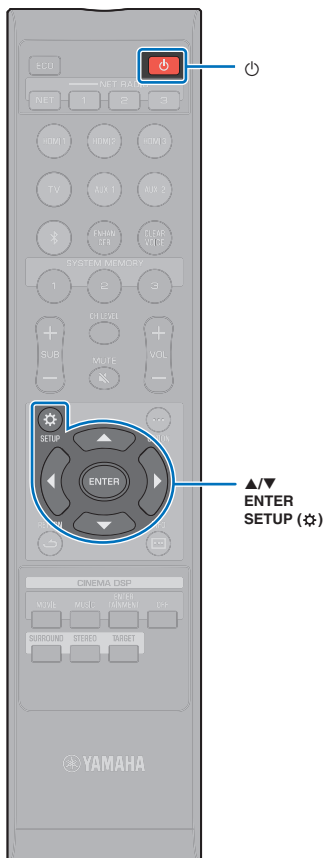

## Using connection methods other than the MusicCast CONTROLLER app (wireless network)

Use the setup menu on the unit to connect to a wireless network without using the MusicCast CONTROLLER app.

- Sharing the iOS device setting (p. 53)
- Using the WPS push button configuration (p. 54)
- Searching for a wireless router (access point) (p. 55)
- Setting up the wireless connection manually (p. 57)
- Using the WPS PIN code (p. 59)



- Once the unit has been connected to a wireless network using any of the methods described above, network settings will change when connection to a wireless network is established with the MusicCast CONTROLLER app.
- AirPlay is the only network function that can be used without the MusicCast CONTROLLER app.

### Sharing the iOS device setting

You can easily setup a wireless connection by applying the connection settings on iOS devices (such as an iPhone).

Before proceeding, confirm that your iOS device is connected to a wireless router (access point).



- You need iOS device with iOS 7 or later.
- The connection settings on iOS devices cannot be applied to the unit to establish a wireless connection if your wireless router (access point) uses WEP encryption. See “Searching for a wireless router (access point)” (p. 55) to establish a connection.

- 1 Press the key to turn on this unit.
- 2 Turn on the TV and switch the TV input to display video from the unit (HDMI OUT jack; p. 30).

- 3 Press the **SETUP** (⚙️) key.

The setup menu is displayed on the TV screen.

- 4 Use the **▲/▼** keys to select “Network”, and press the **ENTER** key.

- 5 Use the **▲/▼** keys to select “Network Connection”, and press the **ENTER** key.

- 6 Use the **▲/▼** keys to select “Wireless (Wi-Fi)”, and press the **ENTER** key.

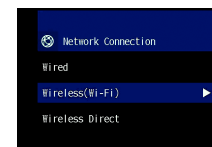

- 7 Use the **▲/▼** keys to select “Share Wi-Fi Settings (iOS)”, and press the **ENTER** key.

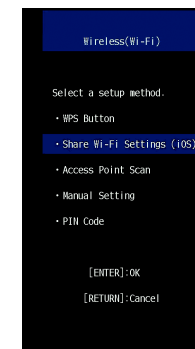

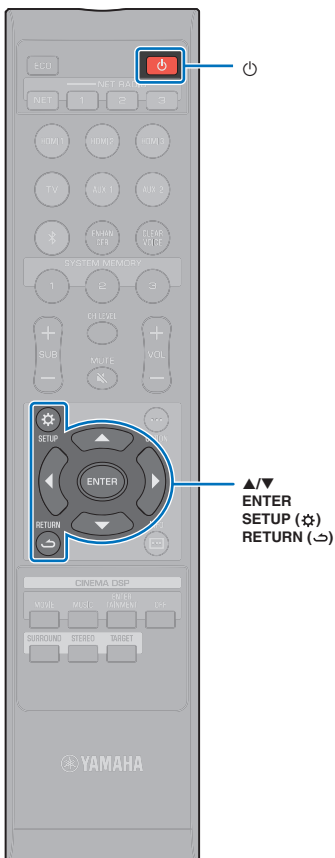

**8** When the following screen is displayed, press the **ENTER** key.

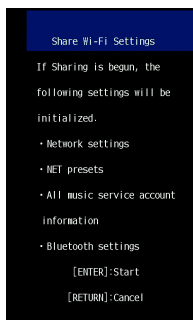

- The settings to be deleted (initialized) will be displayed. If you do not want to delete these settings, press the RETURN (↵) key to terminate the connection.

**9** When the following screen is displayed, press the **ENTER** key.



**10** Display the Wi-Fi setup screen on the iOS device and select the unit from “**SETUP A NEW AIRPLAY SPEAKER...**”.

Follow the on-screen instructions displayed on the iOS device.

## Using the WPS push button configuration

A wireless connection can be established by pressing WPS button on the wireless router (access point).

**1** Press the **⏻** key to turn on this unit.

**2** Turn on the TV and switch the TV input to display video from the unit (HDMI OUT jack; p. 30).

**3** Press the **SETUP (⚙)** key.

The setup menu is displayed on the TV screen.

**4** Use the **▲/▼** keys to select “**Network**”, and then press the **ENTER** key.

**5** Use the **▲/▼** keys to select “**Network Connection**”, and then press the **ENTER** key.

**6** Use the **▲/▼** keys to select “**Wireless (Wi-Fi)**”, and then press the **ENTER** key.

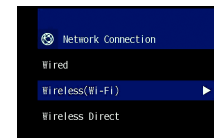

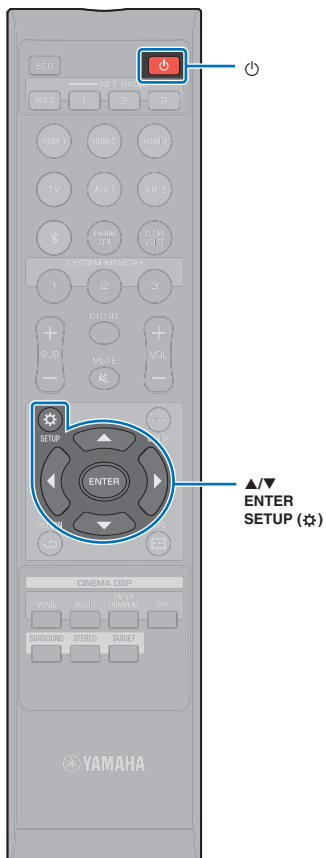

**7** Use the ▲/▼ keys to select “WPS Button”, and then press the ENTER key.

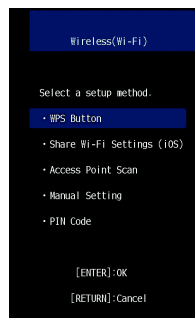

**8** Push the WPS button on the wireless router (access point).

When a connection has been established, “Completed” will be displayed on the TV screen.

If “Not connected” is displayed, press the ENTER key to repeat the procedure beginning with step 6, or see the information below to try another connection method.



- The WPS button cannot be used to establish a wireless connection if your wireless router (access point) uses WEP encryption, or if the router’s MAC address filter is enabled. See “Searching for a wireless router (access point)” (p. 55) to establish a connection.
- The WPS button cannot be used to establish a wireless connection if your wireless router (access point) is configured so that it does not broadcast its SSID. See “Setting up the wireless connection manually” (p. 57) to establish a connection.

**9** Press the SETUP (⚙️) key to exit the setup menu.

**About WPS**

WPS (Wi-Fi Protected Setup) is a standard established by the Wi-Fi Alliance, which allows easy establishment of a wireless home network.

**Searching for a wireless router (access point)**

Find and connect to a nearby wireless router (access point).

- 1** Press the key to turn on this unit.
- 2** Turn on the TV and switch the TV input to display video from the unit (HDMI OUT jack; p. 30).
- 3** Press the SETUP (⚙️) key.  
The setup menu is displayed on the TV screen.
- 4** Use the ▲/▼ keys to select “Network”, and then press the ENTER key.
- 5** Use the ▲/▼ keys to select “Network Connection”, and then press the ENTER key.
- 6** Use the ▲/▼ keys to select “Wireless (Wi-Fi)”, and then press the ENTER key.

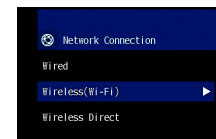



▲/▼/◀/▶  
ENTER  
SETUP (⚙️)

- 7** Use the ▲/▼ keys to select “Access Point Scan”, and then press the ENTER key.

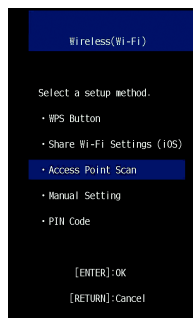

The list of available access points appears on the TV screen.

- 8** Use the ▲/▼ keys to select the desired access point and press the ENTER key.

The wireless connection setting screen appears on the TV.



- 9** Press the ENTER key.

- 10** Use the ◀/▶/▲/▼ and ENTER keys to enter the security key.



[←]/[→]: Move the cursor left and right.  
[Space]: Enter a space.  
[BKSP]: Delete the character to the left of the selected one.  
[DELETE]: Delete the selected character.  
[CLEAR]: Delete all characters entered.  
[CANCEL]: Cancel character entry, and return to the previous screen.

Once the security key been entered, select “OK”, and then press the ENTER key. The screen will return to that displayed in step 8.

- 11** Use the ▲/▼ keys to select “Connect” and press the ENTER key to start the connection process.

When a connection has been established, “Completed” will be displayed on the TV screen.

If “Not connected” is displayed, press the ENTER key to repeat the procedure beginning with step 6, or see the information below to try another connection method.



- “Access Point Scan” cannot be used to establish a wireless connection if your wireless router (access point) is configured so that it does not broadcast its SSID. See “Setting up the wireless connection manually” (p. 57) to establish a connection.

- 12** Press the SETUP (⚙️) key to exit the setup menu.



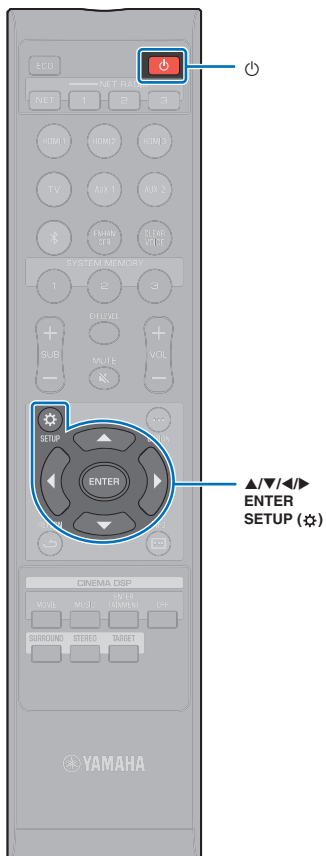

## Setting up the wireless connection manually

Setup the SSID (network name), encryption method and security key for your network manually.

- 1 Press the  key to turn on this unit.
- 2 Turn on the TV and switch the TV input to display video from the unit (HDMI OUT jack; p. 30).
- 3 Press the SETUP (⚙️) key.  
The setup menu is displayed on the TV screen.
- 4 Use the ▲/▼ keys to select “Network”, and then press the ENTER key.
- 5 Use the ▲/▼ keys to select “Network Connection”, and then press the ENTER key.
- 6 Use the ▲/▼ keys to select “Wireless (Wi-Fi)”, and then press the ENTER key.

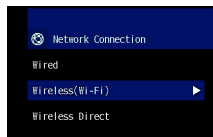

- 7 Use the ▲/▼ keys to select “Manual Setting”, and then press the ENTER key.

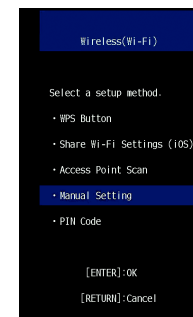

- 8 Use the ▲/▼ keys to select “SSID”.





▲/▼/◀/▶  
ENTER  
SETUP (⚙️)

## 9 Use the ◀/▶/▲/▼ keys and the ENTER key to enter the SSID of the access point.



[←]/[→]: Move the cursor left and right.  
[Space]: Enter a space.  
[BKSP]: Delete the character to the left of the selected one.  
[DELETE]: Delete the selected character.  
[CLEAR]: Delete all characters entered.  
[CANCEL]: Cancel character entry, and return to the previous screen.

Once the security key been entered, select “OK”, and then press the ENTER key. The screen will return to that displayed in step 8.

## 10 Use the ▲/▼ keys to select “Security” and the ◀/▶ keys to select the encryption method.

### Settings

None, WEP, WPA2-PSK (AES), Mixed Mode



- As communications are not encrypted when “None” is selected, selecting this option poses the risk that third parties may access the unit without your permission.

## 11 Use the ▲/▼ keys to select “Security Key” and press the ENTER key.



- If you select “None” in step 10, this item is not available.

## 12 Use the ◀/▶/▲/▼ and ENTER keys to enter the security key.

If you select “WEP” in step 10, enter either 5 or 13 character string, or 10 or 26 hexadecimal (base 16) keys.

If you select the method other than “WEP”, enter either 8 to 63 character string, or 64 hexadecimal (base 16) keys.



- Hexadecimal (base 16) keys use combinations of the numbers 0 through 9 and the letters a through f. Letters are not case sensitive.



[←]/[→]: Move the cursor left and right.  
[Space]: Enter a space.  
[BKSP]: Delete the character to the left of the selected one.  
[DELETE]: Delete the selected character.  
[CLEAR]: Delete all characters entered.  
[CANCEL]: Cancel character entry, and return to the previous screen.

Once the security key been entered, select “OK”, and then press the ENTER key. The screen will return to that displayed in step 8.

## 13 Use the ▲/▼ keys to select “Connect” and press the ENTER key to start the connection process.

When a connection has been established, “Completed” will be displayed on the TV screen.

If “Not connected” is displayed, press the ENTER key to repeat the procedure beginning with step 6.

## 14 Press the SETUP (⚙️) key to exit the setup menu.

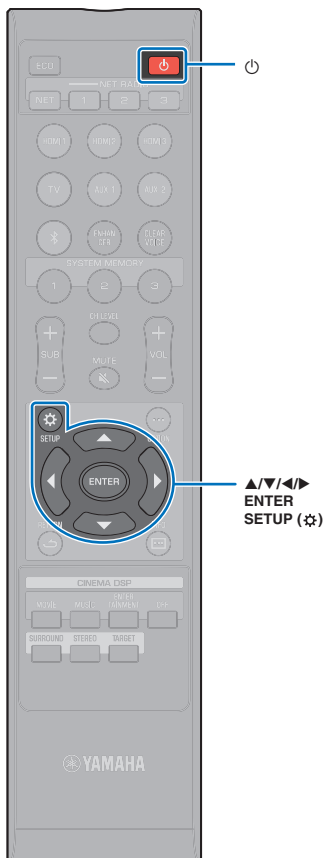

## Using the WPS PIN code

Register the unit's PIN code with your wireless router (access point) to establish a connection. This procedure applies if your wireless router (access point) supports the WPS PIN feature.

- 1 Press the key to turn on this unit.
- 2 Turn on the TV and switch the TV input to display video from the unit (HDMI OUT jack; p. 30).
- 3 Press the SETUP () key.  
The setup menu is displayed on the TV screen.
- 4 Use the ▲/▼ keys to select “Network”, and then press the ENTER key.
- 5 Use the ▲/▼ keys to select “Network Connection”, and then press the ENTER key.
- 6 Use the ▲/▼ keys to select “Wireless (Wi-Fi)”, and then press the ENTER key.

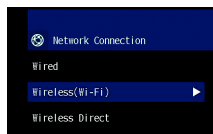

- 7 Use the ▲/▼ keys to select “PIN Code”, and then press the ENTER key.

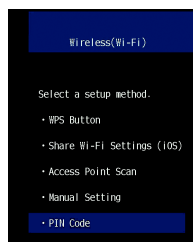

The list of available access points appears on the TV screen.

- 8 Use the ▲/▼ keys to select the desired access point and press the ENTER key.

The PIN code of the unit appears on the TV screen.



- 9 Enter the unit's PIN code into the wireless router (access point).

For details on settings, refer to documentation supplied with the wireless router (access point).

- 10 Press the ENTER key to start the connection process.

When a connection has been established, “Completed” will be displayed on the TV screen.

If “Not connected” is displayed, press the ENTER key to repeat the procedure beginning with step 6, or see the information below to try another connection method.



- The PIN code cannot be used to establish a wireless connection if your wireless router (access point) uses WEP encryption, or if the router's MAC address filter is enabled. See “Searching for a wireless router (access point)” (p. 55) to establish a connection.

- 11 Press the SETUP () key to exit the setup menu.

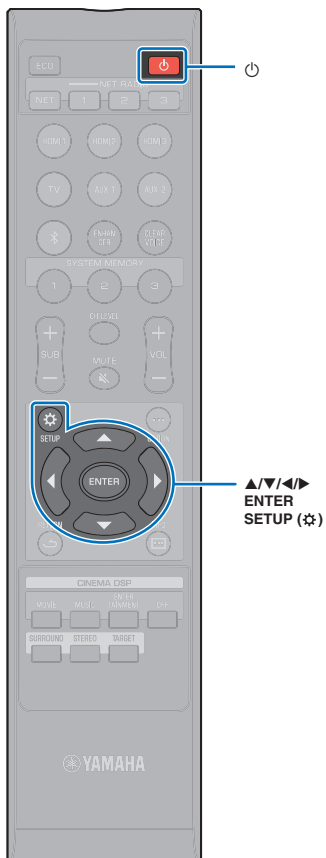

## Connecting a mobile device to the unit directly (Wireless Direct)



Connect a mobile device directly to the unit without using a wireless router (access point).

Wireless Direct supports the following.

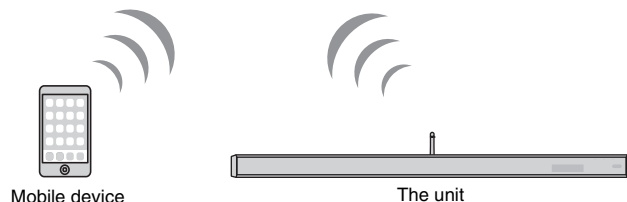
- Operation of the unit using a mobile device to which the dedicated MusicCast CONTROLLER app has been installed.
- Use of AirPlay to play music files stored on an iOS device.



- You cannot use Wireless Direct simultaneously with the wired network connection (p. 27) or the wireless network connection (p. 27).
- When Wireless Direct is enabled, the mobile device and the unit cannot connect to the Internet. Therefore, you cannot use any kind of Internet service such as Internet radio.

- 1 Press the  key to turn on this unit.**
- 2 Turn on the TV and switch the TV input to display video from the unit (HDMI OUT jack; p. 30).**
- 3 Press the SETUP () key.**

The setup menu is displayed on the TV screen.

- 4 Use the ▲/▼ keys to select “Network”, and then press the ENTER key.**
- 5 Use the ▲/▼ keys to select “Network Connection”, and then press the ENTER key.**
- 6 Use the ▲/▼ keys to select “Wireless Direct”, and then press the ENTER key.**



- 7 Use the ▲/▼ keys to select “Security” and the ◀/▶ keys to select the encryption method.**

### Settings

None, WPA2-PSK (AES)

In most cases, “WPA2-PSK (AES)” should be selected. If your mobile device does not support “WPA2-PSK (AES)”, select “None”.



- As communications are not encrypted when “None” is selected, selecting this option poses the risk that third parties may access the unit without your permission.

- 8 Use the ▲/▼ keys to select “Security Key” and press the ENTER key.**



- If you select “None” in step 7, this item is not available.



▲/▼/◀/▶  
ENTER  
SETUP (⚙️)

## 9 Use the ◀/▶/▲/▼ and ENTER keys to enter the security key.

Enter either 8 to 63 character string, or 64 hexadecimal (base 16) keys.



- Hexadecimal (base 16) keys use combinations of the numbers 0 through 9 and the letters a through f. Letters are not case sensitive.

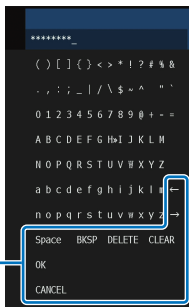

[←]/[→]: Moves the cursor left and right.  
[Space]: Enter a space.  
[BKSP]: Delete the character to the left of the selected one.  
[DELETE]: Delete the selected character.  
[CLEAR]: Delete all characters entered.  
[CANCEL]: Cancel character entry, and return to the previous screen.

Once the security key been entered, select “OK”, and then press the ENTER key. The screen below will be displayed.

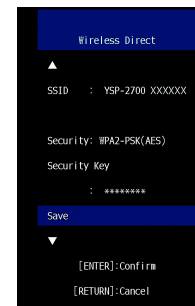

- Before proceeding to the next step, record the following information. These information will be needed to configure the Wi-Fi setting of a mobile device.
  - SSID displayed on the TV screen
  - Security key you have just entered

## 10 Use the ▲/▼ keys to select “Save” and press the ENTER key to save the setting.

This completes the settings and “Set the mobile device.” will be displayed on the TV screen. The unit functions as an access point.

Next, configure the Wi-Fi settings of a mobile device.

## 11 Configure the Wi-Fi settings of a mobile device.

For details on settings of your mobile device, refer to documentation supplied with the mobile device.

- Enable the Wi-Fi function on the mobile device.
- Select the SSID displayed in step 9 from the list of available access points.
- When you are prompted for a password, enter the security key displayed in step 9.

## 12 Press the SETUP (⚙️) key to exit the setup menu.

## Playing back music stored on media servers (PCs/NAS)

You can play back music files stored on your PC or DLNA-compatible NAS via the unit.



- The audio may be interrupted while using the wireless network connection. In this case, use the wired network connection.

### Supported File formats

File	Sampling frequency (kHz)	The number of channels	Gapless playback
WAV*	32 to 192	2	✓
MP3	8 to 48	2	—
WMA	8 to 48	2	—
MPEG-4 AAC	8 to 48	2	—
FLAC	32 to 192	2	✓
ALAC	32 to 96	2	✓
AIFF	32 to 192	2	✓

\* Linear PCM format only



- To play back FLAC files stored on a PC or NAS, you need to install server software that supports sharing of FLAC files via DLNA on your PC or use a NAS that supports FLAC files.
- Digital Rights Management (DRM) contents cannot be played back.

## Media sharing setup

To play back music files stored on your PC or DLNA-compatible NAS, first you need to configure the media sharing setting on each music server.

### For a PC with Windows Media Player installed

This unit supports Windows Media Player 11 or later. This section explains Windows Media Player 12 setup as an example.



- Operation may vary depending upon your PC or settings. Refer to documentation provided by your PC's manufacturer or Windows Media Player Help for details.

- 1 Start Windows Media Player 12 on your PC.
- 2 Select “Stream”, then “Turn on media streaming”.
- 3 Click “Turn on media streaming”.
- 4 Select “Allowed” from the drop-down list next to the unit’s model name.
- 5 Click “OK” to exit.

### For a PC or a NAS with other DLNA server software installed

Refer to documentation supplied with the device or software and configure the media sharing settings.

## Playing music files

---

Use the MusicCast CONTROLLER app installed on your mobile device to play music files.



- Register the unit as a MusicCast-enabled device (p. 50) before playing music files.

- 1 Use the MusicCast CONTROLLER app to select the unit's room (Room1, etc.).**
- 2 Tap  (Server).**
- 3 Follow the on-screen instructions to select a song.**



NET RADIO  
1-3

## Listening to Internet radio

You can listen to Internet radio stations from all over the world.



- You may not be able to receive some Internet radio stations.
- The unit uses the vTuner Internet radio station database service. This service may be discontinued without notice.

### Playback of Internet radio

Use the MusicCast CONTROLLER app installed on your mobile device to select an Internet radio station.



- Register the unit as a MusicCast-enabled device (p. 50) before listening to Internet radio.

- 1 Use the MusicCast CONTROLLER app to select the unit's room (Room1, etc.).
- 2 Tap  (Net Radio).
- 3 Select a station from "Locations", "Genres", etc.

### Registering favorite Internet radio stations

Internet radio stations can be assigned to the NET RADIO keys on the remote control, or they can also be bookmarked with the MusicCast CONTROLLER app.

#### Assigning a station to a NET RADIO key

- 1 Select the desired Internet radio station.
- 2 Press and hold one of the NET RADIO 1, 2, or 3 key for at least 3 seconds.

#### Tuning into assigned Internet radio stations

- 1 Press the NET RADIO 1, 2, or 3 key to which the desired Internet radio station has been assigned.

"NET RADIO" is shown in the front panel display, and streaming begins.



- When an Internet radio station is assigned to the NET RADIO 1, 2, or 3 key on the remote control, the same station is also registered with No. 1, 2, or 3 in the MusicCast CONTROLLER app's "Favorites". When an Internet radio station is registered with No. 1, 2, or 3 in "Favorites" with the MusicCast CONTROLLER app, the same station is also assigned to the NET RADIO 1, 2, or 3 key on the remote control.



## Using the MusicCast CONTROLLER app to bookmark a station

- 1 Select the desired Internet radio station.
- 2 Tap ... in the playback screen, and then tap “Add Bookmark”.



- You can use the Web browser on your PC to access the vTuner website (<http://radio.vtuner.com/>) and edit bookmarks.
- When the vTuner website is accessed, a dialog in which the unit's vTuner ID can be entered is displayed. Confirm the unit's vTuner ID from “Network” of “Information” in the setup menu beforehand (p. 82)

### □ Tuning into registered Internet radio stations

- 1 Tap “Bookmarks”, and then tap “My\_Favorites” to select the desired Internet radio station.

# Playing back music with AirPlay

The AirPlay function allows you to play back iTunes or iPod music on the unit via network.



- This section describes “iPod touch”, “iPhone” and “iPad” as the “iPod”. “iPod” refers to “iPod touch”, “iPhone” and “iPad”, unless otherwise specified.
- If no router is available, you can connect your iPod to the unit directly via a wireless connection for playback (Wireless Direct). For instructions on connecting with Wireless Direct, refer to p. 60.

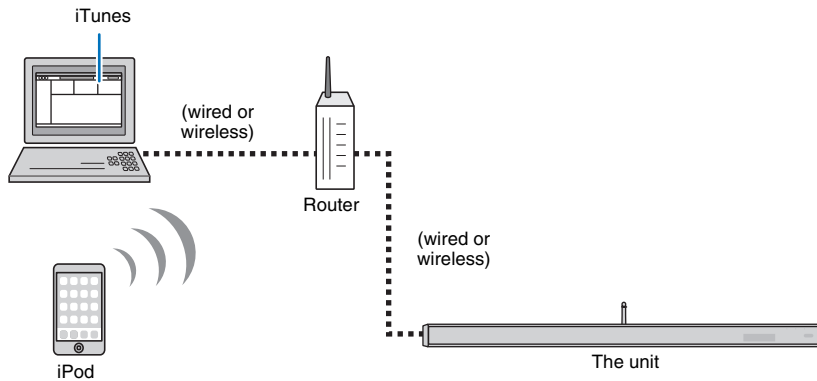

- AirPlay works with iPhone, iPad, and iPod touch with iOS 4.3.3 or later, Mac with OS X Mountain Lion or later, and Mac and PC with iTunes 10.2.2 or later.

## Playback of iTunes/iPod music contents

Follow the procedure below to play back iTunes/iPod music contents on the unit.

### 1 Turn on the unit, and start iTunes on the PC or display the playback screen on the iPod.

If the iTunes/iPod recognizes the unit, the AirPlay icon (  ) appears.

iTunes (example)



iPod (example)

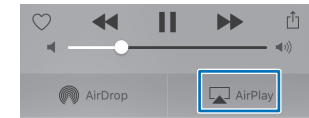

- If the icon does not appear, check whether the unit and PC/iPod are connected to the router properly.

### 2 On the iTunes/iPod, click (tap) the AirPlay icon and select the unit as the audio output device.

iTunes (example)

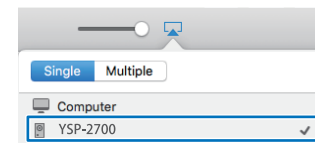

iPod (example)



The unit

### 3 Select a song and start playback.

To operate playback, use the Music app on the iPod or iTunes on the PC.

“AirPlay” is shown in the front panel display, and playback begins.



- You can turn on the unit automatically when starting playback on iTunes or iPod by setting “Network Standby” (p. 84) in the setup menu to “On”.
- You can adjust the unit’s volume from the iTunes/iPod during playback.

#### Caution

- When you use iTunes/iPod controls to adjust volume, the volume may be unexpectedly loud. This could result in damage to the unit or speakers. If the volume suddenly increases during playback, stop playback on the iTunes/iPod immediately.

## Playing back music stored on mobile devices

Use this function to play music stored on your mobile device over a network.

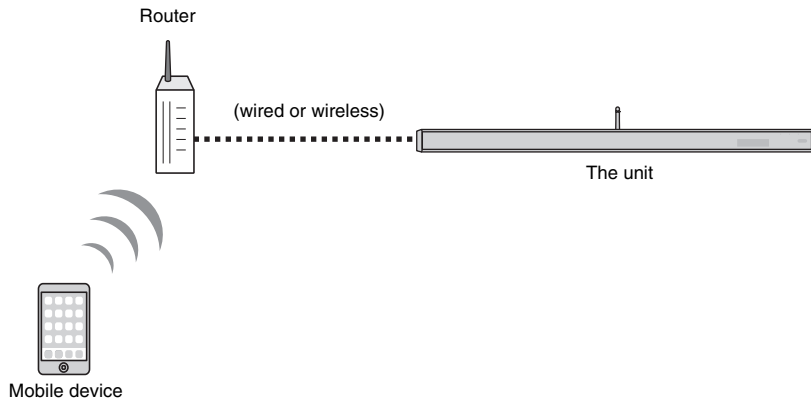

## Using a mobile device to play songs

Use the MusicCast CONTROLLER app installed on your mobile device to operate playback.



- Register the unit as a MusicCast-enabled device (p. 50) before playing music files.

- 1 Use the MusicCast CONTROLLER app to select the unit's room (Room1, etc.).**
- 2 Tap .**
- 3 Select a song from "Playlists", "Artists", etc.**

### Caution

- When you use mobile device controls to adjust volume, the volume may be unexpectedly loud. This could result in damage to the unit or speakers. If the volume suddenly increases during playback, stop playback on the mobile device immediately.

# SETTINGS

## Setup menu

A variety of settings for this unit can be specified and adjusted from the setup menu. Among the options available are the sound beam output method for optimal surround sound effects, channel volume control, and HDMI settings.

The setup menu is displayed on, and operated from, the TV screen (it cannot be displayed in the front panel display). See “Displaying the menu screen on the TV” (p. 30) for instructions on displaying the setup menu on the TV.

## Setting the setup menu

### 1 Press the SETUP (⚙️) key.

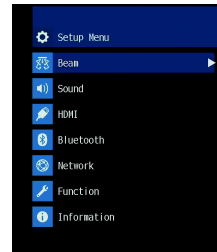

- Hold down the SETUP (⚙️) key to display “OSD Language” directly on the screen (p. 31, 85).
- If an update for the unit's firmware is available, an envelope icon (✉️) will be displayed in the setup menu (p. 92).

### 2 Press the ▲/▼ key to select a menu and then press the ENTER key or ► key.

Repeat these steps to display the desired menu.

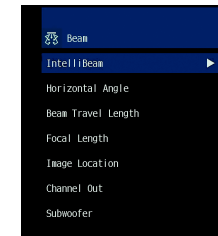

Press the ◀️ key or RETURN (↵) key to return to the previous menu.

### 3 Press the ▲/▼ key to change the setting value of each menu.

### 4 Press the SETUP (⚙️) key again to exit the setup menu.

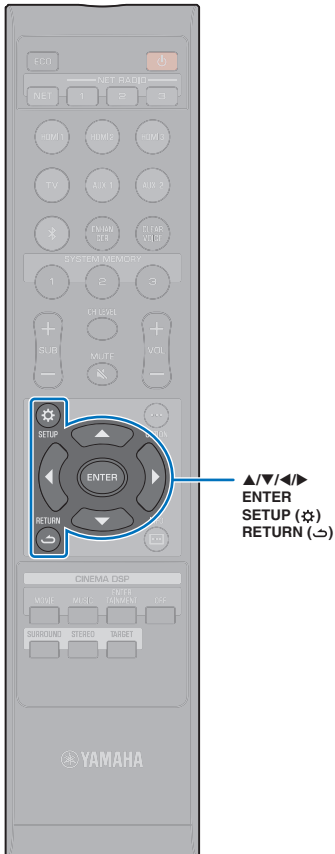

## Setup menu list

Menu	Settings	Function	Page	
Beam	IntelliBeam	<b>Beam+Sound optimize</b>	Optimizes the sound beam and sound settings automatically.	35
		<b>Beam optimize only</b>	Optimizes the sound beam settings automatically.	35
		<b>Sound optimize only</b>	Optimizes the sound settings automatically.	35
	<b>Horizontal Angle</b>	<b>Front L, Front R, Center, Surround L, Surround R</b>	Adjust horizontal sound beam angle.	72
	<b>Beam Travel Length</b>	<b>Front L, Front R, Center, Surround L, Surround R</b>	Adjust sound beam travel length.	72
	<b>Focal Length</b>	<b>Front L, Front R, Center, Surround L, Surround R</b>	Adjust sound beam focal length.	73
	<b>Image Location</b>	<b>Adjustment, Left, Right</b>	Adjusts the sound position of the front right and left channels.	74
	Channel Out	<b>Front</b>	Specify the output method for the front channels.	75
		<b>Surround Back</b>	Specify whether or not there are surround back channels.	75
		<b>My Surround</b>	Enable/disable the My Surround function.	76
	Subwoofer	<b>Bass Out</b>	Specify whether the subwoofer will be connected via a wired or wireless connection.	76
		<b>Distance</b>	Specify the distance from the subwoofer to the listening position.	76
		<b>Pairing</b>	Manually pair the center unit with the subwoofer.	76
	Sound	<b>Channel Level</b>	<b>Front L, Front R, Center, Surround L, Surround R, Height L, Height R, Subwoofer</b>	Adjusts the volume of each channel.
<b>Adaptive DRC</b>			Choose whether or not dynamic range is adjusted based on this unit's volume level.	77
<b>Dynamic Range</b>			Specify dynamic range.	78
<b>Matrix Decoder</b>			Specify a surround decoder.	78
<b>DPLx Parameter</b>		<b>Center Width, Panorama, Dimension</b>	Specify Dolby Pro Logic IIx Music parameters.	79
<b>Audio Delay (LINK)</b>		<b>Audio Sync, Lip Sync</b>	Specify audio output timing when distributing sound from the unit to other MusicCast-enabled devices.	79
HDMI	<b>HDMI Control</b>		Turn HDMI control on or off.	80
	<b>HDMI Audio Out</b>		Choose whether HDMI audio input is played via this unit or the TV.	80
	<b>TV Input</b>		Select the input jack for TV audio from TV (optical digital) input jack, AUX1 (analog) input jacks, and AUX2 (coaxial digital) input jack.	80

Menu	Settings	Function	Page
Bluetooth	<b>Bluetooth</b>	Enable/disable the <i>Bluetooth</i> functions.	81
	<b>Transmission</b>	Turn the function that transmits audio to a <i>Bluetooth</i> device, such as <i>Bluetooth</i> speakers, on or off.	81
	<b>Device Search</b>	Search for the <i>Bluetooth</i> device, such as <i>Bluetooth</i> speakers, to which audio will be transmitted.	81
	<b>MAC Address</b>	Display the MAC address for the <i>Bluetooth</i> connection.	81
Network	<b>Information</b>	Display the unit's network information.	82
	<b>Network Connection</b>	Select the network connection method.	82
	<b>IP Address</b>	<b>DHCP, IP Address, Subnet Mask, Default Gateway, DNS Server (P), DNS Server (S)</b> Configure the network parameters (such as IP address).	83
	<b>MAC Address Filter</b>	<b>Filter, MAC Address 1–10</b> Set the MAC address filter to limit access to the unit from other network devices.	83
	<b>Network Standby</b>	Enable/disable the function that turns on the unit from other network devices.	84
	<b>Network Update</b>	<b>Perform Update</b> Update the firmware via the network.	84
Function	<b>Dimmer</b>	Adjust the brightness of the front panel display and indicators.	85
	<b>OSD Language</b>	Changes the language used for menus displayed on the TV screen.	85
	<b>Distance Unit</b>	Specify units used for length and distance in menus.	85
Information	<b>Audio</b>	Display audio input signal information.	86
	<b>Video</b>	Display video input signal information.	86
	<b>System</b>	Display this unit's firmware version.	86

# Beam

When "AUTO SETUP" in the "IntelliBeam" menu (p. 33) is used, recommended beam settings are automatically applied by this unit. However, "Horizontal Angle", "Beam Travel Length", "Focal Length" (except "Center"), and "Image Location" settings can later be fine-tuned.

The output method for each channel can also be specified in "Beam" menu.



- When manually adjusting sound beams for the front channels, set "Front" for "Channel Out" to "Beam" or "Mix". Adjustment is not possible if "Front" is set to "Stereo".

## Horizontal Angle



Adjust the horizontal angle of sound beams for each channel using test tones. Adjust toward L (left) to move the direction of the output to the left and adjust toward R (right) to move it to the right.

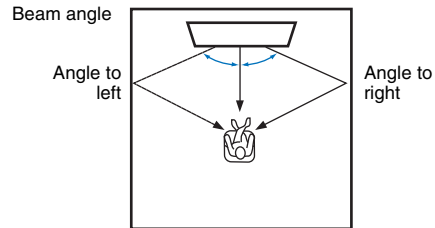

### Settings

Front L, Front R, Center, Surround L, Surround R

### Adjustable range

L90° to R90°

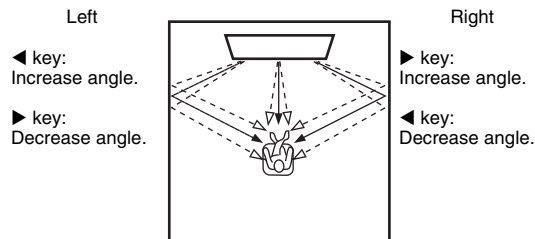

## Beam Travel Length



Specify the distance that sound beams travel for each channel. The distance starts at this unit, ends at the listening position, and includes refraction off a wall. The audio delay is adjusted and sound from each channel arrives at the listening position simultaneously.

### Settings

Front L, Front R, Center, Surround L, Surround R

### Adjustable range

0.3 m to 24.0 m (1.0 ft to 80.0 ft)

The length of each arrow indicates the beam travel length.

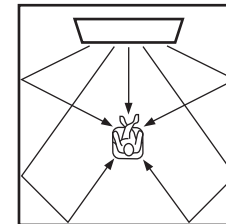

- Configure this setting only when you have adjusted "Horizontal Angle".



## Focal Length

Setup Menu



Beam



Focal Length

Expand the optimal listening area (sweet spot).

The illustration below shows how output from all channels is once concentrated in a focal point and then expanded from that point. Apply negative (-) values to broaden the sweet spot, or positive (+) values to narrow the sweet spot.

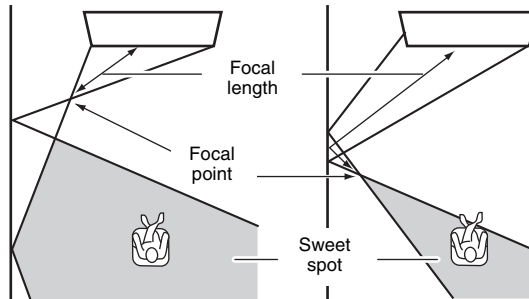

### Settings

Front L, Front R, Surround L, Surround R

### Adjustable range

-1.0 m to +13.0 m (-3.5 ft to +43.5 ft)

### Setting

Center

### Adjustable range

-1.0 m to +13.0 m (default: -0.5 m) (-3.5 ft to +43.5 ft (default: -1.5 ft))

We recommend using the default setting (-0.5 m or -1.5 ft) for "Center".

Example

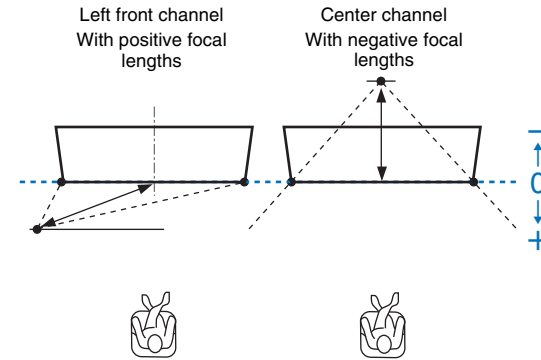

- "AUTO SETUP" (p. 33) automatically enables a range for optimal listening (sweet spot) that is broader than the width of this unit.

## Image Location

Setup Menu



Beam



Image Location

If sound from the left and right channels is unnatural, first adjust the volume of each channel (p. 43, 77).

If this does not resolve the problem, adjust left- and right-channel image location.

Use to adjust the direction from which the front left and right channel sound is heard so that each sound can be heard closer to the center channel.

### Adjustment

#### Settings

Off (default)	No adjustments are made.
On	Choose "Left" or "Right" to adjust the direction from which sound is heard.

### Left

The higher the percentage, the louder the output from the center channel.

Once "Adjustment" has been set to "On", this setting can be selected.

#### Adjustable range

0% (default) to 95%

Sound from the left front channel is unnatural

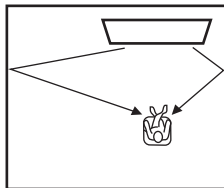

With the left front channel adjusted

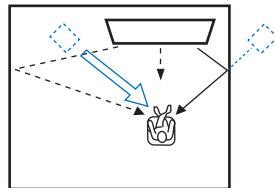

### Right

The higher the percentage, the louder the output from the center channel.

Once "Adjustment" has been set to "On", this setting can be selected.

#### Adjustable range

0% (default) to 95%

Sound from the right front channel is unnatural

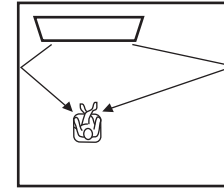

With the right front channel adjusted

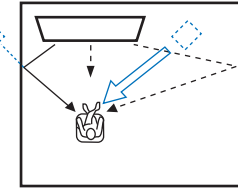

## Channel Out

Setup Menu



Beam



Channel Out

Specify the output method for each channel.

### Front

Specify whether sound beams or normal sounds are output from the front channels.

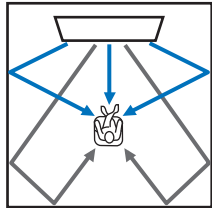

Sound output with "Beam"

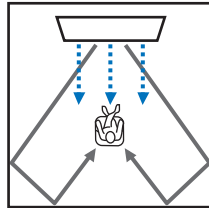

Sound output with "Stereo"

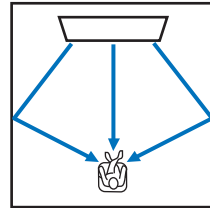

Sound output with "Mix"

### Settings

Beam	Sound beams are output from the left front, right front, and center channels. This setting is effective for creating sound fields greater than the dimensions of the actual listening room for playback of movies and the like.
Stereo	No sound beams are output from the left front, right front, and center channels. Front channel audio comes from the direction of the screen. Therefore, this setting is effective for enjoying music content such as live music videos.
Mix	Sound beams are output from the left front, right front, and center channels. Other channels are mixed into the left front and right front channels. This setting is effective when the listening position is close to the rear wall, or when several people have gathered to watch a movie.



- This setting is not available when "My Surround" is selected.

### Surround Back

Specify whether or not surround back channels are present.

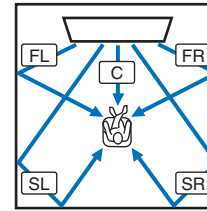

None

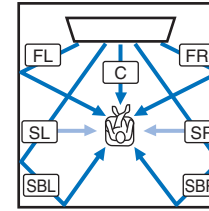

Yes

FL: Front L  
FR: Front R  
C: Center  
SL: Surround L  
SR: Surround R  
SBL: Surround back L  
SBR: Surround back R

### Settings

None	Sounds are played back without using surround back channels. Left and right surround channel audio is played back using sound beams that come from behind the listening position.
Yes	Sounds are played back using surround back channels. Left and right surround back channel audio is played back using sound beams that come from behind the listening position. Left and right surround channel audio is output using both sound beams that come from the front channels and from behind the listening position. This allows sounds to be heard from the sides of the listening position as well.
Auto (default)	Automatically select whether or not surround back channels are used based on the number of channels used for playback of the selected input source.

## ❑ My Surround

Specify whether or not “My Surround” is enabled to reproduce a sense of surround sound even in a room not suitable for surround sound playback using sound beams.

### Settings

Off (default)	My Surround is disabled.
On	“My Surround” is enabled. Enjoy playing audio with a good sense of surround sound even in an environment where surround sound playback using sound beams does not provide sufficient surround sound effects. Press the SURROUND key on the remote control for playback using the My Surround function.



- To use “My Surround”, establish the listening position directly in front of the unit for a greater sense of surround sound.



- When “My Surround” is set to “On”, CINEMA DSP is disabled.

## Subwoofer

Setup Menu



Beam



Subwoofer

Apply or adjust subwoofer settings, such as the connection method and the subwoofer's distance from the listening position.

### ❑ Bass Out

Specify how the subwoofer is connected.

#### Settings

Wireless (default)	Select to connect the center unit and subwoofer wirelessly.
Wired	Select to connect the center unit and subwoofer via the subwoofer cable (RCA mono cable) and system control cable (3.5 mm monaural mini plug cable).

### ❑ Distance

Specify the distance from the subwoofer to the listening position.

#### Adjustable range

0.3 m (1.0 ft) to 15.0 m (50.0 ft) (default: 2.5 m (8.5 ft))

### ❑ Pairing

Manually pair the center unit with the subwoofer.

After “Pairing” is selected, press the SUBWOOFER PAIRING button on the subwoofer for three seconds. For details, refer to “Pairing the center unit and subwoofer” (p. 105).



- “Pairing” can be selected when “Bass Out” is set to “Wireless”.

# Sound

## Channel Level



Adjust the volume of each channel to balance output levels. Use test sounds output from each channel to adjust volume for optimal balance.

### Settings

Front L, Front R, Center, Surround L, Surround R, Subwoofer

### Adjustable range

-20 to +20



- When "My Surround" or "Channel Out" is set to "On" the following items can be configured (p. 76).
  - Center
  - Surround L/R
  - Subwoofer

## Adaptive DRC



Adjust this unit's volume and dynamic range for optimal balance. When "On" is selected, dynamic range is adjusted as follows for optimal listening at low volumes, such as might be used at night.

When the volume level is low:

Narrow the dynamic range. Loud sound is played back softer, and soft sound which is hard to be listened to is played back louder.

When the volume level is high:

Widen the dynamic range. For both soft and loud sounds, source sound is played back without adjusting volume.

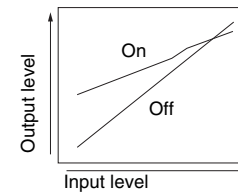

Volume: low

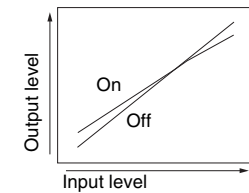

Volume: high

### Settings

Off	The dynamic range is not adjusted automatically.
On (default)	Adjust the dynamic range automatically.



- When set to "On", "Dynamic Range" is automatically set to "Max".

## Dynamic Range

Setup Menu



Sound



Dynamic Range

Adjust this unit's dynamic range (difference between maximum and minimum volumes).

### Settings

Min/Auto	Min: Sets dynamic range at a level that supports comfortable listening at low volumes. Auto: Sets dynamic range in accordance with information received from input signal.
Standard	The dynamic range recommended for regular home use.
Max (default)	Outputs sound without adjusting the dynamic range of the input signals.



- "Adaptive DRC" is automatically set to "Off" when the settings other than "Max" is selected.

## Matrix Decoder

Setup Menu



Sound



Matrix Decoder

Set the surround decoder.

When this unit plays back 2-channel or 5.1-channel sources in the surround mode, surround decoder enables them playback for 7.1-channel. You can enjoy a variety of surround sound effects by switching the decoder.

To enable a surround decoder, press the CINEMA DSP key to select "DSP Off".

### Settings

DPL Movie* (default)	Use the Dolby Pro Logic II decoder suitable for movies.
DPL Music*	Use the Dolby Pro Logic II decoder suitable for music.
DPL Game*	Use the Dolby Pro Logic II decoder suitable for games.
Neo:6 Cinema	Use the DTS Neo: 6 decoder suitable for movies.
Neo:6 Music	Use the DTS Neo: 6 decoder suitable for music.

\* The Dolby Pro Logic IIx surround decoder is used when 7.1-channel audio is output in accordance with the selected "Channel Out" setting (p. 75).



- Decoders are disabled when stereo playback mode (p. 42), My Surround (p. 76), or target playback mode (p. 42) is enabled.
- Dolby Pro Logic IIx Music parameters (Center Width, Panorama, and Dimension) can be adjusted from the setup menu (p. 79).

### About the surround decoder for playback of 5.1-channel sources

When "Surround Back" of "Channel Out" (p. 75) is set to "Yes" or "Auto", this unit decodes 5.1-channel sources and then playback them in up to 7.1-channel surround. One of the following decoders is automatically selected depending on the input signals.

Input signal (5.1 ch)	Decoder
PCM, Dolby Digital, Dolby Digital EX, Dolby TrueHD, Dolby Digital Plus	Dolby Pro Logic IIx Movie Dolby Pro Logic IIx Music
DTS, DTS-ES matrix, DTS-96/24, DTS-HD Master Audio, DTS-HD High Resolution Audio, DTS Express	DTS-ES matrix
DTS-ES discrete	DTS-ES discrete

## DPLx Parameter

Setup Menu



Sound



DPLx Parameter

Adjust Dolby Pro Logic IIx Music surround decoder parameters.



- This setting can be configured only when “Matrix Decoder” (p. 78) is set to “DPL Music”.

### Center Width

The greater the value, the broader the sound to the left and right. Smaller values restrict sound to the center.

#### Adjustable range

0 to 7 (default: 3)

### Panorama

When this is set to “On”, sounds from the front left and right channels are routed to the left and right for a surround, panoramic effect.

#### Settings

Off (default), On

### Dimension

This setting adjusts the difference in levels between the front and surround channels. The greater the value, the higher the volume from the front channel. The smaller the value, the higher the volume from the surround channels.

#### Adjustable range

-3 to +3 (default: 0)

## Audio Delay (LINK)

Setup Menu



Sound



Audio Delay (LINK)

Specify whether or not the unit's sound output timing is synchronized with other MusicCast-enabled devices when sound is distributed from this unit to other MusicCast-enabled devices.



- This setting can only be configured when “Link Control” is set to “Standard (default)” or “Speed Boost” with the MusicCast CONTROLLER app.

#### Settings

Audio Sync (default)	Output timing is synchronized with other MusicCast-enabled devices (to which sound from this unit is distributed).
Lip Sync	Output timing is adjusted in accordance with the “Audio Delay” setting in the option menu (p. 88). Select this option if you notice a deviation in timing between audio and video playing on a TV or BD/DVD player.

# HDMI

Use to configure the settings related to HDMI signals and the HDMI control function.

## HDMI Control



Turn HDMI control (p. 37) on or off.

### Settings

Off	Disable the control function. The standby power consumption of this unit decreases.
On (default)	Enable the control function.



- Set the HDMI control function to “On” when a TV that supports audio return channel (ARC) is used (p. 24), or when using the HDMI signal pass-through function (p. 25).

## HDMI Audio Out

**This setting can be configured only when “HDMI Control” is set to “Off”.**



Use to select a device to play back HDMI audio signals.

### Settings

AMP (default)	Play HDMI audio input signal from the unit.
TV	Play HDMI audio input signal from the TV connected to the HDMI OUT (ARC) jack on the unit.



- When “HDMI Control” is set to “On”, select the audio output device based on the settings configured for the TV connected to this unit.
- HDMI video signals input to one of the HDMI IN jacks of this unit are always output from the HDMI OUT (ARC) jack of this unit.

## TV Input



If your TV is not ARC compatible (or if the ARC feature has been disabled), TV audio is input via the TV (optical digital) input jack (default). This unit's input source can be changed to the AUX2 (coaxial digital) input jack or AUX1 (analog) input jacks.

### Settings

Optical [TV] (default), Analog [AUX1], Coaxial [AUX2]



- If this unit's input source is switched to “Coaxial [AUX2]”:  
Audio is input from the device (TV) connected to the AUX2 (coaxial digital) input jack on this unit when the TV key is pressed. Audio is input from the device connected to the TV (optical digital) input jack on this unit when the AUX2 key is pressed.
- If this unit's input source is switched to “Analog [AUX1]”:  
Audio is input from the device (TV) connected to the AUX1 (analog) input jacks on this unit when the TV key is pressed. Audio is input from the device connected to the TV (optical digital) input jack on this unit when the AUX1 key is pressed.



# Bluetooth

Configures the *Bluetooth* settings.

## Bluetooth



Enables/disables the *Bluetooth* function.

### Settings

Off	Disable the <i>Bluetooth</i> function.
On (default)	Enable the <i>Bluetooth</i> function.

## Transmission



Transmit audio from the unit to *Bluetooth* speakers or headphones.

### Settings

Off (default)	Audio can not be transmitted.
On	Audio input to the unit can be transmitted to <i>Bluetooth</i> speakers or headphones.

## Device Search

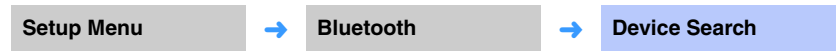

Select the *Bluetooth* speakers or headphones to which audio will be transmitted, and connect the unit to the speakers or headphones wirelessly.

## MAC Address



Display the MAC address for the *Bluetooth* connection.

# Network

Configures the network settings.

## Information



Display the network information on the unit.



- The options displayed vary according to the type of network connection (Wired/Wireless (Wi-Fi)/Wireless Direct).

Status	The connection status of the NETWORK jack
Connection	Connection method
MC Network	The connection status of MusicCast Network
SSID	The access point to which the unit is connected
Security	The encryption method for your network
MAC Address	MAC address (Ethernet/Wi-Fi)
IP Address	IP address
Subnet Mask	Subnet mask
Default Gateway	The IP address of the default gateway
DNS Server (P)	The IP address of the primary DNS server
DNS Server (S)	The IP address of the secondary DNS server
vTuner ID	The ID of the Internet radio (vTuner)

## Network Connection



Select the network connection method.

### Settings

Wired	Select this option when connecting the unit to a network with a network cable (not supplied).
Wireless (Wi-Fi)	Select this option when connecting the unit to a network via the wireless router (access point).
Wireless Direct	Select this option when connecting a mobile device to the unit directly.

## IP Address



Configure the network parameters (such as IP address).

### DHCP

Select whether to use a DHCP server.

#### Settings

Off	The DHCP server is not used. Configure the network parameters manually. For details, see "Manual network settings".
On (default)	The DHCP server is used to automatically obtain the unit's network parameters (such as IP address).

#### Manual network settings

### 1 Set "DHCP" to "Off".

### 2 Use the ▲/▼ keys to select a parameter type.

IP Address	Specify an IP address.
Subnet Mask	Specify a subnet mask.
Default Gateway	Specify the IP address of the default gateway.
DNS Server (P)	Specify the IP address of the primary DNS server.
DNS Server (S)	Specify the IP address of the secondary DNS server.

### 3 Use the ◀/▶ keys to move the edit position and the ▲/▼ keys to select a value.

### 4 Press the ENTER key.

## MAC Address Filter



The MAC address filter limits network devices that can be used to operate the unit. When operating the unit via an app on a mobile device, specify the MAC address of the device.



- Operation of the AirPlay function (p. 66) or DLNA-compatible device (p. 62) is not limited by this setting.

### Filter

Enable/disable the MAC address filter.

#### Settings

Off (default)	Disable the MAC address filter.
On	Enable the MAC address filter. In "MAC Address 1–10", specify the MAC addresses of the network devices that will operate the unit.

### MAC Address 1–10

Specify the MAC addresses (up to 10) of the network devices that will operate the unit when "Filter" is set to "On".

### 1 Use the ▲/▼ keys to select an MAC address number (1 to 10).

### 2 Use the ◀/▶ keys to move the edit position and the ▲/▼ keys to select a value.

### 3 Press the ENTER key.

## Network Standby



Turn the function that controls the unit's power (Network Standby) when a mobile device or *Bluetooth* device is operated on or off.

### Settings

Off	Disable the network standby function.
On (default)	Enable the network standby function. <ul style="list-style-type: none"><li>• When the unit is turned off, it will turn on with the following playback operations.<ul style="list-style-type: none"><li>– Play back with AirPlay</li><li>– Music files stored on a DLNA-compliant network attached storage (NAS) unit are played</li></ul></li><li>• The unit can also be turned on and off using the MusicCast CONTROLLER app installed on your mobile device.</li></ul> <p>When a <i>Bluetooth</i> device is connected to this unit while it is off, this unit turns on.</p>



- The unit consumes more power when "Network Standby" is set to "On" than when it is set to "Off".

## Network Update



Update the firmware via the network.

### Perform Update

This option is available after firmware has been updated. For details, see "Updating the unit's firmware" (p. 92).

# Function

## Dimmer

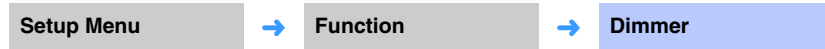

Adjust the brightness of the front panel display and indicators. The smaller the value, the dimmer the display and indicators.

### Settings

-2 (darkest) to 0 (brightest) (default)



- When the  indicator glows red, the display is at maximum brightness regardless of this setting.
- When the Eco function is activated, this function cannot be configured (p. 45).

## OSD Language



Use to select the language used for menus displayed on the TV screen.

### Settings

日本語	Menus are displayed in Japanese.
ENGLISH (default)	Menus are displayed in English.
DEUTSCH	Menus are displayed in German.
FRANÇAIS	Menus are displayed in French.
ESPAÑOL	Menus are displayed in Spanish.
ITALIANO	Menus are displayed in Italian.
NEDERLANDS	Menus are displayed in Dutch.
РУССКИЙ	Menus are displayed in Russian.
SVENSKA	Menus are displayed in Swedish.
TÜRK	Menus are displayed in Turkish.



- Hold down the SETUP (  ) key to display “OSD Language” directly on the TV screen.
- The settings may be changed automatically when using the TV which supports the HDMI control function.
- Display language can only be selected for menus displayed on the TV screen. Information in the front panel display is displayed in English.

## Distance Unit



Use to change the display unit of measurement.

### Settings

Meters (default setting other than U.S.A. and Canada models), Feet (default setting for U.S.A. and Canada models)



- If the unit used with measurement displays is changed from “Meters” to “Feet”, or vice versa, configure settings again to reflect the change in unit. The change will not be reflected with current settings.

## Information

Display information for the audio and video signal input to this unit.

### Audio



The following information on the current audio input signal is displayed.

Format	Digital audio format
Number of channels	The number of channels contained within the input signal—front/surround/low field effects (LFE). Example: "3/2/0.1" means signal contains 3 front channels, 2 surround channels, and LFE. If the signal contains channels other than front, surround, and LFE, the total number of channels may be displayed. Example: "5.1ch"
Sampling frequency	The sampling frequency of the digital input signal
Bit rate	The per-second bit rate of the input signal



- The audio bit rate may not be displayed for some input signals.

### Video



The following information on the current video input signal is displayed.

Type	HDMI or DVI
Resolution	Video signal resolution

### System



Display the version of firmware currently installed on this unit.

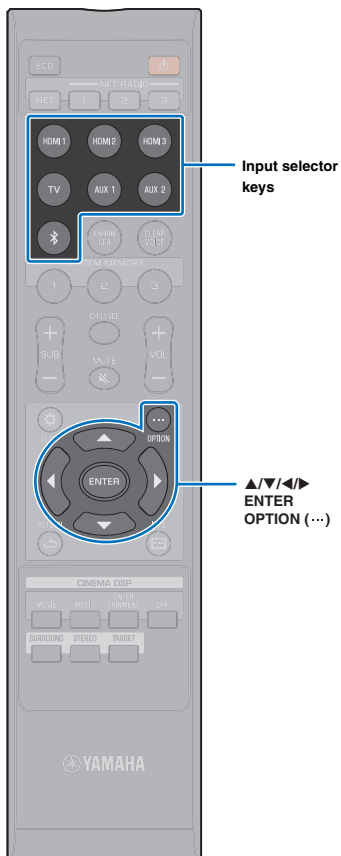

## Settings each input source (Option menu)

Configure the functions related to the input source currently playing back content.

The option menu is displayed on, and operated from, the TV screen. See “Displaying the menu screen on the TV” (p. 30) for instructions on displaying the option menu on the TV.

### Setting the option menu

**1** Press the input selector key for the input source to be configured.

**2** Press the OPTION (...) key.

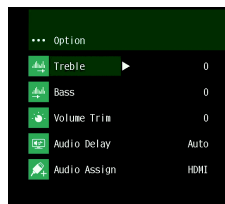

**3** Select the items by pressing the ▲/▼ key, then press the ENTER key or ► key.

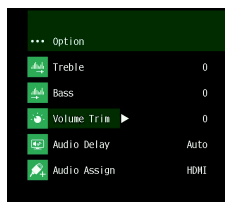

**4** Change setting value by pressing the ▲/▼ key.

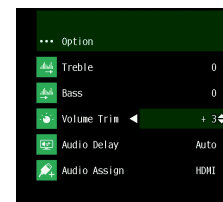

**5** Press the OPTION (...) key to exit the option menu.



- The configurable items vary depending on the input source selected.

## Option menu list

Menu	Description	Input
<b>Treble</b>	Adjust the output level of high (treble) tones.	HDMI1- 3, TV, AUX1- 2, <i>Bluetooth</i> , NET (such as an internet radio station)
<b>Bass</b>	Adjust the output level of low (bass) tones.	HDMI1- 3, TV, AUX1- 2, <i>Bluetooth</i> , NET (such as an internet radio station)
<b>Volume Trim</b>	Adjust the input level for each jack to compensate for variations in volume.	HDMI1- 3, TV, AUX1- 2, <i>Bluetooth</i> , NET (such as an internet radio station)
<b>Audio Delay</b>	Adjust deviations in timing between audio and video playback.	HDMI1- 3, TV, AUX1- 2
<b>Audio Assign</b>	When an HDMI device is selected as the input source, audio from a different input source is assigned to HDMI audio.	HDMI1- 3

### Adjusting tones (Treble, Bass)

Adjust the output level of high (treble) and low (bass) tones.

#### Adjustable range

-12 to +12 (default: 0)

### Adjusting input level of each jack (Volume Trim)

Adjust the input level for each jack to compensate for variations in volume.

#### Adjustable range

-12 to +12 (default: 0)

### Audio delay control (Audio Delay)

TV images sometimes lag behind the sound. You can use this function to delay the sound output to synchronize it with the video image.



- Audio delay can only be adjusted when “Audio Delay (LINK)” (p. 79) is set to “Lip Sync”.

#### Adjustable range

HDMI1- 3: AUTO (default), 0 ms to 500 ms, 5 ms increments

TV, AUX1- 2: 0 ms (default) to 500 ms, 5 ms increments

When “AUTO” is selected, output timing is automatically adjusted. This setting is only available when the TV connected via HDMI cable supports the audio delay automatic adjustment feature.

### Assigning HDMI audio to a different input jack (Audio Assign)

When HDMI1- 3 is the selected input source, sound can be input from the TV (optical digital) input jack rather than the HDMI IN jack.

Use this function to listen to sound from a different playback device while watching video of the BD/DVD player.

#### Settings

HDMI (default), OPTICAL



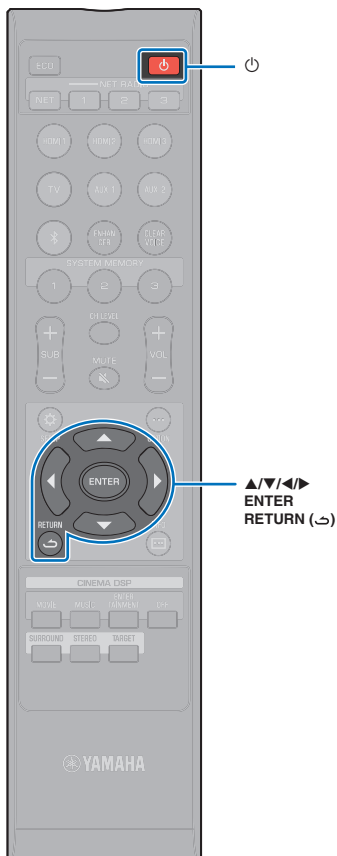

## Advanced setup

The advanced setup enables more precise configuring of this unit's function. For example, maximum volume can be specified and the INPUT key on the top panel can be disabled.

### Setting the advanced setup

- 1 Press the key to turn off this unit.
- 2 While holding down the INPUT key on the top panel, press the key on the remote control to turn on the power.

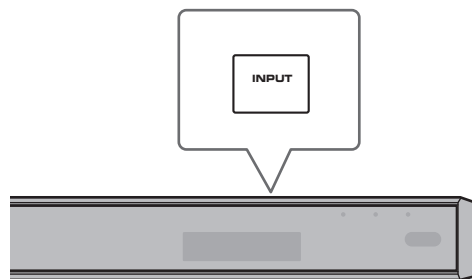

"ADVANCED" appears in the front panel display.

ADVANCED



- The advanced setup menu is not displayed on the TV screen.

- 3 Release the INPUT key on the top panel.

- 4 Use the key to display the desired menu in the front panel display and then press the key or ENTER key.



- To return to the previous menu, press the or RETURN ( ) key.

- 5 Use the key to change setting.

- 6 Press the key to turn off this unit.

The new setting is reflected when you turn on the unit by pressing the key.

## Advanced setup list

Menu	Settings/Adjustable range	Description
TURN ON VOLUME	OFF (Not set) (default), 1 to 70	Set the initial volume level when the power of this unit is turned on. When set to "OFF", volume level is the same as when this unit is turned off.
MAX VOLUME	1 to 99, MAX (Maximum) (default)	Set the maximum volume level so that this unit will not output sound beyond the limited volume level.
INPUT LOCK	ON (INPUT key operation is disabled) OFF (INPUT key operation is enabled) (default)	Select whether or not to enable the INPUT key on the unit.
PANEL LOCK	ON (Key operation on the unit is disabled) OFF (Key operation on the unit is enabled) (default)	Select whether or not to enable key operations on the unit (except the advanced setup operations).
IR INPUT POWER	ON (Enables power-on) OFF (Disables power-on) (default)	Select whether or not to automatically turn on this unit by pressing an input selector key on the remote control when the unit is turned off.
AC ON STANDBY	ON (Enters standby mode) (default) OFF (Restores the state before power was lost)	Set this unit's power to off when the AC power is recovered after the power to this unit was lost temporarily (disconnect the AC power plug from the wall outlet, power outage, etc.).
MEMORY PROTECT	ON (Protect is performed) OFF (Protect is not performed) (default)	Protect settings stored in system memory, and Internet radio stations registered with the unit.
YRB FL	YES (The reflection board is used) NO (The reflection board is not used) (default)	Use the YRB-100 sound reflection board for the front left channel. Refer to page 103 for details of YRB-100.
YRB FR	YES (The reflection board is used) NO (The reflection board is not used) (default)	Use the YRB-100 sound reflection board for the front right channel. Refer to page 103 for details of YRB-100.
YRB SL	YES (The reflection board is used) NO (The reflection board is not used) (default)	Use the YRB-100 sound reflection board for the surround left channel. Refer to page 103 for details of YRB-100.
YRB SR	YES (The reflection board is used) NO (The reflection board is not used) (default)	Use the YRB-100 sound reflection board for the surround right channel. Refer to page 103 for details of YRB-100.
AUTO POWER STANDBY	ON (This unit turns off automatically) (default setting for U.K. and Europe models) OFF (This unit does not turn off automatically) (default setting other than U.K. and Europe models)	When set to "ON", this unit turns off automatically in any of the following situations: <ul style="list-style-type: none"> <li>• Audio is coming from the selected input source, but no operations have been performed for 8 hours or more.</li> <li>• HDMI1–3, <i>Bluetooth</i> or NET is selected as the input source, but no audio has been input to the unit or no operations have been performed with the unit for more than 20 minutes.</li> </ul>
NOTICE OF NEW FW	ON (Notify) (default) OFF (Do not notify)	Notifications will not be displayed on the TV screen when updates for the unit's firmware are provided via the network.
4K MODE	MODE 1 <sup>1)</sup>	Inputs/outputs 4K (60 Hz/50 Hz) signals in 4:4:4, 4:2:2 or 4:2:0 format. Depending on the connected device or HDMI cables, video may not be displayed correctly. In this case, select "MODE 2".
	MODE 2 (default)	Inputs/outputs 4K (60 Hz/50 Hz) signals in 4:2:0 format.

<sup>1)</sup> When "MODE 1" is selected, use a high-speed HDMI cable that supports 18 Gbps.

Menu	Settings/Adjustable range	Description
FW UPDATE	01.02 (The firmware version is displayed) Start OK? (Firmware is updated)	Confirm firmware version/update firmware.
INITIALIZE <sup>2)</sup>	INFO (Initialize all settings not related to the network) NET INFO (Initialize network related settings)* CANCEL (Do not initialize) (default)	Reset the parameters of this unit to the factory presets. When the unit freezed, the problem may solve by restoring to their default values. * The following configurations will be restored if "INFO" is selected. <ul style="list-style-type: none"> <li>• Network Standby (p. 84)</li> <li>• Bluetooth (p. 47)</li> </ul>

<sup>2)</sup> Initializing this unit also initializes measurement results with IntelliBeam and settings stored in system memory. Perform "AUTO SETUP" from the "IntelliBeam" menu again (p. 32).



▲/▼  
ENTER  
SETUP (⚙️)  
RETURN (↵)

## Updating the unit's firmware

New firmware that provides additional features or product improvements will be released as needed. If the unit is connected to the Internet, you can download the firmware via the network and update it.

The unit's firmware can be updated as follows.

- Update firmware from “Network Update” in the setup menu.
- Update firmware by connecting a USB flash drive to which the unit's firmware update has been saved (p. 93).
- Update firmware using the dedicated MusicCast CONTROLLER app installed on a mobile device. Follow MusicCast CONTROLLER guides to operate the app and update the firmware.

### Notes

- Do not operate the unit or disconnect the power cable or network cable during firmware update. Firmware update takes about 20 minutes or more (depending on your Internet connection speed).
- If the Internet connection speed is slow, or the unit is connected to the wireless network, network update may not be possible depending on the condition of the network connection. In this case, update the firmware using the USB flash drive (p. 93).
- To perform the following procedure, your TV must be connected to the unit via HDMI.
- For details on update, visit the Yamaha website.

## Using “Network Update” in the setup menu to update firmware

When the unit is turned on for the first time after a new version of the unit's firmware has been released, a message indicating that a firmware update is available will be displayed on the TV screen.

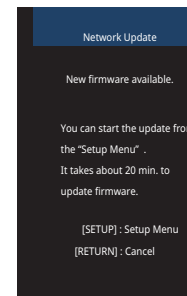

- To update the firmware later, press the RETURN (↵) key when the “Network Update” screen is displayed on the TV screen.

- 1 Press the SETUP (⚙️) key.**
- 2 Use the ▲/▼ keys to select “Network”, and then press the ENTER key.**
- 3 Use the ▲/▼ keys to select “Network Update”, and then press the ENTER key.**

#### 4 Press the ENTER key.

The TV screen goes black and firmware update begins.

Update progress is displayed on the front panel display while firmware is updated.

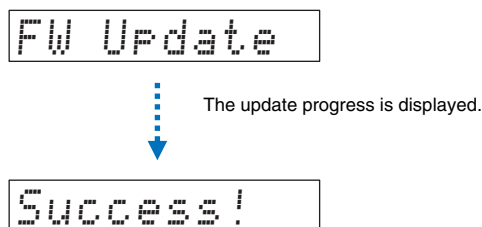

#### 5 When “Success!” is shown in the front panel display, press the ⏻ key on the unit’s top panel.

The firmware update is complete.



- If the firmware update fails, use the ⏻ key to turn the unit off and then on again, and repeat the procedure from step 1 again.
- If “XXXXSumError” is displayed, a problem with communications over the network has occurred. Check communications status, use the ⏻ key to turn the unit off and then on again, and then repeat the procedure from step 1 again.

## Updating firmware with connection of a USB flash drive

Download the latest firmware version from the Yamaha website to a USB flash drive, which can then be used to update the unit’s firmware.

See information provided when updating firmware for details.

#### 1 Save this unit’s firmware to a USB flash drive.

#### 2 Turn off the unit.

#### 3 Connect the USB flash drive to the UPDATE ONLY jack on the unit’s rear panel.

#### 4 Select “FW UPDATE” in the advanced setup menu, and press the ENTER key.

#### 5 Use ▲/▼ key to select “Start OK?”, and press the ENTER key.

The firmware update begin.

Update progress is displayed on the front panel display while firmware is updated.

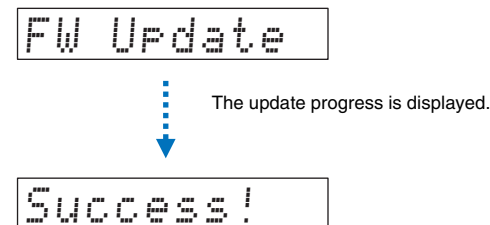

#### 6 When “Success!” is shown in the front panel display, press the ⏻ key on the unit’s top panel.

The firmware update is complete.



- If the firmware update fails, use the ⏻ key to turn the unit off and then on again, and repeat the procedure from step 1 again. If the firmware update fails again, confirm the USB flash drive is correctly connected to the UPDATE ONLY jack.
- If any of the following messages are displayed, a problem has occurred during the update.
  - “Not found”:  
The USB flash drive does not contain the firmware data. Use a PC to properly save the firmware data to the USB flash drive again.
  - “XXXXSumError”:  
There is a problem with the data stored on the USB flash drive. Use a PC to confirm data on the USB flash drive.

# APPENDIX

## Troubleshooting

Refer to the chart below when this unit does not function properly. If the problem you are experiencing is not listed below or if the instruction below does not help, turn off the unit, disconnect the AC power supply cable, and contact the nearest authorized Yamaha dealer or service center.

### General

Problem	Cause	Remedy	See page
<b>This unit does not operate properly.</b>	The internal microcomputer has been frozen by an external electric shock (such as lightning or excessive static electricity) or by a power supply with low voltage.	Disconnect the AC power supply cable from the outlet and plug it again in after 30 seconds.	–
<b>This unit fails to turn on when the  key is pressed, or the unit is turned off soon after the power has been turned on.</b>	The AC power supply cable is not firmly connected to the AC wall outlet.	Connect the AC power supply cable firmly to the AC wall outlet.	28
	The internal microcomputer has been frozen by an external electric shock (such as lightning or excessive static electricity) or by a power supply with low voltage.	Disconnect the AC power supply cable from the outlet and plug it again in after 30 seconds.	–
	"PANEL LOCK" is set to "ON".	Set to "OFF".	89
<b>This unit is suddenly turned off.</b>	The internal temperature becomes too high and the overheat protection circuitry has been activated.	Wait for about 1 hour for this unit to cool down, turn it back on after confirming an adequate amount of ventilation space and not to cover this unit with a cloth.	–
	When the Auto Power Standby function is enabled, this unit turns off automatically in any of the following situations: – Audio is coming from the selected input source, but no operations have been performed for 8 hours or more. – HDMI1–3, <i>Bluetooth</i> or NET is selected as the input source, but no audio has been input to the unit or no operations have been performed with the unit for more than 20 minutes.	Turn on the power of the unit and play back the source again. If the Auto Power Standby function is not used, set "AUTO POWER STANDBY" to "OFF".	90

Problem	Cause	Remedy	See page	
<b>No sound or sound is too low.</b>	Incorrect input or output cable connections.	Connect the cable properly.	25	
	No appropriate input source has been selected.	Select an appropriate input source with the input selector keys.	39	
	The volume is turned down.	Turn up the volume.	39	
	The sound is muted.	Press the MUTE (  ) or VOL (+/-) key to resume audio output and adjust the volume level.	39	
	There is input signal cannot be played back by this unit.	Play a source whose signals can be reproduced by this unit. Change the system settings of the source device.	110	
	"HDMI Audio Out" is set to "TV".	Set to "AMP".	80	
	"HDMI Control" is set to "Off".	When connecting ARC (Audio Return Channel) supported TV and this unit using an HDMI cable only, set "HDMI Control" to "On".		80
		To use this unit with "HDMI Control" set to "Off", connect the TV's audio output jack to this unit's TV (optical digital) input jack via the optical digital audio cable.		24
	Sound from an HDMI control-enabled TV is set for output from the TV's built-in speakers.	Use the TV's HDMI settings to set audio output to any option other than the TV's built-in speakers.		-
No sound is coming from the subwoofer.	Refer to the "No sound is coming from the subwoofer." and "The volume of the subwoofer is low." problems.		96	
<b>Sound is intermittent.</b>	Audio output methods for surround playback were switched.	Sound may be intermittent if the CINEMA DSP program is changed.	-	
<b>No sound or too small sound from a specific channel.</b>	The output level of the channel is muted.	Raise the output level of the channel.	43, 77	
	The beam setting is inappropriate.	Adjust the beam setting.	32, 72	
	The source is played in stereo playback mode.	Switch to surround playback mode.	40, 42	
<b>Surround sound effects are insubstantial.</b>	When connecting this unit with playback device and TV digitally, the output setting of the playback device and TV is not valid.	Refer to documentation supplied with your device and check the setting.	-	
	The playback device is set for constant output from 2 channels (PCM, etc.).	Change the playback device's audio output setting.	-	
	The listening room is not a regular shape, or the unit or listening position is not at the center of the right and left wall of the listening room.	Relocate the unit or listening position.	14	
	There is no wall in the path of the sound beam.	Place the sound reflection board in the path of the sound beam.	103	
	When "My Surround" is set to "On", listening position is not in front of the unit.	Listen in front of this unit.	76	

Problem		Cause	Remedy	See page
<b>No sound is coming from the subwoofer.</b>	<b>Wired/Wireless</b>	The AC power supply cable of the subwoofer is not firmly connected to the AC wall outlet.	Connect the AC power supply cable firmly to the AC wall outlet.	–
	<b>Wired/Wireless</b>	The volume of the subwoofer is low.	Increase the volume of the subwoofer with the SUB + key on the remote control.	39
	<b>Wired/Wireless</b>	The subwoofer's built-in protective circuit was activated. (The STATUS indicator on the subwoofer glows orange.)	Disconnect the power cable, and contact your nearest Yamaha dealer or service center to request repair.	–
	<b>Wired</b>	"Bass Out" of "Subwoofer" is set to "Wireless".	Set it to "Wired".	76
	<b>Wired</b>	The system control cable (3.5 mm monaural mini plug cable) and subwoofer cable (RCA mono cable) are not connected firmly.	Connect the cables firmly.	29
	<b>Wireless</b>	Conditions for wireless communications are not good, and the center unit and the subwoofer are not connected. (The STATUS indicator on the subwoofer flashes green, or glows red.)	Move the subwoofer closer to the center unit. If the problem persists, move the subwoofer to a location where its STATUS indicator steadily glows green.	–
			If there are obstacles such as metal furniture obstructing communications between the center unit and the subwoofer, rearrange the furniture or reposition the subwoofer.	–
			If there are devices such as microwave ovens or wireless network devices that emit electromagnetic waves, move the center unit and the subwoofer away from these devices.	–
			Use cables to connect the subwoofer to the center unit.	29
<b>Wireless</b>	The center unit is not paired with the subwoofer. (The STATUS indicator on the subwoofer flashes or grows red.)	Move the subwoofer closer to the center unit to improve conditions for wireless communications, and pair the two. If the indicator on the subwoofer does not glow green steadily after pairing, the unit may be malfunctioning. Disconnect the power cable and contact your nearest Yamaha dealer or service center to request repairs.	76	
<b>Wireless</b>	"Bass Out" of "Subwoofer" is set to "Wired".	Set to "Wireless".	76	
<b>The volume of the subwoofer is low.</b>	<b>Wired/Wireless</b>	The volume of the subwoofer is low.	Increase the volume of the subwoofer with the SUB + key on the remote control.	39
	<b>Wired/Wireless</b>	Content from an input source with a limited support for low tones is playing.	Play content from an input source with broader support for low tones to see if volume is still low.	–
	<b>Wired/Wireless</b>	The unit is in target playback mode.	Switch to surround playback mode or stereo playback mode.	40, 42
	<b>Wired/Wireless</b>	_____	Move or reposition the subwoofer.	13
	<b>Wired/Wireless</b>	A subwoofer other than that supplied with this unit is connected.	This unit supports the supplied subwoofer NS-WSW121 only.	–



Problem	Cause	Remedy	See page	
<b>Sound from the subwoofer is intermittent.</b>	<b>Wired</b>	Cables used to connect the subwoofer to the center unit are not connected firmly.	Connect the cables firmly.	29
	<b>Wireless</b>	Wireless communication conditions are not good, and the center unit and the subwoofer are not connected steadily.	Move the subwoofer closer to the center unit. If the problem persists, move the subwoofer to a location where its STATUS indicator steadily glows green.	-
			If there are obstacles such as metal furniture obstructing communication between the center unit and the subwoofer, rearrange the furniture and the subwoofer.	-
			If there are devices such as microwave ovens or wireless network devices that emit electromagnetic waves, move the center unit and the subwoofer away from these devices.	-
<b>The image is not displayed on TV screen.</b>	The HDMI cable is not securely connected.	Connect the HDMI cable properly.	24, 25	
	4K MODE is not properly configured.	Select MODE 1 or MODE 2 in accordance with the 4K signal format.	90	
<b>Menu screen of this unit is not displayed.</b>	The input switch of TV is not set correctly.	Set the TV's input source to this unit.	30	
<b>A digital or high-frequency equipment produces noises.</b>	The unit may be placed close to digital equipment or high-frequency equipment.	Move the equipment away from the unit.	-	
<b>The HDMI control function does not work properly.</b>	"HDMI Control" is set to "Off".	Set "HDMI Control" to "On".	80	
	The HDMI control function is disabled on your TV.	Refer to documentation supplied with your TV and check the setting.	-	
	The number of the connected HDMI devices exceeds the limit.	Disconnect some of the HDMI devices.	-	
	Amplifiers (AV amplifiers, sound bars, etc.) other than the unit are connected to the TV or a playback device with an HDMI cable.	Connect only this unit to the TV or a playback device for use as an amplifier.	-	
<b>When the unit is turned off, video and/or audio from a playback device are not output to the TV.</b>	"HDMI Control" is set to "Off".	Set "HDMI Control" to "On".	25	
<b>Sound beams for the front channels cannot be adjusted manually.</b>	"Front" of "Channel Out" is set to "Stereo".	Set to "Beam" or "Mix".	75	
<b>Audio delay control function is not effective even "Audio Delay" is set to "AUTO".</b>	The TV does not support the audio delay auto adjustment feature.	Adjust timing of sound output manually from "Audio Delay" in the option menu.	88	
<b>"Disable" appears in the front panel display after key operation.</b>	The key is unable to function in the current status of the unit.	_____	-	

## Bluetooth

Problem	Cause	Remedy	See page
<b>Receiving</b> <b>Unable to connect the unit to a Bluetooth device.</b>	"Bluetooth" is set to "Off".	Set it to "On".	81
	<i>Bluetooth</i> is not selected as the input source.	Select <i>Bluetooth</i> as the input source.	48
	Another <i>Bluetooth</i> device is connected.	Terminate the current <i>Bluetooth</i> connection, and connect to the device from which audio should be received.	47, 48
	A <i>Bluetooth</i> adaptor, etc. that you want to connect to the unit has a password other than "0000".	Use a <i>Bluetooth</i> adaptor, etc. whose password is "0000".	47
	The device does not support A2DP.	Connect to a <i>Bluetooth</i> audio device that supports A2DP.	109
	The unit and device are too far apart.	Position the <i>Bluetooth</i> device so that it is less than 10 m (33 ft) from this unit and connect the device to this unit.	47, 48
	There is a device (microwave oven, wireless LAN, etc.) outputs signals in the 2.4 GHz frequency band nearby.	Move this unit away from the device that is emitting radio frequency signals.	-
<b>No sound is heard or the sound is intermittent via the unit.</b>	The device is not set to send <i>Bluetooth</i> audio signals to the unit.	Check that the <i>Bluetooth</i> function of the device is set properly.	-
	Playback on the device has not been performed.	Perform playback on the device.	-
	The device's volume is set to minimum.	Turn up the volume level on the device.	-
	The unit and device are too far apart.	Move the <i>Bluetooth</i> device so that it is less than 10 m (33 ft) from this unit.	47, 48
	There is a device (microwave oven, wireless LAN, etc.) outputs signals in the 2.4 GHz frequency band nearby.	Move this unit away from the device that is emitting radio frequency signal.	-
	The <i>Bluetooth</i> connection of the unit with the device is disconnected.	Perform <i>Bluetooth</i> connection operations again.	48

Problem	Cause	Remedy	See page
<b>Transmitting</b> <b>Cannot make the unit connected to the <i>Bluetooth</i> device.</b>	"Bluetooth" is set to "Off".	Set it to "On".	81
	"Transmission" is set to "Off".	Set it to "On".	81
	Another <i>Bluetooth</i> device is connected.	Terminate the current <i>Bluetooth</i> connection, and connect to the device to which audio should be transmitted.	47, 49
	The device does not support A2DP.	Connect to a <i>Bluetooth</i> audio device that supports A2DP.	109
	The unit and device are too far apart.	Position the <i>Bluetooth</i> device so that it is less than 10 m (33 ft) from this unit and connect the device to this unit.	47, 49
	There is a device (microwave oven, wireless LAN, etc.) outputs signals in the 2.4 GHz frequency band nearby.	Move this unit away from the device that is emitting radio frequency signals.	-
	<b>No sound is heard or the sound is intermittent via the <i>Bluetooth</i> device.</b>	The device is not set to receive <i>Bluetooth</i> audio signals from the unit.	Check that the <i>Bluetooth</i> function of the device is set properly.
The device's volume is set to minimum.		Turn up the volume level on the device.	-
The sound to be transmitted is not playing.		Play audio on the device selected with the input selector key.	49
The unit and device are too far apart.		Move the <i>Bluetooth</i> device so that it is less than 10 m (33 ft) from this unit.	47, 49
There is a device (microwave oven, wireless LAN, etc.) outputs signals in the 2.4 GHz frequency band nearby.		Move this unit away from the device that is emitting radio frequency signals.	-
The <i>Bluetooth</i> connection of the unit with the device is disconnected.		Perform <i>Bluetooth</i> connection operations again.	49
Attempted to establish a connection during playback with AirPlay.		Playback with AirPlay cannot be transmitted. Terminate AirPlay playback and try again to establish a connection.	49, 66

## Remote control

Problem	Cause	Remedy	See page
<b>The remote control does not work and/or function properly.</b>	The wrong distance or angle.	The remote control functions within a maximum range of 6 m (20 ft) and no more than 30 degrees off-axis from the front panel.	7
	Direct sunlight or lighting (from an inverter type of fluorescent lamp, etc.) is striking the remote control sensor of this unit.	Reposition this unit.	-
	The batteries are weak.	Replace all batteries.	7

## Network

Problem	Cause	Remedy	See page
<b>The network feature does not function.</b>	The network parameters (IP address) have not been obtained properly.	Enable the DHCP server function on your router and set "DHCP" in the setup menu to "On" on the unit. If you want to configure the network parameters manually, check that you are using an IP address which is not used by other network devices in your network.	83
<b>"Not connected" is displayed with "Wireless (Wi-Fi)" configuration; unable to connect to wireless router (access point).</b>	The wireless router's MAC address filter is enabled.	A connection cannot be established if the wireless router's MAC address filter is enabled. Check wireless router (access point) settings and try a different connection method.	83
<b>"Not connected" is displayed with "Wireless (Wi-Fi)" configuration using the WPS function ("WPS Button" and "PIN Code") and "Access Point Scan"; unable to connect to wireless router (access point).</b>	The wireless router (access point) does not broadcast its SSID.	A connection cannot be established if the wireless router (access point) is configured so that it does not broadcast its SSID. Check wireless router (access point) settings and try a different connection method.	54, 59
<b>"Not connected" is displayed with "Wireless (Wi-Fi)" configuration using the WPS function ("WPS Button" and "PIN Code"); unable to connect to wireless router (access point).</b>	The wireless router (access point) uses WEP encryption.	A connection cannot be established using the WPS function. Try a different connection method.	54, 59
<b>Playback stops unexpectedly and files cannot be played continuously.</b>	The folder contains some files that cannot be played via the unit.	Delete or move files (including video or hidden files) that cannot be played via the unit from the folder.	–
<b>The unit does not detect the PC.</b>	The media sharing setting is not correct.	Configure the sharing setting and select the unit as a device to which music contents are shared.	62
	Some security software installed on your PC is blocking the access of the unit to your PC.	Check the settings of security software installed on your PC.	–
	The unit and PC are not in the same network.	Check the network connections of the unit and PC, and then connect the unit and the PC to the same network.	–
	The MAC address filter is enabled on the unit.	In "MAC Address Filter" in the setup menu, disable the MAC address filter or specify the MAC address of your PC to allow it to access to the unit.	83
<b>The files in the PC cannot be viewed or played back.</b>	The files are not supported by the unit or the media server.	Use the file format supported by both the unit and the media server.	62

Problem	Cause	Remedy	See page
<b>The Internet radio cannot be played.</b>	The selected Internet radio station is currently not available.	There may be a network problem at the radio station, or the service may have been stopped. Try the station later or select another station.	-
	The selected Internet radio station is currently broadcasting silence.	Some Internet radio stations broadcast silence at certain times of the day. Try the station later or select another station.	-
	Access to the network is restricted by the firewall settings of your network devices (such as the router).	Check the firewall settings of your network devices. The Internet radio can be played only when it passes through the port designated by each radio station. The port number varies depending on the radio station.	-
<b>The dedicated apps for mobile device does not detect the unit.</b>	The MAC address filter is enabled on the unit.	In "MAC Address Filter" in the setup menu, disable the MAC address filter or specify the MAC address of your mobile device to allow it to access to the unit.	83
	The unit and mobile device are not in the same network.	Check the network connections and your router settings, and then connect the unit and mobile device to the same network.	-
<b>Firmware update via the network (Network Update) fails.</b>	It may not be possible depending on the condition of the network.	Update the firmware via the network (Network Update) again or use a USB flash drive.	92
<b>The iPod does not recognize the unit when using AirPlay.</b>	The unit and iPod/mobile device are connected to different SSIDs on the same access point.	Check the network connections for the unit and your mobile device, and connect them to the same SSID.	-
<b>The app installed on a mobile device does not recognize the unit.</b>			
<b>The unit cannot connect to the Internet via a wireless router (access point).</b>	The wireless router (access point) is turned off.	Turn on the wireless router (access point).	-
	The unit and the wireless router (access point) are too far apart.	Place the unit and the wireless router (access point) closer to each other.	-
	There is an obstacle between the unit and the wireless router (access point).	Move the unit and the wireless router (access point) in a location where there are no obstacles between them.	-
<b>Wireless network is not found.</b>	There is a device (microwave oven, wireless LAN, etc.) outputs signals in the 2.4 GHz frequency band nearby.	Move this unit away from the device that is emitting radio frequency signals.	-
	Access to the network is restricted by the firewall settings of the wireless router (access point).	Check the firewall setting of the wireless router (access point).	-

## Messages in the front panel display

Message	Description	See page
<b>ViewScreen</b>	This unit's setup menu is displayed on the TV screen. Use the TV screen to configure settings.	69
<b>Key Locked</b>	The keys on the unit are locked. Use the remote control.	89
<b>Sleep XXmin</b>	The Auto Power Standby function will turn this unit off in XX minutes.	89
<b>Protected</b>	SYSTEM MEMORY 1–3 and NET RADIO 1–3 are protected.	89
<b>Disable</b>	<p>Key operation is disabled. This message is displayed in the following situations.</p> <ul style="list-style-type: none"> <li>• When the <i>Bluetooth</i> function is disabled, <i>Bluetooth</i> cannot be selected as the input source.</li> <li>• When using target playback mode, the channel level cannot be adjusted.</li> <li>• When using My Surround, CINEMA DSP programs are not available.</li> <li>• When audio signals with a sampling frequency higher than 48 kHz are being played, CINEMA DSP programs are not available.</li> <li>• When audio signals with a sampling frequency higher than 48 kHz are being played, Compressed Music Enhancer is not available.</li> </ul>	<p>48</p> <p>42</p> <p>76</p> <p>41</p> <p>43</p>

## When surround effect is not enough

The unit achieves its surround sound effects by projecting sound beams which reflect off walls. The sound beams are not reflected toward to the listening position caused by furniture, etc., in the path of sound beams, or the room shape. In this case, the sound may become unbalanced.

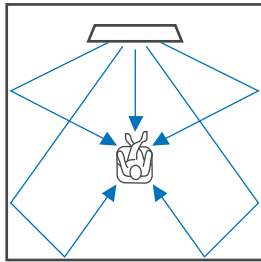

Figure 1. Ideal condition

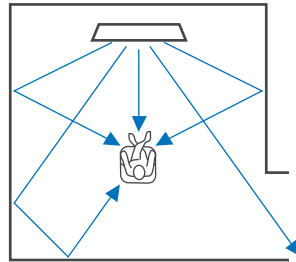

Figure 2. Surround right beam is not being reflected because there is no wall.

Surround right is quieter than surround (left), or surround right is in front of its proper location.

If the sound beams are not reflected toward to the listening position (figure 2), you can adjust for this by installing the optional sound reflection board YRB-100.

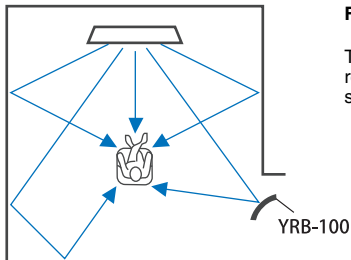

Figure 3. With a sound reflection board installed

The sound beam for surround right is reflected correctly, and correct surround sound effect is achieved.

## Installing and adjusting the sound reflection board YRB-100

### 1 Decide the position of the sound reflection board.

Install the sound reflection board as shown in the picture.



- Always hold the pole when moving the sound reflection board.



- Use "Channel Level" in the setup menu (p. 77) to determine the precise direction from which sounds are difficult to hear.

#### Recommended position for installation

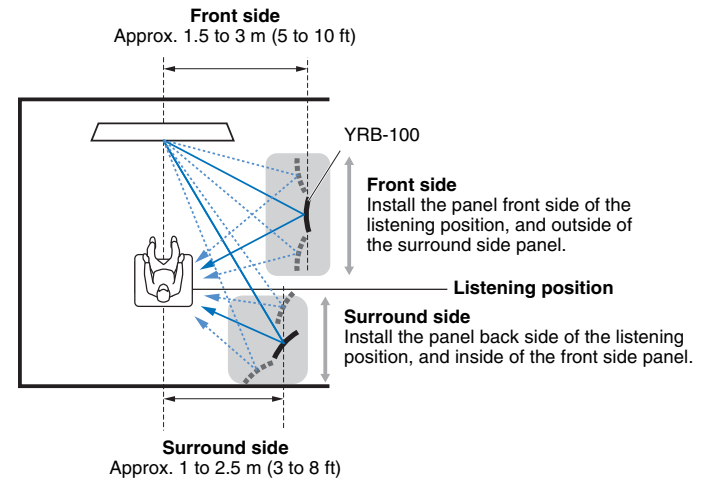

- YRB-100 may not be available in some countries or regions.

## 2 Use advanced setup (p. 89) to configure the sound reflection board.

Set “YRB FL” (FL), “YRB FR” (FR), “YRB SL” (SL), and “YRB SR” (SR) to “YES” depending upon the position of the sound reflection board to be installed.

Color bars are displayed across the entire TV screen. This makes it easier to recognize whether the TV screen is reflected in the panel when determining the proper angle of the panel in step 4, to the left or right.

## 3 Adjust the height.

Adjust the height of the sound reflection board panel based on the position of the unit and the sound reflection board, as well as the listening position.

See the YRB-100 Owner’s Manual for more information.

## 4 Adjust the angle of the panel left or right.

Adjust the angle of the panel so that sound beams are reflected toward the listening position.

Turn on the TV and dim the lights in the room. If you see the TV screen (color bar display) reflected in the panel from your listening position, the angle of the panel is properly adjusted.

See the YRB-100 Owner’s Manual for more information.

## 5 Press the key to turn this unit off. Press it a second time to turn this unit on again.

## 6 Plug the IntelliBeam microphone into this unit and then perform “AUTO SETUP” (Beam+Sound optimize) from the “IntelliBeam” menu (p. 33).

Be sure that the channels (FL, FR, SL, and SR) configured for the sound reflection board are displayed for “YRB” on the SHOW RESULT screen.

An asterisk (\*) is displayed with a channel exhibiting poor sound beam reflection.

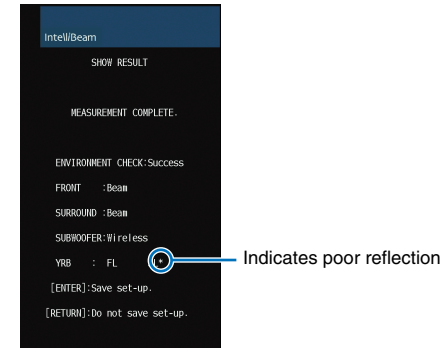

Should this occur, follow the instructions below to re-adjust the panel.

- ① Adjust the height and angle of the sound reflection board panel in accordance with installation conditions.
- ② Use “Channel Level” in the setup menu (p. 77) to confirm that the test sound is successfully reflected.  
For greater precision, perform “AUTO SETUP” in the “IntelliBeam” menu, and then confirm that the asterisk (\*) is no longer displayed with the channel.

If the asterisk (\*) continues to be displayed, or if there is still no test sound reflected from the direction of the sound reflection board, follow directions in the YRB-100 Owner’s Manual to adjust sound beams manually.



## Pairing the center unit and subwoofer



- Be sure that “Bass Out” of “Subwoofer” in the setup menu is set to “Wireless” (p. 76).

Pairing is the process of establishing a wireless connection between the center unit and subwoofer.

When the center unit is turned on for the first time, the center unit and subwoofer are usually paired automatically. If a problem occurs (e.g., the STATUS indicator on the subwoofer does not glow green), follow the instructions below to pair the center unit and subwoofer manually.

- 1 Turn on the center unit.**
- 2 Press the SETUP (⚙) key.**
- 3 Use the ▲/▼ keys to select “Beam”, and then press the ENTER key.**
- 4 Use the ▲/▼ keys to select “Subwoofer”, and then press the ENTER key.**
- 5 Use the ▲/▼ keys to select “Pairing”, and then press the ENTER key.**

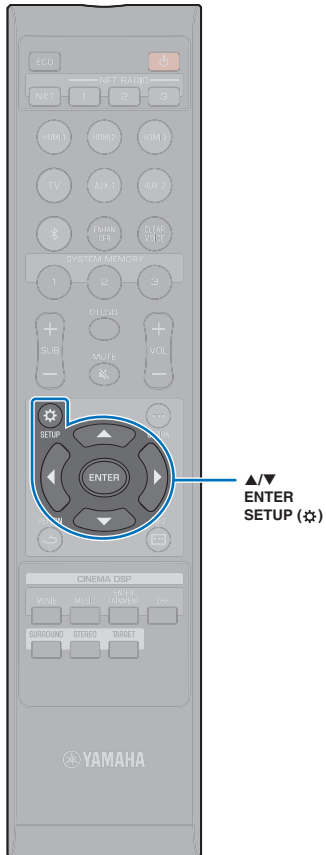

- 6 Use an object with a fine point, such as a pin, to hold down the SUBWOOFER PAIRING button on the subwoofer for more than 3 seconds.**

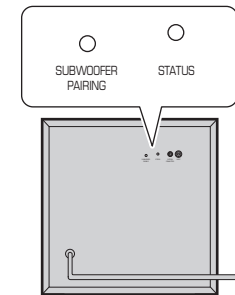

Rear panel of the subwoofer

The subwoofer’s STATUS indicator will rapidly blink green. Once pairing has been completed and the link between the center unit and subwoofer has been re-established, the STATUS indicator will glow green. “Completed” appears on the TV screen.



- If “Not connected” is displayed on the TV screen or the subwoofer’s STATUS indicator does not glow green after 30 seconds have passed, repeat the procedure from step 2. If the problem persists, refer to “No sound is coming from the subwoofer.” in “Troubleshooting” (p. 96).

## Basic knowledge of surround sound

### What is Surround Sound?

Surround sound offers the sense of being surrounded by sounds, an experience common in concert halls and movie theaters. This can be achieved by surrounding the audience with numerous speakers from which sound is output uniformly in all directions. This "surround sound" technology immerses the listener in sound with speakers positioned not only in front of the listener, but also behind and to the sides of the listener, making him or her feel as if they are actually in the situation.

For precise directional control and quality of sound reproduction, sounds must be split into separate audio channels for output to each speaker. Surround sound systems for regular home use (7.1-channel speaker systems) produce surround sound using seven speakers and a subwoofer, as shown below:

Typical 7.1 channel speaker system

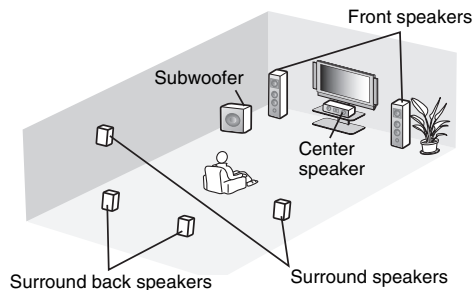

A highly realistic sound field can be created with multiple speakers installed around the listening position as shown in the illustration above. However, this can be difficult to do in a living room. The unit utilizes "digital sound projector" technology, enabling it alone to provide a realistic and engaging surround sound experience.

### What is a Digital Sound Projector?

A digital sound projector provides optimal control over the delay time for each of the compact speakers installed in orderly rows, and drives the amplifier for each of these speakers, synthesizing audio signals output from each speaker as highly focused sounds (sound beams).

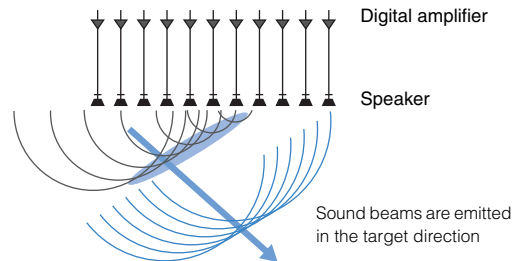

These focused sounds possess wave-like characteristics. When they hit a hard wall, they are reflected off the wall. A digital sound projector outputs sound beams from five channels, including front (left/right), center, and surround (left/right) channels, by reflecting these beams off the walls so that sounds reach the listener from the appropriate direction. It features a technology that enables true surround sound without requiring the installation of speakers behind or to the sides of the listener.

By combining sound beams coming from the front (left/right) and back (left/right), it can also create two new audio channels for surround sound playback using 7 channels. With this configuration, the new audio channels output sounds from surround sound channels, while sound beams coming from behind the listening position (left/right) output sounds from surround back channels.

The sound image of the system

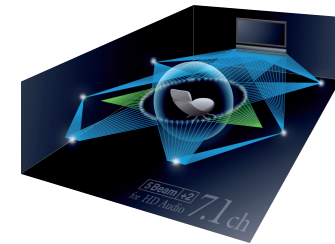

### Yamaha's audio technologies

This unit features many more functions based on Yamaha's superior audio technologies.

#### Compressed Music Enhancer

This technology enhances and extends bass and treble, which tend to be weak in digitally compressed formats such as MP3 used with portable digital audio players and computers. This makes compressed audio sound more musically dynamic.

#### CINEMA DSP

This technology enables precise digital recreation of actual acoustic environments found in well-known concert halls and movie theaters. This is achieved using Yamaha's exclusive sound field programs, which are based on data measured in various sound fields, and with which the amplitude, depth, and volume of sounds have been adjusted.

## Audio/video information

### Sampling Frequency and Bit Depth

These are values that represent the amount of information used to convert analog signals to digital signals. They may be expressed as 48kHz/24bit, for example.

- **Sampling Frequency**

This defines the number of samples per second (sampling a finite set of discrete values in an analog signal). The higher the sampling rate, the broader the range of frequencies that can be played back.

- **Bit Depth**

This defines the amplitude value of sounds when quantifying analog signals as finite values. The higher the bit depth, the deeper sounds are reproduced.

### Deep Color

This is a video technology supported by the HDMI standard. It processes RGB or YCbCr signals at bit depths of 10, 12, or 16 bits per color, whereas conventional formats utilize only 8-bit processing, enabling reproduction of more colors. Its gamut is comprised of a billion or more colors, while the gamuts of conventional formats are comprised of only millions of colors or less. This broader gamut results in more precise reproduction of colors and greater detail in darker portions.

### Dolby Digital

This is a compressed audio format for 5.1 channels. It was developed by Dolby Laboratories, and is widely used with DVD discs.

### Dolby Digital EX

This technology enables 6.1-channel playback for sources encoded in the Dolby Digital EX format. It takes the Dolby Digital 5.1-channel setup one step further with an additional back surround channel.

### Dolby Digital Plus

This is a compressed audio format for 7.1 channels developed by Dolby Laboratories. It is fully compatible with Dolby Digital and is available for playback on Dolby Digital-enabled audio systems. It is widely used with Blu-ray Discs.

### Dolby Pro Logic II

This technology converts audio signal recorded in 2 channels to 5-channel signal. There are three modes available: "Music mode" for stereo music sources, "Movie mode" for movie sources, and "Game mode" for game sources.

### Dolby Pro Logic IIx

This technology converts not only audio recorded in 2 channels, but also audio signal recorded in multiple channels to discrete 7-channel sound. There are three modes available: "Music mode" for music sources, "Movie mode" for movie sources and "Game mode" for game sources.

### Dolby TrueHD

This advanced lossless audio technology was developed by Dolby Laboratories for high-definition disc-based media to deliver sounds that are identical, bit for bit, to studio masters for a great home theater experience. It delivers up to 8 discrete channels of 24-bit/96-kHz (up to 6 discrete channels of 24-bit/192 kHz) audio simultaneously, and is widely used with Blu-ray Discs.

### DTS Digital Surround

This is a compressed audio format for 5.1 channels developed by DTS. It is widely used with DVD discs.

### DTS Express

This is a compressed audio format for 5.1 channels. It provides a higher compression ratio than the DTS Digital Surround audio format, and was developed specifically for network streaming and Blu-ray Disc secondary audio.

### DTS-HD High Resolution Audio

This is a compressed audio format for 24-bit/96-kHz superior sound quality with 7.1 channels developed by DTS. It is fully compatible with DTS Digital Surround, and is widely used with Blu-ray Discs.

### DTS-HD Master Audio

This advanced lossless audio technology was developed by DTS for high-definition disc-based media to deliver sounds identical, bit for bit, to studio masters for a great home theater experience. It delivers up to 8 discrete channels at 24-bit/96 kHz (up to 6 discrete channels at 24-bit/192 kHz) audio simultaneously, and is widely used with Blu-ray Discs.

### DTS Neo:6

This technology enables discrete 6-channel playback from 2-channel sources. There are two modes available: "Music mode" for music sources and "Cinema mode" for movie sources. It provides a channel split effect similar to sources recorded as discrete surround sound.

### HDMI

High-Definition Multimedia Interface (HDMI) is a digital audio/video interface that has become an industry standard around the world. It is capable of transmitting both digital video and audio signals intact via a single cable. It is also compliant with the High-bandwidth Digital Content Protection (HDCP) standard. See <http://www.hdmi.org> for more information.

### Pulse Code Modulation (PCM)

This technology records analog audio signals in digital form, converts analog audio signals to digital audio signals, and transmits analog audio signals in digital form. It is the underlying technology for all digital audio signal systems, and is widely used with CDs, Blu-ray Discs, and many other types of media as an uncompressed audio format known as Linear PCM.

### x.v.Color

This is a color space supported by HDMI. It has become an international standard for video and offers a broader gamut than does the sRGB standard for expression of colors never before possible. It expands the color space while ensuring compatibility with the sRGB standard for more natural and vivid images.

## Network information

---

### **SSID**

SSID (Service Set Identifier) is a name that identifies a particular wireless LAN access point.

### **Wi-Fi**

Wi-Fi is a technology that allows an electronic device to exchange data or connect to the Internet wirelessly using radio waves. Wi-Fi offers the advantage of eliminating the complexity of making connections with network cables by using wireless connection. Only products that complete Wi-Fi Alliance interoperability tests can carry the "Wi-Fi Certified" trademark.

### **WPS**

WPS (Wi-Fi Protected Setup) is a standard established by the Wi-Fi Alliance, which allows easy establishment of a wireless home network.

# Specifications

## YSP-CU2700

### Amplifier section

- Rated Output Power  
Tweeter (1 kHz, 1% THD, 4 Ω) ..... 27.2 W
- Maximum Effective Output Power  
Tweeter (1 kHz, 10% THD, 4 Ω) ..... 32 W

### Speaker section

- Speaker Type...Acoustic Suspension/Magnetic Shielding type
- Driver  
Tweeter ..... 2.8 cm (1-1/8 in) Cone × 16
- Impedance ..... 4 Ω
- Frequency Response ..... 500 Hz to 22 kHz

### Input jacks

- Audio Input  
Optical ..... 1 (TV)  
Coaxial ..... 1 (AUX2)  
Analog ..... 1 pair (AUX1)
- HDMI Input ..... 3 (HDMI IN 1 to 3)

### Output jacks

- HDMI output (ARC) ..... 1
- Subwoofer output ..... 1

### Other jacks

- INTELLIBEAM MIC ..... 1
- SYSTEM CONNECTOR ..... 1
- NETWORK ..... 1
- UPDATE ONLY ..... 1

### Network

- Ethernet standard: 100BASE-T/10BASE-T
- Compatible with DLNA ver. 1.5
- Supported codecs  
WAV (PCM format only) /AIFF/FLAC: up to 192 kHz  
ALAC: up to 96 kHz  
MP3/WMA/MPEG-4 AAC: up to 48 kHz
- AirPlay supported
- Internet Radio

### Wireless LAN (Wi-Fi)

- Wireless LAN Standards ..... IEEE802.11b/g/n
- Radio Frequency Band ..... 2.4 GHz
- WPS (Wi-Fi Protected Setup)  
..... Push-Button-Method, PIN Method
- Security Type ..... WEP, WPA2-PSK (AES), Mixed Mode

### Wireless LAN (Wireless Direct)

- Direct connection with mobile devices

### Bluetooth

- *Bluetooth* version Ver. 2.1 +EDR
- Radio Frequency Band ..... 2.4 GHz
- Supported protocols  
Receiving: A2DP, AVRCP  
Transmitting: A2DP
- Supported codecs  
Receiving: SBC, MPEG-4 AAC  
Transmitting: SBC
- Wireless output ..... *Bluetooth* Class 2
- Range (line-of-sight) ..... Approx. 10 m (33 ft)
- Supported content protection method ..... SCMS-T (receiving)

### General

- Power Supply  
[U.S.A. and Canada models] ..... AC 120 V, 60 Hz  
[Taiwan model] ..... AC 110–120 V, 50/60 Hz  
[China model] ..... AC 220 V, 50 Hz  
[Other models] ..... AC 220–240 V, 50/60 Hz
- Power Consumption ..... 24 W
- Standby Power Consumption  
HDMI Control Off, Network Standby Off ..... 0.3 W  
HDMI Control On, Network Standby Off ..... 0.8 W  
HDMI Control Off, Network Standby On  
(Wired/Wi-Fi/Wireless Direct/*Bluetooth*) ..... 1.8/1.8/1.9/1.7 W  
HDMI Control On, Network Standby On ..... 2.3 W
- Dimensions (W × H × D)  
Antenna raised ..... 944 x 91 (110)\* x 154 mm  
(37-1/8 x 3-5/8 (4-3/8)\* x 6 in)  
Antenna lowered ..... 944 x 51 (70)\* x 154 mm  
(37-1/8 x 2 (2-3/4)\* x 6 in)  
\* Values in parentheses are heights with the stands attached.
- Weight ..... 4.0 kg (8.8 lbs)

## NS-WSW121

- Driver ..... 14 cm (5-1/2 in) cone woofer × 1 non-magnetic shielding type
- INPUT jack.....1
- SYSTEM CONNECTOR jack.....1
- Output power..... 75 W (100 Hz, 6 Ω, 10% T.H.D)
- Dynamic power..... 130 W
- Frequency response..... 40 Hz–500 Hz
- Wireless  
Radio Frequency Band..... 2.4 GHz  
Transmission Range ..... 10 m (33 ft) (without interference)
- Power supply  
[U.S.A. and Canada models] ..... AC 120 V, 60 Hz  
[Taiwan model] ..... AC 110–120 V, 60 Hz  
[Australia model] ..... AC 240 V, 50 Hz  
[U.K. and Europe models]..... AC 230 V, 50 Hz  
[China model]..... AC 220 V, 50 Hz  
[Korea model]..... AC 220 V, 60 Hz  
[Asia model] ..... AC 220–240 V, 50/60 Hz
- Power consumption ..... 75 W
- Standby Power Consumption  
Wireless ..... 1.5 W  
Wired ..... 1.5 W
- Dimensions (W x H x D)..... 295 × 297 × 307 mm  
(11-5/8 × 11-3/4 × 12-1/8 in)
- Weight..... 9.1 kg (20 lbs)

## YSP-CU2700 + NS-WSW121

- Frequency Response ..... 40 Hz to 22 kHz (-10 dB)
- Crossover frequency ..... 500 Hz

The contents of this manual apply to the latest specifications as of the publishing date. To obtain the latest manual, access the Yamaha website then download the manual file.

## HDMI signal

### • Audio signals

Audio signal types	Audio signal formats	Compatible media
2ch Linear PCM	2ch, 32–192 kHz, 16/20/24 bit	CD, DVD-Video, DVD-Audio, etc.
Multi-ch Linear PCM	8ch, 32–192 kHz, 16/20/24 bit	DVD-Audio, Blu-ray disc, HD DVD, etc.
Bitstream (SD Audio)	Dolby Digital, DTS	DVD-Video, etc.
Bitstream (HD Audio)	Dolby TrueHD, Dolby Digital Plus, DTS-HD Master Audio, DTS-HD High Resolution Audio, DTS Express	Blu-ray disc, HD DVD



- Refer to documentation supplied with the playback device, and set the device appropriately.
- When CPPM copy-protected DVD-Audio is played back, video and audio signals may not be output depending on the type of the DVD player.
- This unit is not compatible with HDCP-incompatible HDMI or DVI devices. Refer to documentation supplied with the HDMI or DVI device for HDCP compatibility.
- To decode audio bitstream signals on this unit, set the input source device appropriately so that the device outputs the bitstream audio signals directly (does not decode the bitstream signals on the device). Refer to documentation supplied with the device for details.

### • Video signals

This unit is compatible with the following video signals.

- Deep Color
- x.v.Color
- 3D video signal
- High Dynamic Range (HDR) video

This unit is compatible with the following resolutions.

- VGA
- 720p/60 Hz, 50 Hz
- 480i/60 Hz
- 1080i/60 Hz, 50 Hz
- 480p/60 Hz
- 1080p/60 Hz, 50 Hz, 30 Hz, 25 Hz, 24 Hz
- 576i/50 Hz
- 576p/50 Hz
- 4K (4:4:4, 4:2:2, 4:2:0)/60 Hz, 50 Hz, 30 Hz, 25 Hz, 24 Hz



- The resolution of transmitted video signal varies according to specifications of the TV connected to this unit.

## Digital audio signal

### • Optical/coaxial

Audio signal types	Audio signal formats	Compatible media
2ch Linear PCM	2ch, 32–96 kHz, 16/20/24 bit	CD, DVD-Video, DVD-Audio, etc.
Bitstream	Dolby Digital, Dolby Digital EX, DTS, DTS-ES	DVD-Video, etc.

### • HDMI (ARC)

Audio signal types	Audio signal formats	Compatible media
2ch Linear PCM	2ch, 32–192 kHz, 16/20/24 bit	TV
Bitstream	Dolby Digital Plus, Dolby Digital, DTS	TV



MusicCast is a trademark or registered trademark of Yamaha Corporation.



The "CINEMA DSP" logo and "Cinema DSP" are registered trademarks of Yamaha Corporation.

## IntelliBeam

The "IntelliBeam" logo and "IntelliBeam" are trademarks of Yamaha Corporation.



Manufactured under license from Dolby Laboratories.

Dolby, Dolby Audio, Pro Logic, and the double-D symbol are trademarks of Dolby Laboratories.



For DTS patents, see <http://patents.dts.com>. Manufactured under license from DTS Licensing Limited. DTS, DTS-HD, the Symbol, & DTS and the Symbol together are registered trademarks of DTS, Inc. © DTS, Inc. All Rights Reserved.



The terms HDMI, the HDMI Logo, and High-Definition Multimedia Interface are trademarks or registered trademarks of HDMI Licensing LLC in the United States and other countries.

## x.v.Color

"x.v.Color" and "x.v.Color" logo are trademarks of Sony Corporation.



DLNA™ and DLNA CERTIFIED™ are trademarks or registered trademarks of Digital Living Network Alliance. All rights reserved. Unauthorized use is strictly prohibited.



The Wi-Fi CERTIFIED Logo is a certification mark of Wi-Fi Alliance. The Wi-Fi Protected Setup Identifier Mark is a certification mark of Wi-Fi Alliance.

Wi-Fi, Wi-Fi Alliance, Wi-Fi CERTIFIED, Wi-Fi Protected Setup, WPA and WPA2 are trademark or registered trademark of Wi-Fi Alliance.



The *Bluetooth*® word mark and logos are registered trademarks owned by *Bluetooth* SIG, Inc. and any use of such marks by Yamaha Corporation is under license.



"Made for iPod," "Made for iPhone," and "Made for iPad" mean that an electronic accessory has been designed to connect specifically to iPod, iPhone, or iPad, respectively, and has been certified by the developer to meet Apple performance standards. Apple is not responsible for the operation of this device or its compliance with safety and regulatory standards. Please note that the use of this accessory with iPod, iPhone, or iPad may affect wireless performance. Supports iOS 7 or later for setup using Wireless Accessory Configuration.

iTunes, AirPlay, iPad, iPhone, iPod, iPod nano, iPod touch, and Safari are trademarks of Apple Inc., registered in the U.S. and other countries.

### AppStore

App Store is a service mark of Apple Inc.

### Android/Google Play

Android and Google Play are trademarks of Google Inc.

### Blu-ray

"Blu-ray Disc™", "Blu-ray™", and the logos are trademarks of the Blue-ray Disc Association.

### Explanations regarding GPL

This product utilizes GPL/LGPL open-source software in some sections. You have the right to obtain, duplicate, modify, and redistribute this open-source code only. For information on GPL/LGPL open source software, how to obtain it, and the GPL/LGPL license, refer to the Yamaha Corporation website (<http://download.yamaha.com/sourcecodes/musiccast/>).

### Bluetooth protocol stack (Blue SDK)

Copyright 1999-2014 OpenSynergy GmbH

All rights reserved. All unpublished rights reserved.

### Google Noto Fonts

This product uses the following fonts.

Copyright © June 2015, Google (<https://www.google.com/get/noto/#sans-lgc>), with Reserved Font Name Noto Sans Version 1.004.

Copyright © June 2015, Google (<https://www.google.com/get/noto/help/cjk/>), with Reserved Font Name Noto Sans CJK Version 1.004.

This Font Software is licensed under the SIL Open Font License, Version 1.1.

This license is available with a FAQ at: <http://scripts.sil.org/OFL>

### Windows

Windows is a registered trademark of Microsoft Corporation in the United States and other countries.

Internet Explorer, Windows Media Audio and Windows Media Player are either registered trademarks or trademarks of Microsoft Corporation in the United States and/or other countries.

# Index

## Numerics

- 2-channel playback 42
- 3D video 24
- 4K MODE 90
- 4K video 24
- 5.1ch 78
- 7.1ch 78

## A

- Access point scan 55
- Adaptive DRC 77
- ADVANCED 89
- Advanced setup menu 89
- AirPlay 66
- Antenna 23
- Audio Assign 88
- Audio Delay 88
- Audio Return Channel (ARC) 24
- Audio signal information 86
- AUTO POWER STANDBY 90
- Auto setup (IntelliBeam) 32

## B

- Bass 44, 88
- Beam optimize only 35
- Beam Travel Length 72
- Beam+Sound optimize 35
- Bluetooth* 47
- Bluetooth* (receiving audio) 48
- Bluetooth* (transmitting audio) 49
- Bluetooth* settings 81
- Brightness adjustment (front panel display and indicators) 85

## C

- Channel level 43
- Channel Out 75
- Channel output level adjustment (test sound) 77
- CINEMA DSP 106
- CLEAR VOICE 43
- Compressed Music Enhancer 43

## D

- Deep Color 107
- Default gateway 82, 83
- DHCP 50, 83
- Digital Sound Projector 106
- Dimmer 85
- Distance Unit 85
- DLNA 62
- DNS server (P) 82, 83
- DNS server (S) 82, 83
- Dolby Digital 78, 107
- Dolby Digital EX 107
- Dolby Digital Plus 78, 107
- Dolby PLIIx PARAMETER 78, 79
- Dolby Pro Logic II 107
- Dolby Pro Logic IIx 107
- Dolby Pro Logic IIx Music 79
- Dolby TrueHD 107
- DTS Digital Surround 107
- DTS Express 107
- DTS Neo:6 107
- DTS-HD High Resolution Audio 107
- DTS-HD Master Audio 107
- Dynamic Range 78

## E

- Eco function 45

- Encryption method 55, 58, 59, 60
- Entertainment 41
- Error buzzer 34
- Error message 36

## F

- Firmware of this unit 86, 91
- Firmware update 84, 92
- Front panel (center unit) 8

## H

- HDCP version 2.2 24
- HDMI 107
- HDMI audio assignment 88
- HDMI Audio Out 80
- HDMI cable 24, 25
- HDMI control 37, 80

## I

- Installing the unit 13
- IntelliBeam 32
- INTELLIBEAM MIC jack 9
- IntelliBeam microphone 32
- Internet radio 64
- IP address 82, 83
- iPod music (AirPlay) 66
- iTunes music (AirPlay) 66

## L

- Language (OSD) 31
- Language for menu display 85

## M

- MAC address 82



MAC address filter 50, 83  
Manual setting (wireless connection) 57  
Matrix Decoder 78  
Media sharing setup 62  
Menu screen 30  
Mobile device music 68  
Movie 41  
MP3 43  
Music 41  
MusicCast CONTROLLER app 5, 50

## **N**

Network information 82  
Network standby 84

## **O**

Option menu 87  
OSD Language 85  
Output timing adjustment (image and sound) 88

## **P**

Pairing 76, 105  
Power cable 9, 11, 28  
Pulse Code Modulation (PCM) 107

## **R**

Rear panel (center unit) 9  
Rear panel (subwoofer) 11  
Reflection board 103  
Remote control 7, 10  
Remote control sensor 8

## **S**

Sampling frequency 41, 86  
Security 82  
Security key 58, 60  
Security software 50

Setup menu 69  
Sharing Wi-Fi settings (iOS device) 31, 53  
Sound optimize only 35  
Sound output timing (MusicCast-enabled devices) 79  
Sound reflection board 103  
SSID 55, 56, 82, 108  
Stands 18  
Stereo playback 42  
Subnet mask 50, 82  
Subwoofer connections 29, 105  
Subwoofer settings 76  
Subwoofer volume 39  
Surround sound 40  
System memory 46

## **T**

Target playback mode 42  
Test sound 77  
Tone adjustment 44, 88  
Top panel (center unit) 8  
Treble 44, 88  
TV 30, 37  
TV audio input 80

## **U**

USB flash drive (firmware update) 93

## **V**

Video signal information 86  
Volume 39  
Volume Trim 88  
vTuner 64  
vTuner ID 82

## **W**

Wall Mount Bracket 19  
Wi-Fi 108  
Wired network 27

Wireless connection (center unit and subwoofer) 29  
Wireless Direct 60  
Wireless network 27  
WPS 108  
WPS PIN code 59

## **X**

x.v.Color 107



Yamaha Global Site  
<http://www.yamaha.com/>

Yamaha Downloads  
<http://download.yamaha.com/>

Manual Development Group  
© 2016 Yamaha Corporation

Published 06/2016 KS-A0

YH905A0/EN