

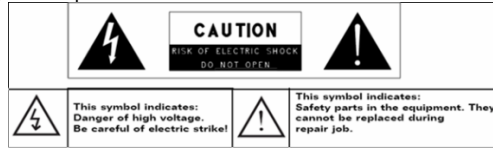

Safety Precautions

- Do not subject the device to severe impact or drop it from heights.
- Do not use the device in extreme hot or cold, dusty or damp conditions. Do not expose it to direct sunlight.
- Avoid using the device near strong magnetic fields.
- Normal functioning of the product may be disturbed by ESD. If so, simply reset and restart the device following the instruction manual. During file transmission, please handle with care and operate in a static-free environment.
- Keep the device away from water and other liquids. In the event that water or other liquids enter the device, power off the product immediately and clean the device.
- Do not use chemicals to clean the device in order to avoid corrosion. Clean it with a dry cloth.
- Do not install this equipment in a confined space such as a book case or similar unit. The ventilation should not be impeded by covering the ventilation openings with items such as newspaper, table-cloths, curtains etc.
- No naked flame sources, such as lighted candles, should be placed on the apparatus.
- Attention should be drawn to environmental aspects of battery disposal.
- Use the apparatus in moderate climates.
- We are not responsible for damage or lost data caused by malfunction, misuse, modification of the device or battery replacement.
- Do not attempt to disassemble, repair or modify the product. This will invalidate the warranty.
- If the device will not be used for an extended period of time, please charge the battery at least once per month to maintain battery life.
- Charge the battery if:
 - a) The battery level icon displays  (An empty battery)
 - b) The device powers off automatically when restarted.
 - c) There is no response when pressing keys with keys unlocked and battery full.
- Do not interrupt the connection when the device is being formatted or transferring files. Otherwise, data may be corrupted or lost.
- When the device is used as a portable HD, please use only per the instructions. Otherwise, permanent data loss could occur.
- Please use and install data using the attachments/accessories provided and only according to the manufacturer's instruction.
- Please refer to the information on the bottom of the device for electrical and safety information before installing data or operating the device.
- To reduce the risk of fire or electric shock, do not expose this device to rain or moisture. The device should not be exposed to dripping or splashing. Never place objects filled with liquids, such as vases, on the device.
- There is danger of explosion if the battery is replaced incorrectly. Replace only with the same or equivalent type.

- The battery (battery or batteries or battery pack) should not be exposed to excessive heat such as sunlight, fire or the like.
- Please follow responsible procedures for battery disposal.
- If the power adaptor disconnected from the device, the device will remain operable as long as the battery has sufficient charge.
- The power adaptor is a CLASS II apparatus with double insulation, and no external ground is provided.
- Safety symbol explanation:



- The lightning flash with arrowhead symbol within an equilateral triangle is intended to alert the user to the presence of non-insulated “dangerous voltage” within the product’s enclosure that may be of sufficient magnitude to constitute a risk of electric shock.
- To reduce the risk of electric shock, do not remove the cover (or back) as there are no user-serviceable parts inside. Refer servicing to qualified personnel.
- The exclamation point within an equilateral triangle is intended to alert the user to the presence of important operating and maintenance instructions in the literature accompanying the device.
-  Correct Disposal of this product. This marking indicates that this product should not be disposed of with other household waste in the EU. To prevent possible harm to the environment or human health from uncontrolled waste disposal, recycle it responsibly to promote the sustainable reuse of material resources. To dispose of your used device, please use the return and collection systems available in your area or contact the retailer where the product was purchased. They can take this product for safe environmental recycling.

Listening Cautions

- This product respects the current regulations for limiting the output volume of consumer audio devices to a safe level. By listening to your device with headphones or earbuds at high volumes, you run the risk of permanent damage to your ears. Even if you get used to listening at high volumes and it seems normal to you, you still risk the possibility of damaging your hearing. Reduce the volume of your device to a reasonable level to avoid permanent hearing damage. If you hear ringing in your ears, reduce the volume or shut off your device. This device has been tested with the supplied earphones. In order to preserve your hearing, it is advised that you use only the following headphone models: the earphones supplied with your device, or any other headphones that respect the current regulations. Other types of headphones may produce higher volume levels. (At full power, the prolonged listening of the walkman can damage the ear of the use)
- Maximum output voltage $\leq 150\text{mv}$
- Do not use while operating a motorized vehicle. It may create a traffic hazard and is illegal in many areas.
- You should use extreme caution or temporarily discontinue use in potentially hazardous situations created by obstructed hearing.
- Even if your headphones or earphones are the open-air type designed to let you hear outside sounds, don't turn up the volume so high that you can't hear what's around you.
- Sound can be deceiving. Over time your hearing "comfort level" adapts to higher volumes of sound. What sounds "normal" can actually be loud and harmful to your hearing. Guard against this by setting the volume of your device at a safe level BEFORE your hearing adapts.
To establish a safe volume level:
 - a. Start your volume control at a low setting.
 - b. Slowly increase the sound until you can hear it comfortably and clearly, and without distortion. Once you have established a comfortable sound level, leave it there.

This manual may not reflect your actual device's operation. All information is subject to change without prior notification. Please follow your actual device's operational procedures.

Table of Content

Safety Precautions.....	1
Listening Cautions	3
Feature Summary	5
Accessories	5
Buttons & Ports.....	5
Charging Battery.....	6
Installing Memory Card	6
Transferring Files	6
Turning On/Off	6
Unlocking the Screen.....	7
Home Screen.....	7
Tips of touching screen	9
Accessing Internet	9
Using the Virtual Keyboard	10
Reading E-Books.....	10
Playing Music.....	11
Playing Video.....	12
HDMI Output.....	13
Viewing Photos	13
Using the Camcorder/Camera	14
Exploring Files	15
Sending/Receiving E-mails	16
Other Applications.....	18
Managing Apps	18
Managing Tasks	19
Troubleshooting	19
Specifications.....	20

Feature Summary

- Wi-Fi
- 7.0" Touch Screen
- 3rd-party Application
- Built-in Webcam
- Built-in G-sensor
- Entertainment

Accessories

- Main Unit
- USB cable
- AC Adaptor
- User Manual
- Warranty Card

Buttons & Ports

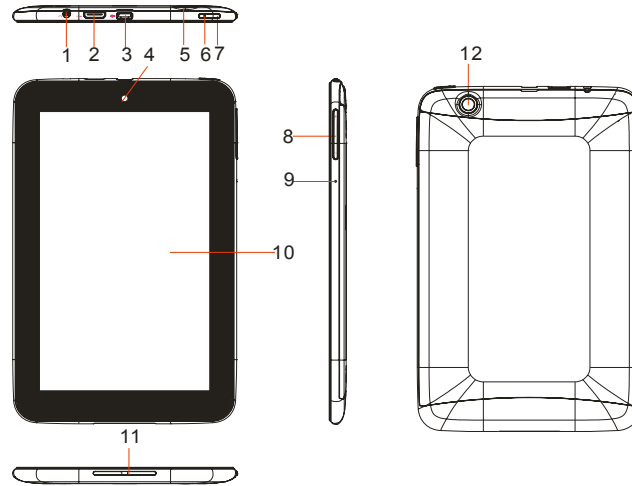

1. **Earphone socket** – connects to stereo earphones.
2. **HDMI jack** – Connects to HD TV that supports HDMI connection.
3. **Micro USB Port** – Connects to PC; connects power adaptor for charging.
4. **Front webcam**
5. **MicroSD card Slot**
6. **Charging indicator**– Lights red when charging; lights orange as charging is over.
7. **Power** –Briefly press to lock or unlock the screen; press and hold for seconds to turn on/off the unit; press and hold long enough to reset it.
8. **VOL+/-** – Increase/ decrease the volume.
9. **Microphone**
10. **Touch screen**
11. **Built-in Speakers**
12. **Rear camera lens**

Charging Battery

The device has a built-in rechargeable battery. No extra battery installation is required. Just charge the device when it indicates low battery.

You can charge the device with the power adaptor or a USB cable connected to PC.

In both methods, the USB port should be used. When connecting the adaptor for charging, plug it into any standard wall outlet. The charge indicator should light red during charging, and should light orange as the battery is fully charged.

You can also charge the device as long as you connect it with a running PC.

Note:

- a. You are strongly recommended to charge the battery immediately when the device indicates the battery is lower than 15%!
 - b. For extended battery life, it is suggested NOT to use the device when it is charging.
 - c. Be sure to use only the dedicated power adaptor provided with the unit for charging.
-

Installing Memory Card

This device can read files directly from memory card.

To use a memory card, find the card slot on the device and then insert the memory card into the slot in the correct orientation. To access the files stored in the memory card, enter the **FileBrowser/ASTRO** mode and select the "SD Card" directory.

Transferring Files

Before reading or playing files, you may need to transfer media files from a computer to the device.

- (1) Connect the device to a computer with the supplied USB cable. Two removable disks will be added to the computer, respectively referring to the internal flash memory and the SD card.
- (2) Once the connection is done, turn on the USB storage.
- (3) Open a removable disk, then copy files from the PC to it.

Note:

Since pre-installed applications and Android OS occupies a considerable part of capacity – about 2.0GB, it is normal that you see huge difference between available memory space and total capacity.

Turning On/Off

To turn on the device, press and hold the **Power** button on the unit until you see the boot-up screen then release.

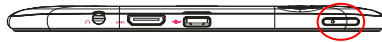

To turn off the device, press and hold the **Power** button until you see the option "Power Off", tap on "Power Off" and then tap on "OK".

Tip: For the sake of power saving, this device may sleep with the screen display locked when there is no touch action for a while (depending on the actual setting of Display-Sleep). You can briefly press the **Power** button to wake it up.

Unlocking the Screen

The screen will be locked after the device is idle for a few seconds. You need to unlock the screen by dragging the lock icon  rightwards before you continue to use the device.



Home Screen



- a. Apps button- Open the apps menu.
- b. ESC button
- c. Home button- Go to the home screen.
- d. Recent opened apps
- e. Battery level

The Home Screen consists five separate screens for positioning the shortcuts, widgets etc.. Slide your finger left or right on the screen to go to the extended screens.



Customizing Home Screen Items

- To add a Home Screen item (shortcut, widget etc.), you can tap the application icon  to display all applications and widgets, then hold your tap on an item to place it on the home page.

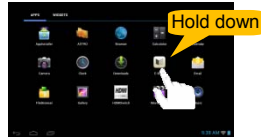

Note: If current page of Home Screen has no enough room for a shortcut or widget, you will be prompted that there is no more room.

- To move a Home Screen item, hold your finger onto it to highlight it, then drag it to the desired location, and release it.
- To remove a Home Screen item, hold your finger onto it to highlight it, drag it to the recycle bin symbol "X" and then release your finger.



Changing the wallpaper

Hold your tap on the Home screen until a menu appear. Tap on "Wallpaper" and then choose a picture as the desktop wallpaper.

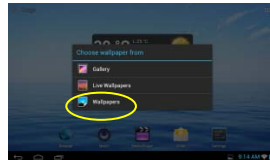

Changing the System Settings

Tap the Setting icon  on the Home Screen to open the settings menu and change relevant settings for your device if necessary.



Display all Applications and widgets

The device has many useful applications and widgets pre-installed. You can tap the Application Tab  to display them.



Tip: Holding your finger on an item can add it to the desktop as a shortcut.

Tips of touching screen

- When watching a video or listening to music, you can tap on the progress bar to play any designated section of the file. You can drag the cursor of the progress bar to any other elapsed time point of the file.
- In different browsers (File, Music, etc.), you can hold your finger on the screen and then drag up and down to scroll the file list up and down.
- In some browsers (File, Music etc.), you may hold your finger on an item to display options.



Accessing Internet

This device features connection of Wi-Fi that provide you easy access to the Internet. For Wi-Fi application, you need to configure a Wi-Fi network first, and you will have to stay in a Wi-Fi service zone. Whenever it is within the coverage of a WiFi network you have configured, the device will attempt to make a connection.

Make WI-FI Connection

Before launching an Internet application such as the web browser, you first need to activate the Wi-Fi and configure a Wi-Fi network.



- (1) Tap the Setting icon  on the Home Screen to open the settings menu.
- (2) Select "WIFI" and slide the toggle switch to "ON" to turn on WIFI.
- (3) The device will scan automatically for available WiFi networks and display them in the right panel. The list of available networks shows all the wireless networks in range of your device.
- (4) Choose a network from the list and then tap "Connect" to connect. Some network may be secured with password, enter the password before connecting. If the connection is successful, the message Connected to (WiFi Network Name) will appear under the WIFI Setting.







Note:

1. The available network list is constantly refreshed automatically.
 2. When the Wi-Fi is enabled, the device will connect automatically to your configured networks when they are in range.
-

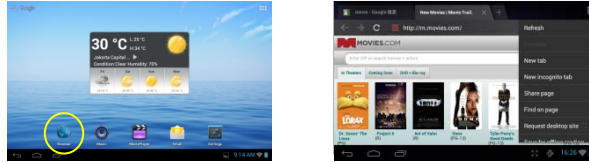
Launching the Web browser

To launch the Web browser, you tap the Browser icon  in the Home screen. To display context menus, tap .



- You can scroll the screen up and down by tapping on the page and dragging it up or down (be careful not to tap a link until you are ready!).
- To open a link, simply tap it.
- To go back to the previous page that you browsed, tap the Back icon .
- To display the available menu items, tap the Menu icon .
- To go back directly to the Home screen, tap the Home icon .

Using the Virtual Keyboard

Tapping on any text input field can open the virtual board. With the virtual keyboard, you can enter a website address or any text required.

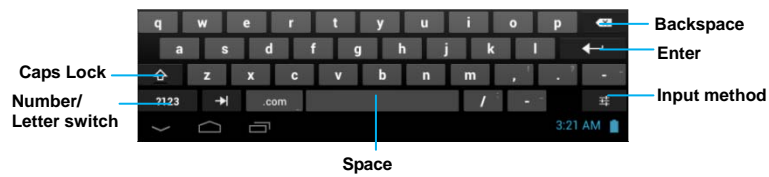

Reading E-Books

This device has a pre-installed E-Book reader, which allows you to read free ebooks from the local memory or the Internet.

Get E-books

To get some e-books, you can copy them from a PC to the device via USB port (see the "Transferring files" section mentioned above), or try to download some e-books from the Internet.

Note:

Make sure you have the access to the Internet by WiFi connection if you are going to read or download on-line e-books.

Start Reading

To read the local e-books,

- (1) Open the app E-Book, then select one e-book from the local library and tap to open it for reading.
- (2) During your reading, you can slide your finger on the screen left/right to turn up/down the pages.
- (3) Tap the Menu button  to open the context menu which allows you to check your books in either local library or network library, or to perform some preferable setting operations.

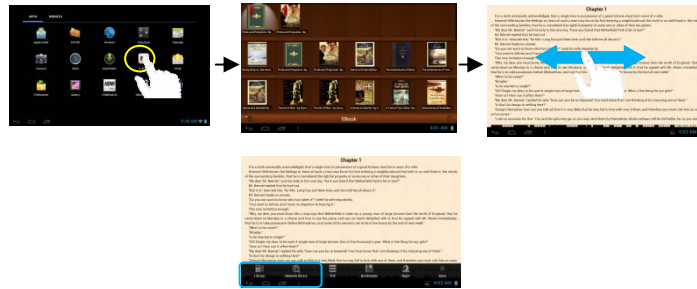

Search for local E-books

- (1) In the Library screen, tap the **Menu** button  to display Search icon.
- (2) Tap the Search icon to bring up the virtual keyboard.
- (3) Input the keywords of the book title, author name or tag name for search.
- (4) The search result will be shown.

Playing Music





Tap the Music icon in the Apps page to launch the music player.

Music Library

You should enter the music library once you start the music player. The Music Library shows your music files sorted by categories (Artist, Album, etc.) if your music files contain these song information tags.



- You can drag your finger up and down on the file list to scroll through it.
- Tap a song to play.

 Artist	List music files by artist.
 Album	List music files by album.
 Songs	List all music files.
 Playlists	List your favorite songs.

 Now Playing	Go to the Now Playing screen.
---	-------------------------------

Playback Screen



- Now Playing List
- Shuffle on /off
- Repeat mode
- Lyrics display on/off
- Artist Name
- Album Name
- Song Title
- Previous song/Rewind
- Play/Pause
- Next song/Fast Forward
- Progress bar

Playback menu

During playback of a music file, tap on the **MENU** icon  to bring up a context menu:

Library– return to music library menu.

Party Shuffle – select Party Shuffle mode.

Add to playlist – add a song to the playlist.

Delete – delete a song.

Sound Effects – Set the sound effects for the music playback.  video player.

Navigate through Video Files

Find the video files/folders under correct directory after you enter the video player.

- You can drag your finger up and down on the video list to scroll through it.
- Tap a video to start playing.

Playback Screen

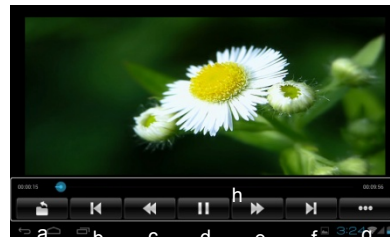

- Return
- Previous Video
- Fast Rewind
- Play/Pause
- Fast Rewind
- Next video
- Video settings
- Progress bar

Video Playback Settings

Tap on the  icon to display the video settings.



HDMI Output

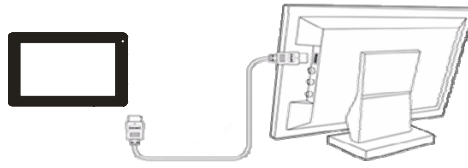

The device features a HDMI interface that allows you to connect it to a digital television. HDMI connection can deliver high-definition audio and video quality.

To use the HDMI function on digital televisions,

- (1) Connect the device to the digital television through HDMI cable.
- (2) Open the HDMISwitch app, then select an HDMI option (HDMI 720p/HDMI1080p) and play a video file;
- (3) Turn on the digital television, and switch its Source mode to HDMI.
- (4) Enjoy the sharpest image quality on the wide screen of television.

Note:

For some reason, conductive objects may cause short circuit to the device when they contact the HDMI jack. Therefore, always avoid using any conductors to touch the HDMI jack.

Viewing Photos

Tap the Gallery icon in the Apps page to launch the Photo Gallery.

Viewing Photos

- (1) Photos should be listed in thumbnail. You can slide your finger on the screen left or right to browse photos.

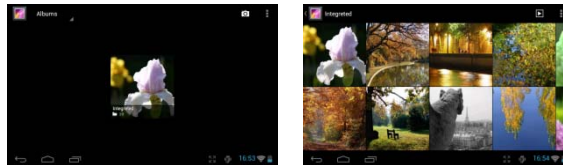

- (2) Tap a photo thumbnail to view the photo in full screen.



(3) To display the previous/next picture, slide your finger on the screen horizontally.



(4) To zoom in or out the picture, pinch your finger on the picture.

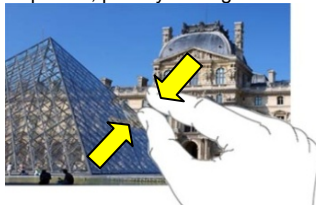

Display Menu

When you are viewing the picture, you can tap on the screen or the Menu icon  to show a menu.





Using the Camcorder/Camera

Tap the Camera in the apps page to launch the Camera.

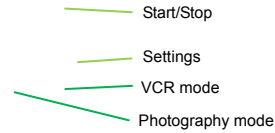











- To start making video clips, tap on the Start/Stop button  to start video recording.
- Tap on the Start/Stop button  again to stop video recording or photographing.
- The video clip / photo can be previewed in the Preview Window.
- To play the video clip that you have made, enter the **Movie Player**, and then tap the video.
- To view the photo that you have taken, enter the Photo Viewer mode, and then tap the photo.

Exploring Files

You can explore files and folders with either the FileBrowser or ASTRO application.

Using the FileBrowser

Navigate through Files and Folders

- Tap the FileBrowser icon in the application page to launch the application.
- You can drag your finger up and down to scroll the file list up and down.
- Tap to open a file or folder.
- You can go back one level in the interface by tapping on the **Back** icon .
- You can go back to the root of directory by tapping Up button .
- Tap  button to enable multiple choices of the files.
- Tap  button to edit (Cut/Copy/Paste/ Delete) the selected file or files.
- Tap  button to browser the file or folders in thumbnails.
- Tap  button to seek for help information on the Internet.
- You can always go back directly to the Home screen by tapping .
- Tapping  can hide/display the toolbar.









Using the ASTRO

Navigate through Files and Folders



- Tap the ASTRO icon in the apps page to launch the application.
- You can drag your finger up and down to scroll the





file list up and down.

- To open a file or folder, tap the file/folder.
- Tap the menu icon , you can manage the applications.
- You can go back or forward one level in the interface by tapping on the **Back** icon  or **Next** icon .
- You can go back one level in the directory by tapping on the LevelUp button .
- Wherever you are in the interface, you can go back directly to the Home screen by tapping on the Return icon  or Home icon .
- Tap the Home icon  to go to the root directory.



Copy/Move Files and Folders

- (1) Navigate through the file/folder and locate the file/folder you want.
- (2) Tap the Multi icon  and then tap the file(s) /folder(s) that you want. You can select multiple items by tapping. To deselect the item(s), tap the Cancel icon .
- (3) Select “Copy” or “Move” from the pop-up menu.
- (4) Navigate to the location where you wish to copy or move the file/folder to.
- (5) Select the Edit icon  from the toolbar and then choose “Paste.”

Delete Files and Folders

- (1) Navigate through the file/folder and locate the file/folder you want.
- (2) Tap the Multi icon  and then tap the file(s) /folder(s) that you want. You can select multiple items by tapping. To deselect the item(s), tap the Cancel icon .
- (3) Select “Delete” from the pop-up menu and then select “Delete” to confirm.

Compress Files/Folder with Zip

- (1) Navigate through the file/folder and locate the file/folder you want.
- (2) Tap the Multi icon  and then tap the file(s) /folder(s) that you want. You can select multiple items by tapping. To deselect the item(s), tap the Cancel icon .
- (3) Select “Zip” from the pop-up menu.
- (4) Enter a name for the zip file and then tap “Create”.

File Options

You can hold your finger on a file or folder to display the options (as shown on the right).



Sending/Receiving E-mails

This device has an E-mail application pre-installed. You can send or receive e-mails from the Internet at any time with this device. Make sure you have an Internet connection before using the email service.

In the Home Screen, tap the Applications shortcut to display all applications and then tap the Email icon to launch the e-mail application.

Setup Email Account

First you need to setup an E-mail account for receiving or sending emails.

- (1) Start up the email application by tapping the **Email** application icon and you are prompted to setup an account.
- (2) Input your email address and login password. You can set the account as default by selecting the option "Send email from this account by default".
- (3) Tap "Manual Setup" to set the email server information.
- (4) Choose the server type from POP3, IMAP or Exchange for incoming emails. To know what type of your email server is, you can consult the service provider, network administrator or search for information in the Internet.
- (5) Input required information (server, port etc.). You can obtain the information from the service provider, network administrator or the Internet.
- (6) Choose the server type for outgoing emails, and input required server information.
- (7) Click "Next" to continue. Your tablet will check the server settings. When it prompts you that "Your account is set up, and email is on its way", your account is set up successfully.
- (8) Input your name and then tap on "Done" to finish.



Note: If you have more than one account, every time when you start up the email application, you enter the default email account.

Manage Accounts

You can setup more than one account and manage these accounts by checking information about the account, adding another account or deleting an account.

Add another Account

Following these steps to add another account if you want.

- (1) Launch the email application and then tap on the Menu icon  to display the menu item. Choose "Accounts" to display accounts.
- (2) Tap on the Menu icon  to display the menu item, and then choose "Add account".
- (3) Follow the steps of setting up a Email Account to add an account.

Delete an Email Account

- (1) When you are in the email box, tap on the Menu icon  to display the menu items.
- (2) Tap on "Accounts" to display all email accounts.
- (3) Hold your tap on the account that you want to delete until a menu pop up.
- (4) Tap on "Remove Account" , and then tap on "OK" to confirm.

Check the Account Setting

- (1) When you are in the email box, tap on the Menu icon  to display the menu items.
- (2) Tap on "Accounts" to display all email accounts.
- (3) Hold your tap on the account that you want to check until a menu pop up.

- (4) Tap “Account settings” , and then you should see all setting information about the account. You can edit these settings as you want.

View Emails

You should enter your mailbox when you start up the email application.

- In the mailbox, you can slide your finger up and down to scroll through the email list.
- Tap on an email to open it.
- Holding your tap on the email can display a menu. With the menu, you can open, reply, forward or delete the email.

Other Applications

Some useful small apps have been preinstalled in this device, such as Calculator, Calendar, Sound Recorder, Office Suite etc.. They are easy to use, thus no detailed instructions are necessary for these apps. Please always follow the actual operation of your device.

Managing Apps

You can manage your applications of the device easily.

There are number of useful apps pre-installed in the device as it is produced at the factory, and you can copy some from other resources, download or purchase them from the Internet.

Install Applications

You can install applications following these steps:

- (1) Open the FileBrowser application, then find the app you want to install.
- (2) Tap the app to start installing. However, for the sake of security, the device may prompt you that there is possibility of attack risk if you install and run some apps whose sources are not guaranteed. In this case, you shall turn to the Settings menu and select Security to check the “Unknown sources” before you go on with the installation.
- (3) Once the installation is completed, you can find the icon of the app in the Apps screen. It is ready for running.

Uninstall Applications

- (1) Tap the Settings shortcut in the Home Screen to display setting menus.
- (2) Select “Apps”.
- (3) Tap on the application that you want to uninstall.
- (4) Tap on “Uninstall” to uninstall the application.
- (5) You can simply tap and hold on an app icon to jump to the Home Screen, then drag it to the dustbin icon to uninstall it.

Note:

1. You cannot uninstall the pre-installed applications, but you can deactivate or stop them.
 2. Make sure all apps you have copied or downloaded to your device are in the .apk format.
-

Managing Tasks

Your device can handle multiple tasks at the same time. For example, you can view photos while listening to music. Multitasking is helpful but inefficient if too many tasks are running. In order to save system memory and enhance system performance, you can end some tasks that you don't use at the moment.

- (1) Tap  to display applications that you used recently.
- (2) Hold your tap on the application that you want to stop, and then select "Remove from list".
- (3) You can also run the application Advanced Task Killer to manage your tasks(running apps).

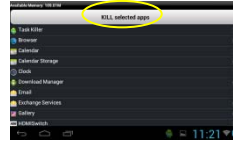

Troubleshooting

Reset this device

- In the event that the device freezes, you can reset the device by pressing and holding the **Power** button for about 10 seconds.

Specifications

Item	Description
CPU	Based on AML8726-MX Cortex A9; Main CPU frequency: 1.5 GHz
DDR3	1G B
Operating System	Android OS 4.0.4 .
Hardware	IBM PC or compatible PC, Note-book or Macintosh with USB port
Internal Memory	4GB, 8GB, 16GB (optional)
Memory Card type	SD card: 2GB, 4GB (SDHC), 8GB, 16GB, 32GB(SDHC)
Operation System	Windows2000/XP/Vista/windows 7/Linux2.4/ MAC OS 10.6.7 above
Interface	USB2.0 High speed
	SD (compatible SDHC)
	3.5mm Earphone
Connection Agreement	WiFi (802.11 b/g/n)
Front Webcam	0.3 Mega Pixels
G-sensor	Support 360 degrees rotation
E-Book Reader	Support
Photo Format	JPEG(Baseline) : 2Mpels (Max)
	BMP / GIF (Static) / PNG
Audio Format	MP3/WAV/OGG/FLAC/APE/AAC/WMA
Video Format	AVI/3GP/ MP4/RM/RMVB/FLV/MKV/MOV/MOV/MPG/VOB/DAT/WMV/ASF
Battery Life	About 6 hours of music playback; About 5 hours of video playback; About 4.5 hours of web browsing.
Display	7.0-inch TFT LCD, Touchpad (capacitive touch pad), 1024X600 pixels.
SNR	>=80dB
Frequency Response Range	20Hz—20KHz
Power Supply	Rechargeable lithium-ion polymer battery; AC Adapter: AC Input 100-240V~50/60Hz, DC Output 5V/2A
Storage Temp.	-20℃ ~ +65℃
Ambient Temp.	0℃ ~ +40℃
Operation Relative Humidity	20% ~ 90% (40℃)
Storage Relative Humidity	20% ~ 93% (40℃)

FCC Warning:

- This device complies with Part 15 of the FCC Rules. Operation is subject to the following two conditions:
 - (1) this device may not cause harmful interference, and
 - (2) this device must accept any interference received, including interference that may cause undesired operation.
- Changes or modifications not expressly approved by the party responsible for compliance could void the user's authority to operate the equipment.
- NOTE: This equipment has been tested and found to comply with the limits for a Class B digital device, pursuant to Part 15 of the FCC Rules. These limits are designed to provide reasonable protection against harmful interference in a residential installation. This equipment generates, uses and can radiate radio frequency energy and, if not installed and used in accordance with the instructions, may cause harmful interference to radio communications. However, there is no guarantee that interference will not occur in a particular installation. If this equipment does cause harmful interference to radio or television reception, which can be determined by turning the equipment off and on, the user is encouraged to try to correct the interference by one or more of the following measures:
 - -- Reorient or relocate the receiving antenna.
 - -- Increase the separation between the equipment and receiver.
 - -- Connect the equipment into an outlet on a circuit different from that to which the receiver is connected.
 - -- Consult the dealer or an experienced radio/TV technician for help.

FCC RF warning statement: The device has been evaluated to meet general RF exposure requirement. The device can be used in portable exposure condition without restriction.