

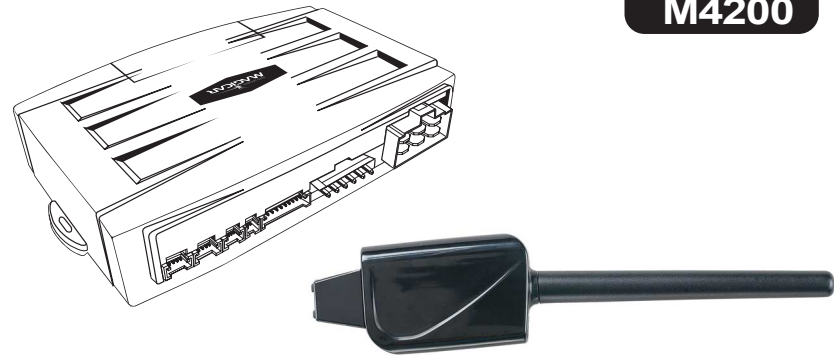

Installation Guide

M4200 Controllers

M4200



www.magicar.com



FCC ID : O44JMA580

This device complies with Part 15 of the FCC Rules.

Operation is subject to the following two conditions :

- (1) This device may not cause harmful interference, and
- (2) This device must accept any interference received, including interference that may cause undesired operation.

Caution : Changes or modifications not expressly approved by the party responsible for compliance could void the user's authority to operate this device.

IC : 3767B-MA580

Statement : The term "IC:" before the radio certification number only signifies that Industry Canada technical specifications were met.

Caution : The User that modifications to the unit may void the user's authority to operate the unit.

Installation GUIDE

M4200

By Youngshin Electronics Co., Ltd.

YOUNGSHIN
Electronics Co., Ltd.

Safety Information

Please take these safety precautions into consideration under the following conditions:

1. Servicing the vehicle

When servicing your automobile (i.e. changing the oil, washing your car), the Young Shin Electronics, Inc system should be in Valet Mode. There is a safety shutdown switch under the hood that deactivates the remote starter function if the hood is open. However, if the switch has been damaged or the switch has been installed improperly, the vehicle may start when Button II is pressed for 2 seconds, even if the hood is open.

2. Loaning your vehicle to others

Whenever you loan your vehicle to an individual who is not familiar with Young Shin Electronics, Inc, you may want to put the vehicle in Valet mode. This will prevent the borrower from accidentally activating the Young Shin Electronics, Inc auto-security system.

3. For manual transmission vehicles

If the Young Shin Electronics, Inc 2WAMR is installed in a manual transmission vehicle, extra precautions are required because the Young Shin Electronics, Inc does not monitor the gear shift :

Important!

Under normal circumstances, Reservation Mode is cancelled when a door or hatchback opens. Please verify that the opening of any door or hatchback cancels Reservation Mode. If any of the doors or hatchback are not monitored by Young Shin Electronics, Inc because of improper installation or a faulty dome light switch, do not use the Young Shin Electronics, Inc and take your vehicle immediately to the dealer for repair. Do not set Reservation Mode if the window(s) are open or if there is anyone inside the vehicle, this includes animals. Remote start installation in a manual transmission vehicle with a convertible top is not recommended.

Remote-Pager : 2WAMR w/LCD

The model name, 2WAMR stands for Two Way Amplitude Modulated Remote with Liquid Crystal Display.

This transmitter allows you to activate multiple functions by pressing different combinations of the 4 buttons on the unit.

Description of Remote Appearance

The model name, 2WAMR, stands for 2 Way 4 Button Remote.

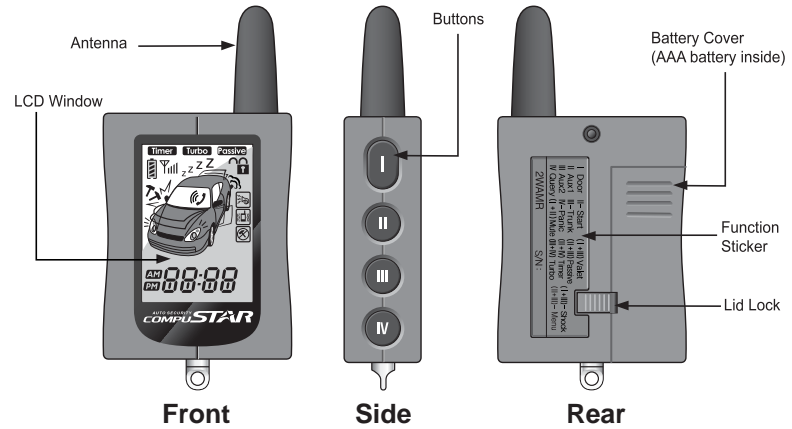



















GLO color LCD

The remote-pager comes with GLO which is a unique color LCD display that visually tells the vehicle owner the security status of your car at all times. There are differing icons that will appear on your GLO LCD indicating what your vehicle is currently doing.



LCD Icons

Icon	Explanation
	Indicates if Timer Mode is on or off.
	Indicates if Turbo Start Mode is on or off.
	Indicates if Passive Arming Mode is on or off.
	Displays remaining battery life.
	Indicates that your remote-pager is transmitting signals to the controller unit.
	Indicates if you are in Valet Mode.
	Display if your car is lock or unlock
	Indicates that the Shock Sensor has been triggered.
	Displays if your Trunk is open.
	Indicates if RPS is on or off.
	Indicates that someone is paging you from your vehicle.
	Displays if your vehicle has auto-started properly or ignition on.
	Displays if your door is open.
	Indicates that your car siren is turned on or off when you lock or unlock the vehicle.
	Indicates if Vibrator is on or off.
	Indicates that Shock sensor is turned on or off.
	Displays if your Hood is open.
	1. Time Clock. 2. Remainder of the engine running time.
	Indicates if your car parking lights are flashing.

Remote-Pager Button Functions

	Button	PressedFor	Function
1	I, I-	1/2 sec	Alarm Mode - on/off, RPS - on/off, Siren Off, Starter Kill (Anti-Grind) - on/off
2	II	1/2 sec	AUX 1
3	III	1/2 sec	AUX 2
4	IV	1/2 sec	Query Function
5	II-	2 sec	Auto-start Function – on/off
6	III-	2 sec	Trunk Release
7	IV-	2 sec	Panic, Press I to shut off Siren.
8	(I+II)	1/2 sec	Siren Chirps – on/off
9	(I+III)	1/2 sec	Valet Mode – on/off
10	(II+III)	1/2 sec	Passive Arming – on/off
11	(II+IV)	1/2 sec	Timer Start Mode – on/off
12	(III+IV)	1/2 sec	Turbo Mode - on/off
13	(I+III)-	2 sec	Shock Sensor – on/off
14	(I+II)-	2 sec	Programming Menu 1 - Installer Only
15	(I+IV)-	2 sec	Programming Menu 2 - Installer Only

Note : " —" Represents pressing the button for 2 seconds.

"()" Represents simultaneously pressing the buttons.

"() —" Represents simultaneously pressing the buttons for 2 seconds.

Wiring Diagram

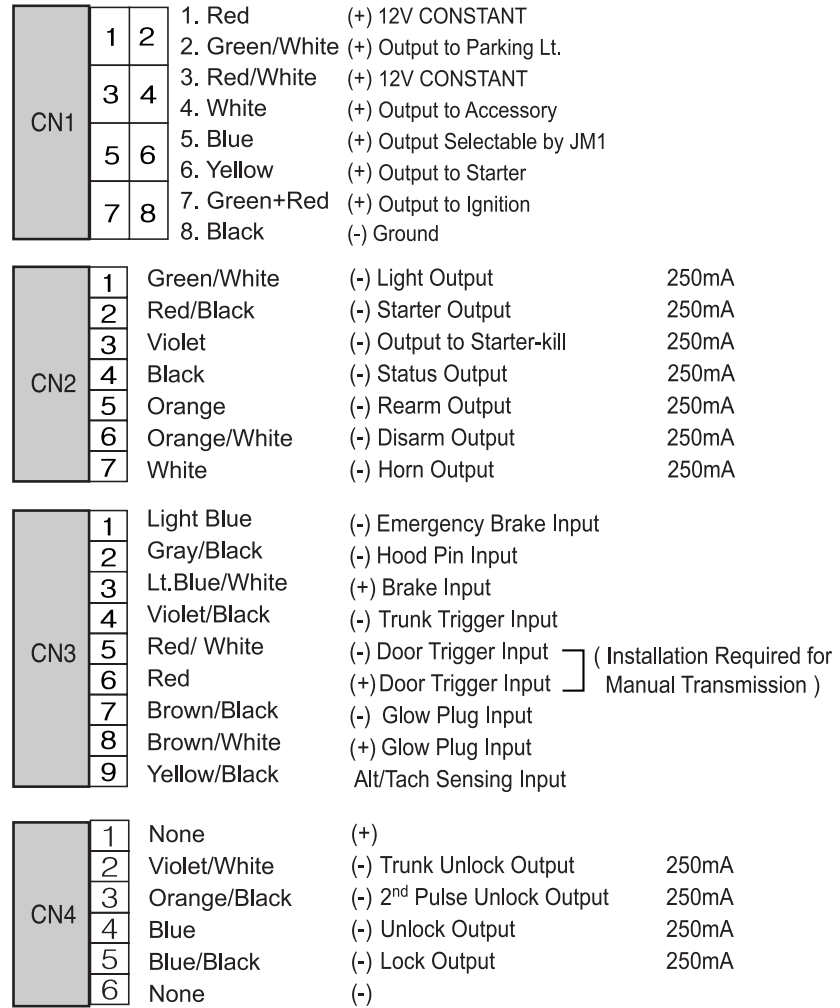
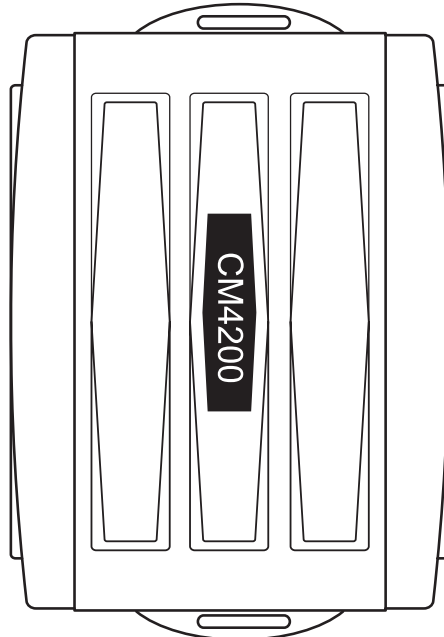
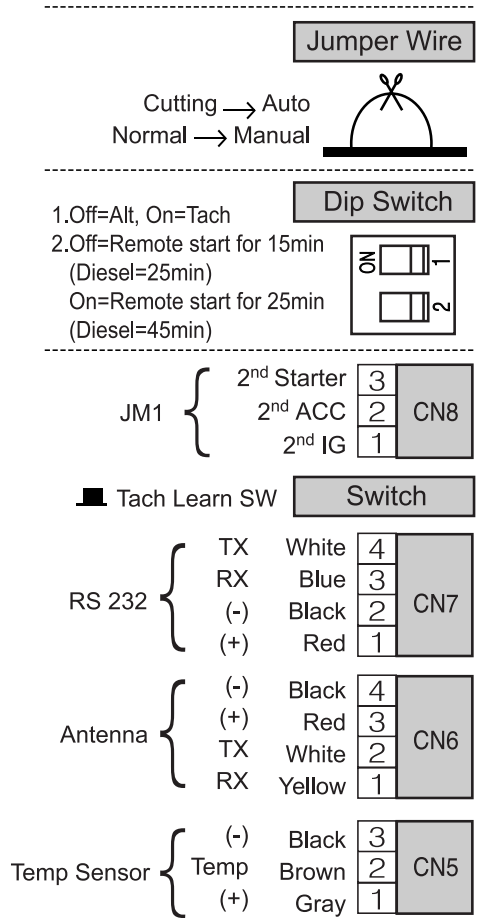

Notes for Wire Connection

■ Connector #1

- Pin #1 :** **Red** This wire is used as the **(+)Constant Power** input for the unit. This wire must be connected for the unit to function correctly.
- Pin #2 :** **Green/ White** This wire is the **(+)Positive Parking** light output. Connect this wire directly to the (+) trigger wire generally off the parking light switch or found at or behind the fuse box.
- Pin #3 :** **Red/ White** This wire is used as the **(+)Constant Power** input for Starter and 2nd Ignition.
- Pin #4 :** **White** This wire is used to power the **(+)Accessory**, which activates the blower motor for the heater or A/C.
- Pin #5 :** **Blue** This wire will power (+)2nd Starter, (+) 2nd Accessory or (+) 2nd Ignition depending on the jumper selection at JM1.
- Pin #6 :** **Yellow** This wire is the **(+) Starter Output**.
- Pin #7:** **Green/ Red** This wire is used to power the **(+) Ignition**. This wire is also an input for the CompuStar used to monitor the status of the vehicle and for programming.
- Pin #8 :** **Black** This wire needs to be connected to a chassis **(-)Ground**. It is very important to make sure you have a good ground or the unit will not function correctly.

■ Connector #2

- Pin #1 :** **Green/ White** This is the low voltage **(-) Parking light output 200mA**. Some newer vehicles require a (-) parking light output instead of the standard (+) output (reference connector #1) such as the new Jeeps and even some Fords.

- Pin #2 :** **Red/ Black** This wire is a **(-) 2nd Starter 200mA output**. Normally the only vehicle this would be used on Nissan's and older Ford's. You may connect this wire to the purple pigtail of the additional relay on CN #1. This will result in a (+) trigger output for the 2nd starter on the blue wire of the same relay.
- Pin #3 :** **Violet** This wire is the **(-) Negative when armed out**. It will provide a (-) output anytime the unit is armed or remote started. This wire is pre-wired into the starter-kill. This wire could be used for adding a window roll-up.
- Pin #4 :** **Black** This is the **(-)Status Out wire (Ground when running)**. It provides you with a (-) 200mA output as soon as the remote start is activated.

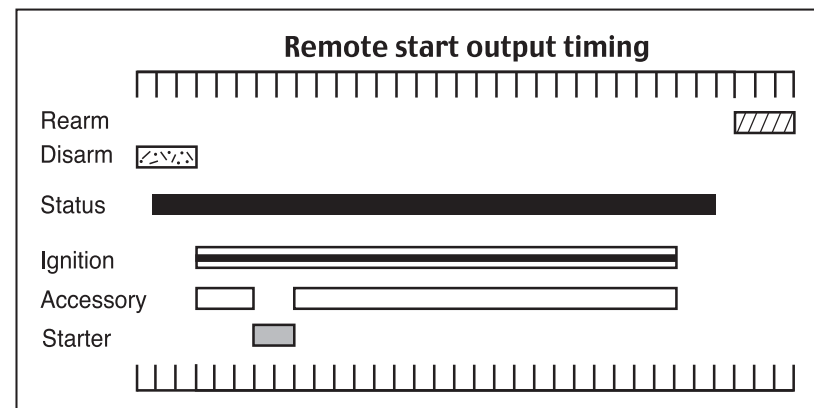

This is the wire you would connect to a Transponder Module or maybe a VATS module.

- Pin #5 :** **Orange** This is the Rearm wire. It provides you with a (-) pulse when armed, after remote start, and then again one second after remote start shuts down. As of August 2004, this wire's output duration has been increased by 1.0 second. This has been done to provide the Dome Light Factory Rearm feature currently offered in the CM3000 controller module. Some vehicles require the door to be open while the door is locked for the factory security system to arm. Connecting this wire to the dome light circuit

(generally you will have to change the polarity with a relay) will simulate the door opening 0.5 seconds before the lock pulse, and will keep the simulated door open until 0.5 seconds after the lock pulse has ended.

Pin #6 : **Orange/White** This is the Disarm wire. It provides you with a (-) pulse when disarmed and before remote start.

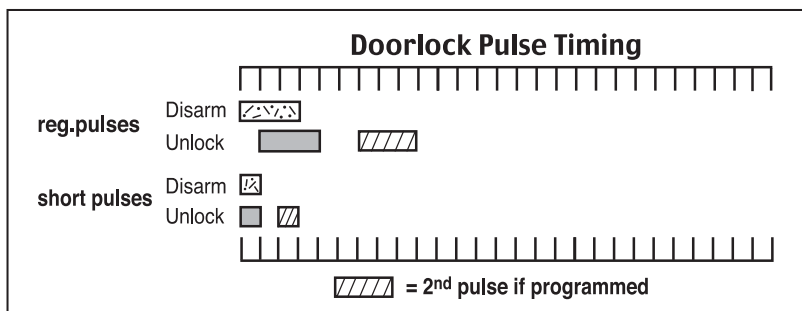

Pin #7 : **White** This is the (-) 250mA horn honk output wire.

■ Connector #3

Pin #1 : **Light Blue** This needs to be connected to the **parking brake**. This wire requires a (-) input to activate. This wire serves two functions:

1. To engage Reservation Mode for manual transmissions, reference the users or install guide.
2. To activate the Turbo Timer, reference the users or install guide.

Pin #2 : **Gray/ Black** This is the (-) **shutdown for the Hood Trigger**. This wire serves two functions:

1. It prevents the remote start from activating while the hood is open
2. It will trigger a full alarm if the hood is opened when the alarm has been armed.

Pin #3 : **Light Blue/ White** This is the (+) **shutdown for the foot brake**. This wire will shut down the remote start if the foot brake is pressed.

Pin #4 : **Violet/ Black** This wire is the (-) **trigger input**, which may be connected to a **trunk pin or trunk trigger as a buyer option**.

Pin #5 : **Red/White** This wire is the (-) **trigger input for the door trigger**. You would connect this to the trigger that shows (-) when the door is opened.

Pin #6 : **Red** This wire is the (+) **input for the door trigger**. You would connect this to the trigger that shows (+) when the door is opened.

Pin #7 : **Brown /Black** This is the trigger input for a (-) **glow plug wire**.

Pin #8 : **Brown /White** This is the trigger input for a (+) glow plug wire.

Pin #9 : **Yellow/ Black** This wire serves as the Tachometer input or the Alternator input. Either way you use it, it is for engine sensing. This wire tells the CompuStar when to quit cranking the starter of the vehicle. There are a couple of ways to find the correct voltage for either type of sensing. Please review the following tips on the next page.

Tachometer Sensing

1. You will need an Auto Ranging Digital Meter to test for the correct tach.
2. Most tach wires are located at the (-) side of the ignition coil. In some cases you may have to go to the ECU or Coil pack.
3. The Voltage will read (AC), so you will need to set you meter accordingly.
4. With the vehicle off the voltage should read 0.00 AC.
5. Start the vehicle and at this time the voltage should fluctuate between 1 and 8 volts AC.
6. Connect the tachometer wire to the yellow/black.
7. Make sure that the Dipswitch #1 is set to the On position.
8. While the vehicle is running press the small black button on the side of the brain, Parking Light will flash once if you have the correct Tach wire.
9. If the cars parking lights flash 3 times, there is a problem with the tachometer learning. Wait for 2 seconds and the cause for the error will be indicated by the number of times the parking lights flash.
10. Diagnosing Tach Learning Error

If the cars parking lights flash 3 times, there is a problem with the tachometer learning. Wait for 2 seconds and the cause for the error will be indicated by the number of times the parking lights flash.

Error Number (# of times parking lights flash)	Tach Learning Error Diagnosis
1	Dip Switch #1 is on alternator sensing.
2	Manual Car Key is in the off position.
3	No signal or the signal is not fast enough. find a different wire.

Alternator Sensing

1. Just like with Tachometer sensing you will need a Auto Ranging Digital Meter to test for the correct wire.
2. Set your meter to DC voltage for this type of sensing, compared to AC voltage for the Tach sensing.
3. To find this wire you will need to locate the alternator. Look for the Stator wire, Which is always located somewhere on the alternator. It will usually be a smaller gauge wire and generally by itself.
4. With the vehicle in the OFF position the voltage should read 0.00
5. Turn the key to Ignition and the voltage should read anywhere from 1 to 6 volts DC.
6. Next, start the vehicle. The voltage should now read between 9 to 14 volts DC.
7. If this is the case you have found the Alternator wire, connect this to the Yellow/Black on CN 3
8. Set dipswitch #1 to the OFF position. Please note, you will not need to press the small black button on the side of the brain, it is automatic.

■ Connector #4

Pin #1 : No Connection

Pin #2 : **Violet/ White** This wire is the (-) 200mA trunk release.

The following sequence takes place each time the trunk release output is triggered :

1. CompuStar disarms alarm and unlocks doors
2. Trunk output is triggered

Pin #3 : **Orange/Black** This wire provides you with the capability of adding **driver's door priority unlock** similar to factory keyless entry systems.

Please note that this feature requires more advanced installation. Please call Technical Support for details.

Pin #4 : **Blue** This wire is a (-) 200mA Unlock Output.

Pin #5 : **Blue/Black** This wire is a (-) 200mA Lock Output.

Pin #6 : No Connection

■ Connector #5

This is the plug in for temperature sensor input. This sensor will monitor the internal temperature of the vehicle and be programmable for timed engine starts.

■ Connector #6

This is the plug for the antenna cable.

■ Connector #7

This is the data lines to interface Telematic Devices or Interface Modules.

Tach Learning Switch :

This is the small black button on the side of the brain used to program tach. Once you have found the correct wire simply press this button while the vehicle is running and the parking light will flash once to confirm that the tach is learned. If the parking light flash three times the tach source is not valid.

■ Jumper Selection-JM1

Pin #5 wire of CN1 will power the (+)2nd Starter, (+) 2nd Accessory or (+) 2nd Ignition depending on the jumper selection at JM1.

■ Dip Switches

Switch #1: This is used to set either Tach or Alternator mode. If the switch is set to the ON position the unit is set to Tach. If the switch is set to the OFF position then the unit is set for Alternator sensing.

Switch #2 : This is used for setting run time. If the switch is set to the OFF position then the run time is set for 15 min for gas engines or 25 min for diesel engines. If set to the ON position then the run time is set to 25 min for gas engines or 45 min for diesel engines.

Jumper Wire : This jumper is connected when you receive the brain.

While the jumper is connected the module is set for manual transmission mode. When installing on automatic transmissions the jumper must be cut. Please note : if a unit with a cut jumper is installed on a manual transmission **the warranty will be void and Firstech will have no liability.**

Switch and Jumper Setting

Dip Switch	Jumper Wire	#1	#2
On	Uncut: Manual Transmission	Tach Sensing	25 min run time (45 min diesel)
Off	Cut: Automatic Transmission	Alternator Sensing	15 min run time (25 min diesel)

Important! Once you cut the jumper wire, you are not allowed to reconnect it. Reconnection will completely void the warranty. A trace of reconnection of this wire will prevent you from making any claim whatsoever pertaining to the manual transmission mode.

Installation of Antennas

The antennas have been calibrated for horizontal installation at the left-top corner of the windshield. Different installation may adversely affect the transmitting distance.

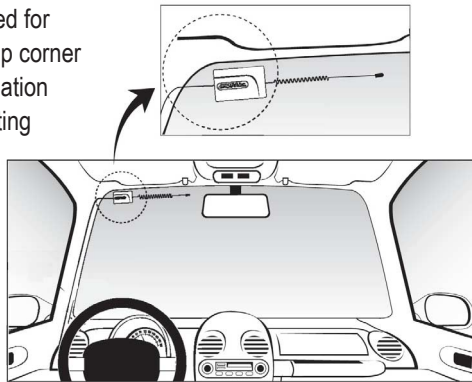

Option Programming for Four Button Remotes for FM or SS Units

Step1: For Programming menu 1: Press Buttons (I+II) for 2 seconds.
For Programming menu 2: Press Buttons (I+IV) for 2 seconds.
The car will chirp once indicating that you are in programming mode.

Step2: Within a 2 seconds after pressing (I+II) or (I+IV), press Button IV the number of times to go to the option number you want to change.
You have to hear a chirp and see the parking light flash each time when you press Button IV .

Step3 : Wait a few seconds. You will hear a number of chirps and see a number of parking light flashes corresponding to the option number you want to change. If the number of chirps or flashes is not what you want, go back to Step 1.

Step4 : Press Button I for the default factory settings and your car will respond by one chirp and one flash. Press Button II for the optional setting and your car will respond by two chirps and two parking flashes.

If you see an extended flash of the lights, you are going out of programming mode, please go back to Step 1.

If you want to change more options, go back to Step 1.

Resetting any Option Setting to the Factory Setting

Step1 : Press Buttons (I+II) simultaneously or Buttons (I+IV) simultaneously for 2 seconds. A one flash of the parking lights confirms step 1.

Step2: Press Button III three times. This is confirmed by a parking light flash each time you press Button III . A few second later, your cars parking lights will flash three times rapidly. Your car is now set to all of the original factory default settings.

Installation of AM Antennas

The antennas have been calibrated for horizontal installation at the left-top corner of the windshield. Different installation may adversely affect the transmitting distance.

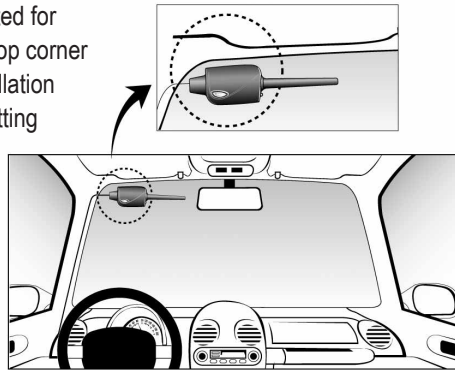

Option Programming with Programming Button for AM Units

Most of the original programming (“**Factory Setting**”) from the factory can be changed to alternative programming (“**Option Setting**”) by Programming Switch (hereinafter called “PS”).



Changing Factory Setting to Option Setting. #1

Step1: Turn the key to On position. (Engine Off)

Step2: Press PS (Programming Switch) for two seconds until Parking Light flashes once for **Option #1-1 to #1-11**, then release the switch.
Or, press PS for four seconds until Parking Light flashes twice for **Option #2-1 to 2-10**, then release the switch.

Step3: Within 4 seconds after you released the switch, press and release PS for the number of times of the option number you want to change.

Step4: Within 2 seconds, the LED and Parking Lights will flash the same number of times as you pressed the switch at step 3.

Note : If the number of flash does not correspond to what you did at Step 3,
1) wait for 4 seconds until Parking Light flash once for 1 second to reset. If this happens, go to Step 2, or
2) turn the key off and go to the Step1.

Step5: Within 4 seconds from step 4, press PS once for factory setting, the LED and Parking Lights will flash once to confirm. Press PS twice for optional setting, the LED and Parking Lights will flash twice to confirm.

Step6: If you want to change more options, go to Step 3. However, if you want to change options from **Option#1-1 to #1-11** to **Option#2-1 to #2-10** or vice versa,
1) wait for 4 seconds until Parking Light flash once for 1 second to reset. Then go to the Step 2, or
2) turn the key off and go to the Step 1.

Resetting any Option Setting to the Factory Setting

If you want to reset any changes you made to the Factory Setting,

Step1: Turn the key to On position. (Engine Off)

Step2: Press PS (Programming Switch) for two seconds until Parking Light flashes once for **Option#1-1 to #1-11**, then release the switch.
Or, press PS for four seconds until Parking Light flashes twice for **Option#2-1 to #2-10**, then release the switch.

Step3: Within 4 seconds after you released the switch, press and release PS for 3 seconds.

Step4: Within 2 seconds, the LED and Parking Lights will flash three times to confirm the above step.
If any of the above steps is not followed correctly, the Parking Lights will flash once for 1 second to reset.
If that happens, please start from Step 2.

Option Programming for Six Button Remotes

The procedures will be same as the 4 button remotes except the use of the different buttons.

Programming	6 Button Remote	4 Button Remote	ICON
Programming Menu 1	(Trunk+Start)-	(I+II)-	(+) -
Programming Menu 2	(Trunk+Stop)-	(I+IV)-	(+ +) -
Option Selection	(Stop)-	(IV)	(+) -
Factory Setting	Lock	(I)	
Option Selection	Unlock	(II)	
Default Setting Selection	(Start)-	(III)	-

Programming Menu Options

Programming Menu #1 (Auto-Start and Door Lock Options)

	Feature	Factory Default	Optional
1-1	Unlock Before, Lock After Starting, Lock after remote start	OFF	ON
1-2	Door Lock / Unlock Pulse Duration	0.8 sec	2.5 sec
1-3	Min. Crank Time for the Alternator Sensing	0.8 sec	1.0 sec
1-4	Driver's Priority Unlock	OFF	ON
1-5	Double Pulse Unlock	OFF	ON
1-6	N/A		
1-7	Turbo	OFF	ON
1-8	Diesel Time	Glow Plug Wire	18 sec
1-9	Short Pluse Lock/ Unlock	OFF	0.125 sec
1-10	Start-Kill Relay	Anti-Grinding Only	Anti-Grinding + Passive starter- kill
1-11	Manual Transmission Lock	Lock Upon Reservation	Active Lock Upon Reservation

Note :

1-1 Some vehicles such as Mercedes-Benz and the Lexus ES300 require you to unlock the car to disarm the factory alarm before remote starting the vehicle. Activating this feature will unlock the vehicle for a brief second in order to disarm the factory alarm before auto-starting the vehicle remotely then lock after starting.

1-4 This feature unlocks the driver's side door lock with the first unlock pulse. A second unlock pulse is need to unlock the rest of the car doors.

Important! In order for this feature to operate, the installer must use the 2nd Unlock Wire (Or/Bk wire of Connector 4). Isolate the driver's door actuator from the rest of the other doors. Call us for the technical support if you are not sure about this.

1-7 Turbo mode requires the connection of the emergency brake wire for either automatic or manual transmission vehicles. With this mode, the engine will continue running for two minutes after the key is turned off if the emergency brake was set before the key was turned off and the foot brake was not being pressed when the key was turned off.

1-8 Use this feature if you do not use the glow plug wire. "With the Option Programmer, you can program between 3-99 seconds."

1-9 This option will not be available if you chose 2.5 sec pulse under 1-2.

1-10 Passive Kill

The factory setting for the starter-kill relay is Anti-Grinding only.

With this optional setting, you can add Passive Starter-kill function, that will be activated,

- 1) Whenever doors are locked by the remote, or
 - 2) One minute after the ignition is off, or
 - 3) 30 seconds after the last door is closed if the door trigger is installed and the user's option for Passive Locking (Button (+) for a half second) is turned on. See Passive Locking of the User's Manual.
- You can deactivate the starter-kill with the Lock/Unlock button.

1-11 This is only of the manual transmission vehicle. With this option, you have to actively lock the vehicle after the manual transmission reservation.

Programming Menu #2

	Feature	Factory Default	Optional
2-1	Cold Start with Temp Sensor	OFF	ON
2-2	Timer Start or Minimum Interval between Cold Starts	3 Hr	1.5Hr
2-3	N/A		
2-4	N/A		
2-5	Ignition Controlled Door Lock	OFF	ON
2-6	N/A		
2-7	N/A		
2-8	N/A		
2-9	N/A		
2-10	N/A		

Note :

- 2-1** Cold start mode requires installation of the optional temperature sensor.
In the default factory setting, Cold Sensor input works as Remote StartActivation Input. A Ground pulse to this wire will start the vehicle
- 2-5** This programmable option enables your vehicle to automatically lock the doors when the brake pedal is pressed after starting the vehicle with a key. In addition, the vehicle will automatically unlock the doors upon pulling the key out from the ignition.
However, if the emergency brake wire was installed, the vehicle will unlock upon the emergency brake is set if the engine is still running with the key. The option must be chosen at the time of installation.

Diagnosing Problems with Auto-Start

If there is a problem in auto-starting your car, you will see three flashes of the parking lights when you attempt to auto-start the car. Wait for 2 seconds and the cause for the error, will be indicated by the number of times the parking lights flash.

Error Number (# of times parking lights flash)	Error Reason
1	Engine On
2	Key On
3	Door Open
4	Trunk Open
5	Brake On
6	Hood Open
7	Reservation Off (Manual Transmission Only)