



Internet Tablet QD09

User's Manual



Read this manual before installation and use.

Important Safety Instructions and Notices

We would like you to have a safe and enjoyable experience. Please read the following instructions and notices before using the tablet.

- Avoid using the tablet in extremely hot, cold, dusty, damp or wet environments.
- The tablet is not moisture/water-resistant. Avoid using the tablet around sources of water.
- Avoid dropping or forcibly placing the tablet onto a hard surface. This may damage the screen or internal electronic components.
- Do not use alcohol, thinner or benzene to clean the surface of the tablet. Use only cleaning products designed for computer tablet devices
- Do not use the tablet while walking or driving.
- Excessive use of earphones at high volume may lead to hearing impairment. Limit earphone usage, and adjust the volume to a moderate level when doing so.
- The images in this manual may vary slightly from the actual product.
- Charge the tablet battery under any the following circumstances:
 1. The battery level icon indicates low power, by showing a drained, red battery icon.
 2. The tablet powers-off automatically, and continues to do even after restarting.
 3. On-screen keys do not work.
- Do not suddenly disconnect the tablet when formatting, uploading or downloading data. This can lead to program errors (e.g., system or screen “freezing”.)
- Static discharge in the cable, while it is connected to a computer, may corrupt files or damage the memory of the tablet.
- Dismantling the tablet will void the manufacturer’s warranty. If experiencing problems, review the Troubleshooting section of this manual.
- The tablet functions, hardware, software, and warranty information may be improved or modified by the manufacturer or their respective owners, and is subject to change without notice.

Features

- 9"1024X600 Capacitive touch-screen, with multi-point touch function.
- Wi-Fi and Bluetooth connection capability .
- Play all formats of music, video and picture file, Supports resolution up to 1080P.
- TF card for data storage and transfer.
- Energy-saving brightness control and sleep functions.
- Supports multiple languages.
- USB 2.0 high-speed transfer.
- APK program installation using the AppInstaller.
- Supports firmware upgrades.
- G-Sensor function: Detects the environment, orientation and position of the tablet, to provide input for various applications.
- Camera: Front (facing user)0.3MP; Rear 2.0MP

What's in the Box

- The Nobis QD09 9"Tablet
- Keyboard
- AC Adapter
- User's Manual
- USB Cable

Important Safety Instructions and Notices

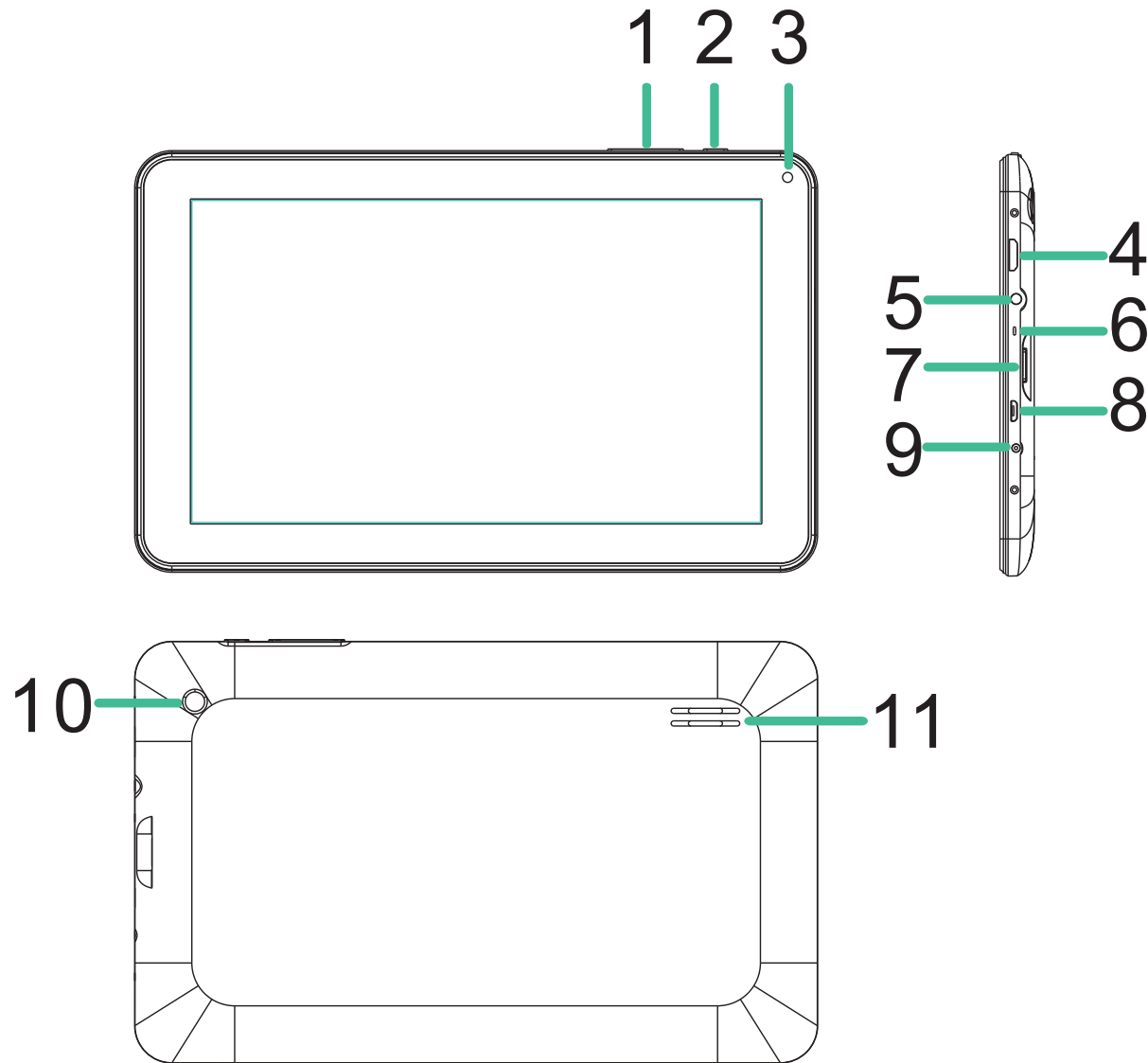

1	Volume-/+Key	Increases/Decreases audio volume in either speakers or earphones.
2	Power/Lock Key	Powers ON/OFF when held for about 3 seconds. Locks and unlocks the tablet in Stand-by Mode.
3	Camera	0.3MP camera on front of tablet (facing the user.)
4	HDMI	1080P HDMI Output.
5	Earphone Jack	use with a standard 3.5mm stereo headphone jack.
6	MIC Jack	Microphone
7	TF Card Slot	Slot for a TransFlash card (also referred to as a Micro SD card.)
8	Micro USB Port	Connect to a computer via mini USB cable to transfer data (i.e. music, video, photo, data files.)
9	Power Jack	Connects to an AC adapter.
10	Camera	2.0MP camera on rear of tablet.
11	Speaker	Speaker

Basic Operations

Powering ON/OFF

To power ON/OFF the tablet, press and hold the Power button for about 3 seconds. When turning the tablet ON, you will go to the initial Startup screen and have the option of unlocking it and going to the Home screen, or directly to the Camera app. When turning OFF the tablet, a window will open, verifying your action.

Stand-by Mode

if you do not want to power-off the tablet, you can opt to deactivate just the LCD screen. This will keep the tablet in Stand-by mode. To deactivate the screen, quickly press and release the Power button. The screen will go black. To reactivate, simply press and release the Power button again. (You may have to unlock the tablet in order to use it, depending on your security settings.)

Touching and Typing

The QD09 tablet screen is designed for you to touch it to move, select and manipulate information.

- To select an item on the screen, simply tap it

once with your fingertip or stylus. Some items may require you to "double-tap".

- To type into on text field(i.e.,when inputting your name, or a web address),tap the text field. The on-screen keyboard will appear, and allow you to type the information you wish to enter.

Other common finger gestures include:

- **Touch and Hold:** Touching and keeping your finger on an on-screen item, until a light glow appears around it, may activate a separate menu or other options for that item. This is often used for deleting an item from the tablet.

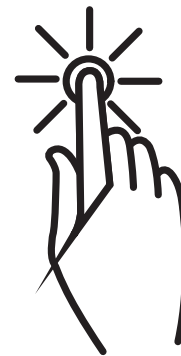

- **Drag:** To move an object, or activate functionality, Touch and Hold an item until it glows, then "drag"it to another location on the screen without lifting your finger or stylus.

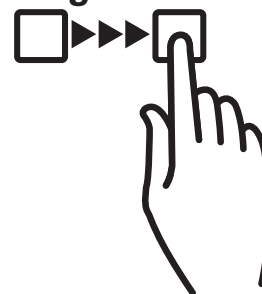

- **Swipe/Slide:** A motion often used to move through menus, pictures or multiple options. This is done with a light tap or flick of the finger/stylus into the direction you want the item, menu or screen to move toward.



- **Double-Tap:** Some items will require two taps in order to activate, zoom-in, zoom-out.

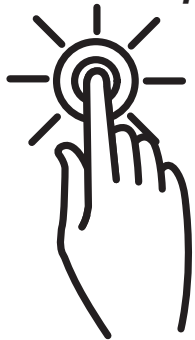

- **Pinch:** In some apps (such as Maps, Browser, and Gallery), you can zoom in and out by



placing two fingers on the screen at once, and pinching them together (to zoom out) or spreading them apart (to zoom in.)

Changing the screen orientation

First, make sure the “Auto-rotate screen” option is selected in the Settings menu (Settings > Accessibility). With this option selected, the screen will automatically rotate based on the vertical/horizontal orientation it is being held in. To “lock” an orientation, simply deselect the “Auto-rotate screen” option.

Resetting the Tablet

If the tablet is unresponsive to either touch input or function keys, use a paperclip or similarly-sized pin and press the Reset button located in the reset aperture. This reset will clear the memory and reboot the tablet. (It is not the same as a factory reset; your personal information, apps, settings etc. will be retained.)

Conserving Power

To conserve tablet battery power, set the brightness and sleep functions at reasonable levels. These functions can be found in the Settings menu (Settings > Display).

Basic Operations/The Home Screen at a Glance

Charging the Tablet

It is best to charge the tablet before the battery icon is fully drained, or when the tablet pop-up indicates that it needs charging. To charge the tablet, plugin the AC adapter to a convenient outlet, then plug-in the tablet to the AC adapter. If the tablet is on, the battery icon will pulse, showing that it is being charged. If is fully charged when an icon of a full battery is displayed on the screen.

A complete battery charge will take approximately 5 hours. It is normal for the tablet to be warm to the touch as it is being charged.

Connecting to a Computer for File Transfer

The included USB cable can be used to connect the tablet to any PC computer, for the purpose of transferring music, picture and other data files between the two units.

Power On the tablet

Upon pressing the Power button for about 3 seconds to start the tablet, there will be a series of screens, and then you will see this locked Start-up screen:

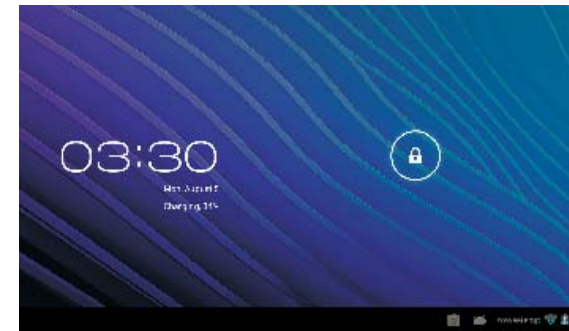

Press and hold your finger on the lock icon, and two options will appear. Drag it to the right, so that the circle clicks onto the unlock icon. The tablet will be unlocked, and will proceed to the Home screen. Drag it to the left to go directly to the Camera app. If you do nothing, the tablet will return to Standby mode.



The Home screen is the starting point for all of the features of the tablet are descriptions of each item on the home screen

1	Google Search	Opens to the Google Search page, which allows you to enter an internet search using the keyboard or voice control
2	Home Icon	Returns to the center/main Home screen.
3	Back Icon	Opens the previous screen visited, whether in an application or using the internet.
4	Recent Apps	Opens a list of apps (applications) recently used. Any application in the list can be selected simply by touching it, or removed by swiping it left or right. NOTE: If an application is not used after a certain length of time, it will begin to shrink, and eventually fade from this menu.
5	Volume Down	Reduced volume from music or other audio sources.
6	Volume Up	Increases volume from music or other audio sources.
7	Application Menu	Opens a list of all apps and widgets installed on the tablet. See "More on the Launcher Tab" below.
8	System Notifications	Opens a status window, which will give details in the state of the tablet, incoming messages, updates, Wi-Fi and Bluetooth connections and other tablet system related information
9	Status Icons	A quick-look at the status of the tablet, including network connections, battery life, volume and time. Tapping on the Status icons will give the System Notifications pop-up window.

Home screen may extend beyond the width of the central screen. It provides more space, so that Apps shortcut, widget, etc. can be displayed. Press a blank area of the home screen, swipe finger (left to right) to access other home screen. Add APPS shortcut, widgets and other features to the homescreens, and change the wallpaper.

The Home Screen at a Glance

More on the Launcher Tab



The Launcher Tab is a convenient way to access all of the applications (Apps). After tapping the icon, the screen will open to the Launcher Tab page. At the top, you will find options to see all Apps (applications) or widgets.

Apps

Tapping on any application icon in the Launcher screen will activate the application. If you would like to add the application to the Home screen, simply press and hold the app icon, and you

will return to the Home screen with the selected icon still under-finger. You can move the application to any available location on the main screen. Release the application icon to place it in the screen, add it to another application in a separate sub-window, or onto the top of the screen onto the text “App info”, where you will find detailed information on that application.

Widgets

Widgets are mini Apps that run on the Home screen. The tablet comes with several by default, including a calendar and a clock, and more can be downloaded.

Shop

This is the icon for the Google Play store, where you can purchase and download Apps and widgets will be able to use on the tablet.

Pre-Installed Applications

Some applications have been installed on the tablet to help get started. (It is recommended that a Google Gmail account, as many of these Apps use Google services.) These Apps may include;

For the Internet/Communication:

- Browser-For accessing the internet.
- Email-Quick access to the email account (if other than Gmail.)

Music, Video and Photos

- Video Player-Plays and manages video files.
- Music-Plays and manages music files.
- Gallery-Displays and manages photos and image files.
- Sound Recorder-Allows for the recording of sound using the internal microphone.
- Camera-Take photos using the 0.3 mega-pixel camera, and apply special effects.

Tablet and Application Management

- Explorer-Allows for the management and access of data files, including files such as music, video, and data (ie. PDFs)

- AppInstaller-Assists with the installation, management and download of applications on your tablet.
- Settings-Adjust wireless networks, screen and sound functions, and other aspects of the tablet.
- Play Store-Purchase and download Apps, music, movies and widgets from Google Play.
- Downloads-Manages all downloaded items, including Apps, widgets, ebooks, documents, etc.
- Drive-Connects to Google Drive account. Manages storage and sharing of files, images, etc.

Convenient Utilities:

- Calculator-A simple and convenient calculator.
- Calendar-A robust calendar app that allows for custom scheduling.
- Clock-A standard clock/alarm.

Pre-Installed Applications

Please note: Not all applications in the list may be available on the tablet. Double P-ower reserves the right to add, modify, or delete any application without prior notice.

BROWSER

Tapping on the Browser icon will give access to the internet. Here is the screen layout:

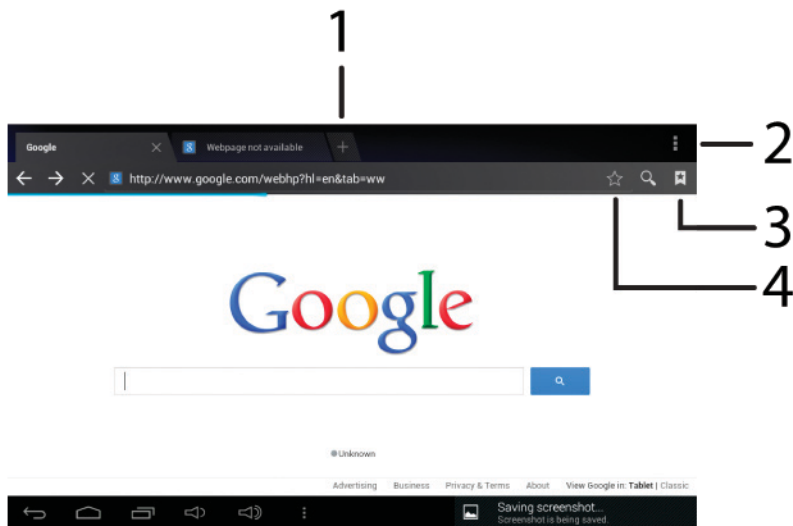

1	Touch to open a new window.
2	Touch to view/select more options for the window.
3	Opens the Bookmark/History/Saved Pages screen. Tap on any thumbnail to go to that website.
4	Touch to bookmark a web page. Page will be made available in the Bookmark/History/Saved Pages screen.

SETTINGS

Allows many adjustments of the functions of the tablet.

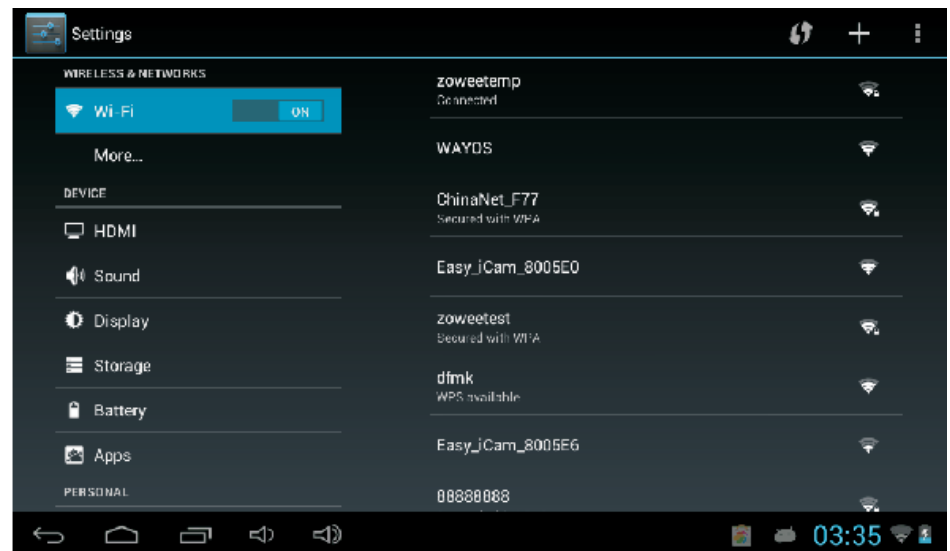

The following are some of the available settings:

Wi-Fi	Turn Wi-Fi ON/OFF. Shows available Wi-Fi signals, and allows you to tap on the signal you wish to join. See page X on connecting to and managing your Wi-Fi.
Data usage	A convenient tool for viewing the amount of data transferred to/from the tablet.
More. . .	Connect the tablet using VPN, Portable hotspot, Wi-Fi direct or a Mobile network.
Sound	Adjust tablet volumes for music, sound and notifications.
Display	Adjust the Brightness, Auto-rotation, Sleep duration and Font size. Also allows you to customize wallpaper.
HDMI	Activate HDMI (High-Definition Multimedia Interface), and adjust resolution and Screen Zoom.
Storage	Show the total amount of memory available in the tablet for data (e. g. , apps, pictures).
Battery	Shows battery usage over time, giving an estimate on how much battery power is available (as a time interval).

Apps	Shows a list of apps that have been Downloaded, are currently running, or are located on a separate device (such as an SD card.) Displays the total amount of internal storage available.
Accounts & sync	Allows user to view email accounts linked and accessible by the tablet, and synchronize features such as calendar and contacts.
Location services	Allows Google to determine your location using Wi-Fi, and to base any searches off that location.
Security	View and select options for security on the tablet, including screen lock, creating/ managing passwords, and tablet encryption. See page X on tablet security.
Language & input	Select the language you would like to view on the tablet. Also, manage input using voice, text-to-speech output, and pointer speed.
Backup & reset	Manage the backup and restoration of app data, Wi-Fi passwords, and other settings to Google servers. Also erase all data on the tablet.

Pre-Installed Applications

Date & time	Adjust the date/time displayed on the tablet.
Accessibility	Enables features for more functional tablet usage, including TalkBack, enlarged text, automatic screen rotation, the ability to speak passwords, touch and hold delays, and the installation of assistive web scripts.
Developer options	For Developer Use Only – These settings allow hardware/software developers to access programming and developmental aids in the tablet.
About tablet	Shows detailed information on the tablet, including system updates, status, legal information, model and Android software version number

Connecting to the Internet

The QD09 utilizes Wi-Fi networks to connect to the internet. (Wi-Fi technology can provide wireless internet access at distances over 300 feet, however, this distance can be affected by your surrounding environment and a Wi-Fi router.)

In order to connect to the internet, you will need either of the following:

- A wireless router.
- An access point with a broadband internet connection.
and
- The name of your network (SSID), as well as the password or other credentials, if your network is secure. (NOTE: You may encounter open Wi-Fi networks, or "hot spots." These networks are usually configured so that you can simply connect to them without needing to know its settings. The tablet will obtain all needed information from the router automatically.)

The wireless router must support Wi-Fi 802.11b/g connections. If the router supports 802.11n, make sure that it has been configured to accept 802.11b/g connections as well. (Note: A minimum connection speed of 64 Kbps is recommended. Faster speeds will provide for a better internet experience.)

Tablet Security

The QD09 comes with several security methods for unlocking the tablet, encrypting data, and other security functions. To change the security method, go to Settings, and touch the Security tab. You will be presented with the following options:

Screen Security	<p>Screen lock-The tablet has several methods for locking/unlocking the screen. Locking the screen prevents unauthorized users from accessing the tablet. The default setting is the 'Slide' lock.</p> <table border="1" data-bbox="562 632 2078 1150"> <tr> <td data-bbox="562 632 801 751">Slide</td> <td data-bbox="808 632 2078 751">The default setting. Requires the user to only slide the circle to the unlock icon to open the tablet.</td> </tr> <tr> <td data-bbox="562 756 801 876">Face unlock</td> <td data-bbox="808 756 2078 876">Uses a photograph image to unlock the tablet.</td> </tr> <tr> <td data-bbox="562 880 801 951">Pattern</td> <td data-bbox="808 880 2078 951">Requires the drawing of a pattern on the tablet screen to unlock.</td> </tr> <tr> <td data-bbox="562 956 801 1026">PIN</td> <td data-bbox="808 956 2078 1026">Uses a number with no more than 17 digits to unlock the tablet.</td> </tr> <tr> <td data-bbox="562 1031 801 1150">Password</td> <td data-bbox="808 1031 2078 1150">Uses a word or phrase with between 4 and 17 characters to unlock the tablet.</td> </tr> </table> <p><i>Owner info -Shows the owner information on the locked Start-up screen.</i></p>	Slide	The default setting. Requires the user to only slide the circle to the unlock icon to open the tablet.	Face unlock	Uses a photograph image to unlock the tablet.	Pattern	Requires the drawing of a pattern on the tablet screen to unlock.	PIN	Uses a number with no more than 17 digits to unlock the tablet.	Password	Uses a word or phrase with between 4 and 17 characters to unlock the tablet.
Slide	The default setting. Requires the user to only slide the circle to the unlock icon to open the tablet.										
Face unlock	Uses a photograph image to unlock the tablet.										
Pattern	Requires the drawing of a pattern on the tablet screen to unlock.										
PIN	Uses a number with no more than 17 digits to unlock the tablet.										
Password	Uses a word or phrase with between 4 and 17 characters to unlock the tablet.										
PASSWORDS	Make passwords visible-Allows passwords to be seen one character at a time, during input.										

DEVICE ADMINISTRATION (Advanced Users)	Device administrators- Unknown sources-When activated,allows the downloading and installation of 'unknown', non-market(e.g.,Google Play) Apps.
CREDENTIAL STORAGE (Advanced Users)	Trusted credentials- Shows all Trusted credentials. Install from SD card- Allows a credential to be installed via SD card. Clear credentials-Removes all credentials.

SLEEP AND AUTOMATIC LOCK

Unless otherwise set, the tablet will go to sleep, and automatically lock, after a preset period of time. The Sleep function can be set by going to Settings, and then to Display and selecting Sleep in the right side menu. The tablet can be set to sleep after 15 seconds to 30 minutes of inactivity, or not at all.

The screen lock is determined by the Screen Security setting(see above.)

POWER BUTTON INSTANTLY LOCKS

When screen security is active, the tablet will lock after the Power button has been pressed, and the screen has gone to sleep.

Troubleshooting

1.The tablet will not turn on.

- The tablet may need to be recharged. Insure that the AC adaptor is plugged-in correctly, and allow the tablet to charge.
- If you are aware that the tablet is charged, try resetting it by pressing the RESET button.

2.There is no sound in the earphones.

- The volume may be set to"0". Adjust the volume accordingly.
- Check the volume of the file you are attempting to play.
- Confirm that the earphones are properly connected to the tablet.

3.The incorrect language is being displayed.

- To set the language you wish displayed. Go to Settings, then Language & input(under PERSONAL), and select Language. Select the language you would prefer displayed.

4.Files will not download from my computer.

- Make sure you have the proper cable connection between the tablet and computer.
- Check to see if the tablet has enough memory to store the file you would like to download. Go to Settings, then Storage(under DEVICE),and look under INTERNAL STORAGE for Available. Compare the available amount of memory to the size of the file you're attempting to download.

5.Tablet will not play some video and/ or audio files.

- The tablet will not play audio files that are copy-protected.If should, however, play files you have purchases from Google Play or other such online store.



6.Fails to open a web page.

- Check to ensure the tablet has a Wi-Fi connection.
- It is possible the web page you're trying to access does not exist, or is under maintenance. Try accessing the site from another device.

7.Forgot password or lock pattern.

- Please contact Customer Service via email, and you will be given instructions on how to do a factory reset. Please be aware that all personal data will be deleted by a factory reset.

8.Downloaded an app, but don't see it on the home page.

- Check the Launcher Tab to see if the app you downloaded is under the APP tab.
- Check the AppInstaller.
- Go to Settings, then Apps, and view the list of downloaded or all Apps.

Frequently-Asked Questions(FAQ)

1. Where can I buy more apps?

Apps and widgets for the tablet can be purchased or downloaded from a number of sources. The tablet comes ready with a Google Play, app, which will allow you access to Google Play, and enable you to download everything from music to video and apps. You can also try the Amazon Appstore.

2. How do I sync my email to the tablet?

- Goto 'Settings', scroll down to 'PERSONAL' and select 'Accounts & sync'.
- Touch 'ADD ACCOUNT' in the upper right corner. A pop-up window will appear, giving you the option to add a Corporate, regular Email, or Google account(which includes gmail.) Select the type of account you would like to sync with the tablet ,and follow the prompts. You will be asked for the email address/user-name and password,

1. Can Nobis repair my tablet if it breaks, or I drop it in water?

Please read the Warranty statement at the rear of this instruction manual. If the damage is not covered by the Nobis warranty, you can contact Nobis Customer Service to see what options may be available to you.

4. Do I need to let the battery drain before I recharge the tablet?

No. It's usually a good idea to charge the tablet before it reaches 1% power, and the tablet will prompt you to plug it in when the battery is low.

5. Can I use a stylus,and if so,what type can I use?

Yes. You can use the styplus that was designed for capacitive screen.

6. Can I upgrade the processor?

No. Any attempt to upgrade the hardware of the tablet will void the warranty ,and may compromise the operation of the tablet

FCC NOTICE

The following statement applies to all products that have received FCC approval. Applicable products bear the FCC logo, and/or an FCC ID in the format FCC ID:2AAP6M9029 on the product label. This mobile device complies with part 15 of the FCC Rules. Operation is subjected to the following two conditions: This mobile device may not cause harmful interference, and this mobile device must accept any interference received, including interference that may cause undesired operation. This mobile device has been tested and found to comply with the limits for a Class B digital device, pursuant to Part 15 of the FCC Rules. These limits are designed to provide reasonable protection against harmful interference in a residential installation. This equipment generates, uses and can radiate radio frequency energy and, if not installed and used in accordance with the instructions, may cause harmful interference to radio or television reception, which can be determined by turning the equipment off and on, the user is

encouraged to try to correct the interference by one or more of the following measures:

- Reorient or relocate the receiving antenna.
- Increase the separation between the equipment and receiver.
- Connect the equipment into an outlet on a circuit different from that to which the receiver is connected.
- Consult the dealer or an experienced radio/TV technician for help.

Changes or modifications not expressly approved by the party responsible for compliance could void the user's authority to operate the equipment. The antenna(s) used for this transmitter must not be colocated or operating in conjunction with any other antenna or transmitter.

Compliance Information

RF EXPOSURE INFORMATION (FCC SAR)

DEVICE MEETS THE GOVERNMENT'S REQUIREMENTS FOR EXPOSURE TO RADIO WAVES.

This device is designed and manufactured not to exceed the emission limits for exposure to radio frequency (RF) energy set by the Federal Communications Commission of the U.S. Government. The exposure standard for wireless mobile devices employs a unit of measurement known as the Specific Absorption Rate, or SAR. The SAR limit set by the FCC is 1.6W/kg. Tests for SAR are conducted using standard operating positions accepted by the FCC with the device transmitting at its highest certified power level in all tested frequency bands. Although the SAR is determined at the highest certified power level, the actual SAR level of the device while operating can be well below the maximum value. This is because the device is designed to operate at multiple power levels so as to use only the power required to reach the network. In general, the closer you are to a wireless base station antenna, the lower the power output.

The highest SAR value for the device as reported to the FCC when tested for use when worn on the body, as described in this user guide, is 0.725W/Kg for Body and summation is 1.056 W/Kg for Body; (Body-worn measurements differ among device models, depending upon available accessories and FCC requirements.)

While there may be differences between the SAR levels of various devices and at various positions, they all meet the government requirement. The FCC has granted an Equipment Authorization for this device with all reported SAR levels evaluated as in compliance with the FCC RF exposure guidelines. SAR information on this device is on file with the FCC and can be found under the Display Grant section of www.fcc.gov/oet/ea/fccid/ after searching on FCC ID: 2AAP6M9029.

For Canada

This Class B digital apparatus complies with Canadian ICES-003. This Category II radiocommunication device complies with Industry Canada Standard RSS-310.

Warning Statement

Operation is subject to the following two conditions: this device may not cause interference, and this device must accept any interference, including interference that may cause undesired operation of the device.

IMPORTANT NOTICE: IC Radiation Exposure Statement

This EUT is compliance with SAR for general population/ uncontrolled exposure limits in IC RSS-102 and had been tested in accordance with the measurement methods and procedures specified in IEEE 1528. This equipment should be installed

and operated with minimum distance 0.5cm between the radiator and your baby. this device and its antenna (s) must not be co-located or operating in conjunction with any other antenna or transmitter.

WARRANTY

ONE-YEAR LIMITED WARRANTY ON PARTS AND 90 DAYS ON LABOR

Nobis provides a warranty to the original purchaser of a new Product against defects in materials and workmanship for a period of one year of non-commercial usage and ninety(90)days if commercial use. If a Product covered by this by this warranty is determined to be defective within the warranty period, Nobis will either repair or replace the unit at its sole option and discretion.

PARTS AND LABOR

There will be no charge for parts or labor during the first ninety (90) days of the warranty period. Thereafter and up to one year from the date of purchase, parts only are under warranty. There will be a labor fee if repairs are required during this time. Replacement parts and units may be new or recertified at Nobis' s option and sole discretion.

Replacement parts and units are warranted for the remaining portion of the original warranty or for ninety (90) days from warranty service or replacement, whichever is greater.

TYPE OF SERVICE

Defective Products must be sent to a Nobis service center to obtain warranty service. Nobis is not responsible for transportation costs to the service center, but Nobis will cover return shipping to the customer. Pre-authorization is required before sending any unit in for warranty service.

Product returns to Nobis' s service centers must utilize either the original box and shipping material or packaging that affords an equal degree of protection. Nobis Technical Support will provide instructions for packing and shipping the covered Product to the Nobis service center.

Limitations and Exclusions

Nobis' S one-year limited warranty only covers defects in materials and workmanship. This warranty does not cover: cosmetic damage, units that are dropped, normal wear and tear, improper operation, improper voltage supply or power surges, signal issues, damages from shipping, acts of God, any type of customer misuse, modifications or adjustments, as well as installation and set-up issues or any repairs attempted by anyone other than by a Nobis authorized service center. Products with unreadable or removed serial numbers, or requiring routine maintenance are not covered. This one year limited warranty does not cover Products sold: "AS IS", "FACTORY RECERTIFIED" or by a non-authorized reseller.

THERE ARE NO EXPRESS WARRANTIES OTHER THAN THOSE LISTED OR DESCRIBED ABOVE. ANY IMPLIED WARRANTIES, INCLUDING ANY IMPLIED WARRANTY OF MERCHANTABILITY AND FITNESS FOR A PARTICULAR PURPOSE, SHALL BE LIMITED IN DURATION TO THE

PERIOD OF TIME SET FORTH ABOVE. DAGE' S TOTAL LIABILITY FOR ANY AND ALL LOSSES AND DAMAGES RESULTING FROM ANY CAUSE WHATSOEVER INCLUDING DAGE' S NEGLIGENCE, ALLEGED DAMAGE, OR DEFECTIVE GOODS, WHETHER SUCH DEFECTS ARE DISCOVERABLE OR LATECT, SHALL IN NO EVENT EXCEED THE PURCHASE PRICE OF THE PRODUCT, DAGE SHALL NOT BE RESPONSIBLE FOR LOSS OF USE, LOSS OF INFORMATION OR DATA, COMMERCIAL LOSS, LOST REVENUE OR LOST PROFITS, OR OTHER INCIDENTAL OR CONSEQUENTIAL DAMAGES.

Some states do not allow limitations on how long an implied warranty lasts or the exclusion of incidental or consequential damages, so the above limitations or exclusions may not apply to you. This warranty gives you specific legal rights, and you may also have other rights, which vary from state to state. THIS WARRANTY IS SUBJECT TO CHANGE WITHOUT NOTICE.



SERVICE CENTER

1845 S.Vineyard Ave.Ste.4
Ontario,CA 91761
Hours:8:30AM-5:00PM PST

TO OBTAIN WARRANTY SERVICE

Contact Nobis Technical Support
email: support@zoweeusa.com
from 8:30AM to 5:00PM Monday through Friday
Pacific Time.

Pre-authorization must be obtained before sending any product to the Service Center.Proof of purchase in the form of a purchase receipt or copy is required to show that a product is within the warranty period.

Please provide all information when filling out the request on our website. If you'd like to speak with us, put in that request as well. You will receive a email back or call back within 1 business day.