

UserGuide

MF279T

Contents

Getting Started	3
In the Box	3
Getting to Know Your Device	3
Indicators	4
How It Works	5
Device Installation	5
Before You Begin	5
Installation Guide	6
Voicemail	11
Transferring a Phone Number	11
MF279T Manager	12
Using Your Device	13
Calling	13
Internet Access	15
Checking Your Voice and Data Usage	16
Helpful Tips	17
Important Information	18
Power Outages	18
Back-up Battery	18
Device Compatibility	18
In-Home Wiring	19
Device Configuration	19
Wi-Fi Settings	19
Network	21
Advanced Settings	24
Specifications	27
Troubleshooting	28
General	28
Phone	28
Internet	30
Safety Instructions	31
Radio Frequency (RF) Exposure	32
FCC Regulations	32
IC	33
CTIA	34
Warranty	34
LEGAL INFORMATION	35

Getting Started

In the Box

The package contains the following items:

- MF279T
- Power Cord
- Phone Cable (Optional)
- Back-up Battery
- Get Started Guide





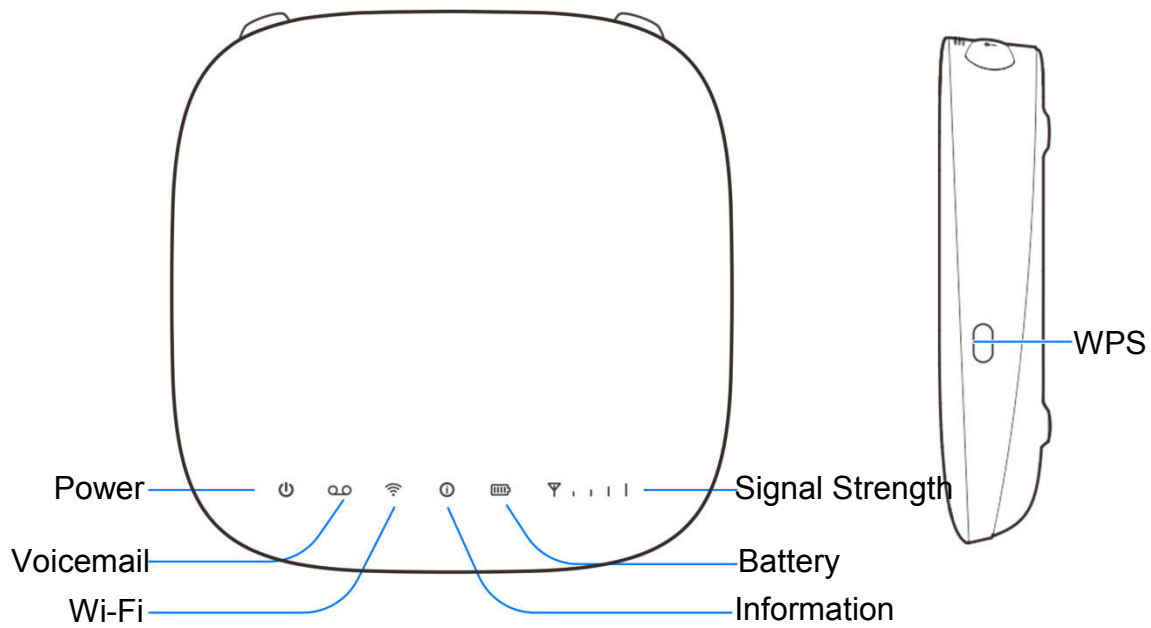

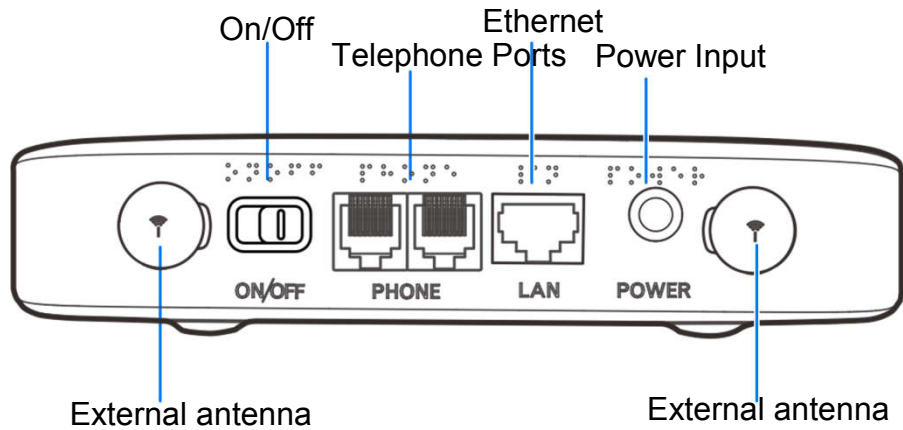
Getting to Know Your Device

* Allows WPS-enabled devices to be connected via Wi-Fi without typing a Wi-Fi password. For detailed instructions, please refer to page 17.





Indicators

Indicator	State	Description
Power 	Green steady	On AC power
	Green blinking	On battery power
	Off	No power
Voicemail 	Green blinking	New voicemail waiting
	Off	No new voicemail
Wi-Fi 	Green steady	Wi-Fi on, no data transferring
	Green flickering	Data transferring
	Off	Wi-Fi off
Information 	Green blinking	Check the MF279T new messages
	Off	No unread messages
Battery 	Green steady	More than 50% battery power
	Yellow steady	20%-50% battery power
	Red blinking	Less than 20% battery power
	Off	Battery needs to be installed or replaced
Signal Strength 	Blue steady	Strong signal 3G/4G/HSPA+(antenna and 1,2,3,4bars)
	Blue blinking	3G/4G/HSPA+ roaming (antenna and 1,2,3,4bars)
	Green steady	Strong signal LTE(antenna and 1,2,3,4bars)

	Green blinking	LTE roaming (antenna and 1,2,3,4bars)
	Red steady	No service, limited service, or searching for signal (antenna with RED and 0 bar)
	Red blinking	SIM checking, SIM error or other abnormal (antenna with RED and 0 bar. Blinking period: 2s)

How It Works

The MF279T uses the TELUS cellular network to provide phone service to your cordless or corded home phone(s) and Internet access to your computer and Wi-Fi enabled devices. Place it anywhere in your home where you have a strong wireless signal. It does not require the use of a home phone wall jack like traditional home phone service.

The MF279T provides many calling services, such as voicemail, Caller Number ID, Call Waiting, Call Forwarding, and Three-way Calling for your home phone(s). It also includes a back-up battery in case of a power outage.

Device Installation

Before You Begin

The MF279T works exclusively with the TELUS cellular network and DOES NOT use your home phone wall jacks.

Your device should be located:

- Where you have a strong signal from a cell tower, typically near a window or outside wall. Signal strength may vary in different parts of your home.
- Near an electrical wall outlet.
- In the general area where you'll be using your home phone, computer, or Wi-Fi enabled devices.

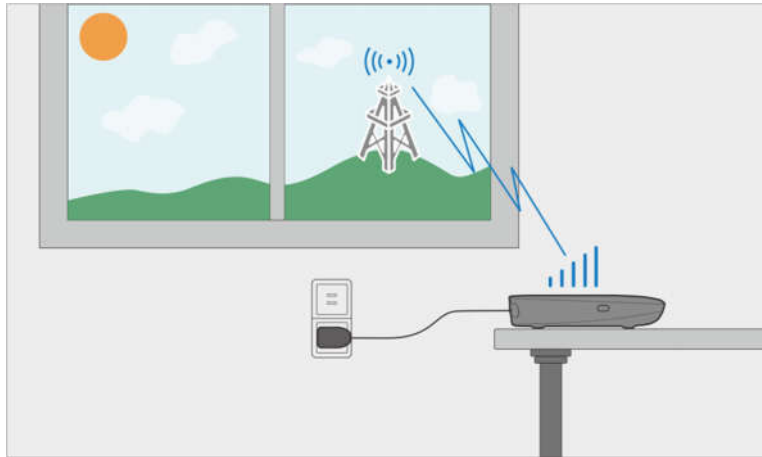

Select which phone and computer/Wi-Fi enabled device you will use with the MF279T:

- A cordless phone system with multiple handsets should be used to place phones throughout your home.
- If using an existing phone, unplug it from the wall jack.
- For Internet access, you may connect up to 20 devices via Wi-Fi and one via Ethernet simultaneously.

Installation Guide

Install the Back-up Battery and nano-SIM Card(Optional)

1. Remove the bottom of the device by pushing the entire cover in the direction of the arrow.

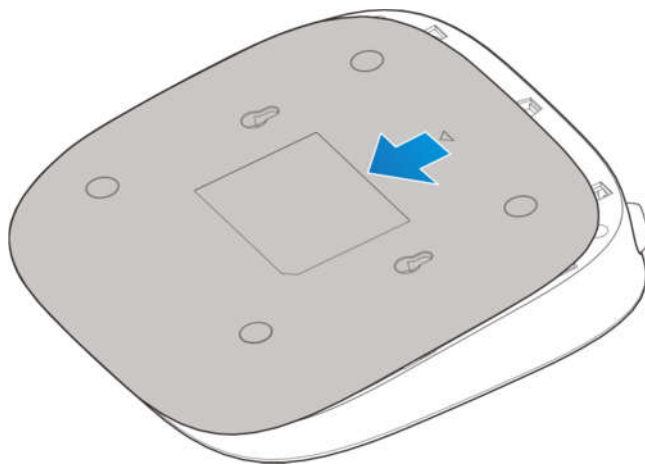

2. Install the nano-SIM card (Optional).

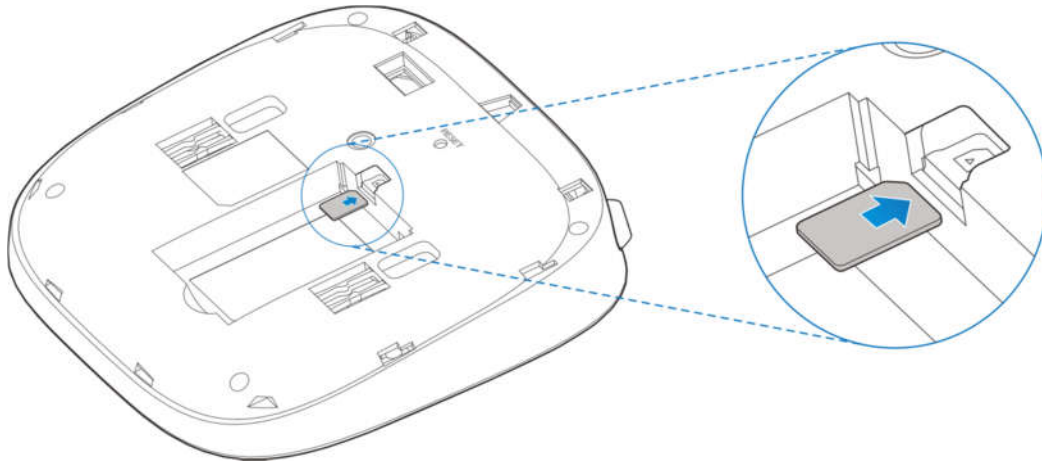

WARNING!

- Your device only supports a nano-SIM card.
 - To avoid damaging the device, please only use the card that is provided by TELUS and ensure that the nano-SIM card contacts are facing up when inserting it into the nano-SIM slot.
2. Insert the back-up battery.

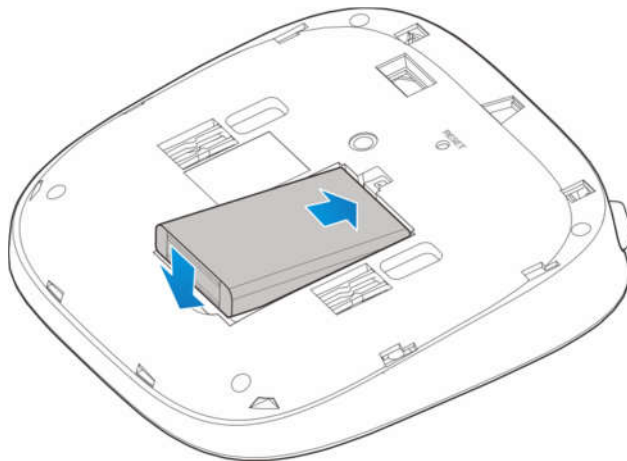

3. Replace the cover.

Turn on Your Device

1. Plug the power cord into an electrical wall outlet.
2. Connect the other end of the power cord into the Power Input port on the back of your MF279T.
3. Slide the ON/OFF button to the ON position and you'll see the power light stays steady green.

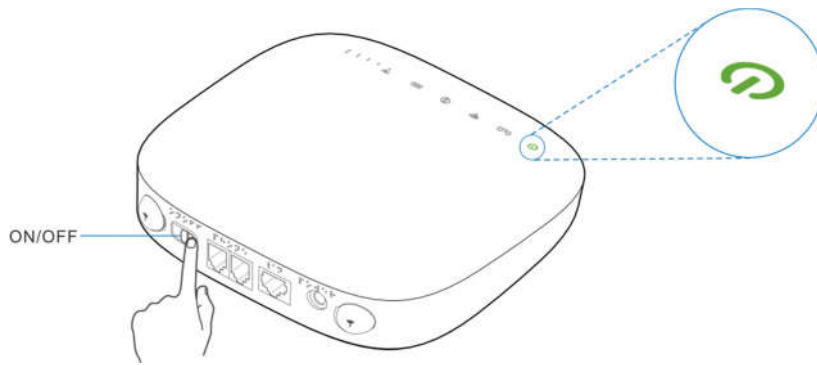

Check the Wireless Signal

Wait a few seconds for the signal strength light to turn on, while your device connects to the cellular network.

Confirm signal strength light is green for optimal performance. Blue indicates a moderate signal and may be sufficient.

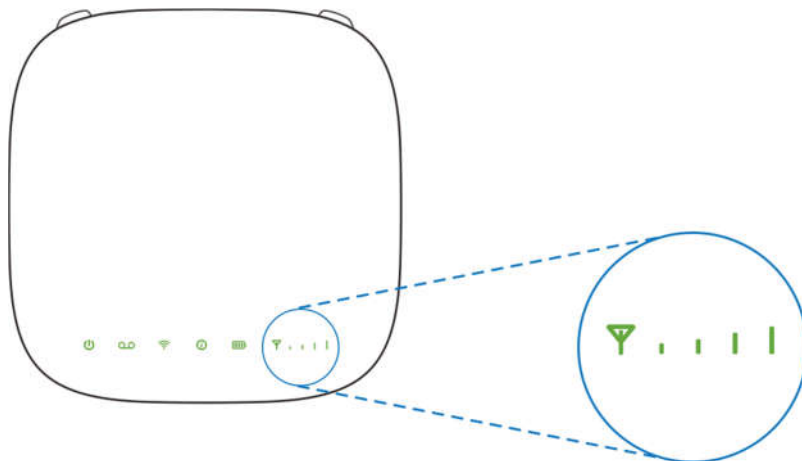

Connect Your Phone

Unplug Your Phone from the Wall Jack

The MF279T is not used with your home phone wall jack.

Note: If you have a cordless phone, keep it plugged into a power outlet.

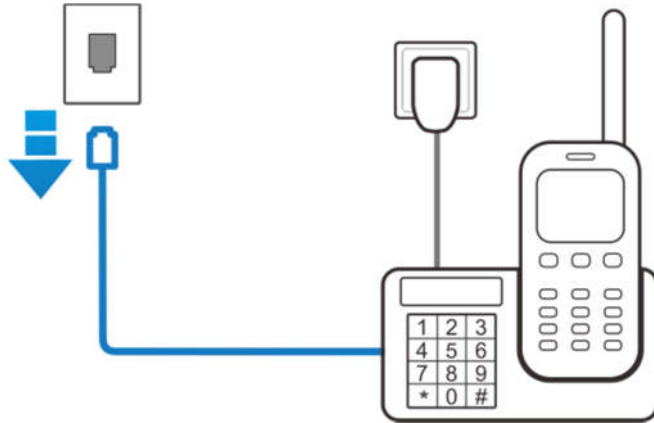

Connect Your Phone to the Device

Plug your phone into the “Phone 1” port on the MF279T, using your existing phone cable or the included phone cable.

Note: Do not plug the device into your home phone wall jack.

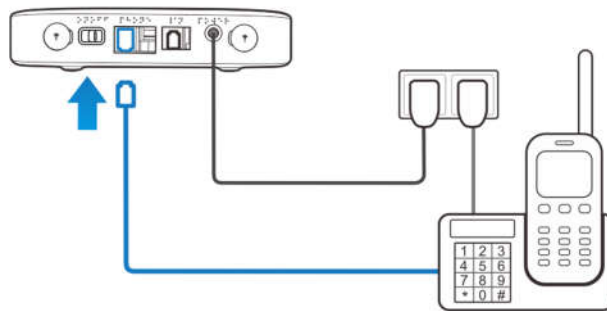

Place a Test Call

Place a test call from your connected home phone. Make sure to dial the 10-digit phone number, including area code.

For best results, place the cordless phone base at least 12 inches from the MF279T.

Important Phone Tips

- Voicemail is included with your service. Dial "1" to set up and access. If you choose to use an answering machine instead, set it to fewer than four (4) rings.
- To place phones throughout your home, use a cordless phone system with multiple handsets. Wall jacks are not used with the MF279T.

- The "Phone 2" port can be used to connect an additional phone or standalone answering machine. It uses the same phone number as the "Phone 1" port.
- Your MF279T does not support incoming/outgoing fax service or home alarm systems.
- Your MF279T does not support rotary or pulse-dialing phones.

Connect to the Internet

Select Your Internet Connection

To Connect via Wi-Fi:

1. Open the Wi-Fi network manager on your computer or Wi-Fi enabled device.
2. Find and select the MF279T Wi-Fi network name (SSID) (e.g., ZTE MF279T/2.4GXXXX, or ZTE MF279T/5GXXXX, XXXX is the last 4 digits of MAC address).

To Connect via Ethernet:

Use an Ethernet cable (not included) to connect your computer or other device to the Ethernet port on the back of your MF279T. Go to **Telus.com** (or your favorite website) to confirm your Internet connection.

To connect via WPS, see page 17.

Enter Wi-Fi Network Password

When prompted, enter the Wi-Fi password found on the bottom of the MF279T.

Confirm Internet Connection

Go to **Telus.com** (or your favorite website) to confirm your Internet connection.

When your device is transmitting to and from the Internet, the Wi-Fi light will flicker green.

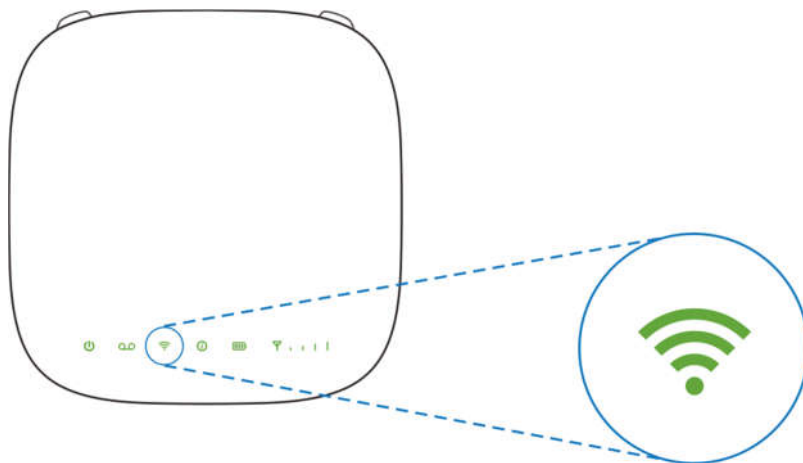

Voicemail

Your MF279T comes with standard wireless voicemail. Follow the steps below to setup and use your voicemail.

Setup

Dial **1** on any home phone connected to the MF279T and wait four (4) seconds to connect to your TELUS wireless voicemail. Simply follow the voice prompts to complete setup. To enable remote voicemail retrieval and for added security be sure to create a password during setup.

Message Waiting

There are two indicators for a new message waiting: 1) the voicemail icon; and 2) an intermittent dial tone.

The voicemail icon  on your MF279T blinks when a voicemail message is waiting. You will also hear an intermittent dial tone on any connected phone handset before placing a call.

Retrieving Messages

To retrieve voice messages, dial **1** on any home phone connected to the MF279T and wait four (4) seconds to connect to your TELUS wireless voicemail box. Simply follow the voice prompts to listen to and manage your messages. (Alternately, you may dial your 10-digit home phone number to access your voicemail box.)

Remote Retrieval

To retrieve voicemail messages from a phone not connected to the MF279T, dial the number associated with your MF279T service. When voicemail picks up, press *. You will then be prompted to enter your password. Simply follow the prompts to listen to and manage your voicemail messages.

Transferring a Phone Number

Transferring a landline phone number to your MF279T can take about four (4) days. Outgoing calls can be made immediately using your MF279T, however incoming calls (including 911) will continue through your old service until the transfer is complete. Keep a phone connected to your wall jack or prior service to continue to receive incoming calls until the transfer is complete.

MF279T Manager

The MF279T Manager allows you to easily manage your MF279T. You can:

- Customize settings
- Change your Wi-Fi network name and password
- Check signal strength, data usage, and important messages from TELUS
- Get help and information

To access the MF279T Manager, first connect to your MF279T. In your browser address field, enter **http://telus.ztesmarthub** or **http://192.168.0.1** and log in using "admin".

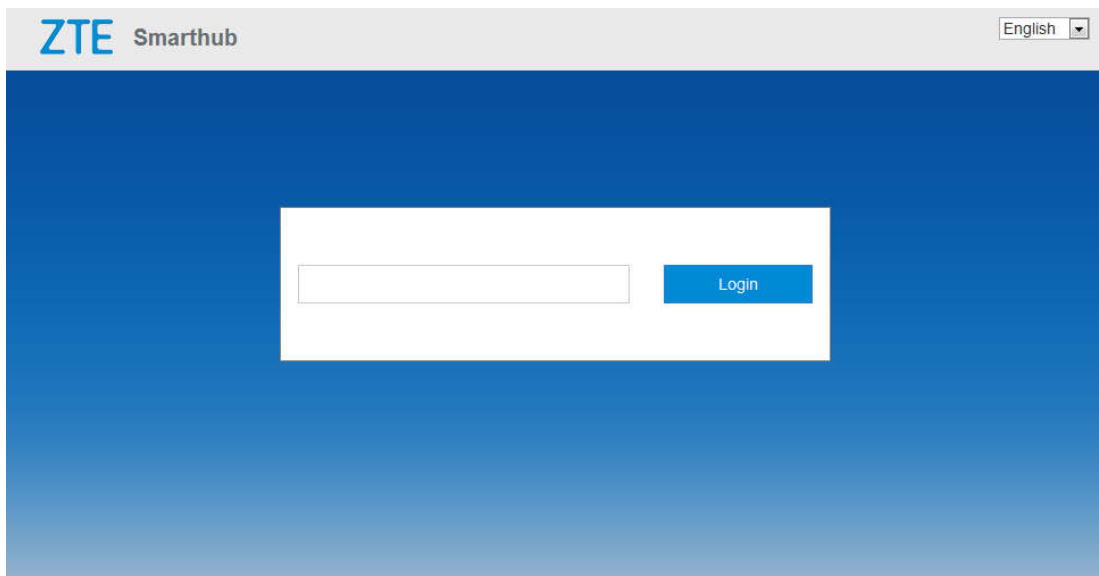

The MF279T Manager includes a navigation panel on the screen, which contains the following sections:

- **My router** -- displays general device information and help, check the connection settings, customize your device's Wi-Fi settings.
- **Access device** -- view devices currently connected to your MF279T and block/unblock devices from connecting.
- **Net surfing** -- surf the network.
- **Statistics** -- get details regarding current statistics status and information.
- **SMS** -- view messages from TELUS about your service plan.
- **Advanced Settings** -- customize your device's security settings.

You can also change the current mode of your Smarthub:

1. View the current mode on the right top of the configuration page, and then click **Change**.

Current Mode: Wireless Broadband Mode **Change**

2. Select an operation mode which you want to use and then click **Apply**.

Change Mode x

LTE Bridge Mode

Wireless Broadband Mode

If wireless broadband mode is enabled, please remove network cable of public network.

Note: If you change the operation mode, the device will be restarted automatically.

3. Set the detail parameters for the operation mode.
4. Begin to enjoy your Internet service.

Using Your Device

Calling

Making Calls

Using a phone connected to your MF279T, place and receive calls as you normally would. The MF279T supports both cordless and corded phone dialing methods.

Note: Make sure to dial the 10-digit phone number, including area code.

Three-Way Calling

While on an existing call, press the **Flash** (or **Phone/Talk**) key on your phone to put the first party on hold. When you hear a dial tone, dial the second party's number (wait up to four [4] seconds). When the second party answers, press the **Flash** (or **Phone/Talk**) key again to complete the three-way connection. If the second party does not answer, press the **Flash** (or **Phone/Talk**) key to end the connection and return to the first party.

Note: If your phone does not have a **Flash** (or **Phone/Talk**) key, use the off-hook mechanism supported by your phone instead.

Call Waiting

You will hear two tones if someone calls while you are already on a call.

To hold the current call and accept the waiting call, press the **Flash** (or **Phone/Talk**) key. You can press the **Flash** (or **Phone/Talk**) key anytime to switch back and forth between calls.

To clear the current call and accept the waiting call, enter "1" and press the **Flash** (or **Phone/Talk**) key.

To reject (User Busy) the waiting call, enter "0" and press the **Flash** (or **Phone/Talk**) key.

Notes:

- Your MF279T comes with standard three-way calling and call waiting. Operation of these features will vary depending on your home phone equipment.
- If your phone does not have a **Flash** (or **Phone/Talk**) key, then use the off-hook mechanism supported by your phone.

Call Forwarding

Always forward

1. Press *21* on your connected phone.
2. Dial the 10-digit number to which you wish to forward your calls.
3. Press the "#" key.

(Example: *21*1234567890# forwards your calls to the phone number 123-456-7890)

4. Wait for 3 seconds until you hear a confirmation tone for the forwarding process to complete before hanging up.

Note: To un-forward calls, press #21#, wait for 3 seconds until you hear a confirmation tone for the un-forwarding process to complete before hanging up.

Forward when busy

1. Press *67* on your connected phone.
2. Dial the 10-digit number to which you wish to forward your calls.
3. Press the "#" key.
4. Wait for 3 seconds until you hear a confirmation tone for the forwarding process to complete before hanging up.

Note: Press #67# to un-forward calls.

Forward when unanswered

1. Press *61* on your connected phone.
2. Dial the 10-digit number to which you wish to forward your calls.
3. Press “#” key.

(Example: *61*1234567890**10# forwards your calls to the phone number 123-456-7890, if you don't answer the calls for 10 seconds.)

4. Wait for 3 seconds until you hear a confirmation tone for the forwarding process to complete before hanging up.

Note: Press #61# to un-forward calls.

Forward when unreachable

1. Press *62* on your connected phone.
2. Dial the 10-digit number to which you wish to forward your calls.
3. Press “#” key.
4. Wait for 3 seconds until you hear a confirmation tone for the forwarding process to complete before hanging up.

Note: Press #62# to un-forward calls.

Internet Access

Connect Other Devices

You can connect up to 20 Wi-Fi enabled devices simultaneously to your MF279T, including smartphones, tablets, laptops, etc.

1. Open the Wi-Fi network manager on your Wi-Fi enabled device.
2. Find and select the Wi-Fi network name (SSID) **ZTE MF279T/2.4GXXXX / ZTE MF279T/5GXXXX**.

Note: Your device support 2.4G wireless network and 5G wireless network. You can connect to 10 Wi-Fi enabled devices in 2.4G network and connect to 10 Wi-Fi enabled devices in 5G network simultaneously.

3. When prompted, enter the Wi-Fi password found on the bottom of the MF279T.

Connect WPS devices

Wi-Fi Protected Setup (WPS) allows WPS-enabled devices to be connected to a Wi-Fi network without having to type a Wi-Fi password.

1. With the MF279T powered on, press and hold the WPS button for one (1) second.
2. Within two (2) minutes, press the WPS button on the wireless device you want to connect.
3. Your MF279T and the wireless device will communicate and establish the connection.

Connect via Ethernet

To connect via Ethernet, plug one end of your Ethernet cable into the Ethernet port on your computer and the other end into the Ethernet port on the back of the MF279T.

Changing Wi-Fi Network Name and Password

You can customize your MF279T Wi-Fi network name (SSID) and password using the MF279T Manager. On any device that is connected to the MF279T, enter **http://telus.ztesmarthub** directly into your browser address field and log in using "admin" (or your customized login). Go to **Wi-Fi Settings** to change your network name and password.

Note: You will need to reconnect all Wi-Fi devices using the new information.

Important Messages

Your MF279T is able to receive important messages from AT&T regarding new software updates and your service plan. You are not able to respond or reply to these messages.

To view your messages, use any device that is connected to the MF279T and enter **http://telus.ztesmarthub** directly into your browser address field. Log in using "admin" (or your customized login), and go to **SMS**.

Managing Connected Devices

You can view devices currently connected to your MF279T and block and unblock devices using the MF279T Manager. On any device that is connected to the MF279T, enter **http://telus.ztesmarthub** directly into your browser address field. Log in using "admin" (or your customized login), and go to **Access device**.

Checking Your Voice and Data Usage

You can also use the MF279T Manager to check your data plan usage and view data usage notifications. On any device that is connected to your MF279T, enter **http://telus.ztesmarthub** directly into your browser address field. Log in using "admin" (or your customized login). To check your data usage and the days remaining in your billing cycle, go to **Statistics** or **Statistics Information**. To view data usage notifications, go to **Messages**. The "i" light on your MF279T will blink green when you have a new notification.

Note: Actual billed usage can be higher than the estimated data usage displayed in the usage meter.

Helpful Tips

Home Answering Machines

If you choose to use your home answering machine instead of the voicemail provided by your MF279T, you will need to set your answering machine to pick up calls before network voicemail, which is fewer than four (4) rings. If you have a standalone answering machine, you can connect it to the "Phone 2" port on the back of your MF279T.

Adjusting Volume

Use your home phone's volume adjustment if available. Alternatively, the volume of the MF279T can be adjusted. Four volume levels are available (level 1 to level 4) with the default setting at level 4. While on a call, press ****** to decrease volume or press **##** to increase volume. Each time ****** or **##** is pressed, the volume level is decreased or increased one volume level. To exit Volume Setting Mode, press any other key or wait five (5) seconds.

Powering On/Off

The **ON/OFF** button is used to turn your MF279T on or off. When powered off, the MF279T will no longer send or receive calls, but it will continue to charge the back-up battery if still connected to the wall outlet.

To turn on your MF279T, slide the **ON/OFF** button to the **ON** position until the power light stays solid green, if connected to a power supply (it will blink green if on back-up battery). To turn off your MF279T, slide the **ON/OFF** button to the **OFF** position until all the lights turn off.

TTY Support

TTY (Text Telephony) and TDD (Telecommunications Device for the Deaf) are supported by the MF279T. In order to use the TTY network, you must have a TTY-compatible phone and be in TTY mode. Note that most digital wireless devices are TTY-compatible.

Dial ***983*889*n#** to set the TTY mode.

- n = 0: TTY off mode. The standard voice speaking mode and listening mode. This is the default setting.
- n = 1: TTY full mode. Transmit and receive the TTY characters.
- n = 2: VCO mode. Receive TTY characters but transmit by speaking into the speaker.
- n = 3: HCO mode. Transmit TTY characters but receive by listening to the receiver.

Important Information

Power Outages

The MF279T has a back-up battery in the event of a power outage with talk time of approximately XXX minutes and standby time of approximately XXX hours depending on environmental factors. In the event of a power outage (commercial power no longer being available), the MF279T will automatically begin using the back-up battery, provided there is sufficient battery charge left. If there is no battery charge at the time of the power outage, the device will not be operable.

To make calls using your back-up battery, you must plug a corded phone or landline phone into the "Phone 1" or "Phone 2" port on the MF279T.

The MF279T will disable Wi-Fi to conserve power while using the back-up battery when there are no devices connected. To re-enable Wi-Fi while using the back-up battery, slide the **ON/OFF** button to the **ON** position. Or, if power is available, plug the MF279T into an electrical wall outlet.

If you experience a power outage and your back-up battery is fully depleted, it will be necessary to restart your device when power is restored by sliding the **ON/OFF** button to the **ON** position until the power light stays solid green.

Back-up Battery

A new back-up battery should last for approximately 5 years, but the life of any back-up battery can be adversely affected by environmental conditions like moisture and heat. To get the longest service from your back-up battery, do not place the MF279T in direct sunlight or in wet or extremely cold environments.

To test the condition of your back-up battery, make sure the MF279T is powered on. Unplug the MF279T from the wall power outlet. If the Power LED immediately starts blinking red, then the back-up battery may need to be replaced. If the MF279T does not remain on (no LEDs are lit) once unplugged from the wall power outlet, then the back-up battery needs to be replaced.

It is recommended that you test your back-up battery charge at least once per year and replace if necessary.

Device Compatibility

The MF279T is not compatible with wireless messaging services, home security systems, fax service, medical alert systems, medical monitoring systems, credit card machines, IP/PBX Phone systems, or dial-up Internet service. May not be compatible with your DVR/Satellite systems, please check with your provider. DSL customers should contact their provider before transferring a phone number to ensure uninterrupted DSL Internet service.

In-Home Wiring

Interconnecting to home telephone wiring is not necessary, but is possible; however, it is not recommended unless you possess sufficient knowledge of electrical systems. Use with home wiring requires the physical disconnection from other services, including the landline coming into your home. Use of a qualified licensed electrician is highly recommended. Improper installation may result in phone equipment damage or even a fire.

Device Configuration

You can manage your MF279T settings using the MF279T Manager. To access, first connect to your MF279T and enter <http://telus.ztesmarthub> or <http://192.168.0.1> (or other IP if you have changed it from the default) directly into your browser address field. Log in using "admin"(or your customized login).

Wi-Fi Settings

You can manage your MF279T Wi-Fi Settings under **Wi-Fi > Settings**.

Basic

2.4 GHz 5.0 GHz WPS

2.4GHz Basic Settings

Access Point Switch Enable Disable

Network Name(SSID) *
 Broadcast SSID

AP Isolation All the wireless client device is completely isolated

Security Mode

Password *
 Display Password

Max Station Number

Apply

Access Point Switch: Select to enable or disable access point switch.

Network Name (SSID): Shows the Wi-Fi network name (SSID), which is broadcast by the device to allow Wi-Fi enabled devices to identify and connect to it. You can change the Network Name by typing the desired name directly into the text box.

Broadcast Network Name (SSID): If this setting is enabled, the MF279T appears in the list of available Wi-Fi networks on your Wi-Fi enabled devices. If disabled, the network will not appear.

AP isolation: If this setting is enabled, all the wireless client device is completely isolated.

Security Mode: The security modes are described below:

Mode	Description
OPEN	Authentication and encryption won't be active. There are risks that private information can be intercepted or that the network will be used by unauthorized individuals.
WPA2(AES)-PSK	A more secure version of WPA with implementation of the 802.11i standard.
WPA-PSK/WPA2-PSK	Apply both the WPA-PSK and WPA2-PSK schemes.

Password: Set the password for your wireless local area network.

Max Station Number: Choose the maximum number of the devices that can connect to the Wi-Fi hotspot simultaneously.

2.4GHz Advanced Settings

Network Mode	802.11 b/g/n
Channel Bandwidth	20MHz/40MHz
Country/Region Code	CANADA
Frequency (Channel)	Auto

Apply

Network Mode: Indicates which mode is active for connecting via Wi-Fi. The default is 802.11b/g/n Mixed Mode for 2.4G network, and 802.11 a/n/ac Mixed Mode for 5G network.

Channel Bandwidth: Choose the channel bandwidth for your environment.

Country/Region Code: You can select the suitable Country/Region Code for your device.

Frequency (Channel): This should be left on Automatic unless you need to choose a particular channel for your environment.

Be sure to click "Apply" after you've made changes.

Connections

View devices that are currently connected to your MF279T and block and unblock devices from having access.

The following information is displayed for each connected device:

Device Name: If you have assigned a name to the connected device, the assigned name will appear. If the device name is unavailable, you will need to refer to the MAC Address to identify your device.

MAC Address: A unique network identifier for the connected device.

WPS

WPS, or Wi-Fi Protected Setup, is a standard that allows easy establishment of a secure wireless home network. This feature is set to Enable by default. If you change these settings, existing connected devices may lose their connection.

WPS Mode: You may select either **PIN** or **PBC (Push-Button Connection)** by selecting the desired option and clicking "Apply".

PIN: If selected, you will need to specify a 4-digit or 8-digit PIN that other devices will require to connect via this method. Enter the desired PIN in the field, then click "Apply".

PBC: If selected, this will act in the same way as manually pushing the WPS button on the back of the MF279T. Within two (2) minutes, you will need to activate WPS on the device you wish to connect to the MF279T via a physical or virtual button in order to complete the connection process.



Note: Refer to your connecting device's documentation for specific information on how to complete the WPS process on the desired device. When you hide the SSID, you can't use the WPS function.

Network

These settings affect the connection to the mobile (wide area) network or WAN.

Connections

You can set the WAN connection mode here. The default mode is Automatic.

Mode	Operation
Automatic	Your device is automatically connected to the Internet, and you can surf on the Internet through the client.
Manual	<ol style="list-style-type: none">1. Log in to the configuration page.2. In My router section, select LTE (or other network type) Settings > Connection Mode > Manual, and then click Apply.3. Click  to return to the home page, and then click  or .

Network Selection

In My router section, select LTE (or other network type) **Settings >Network Selection**.

You can set the device to search for the network automatically.

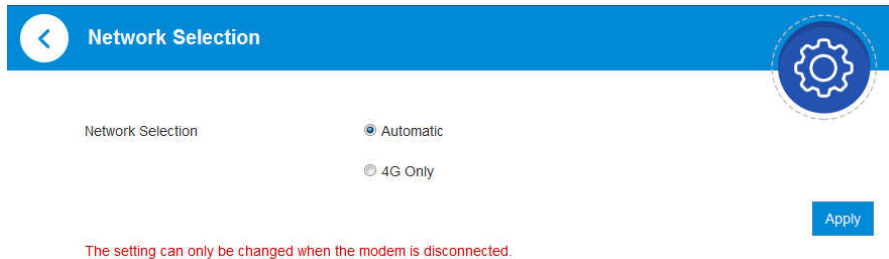

Network Selection

Automatic

4G Only

The setting can only be changed when the modem is disconnected.

Apply

Automatic: The device will search for the available network automatically.

4G Only: The device searches for 4G network only.

Click **Apply** to confirm your configuration.

APN

In My router section, select LTE (or other network type) **Settings > APN**.

The APN parameters are shown in the following figure.

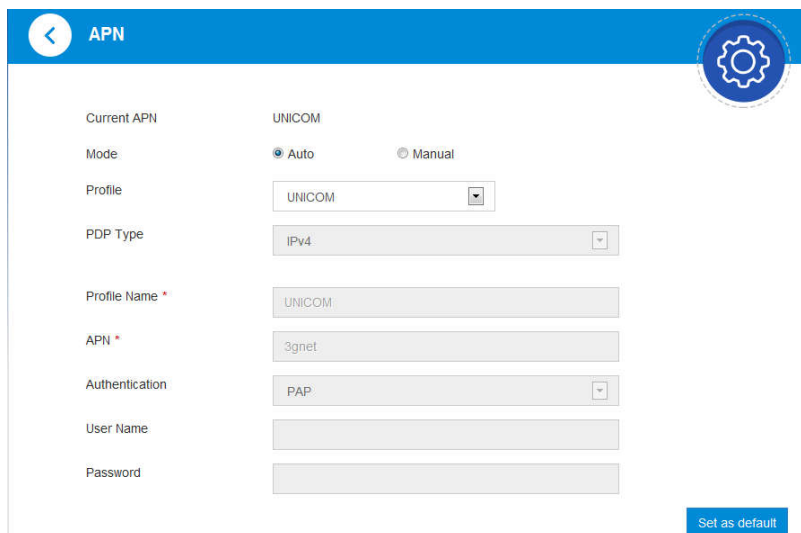

APN

Current APN UNICOM

Mode Auto Manual

Profile UNICOM

PDP Type IPv4

Profile Name * UNICOM

APN * 3gnet

Authentication PAP

User Name

Password

Set as default

Set as default: Click to set current profile as the default profile.

To add a new APN profile, follow the steps below:

1. Select **Manual** mode in the figure above.

The screenshot shows the APN configuration interface. At the top, there is a blue header with a back arrow and the text 'APN'. On the right side of the header is a gear icon. Below the header, the 'Current APN' is 'UNICOM'. The 'Mode' section has two radio buttons: 'Auto' (unselected) and 'Manual' (selected). The 'Profile' dropdown menu is open, showing 'TELUS ISP' selected, with an 'Add New' button to its right. Below this are fields for 'PDP Type' (IPv4), 'Profile Name *' (TELUS ISP), 'APN *' (isp.telus.com), 'Authentication' (NONE), 'User Name', and 'Password'. At the bottom right, there is a 'Set as default' button.

2. Click **Add New** to access the following figure.

This screenshot is similar to the previous one, but the 'Add New' button is now a 'Cancel' button. The 'Profile' dropdown is still set to 'TELUS ISP'. The 'Profile Name *' field is now empty. The 'APN *' field is also empty. The 'Authentication' dropdown is still set to 'NONE'. The 'User Name' and 'Password' fields are empty. At the bottom right, there is an 'Apply' button.

3. Enter the related parameters (please see following table), and then click **Apply** to add a new profile.

Parameter	Function
Mode	If a fixed APN is provided by your service provider, select Manual APN. Otherwise, please select Auto APN, and the device will automatically obtain parameters.
Profile	Shows the profile.
Profile Name	Type the profile name.

APN	Type the APN string.
Authentication	Password Authentication Protocol (PAP) provides a simple method without encryption for the peer to establish its identity using a 2-way handshake. Challenge-Handshake Authentication Protocol (CHAP) is used to periodically verify the identity of the peer using a 3-way handshake.
User Name	User name is used to obtain authentication from the ISP when the connection is established.
Password	Password is used to obtain authentication from the ISP when the connection is established.

Notes:

- The **Profile Name** and **APN** are mandatory, others are optional.
- If the Authentication is set to **NONE**, you don't need to set the User Name and Password.

Advanced Settings

Router

Advanced Settings

Router Firewall Update Others

IP Address * 192.168.0.1

Subnet Mask * 255.255.255.0

DHCP Server Enable Disable

DHCP IP Pool * 192.168.0.100 - 192.168.0.200

DHCP Lease Time * 24 hour(s)

Apply

IP Address: The IP address for this device, as seen from the local network. This is set to a default value.

Subnet Mask: The default value 255.255.255.0 is standard for small (class "C") networks.

DHCP Server: This option is set to Enable by default. The DHCP server allocates an IP address to each Connected Device.

DHCP IP Pool: This is the IP address range used by the DHCP server. This indicates the range of IP addresses which may be allocated to connected devices.

DHCP Lease Time: This specifies the time period (in hours) for how long each device is assigned an internal IP address.

MAC-IP Bind Switch: Select "Enable" to bind IP Address and MAC Address on your device.

MAC Address: The MAC Address is a network identifier. This read-only field displays the MAC Address for the Wi-Fi interface on this device.

IP Address: The IP address for this device, as seen from the local network. This is set to a default value.

Current Bind List: Lists any MAC-IP Bind you have bound.

Firewall

A firewall protects your connected devices against malicious incoming traffic from the Internet. The firewall cannot be disabled, but the following settings are available.

MAC/IP/Port Filtering

You can **Enable** or **Disable** the MAC/IP/Port Filtering feature as needed to block certain Internet traffic. If this setting is enabled, you can then choose whether traffic is **Accepted** or **Dropped** by default by selecting the appropriate option from the Default Policy dropdown.

Default Policy:

Accepted: Internet traffic is allowed by default. Only traffic from the selected applications will be blocked from accessing the Internet. Traffic is identified by port numbers. Some applications are pre-defined. You can define additional applications by clicking the "Add Custom Application" button, but you need to know details of the traffic used and generated by the applications you wish to define. In particular, you need to know the port numbers and the protocol (TCP, UDP) used by outgoing traffic.

Dropped: Internet traffic is blocked by default. Only traffic from the selected pre-defined or custom applications are allowed to access the Internet.

Applications: Use these check boxes to deny or allow access to the Internet for each application, as an exception to the selected Default Policy of accepting or dropping Internet traffic.

To start, click the **Apply**, then provide the following data:

MAC Address: A network identifier unique to each device's hardware.

Source IP Address: The source IP address that traffic will be filtered from.

Destination IP Address: The internal IP address where traffic will be filtered to.

Protocol: You can select from **None/TCP/UDP/ICMP** as the traffic type you would like to filter.

Action: Selecting **Drop** or **Accept** will determine if the rule will allow or block traffic based on the criteria specified.

Comment: Here you will need to add a name or description to the rule in order to click "Apply" to save and implement the rule.

Port Forwarding

Port Forwarding allows for specific external ports on the MF279T to be mapped to specific ports on a specific device on the internal network. You can have a maximum of 10 Port Forwarding/Virtual Server rules in the system.

You can **Enable** or **Disable** Port Forwarding to allow certain devices to act as virtual servers within the internal MF279T network.

If you select **Enable**, the Virtual Server Settings will appear:

IP Address: Enter the internal IP address (i.e. 192.168.1.101) that you would like traffic from a specific external port directed to internally.

Port Range: Enter the starting and ending port numbers that will be directed to the internal device.

Protocol: You may pick **TCP**, **UDP**, or **TCP+UDP** traffic types to be directed.

Comment: Enter a comment or label to be saved with this custom port forwarding rule.

Be sure to click "Apply" to confirm your configuration.

URL Filtering

You can set up content filters to restrict the access to specific websites.

Type the URL address, and then click "Apply" to add the URL address into the filtering list. The new URL filtering item will be shown in the Current Webs URL Filters field.

UPnP

Universal Plug Play (UPnP) is a set of networking protocols that allows network devices, such as PCs, printers, Internet gateways, Wi-Fi access points and mobile devices, to seamlessly discover each other's presence on the network and establish functional network services for data sharing, communications, and entertainment.

Check **Enable** and click "Apply" to enable the function.

DMZ

The DMZ, or De-Militarized Zone, is a selected internal IP address of a device that allows full access and connectivity from outside traffic, through the firewall, to a specific internal device without being filtered or blocked by the MF279T.

DMZ Settings: You may choose to enable or disable the DMZ setting here. DMZ is set to **Disable** by default.

DMZ IP Address: Enter the internal IP address of the desired device that will be directly accessible from outside the firewall.

Update

This screen provides the ability to check new version and auto-check settings.

You can click "Check " to manually check for new software at any time.

Enable Auto-check Settings will set the device to automatically check for updates. You can change the Auto-check Cycle to the desired update schedule. **Disable** Auto-check Settings will set the device to not check for device updates automatically.

Others

You can customize your MF279T by other settings, such as restart and reset the device, PIN management and set the device's time manually or set the device to obtain time from an SNTP server automatically.

Specifications

Dimensions (L×W×H)mm	160 (W) × 160(D) × 33 (H)
Weight	437.0g (including back-up battery)
Back-up Battery	3,000 mAh
Talk time	TBD
Standby time	TBD

Note: The value of the talk time or standby time varies with the actual environment.

Troubleshooting

General

Problem	Possible Solution
None of the LEDs are illuminated	<ul style="list-style-type: none"> Make sure there is AC power to the MF279T. Do not connect to an AC outlet controlled by a wall switch. Slide the ON/OFF button to the ON position on the back of the MF279T until the Power light stays solid green.
Red signal strength indicator	<ul style="list-style-type: none"> Move your device to another area with sufficient network signal (Green or Blue Signal Strength light).
Blinking Red signal strength indicator	<ul style="list-style-type: none"> nano-SIM card is missing or not installed properly. <ol style="list-style-type: none"> Remove the bottom of the device and back-up battery. Locate the nano-SIM card slot and insert the nano-SIM card into the slot until secure. The nano-SIM card will click and lock in place when properly installed in the correct orientation. nano-SIM card may be invalid or damaged and need to be replaced. For a replacement nano-SIM card, take your MF279T to your local AT&T store..
nano-SIM Card doesn't work in my mobile device	The nano-SIM card provided with your MF279T is intended for use only in your specific MF279T and cannot be used in a mobile handset.

Phone

Problem	Possible Solution
No dial tone	<ul style="list-style-type: none"> Make sure there is AC power to the MF279T. Do not connect to an AC outlet controlled by a wall switch. Make sure your MF279T is powered on. Slide the ON/OFF button to the ON position until the Power light stays solid green. Make sure your cordless phone has power and is connected properly to the MF279T. Move the MF279T to an area with sufficient network signal (Blue or Green Signal Strength light).

Caller Number ID only	<ul style="list-style-type: none"> • Like all wireless services, only the calling number is displayed with Caller ID. • Your home phone may support the display of names stored in its contacts memory.
My answering machine won't pick up calls	<ul style="list-style-type: none"> • Set your answering machine settings to pick up calls before network voicemail, which is approximately four (4) rings.
Poor voice quality	<ul style="list-style-type: none"> • Use the phone cable included with the MF279T. • Make sure all connections are firmly in place. • Move your MF279T to an area with sufficient network signal (Blue or Green Signal Strength light). • Increase the distance away from other electronic devices and the MF279T (including cordless base stations, Wi-Fi routers, and cell phones). • Move the MF279T near a window with a clear unobstructed view of the sky and remove any objects that may be obstructing the wireless signal. • Make sure the home phone that is connected to the MF279T is of good quality and in good working order. • Voice quality may degrade with a low battery charge. Connect to an AC power source to recharge when power is available.
Message Waiting indicator on my home phone doesn't light.	<ul style="list-style-type: none"> • The MF279T does not support this functionality with your home phone. • The MF279T has a dedicated voicemail light that will blink when you have a new voice message; you will also hear an intermittent dial tone when you pick up your handset.
I hear an intermittent dial tone	<ul style="list-style-type: none"> • You will hear an intermittent dial tone when you have a new voicemail message waiting. • Dial 1 from your home phone that is connected to the MF279T to listen to your voice messages.
My phone doesn't ring when a call comes in	<ul style="list-style-type: none"> • If you recently transferred your landline phone number, you will continue to receive incoming calls on your previous service until the transfer is complete. • Make sure your MF279T is NOT connected to your in-home phone wiring. • Make sure your home phone is powered on and connected to the MF279T. • Your MF279T number may be set to Call Forward. Dial #21# to un-forward calls.
I hear a constant low frequency tone	<ul style="list-style-type: none"> • Hang up your home phone to restore dial tone.

(not dial tone) when I try to place a call	
--	--

Internet

Problem	Possible Solution
Can't access the Internet	<ul style="list-style-type: none"> • Make sure your MF279T is powered on. Slide the ON/OFF button to the ON position until the Power light stays solid green. • For Wi-Fi: Make sure your MF279T is located in the general area of your Wi-Fi enabled device(s). Check that your device is connected to the MF279T Wi-Fi network (e.g. ZTE MF279T/2.4GXXXX) and you are using the correct Wi-Fi Password. For Ethernet: Make sure the Ethernet cable is securely inserted into the Ethernet port on the back of the MF279T and your computer (or other device). • Move the MF279T to an area with sufficient network signal (Green or Blue Signal Strength light). • Make sure the Wi-Fi light is on. If not, maybe in sleep mode. You can restart your MF279T, press the WPS button or charging to wake up. • Check the following on the MF279T Manager (http://telus.ztesmarthub)
Download or upload speeds are slow	<ul style="list-style-type: none"> • Check your signal strength light. If not green or blue, choose an alternate location. • Other connected devices may be transferring a large amount of data. To view and block other connected devices, go to the MF279T Manager (http://telus.ztesmarthub). • A phone call in progress may slow down the data speed. • Check your wireless network connection using the MF279T Manager (http://telus.ztesmarthub). 4G LTE offers the fastest data speeds and if available, the MF279T should be located in a covered area.
The MF279T Network does not appear in the wireless network list	<ul style="list-style-type: none"> • Make sure the MF279T is powered on. Power light should be solid green/blue if connected to a power outlet (or blinking green if on back-up battery). • Refresh the network list on the device you are trying to connect. • Restart your MF279T: Slide the ON/OFF button to the OFF position until all lights turn off. Then, Slide the ON/OFF button to the ON position until the power light stays solid green.
Can't connect to my MF279T Home Base	<ul style="list-style-type: none"> • Check that you are connecting to your MF279T Wi-Fi network name (SSID) (e.g. ZTE MF279T/2.4GXXXX). If connected via Ethernet, make sure the Ethernet cables are firmly attached. • Make sure you entered the correct Wi-Fi password found on the bottom of your device or your customized password, if you changed it.

Can't access the MF279T Manager	<ul style="list-style-type: none"> • Make sure you are trying to access on a device that is currently connected to your MF279T either via Wi-Fi or Ethernet connection. • Make sure you have entered the correct URL (http://telus.ztesmarthub or http://192.168.0.1) directly into your browser address field on your connected device. • Make sure you have entered the correct login, either "admin" or your customized login. If you changed the login and forgot it, you will need to restore the device to the factory default settings. Remove the bottom cover of your device and using a ballpoint pen, press and hold the RESET button for five (8) seconds. You may then log in using the default login "admin."
---------------------------------	---

Safety Instructions

- Some electronic devices may be susceptible to electromagnetic interference. Locate the router away from TV set, radio and other electronic equipment to avoid electromagnetic interference.
- The router may interfere with medical devices like hearing aids and pacemakers. Consult a physician or the manufacturer of the medical device before using the router.
- Please keep yourself at least eight (8) inches away from router.
- Do not use your router in dangerous environments such as oil terminals or chemical factories where there are explosive gases or explosive products being processed.
- Please use original accessories or accessories that are authorized by ZTE. Unauthorized accessories may affect the router performance, damage the router or cause danger to you.
- Do not attempt to dismantle the router. There are no user serviceable parts.
- Do not allow the router or accessories to come into contact with liquid or moisture at any time. Do not immerse the router in any liquid.
- Do not place objects on top of the router. This may lead to overheating of the device.
- The device must be placed in ventilated environment for use.
- Do not expose the router to direct sunlight or store it in hot areas. High temperature can shorten the life of electronic devices.
- Do not allow children to play with the router or charger.
- Keep the length of the cable between the router and the phone less than 11 yards.
- The router is for indoor use only. Do not use the router outside. Do not connect telephone extensions which run outside of the building. These can result in lightning damage to your unit.

Radio Frequency (RF) Exposure

Your device contains a transmitter and a receiver. When it is ON, it receives and transmits RF energy. When you communicate with your device, the system handling your connection controls the power level at which your device transmits.

Important safety information regarding radiofrequency radiation (RF) exposure. To ensure compliance with RF exposure guidelines the device must be used with a separation from the body. Failure to observe these instructions could result in your RF exposure exceeding the relevant guideline limits.

The maxim permissible exposure is defined in 47 CFR Part 2.1091 with 1mW/cm². The transmitter is using external antenna that operate at 20cm or more from nearby persons. The maxim power density is 0.089mW/cm².

The FCC grant can be found under the Display Grant section of <http://www.fcc.gov/oet/fccid> after searching on **FCC ID: SRQ-MF279T**.

FCC Regulations

This device complies with part 15 of the FCC Rules. Operation is subject to the following two conditions:

(1) This device may not cause harmful interference, and (2) this device must accept any interference received, including interference that may cause undesired operation.

This device has been tested and found to comply with the limits for a Class B digital device, pursuant to Part 15 of the FCC Rules. These limits are designed to provide reasonable protection against harmful interference in a residential installation. This equipment generates, uses and can radiate radio frequency energy and, if not installed and used in accordance with the instructions, may cause harmful interference to radio communications. However, there is no guarantee that interference will not occur in a particular installation. If this equipment does cause harmful interference to radio or television reception, which can be determined by turning the equipment off and on, the user is encouraged to try to correct the interference by one or more of the following measures:

- Reorient or relocate the receiving antenna.
- Increase the separation between the equipment and receiver.
- Connect the equipment into an outlet on a circuit different from that to which the receiver is connected.
- Consult the dealer or an experienced radio/TV technician for help.

Changes or modifications not expressly approved by the party responsible for compliance could void the user's authority to operate the equipment.

IC

This radio transmitter (identify the device by certification number, or model number if Category II) has been approved by Industry Canada to operate with the antenna types listed below with the maximum permissible gain and required antenna impedance for each antenna type indicated. Antenna types not included in this list, having a gain greater than the maximum gain indicated for that type, are strictly prohibited for use with this device.

Immediately following the above notice, the manufacturer shall provide a list of all antenna types approved for use with the transmitter, indicating the maximum permission antenna gain (in dBi) and required impedance for each.

ISED Notice

This device complies with Innovation, Science and Economic Development Canada license-exempt RSS standard(s). Operation is subject to the following two conditions:

- (1) this device may not cause interference, and
- (2) this device must accept any interference, including interference that may cause undesired operation of the device.

Le présent appareil est conforme aux CNR Innovation, Sciences et Développement économique Canada applicables aux appareils radio exempts de licence. L'exploitation est autorisée aux deux conditions suivantes:

- (1) l'appareil ne doit pas produire de brouillage, et
- (2) l'utilisateur de l'appareil doit accepter tout brouillage radioélectrique subi, même si le brouillage est susceptible d'en

This Class B digital apparatus complies with Canadian ICES-003.

Cet appareil numérique de la classe B est conforme à la norme NMB-003 du Canada.

IC : 5200E-MF279T

ISED RF Exposure Statement

This device complies with ISED RSS-102 RF exposure limits set forth for an uncontrolled environment. In order to avoid the possibility of exceeding the IC RSS-102 RF exposure limits, human proximity to the antenna shall not be less than 20cm (8 inches) during normal operation.

Cet appareil est conforme aux limites d'exposition aux rayonnements de la CNR-102

définies pour un environnement non contrôlé. Afin d'éviter la possibilité de dépasser les limites d'exposition aux fréquences radio de la CNR-102, la proximité humaine à l'antenne ne doit pas être inférieure à 20 cm (8 pouces) pendant le fonctionnement normal.

CTIA

- Do not disassemble or open, crush, bend or deform, puncture or shred.
- Do not modify or remanufacture, attempt to insert foreign objects into the battery, immerse or expose to water or other liquids, expose to fire, explosion or other hazard.
- Only use the battery for the system for which it is specified.
- Only use the battery with a charging system that has been qualified with the system per CTIA Certification Requirements for Battery System Compliance to IEEE 1725. Use of an unqualified battery or charger may present a risk of fire, explosion, leakage, or other hazard.
- Do not short circuit a battery or allow metallic conductive objects to contact battery terminals.
- Replace the battery only with another battery that has been qualified with the system per this standard, IEEE-Std-1725. Use of an unqualified battery may present a risk of fire, explosion, leakage, or other hazard.
- Promptly dispose of used batteries in accordance with local regulations.
- Battery usage by children should be supervised.
- Avoid dropping the phone or battery. If the phone or battery is dropped, especially on a hard surface, and the user suspects damage, take it to a service center for inspection.
- Improper battery use may result in a fire, explosion, or other hazard.

For those host devices that utilize a USB port as a charging source, the host device's user manual shall include a statement that the phone shall only be connected to CTIA certified adapters, products that bear the USB-IF logo or products that have completed the USB-IF compliance program.

Warranty

ZTE offers you a limited warranty that the enclosed subscriber unit and its enclosed accessories will be free from defects in material and workmanship for a period that expires one (1) year from the date of sale of the Product to you, provided that you are the original end-user purchaser of the Product and provided that your purchase was made from a supplier authorized by the Seller. Transfer or resale of a Product will automatically terminate warranty coverage with respect to that Product. This limited warranty is not transferable to any third party, including but not limited to any subsequent purchaser or owner of the Product. This limited warranty is applicable only to end users in the United States.

This product or phone is warranted for 12 months from date of purchase.

For warranty service information, please call ZTE service number (877) 817-1759

(toll-free). The manufacturer's website, <http://www.zteusa.com>, is also available for assistance.

This warranty only applies if the product has been used in accordance with the manufacturer's instructions under normal use and with reasonable care.

What this warranty does not cover:

- a) Defects or damages resulting from the misuse of this product.
- b) Defects or damages from abnormal use, abnormal conditions, improper storage, exposure to moisture, dampness or corrosive environments, unauthorized modifications, unauthorized repair, neglect, rough handling, abuse, accident, alteration, improper installation, incorrect voltage application, food or liquid spoilage, acts of God.
- c) Normal wear and tear.
- d) If the Product has been opened, modified or repaired by anyone other than a warranty service center or if it is repaired using unauthorized spare parts.
- e) If the serial number or mobile accessory date code has been removed, erased, defaced, altered, or are illegible in any way subject to sole judgment of ZTE.

LIMITED WARRANTY

TO THE EXTENT PERMITTED BY APPLICABLE LAW, THIS LIMITED WARRANTY IS YOUR SOLE AND EXCLUSIVE REMEDY AGAINST ZTE AND ZTE'S SOLE AND EXCLUSIVE LIABILITY IN RESPECT OF DEFECTS IN PRODUCT. HOWEVER, THIS LIMITED WARRANTY SHALL NOT EXCLUDE NOR LIMIT ANY OF YOUR LEGAL (STATUTORY) RIGHTS UNDER THE APPLICABLE NATIONAL LAWS.

TO THE EXTENT PERMITTED BY APPLICABLE LAW ZTE DOES NOT ASSUME ANY LIABILITY FOR LOSS OF OR DAMAGE TO OR CORRUPTION OF DATA, FOR ANY LOSS OF PROFIT, LOSS OF USE OF PRODUCTS OR FUNCTIONALITY, LOSS OF BUSINESS, LOSS OF REVENUES OR LOSS OF ANTICIPATED PROFIT, INCREASED COSTS OR EXPENSES OR FOR ANY INDIRECT, OR SPECIAL OR CONSEQUENTIAL LOSS OR DAMAGE. TO THE EXTENT PERMITTED BY APPLICABLE LAW, ZTE'S LIABILITY SHALL BE LIMITED TO THE PURCHASE VALUE OF THE PRODUCT. THE ABOVE LIMITATIONS SHALL NOT APPLY TO DEATH OR PERSONAL INJURY CAUSED BY DEFECT OF PRODUCT IN MATERIAL, DESIGN, AND WORKMANSHIP.

LEGAL INFORMATION

Copyright © 2017 ZTE CORPORATION.

All rights reserved.

No part of this publication may be excerpted, reproduced, translated or utilized in any form or by any means, electronic or mechanical, including photocopying and microfilm, without the prior written permission of ZTE Corporation.

The manual is published by ZTE Corporation. We reserve the right to make modifications on print errors or update specifications without prior notice.

Version No. : R1.0

Edition Time: November13,2017