

MF288

User Guide

ZTE CORPORATION
NO. 55, Hi-tech Road South, ShenZhen, P.R.China
Postcode: 518057
Tel: +86-755-26779999
URL: www.ztedevice.com
E-mail: mobile@zte.com.cn

LEGAL INFORMATION

Copyright © 2017 ZTE CORPORATION.

All rights reserved.

No part of this publication may be excerpted, reproduced, translated or utilized in any form or by any means, electronic or mechanical, including photocopying and microfilm, without the prior written permission of ZTE Corporation.

The manual is published by ZTE Corporation. We reserve the right to make modifications on print errors or update specifications without prior notice.

Version No. : R1.0
Edition Time: August 09, 2017

Contents

Getting Started	1
Appearance.....	1
Indicators.....	2
Installation Guide	3
Installing the nano-SIM Card and battery.....	3
Connecting Your Device.....	4
Switching on Your Device.....	4
About nano-SIM Card.....	4
Internet Access	5
Wireless Connection	5
Accessing the Internet.....	6
Calling.....	7
Making a Call.....	7
Three-Way Calling.....	7
Call Waiting	7
Call Forwarding	8
Voicemail.....	9
Setup.....	9
Message Waiting.....	9
Retrieving Messages	9
WebUI Configuration	10
Accessing the Configuration Page.....	10
Login	10
Settings.....	10
Network Settings.....	10
Wi-Fi Settings	14
Router Settings.....	16
Firewall	17
Update Management	23
Device Settings	23
Information.....	25
Detail Information.....	25
Data management.....	26
SMS.....	27
Operating Messages in Native	27
Operating Messages in nano-SIM Card.....	28
Warning and Notice	29
Safety Precautions.....	29
Cleaning and Maintaining.....	29
Limited Warranty.....	30
Limitation of Liability.....	30
FCC Compliance.....	30
RF Exposure.....	31
RF Exposure Information.....	31

ISED Notice	31
Troubleshooting	32

Getting Started

The device operates on UMTS/HSPA/LTE networks and supports voice and data services.



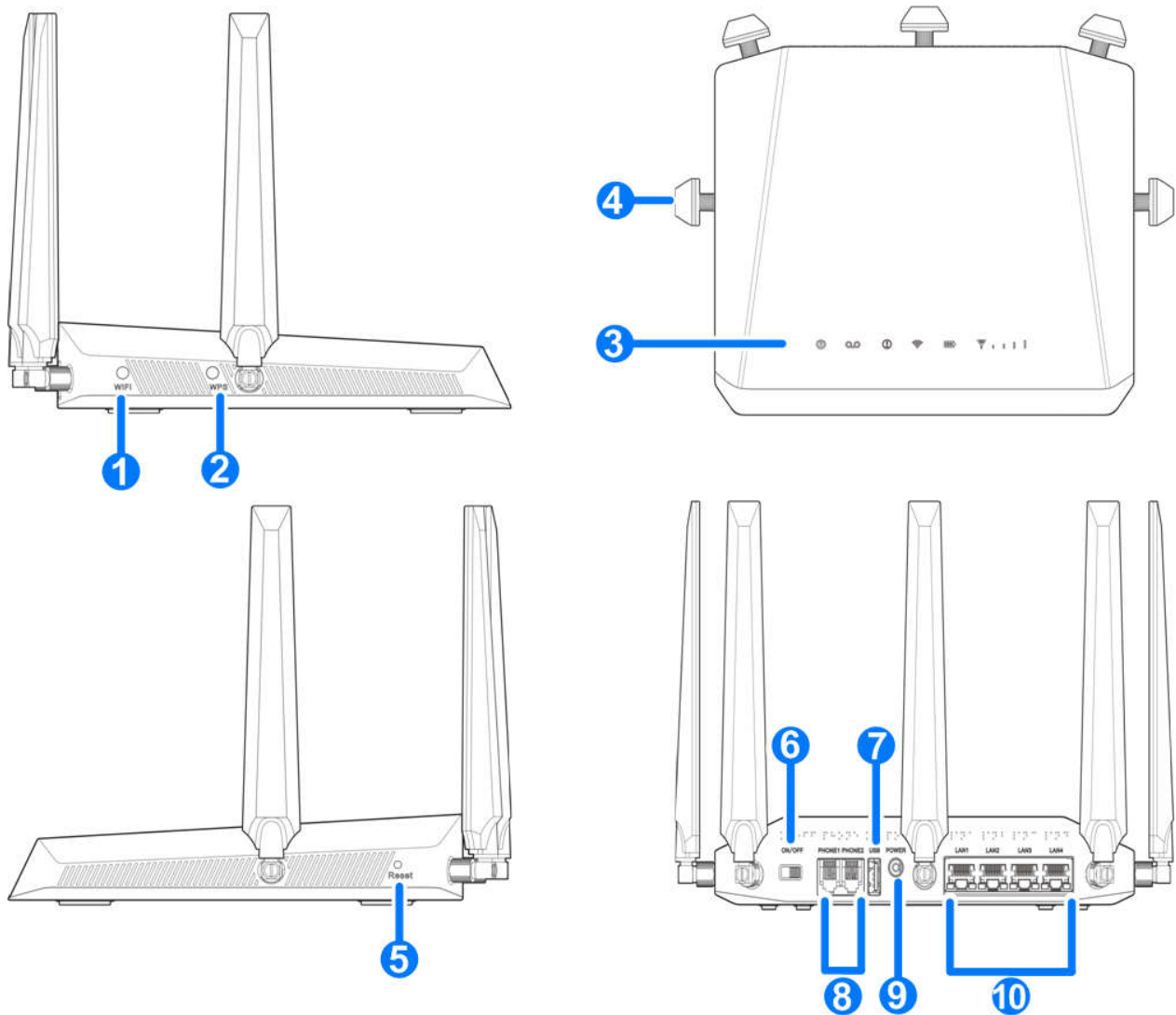



Appearance



1. Wi-Fi button	Turn Wi-Fi function on or off.
2. WPS button	To activate the WPS function.
3. Indicators	Indicates the status of your device.
4. External antenna	To strengthen signal.
5. Reset button	Reset your device.
6. Power Switch	Turn your device on or off.
7. USB	USB storage port.
8. Phone	RJ11 connector for connection to telephone.
9. Power Socket	Connector for the external power supply.

10. LAN	RJ45 Ethernet connector for connection to computer.
---------	---

Indicators

Indicator	State	Description
Power 	Green steady	Power on.
	Green blinking	Power save
	Off	Power off
Voicemail 	Green blinking	New voicemail waiting
	Off	No new voicemail
Information 	Green steady	New information(Unread SMS & FOTA update)
	Green Blinking	Inbox is full
	Off	No new information
Wi-Fi 	Green steady	Wi-Fi on
	Green Blinking	Active data connection or FOTA upgrading
	Off	Wi-Fi off
Battery 	Green steady	Between 100% and 11% discharging (charger not present)
	Green blinking	Charging (charger present)
	Red steady	Less than 10% discharging(charger not present)
	Off	Battery not present
Network 	Green steady	Connected to the LTE network
	Green blinking	Roaming (LTE network)
	Blue steady	Connected to the UMTS or HSPA network
	Blue blinking	Roaming (UMTS or HSPA network)
	Red steady	No service, limited service, no SIM Card or other abnormal status

Installation Guide

Installing the nano-SIM Card and battery

1. Slide the back cover and remove it

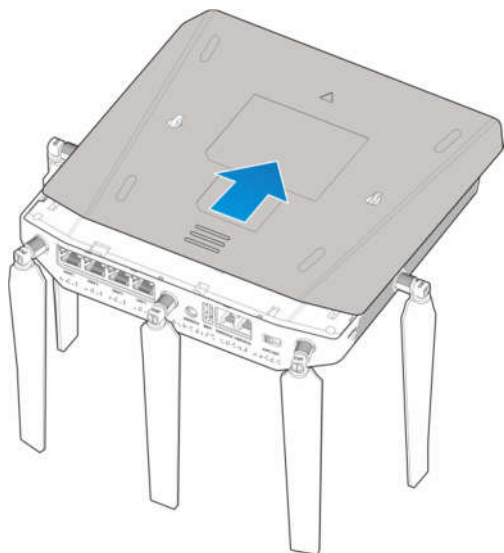

2. Install the nano-SIM Card.

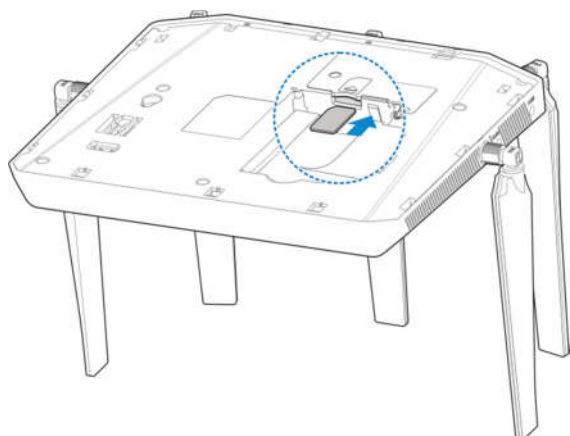

WARNING!

- Switch off your device before installing or replacing the nano-SIM card.
 - Only 4FF nano-SIM card is supported for use in this device.
 - To avoid damaging the device, please only use the card that is provided by your service provider and ensure that the nano-SIM card contacts are facing down when inserting it into the nano-SIM slot.
3. Insert the battery and close the back cover.

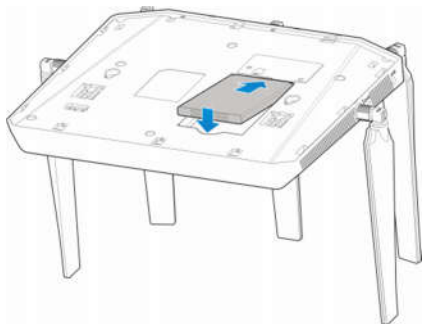

Connecting Your Device

Please refer to the below picture before connecting to your device. If you want to use the mobile network to connect to the Internet or use your land line phone, you will need to insert your nano-SIM card first.

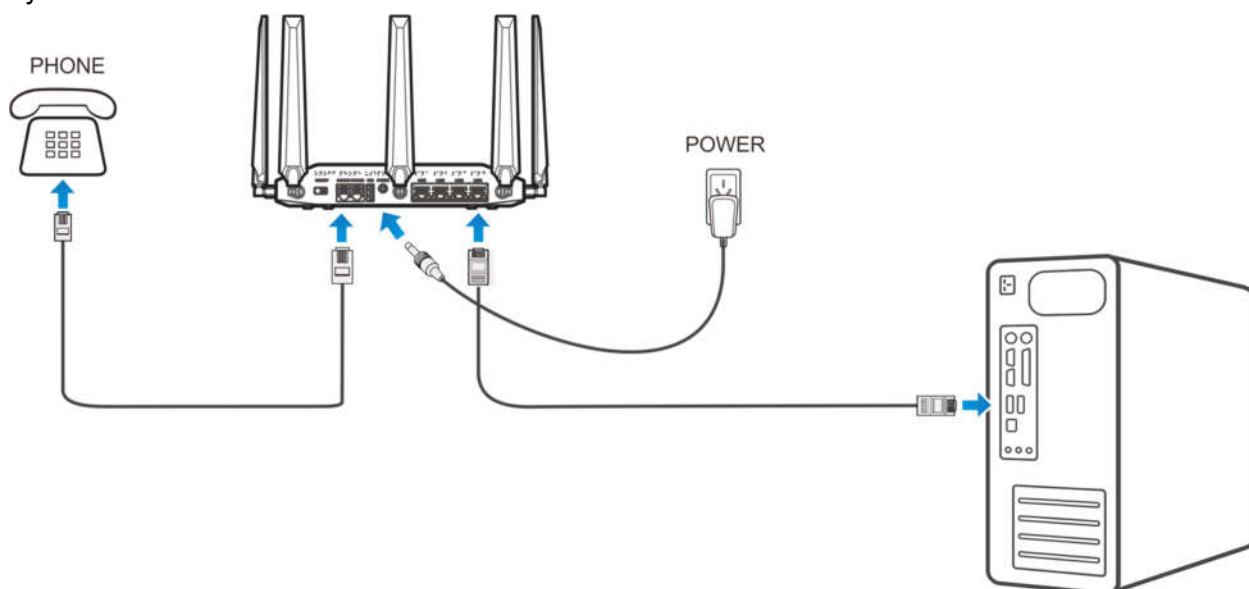

Switching on Your Device

Flip on the Power Switch to get started. Make sure that the phone is on the hook before you power on.

NOTE:

Do not put anything on the top of the device. Do not stack multiple devices on top of each other during usage.

About nano-SIM Card

Avoid handling the nano-SIM card unnecessarily. Hold the card by the edges to prevent static damage. Keep the nano-SIM card away from electrical and magnetic appliances.

If you cannot get service, make sure that:

- You are in an area which has network coverage

- The antennae are firmly attached to the device
- You are using the correct nano-SIM card

Internet Access

Wireless Connection

If you want to use Wi-Fi to connect to your MF288, please refer to the following steps.

1. Make sure that Wi-Fi is enabled. Please check the Wi-Fi Setting on the WebUI Configuration page or check the Wi-Fi indicator .

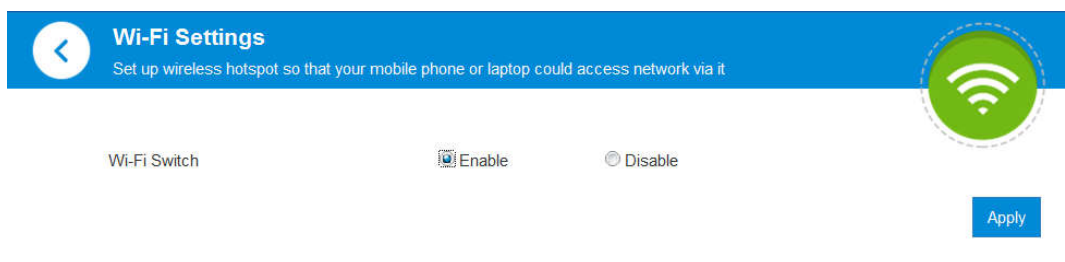

2. Use your normal Wi-Fi application on the client to search for available wireless networks.



NOTE:

Please set the client to use DHCP to obtain an IP address automatically, and the client will get an IP address like “192.168.0.1”.

3. Select the SSID (wireless networks name) of your device, and then click **Connect**.

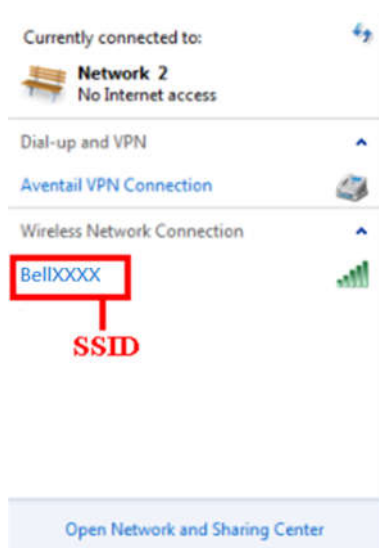

4. Input the password, and then click **OK**.

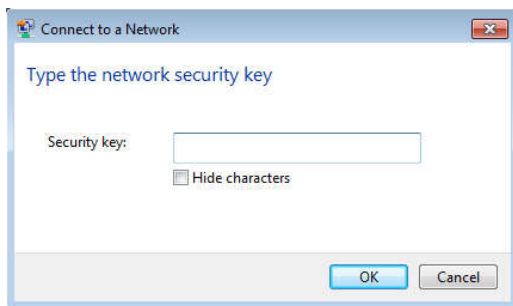

 **NOTE:**

You may need to input a password for the Wi-Fi connection. Please check the label on your MF288 to get the default password.

5. After a few moments, the client will connect to your MF288.

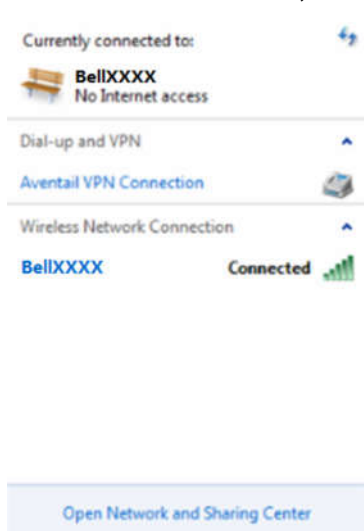

If you want to use **WPS** function to enable a Wi-Fi connection, please:

1. Power on your device, and enable the Wi-Fi function on your device.
2. Please check that the **WPS** Setting on the WebUI Configuration page in enabled.
3. Press the **WPS** button on your device to start the Wi-Fi Protected Setup authentication process.
4. Enable the **WPS** function on your client device.
5. Follow the system prompts on your client to finish the connection process.

Accessing the Internet

After the client is connected to your device successfully, you can access the Internet in the **Automatic** or **Manual** mode. The default mode is **Automatic**.

Mode	Operations
Automatic	Your device will connect to the Internet automatically.
Manual	1. Log in the WebUI configuration page.

	<ol style="list-style-type: none">2. Select Settings > Connection Mode > Manual, and then click Apply.3. Select Home, and then click Connect or Disconnect.
--	---

 **NOTE:**

If you want to modify the detailed parameters of your device, please log into the WebUI configuration page by visiting <http://192.168.0.1> or <http://setup.zte>. The default password is **admin**.

Calling

Making a Call

Using a phone connected to your device allows you to place and receive calls as you normally would. The device supports both cordless and corded phone dialing methods.

Note: Make sure to dial the 10-digit phone number, including area code.

Three-Way Calling

While on an existing call, press the Flash (or Talk) key on your phone to put the first party on hold. When you hear a dial tone, dial the second party's number (wait up to four seconds).

When the second party answers, press the Flash (or Talk) key again to complete the three-way connection. If the second party does not answer, press the Flash (or Talk) key to end the connection and return to the first party.

 **NOTE:**

If your phone does not have a Flash (or Talk) key, use the off-hook mechanism supported by your phone instead.

Call Waiting

Press *43# or #43# to enable or disable Call Waiting features.

You will hear two tones if someone calls while you are already on a call.

To hold the current call and accept the waiting call, press the Flash (or Talk) key.

You can press the Flash (or Talk) key anytime to switch back and forth between calls.

To end the current call and accept the waiting call, enter "1" and press the Flash (or Talk) key.

To reject (User Busy) the waiting call, enter “0” and press the Flash (or Talk) key.

 **NOTE:**

Your device comes with standard three-way calling and call waiting. Operation of these features will vary depending on your home phone equipment.

If your phone does not have a Flash (or Talk) key, then use the off-hook mechanism supported by your phone.

Call Forwarding

With Call Forwarding you can forward calls to another phone number.

Always forward

1. Press *21* on your connected phone.
2. Dial the 10-digit number to which you wish to forward your calls.
3. Press the “#” key.

(Example: *21*1234567890# forwards your calls to the phone number 123-456-7890)

4. Wait for 3 seconds until you hear a confirmation tone for the forwarding process to complete before hanging up.

 **NOTE:**

To un-forward calls, press #21#, wait for 3 seconds until you hear a confirmation tone for the un-forwarding process to complete before hanging up.

Forward when busy

1. Press *67* on your connected phone.
2. Dial the 10-digit number to which you wish to forward your calls.
3. Press the “#” key.
4. Wait for 3 seconds until you hear a confirmation tone for the forwarding process to complete before hanging up.

NOTE:

 Press #67# to un-forward calls.

Forward when unanswered

1. Press *61* on your connected phone.
2. Dial the 10-digit number to which you wish to forward your calls.
3. Press “#” key.

(Example: *61*1234567890**10# forwards your calls to the phone number 123-456-7890, if you don't answer the calls for 10 seconds.)

4. Wait for 3 seconds until you hear a confirmation tone for the forwarding process to complete before hanging up.

 **NOTE:**

Press #61# to un-forward calls.

Forward when unreachable

1. Press *62* on your connected phone.
2. Dial the 10-digit number to which you wish to forward your calls.
3. Press “#” key.
4. Wait for 3 seconds until you hear a confirmation tone for the forwarding process to complete before hanging up.

 **NOTE:**

Press #62# to un-forward calls.

Voicemail

Your MF288 supports wireless voicemail. Follow the steps below to set up and use your voicemail.

Setup

Dial 1 on any home phone connected to your device and wait for 2~4 seconds to connect to your wireless voicemail. Simply follow the voice prompts to complete setup.

Message Waiting

There are two indicators for a new message waiting: 1) the voicemail indicator ; and 2) an intermittent dial tone.

The voicemail indicator on your device flashes when a voicemail message is waiting. You will also hear an intermittent dial tone on any connected phone handset before placing a call.

Retrieving Messages

To retrieve voice messages, dial 1 on any home phone connected to your device and wait for 7~8 seconds to connect to your wireless voicemail box.

Simply follow the voice prompts to listen to and manage your messages. (Alternately, you may dial your 10-digit home phone number to access your voicemail box.)

WebUI Configuration

Accessing the Configuration Page

1. Make sure the connection between your devices is active (either by cable or WiFi).
2. Launch the Internet browser, and then enter `http://192.168.0.1` (or other IP if you have changed it from the default) or `http://setup.zte` in the address bar.

 **NOTE:**

It is recommended that you use IE (8.0 or later), Firefox (31.0 or later), Opera (23.0 or later), Safari (6.2 or later) or Google Chrome (36.0 or later).

3. The login page will appear as follows.

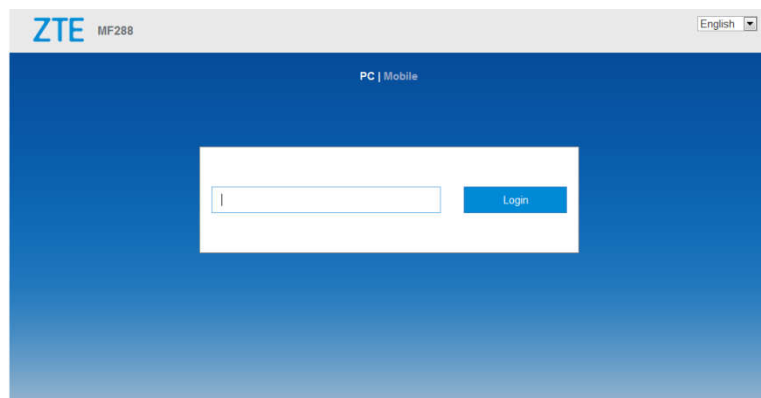

Login

In the WebUI Configuration page, select the desired language and input the password (the default Password is **admin**).

Click **Login** to proceed.

Settings

Do not modify any settings unless instructed by your service provider.

Network Settings

Connection Mode

Select **Settings** > **Connection Mode**.

You can set the connection mode here. The default mode is Automatic.

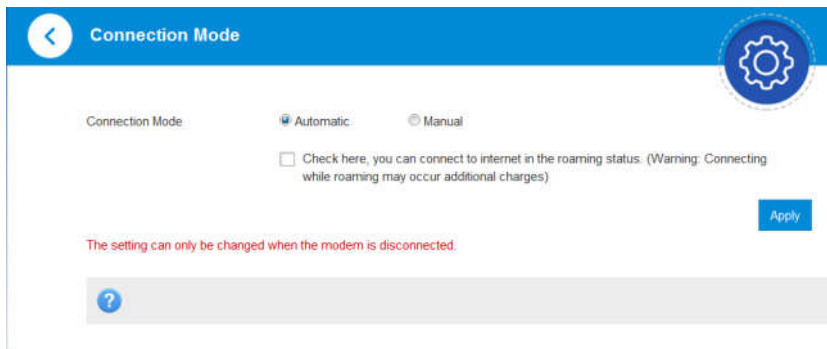

 **NOTES:**

To change the current settings, please disconnect from the cellular network first.

After changing the connection mode to **Manual**, you need to go to the home page and click **Connect** to connect to the Internet.

Network Selection

Select **Settings > Network Selection > Automatic**.

The device will search for the available network automatically.

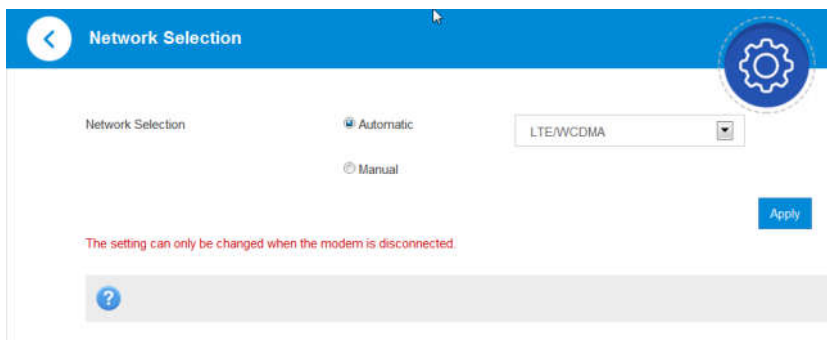

Select **Settings > Network Selection > Manual > Search**, click  to choose a network, and click **Register** to join it.

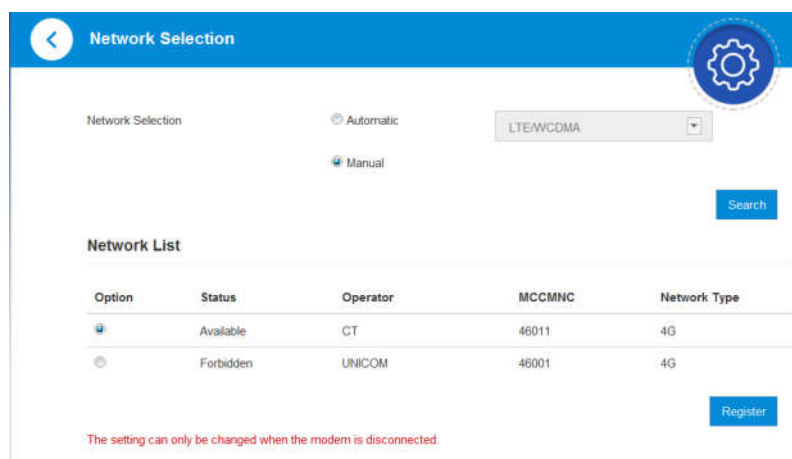

 **NOTE:**

To change the current settings, please disconnect from the cellular network first.

APN Setting

Select **Settings > APN**.

The APN parameters are shown in the following figure.

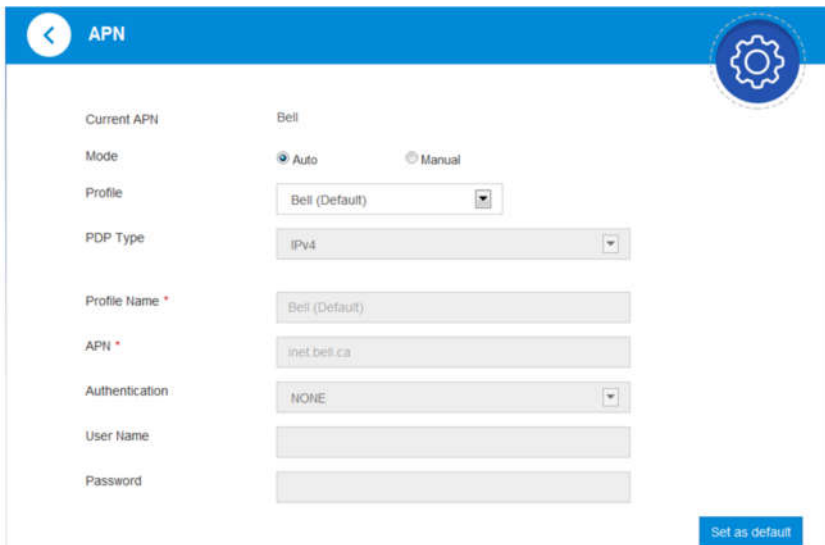

The screenshot shows the APN settings interface. At the top, there is a blue header with a back arrow and the text 'APN'. A gear icon is in the top right corner. The settings are as follows:

- Current APN: Bell
- Mode: Auto Manual
- Profile: Bell (Default) (dropdown menu)
- PDP Type: IPv4 (dropdown menu)
- Profile Name *: Bell (Default) (text field)
- APN *: inet.bell.ca (text field)
- Authentication: NONE (dropdown menu)
- User Name: (text field)
- Password: (text field)

A 'Set as default' button is located at the bottom right of the form.

Set as default: Click to set current profile as the default profile.

To add a new APN profile, follow the steps below:

1. Select **Manual** mode in the figure above.

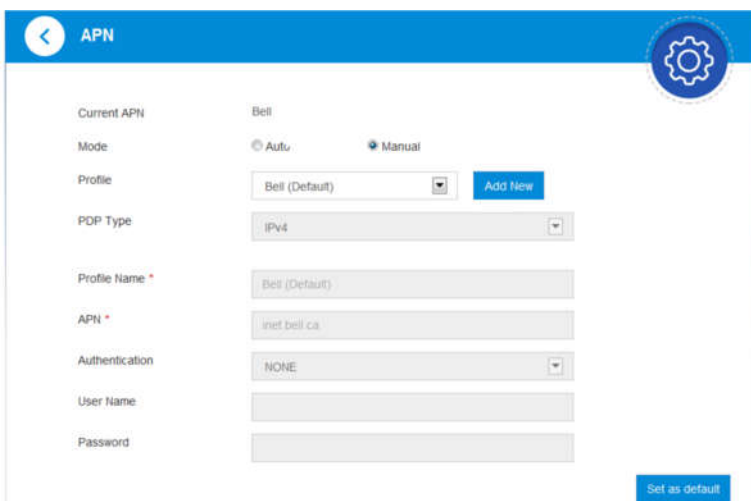

The screenshot shows the APN settings interface with the 'Manual' mode selected. The settings are as follows:

- Current APN: Bell
- Mode: Auto Manual
- Profile: Bell (Default) (dropdown menu) with an 'Add New' button to its right.
- PDP Type: IPv4 (dropdown menu)
- Profile Name *: Bell (Default) (text field)
- APN *: inet.bell.ca (text field)
- Authentication: NONE (dropdown menu)
- User Name: (text field)
- Password: (text field)

A 'Set as default' button is located at the bottom right of the form.

2. Click **Add New** to access the following figure.

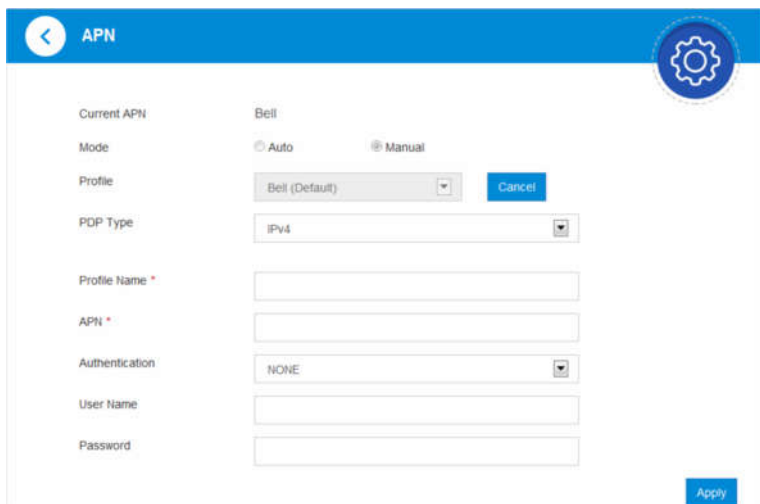

3. Enter the related parameters (please see following table), and then click **Apply** to add a new profile.

Parameter	Function
Mode	If a fixed APN is provided by your service provider, select Manual APN. Otherwise, please select Auto APN, and the device will automatically obtain parameters.
Profile	Shows the profile.
PDP Type	Select PDP type.
Profile Name	Type the profile name.
APN	Type the APN string.
Authentication	Password Authentication Protocol (PAP) provides a simple method without encryption for the peer to establish its identity using a 2-way handshake. Challenge-Handshake Authentication Protocol (CHAP) is used to periodically verify the identity of the peer using a 3-way handshake.
User Name	User name is used to obtain authentication from the ISP when the connection is established.
Password	Password is used to obtain authentication from the ISP when the connection is established.

 **NOTES:**

The **Profile Name** and **APN** are mandatory, others are optional.

If the Authentication is set to **NONE**, you don't need to set the User Name and Password.

Wi-Fi Settings

Basic Settings

Select **Settings > 2.4GHz / 5.0GHz**

The wireless network basic parameters are shown in the following figure.

Wi-Fi Settings
Set up wireless hotspot so that your mobile phone or laptop could access network via it

Wi-Fi Switch Enable Disable Apply

2.4 GHz | 5.0 GHz | WPS

2.4GHz Basic Settings

Access Point Switch Enable Disable

Network Name(SSID) * Broadcast SSID

All the wireless client device is completely isolated

Security Mode

Password * Display Password

Max Station Number Apply

2.4GHz Advanced Settings

Network Mode

Channel Bandwidth

Country/Region Code

Frequency (Channel) Apply

- **Access Point Switch:** Enable or disable 2.4GHz SSID function.
- **Network Name (SSID):** Service Set Identifier (SSID). Enter a string less than 32 characters as the name for your wireless local area network (WLAN).
- **Broadcast SSID:** Disable or Enable (Default) this function. If **Broadcast SSID** is checked, the device broadcasts the SSID, and other devices can search and connect to it. When **Broadcast SSID** is disabled, other devices cannot search out the SSID. If you want someone to connect, you need to tell them the SSID, and let them setup the connection manually.
- **All the wireless client device is completely isolated:** If you check it, your wireless clients will not be able to communicate with each other.
- **Security Mode:** The security modes are described below:

Mode	Description
OPEN	Authentication and encryption won't be active. There are risks that private information can be intercepted or that the network will be used by unauthorized individuals.
WPA2(AES)-PSK	A more secure version of WPA with implementation of the 802.11i standard.
WPA-PSK/WPA2-PSK	Apply both the WPA-PSK and WPA2-PSK schemes.

- **Password:** Set the password for your wireless local area network.
- **Max Station Number:** Choose the maximum number of the devices that can connect to the Wi-Fi hotspot simultaneously.

Click **Apply** to confirm your configuration.

 **NOTE:**

Your device has two Wi-Fi SSIDs, select **Settings > 2.4GHz / 5.0GHz**, and you can set the network mode, channel bandwidth, Frequency (Channel) and other Wi-Fi advanced settings.

WPS

Select **Wi-Fi Settings > WPS**

You can enable Wi-Fi Protected Setup (WPS) by PIN (PIN code) or PBC (push-button) mode; the two modes are described below:

The screenshot shows the WPS configuration interface. At the top, there are three tabs: '2.4 GHz', '5.0 GHz', and 'WPS'. The 'WPS' tab is selected and highlighted in blue. Below the tabs, the interface is divided into two sections: 'WPS(2.4GHz SSID)' and 'WPS(5.0GHz SSID)'. Each section contains a 'WPS *' label, two radio button options: 'PIN' and 'PBC', a text input field, and an 'Apply' button. A blue question mark icon is visible in the top left of the 5.0 GHz section.

- **PIN:** A device will need to provide the specified PIN to connect to the network when using WPS.
- **PBC:** Press the WPS button of the device or select PBC, and then click Apply. Press the WPS button on the client wireless adapter within two minutes, and the negotiation process will be established.

NOTE:

Your device has two WPS selections to configure the two Wi-Fi SSIDs.

Router Settings

Select **Advanced Settings > Router**

The router information is shown in the following figure:

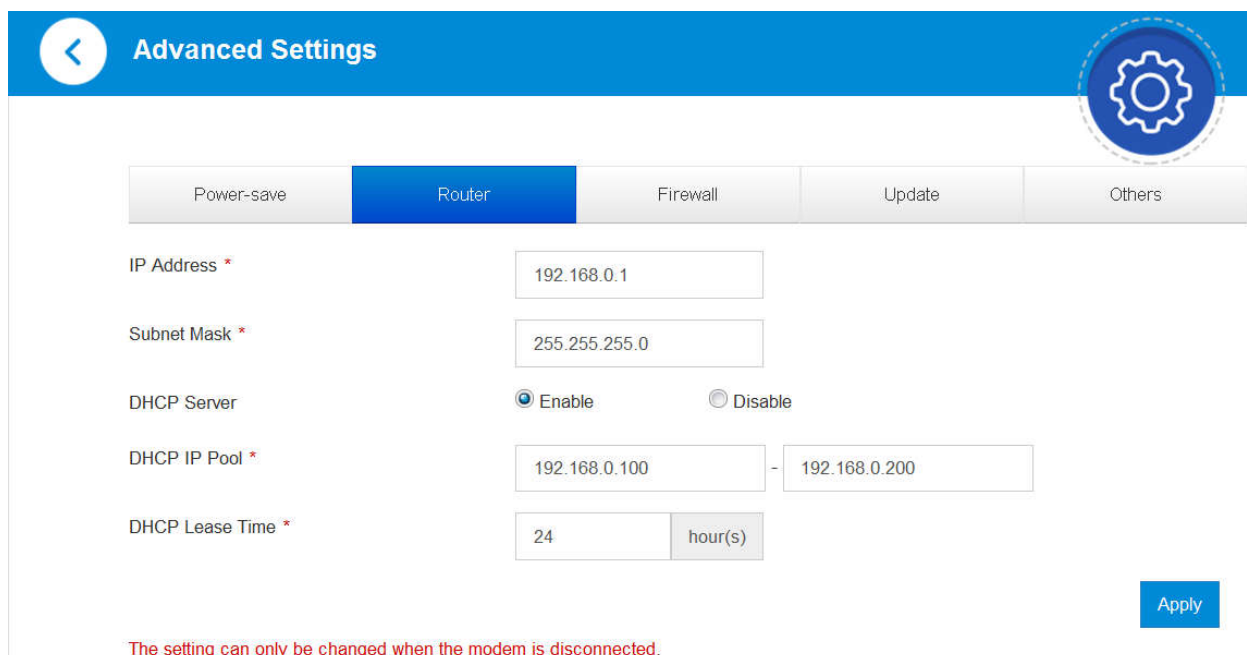

Advanced Settings

Power-save Router Firewall Update Others

IP Address * 192.168.0.1

Subnet Mask * 255.255.255.0

DHCP Server Enable Disable

DHCP IP Pool * 192.168.0.100 - 192.168.0.200

DHCP Lease Time * 24 hour(s)

Apply

The setting can only be changed when the modem is disconnected.

- **IP Address:** IP address for the LAN interface.
- **Subnet Mask:** Subnet mask for the IP address.
- **DHCP Server:** Enable or disable DHCP Server function.
- **DHCP IP Pool:** Allocate begin and end IP address for IP pool.
- **DHCP Lease Time:** Define how long before the leased IP address will expire. The new IP address will be reallocated after the IP address has expired.

Click **Apply** to confirm your configuration.

Firewall

A firewall protects your connected devices against malicious incoming traffic from the Internet. The firewall cannot be disabled, but the following settings are available.

Port Filtering

Select **Advanced Settings > Firewall > Port Filtering**.

The MAC/IP/Port Filtering section is shown in the following figures.

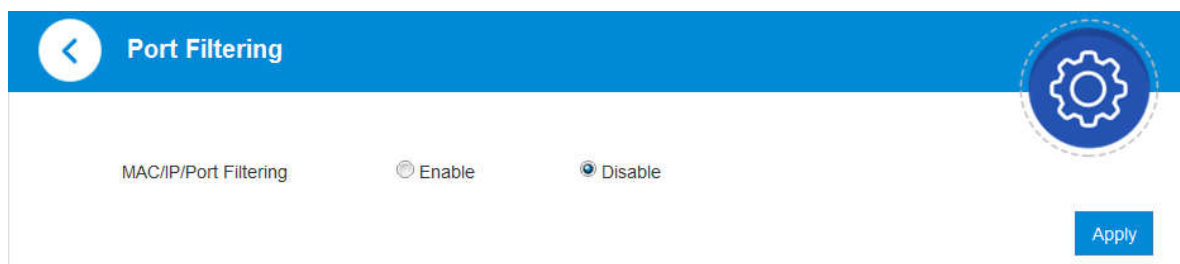

Port Filtering

MAC/IP/Port Filtering Enable Disable

Apply

If you select **Enable**, and click **Apply**, the filter settings will appear as shown below:

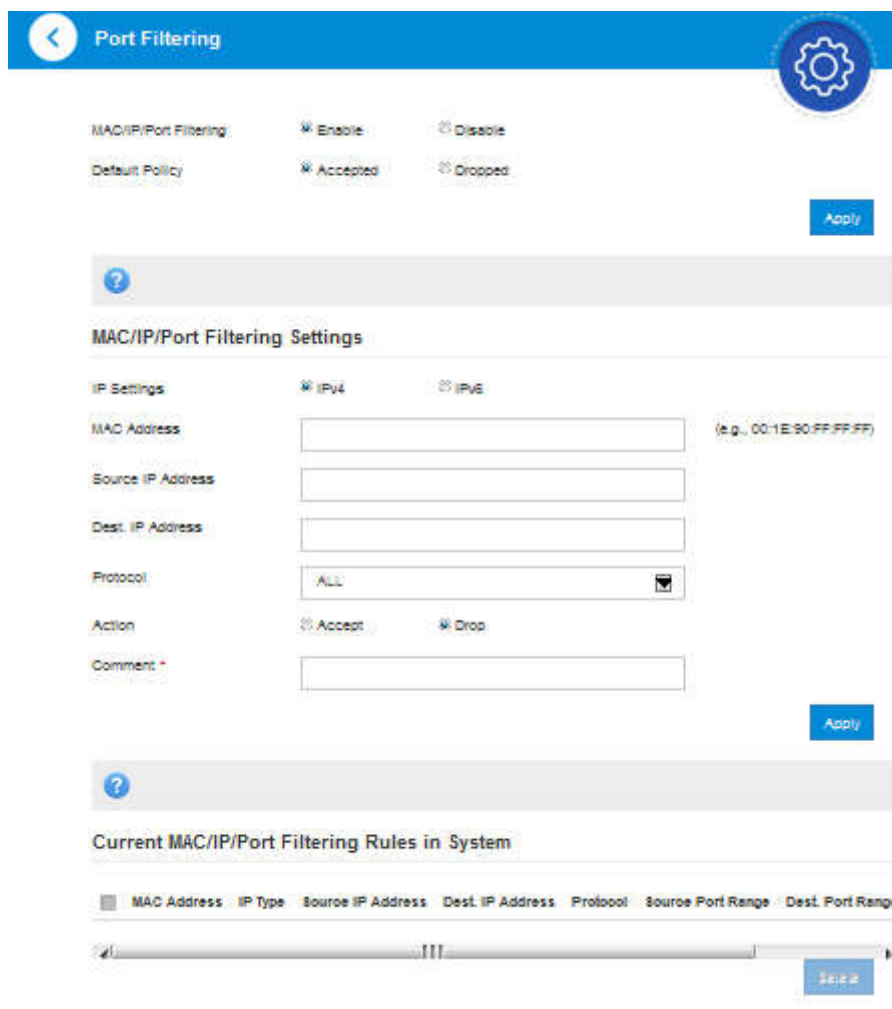

Port Filtering

MAC/IP/Port Filtering: Enable Disable

Default Policy: Accepted Dropped

Apply

MAC/IP/Port Filtering Settings

IP Settings: IPv4 IPv6

MAC Address: (e.g., 00:1E:90:FF:FF:FF)

Source IP Address:

Dest. IP Address:

Protocol: 

Action: Accept Drop

Comment:

Apply

Current MAC/IP/Port Filtering Rules in System

MAC Address	IP Type	Source IP Address	Dest. IP Address	Protocol	Source Port Range	Dest. Port Range

Apply

- **Default Policy:** Set how to handle the packet if none of the rules matches.

Accepted: Internet traffic is allowed by default. Only traffic from the selected applications will be blocked from accessing the Internet. Traffic is identified by port numbers. In particular, you need to know the port numbers and the protocol (TCP, UDP) used by outgoing traffic.

Dropped: Internet traffic is blocked by default. Only traffic from the selected, pre-defined or custom applications is allowed to access the Internet.

- **MAC Address:** Set the MAC address that will be filtered.
- **Source IP Address:** Set the source IP address that will be filtered.
- **Dest. IP Address:** Set the destination IP address that will be filtered.
- **Protocol:** Set which protocol will be used for filtering.
- **Action:** Set how to handle the packet if it matches with the rule.
- **Comment:** Type a comment for the filter settings.

 **NOTE:**

If rules are in conflict with each other, the first to be triggered will determine how that traffic is handled.

Click **Apply** to confirm your configuration.

Click **Delete** to delete the rule which you selected.

To add a new rule:

1. Select **Enable** in the **Port Filtering** area.
2. Click **Apply**.
3. Input the detailed information in the **MAC/IP/Port Filtering Settings** area.
4. Click **Apply** in the **MAC/IP/Port Filtering Settings** area.

Port Forwarding

You can set up virtual servers to provide services on the Internet.

Select **Advanced Settings > Firewall > Port Forwarding**

The virtual server settings is shown in the following figures.

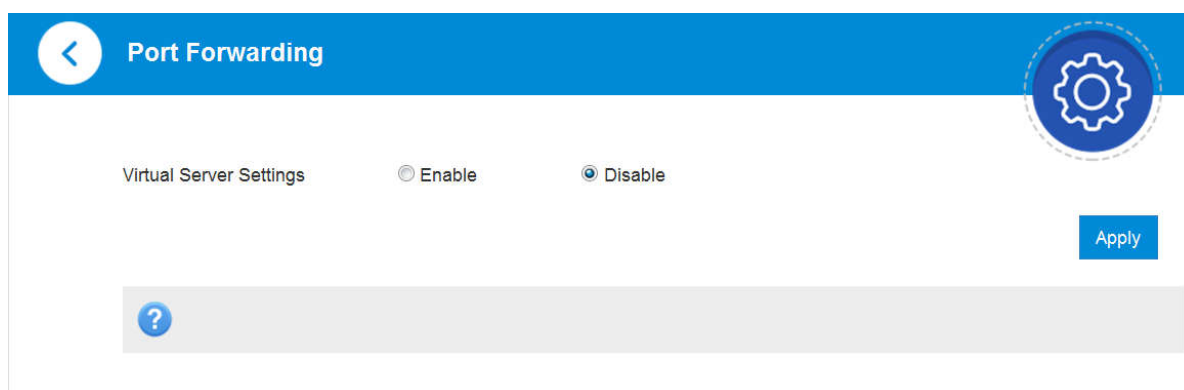

If you select **Enable**, and click **Apply** then the Virtual Server Settings will appear.

Virtual Server Settings Enable Disable Apply

?

Port Forwarding Settings

IP Address * (e.g., 192.168.0.101)

Port Range * - (1-65535)

Protocol ▼

Comment *

Apply

?

Current Virtual Servers in system

<input type="checkbox"/>	IP Address	Port Range	Protocol	Comment
--------------------------	------------	------------	----------	---------

Delete

- **IP Address:** Set the IP address for the virtual server.
- **Port Range:** Set port numbers for the virtual server.
- **Protocol:** Set the protocol for the virtual server.
- **Comment:** Type a comment for the virtual server settings.

Click **Apply** to confirm your configuration.

Click **Delete** to delete the rule which you selected.

To add a new rule:

1. Select **Enable** in the **Port Forwarding** area.
2. Click **Apply**.

3. Input the detailed information in the **Port Forwarding Settings** area.
4. Click **Apply** in the **Port Forwarding Settings** area.

URL Filtering

You can set up content filters to restrict the access to specific websites.

Select **Advanced Settings > Firewall > URL Filtering**

The URL Filtering is shown in the following figure:

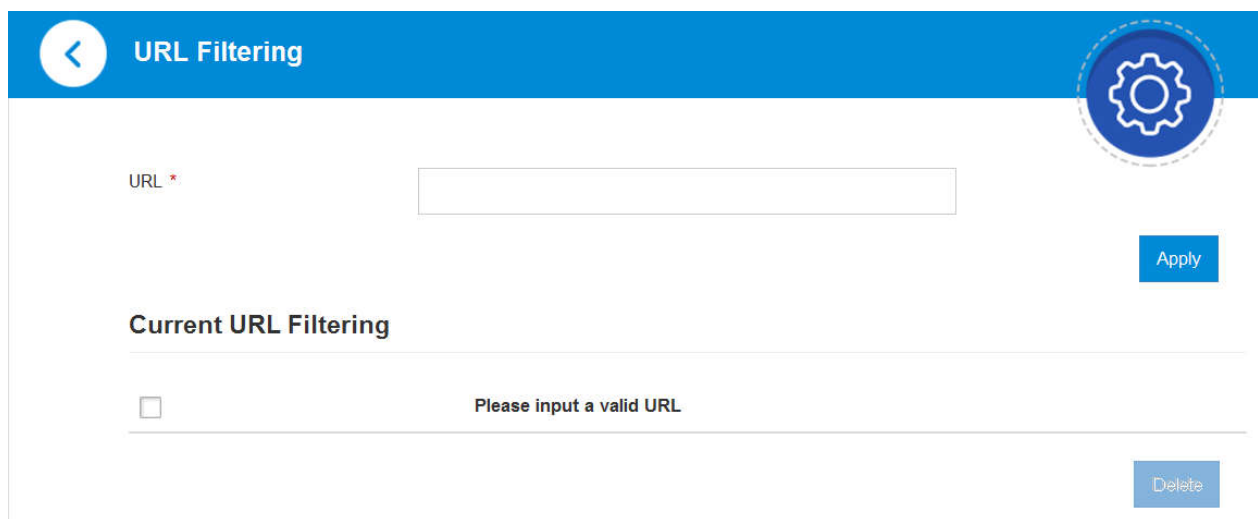

Type the URL address, and then click **Apply** to add the URL address into the filtering list. The new URL filtering item will be shown in the Current Webs URL Filters field.

UPnP

Universal Plug Play (UPnP) is a set of networking protocols that allows network devices, such as PCs, printers, Internet gateways, Wi-Fi access points and mobile devices, to seamlessly discover each other's presence on the network and establish functional network services for data sharing, communications, and entertainment.

Select **Advanced Settings > Firewall > UPnP**

The UPnP settings page is shown in the following figure.

UPnP Settings

Enable Disable

Apply

?

Check **Enable** and click **Apply** to enable the function.

DMZ

The DMZ, or De-Militarized Zone, is a selected internal IP address of a device that allows full access and connectivity from outside traffic, through the firewall, to a specific internal device without being filtered or blocked by your device.

Select **Advanced Settings > Firewall > DMZ** and the following page will appear:

DMZ Settings

Enable Disable

Apply

?

If you select **Enable**, the DMZ Settings will appear:

DMZ Settings

Enable Disable

IP Address *

Apply

Enter the IP address of the device you want to communicate with the Internet unfiltered, and then click **Apply** to save the settings.

Update Management

Select **Advanced Settings > Update**

The update management is shown in the following figure.

Enable will set the device to automatically check for updates. You can change the **Auto-check Cycle** to the desired update schedule. **Disable** will set the device to not check for device updates automatically. You can click the **Check** button to manually check for new software at any time.

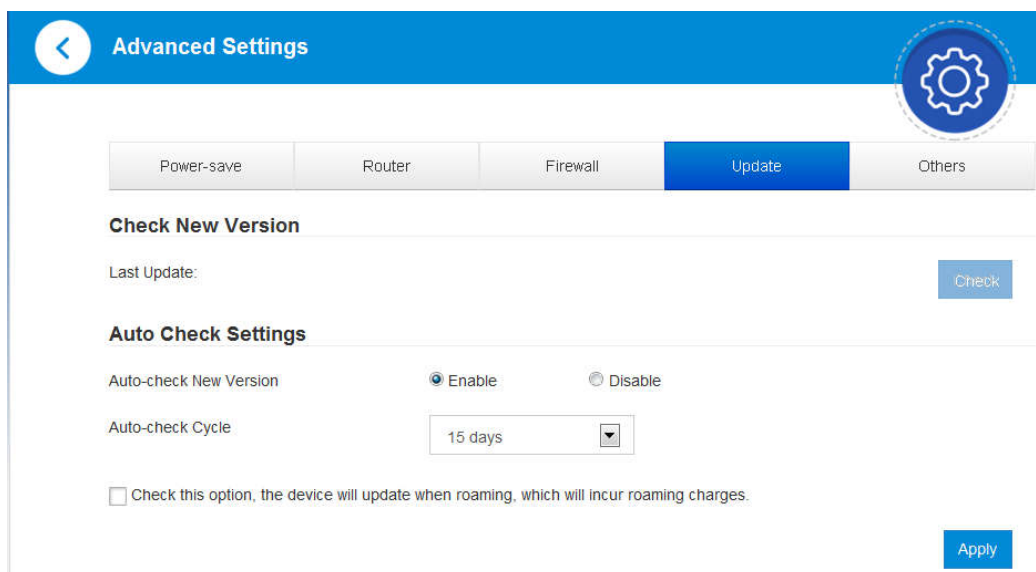

Device Settings

PIN Management

Select **Advanced Settings > Others > PIN Management**.

The PIN management is shown in the following figure.

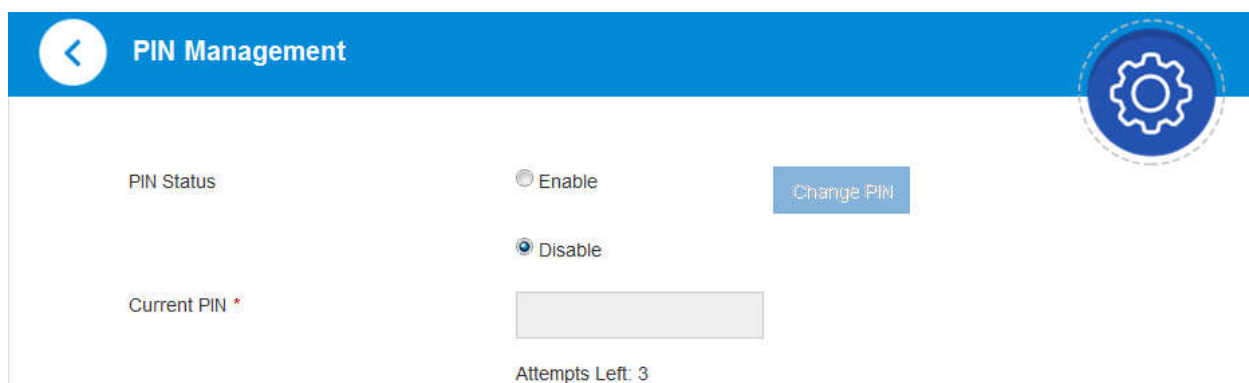

- **PIN Status:** Shows the current PIN status and allows you to select PIN status.
- **Current PIN:** Type the PIN code.

NOTES:

- If you enter the incorrect PIN three times the nano-SIM card will be blocked.
- When you manage your PIN code, you need to disconnect from the network first.
- After changing the PIN code, you don't need to input the PIN code again. The PIN code is required every time the device is restarted.

Reset

Select **Advanced Settings > Others > Reset factory settings** to set all the settings to their factory default values, and then the device will restart automatically.

Restart

Select **Advanced Settings > Others > Restart Device** to restart your device manually.

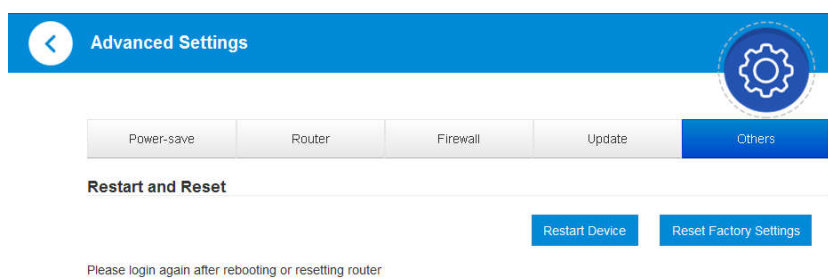

SNTP

Select **Advanced Settings > Others > SNTP**

You can set the device's time manually or set the device to obtain time from an SNTP server automatically. The default time set mode is **Sntp auto Synchronization**.

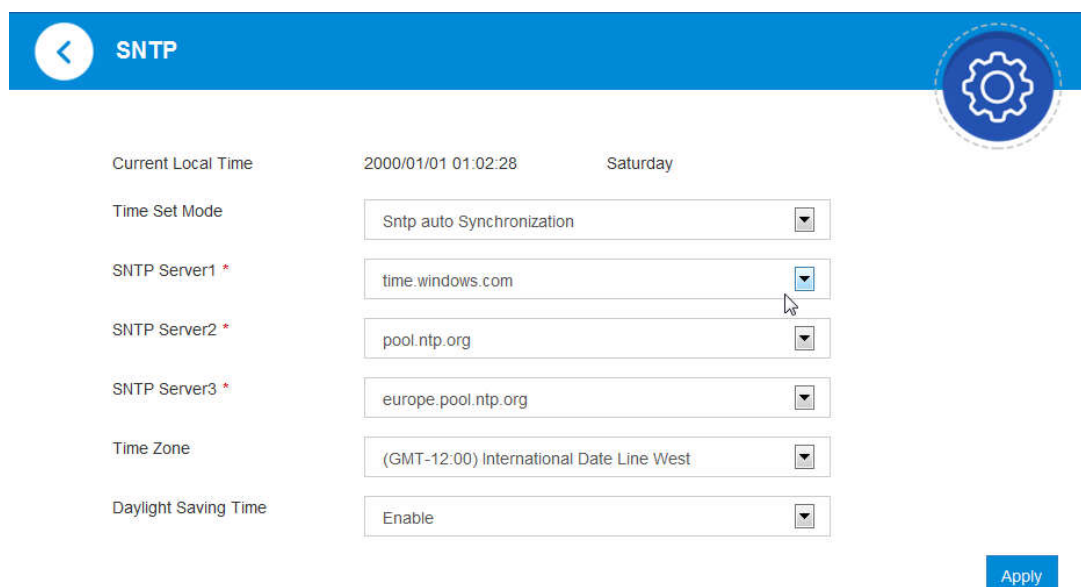

- **Current Local Time:** Shows current local time.
- **Time Set Mode:** Choose to set the time automatically or manually from the drop-down list.
- **SNTP server 1/2/3:** Choose SNTP server from the drop-down list.
- **Time Zone:** Choose your time zone from the drop-down list.
- **Daylight Saving Time:** Enable or disable the Daylight Saving Time.

Click **Apply** to confirm your configuration.

To set the device's time manually, follow the steps below.

1. Choose **Manual Set Time** from the **Time Set Mode** drop-down list.

The screenshot shows the SNTP configuration interface. At the top, there is a blue header with a back arrow and the text 'SNTP'. On the right side of the header is a gear icon. Below the header, the 'Current Local Time' is displayed as '2000/01/01 01:04:40 Saturday'. The 'Time Set Mode' is set to 'Manual Set Time'. The 'Manual Set Time' section contains five dropdown menus: Year (2000), Month (1), Date (1), Hour (1), and Minute (1). An 'Apply' button is located at the bottom right of the form.

2. Set the time and then click **Apply** to confirm your configuration.

Information

This function allows you to view system information.

Detail Information

Click **Detail Information** to view the device information.

Status Information	
SIM Card Number	+8613572209054
IMEI	004401784178549
IMSI	460002412787516
Signal Strength	---
Network Name (2.4GHz SSID)	BellXXXX
Max Access Number (2.4GHz SSID)	10
Network Name (5GHz SSID)	BellXXXX
Max Access Number (5GHz SSID)	10
Wi-Fi Coverage	Long Wi-Fi Coverage
IP Address	192.168.0.1
WAN IP Address	---
Software Version	MF288UIV0.0.5
Hardware Version	MF288HW1.0

[Detail Information](#) 

Data management

Not set,  [click Settings](#) from home page.

<
Data Management

You can create statistic plan, query used and left statistic

Data Management Enable Disable

[Apply](#)

If you select **Enable**, the **Data management** will appear, you can configure your data settings on this screen.

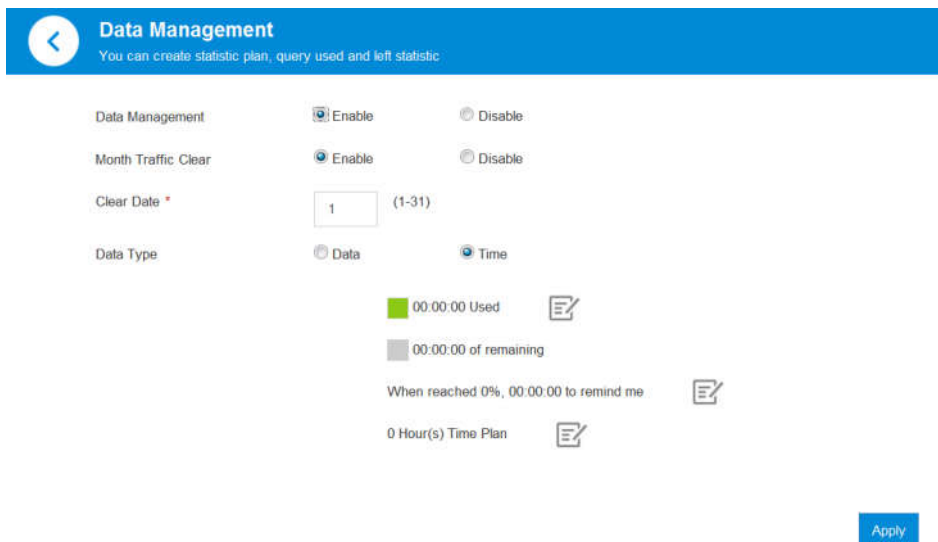

SMS

This function allows you to create, receive, send and forward messages from your ISP.

Operating Messages in Native

You can check the messages saved in your device.

Device SMS

Click **SMS** from home page to access the following figure:

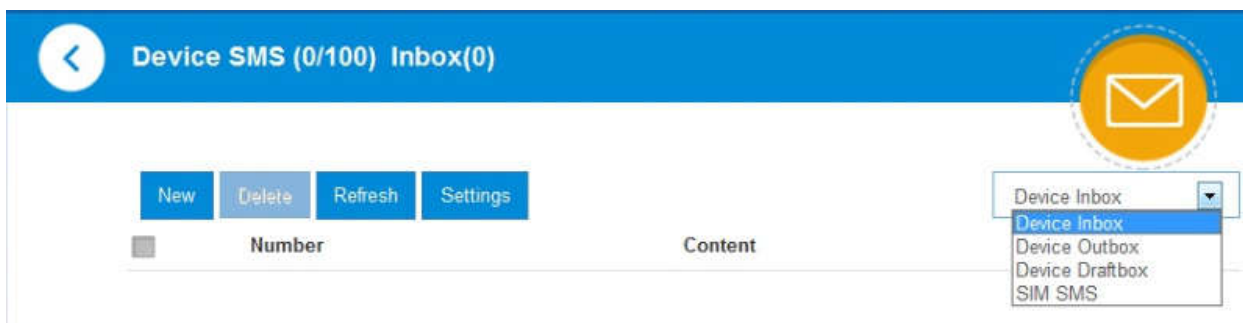

All the received messages saved in your device will be displayed here.

Click **New** to create a new message, the message screen will appear, click **Send** to finish. Click

➡ below the message entry to forward message.

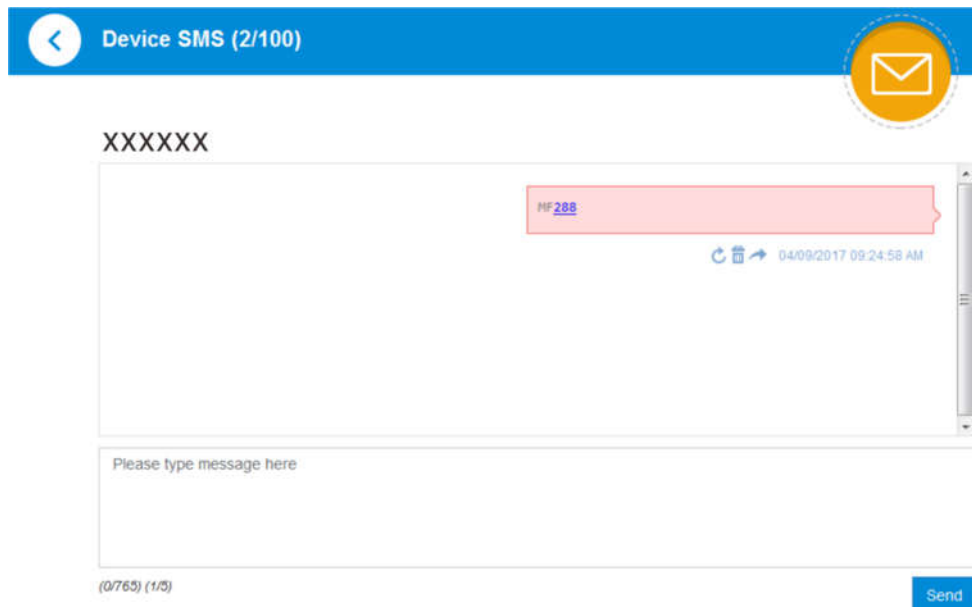

Click **Delete** to delete the selected messages.

Select the checkbox next to **Number** to select all the messages saved in your device and then click **Delete** to delete them.

Click **Refresh** to refresh manually.

You can save the message in the **Draft box** too.

Operating Messages in nano-SIM Card

You can check the messages saved in your nano-SIM card.

SIM SMS

Click  next to the **Device SMS** to select SIM SMS on the drop-down menu, then access the following figure:

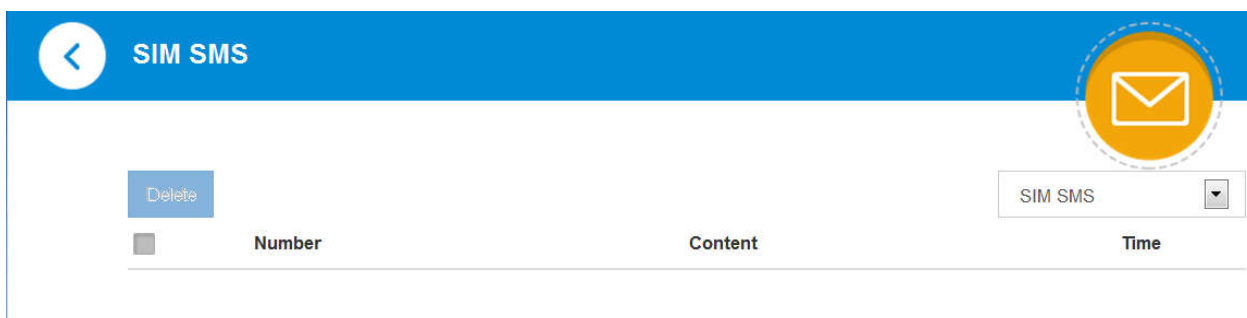

All the received messages saved in the nano-SIM card will be displayed here.

Click **Delete** to delete the selected messages.

Check the checkbox next to **Number** to select all the messages in nano-SIM card and then click **Delete** to delete them.

Warning and Notice

Safety Precautions

- Some electronic devices may be susceptible to electromagnetic interference. Locate the device away from TV set, radio and other electronic equipment to avoid electromagnetic interference.
- The device may interfere with medical devices like hearing aids and pacemakers. Consult a physician or the manufacturer of the medical device before using the device.
- Please keep yourself at least 20 centimeters away from device.
- Do not use your device in dangerous environments such as oil terminals or chemical factories where there are explosive gases or explosive products being processed.
- Please use original accessories or accessories that are authorized by ZTE. Unauthorized accessories may affect the device performance, damage the device or cause danger to you.
- Do not attempt to dismantle the device. There are no user serviceable parts.
- Do not allow the device or accessories to come into contact with liquid or moisture at any time. Do not immerse the device in any liquid.
- Do not place objects on top of the device. This may lead to overheating of the device.
- The device must be placed in ventilated environment for use.
- Do not expose the device to direct sunlight or store it in hot areas. High temperature can shorten the life of electronic devices.
- Do not allow children to play with the device or charger.
- Keep the length of the cable between the device and the phone less than 10 meters.
- The device is for indoor use only. Do not use the device outside. Do not connect telephone extensions which run outside of the building. These can result in lightning damage to your unit.

Cleaning and Maintaining

- Use an antistatic cloth to clean the device. Do not use chemical or abrasive cleanser as these could damage the plastic case. Turn off your device before you clean it.
- Use the device within the temperature range of $-10^{\circ}\text{C} \sim +55^{\circ}\text{C}$, and the storage temperature range is $-20^{\circ}\text{C} \sim +65^{\circ}\text{C}$. The humidity range is 5%~95%.
- Do not use your device during a thunderstorm. Remove the mains power pack from the wall socket.
- Do not take out your nano-SIM card unnecessarily. The nano-SIM card may be easily lost or it can be damaged by static electricity.

Limited Warranty

- This warranty does not apply to defects or errors in the Product caused by:
 - i. Reasonable abrasion.
 - ii. End User's failure to follow ZTE's installation, operation or maintenance instructions or procedures.
 - iii. End User's mishandling, misuse, negligence, or improper installation, disassembly, storage, servicing or operation of the Product.
 - iv. Modifications or repairs not made by ZTE or a ZTE-certified individual.
 - v. Power failures, surges, fire, flood, accidents, actions of third parties or other events outside ZTE's reasonable control.
 - vi. Usage of third-party products, or usage in conjunction with third-party products provided that such defects are due to the combined usage.
 - vii. Any other cause beyond the range of normal usage intended for the Product.

End User shall have no right to reject or return the Product, or receive a refund for the Product from ZTE under the above-mentioned situations.

- This warranty is End User's sole remedy and ZTE's sole liability for defective or nonconforming items, and is in lieu of all other warranties, expressed, implied or statutory, including but not limited to the implied warranties of merchantability and fitness for a particular purpose, unless otherwise required under the mandatory provisions of the law.

Limitation of Liability

ZTE shall not be liable for any loss of profits or indirect, special, incidental or consequential damages resulting from or arising out of or in connection with using of this product, whether or not ZTE had been advised, knew or should have known of the possibility of such damages, including, but not limited to lost profits, interruption of business, cost of capital, cost of substitute facilities or product, or any downtime cost.

FCC Compliance

This device complies with part 15 of the FCC Rules. Operation is subject to the following two conditions: (1) This device may not cause harmful interference, and (2) this device must accept any interference received, including interference that may cause undesired operation.

Caution: Changes or modifications not expressly approved by the manufacturer could void the user's authority to operate the equipment.

NOTE: This equipment has been tested and found to comply with the limits for a Class B digital device, pursuant to part 15 of the FCC Rules. These limits are designed to provide reasonable protection against harmful interference in a residential installation. This equipment generates, uses and can radiate radio frequency energy and, if not installed and used in accordance with the instructions, may cause harmful interference to radio communications. However, there is no guarantee that interference will not occur in a particular installation. If this equipment does cause harmful interference to radio or television reception, which can be determined by turning the

equipment off and on, the user is encouraged to try to correct the interference by one or more of the following measures:

- Reorient or relocate the receiving antenna.
- Increase the separation between the equipment and receiver.
- Connect the equipment into an outlet on a circuit different from that to which the receiver is connected.
- Consult the dealer or an experienced radio/ TV technician for help.

RF Exposure

RF Exposure Information

This device meets the government's requirements for exposure to radio waves.

This device is designed and manufactured not to exceed the emission limits for exposure to radio frequency (RF) energy set by the Federal Communications Commission of the U.S. Government.

This device complies with FCC radiation exposure limits set forth for an uncontrolled environment. In order to avoid the possibility of exceeding the FCC radio frequency exposure limits, human proximity to the antenna shall not be less than 20cm (8 inches) during normal operation.

The FCC grant can be found under the Display Grant section of <http://www.fcc.gov/oet/fccid> after searching on FCC ID: SRQ-MF288.

ISED Notice

This device complies with Innovation, Science and Economic Development Canada license-exempt RSS standard(s). Operation is subject to the following two conditions:

- (1) this device may not cause interference, and
- (2) this device must accept any interference, including interference that may cause undesired operation of the device.

Le présent appareil est conforme aux CNR Innovation, Sciences et Développement économique Canada applicables aux appareils radio exempts de licence. L'exploitation est autorisée aux deux conditions suivantes:

- (1) l'appareil ne doit pas produire de brouillage, et
- (2) l'utilisateur de l'appareil doit accepter tout brouillage radioélectrique subi, même si le brouillage est susceptible d'en

This Class B digital apparatus complies with Canadian ICES-003.

Cet appareil numérique de la classe B est conforme à la norme NMB-003 du Canada.

IC : 5200E-MF288

ISED RF Exposure Statement

This device complies with ISED RSS-102 RF exposure limits set forth for an uncontrolled environment. In order to avoid the possibility of exceeding the IC RSS-102 RF exposure limits, human proximity to the antenna shall not be less than 20cm (8 inches) during normal operation.

Cet appareil est conforme aux limites d'exposition aux rayonnements de la CNR-102 définies pour un environnement non contrôlé. Afin d'éviter la possibilité de dépasser les limites d'exposition aux fréquences radio de la CNR-102, la proximité humaine à l'antenne ne doit pas être inférieure à 20 cm (8 pouces) pendant le fonctionnement normal.

The device for operation in the band 5150–5250 MHz is only for indoor use to reduce the potential for harmful interference to co-channel mobile satellite systems.

Troubleshooting

Internet Related Problems

Problem	Recommended Action
The device cannot access the Internet at all.	<ul style="list-style-type: none"> • Please check your configuration settings. • Please wait 1~ 2 minutes for the device to initialize. • Check your service indicator LED's.
The download or upload speeds are very slow.	The speed is dependent on signal strength. Check your signal strength and network type.
Failing to visit the WebUI configuration page	<ul style="list-style-type: none"> • Enter the correct address. The default address is http://192.168.0.1 or http://setup.zte. • Only use one network adapter in your PC. • Do not use any proxy server.
Failing to establish a connection between your device and a client through Wi-Fi	<ul style="list-style-type: none"> • Make sure the Wi-Fi function is active. • Refresh network list and select the correct SSID. • Check the IP address to make sure your client can obtain an IP address automatically in the Internet protocol (TCP/IP) properties. • Type the correct network key (Wi-Fi password) when you connect to the device.
About the password	<ul style="list-style-type: none"> • For the Wi-Fi connection password, please check the label on the device. • The default password of the WebUI configuration page is admin. • If you changed the password and forgot the new password, you need to restore the device to the factory default settings.

For more assistance, please:

- Visit www.ztedevices.ca
- Call the Service Hotline: **+1 (866) 644-3056**