

Z221

User Manual

ZTE CORPORATION
NO. 55, Hi-tech Road South, ShenZhen, P.R.China
Postcode: 518057
Tel: (0086) 755 26779999
Website: <http://www.zte.com.cn>
E-mail: mobile@zte.com.cn

LEGAL INFORMATION

Copyright © 2011 ZTE CORPORATION.

All rights reserved.

No part of this publication may be excerpted, reproduced, translated or utilized in any form or by any means, electronic or mechanical, including photocopying and microfilm, without the prior written permission of ZTE Corporation.

The manual is published by ZTE Corporation. We reserve the right to make modifications on print errors or update specifications without prior notice.

Version No. : R1.0

Edition Time: Feb, 2011

Manual No. : 07958450XXXX

Contents

Getting Started	1
Removing the Back Cover	1
Battery	1
SIM Card.....	2
Charging Your Phone.....	3
Powering Phone On/Off.....	4
Getting to Know Your Phone.....	5
Key Functions	6
Idle Mode	7
Indicators and Icons	7
Main Menu.....	8
Entering Text.....	10
Changing Input Mode	10
Entering Letters.....	10
Entering Numbers	10
Entering Symbols.....	10
Calls	12
Making a Voice Call	12
Using the Address Book	12
Using Call Options.....	12
Receiving Calls	12
Adjusting the Volume	12
Using Call History	12
Messages	13
Type of Messages.....	13
SMS and MMS.....	13
Voice Mail.....	14
Message Folders.....	14
Using Message Options	14
Message Settings.....	15
Using Message Templates	15
Address Book.....	16
Adding Contact	16
Searching Contact	16
Setting Speed Dial.....	16
Making a Speed Dial.....	16
Using Address Book Entry Options.....	17
Bluetooth.....	18
Enabling Bluetooth	18
My Devices	18
Sending Data.....	18
Receiving Data.....	19
Mobile Web.....	20
Using the att.net Homepage	20
Visiting a Website.....	20
Tools.....	21

Alarm	21
Calendar	21
Calculator	21
Tip Calculator	22
Stopwatch.....	22
World Time	22
Currency Conversion	22
Recent Calls	22
Entertainment.....	23
Pictures.....	23
Video.....	23
Music.....	23
Voice Recorder	23
Settings.....	25
Sound Profile Settings.....	25
Phone Settings.....	25
Display Settings	25
Connections Settings.....	25
Calls Settings.....	26
Security Settings	26
Accessibility.....	28
TTY Mode.....	28
HAC (Hearing Aid Compatibility) Mode	28
Care and Maintenance.....	29
General Care	29
General Guidelines.....	30
Aircraft Safety.....	30
Hospital Safety.....	31
Road Safety	31
Vehicles Equipped with an Airbag	31
Third Party Equipment.....	31
Declaration of Conformity	31
Disposing of Your Phone.....	31
Emergency Service	32
Privacy Information	32
Turn on the HAC Setting	32
Copyright Notice.....	32
Troubleshooting and FAQs.....	33
Specifications	35
FCC Compliance.....	36
Radio Frequency (RF) Energy	37

Chapter 1

Getting Started



Notes: In this User Manual, “press a key” means to press the key and release it, while “hold a key” means to press the key for at least two seconds and then release it.

Removing the Back Cover

1. Hold the Power/End key to turn off the phone.
2. Lift the bottom of the back cover from the notch and remove the back cover as shown below.

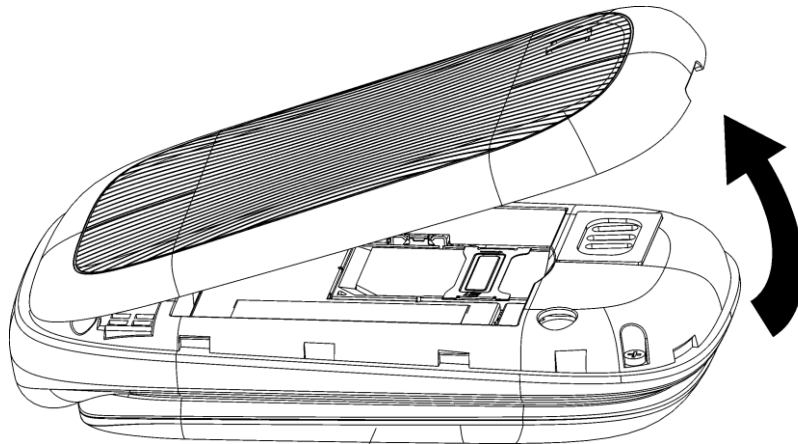

Battery

Installing the Battery



Notes:

- The phone automatically turns off if the battery power is too low.
 - If you are not going to use the battery for a long time, remove it from the phone and store it in a cool dry place.
1. Hold the Power/End key to turn off the phone.
 2. Remove the back cover of your phone.
 3. Carefully insert the battery with the contacts located against the metal springs.
 4. Push down the battery until it clicks into place.

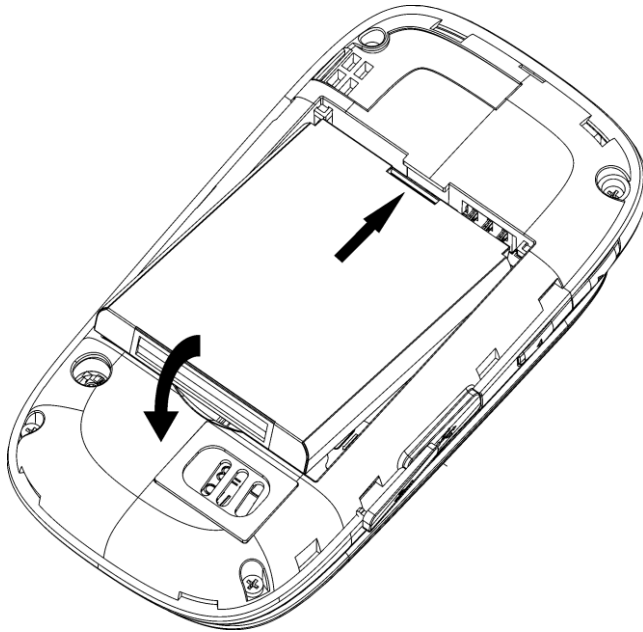

5. Replace the cover on the back of the phone.



Caution:

- Make sure the cover is lined up before pressing it into place. Do not force it. Doing so will damage the back cover.

Removing the Battery

1. Hold the Power/End key to turn off the phone.
2. Remove the back cover of your phone.
3. Lift the end of the battery near the bottom of the phone to remove it.

SIM Card

Inserting the SIM (Subscriber Identification Module) Card

You can obtain a SIM card from your service provider when you sign on as a subscriber.



Caution:

- Do not bend or scratch your SIM card. Keep the card away from electricity and magnetism.
- Don't touch the metal surface of the SIM card. Doing so could cause information on the card to be lost or destroyed.
- Disconnect the charger and other accessories from your phone and remove the battery before inserting and removing your SIM card.

1. Hold the Power/End key to turn off the phone.
2. Remove the back cover of your phone.
3. Hold the SIM card with the metal contacts facing downward and the cut corner at the upper left. Insert the card into the card holder and push it until it clicks into position.
4. Replace the cover on the back of your phone.

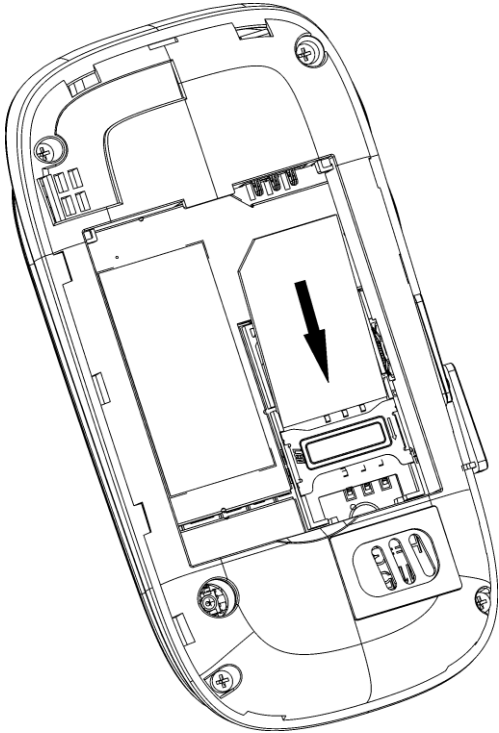

Removing the SIM Card

1. Hold the Power/End key to turn off the phone.
2. Remove the back cover of your phone.
3. Gently remove the SIM card from the card holder.

Charging Your Phone

Your phone uses a rechargeable battery. When you first unpack the phone, the battery is not fully charged, but there might be enough power to turn on the phone. You can use the provided charger to charge the phone battery.

1. Open the USB port cover.
2. Insert the charger's USB adapter into the USB port
3. Plug the charger into a standard AC wall outlet.

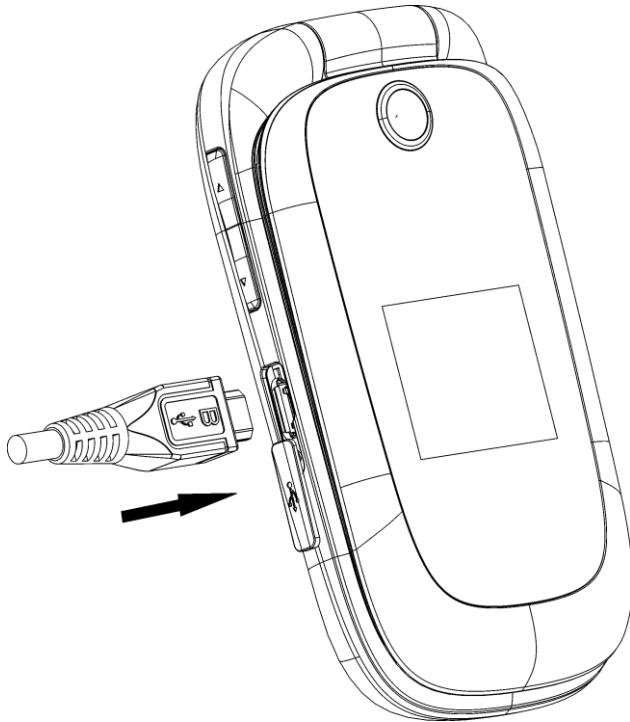

4. When the battery is fully charged, unplug the charger and disconnect it from the phone.



Notes:

- The phone automatically switches off if the battery power is too low.
- Make sure the charger's connector is inserted correctly. Do not force the connector into the port.
- The battery will remain fully charged for 3 to 4 hours.
- Only use the charger provided by the original provider. Using an unapproved charger might be dangerous and violate the authorization and warranty rules of the phone.
- If the phone is used too often when the battery is low or not used for a long time, the screen may not display the charge indicator until the battery has been continuously charged for 10 to 40 minutes.
- To get the maximum performance out of your battery, it is recommended that you completely charge the battery before using the phone for the first time. A new battery's full performance is only reached after three complete charge and discharge cycles have been finished.
- Charging is only possible within a temperature range of 32° F to 113° F.

Powering Phone On/Off



Notes:

- Do not turn your phone on in areas in which wireless phone use is not permitted, or when it could cause interference or danger.

Hold the **Power/End Key** to turn your phone on or off.



Tips:

- When prompted, enter your PIN (Personal Identification Number) code or handset code and press the **OK Key**.
- The PIN code is the password provided by your network service provider. You cannot use the SIM card without it.
- When the PIN code or handset code is accepted, the phone automatically searches for the network. After a few seconds, your phone displays idle mode.

Getting to Know Your Phone

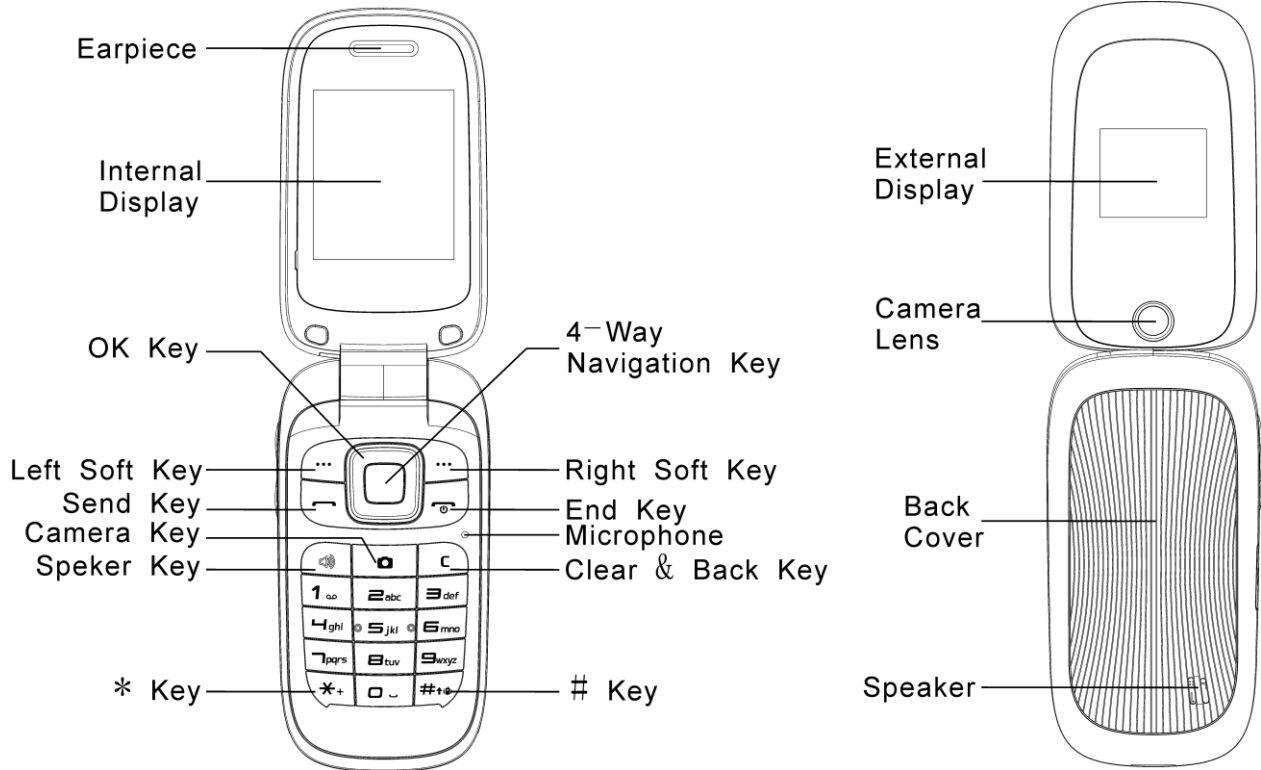

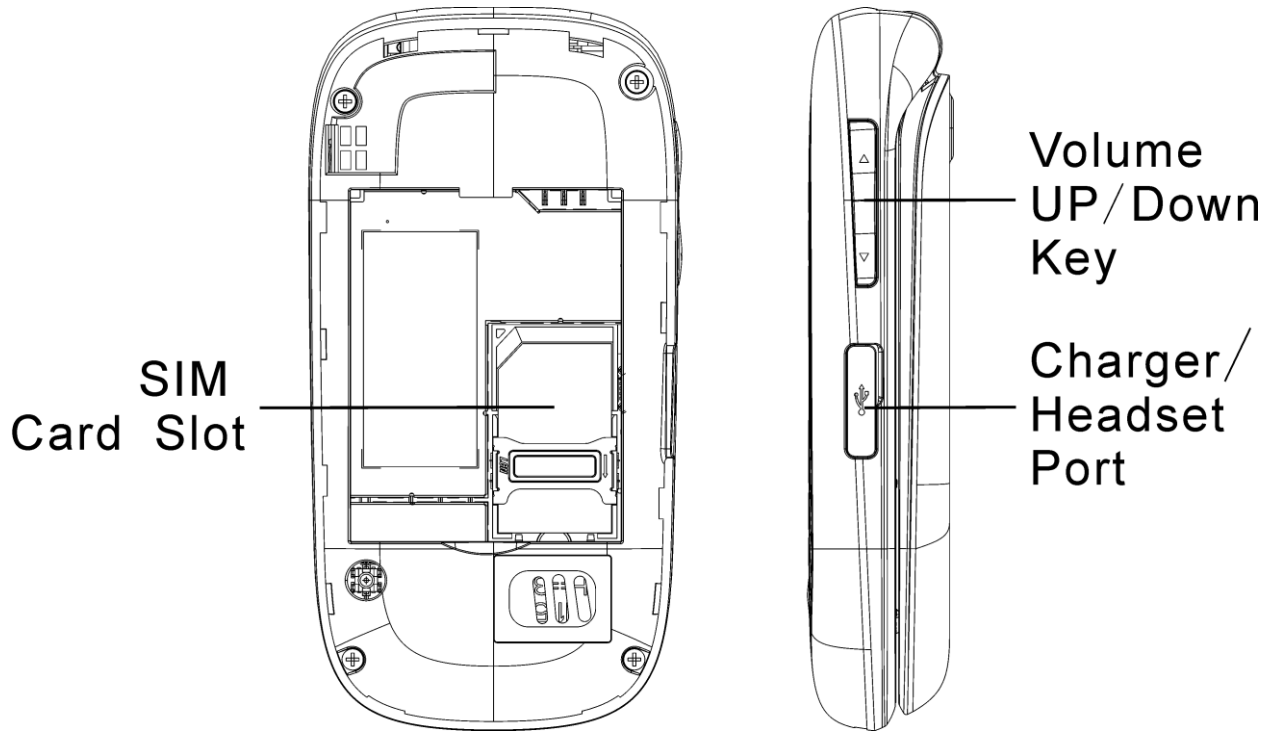

Key Functions







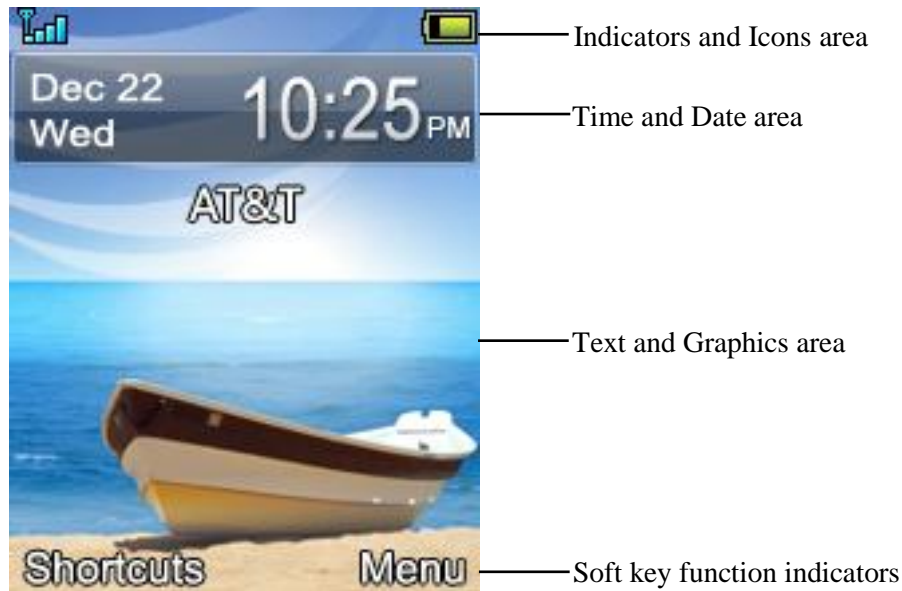





Key	Description
OK Key	From idle mode, press to open att.net. In lists and menus: Press to start an application/function.
4-Way Navigation Key	From idle mode: Used to activate preset functions. In lists, messages, and menus: Used to scroll up, down, left, and right.
Left Soft Key/ Right Soft Key	The bottom line of the display shows the options that can be selected using the Left and Right Soft Keys . The options change depending on the application/function being used.
Send Key	Press to dial or answer calls. From idle mode: Press to show a list of all calls.
Power/End Key	Hold to turn the phone on/off. Press to end a call. Press to reject an incoming call. Press to cancel dialing. Press to return to idle mode.
Volume key	Adjust the volume of the phone.
Speaker Key	Press to open the speaker while calling.
Camera Key	Press to activate multitask manager.
Clear & Back Key	Press to delete the character on the left of the cursor when entering text or numbers. Hold to delete all characters during text entry. Press to return to the previous page when navigating menus or browsing the internet.
Number Keys	Press the number keys to enter a phone number.
* Key	Press to enter *. From idle mode, hold to lock the keypad. In an editing screen: Press to enter punctuation and symbols.
# Key	Press to enter #. In an editing screen: Press to change the input method. From idle mode: Hold to activate meeting mode with vibration.









Idle Mode

After powering on the phone, when the name of the network is displayed on the screen, the phone is in idle mode and ready for use. The display has 4 areas:



Indicators and Icons





Indicator	What it means
	Signal strength
	3G network
	EDGE network
	GSM network
	New SMS
	New MMS
	New Email
	New voicemail
	Mute and vibrate
	Headset mode
	GPRS attach (blue and red)
	Bluetooth on
	All calls divert





	Battery status
	Missed call
	Roaming
	HSDPA mode
	The message memory is full
	Vibrate and ringing
	Headset and vibrate mode
	GPRS in use (orange and purple)
	Alarm

Main Menu

From idle screen, press the **Right Soft Key** for **Menu** to access the main menu.



Icon	What it means	Description
	Email & IM	Mobile email and Instant Messaging
	Messaging	Send and read SMS or MMS messages
	YPMobile	Yellow pages
	Mobile Web	Access the web with att.net
	App Center	Online App store

	AT&T Mobile Care	Customer care and services
	My Stuff	Contains applications and tools such as Alarm, Calendar, and more
	Address Book	Add and edit contacts
	Settings	Set up and personalize your phone

Chapter 2

Entering Text

Changing Input Mode

You can enter text into your phone using the following input methods: ZiAbc, abc, Abc, ABC, and number input. You can also switch the language between English and Spanish.

Current Text Mode

When you are in a field that allows characters to be entered, the text input mode indicator is shown in the upper right corner of the display.

Changing Input Mode or Language

Press the **# Key** and select an input method or language.

Using Predictative Text (ZiAbc)

The predictive text method is based on a built-in dictionary and generates words from the combination of letters pressed.

1. Press each key once that corresponds to the letter you want to enter. The letters are shown on the display as they are entered. The list of candidate words changes as each key is pressed.
2. When the candidate words are displayed, use the **Navigation Key** to highlight a candidate word and then press the **OK Key** to **Select**.
3. Press the **0 Key** to insert a space, or press the *** Key** to select symbols.
4. Press the **Clear Key** to delete the letter to the left of the cursor. Hold the **Clear Key** to delete all entered text to the left of the cursor.

Entering Letters

Press a number key (2-9) multiple times until the preferred letter is shown on the screen. Press once to enter the first letter on the keypad, press twice quickly to enter the second letter, and so on.

- Press the **0 Key** to add a space.
- Press the **0 Key** twice quickly or hold the **0 Key** to enter 0.



Notes:

- When using “Abc” mode, only the first letter will be capitalized.
- After entering the first capital letter, the input mode will be changed to “abc” automatically.

Entering Numbers

Press the **# Key** and select 123. The input method icon (此处更换为 123 输入法的图标) is shown on the display. You can enter numbers directly using the number keys.



Tip:

- When using the number input, you need to switch to other text input methods if you want to input a space by pressing the **OK Key**.

Entering Symbols

1. Press the *** Key**.
2. Use the **Navigation Key** to select a symbol.

3. Press the **OK Key**.

Chapter 3

Calls

Making a Voice Call

1. In standby mode, enter a phone number.
2. Press the **Send Key** to call the number.

Using the Address Book

1. From idle mode, select **Menu > Address Book**.
2. Highlight a contact and press the **Send Key** to call the contact.

Using Call Options

During a call, you can press the **Left Soft Key** for more options. The options vary depending on the functions you are currently using.

Hold/Unhold: Put the current call on hold or retrieve the call.

End call: End the current call.

Record: Record the current call. Press the **OK Key** to stop recording.

DTMF off/on: Enable or disable the sending of the DTMF tones.

Message: Switch to the Messaging menu during a call.

Contacts: Switch to the Address Book menu during a call.

Browser: Browse the Internet during a call.

Receiving Calls

When a voice call comes in, press the **Send Key** to answer the call. Press the **OK Key** to answer the call with the speaker phone on.



Tip:

- If you have connected a headset to the phone, you can press the button on the headset to answer the call.

Adjusting the Volume

During a call, press the **Volume Keys** to adjust the earpiece or speaker volume.

Using Call History

From idle mode, press the **Send Key** to check the **All calls** log.

Chapter 4

Messages

Type of Messages

Your phone provides the following message types:

- TextMessages(SMS)
- Multimedia(Picture)Messages(MMS)
- InstantMessages(IMs)

The Short Message Service (SMS) lets you send and receive text messages to and from other mobile phones and email addresses. To use this feature, you may need to subscribe to your service provider's message service.

The Multimedia Messaging Service (MMS) lets you send and receive multimedia messages (such as picture messages) to and from other mobile phones and email addresses. To use this feature, you may need to subscribe to your service provider's multimedia message service.

SMS and MMS

Sending a New SMS Message

1. Select **Menu > Messages > Messages > New message > Text message**, and press the **OK Key [Select]**.
2. Enter the recipient(s) party's number. (Or Press the **OK Key [Contacts]** to choose the recipient(s) from **Directory**.)
3. Press the **Down Key** twice to the text field.
4. Edit the message.
Select **Left Soft Key > Templates/My words** to insert pre-set message or my words.
4. Press the **OK Key [Send]** to send the message.

Sending a New MMS Message

1. Select **Menu > Messages > Messages > New message > Multimedia message**, and press the **OK Key [Select]**.
2. Enter the recipient's number. Or press the **OK Key [Contacts]** to choose the recipient(s).
3. Press the **Down Key** twice to access the Title field.
4. Enter the title of your MMS message.
5. Press the **Down Key** to the text field.
6. Edit the message. Press the **OK Key [Insert]** to insert the image, audio, or video.
7. Press the **Left Soft Key [Options]** and select **Send** to send your message.



Notes:

- To save an unfinished message, press the **Left Soft Key** for **Options** and select **Save** to save it to the Drafts folder.
- Messages in Outbox and Drafts folder can be edited and sent.

Viewing a Message

The **(duanxintubiao)** or **(caixintubiao)** envelope icon will appear on the information bar to identify you that you have received a new message.

Press the **OK Key** twice to view the message.

Or from idle mode, select **Menu > Messaging > Inbox** to check your messages.

Voice Mail

Voice Mail Settings

From idle mode, select **Menu > Messaging > Settings > Voicemail number** to check the voicemail number. Your voicemail phone number is preset by your service provider. You do not need to set it manually.

Receiving a Voice Mail

When the system sends you a message notifying you that there is a new voicemail, from idle mode, hold the **1 Key** to access the voicemail service.



Notes:

- Contact your service provider for more information on using the voicemail service.

Message Folders

The **Inbox** folder contains all of your received messages. In this folder you can view your received messages and reply to them or forward messages to another recipient.

The **Outbox** folder contains all messages that were not sent during the last attempt. In this folder you can edit or resend your messages.

The **Sent** folder contains messages that were sent successfully. From this folder you can edit or forward messages to another recipient.

The **Drafts** folder contains drafts and unfinished messages. In this folder you can complete or resend your messages.

The **Saved messages** folder contains messages that you moved from the Inbox.



Notes:

- You cannot receive new messages if the message memory is full.
- The total amount of space available for saving messages is determined by the space available on the phone and SIM card.

Using Message Options

While viewing the contents of the Inbox, press the **Left Soft Key** to access the following options, which apply to the highlighted text message:

- **Reply:** Reply to the message.
- **Call Sender:** Call back the originator of the message.
- **Save number:** Save the originator's number to your Address Book.
- **Delete:** Delete this message.

- **Lock/Unlock:** When the message is locked, you will not be able to delete it.
- **Forward:** Forward this message.
- **Sort:** Select to sort the messages by time or read/unread.

Message Settings

From idle mode, select **Menu > Messaging > Settings** to change the MMS/SMS/ Templates settings.

MMS Settings (Multi. msg. setting)

Retrieval Settings: You have two choices:

- **Automatic:** Retrieve the new multimedia message automatically without selecting the notification message and receiving.
- **Manual:** Retrieve the new multimedia message manually.

Time per page: Set the play time of each page.

Anonymous Msg.: You can choose to accept or refuse anonymous messages.

Connections: Please consult the service operator for detailed information.

PUSH Message: You can accept or reject PUSH messages.

SMS Settings (Text msg. setting)

SMS center number: Service center number given to you by your service provider.

Template Settings

The phone has 10 templates for SMS/MMS, and you can edit them.

Using Message Templates

1. From idle mode, select **Menu > Messaging > Create message**.
2. Move to the Text field and select **Options > Template**.
3. Select a template and press the **OK Key** to insert the template.

Chapter 5

Address Book

Adding Contact

You can store contacts with a variety of phone and fax numbers and additional address details.

The phone can store up to 500 items. The capacity of the phone book on your SIM card depends on the type of SIM card provided by your service provider. The saved location is identified by the icon shown before the contacts.

The icon shows the contacts that are stored in your SIM card.

1. Select **Menu > Address Book > Left Soft Key [Options] > Add New contact**, and press the **OK Key [Select]**.
2. Enter the information of contact, such as name, number, and so on.
3. Press the **Left Soft Key [Save]** to save the new contact.

Searching Contact

1. Select **Menu > Address Book** to view all the contacts on your phone.
2. Enter a letter, and then the phone will show all the contacts starting with such a letter.
Eg: To search “John”, press the **5 Key** once for ‘j’. All names starting with ‘J’ or ‘j’ are displayed.
3. Refine the search by entering a subsequent letter that can occur anywhere in the name.
Eg: ‘Jn’ will find ‘John’ and ‘Julian’, but not ‘James’.

Setting Speed Dial

1. In standby mode, press **Menu > Address Book**.
2. Use the **Navigation Keys** to select a contact, press the **Left Soft Key [Options]** and select **Set as speed dial**.
3. Press the **Up Key** or **Down Key** to select an **empty** slot.
4. Press the **OK Key [Assign]** to finish.
5. Press the **Right Soft Key[Back]** to return to the previous menu. Or press the **End Key** to return to the idle screen.

Making a Speed Dial



Notes:

The **1 Key** is reserved for the Voicemail number.

1. In standby mode, press and hold the corresponding number key (**2 to 9**) in the speed dial list to make the call.
2. Press the **End Key** to end the call.

Using Address Book Entry Options

1. From idle mode, select **Menu > Address Book**.
2. Scroll to the desired contact and press the **Left Soft Key** for more options:

Call: Call the highlighted contact.

Add new contact: Create a new contact.

Send message: Send SMS or MMS messages to this contact.

Edit contact: Edit this contact information.

Delete contact: Delete this contact.

Share contact info: Send this contact as a business card via MMS message.

Add to: Add this contact to a group: Family, Friends, or Work.

Add new group: Create a new group.

Set as speed dial: Set speed dial for this contact.

Settings:

- SIM management:** Copy contacts to or from the SIM card, or delete contacts from the SIM card.
- Delete multiple:** Delete a batch of contacts.
- Speed dial:** View and edit the speed dials list.

Chapter 6

Bluetooth

Your phone includes support for Bluetooth, which can be used to connect your phone to a wireless headset. You can also use it to transfer files between your phone and other Bluetooth devices, such as another phone or a laptop. Not all applications or devices can be supported because Bluetooth is an open forum and different manufacturers have different standards and implementation.

Enabling Bluetooth

By default Bluetooth is disabled on your phone. If you enable Bluetooth and turn off the phone, Bluetooth will be disabled. When you turn the phone on, Bluetooth will automatically be enabled.

1. From idle mode, select **Menu > Settings > Connections > Bluetooth**.
2. Set **Bluetooth** to **On**.
3. Go down to **Discoverable** and set it to **On**.
4. Go down to **My Bluetooth Info** and enter the phone name.
5. Press the **OK Key** to save the settings.



Notes:

Set **Discoverable** to **On** to allow your phone to be found by compatible devices.

My Devices

6. From idle mode, select **Menu > Settings > Connections > Bluetooth > My devices**.
7. Press the **OK Key** to search for available Bluetooth devices.
8. Highlight a device from the list and press the **OK Key**.
9. To connect to the device, enter the passcode when prompted and press the **Left Soft Key** for **Pair**.

There are two options for *Bluetooth* connection:

- **Automatic:** Set another Bluetooth device that is connecting to your phone as an authorized device.
- **Always Ask:** Set another Bluetooth device that is connecting to your phone as an unauthorized device that must ask before connecting.



Tip:

Some devices don't connect to another Bluetooth device automatically. You need to highlight the device name in the **My devices** list and press the **OK Key** to connect with it.

Sending Data

Before sending data, please confirm the following two items:

- Bluetooth function is enabled.
 - The paired device is visible, paired, and connected.
1. Select your desired file, and select **Left Soft Key [Options] > Send > Via Bluetooth**.
 2. Select the aim device from the device list, and press the **OK Key** to send.

Receiving Data

1. Enable Bluetooth function.
2. If the paired device tries to send a file to your phone, one popup dialogue will appear in your screen.
3. Press the **Left Soft Key [Yes]** to accept the incoming file, or press the **Right Soft Key [No]** to reject the incoming file.

Chapter 7

Mobile Web

Browse the web directly from your mobile phone. Check the weather, visit your favorite websites, and enjoy access to the Internet on the go. From idle mode, select **Menu > Mobile Web**.

Using the att.net Homepage

The att.net homepage features three tabs, which you can access by scrolling left or right with the **Navigation Key**:

- **Web:** enter a web address; search the Internet with Yahoo!® ; use, add, or manage shortcuts; view social networks; find movie information and buy tickets; and access your account.
- **Local:** set your location, search locally, see maps and traffic, find movie showtimes, get local information, check the weather, and see local news updates.
- **Popular:** get the latest updates on news, finance, sports, entertainment, and more; use email, instant messaging, and social networking.

Visiting a Website

1. From the att.net homepage, press down on the **Navigation Key** to highlight the address bar and press the **OK Key**.
2. Enter a web address and press the **OK Key**.
3. To access a link on a website, scroll to it using the **Navigation Key** and press the **OK Key**.

Mobile Web options:

- **Home:** return to the att.net homepage.
- **Go to URL:** enter a new web address.
- **Go to Search:** enter search terms.
- **History:** view your web browsing history.
- **Go to Bookmarks:** access your list of favorite sites.
- **Add to Bookmarks:** add a site to your list of favorites.
- **Reload:** reload the current page.
- **Find in Page:** search the page for a term.
- **Settings:** adjust browser settings.
- **Help:** find help and answers to frequently asked questions.
- **Exit:** exit the web browser.

Chapter 8

Tools

Alarm

This feature allows you to set an alarm to ring at a specific time.

1. From idle mode, select **Menu > My Stuff > Tools > Alarm**.
2. Press the **OK Key** for **Edit** and configure the alarm as required using the Alarm Setup Screen:

Alarm Time	Set as required
Alarm Type	Daily, Workday, Weekly, Once
Snooze	Off, 5, 10, 15, 30 minutes
Ringtone	On/Off
Ringtone Type	ATT tone.mid, select Edit to change
Alarm Remark	Optional



Tips:

If the alarm time has passed, it cannot be saved.

Even if the phone is turned off, the alarm will automatically turn the phone back on so that it can ring.

Calendar

With this feature, you can use the calendar, set appointments, and view events.

1. From idle mode, select **Menu > My Stuff > Tools > Calendar**.
2. Press the Left Soft Key for Options to access the following:
 - New:** Add a meeting, memo, or anniversary.
 - Week view:** View the schedule of the current week.
 - Go to date:** Enter a date and view the scheduled events of that day.
 - Delete entry:** You can choose to delete entries On this day, Before date, or All entries.
 - Settings:** You can set the Calendar alarm tone, Default view, and Week starts on.
 - Memory Info:** Shows the current memory usage.

Calculator

With this feature, you can use the phone as a calculator. The calculator provides the basic arithmetic functions; addition, subtraction, multiplication, and division.

1. From idle mode, select **Menu > My Stuff > Tools > Calculator**.
2. Enter the first number using the **Number Keys**.
3. Enter the operation for your calculation by pressing up, down, left, or right on the **Navigation Key**.
4. Enter the second number.
5. Press the **OK Key** for **Equal** to view the result.



Tips:

Press the **Clear & Back Key** to clear digits and results.

Press the *** Key** to toggle the number between positive and negative.

Press the **# Key** to enter a decimal point.

Tip Calculator

With this feature, it will be easy to calculate the tip or determine how much each person should pay in your group.

1. From idle mode, select **Menu > My Stuff > Tools > Tip Calculator**.
2. Enter the total bill by using the Number Keys.
3. Type the tip amount (in percentage) you would like to leave.
4. If the cost is shared by more than one people, please enter the number of the people into the split field.
5. At bottom of the calculator, the amount you need to pay will be displayed.

Stopwatch

With this feature, you can measure time and take split times or lap times, for example, in different sports.

1. From idle mode, select **Menu > My Stuff > Tools > Stopwatch**.
2. Select **Start** to start timing.
3. Select **Stop** to stop the timing during the operation and view the duration of time.
4. Select **Contin.** to continue timing.
5. Select **Reset** to reset the stopwatch.

World Time

With this feature, you can check the current local time and date for major cities around the world.

1. From idle mode, select **Menu > My Stuff > Tools > World time**.
2. Press left or right on the **Navigation Key** to view the time of desired city.
3. Press the **OK Key** to save the selected city time as the time setting on your phone.
4. Press the **Right Soft Key** to exit.

Currency Conversion

This feature allows you to convert foreign currency to domestic currency.

From idle mode, select **Menu > My Stuff > Tools > Currency conversion**.

- Exchange rate:** Enter a currency exchange rate.
- Foreign amount:** Enter the amount of foreign currency to be converted.
- Local amount:** The conversion result displays.



Tips:

Press the **Left Soft Key** to enter a decimal.

Recent Calls

With this feature, you can check the call log and call duration.

From idle mode, select **Menu > My Stuff > Tools > Recent Calls**.

- Call log:** You can check **All calls**, **Missed calls**, **Received calls**, and **Dialed calls** logs.
- Call Info:** You can check the **Last call duration** and **All calls duration**. You can also clear all the call duration timers by pressing the **OK Key** for **Clear**. To reset the timers you will need to enter the phone's lock code. The default lock code is **0000**.



Notes:

All calls information can also be accessed by pressing the **Send Key** while in idle mode.

Chapter 9

Entertainment

Your phone allows you to use a camera, video camera, and voice recorder to take photos, shoot video clips, record voice memos, and more.

Pictures

Your phone includes a photo management function. Photos in the phone's memory or on the external memory card can be browsed, transmitted, set as wallpaper, moved, renamed, copied, and deleted.



Caution:

The preloaded photos on the phone cannot be transmitted or deleted.

Taking a Photo

Your phone has an integrated digital camera, which allows you to capture images.

1. From idle mode, select **Menu > My Stuff > Tools > Camera**. Or from idle mode, hold the **Camera Key** to start the camera
2. Aim the camera lens at a subject.
3. Press the **OK Key** to take the photo; press it again to save.

Viewing Pictures

You can use the following method to view the photos:

1. From idle mode, select **Menu > My Stuff > Pictures > My pictures**.
2. Highlight a photo and press the **OK Key** for **Open**.

Video

Your phone allows you to record, store, and play video files.

Recording a Video

You can use the video camera to record video clips.

1. From idle mode, select **Menu > My Stuff > Tools > Camera**.
2. Press right on the **Navigation Key** to switch to video camera mode.
3. Press the **OK Key** to start recording.
4. Press the **OK Key** to pause.
5. Press the **OK Key** for Continue to resume recording.
6. Press the **Right Soft Key** for Stop to stop recording.
7. Press the **OK Key** for **Save**.

Playing Videos

You can use the following method to play a video.

1. From idle mode, select **Menu > My Stuff > Video > My Videos**.
2. Highlight a video and press the **OK Key** to play it.

Music

When you have audio files stored in your phone, you can create a playlist. This allows you to set the order in which the audio files are played.

You can use the steps below to play a sound file.

1. From idle mode, select **Menu > My Stuff > Audio > My Audio**.
2. Highlight a sound file and press the **OK Key** to play it.

Voice Recorder

This function allows you to record a voice memo. You can also set the voice memo as a ringtone.

1. From idle mode, select **Menu > My Stuff > Tools > Voice recorder**.

2. Select **Start** to start recording your voice memo.
3. Select **Pause** to pause the recording.
4. Select **Contin.** to resume recording.
5. Select **Stop** to stop recording.

Chapter 10

Settings

Sound Profile Settings

You can set and edit an appropriate profile depending on your current environment.

1. From idle mode, select **Menu > Settings > Sound Profiles**.
2. Select a profile and press the **Left Soft Key** for **Edit**.
 - Select **Voice call ringtone** to set the voice call ringtone.
 - Select **Ring volume** to set the volume of the ringtone.
 - Select **Ring type** to set the ring type.
 - Select **Message tone** to set the notification ringtone for an incoming message.
 - Select **Keypad tone** to enable or disable keypad tone.
 - Select **Warning tone** to turn the warning tone on or off.
 - Select **Power on/off sound** to turn on/off the sound that plays while powering on/off the phone.
 - Select **Earpiece volume** to set the volume in the earpiece.

Phone Settings

From idle mode, select **Menu > Settings > Phone**.

- Select **Language** to set the current display language.
- Select **Time and date** to set the date, time, and time style.
- Select **Missed calls alert** to enable or disable the notification for missed calls. Choose for the alert to repeat every 5 minutes, 10 minutes, 15 minutes, or 30 minutes.
- Select **Shortcut keys** to assign a navigation key as a shortcut for a function, such as the calendar.
- Select **Own phone number** to display your phone number in idle mode to remind you which SIM card you are using.
- Select **TTY setting** to enable the TTY function. Please refer to **Accessibility > TTY Mode**.
- Select **HAC setting** to enable you to hear the phone audio through a hearing aid with a telecoil. Please refer to **Accessibility > HAC Mode**.
- Select **Master Reset** to reset the phone to the default factory settings.
- Select **Master Clear** to clear all user data and reset the phone to the default factory settings.

Display Settings

From idle mode, select **Menu > Settings > Display**.

- Select **Wallpaper** and select a photo saved in Pictures or Other files. This will be used as wallpaper, which is shown in idle mode.
- Select **Backlight duration** to adjust the backlight duration.
- Select **Main menu view** to set the main menu to be displayed as List or Grid.
- Select **Brightness** to adjust the screen brightness.
- Select **Keypad light** to adjust how long the backlight for the keypad remains on.
- Select **Owner name** to enter the owner name. This is displayed in idle mode.
- Select **Greeting** to enter a text greeting to be shown on the display when the phone is turned on.

Connections Settings

From idle mode, select **Menu > Settings > Connections**.

- Select **Bluetooth** to set up your phone as a Bluetooth device.
- Select **Access point settings** to add to, edit, or view the access point list.
- Select **Profile connect** to create or edit the connection data for a service provider.
- Select **PC connection** to choose the connection method between your computer and the phone, but USB cable only for charging.
- Select **Data service** to enable or disable Data service and International data roaming.

Calls Settings

Call forwarding

Call forwarding allows you to divert your incoming calls to another phone number. Contact your service provider for more information and availability.

Call Waiting

If a call comes in when you are already on a call, you are notified with a call waiting tone. The phone shows the number/name of the waiting call. Contact your service provider for more information.

Send My Number

This function allows you to send or hide your phone number when making calls. You can also select **Set by network**. The network then chooses whether to show/hide the phone number. This function requires network support.

Open Flip to Answer

This function allows you to answer an incoming call by directly opening the flip, but without pressing the **Send Key** or **OK Key**.

Any Key to Answer

This function allows you to answer an incoming call by pressing any key on the keypad, without limitation to the **Send Key** or **OK Key**.

Security Settings

Phone Password

A password can protect your phone and help avoid illegal use. If your phone is password protected, you will have to enter the correct password when the phone is turned on.

- For a new phone, the protection function is not activated by default, and the default password is **0000**.
- From idle mode, select **Menu > Settings > Security > Activate security codes > Phone lock code** to start or stop password protection.
- From idle mode, select **Menu > Settings > Security > Change security codes > Phone lock code** to change the phone's password. It is suggested that you change the password to something you will easily remember.



Notes:

Please remember the password you set. Without it your phone cannot be used normally and you will need to contact your service provider to unlock it.

Contact your service provider for more information.

PIN Codes

A PIN code is the personal identification code used by the SIM card. Its purpose is to avoid illegal use of your SIM card. The correct PIN code should be entered when the new phone is first turned on, otherwise the phone will only be able to make emergency calls.

- For a new card, the default code is supplied by the service provider.
- From idle mode, select **Menu > Settings > Security > Activate security codes > PIN code** to enable or disable the PIN code.
- From idle mode, select **Menu > Settings > Security > Change security codes > PIN code** to change the PIN code.
- If you enter the wrong PIN code three times in a row, the phone will lock the SIM card and prompt you to enter a PUK code to unlock it.



Notes:

If you change the PIN code, please remember the new number.

PIN2 is needed for some settings. Use the same procedure as for the PIN code.

PUK Codes

A PUK code is the unlock code for the SIM card. When the SIM card is locked, you have to enter the correct PUK code and then enter the new PIN code. The SIM card can then be used normally.

- A PUK code may be supplied with a new card. Contact your service provider for more

information.

- A PUK code can only be entered 10 times in a row. If you enter the wrong PUK code more than 10 times, the SIM card will be locked indefinitely.



Notes:

If a PUK code is supplied with the new card, please store it safely.

Fixed Dial Numbers

If you enable fixed dial numbers, you cannot dial phone numbers that are not in the FDN list.

FDN List

Allows you to create a list of fixed dial numbers.

Chapter 11

Accessibility

TTY Mode

Your handset is a TTY-compatible device. Simply connect the TTY equipment to the headset jack.

1. From idle mode, select **Menu > Settings > Phone > TTY setting**.
2. Select one of the following options and press the **OK Key** for **Select**.
 - **Full**: Users who cannot talk or hear may use this setting to send and receive text messages through TTY equipment.
 - **Read & talk**: Users who can talk, but cannot hear, may use this setting to talk through the phone and receive responses via text messages.
 - **Write & hear**: Users who can hear, but cannot talk, may use this setting to listen to the other party and respond via text messages.
 - **Off**: Users who can hear and speak may use this setting to disable TTY support.

HAC (Hearing Aid Compatibility) Mode

This phone supports HAC (Hearing Aid Compatibility) function. When you turn on the Hearing Aid Mode and use a hearing aid with a telecoil to answer the phone, it will help you hear more clearly while speaking on the phone. For more detailed information on HAC, please refer to **Care and Maintenance > Turn on the HAC Setting**.

1. From idle mode, select **Menu > Settings > Phone > HAC setting**.
2. Select **On** or **Off** and press the **OK Ke** for **Select** to confirm.

Your Z221 has been tested for hearing aid device compatibility and has an M3/T4 rating.

Chapter 12

Care and Maintenance

General Care

Your handset contains delicate electronic circuitry, magnets and battery systems. You should treat it with care and give particular attention to the following points:

- Do not allow the handset, battery or accessories to come into contact with liquids or moisture at any time. Do not immerse the handset in any liquid.
- Do not place the handset alongside computer disks, credit cards, travel cards and other magnetic media. The information contained on disks or cards may be affected by the handset.
- Do not place anything in the folded handset.
- Do not paint the handset.
- Do not leave the handset or the battery in places where the temperature could exceed 60 °C, e.g. on a car dashboard or a windowsill, behind glass in direct sunlight, etc.
- Do not remove the handset's battery while the handset is switched on.
- Take care not to allow metal objects, such as coins or key rings to contact or short-circuit the battery terminals.
- Do not dispose of battery packs in a fire. The handset's Li-ION batteries may be safely disposed of at a Li-ION recycling point.
- Do not put the handset's battery in your mouth, as battery electrolytes may be toxic if swallowed.
- Do not attempt to dismantle the handset or any of its accessories.
- This equipment is fitted with an internal **battery**; take it to a qualified service engineer when the replacement of the battery is required.
- There is a risk of explosion if the battery is replaced with an incorrect battery type. Dispose of the used battery in accordance with the manufacturer's instructions.
- Do not put a battery into a microwave oven, dryer, or high-pressure container.
- Do not contact battery directly to an electric outlet or cigarette lighter charger. Use only approved charger units.
- Do not pierce battery with a sharp object such as a needle.
- When the battery is thrown away, be sure it is non-conducting by applying vinyl tape to the (+) and (-) terminals.
- Do not disassemble or modify the battery.
- Do not drop, throw, or subject the handset to rough treatment.
- Stop using the battery if abnormal heat, odor, discoloration, deformation, or abnormal condition is detected during use, charge, or storage.
- In the unlikely event of a battery leak, keep the battery discharge away from your eyes or skin. If the leakage does come into contact with the eyes or skin, please flush thoroughly in clean water and consult with a doctor.
- Do not use a damaged or deformed battery.
- Do not solder a battery directly.
- Remove the battery whose life cycle has expired from equipment immediately.

- The earpiece may become warm during normal use. Also, the handset itself may become warm while the battery is being charged.
- When a handset is in vibration mode, the vibration can sometimes cause the handset to move.
- Be careful not to place the handset near heat sources (such as a heater) or too close to the edge of the table.
- Use a damp or anti-static cloth to clean the handset. Do not use an ordinary dry cloth or electrostatic cloth. Do not use chemical or abrasive cleaners as these could damage the casing.
- Third party equipment: The use of third party equipment, cables or accessories, not made or authorized by manufacturer, may invalidate the warranty of your handset and also adversely affect the phone's safety/operation.
- Remember to make backup copies of all important data on your handset.
- Remember to recycle: the cardboard packing supplied with this handset is ideal for recycling.

**Caution:**

Caution explosion if battery is replaced by an incorrect type. Dispose of used batteries according to the instructions.

General Guidelines

- In some countries national law unapproved private copying of copyrighted material. Please check the national legislation of the applicable country concerning the use of such material.
- Many jurisdictions have laws and regulations about taking pictures in public or private areas and regarding the processing and further use of such pictures. The manufacturer encourages its customers to obey all laws and to respect the personal rights of others.
- Please check roaming agreement availability with your service provider.
- The use of mobile phones is not allowed in some radiation sensitive areas, such as hospitals, research centers and airplanes. The user is responsible to power-off the device. If there is any uncertainty, you should remove the battery from the handset.
- Observe any signs that indicate powering off your handsets, such as those near gas stations, or explosives and power off the handset/device immediately.
- If you have a heart condition, be careful with the settings of call vibration or tone volume.
- Do not allow children to play with the handset, charger or batteries.
- Do not use the handset where blasting is in progress.
- Do not try to make a call or conversation while the temperature of charging battery is above 50°C.
- Take care not to put your handset in the back pocket of your trousers or skirt and then sit on it. Also, do not put your phone at the bottom of bag where it may subject to excessive weight or pressure. Doing so may damage the LCD and camera lens and cause them malfunction.
- The operation of some medical electronic devices, such as hearing aids and pacemakers, may be affected if a handset is used next to them. Observe any caution signs and the manufacturer's recommendations.
- Do not leave the handset discharged or without a battery for a long time, otherwise some data may be erased.
- Your phone contains metal, which may cause you an itch, a rash or eczema depending on your physical condition.

Aircraft Safety

- Power off your phone before the airplane takes off. In order to protect airplane's communication system from interference, it is prohibited to use mobile phone in flight. If you want to use mobile phone before

the airplane takes off, you should get aircrew's permission according to safety regulations.

- If the mobile phone has the function of automatic timing power-on, please check your alarm setting to ensure that your phone will not be automatically powered on during the flight.

Hospital Safety

- Switch off your phone and remove the battery in areas where the use of handsets is prohibited.
- Follow the instructions given by the respective medical facility regarding the use of handsets on their premises.

Road Safety

- You must exercise proper control of your vehicle at all times. Give your full attention to driving.
- Observe all of the recommendations contained in your local traffic safety documentation.
- Pull off the road and park before making or answering a call, if driving conditions require so.
- Check if local laws and/or regulations restrict the use of handsets while driving.
- You **MUST NOT** stop on the hard shoulder of a motorway to answer or make a call, except in an emergency.
- Switch off your handset at a refueling point, such as a gas station, even if you are not refueling your own car.
- Do not store or carry flammable or explosive materials in the same compartment as the handset.
- Electronic vehicle systems, such as anti-lock brakes, speed control and fuel injection systems are not normally affected by radio transmissions. The manufacturer of such equipment can advise if it is adequately shielded from radio transmissions. If you suspect vehicle problems caused by radio transmissions, consult your dealer and do not switch on the handset until it has been checked by qualified approved installers.

Vehicles Equipped with an Airbag

An airbag inflates with great force. Do not place objects, including either installed or portable wireless equipment, in the area over the airbag or in the airbag deployment area. If in-vehicle wireless equipment is improperly installed and the airbag inflates, serious injury could result.

Third Party Equipment

The use of third party equipment, cables or accessories, not made or authorized by the manufacturer, may invalidate the warranty of your handset and also adversely affect the handset's operation. For example, use only the manufacturer mains cable supplied with the AC charger.

Declaration of Conformity

We declare under our sole responsibility that the product(s) detailed in this manual, and in combination with our accessories, conform to the essential requirements of European Union Directive 1999/5/EC Radio and Telecommunications Terminal Equipment Directive requirements 3.1(a), 3.1(b), 3.2.

Disposing of Your Phone



The  symbol on the equipment indicates that it must be the object of "separate collection".

Therefore, the customer has to contact local authorities to determine the proper disposal methods for that municipality or deliver it to the retailer in exchange for newly purchased equipment.

The separate collection of garbage and the successive operations of treatment, recovery and waste help in the production of equipment made with recycled material and limits the hazardous effects on the

atmosphere and health caused by improper management of garbage.

The illicit disposal of the product by the customer involves the application of the administrative endorsements of which to article 254 and following of the D.Lgs. 152, April 3rd 2006.

According to the article, the 13, D.Lgs. 25th July 2005, n. 151 “Performance of the Directives 2002/95/CE, 2002/96/CE and 2003/108/CE, relative to the reduction of the use of dangerous substances in the equipment electronic electrical workers and, let alone to the disposal of the refusals”.

Emergency Service



Notes:

Emergency service numbers vary by country. It helps you get emergency service from the operator.

To make an emergency call in any country:

1. Ensure that your handset is on and in service.
2. Press the **End Key** as many times as needed to clear the display and ready the device for calls.
3. Enter the local emergency number for your current location, for example, 911.
4. Press the **Send Key** to dial the number. Follow the instructions you receive and do not end the call until told to do so.

When the (U)SIM card is not inserted or when the dial lock function is on, press the **Right Soft Key [SOS]** and then enter the official emergency number for your present location. Press the **Send Key** or **OK Key [Call]** to dial the number.



Notes:

Tell the operator which service you require: Police, Ambulance, Fire Brigade, Coastguard or Mountain Rescue Service. Tell them where you are and remain stationary to maintain contact if possible.

Due to the nature of the cellular system, the connection of emergency calls cannot be guaranteed. You should never rely solely on any wireless device for essential communications like medical emergencies.

Privacy Information

Camera usage and photo/audio/video recordings carried out with the phone can offend the confidentiality of the subjects. The user therefore is held to respect legislation in matters of confidentiality and remains the only responsible subject in the case of eventual violations of the enforced norm.

Turn on the HAC Setting

When the HAC setting is on, your phone sends the audio from your phone calls to the telecoil rather than to the microphone of your hearing aid. You are likely to hear calls much better because volume is increased and background noise and feedback are diminished. The HAC setting improves only the calls you listen to through the earpiece. It does not affect calls heard on the speakerphone or a headset. It's better to turn off the Bluetooth function when the HAC setting is on. HAC requires extra battery power, so watch your battery consumption when it's turned on.



Caution:

Do not turn on the HAC setting unless you use a hearing aid with a telecoil. Using this setting without a hearing aid or with a hearing aid without a telecoil may be harmful to your hearing.

Copyright Notice

The video/audio recordings you make/download are protected by copyright laws. They are for personal use only and must not otherwise be used without the permission of the copyright owner.

Chapter 13

Troubleshooting and FAQs

If you encounter problems while using the phone, or if it performs erratically, you can consult the information in the chart below. If your particular problem cannot be resolved using the information in the chart, contact the dealer of handset.

Problem	Possible causes	Possible solution
Poor reception	The network signal is too weak at your current location, for example, in a basement or near a tall building, because wireless transmissions cannot effectively reach it.	Move to a location where the network signal can be properly received.
	The network is busy at the current time (for example, during peak times, there may be too much network traffic to handle additional calls).	Avoid using the phone at such times, or try again after waiting a short time.
	You are too far away from a base station for your service provider.	You can request a service area map from your service provider.
Echo or noise	Poor network trunk quality on the part of your service provider.	Press the End Key and dial again. You may be switched to a better-quality network trunk or phone line.
	Poor local telephone line quality.	Press the End Key and dial again. You may be switched to a better-quality network trunk or phone line.
Unable to select certain features.	Your service provider does not support these features, or you have not applied for services that provide these features.	Contact your service provider.
Battery will not charge.	The battery or battery charger is damaged.	Contact the dealer.
	The phone's temperature is below 0 °C or higher than 45 °C.	Adjust the battery charging environment to avoid extremes of temperature.
	Poor contact between the battery and charger.	Check all connectors to make sure all connections have been properly made.
Shortened standby time	The standby time is related to your service provider system configuration. The same phone used with different service providers' systems will not provide exactly the same length of standby time.	If you are located in an area where signaling is weak, temporarily switch off the phone.
	The battery is depleted. In high-temperature environments, battery life will be shortened.	Use a new battery.
	If you are not able to connect to the network, the phone will continue to send out signals as it attempts to locate a base station. Doing so consumes battery power and will consequently shorten standby time.	Change your location to one where the network is accessible, or temporarily turn off your phone.
You cannot switch your phone on.	Battery power has been depleted.	Recharge the phone's battery.
(U)SIM card error	(U)SIM card malfunction or damage.	Take the (U)SIM card to your service

Problem	Possible causes	Possible solution
		provider for testing.
	(U)SIM card inserted improperly.	Insert the (U)SIM card properly.
	Debris on the (U)SIM card contacts.	Use a soft, dry cloth to clean the (U)SIM card contacts.
Unable to connect to the network.	(U)SIM card invalid.	Contact your service provider.
	You are not within the network's service area.	Check the service area with your service provider.
	Poor signal.	Move to an open space, or if you are inside a building, move closer to a window.
PIN code is blocked.	You have entered an incorrect PIN code three consecutive times.	Contact your service provider. If the service provider provides the (U)SIM card's PUK code, use the PUK code to unlock the (U)SIM card.
Unable to enter information into the phone book.	The phone book's memory is already full.	Delete unnecessary data from the Directory.

Chapter 14

Specifications

Handset specifications are shown in the following table.

Handset Standards	WCDMA 850MHz,1900MHz HSDPA GSM 850MHz, 900MHz, 1800MHz and 1900MHz
Dimensions (H×W×D)	Approx 95.6 mm × 48.7 mm× 18.5 mm
Weight	Approx 51.9g (including battery)
Display	2.0" TFT color screen
Front camera	0.3 M pixel camera
Back camera	N/A
Extended memory	N/A
Battery	900 mA hours, Lithium ion (Li-ion)
Performance	BMP/JPG/GIF image; 3GP/MP4 video; MP3/AMR/WAV/ACC/ACC+ audio; USB 1.1; JAVA MIDP 2.0; MMS Video and Picture, Email, Calendar, Speakerphone, Voice Recorder, Bluetooth
Continuous idle time	Up to 200 hours
Continuous talk time	About 180 minutes
Charge time	Approximately 3 hours



Notes:

The phone's talk time and idle time are based on ideal working environments. The use of extended backlighting, browser, and network conditions can reduce battery life and talk/idle time.

Chapter 15

FCC Compliance

- This mobile phone complies with part 15 of the FCC Rules. Operation is subject to the following two conditions: (1) This device may not cause harmful interference, and (2) this device must accept any interference received, including interference that may cause undesired operation.

- This device has been tested and found to comply with the limits for a Class B digital device, pursuant to Part 15 of the FCC Rules. These limits are designed to provide reasonable protection against harmful interference in a residential installation. This equipment generates, uses and can radiate radio frequency energy and, if not installed and used in accordance with the instructions, may cause harmful interference to radio communications. However, there is no guarantee that interference will not occur in a particular installation. If this equipment does cause harmful interference to radio or television reception, which can be determined by turning the equipment off and on, the user is encouraged to try to correct the interference by one or more of the following measures:
 - ▶ Reorient or relocate the receiving antenna.
 - ▶ Increase the separation between the equipment and receiver.
 - ▶ Connect the equipment to an outlet on a circuit different from that to which the receiver is connected.
 - ▶ Consult the dealer or an experienced radio/TV technician for help.
 - ▶ Changes or modifications not expressly approved by the party responsible for compliance could void the user's authority to operate the equipment.

- The antenna(s) used for this transmitter must not be co-located or operating in conjunction with any other antenna or transmitter.

Chapter 16

Radio Frequency (RF) Energy

- This model device meets the government's requirements for exposure to radio waves.
- This device is designed and manufactured not to exceed the emission limits for exposure to radio frequency (RF) energy set by the Federal Communications Commission of the U.S. Government.
- The exposure standard for wireless devices employs a unit of measurement known as the Specific Absorption Rate or SAR. The SAR limit set by the FCC is 1.6W/kg.
- Tests for SAR are conducted using standard operating positions accepted by the FCC with the device transmitting at its highest certified power level in all tested frequency bands. Although the SAR is determined at the highest certified power level, the actual SAR level of the device while operating can be well below the maximum value. This is because the device is designed to operate at multiple power levels so as to use only the power required to reach the network. In general, the closer you are to a wireless base station antenna, the lower the power output.
- The highest SAR value for the model phone as reported to the FCC when tested for use at the ear is 0.622 W/kg and when worn on the body, as described in this user guide, is 0.667 W/kg (Body-worn measurements differ among phone models, depending upon available accessories and FCC requirements.)
- While there may be differences between the SAR levels of various devices and at various positions, they all meet the government requirement.
- The FCC has granted an Equipment Authorization for this model device with all reported SAR levels evaluated as in compliance with the FCC RF exposure guidelines. SAR information on this model device is on file with the FCC and can be found under the Display Grant section of <http://www.fcc.gov/oet/fccid> after searching on:
- FCC ID: **Q78-Z221**.
- For body worn operation, this modem has been tested and meets the FCC RF exposure guidelines for use with an accessory that contains no metal and positions the handset a minimum of 1.5 cm from the body. Use of other enhancements may not ensure compliance with FCC RF exposure guideline.

The operating temperature for the device is from -10°C to 50°C.

