

**Z796C
User Manual**

About This Manual

Thank you for choose this ZTE mobile device. In order to keep your device in its best condition, please read this manual and keep it for future reference.

Copyright

Copyright © 2013 ZTE CORPORATION

All rights reserved.

No part of this publication may be quoted, reproduced, translated or used in any form or by any means, electronic or mechanical, including photocopying and microfilm, without the prior written permission of ZTE Corporation.

Notice

ZTE Corporation reserves the right to make modifications on print errors or update specifications in this guide without prior notice. This manual has been designed with the utmost care to ensure the accuracy of its content. However, all statements, information and recommendations contained therein do not constitute a warranty of any kind, either expressed or implied. Please refer to chapter [For Your Safety](#) to be sure to use your phone properly and safely.

We offer self-service for our smart terminal device users. Please visit the ZTE official website (at www.zte.com.cn) for more information on self-service and supported product models. Information on the website takes precedence.

Disclaimer

ZTE Corporation expressly disclaims any liability for faults and damages caused by unauthorized modifications of the software. Images and screenshots used in this manual may differ from the actual product. Content in this manual may differ from the actual product or software.

Trademarks

ZTE and the ZTE logos are trademarks of the ZTE Corporation. Google and Android are trademarks of Google, Inc.

The *Bluetooth*[®] trademark and logos are owned by the Bluetooth SIG, Inc. and any use of such trademarks by ZTE Corporation is under license.

The microSD logo  is a trademark of the SD Card Association.

Other trademarks and trade names are the property of their respective owners.

Version No.: R1.0

Edition Time : 2013.03.13

Contents

Z796C	1
User Manual	1
About This Manual	2
Copyright	2
Copyright © 2013 ZTE CORPORATION	2
All rights reserved	2
Notice	2
Disclaimer	3
Trademarks	3
Version No.: R1.0	3
Contents	4
Getting Started	12
Getting to Know Your Phone	12
Knowing the Keys.....	14
Installing the microSD Card and Battery.....	14
Charging the Battery.....	16
Powering On/Off	17
Setting Up for the First Time.....	17
Locking/Unlocking the Screen and Keys	18
Using the Touch Screen	19

Getting to Know the Home Screen	20
Personalizing	23
Changing the System Language.....	23
Setting the Date and Time	23
Changing Ringtone.....	23
Changing Notification Sound	24
Turning On/Off Touch Sounds.....	24
Adjusting Volumes	24
Switching to Silent Mode	25
Applying New Wallpapers	25
Changing Screen Brightness.....	26
Protecting Your Phone With Screen Locks	26
Protecting Your Phone With Encryption	27
Knowing the Basics.....	29
Monitoring the Phone Status.....	29
Managing Notifications	30
Managing Shortcuts and Widgets	32
Organizing With Folders	33
Rearranging the Favorites Tray	34
Entering Text.....	34
Editing Text	40
Opening and Switching apps	41
Connecting to Networks and Devices.....	42
Connecting to Mobile Networks	42
Connecting to Wi-Fi	43

Connecting to Bluetooth Devices	45
Connecting to Your Computer via USB.....	47
Connecting to Virtual Private Networks	49
Phone Calls	52
Placing and Ending Calls.....	52
Answering or Rejecting Calls.....	53
Working With the Call Log.....	53
Calling Your Contacts	55
Checking Voicemail	56
Using Options During a Call	56
Managing Multi-party Calls.....	57
Adjusting Your Call Settings	58
People	62
Checking Contact Details	62
Adding a New Contact.....	62
Setting Up Your Own Profile	63
Importing, Exporting, and Sharing Contacts	63
Working With Favorite Contacts	65
Working With Groups	65
Searching for a Contact.....	67
Editing Contacts	67
Accounts.....	71
Adding or Removing Accounts.....	71
Configuring Account Sync	72
Email	74

Set Up the First Email Account	74
Checking Your Emails	74
Responding to an Email.....	75
Writing and Sending an Email.....	76
Adding Signature to Your Emails	77
Adding and Editing Email Accounts	77
Changing General Email Settings.....	78
Gmail™	79
Opening Your Gmail Inbox.....	79
Switching Accounts.....	79
Writing and Sending a Message	80
Adding Signature to Your Gmail Messages	80
Replying to or Forwarding a Message	81
Working With Received Attachments	81
Searching for Messages	82
Working With Labels.....	82
Changing Gmail Settings	83
Messaging	85
Opening the Messaging Screen.....	85
Sending a Text Message.....	85
Sending a Multimedia Message.....	86
Replying to a Message	86
Forwarding a Message	87
Viewing Details About a Message.....	87
Deleting Messages or Threads	87

Changing Message Settings.....	88
Calendar	89
Viewing Your Calendars and Events.....	89
Creating an Event.....	91
Editing or Deleting an Event.....	91
Changing Calendar Settings.....	92
Google+	93
Organizing Your Contacts.....	93
Getting Updates	93
Chatting With Contacts.....	94
Checking Photos	94
Checking and Managing Your Profile	95
Browser	96
Opening the Browser.....	96
Working With an Opened Page	97
Using Multiple Browser Tabs	99
Downloading Files	99
Using Bookmarks	99
Viewing Your Browsing History.....	101
Changing Browser Settings	101
Maps, Navigation, Local, and Latitude	102
Activating Location Services.....	102
Getting Your Location	102
Searching for a Location.....	103
Getting Directions to Your Destination.....	103

Searching for Local Places	104
Sharing Location	105
Google Search and Voice Search.....	106
Searching With Text	106
Searching by Speaking	106
Changing Search and Voice Search Settings	107
Camera	108
Capturing a Photo	108
Customize Camera Settings	109
Recording a Video	110
Customizing Camcorder Settings	112
Gallery	113
Opening Gallery	113
Working With Albums	113
Working With Pictures	114
Working With Videos	116
Music	118
Copying Music Files to Your Phone	118
Viewing Your Music Library	119
Playing Music	120
Managing Playlists	121
Play Music	123
Playing Your Music	123
Managing Playlists	125

Video Player	127
Opening the Video Library	127
Playing and Controlling Videos.....	127
Managing Video Files	128
Sound Recorder	129
Recording a Voice Memo	129
Playing a Voice Memo.....	129
More Apps.....	130
Alarm	130
Backup and Restore	131
Calculator	131
Downloads.....	131
File Manager	132
Full Share	132
NotePad	133
Play Books	134
Play Movies & TV	134
Task Manager.....	135
Timer	135
World Time	135
YouTube	135
Play Store	136
Browsing and Searching for Apps.....	136
Downloading and Installing Apps.....	136
Managing Your Downloads.....	137

Settings	138
General Settings	138
Wireless and Networks	141
Device.....	141
Accounts	143
Personal	143
System.....	145
Upgrading the Phone Software	147
Troubleshooting.....	148
For Your Safety	153
General Safety	153
Radio Frequency (RF) Exposure for CE	154
National Restrictions on Wi-Fi Usage	160
Distraction.....	161
Product Handling	162
Electrical Safety	166
Radio Frequency Interference	167
Explosive Environments.....	169

Getting Started

Getting to Know Your Phone

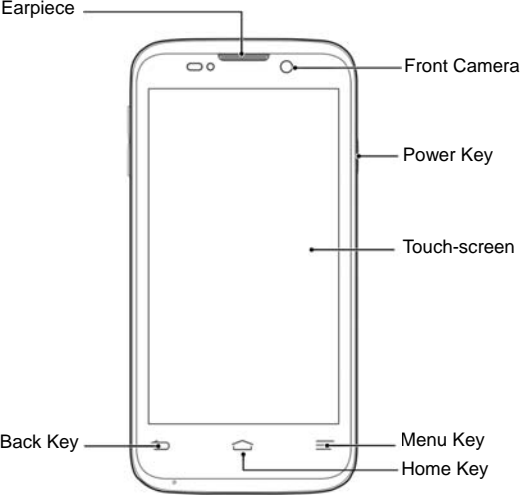

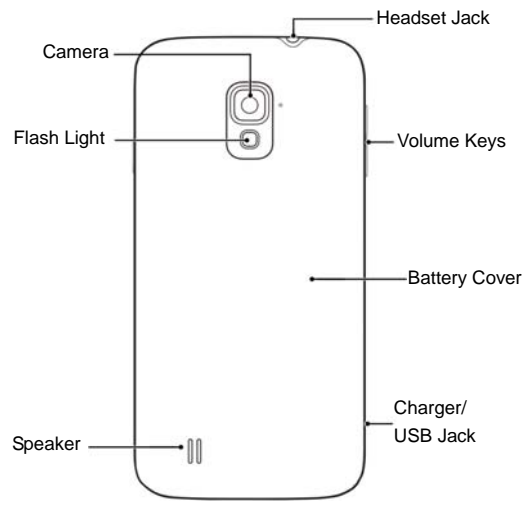

Knowing the Keys

Key	Function
Power Key	<ul style="list-style-type: none">• Press and hold to turn on or off Flight mode, enable silent mode, vibration mode or sound, power off, or to restart the phone.• Press to switch your phone to Sleep mode.• Press to wake up your phone.
Home Key	<ul style="list-style-type: none">• Touch to return to the Home Screen from any application or screen.• Touch and hold to see recently used applications.
Menu Key	Touch to get the options for the current screen.
Back Key	Touch to go to the previous screen.
Volume Keys	Press or hold to turn the volume up or down.

Installing the microSD Card and Battery

Switch off your phone before installing or replacing the battery. The microSD card can be installed and removed while the phone is turned on. [Unmount the microSD card](#) before removing it.

1. Place your finger in the slot at the bottom of the back cover to lift and remove the cover.

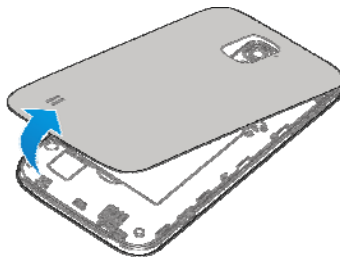

2. Insert the battery by aligning the metal contacts on the battery with the gold contacts in the battery compartment. Gently push down on the battery until it clicks into place.

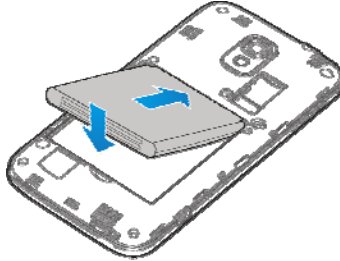

WARNING! Do not handle a damaged or leaking Li-Ion battery as you can be burned.

3. Hold your microSD card with the metal contacts facing down

and slide it into the microSD card slot.

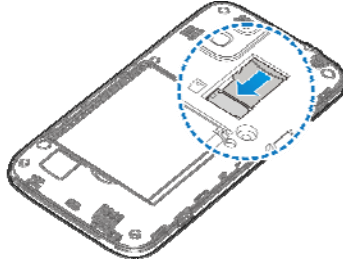

NOTE: Your phone may come with a pre-installed microSD card. Some applications may not function normally after you remove the card, pre-installed or otherwise.

4. Press the cover gently back into place until you hear a click.

Charging the Battery

When you first get your new phone you'll need to charge the battery.



If the battery is low, there will be a pop-up message on the screen. As you charge your phone, the screen will tell you the exact battery level each time you wake up your phone.

WARNING! Use only ZTE-approved chargers and cables. The use of unapproved accessories could damage your phone or cause the battery to explode.

1. Connect the adapter to the charging jack. Ensure that the

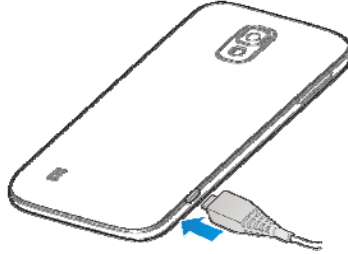
adapter is inserted with the correct orientation. Do not force the connector into the charging jack.



2. Connect the charger to a standard AC wall outlet. If the phone is on, you'll see a charging icon, such as  or  , appear on the status bar.
3. Disconnect the charger when the battery is fully charged.

Powering On/Off

- Press and hold the **Power Key** to turn on your phone.
- To turn it off, press and hold the **Power Key** to open the options menu. Touch **Power off** and then touch **OK**.

Setting Up for the First Time

When you first power on your phone after you purchase it or reset it to factory settings (see [Settings – Personal – Backup & Reset](#)), you may need to do some settings before using it.

1. Touch the language field to select the language you want to use and then touch **Start**.
2. Set the date, time, and time zone, or use date and time data provided by the network. Then touch **Next**.
3. Touch **Get an account** to create a Google account or touch **Sign in** to sign in to your account.
You can also touch **Not now** to set up an account later.
4. Configure the Google location options and touch **Next**.
5. Enter your name which the phone uses to personalize some apps and touch **Next**.
6. You will be prompted to accept the terms of Google service. Touch **Next** to continue.
7. Touch **Finish** to complete the setup.

NOTE: If the phone is not activated, it would prompt you to connect to a Wi-Fi network before asking you to sign in to a Google account.

Locking/Unlocking the Screen and Keys

Your phone allows you to quickly lock the screen and keys (put the phone to sleep mode) when not in use and to turn the screen back on and unlock it when you need it.

To lock the screen and keys:

To quickly turn the screen off and lock the keys, press the **Power**

Key.

NOTE: To save battery power, the phone automatically turns off the screen after a certain period of time when you leave it idle. You will still be able to receive messages and calls while the phone screen is off.

To unlock the screen and keys:

1. Press the **Power Key** to turn the screen on.
2. Touch and hold  at the center of the screen.

NOTE: If you have set an unlock pattern, PIN or password for your phone (see chapter [Personalizing – Protecting Your Phone With Screen Locks](#)), you'll need to draw the pattern or enter the PIN/password to unlock your screen.

Using the Touch Screen

Your phone's touch screen lets you control actions through a variety of touch gestures.

- **Touch**
When you want to type using the onscreen keyboard, select items onscreen such as application and settings icons, or press onscreen buttons, simply touch them with your finger.
- **Touch and Hold**
To open the available options for an item (for example, a message or link in a Web page), touch and hold the item.
- **Swipe or Slide**

To swipe or slide means to quickly drag your finger vertically or horizontally across the screen.

- Drag

To drag, press and hold your finger with some pressure before you start to move your finger. While dragging, do not release your finger until you have reached the target position.

- Pinch

In some apps (such as Maps, Browser, and Gallery), you can zoom in and out by placing two fingers on the screen at once and pinching them together (to zoom out) or spreading them apart (to zoom in).

- Rotate the screen

For most screens, you can automatically change the screen orientation from portrait to landscape by turning the phone sideways.

Getting to Know the Home Screen

The home screen is the starting point for your phone's applications, functions, and menus. You can customize your home screen by adding application icons, shortcuts, folders, widgets, and more. Your home screen extends beyond the initial screen. Swipe the screen left or right to display additional screens.



Extended Home Screens

Your home screen extends beyond the initial screen, providing more space to add icons, widgets, and more. Simply swipe left or right on the screen to see the extended Home Screens.

To add or remove an extended Home Screen:

1. Touch the **Home Key** to return to the Home Screen.
2. Touch the **Menu Key > Customization > Screen edit**.
3. Touch **+** to add more extended Home Screens.
Touch **-** on a thumbnail to remove a screen.

To adjust the order of an extended Home Screen:

1. Touch the **Home Key** to return to the Home Screen.
2. Touch the **Menu Key > Customization > Screen edit**.
3. Touch and hold a thumbnail and drag it to change the place with other screens.

Changing the System Language

1. Touch the **Home Key > Menu Key > System settings > Language & input > Language**.
2. Select the language you need.

Setting the Date and Time

1. Touch the **Home Key > Menu Key > System settings > Date & time**.
2. Uncheck **Automatic date & time** and **Automatic time zone** if you want to set the date, time and time zone by yourself.
3. Set the date, time, time zone, and date/time format.

Changing Ringtone

You can customize the default ringtone for incoming calls by taking the following steps.

1. Touch the **Home Key > Menu Key > Customization**.
2. Touch **Phone ringtone**.
3. Scroll through the ringtone list and select the ringtone you want to use.
4. Touch **OK**.

TIP: See chapter [People – Editing Contacts – Set a Ringtone for a Contact](#) for how to assign a special ringtone to an individual contact.

Changing Notification Sound

You can customize the default notification sound by taking the following steps.

1. Touch the **Home Key > Menu Key > Customization**.
2. Touch **Notification ringtone**.
3. Scroll through the list and select the ringtone you want to use.
4. Touch **OK**.

Turning On/Off Touch Sounds

1. Touch the **Home Key > Menu Key > System settings > Sound**.
2. Check or uncheck **Touch sounds**.

Adjusting Volumes





1. Touch the **Home Key > Menu Key > System settings > Sound > Volumes**.
2. Drag the sliders to adjust the volume for each type of audio.
3. Touch **OK** to save.

TIP: You can adjust the media volume when a media application is in use by pressing the **Volume Up/Down Key**. If no media

application is active, press the **Volume Up/Down Key** to adjust ringtone volume (or the earpiece volume during a call).

Switching to Silent Mode

You can set the phone to silent mode by using one of the following methods.

- Press and hold the **Power Key** and then touch  to enable silent mode, touch  to enable silent mode with vibration, or touch  to disable silent mode.
- Keep pressing the **Volume Down Key** when no media application is active. When the  icon appears in the status bar, the phone is set to silent mode with vibration. When the  icon appears in the status bar, the phone is in silent mode.
- Touch the **Home Key > Menu Key > System settings > Sound > Silent mode**, and touch **Off, Vibrate** or **Mute**.

Applying New Wallpapers

You can set the wallpaper for the Home Screen or Lock Screen.

1. Touch the **Home Key > Menu Key > Wallpaper**.
2. Touch **Home** or **Lock screen**.
3. Select a wallpaper source from **Gallery, Live Wallpapers**, or **Wallpapers** and choose the image or animation you want to use as the wallpaper. Some cropping may be needed for **Gallery** images.

4. Touch **Set wallpaper**.

NOTE: **Live Wallpapers** are not available for the Lock Screen.

Changing Screen Brightness

1. Touch the **Home Key > Menu Key > System settings > Display > Brightness**.
2. Check the **Automatic brightness** box to make the phone adjust the screen brightness automatically, or clear the check box to adjust the brightness manually.
3. Touch **OK**.

Protecting Your Phone With Screen Locks

You can protect your phone by creating a screen lock. When enabled, you need to draw a pattern or enter a numeric PIN or password to unlock the phone's screen and keys.

1. Touch the **Home Key > Menu Key > System settings > Security**.
2. Touch **Screen lock**.
3. Touch **Pattern, PIN** or **Password**.
 - ▶ If you touch **Pattern**, you're guided to create a pattern you must draw to unlock the screen. The first time you do this, a short tutorial about creating an unlock pattern appears. Then you're prompted to draw and redraw your own pattern.

- ▶ If you touch **PIN** or **Password**, you're prompted to set a numeric PIN or a password you must enter to unlock your screen.

The next time you turn on your phone or wake up the screen, you must draw your unlock pattern or enter your PIN or password to unlock it.

IMPORTANT: If you forget the pattern you set, try five times and touch **Forget pattern?** to sign in to the Google Account you have added on the phone and reset the screen lock. You need an active Internet connection. You can also upgrade the phone software. See [Upgrading the Phone Software](#).

Protecting Your Phone With Encryption

You can encrypt all the data on your phone: Google Accounts, application data, music and other media, downloaded information, and so on. If you do, you must enter a numeric PIN or password each time you power on your phone.

WARNING! Encryption is irreversible. The only way to revert to an unencrypted phone is to perform a factory data reset, which erases all your data.

Encryption provides additional protection in case your phone is stolen, and may be required or recommended in some organizations. Consult your system administrator before turning it on. In many cases the PIN or password you set for encryption is controlled by the system administrator.

Before turning on encryption, prepare as follows:

1. Set a lock screen PIN or password.

2. Charge the battery.
3. Keep the phone connected to the charger.
4. Schedule an hour or more for the encryption process: you must not interrupt it or you will lose some or all of your data.

When you're ready to turn on encryption:

1. Touch the **Home Key > Menu Key > System settings > Security > Encrypt phone**.

2. Read the information about encryption carefully.

The **Encrypt phone** button is dimmed if your battery's not charged or your phone's not plugged in.

If you change your mind about encrypting your phone, touch the **Back Key**.

WARNING! If you interrupt the encryption process, you will lose data.

3. Touch **Encrypt phone**.
4. Enter your lock screen PIN or password and touch **Next**.
5. Touch **Encrypt phone** again.

The encryption process starts and displays its progress.

Encryption can take an hour or more, during which time your phone may restart several times.



















When encryption is completed, you're prompted to enter your PIN or password.

Subsequently, you must enter your PIN or password each time you power on your phone, to decrypt it.

Knowing the Basics

Monitoring the Phone Status





















The status bar at the top of the home screen provides phone and service status icons on the right side. Below are some of the icons you may see.

	GPRS connected		No signal
	EDGE connected		Signal strength
	3G connected		Mobile data in use
	Flight mode		Ringer off
	Battery dead		Vibrate mode
	Battery low		Bluetooth on
	Battery partially drained		Connected to a Wi-Fi network
	Battery full		Wi-Fi in use
	Battery charging		Wired headset connected
	Alarm set		

Managing Notifications

Notification Icons

The status bar at the top of the home screen provides notification icons on the left. Below are some of the icons you may see.

	New SMS		microSD card unmounted
	New MMS		microSD card removed
	New Email		Upcoming event
	New Gmail message		Call on hold
	New Google Talk instant message		New Wi-Fi network detected
	Problem with SMS/MMS delivery		Downloading/Saving/Download data
	Missed call		Sending data
	Call in progress		USB tethering is on
	USB connected		Wi-Fi direct is on
	Song is playing		GPS on
	Updates available		

Open/Close the Notification Panel

Notifications report the arrival of new messages, calendar events, and alarms, as well as ongoing events, such as when you've configured your phone as a Wi-Fi device. You can open the notification panel to view the details of notifications.

- To open the notification panel, swipe your finger down from the top of the screen.
- To close the notification panel, swipe your finger up from the bottom of the screen or touch the **Back Key**.

Respond to or Remove a Notification

In the notification panel, you can respond to a notification or remove the notifications.

- To respond to a notification, just touch it.
- To remove a notification, swipe it left or right.
- To remove all notifications, touch  in the top right corner.
- Most apps that send notifications, such as Gmail and Google Talk, have notification settings that you can adjust.

TIP: In the notification panel, touch  at the top of notifications list to get to the **Settings** menu quickly.

Managing Shortcuts and Widgets

Add Shortcuts and Widgets

1. Touch the **Home Key** >  > **Widgets**.
2. Touch **Widgets** or **Shortcuts** to view the available widgets and shortcuts.
3. Touch and hold a widget or shortcut and drag it to the Home Screen.

Move Shortcuts or Widgets

1. Touch and hold a widget or shortcut on the Home Screen.
2. Drag it to the place you need.

Remove Shortcuts or Widgets

1. Touch and hold a widget or shortcut on the Home Screen.
2. Drag it to  **Remove** to remove it.

Adjust Widget Size



1. Touch and hold a widget on the Home Screen and then release it.
2. An outline appears around the widget. Drag the outline to resize the widget.

NOTE: Not all widgets can be resized.

Organizing With Folders

You can create folders on the Home Screen and add several shortcuts in a folder.

Create a Folder

1. Touch and hold the shortcut on the Home Screen you want to add into a folder until  folder appears.
2. Drag the shortcut to  folder and release it. A new folder will be created and the shortcut is added into the folder.

Rename a Folder

1. Touch a folder to open it.
2. Touch the folder name field and enter a new name.

Add Shortcuts to a Folder

1. Touch and hold a shortcut and then drag it onto a folder icon.
2. Release the shortcut and it will be added into the folder.

Remove Shortcuts From a Folder

1. Touch a folder to open it.
2. Touch and hold the shortcut you want to remove and then drag it to the Home Screen.
3. Release the shortcut and it will be removed from the folder.

Rearranging the Favorites Tray

The Home Screen includes a customizable favorites tray at the bottom visible from all Home Screens. You can drag apps, shortcuts, folders, and other priority items in or out of the favorites tray for instant access from any Home Screen.



To remove items from the favorites tray:

Touch and hold an item in the favorites tray and drag it out of the tray.

To add items to the favorites tray:

Touch and hold an item on the Home Screen and drag it into the favorites tray.

If the favorites tray is full, you need to remove an item in the tray.

Entering Text

You can enter text using the onscreen keyboard. Some apps open it automatically. In others, you open it by touching where you want to type. You can touch the **Back Key** to hide the onscreen keyboard.

Change Input Methods





1. When you use the onscreen keyboard to enter text, the icon  appears on the notification bar.

2. Open the notification panel and touch **Choose input method**.
3. Select an input method you need.







Android Keyboard

The Android Keyboard provides a layout similar to a desktop computer keyboard. Turn the phone sideways and the keyboard will change from portrait to landscape. The landscape keyboard is not supported in all applications.



- Touch the alphabetic keys to enter letters. Touch and hold some specific keys to enter associated accented letters or numbers. For example, to enter è, touch and hold  and the available accented letters and number 3 appear. Then slide to choose è.
- Touch  to use uppercase. Double-tap  to lock uppercase. This key also changes to indicate the current case you are using:  for lowercase,  for uppercase,

and  when locked in uppercase.

- Touch  to delete the text before the cursor.
- Touch  to select numbers and symbols. You can then touch  to find more. Also, often used symbols are displayed above the keyboard.
- Touch and hold  and then swipe to choose the emoticons.
- Touch  to use Google's networked voice input.
- Touch and hold  to change the input languages or set up the Android keyboard.

Google Voice Typing

Use Google's networked voice input.

Swype

While you can touch the onscreen keyboard to enter text, Swype Text Input can also speed up text input with a tracing finger gesture where you move your finger from letter to letter without lifting the finger until you reach the end of the word.











- Touch the alphabetic keys to enter letters. Touch and hold a key to enter the number or symbol located on the top of the key. Keep holding the key to bring up a series of characters available on that key, including associated accented letters, symbols or numbers.

For example, in English mode, touch and hold **T** to enter **5**. Keep holding **T** to open a character and number list. You can select to enter **T**, **þ**, **^**, or **5**.

- Touch **⇧** to use uppercase or lowercase. This key also indicates the current case: **⇩** for lowercase, **⇧** for uppercase, and **⇧** when locked in uppercase.
- Touch **EN** to change the text input language. Touch and hold this key to open a pop-up menu for language selection.
- Touch **123** to select numbers and symbols. Touch **123** to enter the alternate symbol on a key. Touch **123** to go back to enter letters. Touch and hold **123** to open a simple keyboard and

you can enter numbers and certain symbols.

- Hold  until appear  or hold  on numbers and symbols interface to open an emoticon list.
- Touch  to delete a character before the cursor. Touch and hold  to delete an entire word.
- Touch  to start a new line.
- Touch  to use voice input.
- Touch and hold  to open the Swype settings.

To enter text via Swype:

Move your finger from letter to letter to trace a word without lifting the finger until you reach the end of the word.

The following example shows how to enter the word "here". Put your finger on "h", and without lifting, slide it to "e", and then to "r", and back to "e". When complete, lift your finger off the screen and the matched words are displayed.



Tips for using Swype Text Input:



- To enter double letters, scribble slightly or make a loop on the letter. For example, to get the "ll" in "hello", scribble (or make a loop) on the "l" key.
- Lift your finger at the end of the word. A space is added automatically when you "Swype" the next word.

Touch Input Settings

Choose the touch input settings by touching the **Menu Key > System settings > Language & input** from the Home Screen.

In the **KEYBOARD & INPUT METHODS** section, you can set the default input method and choose the settings for input methods.

Editing Text

- **Move the insertion point:** Touch where you want to type. The cursor blinks in the new position, and a tab appears below it. Drag the tab to move the cursor.
- **Select text:** Touch and hold or double-tap within the text. The nearest word highlights, with a tab at each end of the selection. Drag the tabs to change the selection.
- **Cut or copy:** Select the text you want to manipulate. Then touch the Cut  or Copy  button to cut or copy the text to the clipboard.
- **Replace text with the clipboard text:** Select the text you want to replace. Then touch  or **PASTE**.



- **Insert text from the clipboard:** Move cursor to the insertion point and then touch and hold the tab below the cursor. Release the finger and touch **PASTE**.

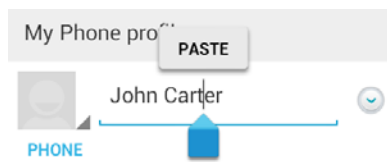

Opening and Switching apps

Open an App

1. Touch the **Home Key** > .
2. Slide left or right on the screen and touch an app to open it.

Switch Between Recently Opened Apps

1. Touch and hold the **Home Key**.
A list of the names and thumbnails of apps you've used recently opens. If you've been using more apps recently than can fit on the screen, you can scroll the list up and down.
2. Touch a thumbnail to open that app.
You can swipe a thumbnail sideways to remove it from the list.

Connecting to Mobile Networks

Control Mobile Data Use

To enable or disable data access:

1. Touch the **Home Key > Menu Key > System settings > Mobile networks**.
2. Check **Data enabled** to enable data access over the mobile network. Clear the check box to disable data access.

To enable always-on data access:

1. Touch the **Home Key > Menu Key > System settings > Mobile networks**.
2. Check **Enable Always-on mobile data** to allow applications to update data automatically.

IMPORTANT: When you enable this option, more data traffic will be generated for automatic updates of applications data. And your phone will consume more power.

To get data services when roaming:

1. Touch the **Home Key > Menu Key > System settings > Mobile networks**.
2. Check **Data roaming**.

IMPORTANT: Data roaming may incur significant roaming

charges.

Connecting to Wi-Fi

Wi-Fi is a wireless networking technology that can provide Internet access at distances of up to 100 meters, depending on the Wi-Fi router and your surroundings.

Turn Wi-Fi On and Connect to a Wi-Fi Network

1. Touch the **Home Key > Menu Key > System settings > Wi-Fi**.
2. Slide the **Wi-Fi** switch to the **ON** position to turn on Wi-Fi.
3. Touch a network name to connect to it.
4. If the network is secured, enter the password and touch **Connect**.

NOTE: Your phone automatically connects to previously used Wi-Fi networks when they are in range.

Get Notified of Open Networks

1. Touch the **Home Key > Menu Key > System settings > Wi-Fi**.
2. Slide the **Wi-Fi** switch to the **ON** position.
3. Touch the **Menu Key > Advanced**.
4. Check **Network notification**.
When Wi-Fi is on, you receive notifications in the Status bar

when your phone detects an open Wi-Fi network. Uncheck the option to turn off notifications.

Add a Wi-Fi Network

You can add a Wi-Fi network if the network does not broadcast its name (SSID), or to add a Wi-Fi network when you are out of range.

To connect to a secured network, you first need to get the security details from the network's administrator.

1. Touch the **Home Key > Menu Key > System settings > Wi-Fi**.
2. Slide the **Wi-Fi** switch to the **ON** position.
3. Touch **Add network**.
4. Enter the network SSID (name). If necessary, enter security or other network configuration details.
5. Touch **Save**.

Forget a Wi-Fi Network

You can make your phone forget about the details of a Wi-Fi network that you added - for example, if you don't want the phone to connect to it automatically or if it is a network that you no longer use.

1. Touch the **Home Key > Menu Key > System settings > Wi-Fi**.
2. Slide the **Wi-Fi** switch to the **ON** position.
3. Touch the Wi-Fi network name and then touch **Forget**.

Adjusting Advanced Wi-Fi Settings

1. Touch the **Home Key > Menu Key > System settings > Wi-Fi**.
2. Touch the **Menu Key > Advanced** to adjust the following settings.
 - ▶ **Network notification:** Get notifications in the status bar when Wi-Fi is on and an open network is available.
 - ▶ **Keep Wi-Fi on during sleep:** Set whether to keep Wi-Fi on in sleep mode.
 - ▶ **Avoid no internet connections:** Only use Wi-Fi network when the Internet connection is good.
 - ▶ **MAC address:** Check the MAC address.
 - ▶ **IP address:** Check the phone's IP address.

Connecting to Bluetooth Devices

Bluetooth[®] is a short-range wireless communication technology. Phones or other devices with Bluetooth capabilities can exchange information wirelessly within a distance of about 10 meters. The Bluetooth devices must be paired before the communication is performed.

Turn Bluetooth On/Off

1. Touch the **Home Key > Menu Key > System settings > Bluetooth**.
2. Slide the **Bluetooth** switch to the **ON** or **OFF** position.

When Bluetooth is on, the  icon will appear in the status bar.

Change the Device Name

1. Touch the **Home Key > Menu Key > System settings > Bluetooth**.
2. Slide the **Bluetooth** switch to the **ON** position if Bluetooth is off.
3. Touch the **Menu Key > Rename phone**.
4. Edit the name and touch **Rename**.

Pair With Another Bluetooth Device

1. Touch the **Home Key > Menu Key > System settings > Bluetooth**.
2. Slide the **Bluetooth** switch to the **ON** position if Bluetooth is off.
Your phone automatically scans for and displays the IDs of all available Bluetooth devices in range. You could touch **SEARCH FOR DEVICES** if you want to scan again.
3. Touch the device you want to pair with.
4. Confirm that the Bluetooth passkeys are the same between the two devices and touch **Pair**. Alternately, enter a Bluetooth passkey and touch **Pair**.

Pairing is successfully completed when the other device accepts the connection or the same passkey is entered.

NOTE: The Bluetooth passkey may be fixed for certain devices, such as headsets and handsfree car kit. You can try entering

0000 or 1234 (the most common passkeys), or refer to the documents for that device.

Send Data via Bluetooth

1. Open the appropriate application and select the file or item you want to share.
2. Select the option for sharing via Bluetooth. The method may vary by application and data type.
3. Touch a Bluetooth device the phone has paired with or wait for it to search for new devices and touch one of them.

Receive Data via Bluetooth

1. Turn Bluetooth on before trying to receive data via Bluetooth.

NOTE: If the phone has not been paired with the sending device, you may need to touch **Bluetooth > [your phone's name]** in **Settings** to keep the phone detectable through Bluetooth.

2. Flick down the status bar and touch .
3. Touch **Accept** to start receiving the data.

Received files are stored automatically in a dedicated folder (*Bluetooth*, for instance). You can access them with the **File Manager** app. Received contacts (vCard files) are automatically imported to your contact list.

Connecting to Your Computer via USB

You can connect your phone to a computer with a USB cable and

transfer music, pictures, and other files in both directions. Your phone stores these files in internal storage or on a removable microSD card.

If you are using USB tethering, you must turn that off before you can use USB to transfer files between your phone and computer.

Connect Your Phone to a Computer via USB

1. Connect your phone to the PC with a USB cable.
2. Open the Notification panel and touch **Connected as an installer**.
3. Choose one of the following options:
 - ▶ **Media device (MTP):** Transfer media files on Windows, or using Android File Transfer on Mac.
 - ▶ **Camera (PTP):** Transfer photos using camera software, and transfer any files on the computers that don't support MTP.

Connect With Windows Media Player

You can sync music on your phone and the computer installed with Windows Media Player.

1. Connect the phone with your computer via USB and choose **Media device (MTP)**.
2. Open Windows Media Player and synchronize music files.

Disconnect Your Phone From the Computer

To disconnect the phone from the computer, simply unplug the

USB cable when you're finished.

Remove the microSD Card From Your Phone

If you need to remove the microSD card while the phone is on, you should unmount it first.

1. Touch the **Home Key > Menu Key > System settings > Storage**.
2. Scroll down and touch **Unmount SD card > OK**.
3. The  icon appears in the status bar and you can now safely remove the microSD card from the phone.

Erase microSD Card

1. Touch the **Home Key > Menu Key > System settings > Storage**.
2. Scroll down the screen and touch **Erase SD card > Erase SD card > Erase everything**.

CAUTION! The formatting procedure erases all the data on the microSD card, after which the files CANNOT be retrieved.

Connecting to Virtual Private Networks

Virtual private networks (VPNs) allow you to connect to the resources inside a secured local network. VPNs are commonly deployed by corporations, schools, and other institutions to let people access local network resources when not on campus, or when connected to a wireless network.

Depending on the type of VPN you are using, you may be

required to enter your login credentials or install security certificates before you can connect to your VPN. You can get this information from your network administrator.

Add a VPN

1. Touch the **Home Key > Menu Key > System settings > More > VPN**.
2. Touch **Add VPN profile** and fill in the information provided by your network administrator.
3. Touch **Save**.

The VPN is added to the list on the VPN screen.

Connect to a VPN

1. Touch the **Home Key > Menu Key > System settings > More > VPN**.
2. Touch the VPN that you want to connect to.
3. When prompted, enter any requested credentials, and then touch **Connect**.

When you are connected, the VPN connected icon appears in the Status bar.

Modify a VPN

1. Touch the **Home Key > Menu Key > System settings > More > VPN**.
2. Touch and hold the VPN that you want to modify.
3. Touch **Edit profile** and edit the VPN settings you want.
4. Touch **Save**.

Delete a VPN





1. Touch the **Home Key > Menu Key > System settings > More > VPN**.
2. Touch and hold the VPN that you want to delete.
3. Touch **Delete profile**.

Phone Calls

You can place calls from the Phone app, the People app, or other apps or widgets that display contact information. Wherever you see a phone number, you can usually touch it to dial.

Placing and Ending Calls

Place a Call by Dialing

1. Touch **Home Key** > .
2. In the phone tab , enter the phone number with the on-screen keypad. Touch  to delete incorrect digits.
NOTE: As you enter digits, your phone searches for contacts that match. If you see the number you want to dial, touch it to place the call immediately without entering the rest of the number.
3. Touch the Phone icon  below the keypad to dial.
TIP: To make an international call, touch and hold the 0 key to enter the plus (+) symbol. Next, enter the country code, followed by the city/area code and then the phone number.



End a Call

During a call, touch  on the screen.

Answering or Rejecting Calls



When you receive a phone call, the Incoming Call screen opens, displaying the Caller ID or the information about the caller that you've entered in People. You can answer or reject the call, or reject it with a text message.



Answer a Call

When you receive a phone call, drag  over  to answer the call.

NOTE: To silence the ringer before answering the call, press the **Volume Keys** up or down.

Reject a Call



When you receive a phone call, drag  over  to reject the call.

You can also drag  over  to reject the call and send a preset text message to the caller.

TIP: To edit the text response from within the Phone app, touch the **Home Key** >  > **Call log** > **Menu Key** > **Settings** > **Quick responses**.

Working With the Call Log

The Call Log is a list of all the calls you've placed, received, or missed. It provides a convenient way to redial a number, return a call, or add a number to your Contacts.

To open the call log, you can touch **Home Key** >  > **Call log** or touch the  tab in the Phone app.

Place a Call From the Call Log



1. Open the call log.
2. Touch a number for more information about the call, or touch  beside it to call back.

NOTE: You can touch  on the bottom of the screen and select the call log type you want to view.

Add a Call Log Number as a Contact

1. Open the call log.
2. Touch a number to view more call information.
3. Touch  at top right of the screen.
4. To add the number to an existing contact, touch **Add to existing**. To add a new contact, touch **New contact**.

Take Other Actions on a Call Log Entry

1. Open the call log.
2. Touch a number to view more call information. While viewing the call details, you can:
 - ▶ Touch  to call it.
 - ▶ Touch  > **Edit number before call** to edit the number in the dialer before calling it.
 - ▶ Touch  to send a message.

- ▶ If the number belongs to a contact you have, touch  to view contact details.



Delete the Call Log

1. Open the call log.
2. Touch **Menu Key > Multi-Select**.
3. Touch the call log items you want to delete and then touch  > **OK** to delete the call logs.



NOTE: You can also touch a number in the call log screen, and touch  at the bottom to delete the call log of the number.

Calling Your Contacts

Call a Contact

1. Touch **Home Key >**  and then touch the Contact tab .
2. Flick the screen up or down to view all your contacts with phone numbers.
TIP: You can search for a contact by touching  on the screen.
3. Touch a contact or number to call it.

Call a Favorite Contact

1. Touch **Home Key >**  and then touch the Contact tab .
2. Your favorite contacts and frequently called contacts or numbers are listed at the top of the screen. Touch a contact

or number to call it.

Checking Voicemail





If you have set the phone to divert certain calls to the voicemail, callers can leave voicemail messages when they cannot reach you. Here's how to check the messages they left.



1. Touch **Home Key** > .
2. Touch and hold "1" in the dialer. If prompted, enter your voicemail password.
3. Follow the voice prompts to listen to and manage your voicemail messages.

NOTE: To set your voicemail service, touch **Menu Key** > **Settings** in the dialer and touch the voicemail settings you want to change. For detailed information, please contact the service provider.

Using Options During a Call

During a call, you will see a number of onscreen options. Touch an option to select it.

- Touch  to turn on or off the speaker.
- Touch  to mute or unmute your microphone.
- Touch  to hold or unhold the current call.
- Touch  to make another call separately from the first call, which is put on hold.

- Touch  to switch to the dialer, for example to enter a code.
- Touch the **Menu Key** for more call options. You can record phone conversation, or view the contact list.
- Touch  to merge the separate calls into a single conference call.
- Touch  to end the current call.

WARNING! Because of higher volume levels, do not place the phone near your ear during speakerphone use.

Managing Multi-party Calls



When the call waiting and three-way call features are available, you can switch between two calls or set up a conference call.

NOTE: The call waiting and three-way call features need network support and may result in additional charges. Please contact your service provider for more information.

Switch Between Current Calls

When you're on a call, your phone screen informs you that another call is coming in and displays the caller ID.

To respond to an incoming call while you're on a call:



Drag  over  to answer the call. (This puts the first caller on hold and answers the second call.)

To switch between two calls:

Touch **Menu Key > Swap**.

Set Up a Conference Call

With this feature, you can talk to two people at the same time.

1. On the dialer screen, enter a number and touch .
2. Once you have established the connection, touch  and dial the second number. (This puts the first caller on hold and dials the second number.)
3. When you're connected to the second party, touch .

If one of the people you called hangs up during your call, you and the remaining caller stay connected. If you initiated the call and are the first to hang up, all callers are disconnected.

To end the conference call, touch .

Adjusting Your Call Settings

Edit Quick Response to Rejected Callers

1. Touch **Home Key** > .
2. Touch **Menu Key** > **Settings** > **Quick responses**.
3. Touch the text message to edit it.

Set Voicemail

1. Touch **Home Key** > .
2. Touch **Menu Key** > **Settings**.
3. Touch **Voicemail** to select voicemail service provider. Your carrier is the default.

Set TTY Mode

Select a TTY mode for your phone to work with a teletypewriter, or turn TTY off.

1. Touch **Home Key** > .
2. Touch **Menu Key** > **Settings** > **TTY mode**.
3. Touch **TTY Off** to turn the feature off, or touch **TTY Full**, **TTY HCO**, or **TTY VCO** to select a mode for your phone to work with the teletypewriter. Consult your teletypewriter manufacturer's manual if necessary.

Set DTMF Tones

You can set the length of Dual-tone multi-frequency (DTMF) signal tones.

1. Touch **Home Key** > .
2. Touch **Menu Key** > **Settings** > **DTMF tones**.
3. Touch **Normal** or **Long**.

Set Speed Dials

You can touch and hold the 2 ~ 9 key from the dialer to call the corresponding speed dial number.

The number key 1 is reserved to speed dial your voicemail.

To assign a speed dial key:

1. Touch **Home Key** > .
2. Touch **Menu Key** > **Settings** > **Speed dial**.

3. Touch a speed dial key.
4. Enter a phone number or select one from the contact list.
5. Touch **OK**.

Forward Incoming Calls

Call forwarding feature allows you to forward your incoming calls to another phone number.

1. Touch **Home Key** > .
2. Touch **Menu Key** > **Settings** > **Call forwarding**.
3. Touch an available option (**Always forward**, **Forward when busy**, **Forward when unanswered**, or **Forward when unreachable**) to enable it.

Internet Call Settings

To add an Internet calling account:

1. Touch **Home Key** > .
2. Touch **Menu Key** > **Settings** > **Accounts**.
3. Touch **Add account**.
4. Follow the instructions from your Internet calling service provider to configure the settings for your account.
5. Touch **Menu Key** > **Save**.

To configure which calls use Internet calling:

You can configure your phone to place all calls using Internet calling (when you're connected to a Wi-Fi network), just calls to Internet calling addresses, or to ask each time you place a call.

1. Touch **Home Key** > .
2. Touch **Menu Key > Settings > Use Internet calling**.
3. Touch the Internet calling option you want.



To configure your phone to receive Internet calls:

By default, your phone is configured to make Internet calls, but not to ensure that you will receive them. But you can configure your phone to listen for Internet calls made to an Internet calling account you added to your phone.



1. Touch **Home Key** > .
2. Touch **Menu Key > Settings > Accounts**.
3. Check **Receive incoming calls**. Checking this setting will reduce your battery life between charges.

People

You can add contacts on your phone and synchronize them with the contacts in your Google account or other accounts that support contact syncing.



To see your contacts, touch **Home Key** > . From there, you can touch the tabs on the top of the screen to quickly switch to the contact groups  or favorite contacts .

Checking Contact Details

1. Touch **Home Key** >  and touch the all contacts tab  to access your contact list.
2. Scroll through the list to view all your contacts.
3. Touch a contact to view its details.

TIP: If you have a lot of contacts stored, you'll see a slider when you touch the right side of the screen. To go directly to a letter, touch and hold the slider and drag it to a letter.

Adding a New Contact



1. Touch **Home Key** >  and touch the all contacts tab .
2. Touch  to add a new contact.
3. Touch the account field near the top of the screen to choose where to save the contact. If a sync account is selected, the contacts will be synced automatically with your account.

online.

4. Enter the contact name, phone numbers, email addresses, and other information.
5. Touch **DONE** to save the contact.

Setting Up Your Own Profile

You can create your own name card in your phone.

1. Touch **Home Key** >  and touch the all contacts tab .
2. Touch **Set up my profile** or your name, whichever is at the top of the contact list.
3. Edit your profile information and touch **DONE**.

Importing, Exporting, and Sharing Contacts

You can import/export contacts from/to your phone storage or microSD card. This is especially useful when you need to transfer contacts between different devices. You can also quickly share your contacts using Bluetooth, Email or Messaging, etc.

Import Contacts From the Phone Storage

1. Touch **Home Key** > .
2. Touch **Menu Key** > **Import/export** > **Import from phone storage**.

3. Select the vCard file(s) in the phone storage and touch **OK**.

Import Contacts From the microSD Card

1. Touch **Home Key** > .
2. Touch **Menu Key** > **Import/export** > **Import from SD card**.
3. Select the vCard file(s) in the microSD card and touch **OK**.



Export Contacts to the Phone Storage

1. Touch **Home Key** > .
2. Touch **Menu Key** > **Import/export** > **Export to phone storage**.
3. The phone will prompt you with the name of the vCard file.
Touch **OK** to create the file in the phone storage.

Export Contacts to the microSD Card

1. Touch **Home Key** > .
2. Touch **Menu Key** > **Import/export** > **Export to SD card**.
3. The phone will prompt you with the name of the vCard file.
Touch **OK** to create the file on the microSD card.

Share Contacts

1. Touch **Home Key** >  and touch the all contacts tab .
2. Touch **Menu Key** > **Multi-Select**.
3. Touch the contacts you want to share to select them and then

touch .



4. Choose to share the contacts via **Bluetooth, Email, Gmail** or **Messages**.

Working With Favorite Contacts



In the favorite contacts  tab, you can find your favorite contacts and frequently contacted contacts.

Add a Contact to Favorites

You can add the contacts used frequently to Favorites, so you can find them quickly.



1. Touch **Home Key** >  and touch the all contacts tab .
2. Touch a contact and then touch  next to the contact name.

Remove a Contact From Favorites

1. Touch **Home Key** >  and touch the favorite contacts tab .
2. Touch a favorite contact and then touch  next to the contact name.

Working With Groups







View Your Contact Groups

1. Touch **Home Key** >  and touch the all contacts tab .



2. Touch  at the lower left corner.
3. Scroll through the list to view the preset groups and any groups you have created.
4. Touch a group to view its members.

NOTE: To send messages to the group members, you can touch  next to the group and select message recipients from the listed group members.



Set Up a New Group

1. Touch **Home Key** >  and touch the all contacts tab .
2. Touch  at the lower left corner.
3. Touch  to create a new group.
4. Enter the group name and touch **DONE**.
5. Touch  and select the contacts you wish to be the group members.
6. Touch .



Delete a Group

1. Touch **Home Key** >  and touch the all contacts tab .
2. Touch  at the lower left corner.
3. Touch a group and then touch **Menu Key** > **Delete group**.
4. Touch **OK** to disband the group. The contacts in the group will not be deleted.

Edit a Group



1. Touch **Home Key** >  and touch the all contacts tab .
2. Touch  at the lower left corner.
3. Touch a group and then touch the **Menu Key**.
4. Touch **Rename group** to edit the group name. Or touch **Multi-Select** to select the members you don't need and remove them.

Searching for a Contact

1. Touch **Home Key** > .
2. Touch  at the bottom of the screen.
3. Input the contact name you want to search for. The contacts matched will be listed.



Editing Contacts

Edit Contact Details

1. Touch **Home Key** > .
2. Touch a contact to view the details.
3. Touch  at the lower left corner.
4. Edit the contact and touch **DONE**.

Set a Ringtone for a Contact

Assign a special ringtone to a contact, so you know who is calling when you hear the ringtone.

1. Touch **Home Key** > .
2. Touch a contact to view the details.
3. Touch  at the lower left corner to edit the contact details.
4. Touch the RINGTONE field.
5. Select a ringtone you like and touch **OK**.

Delete a Contact

1. Touch **Home Key** > .
2. Touch a contact you want to delete and touch **Menu Key** > **Delete**.
3. Touch **OK** to confirm.

To delete several contacts, you can:

1. Touch **Menu Key** > **Multi-Select** in the all contacts screen.
2. Touch to select the contacts you want to remove and then touch .
3. Touch **OK** to confirm.

Join Contacts

Your phone can synchronize with multiple accounts containing your contact information (such as Google and Microsoft

Exchange ActiveSync). When you synchronize your phone with those accounts, there might be duplicate entries for the same contact.

You can merge all the separate information of a contact into one entry in the Contacts list.

1. Touch **Home Key** > .
2. Touch a contact entry to display the contact's details. This is the contact you will see in the Contacts list after merging.
3. Touch **Menu Key** > **Join contact**. The phone will list the suggested contacts to join.
4. Touch the contact whose information you want to join with the first entry.

The information from the second contact is added to the first contact, and the second contact is no longer displayed in the Contacts list.

You can repeat these steps to join another contact to the main contact.

Separate Contact Information

If contact information from different sources was joined in error, you can separate the information back into individual contacts on your phone.

1. Touch **Home Key** > .
2. Touch a contact entry you have merged and want to separate.

3. Touch **Menu Key > Separate contact**.

4. Touch **OK** to confirm.

The contact information is separated into individual contacts in the list of contacts.

Adding or Removing Accounts

You can add multiple Google Accounts and Microsoft Exchange ActiveSync accounts. You may also add other kinds of accounts, depending on the apps installed on your phone.

Add an Account

1. From the Home Screen, touch **Menu Key > System settings** and move to the ACCOUNTS section.
2. Touch **Add account**.
3. Touch the type of account you want to add.
4. Follow the onscreen steps to enter the information about the account. Most accounts require a username and password, but the details may vary. You may also need to obtain some information from IT support or your system administrator.

When the account is successfully added, it is displayed in the **ACCOUNTS** list.

Remove an Account

Removing an account will delete it and all information associated with it from your phone, such as emails and contacts.

1. From the Home Screen, touch **Menu Key > System**

- settings** move to the ACCOUNTS section.
2. Touch the account.
 3. Touch the **Menu Key > Remove account > Remove account**.

Configuring Account Sync

Configure Auto Sync Setting

1. Open the **ACCOUNTS** settings screen.
Your accounts and sync status are displayed. The  icon turns green if automatic sync is enabled for some or all of the account's data, and gray if automatic sync is disabled.
2. Touch the **ON/OFF** switch to turn on or off automatic sync.
 - ▶ When automatic sync is turned on, changes you make to information on your phone or on the web are automatically synced with each other.
 - ▶ When auto sync is turned off, you need to sync manually to collect emails, updates, or other recent information.

Sync Manually

1. Open the **ACCOUNTS** settings screen.
2. Touch the account whose data you want to sync.
3. Touch **Menu Key > Sync now**.

Change an Account's Sync Settings

1. Open the **ACCOUNTS** settings screen.
2. Touch the account whose sync settings you want to change. The Sync settings screen appears, showing a list of information the account can sync.
3. Check or uncheck items as you need. Checked types of information on the phone and the web will be kept in sync when auto-sync is turned on.

Email

Touch  in the Home Screen and select **Email**. Use it to read and send emails from services other than Gmail.

Set Up the First Email Account

1. When you open **Email** for the first time, enter your email address and password.
2. Touch **Next** to let the phone retrieve the network parameters automatically.
NOTE: You can also enter these details manually by touching **Manual setup** or when automatic setup fails.
3. Follow the on-screen instructions to finish the setup.

Your phone will show the inbox of the email account and start to download email messages.

Checking Your Emails

Your phone can automatically check for new emails at the interval you set when setting up the account.



You can also check new emails manually by touching  in any of the email account's boxes. Touch **Load more messages** at the bottom of the email list to download earlier messages.

Responding to an Email

You can reply to or forward a message that you receive. You can also delete messages and manage them in other ways.

Reply to or Forward an Email

1. Open the email you want to reply to or forward from Inbox.
2. Do the following as you need:

To...	do...
Reply to the sender,	touch  in the message header.
Reply to the sender and all recipients of the original message,	touch in the message header  > Reply all .
Forward the message,	touch in the message header  > Forward .

3. Edit your message and touch .

Mark an Email as Unread



You can return a read email to the unread state—for example, to remind yourself to read it again later. You can also mark a batch of emails as unread.

- While reading a message, touch **Menu Key > Mark as unread**.
- While in a message list (for instance, the inbox), touch the

checkboxes before the messages and then touch .

Delete an Email



You can delete an email from its folder. You can also delete a batch of emails.

- While reading a message, touch  > **OK**.
- While in a message list (for instance, the inbox), touch the checkboxes in front of the messages and then touch  > **OK**.

Writing and Sending an Email

1. Open your email Inbox and touch .

NOTE: If you have more than one email account added on the phone, touch the sender line to select the account you want to use for sending the message.

2. Enter a contact name or email address in the 'To' field. Separate each recipient with a comma. You can also touch  to select recipients from your contacts.
3. Enter the email subject and compose the email text.
4. Touch **Menu Key > Attach file** to add audio files, images, videos and other types of files as attachments.
5. Touch  at the top right of the screen to send the message.

Adding Signature to Your Emails

You can set a few lines of plain text as signature for every outgoing email message from an account, such as your name and contact information.

1. Open the **Email** app.
2. Touch **Menu Key > Settings** and select the account you want to add signature to.
3. Touch **Signature** and enter the text.
4. Touch **OK**.

Adding and Editing Email Accounts

Add an Email Account

After setting up your first email account (see [Email – Set Up the First Email Account](#)), you can add more email accounts and manage them separately.

1. Open **Email** to get the Inbox screen.
2. Touch **Menu Key > Settings** and touch **ADD ACCOUNT** at the top right of the screen.
3. Set up the account as you would with the first one.

Edit an Email Account

You can change a number of settings for an account, including how often you check for email, how you're notified of new mails,

and details about the servers the account uses to send and receive mails.

1. Open **Email** to get the Inbox screen.
2. Touch **Menu Key > Settings** and touch the account whose settings you want to change.
3. Make the changes you want and touch the **Back Key** when you're finished.

Remove an Email Account

1. Open **Email** to get the Inbox screen.
2. Touch **Menu Key > Settings** and touch the account you want to remove.
3. Touch **Remove account > OK**.

Changing General Email Settings

General settings apply to all email accounts you add.

1. Open **Email** to get the Inbox screen.
2. Touch **Menu Key > Settings > General**.
3. Make the changes you want and touch the **Back Key** when you're finished.

After you sign in to your Google account on the phone, you can send and retrieve Gmail messages with the **Gmail** app.

NOTE: This feature may not be available in certain regions or with certain service providers.

Opening Your Gmail Inbox

Touch  in the Home Screen and select **Gmail**. The Inbox screen appears.

If you haven't signed in, you will be prompted to do so or create a new account.



Touch  at the bottom right of the screen to refresh your Inbox and download new messages.

Switching Accounts

Gmail displays conversations, messages, and settings from one Google account at a time. If you have signed in to more than one Google account on your phone, you can switch accounts and view information in each account.

1. From your Inbox, touch the current account at the top of the screen.
2. From the drop-down menu, touch the account you want to see. The account's Inbox will open.

Writing and Sending a Message

1. Open your Gmail Inbox and switch to the account you want to use for sending the message.
2. Touch .
3. Enter a contact name or email address in the 'To' field. Separate each recipient with a comma.
4. Enter the email subject and compose the email text.
5. To attach an image, touch **Menu Key > Attach picture** and select a file from the image gallery.
6. Touch  at the top right of the screen to send the message.



Adding Signature to Your Gmail Messages

You can set a few lines of plain text as signature for every outgoing Gmail message. The signature you set on the phone is independent of the signature you use for Gmail on the web.

1. Open the **Gmail** app.
2. Touch **Menu Key > Settings** and select the account you want to add signature to.
3. Touch **Signature** and enter the text.
4. Touch **OK**.

Replying to or Forwarding a Message

1. Open the Gmail message you want to reply to or forward to another person.
2. Do the following as you need:

To...	do...
Reply to the sender,	touch  in the message header.
Reply to the sender and all recipients of the original message,	touch in the message header  > Reply all .
Forward the message,	touch in the message header  > Forward .

3. Edit your message and touch the send icon .

Working With Received Attachments

When a message has an attachment, Gmail displays information about that attachment at the top of the message.

Depending on the attachment type, the applications installed on your phone as well as your settings, you may preview, view, play, save the attachment, or check information about the attachment.

TIP: For documents with multiple pages, touching the **Preview** option will only download the pages you view, while touching **View**, **Play**, or **Save** will download the entire file and cost more

time and data.

Searching for Messages

You can search for messages using words that appear in addresses, subjects, labels, or contents.

NOTE: If you search while the phone doesn't have an active Internet connection, only messages synchronized onto your phone can be searched.

1. Open the **Gmail** app and touch .
2. Enter the words to search for and touch the search key on the screen keyboard.

As you type, suggestions may appear below the search field.

You can touch a suggestion to search for it right away, or touch the arrow next to it to add its text to the search field.

3. In the search results, touch the message you need and work with it just as you would with any Gmail message.

Working With Labels

Message labels include both labels you create and default labels such as **Sent**, **Starred**, and **Outbox**. You can organize your emails by labeling them or adding stars to them. Labels also help you sort your messages, just like folders.

To label or change labels:

1. Open the **Gmail** app and touch in the message list the

checkboxes before the messages you want to label.

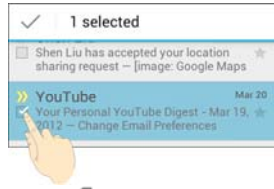

2. Touch the label icon  at the bottom of the screen.
3. Check or uncheck labels in the new screen and touch **OK**.

To add stars to messages:

1. Open the **Gmail** app and touch in the message list the checkboxes before the messages you want to star.
2. At the bottom of the screen, touch  > **Add star**.

To view messages by label:

1. Open the **Gmail** app and touch the label icon  at the bottom of the message list without checking any message.
2. Touch the label to view messages with that label.

TIP: You can also touch the name of your account at the top of the screen. Then touch one of the labels listed in the **RECENT** section, below account names.

Changing Gmail Settings

Touch the **Menu Key > Settings** in any Gmail screen to change

General settings, which apply to all Gmail accounts, or other settings that only apply to specific accounts.

Messaging

You can use Messaging to exchange text messages (SMS) and multimedia messages (MMS).



Opening the Messaging Screen

Touch  in the Home Screen and select **Messaging**.



The **Messaging** screen opens, where you can create a new message, open an ongoing message thread.

- Touch  to write a new text or multimedia message.
- Touch an existing message thread to open the conversation you've had with a certain number.

Sending a Text Message

1. On the **Messages** screen, touch  at the bottom.
2. Add recipients by one of the following ways.
 - ▶ Touch the **To** field and manually enter the recipient's number the contact name. If the phone presents a few suggestions, touch the one you want to add.
 - ▶ Select recipients from your contacts by touching .
3. Touch the **Type message** field and enter the content of your text message.
4. Touch **Send**.

Sending a Multimedia Message

1. On the **Messages** screen, touch  at the bottom.
2. Enter the recipient and the text of the message, as you do when sending a text message. You can also include email addresses as recipients.
3. Touch the **Menu Key > Add subject** to add a message subject.
4. Touch the paper clip icon  to attach a file to the message.
5. Touch **Send**.

NOTE: When you enter an email address as a recipient, add a subject, or attach a file, the message is automatically converted to a multimedia message. When you delete these information, the message is converted to a text message.

Replying to a Message

Messages you receive are appended to existing threads of the same number. If the new message comes from a new number, a new thread is created.

1. On the **Messages** screen, touch the thread that has the message you want to reply to.
2. Type your reply in the text box at the bottom. You can touch the attach icon  if you want to reply with an MMS.
3. Touch **Send**.

Forwarding a Message

1. On the **Messages** screen, touch the thread that has the message you want to forward.
2. Touch and hold the message.
3. Touch **Forward** in the menu that opens.
4. Enter a recipient for the message and edit the content if you want.
5. Touch **Send**.

Viewing Details About a Message

1. Touch and hold a message in a thread.
2. Touch **View message details** to see information about the message, such as message type, sender, recipient, or date.

Deleting Messages or Threads

To delete messages in a thread:

1. On the **Messages** screen, touch a thread.
2. Touch **Menu Key > Multi-Select**.
3. Touch the messages you want to delete. The ones you touch will have a check in the box in front of them.
4. Touch  at the bottom.
5. Touch **OK**.

To delete message threads:

1. On the **Messages** screen, touch and hold one thread you want to delete.
2. If there are more threads you want to delete, touch them one by one.
3. Touch  at the bottom.
4. Touch **OK**.

Changing Message Settings

Touch **Menu Key > Settings** in the Messages screen to change Messages settings.

Calendar

Calendar on the phone works with the web-based Google Calendar service for creating and managing events, meetings, and appointments. It also works with the Microsoft Exchange ActiveSync calendar once you sign into your Exchange account on the phone.

To open Calendar, touch  in the Home Screen and select **Calendar**.

Viewing Your Calendars and Events

Select Visible Calendars

1. Open the **Calendar** app.
2. Touch **Menu Key > Calendars to display**.
3. In the new screen, touch the calendars to check the calendars you want to see or uncheck the calendars you'd like to hide.

Events from hidden calendars are not shown in the Calendar app.

Change Calendar Views

You can view your calendars in different forms. The app offers four views: Month, Week, Day, and Agenda.

To change calendar views, touch the time period shown at the

top left and select the view you prefer.



TIPS:

- In Month view, swipe vertically to see earlier months and later months.
- In Week or Day view, swipe horizontally to see earlier weeks/days and later weeks/days.
- When you are viewing earlier or later days, weeks, or months, touch  at the top to quickly switch to today.

View Event Details

In Agenda, Day, or Week view, touch an event to view its details.

In Month view, touch a day to switch to Day view. Then touch an

event to view its details.

Creating an Event

1. In any Calendar view, touch **Menu Key > New event** to open an event details screen for a new event.
You can also touch a spot in Day or Week view twice to add an event to that time spot.
2. Add details about the event.
Enter a name, location, time span, and other additional details about the event.
NOTE: If you have more than one calendar, you can choose the calendar to which to add the event by touching the current calendar above the **Event name** box.
3. Touch **DONE** at the top of the screen to save the new event.

Editing or Deleting an Event

1. Find the event you want to edit or delete.
2. Open its details screen (see [Viewing Your Calendars and Events – View Event Details](#) in this chapter).
3. Do one of the following as you need.

To...	do...
Edit the event,	touch  at the bottom of the screen. Touch DONE to save your changes.

Delete the event,	touch  at the top of the screen and then touch OK .
-------------------	---

Changing Calendar Settings

To change Calendar settings, open a Calendar view (Day, Week, Month, or Agenda). Then touch **Menu Key > Settings**. You can change **General settings**, which apply to all accounts, or other settings that only apply to specific accounts.

Google+



Google+ is a social networking service offered by Google. The Google+ application on your phone enables you to manage your data, chat with online contacts, organize them in different circles, and share your selected information.

Touch  in the Home Screen and select **Google+**. The first time you open the Google+ app, select the instant upload and contact sync options.

Organizing Your Contacts

1. Open the **Google+** app.
2. Touch  > **Circles**.
3. Enter the person you want to search for or select a suggested person, and touch **Add**.
4. Check the circles you want the person to be added to, or touch **Create a new circle**.



Getting Updates

1. Open the **Google+** app.
2. Touch  > **Home**.
3. Swipe up or down to see different information shared with you by other users. Touch  to choose what groups of information are shown.

- ▶ **Nearby** shows posts shared with you by users near your current location.
- ▶ **All circles, Acquaintances, Family, Following, and Friends** show updates from people you've added to your circles.
- ▶ **What's hot** shows popular posts on Google+.

Chatting With Contacts

You can chat with your Google+ contacts through instant messaging, similar to sending a text with the Messages app.

1. Touch  > **Messenger** in the **Google+** app or touch from the Home Screen  > **Messenger**.
2. Touch  to create a new message.
3. If you touched  at the top, touch  to add recipients. They can be contacts or circles.
4. Enter the message.
5. Touch  to send the message.



TIP: Touch  > **Hangouts** to hold a video chat with your friends.

Checking Photos

You can see your own photo albums and those shared by other users.

Touch  > **My photos** in the **Google+** app to see all available albums.

Checking and Managing Your Profile

1. Touch  > **Profile** in the **Google+** app.
2. Swipe up or down to see your posts and personal info.
Touch  and you can change your profile photo.

Browser

Use **Browser** to view web pages and search for information.

Opening the Browser

Touch  in the Home Screen and select **Browser** to start this function. The last web page you were viewing is displayed. If you have not used **Browser** recently, your home page opens.

Browser also opens when you touch a web link - for example, in an email or a text message.

Open a Web Page or Search the Web

1. Open the **Browser** app.
2. Touch the address box at the top of the web page. If the address box isn't visible, swipe down a little to show it.
3. Enter the address (URL) of a web page. Or, enter terms you want to search for. You can also touch  to search by voice.
4. Touch a URL or search suggestion or touch **Go** on the keyboard to open the web page or search results.

TIP: Touch the **X** at the bottom of the screen if you want to stop opening the page.

Set the Homepage

Your home page opens when you open a new browser tab, and

when you start **Browser** after restarting your phone or after not using the app for a while.

1. Open the page you want to set as your home page.
2. Touch **Menu Key > Settings > General > Set homepage**.
3. Touch **Current page** or one of the following options.
 - ▶ **Current page:** Set the current URL as the homepage.
 - ▶ **Blank page:** Open browser tab without opening a web page by default. This can make new Browser tabs open more quickly.
 - ▶ **Default page:** Set the factory default URL as the homepage.
 - ▶ **Most visited sites:** Every new browser tab displays a list of your frequently visited sites for you to choose from.
 - ▶ **Site Navigation:** Provide a series of sites for you to view.
 - ▶ **Other:** Type a URL as the homepage.

Get Information About the Current Page



Touch **Menu Key > Page info**.

Working With an Opened Page

While viewing most web pages, you can do the following operation.

- **Scroll:** Swipe the screen in any direction.
- **Zoom out:** Touch the screen with two fingers and pinch them

together.

- Zoom in: Touch the screen with two fingers and spread them apart.
- Go back: Touch  at the bottom to return to the page you've viewed previously in the same window.
- Go forward: Touch  at the bottom.
- Refresh the page: Touch  beside the address bar.
- Find text on the page: Touch **Menu Key > Find on page** and type the terms you want to search for.
- Send the page URL to friends: Touch **Menu Key > Share page** and select how you want to send the URL.
- Follow a link: Touch a link on the web page to open it.
- Save the page for offline reading: Touch **Menu Key > Save for offline reading**. You can touch **Menu Key > Bookmarks > SAVED PAGES** to read them.

TIPS:

- Some web sites may redirect you to the mobile version of their web pages, which mostly do not support scrolling or zooming. If you want to view the desktop version, touch the **Menu Key** and check **Request desktop site**.
- Besides links, **Browser** also recognizes some phone numbers, addresses, and similar information for you to act on. Try touching them and see what happens.

Using Multiple Browser Tabs

You can open several web pages at the same time (one page in each tab) and switch between them freely.

To open a new browser tab:

1. Touch  at the bottom of the screen. A new browser window opens and the homepage is loaded.

To switch between tabs:

1. Touch  at the bottom of the screen.
2. Swipe vertically to scroll through the list of opened tabs.
3. Touch the thumbnail of the tab you want to open.

TIP: Swipe a thumbnail horizontally or touch its **X** to close the tab.

Downloading Files

Touch and hold an image or a link to a file or to another webpage. In the menu that opens, touch **Save image** or **Save link**.

The downloaded files are saved to your phone or the memory card. You can view or open them in the **Downloads** app ( > **Downloads**).

Using Bookmarks

Save web URLs as bookmarks to open them easily in the

future.

To open a bookmark, touch **Menu Key > Bookmarks** in a browser tab and then touch the bookmark.

Bookmark a Web Page

1. Open the web page.
2. Touch **Menu Key > Add to bookmarks**.
3. Edit the bookmark label and address if necessary, or choose a different account.
Touch the name beside **Add to** to change the place where the bookmark will be stored.
4. Touch **OK**.

Edit a Bookmark

1. Touch **Menu Key > Bookmarks**.
2. Touch and hold the bookmark to edit.
3. Touch **Edit bookmark**.
4. Edit the label, address, account, or location of the bookmark in the dialog that opens.
5. Touch **OK**.

NOTE: Preinstalled bookmarks may not be edited.

Delete a Bookmark

1. Touch **Menu Key > Bookmarks**.

2. Touch and hold the bookmark to delete.
3. Touch **Delete bookmark**.
4. Touch **OK**.

NOTE: Preinstalled bookmarks may not be deleted.

Viewing Your Browsing History

1. Open the Browser app and touch **Menu Key > Bookmarks**.
2. Touch the **HISTORY** tab.
3. Touch a time span to view the web pages you browsed during then. You can touch an item to reopen the web page.

Changing Browser Settings

You can configure a number of Browser settings to customize the way you browse the web, including several that you can use to control your privacy.



To open the Browser settings screen, touch **Menu Key > Settings**.

Activating Location Services

To use **Navigation, Local, Latitude**, and find your location on Google Maps, you must have location services turned on on your phone.



1. Touch **Home Key > Menu Key > System settings > Location services**.
2. Select the location options you want to use.
Check **Google's location service** to use Wi-Fi and mobile networks to determine your approximate location; check **GPS satellites** to use GPS satellites to determine your location.

Getting Your Location

1. Touch  in the Home Screen and select **Maps**.
2. Touch  at the top right.



The map centers on a blue blinking dot that indicates your location.

Searching for a Location

1. Touch  in the Home Screen and select **Maps**.
2. Touch .
3. Enter the place you're looking for in the search box at the top. You can enter an address, a city, or a type of business or establishment, for example, "museums in Shanghai." As you enter information, suggestions from your previous searches and from popular searches appear in a list below the search box. You can touch a suggestion to search for it.
TIP: You can also touch  beside the search box to use voice search.
4. Touch the search icon on the keyboard. Markers with letter labels indicating search results appear on the map.
5. Touch a marker to open a balloon that contains a label with summary information about the location.
6. Touch the balloon to open a screen with more information, as well as options for obtaining directions and more.

Getting Directions to Your Destination

Maps can provide directions for travel by foot, public transportation, or car.

1. Touch  in the Home Screen and select **Maps**.
2. Touch  at the bottom.
3. Enter a start and end point and select the mode of

transportation (car, public transit, or walking). If you have enabled My Location, this will appear in the start point field by default.

4. Touch **GET DIRECTIONS**. The directions to your destination are marked on the map. Touch the left or right arrow to see the direction step by step. You can also touch **DIRECTIONS LIST** to see your route displayed in a list.

NOTE: Touch  > **Navigation** from the Home Screen to use Google Maps Navigation (beta) and get turn-by-turn voice directions.

Searching for Local Places

Google Places helps you find all kinds of businesses and establishments around you. You can rate these places and get recommendations

1. Touch  in the Home Screen and select **Local**. Or from the **Maps** app, touch the Maps icon at the top of the screen and select **Local**.
2. Wait while you are being located. Your location, when found, is shown at the top.
3. Select a place category and the information for that type of place near you will be displayed.

You can also use the  button at the top to find the place you need.

NOTE: Touch **Menu Key** > **Add a search** to add new place categories.

4. Tap a result you are interested in and check out the details and reviews about that place. You can also see the place on **Maps**, find out how to get there, give that place a call, add your rating and review, and more.



Sharing Location

Google Latitude lets you and your friends view each others' locations on maps and share status messages with each other.

To join **Latitude** on your phone, open the **Maps** app, touch the Maps icon at the top of the screen and select **Latitude > Share location with family or friends > Agree & Continue**.

After you join in, you can always touch the Maps icon at the top in **Maps** and select **Latitude** or touch  > **Latitude** from the Home Screen to see your status as well as that of your selected friends.

In **Latitude**, you can do the following operations.

- Touch  to refresh friends' status.
- Touch **MAP VIEW** to see friends on **Maps**. You can touch the left/right arrow to switch between each friends and yourself.
- Touch  to add new friends to Latitude from contacts, via email addresses, or from suggested friends.
- Touch the **Menu Key** to show or hide stale friends, who haven't updated their location with you for a while.
- Touch **Menu Key > Location Settings** to change Latitude settings or sign out of Latitude service.

Google Search and Voice Search

You can search for information on the web or on your phone using Google Search. You can also search the web or perform certain tasks by speaking.

Searching With Text

1. Touch the Google Search box at the top of the Home Screen to start the **Search** app.
2. Enter the terms you want to search for and touch , or touch a search suggestion.

Searching by Speaking

1. Touch the microphone icon to the right of the search box.
2. Speak the terms you want to search for. When you're finished speaking, your speech is analyzed and the search is initiated.

If Google Search didn't quite understand what you said, you are presented with a list of similar-sounding terms. Touch the correct term to start the search.

Changing Search and Voice Search Settings

Open the **Search** app and touch **Menu Key > Settings** to set Searchable items.

To set Voice Search settings, touch in the Home Screen the **Menu Key > System settings > Language & input > Voice Search**.

Camera

You can take photos and record videos. Photos and videos are stored to the phone's memory card or to the phone's internal storage. You can copy them to your computer or access them in the **Gallery** app.

Capturing a Photo

1. Touch  in the Home Screen and select **Camera**.
2. Aim the camera at the subject and make any necessary adjustment.

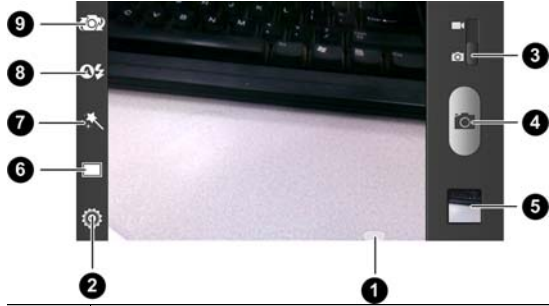





Number	Function
1	Hold the slider and slide to zoom in or out.

Number	Function
2	Change the camera settings.
3	Switch to the camcorder.
4	Capture a photo.
5	View photos and videos you have captured.
6	Switch between normal and timing mode.
7	Select the color effect.
8	Turn on/off flash.
9	Switch between the front and the back cameras.

3. Lightly touch the capture button  or press the **Camera Key**.

Customize Camera Settings

Before taking a photo, you can touch ,  and  to use timing mode, change color effect, and turn on flash. Meanwhile, you can touch  to open the following camera setting options.

Grid	Turn on/off grid.
Shutter Tones	Select your preferred shutter tone.
Picture Size	Adjust picture size.
Image	Adjust exposure, contrast, saturation, and sharpness.



White balance	Select how the camera adjusts colors in different kinds of light to achieve the most natural looking colors for your shots, or allow the camera to adjust the white balance automatically.
ISO	Adjust the ISO.
Review Time	Adjust the review time.
Geo-tag	Set whether your location information is stored or not with each photo you take.
Restore Defaults	Restore camera to default settings.

Recording a Video

1. Touch  in the Home Screen and select **Camera**.
2. Switch to the camcorder mode.
3. Aim the camera at the subject and make any necessary adjustment.





Number	Function
1	Hold the slider and slide to zoom in or out.
2	Change the camcorder settings.
3	Switch to the camera.
4	Start or stop recording a video.
5	View photos and videos you have captured.
6	Turn on/off flash.
7	Switch between the front and the back cameras.

4. Touch  to start and  to stop recording.

TIP: While the recording is in progress, you can touch the  button to save the frame as a photo.

Customizing Camcorder Settings

Before recording a video, you can touch  to turn on flash or touch  to open the following camcorder setting options.

Video quality	Adjust video quality
Time Lapse	Adjust the time lapse.
White balance	Select how the camera adjusts colors in different kinds of light to achieve the most natural looking colors for your videos, or allow the camera to adjust the white balance automatically.
Geo-tag	Set whether your location information is stored or not with each video you record.
Restore Defaults	Restore default settings.

Opening Gallery

Touch  in the Home Screen and select **Gallery** to view albums of your pictures and videos.

Working With Albums

When you open Gallery, all pictures and videos on your phone are displayed in a number of albums.

To view album contents:

Touch an album to view the pictures and videos it contains.

To share albums:



1. Touch and hold an album until it is selected.
2. Touch more albums that you want to share.
3. Touch  at the top of the screen and select how you want to share the albums.

To view details of an album:

1. Touch and hold an album until it is selected.
2. Touch  > **Details**.

To delete albums:

1. Touch and hold an album until it is selected.
2. Touch more albums that you want to delete.

3. Touch  > **Delete**. If only one album is selected, touch  > **Delete** > **OK**.

To download Picasa web albums:

1. Touch **Menu Key** > **Make available offline**.
2. Touch the Picasa web albums you want.
3. Touch **Done**.

Working With Pictures

Touch a picture in an album to view the picture in full screen. Double-touch the picture, or pinch two fingers together or spread them apart to zoom out or in. Slide left or right to view other pictures in the album.



Number	Function
1	Touch to return to the album, where all its contents are displayed in a grid.
2	Share the picture.
3	Delete the picture.



Touch the **Menu Key** to browse the album contents in a slideshow, rotate the picture, view picture file detail, set it as contact icon or wallpaper, or edit it.

NOTE: Not all the options may be available for certain albums or pictures.

Retouch Your Pictures

You can edit any photos you took and some other pictures in **Gallery**. The changed picture is saved in the **Edited** album, while the original image is never affected.

1. Touch the **Menu Key > Edit** while viewing a picture in full screen to open the Edit interface.
2. Touch the icons along the bottom of the screen to edit the picture.



	Add fill light, emphasize highlight or shadows, or set to auto-fix.
	Apply effects such as posterizing, lomography, documentary, and film grain.



Apply color effects such as warmth, saturation, B&W, sepia, negative, as well as other effects including doodling on the picture.



Crop, fix red eye, straighten, rotate, flip, or sharpen the picture.

3. To undo or redo the changes you've made to the picture, touch  or  at the top of the screen.
4. Touch **SAVE** to save the new picture to the **Edited** album.

Share Your Pictures

1. Touch an album in the gallery and then touch a picture.
2. Touch  at the top of the screen. If the icon is invisible, touch the screen first.
3. Select how you want to share the picture.

Working With Videos

Play Videos

1. Touch an album in the gallery and then touch the thumbnail of a video.
 2. Touch  at the center to start playing.
- Touch the video to view the playback controls.

Share Videos

1. Touch an album in the gallery and then touch the thumbnail of a video.
2. Touch  at the top of the screen. If the icon is invisible, touch the screen first.
3. Select how you want to share the video.

Music

Touch  in the Home Screen and select **Music** to play audio files stored on your phone. **Music** supports a wide variety of audio formats, so it can play music you purchase from online stores, music you copy from your CD collection, and so on.

Copying Music Files to Your Phone

Before using Music, you need to copy audio files from your computer to your phone's memory card.

Copy From a Computer

1. Connect your phone and the computer with a USB cable.
2. Touch **Media device (MTP)** (if supported on the PC) or **Camera (PTP)** to browse the files on the phone storage and the microSD card.
3. Copy the music file from the PC and paste it to the phone storage or microSD card.

Download From the Internet

You can download music files when browsing web pages. See [Downloading Files](#).

Receive via Bluetooth

You can receive music files from other devices via Bluetooth.

See [Receive Data via Bluetooth](#).

Viewing Your Music Library

Touch  in the Home Screen and select **Music** and your music library is displayed. All your audio files are cataloged, according to the information stored in the files.

Touch the tabs at the top of the screen to view your music library organized by **Albums**, **Artists**, **Songs**, **Playlists**, **Folders**, or **GenreList**.

NOTE: If an audio file is being played, its summary information is displayed at the bottom of the screen. Touch the summary area to open the playback screen.

Set a Song as the Default Ringtone

The song will be used as the ringtone for all incoming calls, except those from contacts you have assigned special ringtones to (see [People – Editing Contacts – Set a Ringtone for a Contact](#)).

1. Touch  in the Home Screen and select **Music** to see the music library.

NOTE: If you are in the playback screen, touch **Menu Key > Library** to return to the music library.

2. Touch  next to a song in any list.
3. In the menu that opens, touch **Use as phone ringtone**.

TIP: If the song is being played, you can touch **Menu Key >**

Use as ringtone in the playback screen.

Delete a Song

1. Touch  in the Home Screen and select **Music** to see the music library.

NOTE: If you are in the playback screen, touch **Menu Key > Library** to return to the music library.

2. Touch  next to a song in any list.
3. In the menu that opens, touch **Delete > OK**.

Playing Music

Touch a song in the music library to listen to it. The following playback screen appears.



Number	Function
1	Song and artist information.
2	Touch to toggle repeat mode: no repeat, repeat the current song, or repeat the current playlist.
3	Playback control. Skip songs or pause and resume playback. Drag the slider to jump to any part of the song.
4	Touch to open the current playlist.
5	Touch to play the current playlist in shuffle mode, where tracks are played in random order.
6	Album artwork.
7	Touch to add a song to the favourite list.

Managing Playlists

Create playlists to organize your music files into sets of songs, so that you can play the songs you like in the order you prefer.

Create a Playlist

1. Touch  next to the song in the music library.
2. In the menu that opens, touch **Add to playlist**.
3. Touch **New**.
4. Type the playlist name and touch **Save**.

The playlist is created and the song you selected is added to the playlist.

Add a Song to a Playlist

1. Touch  next to the song in the music library.
2. In the menu that opens, touch **Add to playlist**.
3. Touch the name of the playlist you want the song added to.

TIP: You can rearrange the songs in the playlists you created. Open the playlist and touch and hold  in front of a song. Drag up or down to change its order in the playlist.

Remove a Song From a Playlist

1. Open a playlist.
2. Touch  next to the song you want to remove.
3. Choose **Remove from playlist**.

Delete or Rename a Playlist

1. Touch the **Playlists** tab in the music library to see all the playlists.
2. Touch  next to a playlist and touch **Rename Playlist** or **Delete Playlist** in the menu that opens.

NOTE: These options may not be available for certain automatically created playlists, such as **Recently added**.

Play Music

The **Play Music** application () works with Google Music, Google's online music store and streaming service. You can stream via mobile data or Wi-Fi and listen to your favorite songs that you've added to your online Google Music library. You can also play audio files you've copied directly to your phone from a computer.

NOTE: The availability of Google Music is dependent on your region. If it is not available, or you don't have a mobile data or Wi-Fi connection, you can only play music stored on your phone.

Playing Your Music

Touch  in the Home Screen and select **Play Music**. If you are prompted, select an account to access its online music library.

The app searches your online library and your phone for music and playlists before displaying your combined music library, organized by **RECENT**, **ARTISTS**, **ALBUMS**, **SONGS**, **PLAYLISTS**, and **GENRES**. To change views of your library, swipe left or right when holding the phone upright, or touch the view name at the top left of the screen when holding the phone on its side.

Touch a song to play it. When the song is playing, touch the album artwork to display more options.

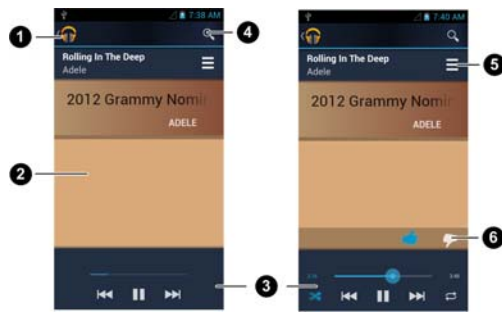

Number	Function
1	Touch to view the current playing list.
2	Album artwork.
3	Playback control. Skip songs, pause and resume playback, use shuffle or repeat. Drag the progress bar to jump to any part of the song.
4	Search for music.
5	Back to Now playing list.
6	Rate the song.

You can still control the music when you are not in the playback screen.

- In the **Play Music** app, touch the Now Playing bar at the

bottom (portrait mode) of the screen to restore the playback screen.

- In other apps, flick down the notification panel. Touch the song title to restore the playback screen, or just pause/resume playback or skip to the next/previous song.
- When the screen is locked, the song information, album cover as well as playback control is displayed on top of the screen. You can pause/resume playback or skip songs.

Managing Playlists

Create playlists to organize your music files into sets of songs, so that you can play the songs you like in the order you prefer.

To create a playlist or add a song to a playlist:

Touch and hold the song or touch  next to the song, and select **Add to playlist**.

To rearrange songs in a playlist:

1. Open a playlist in the **Playlists** tab of the music library.
2. Touch and hold the small grid in front of a song.
3. Drag the grid up or down to change its order in the playlist.

To remove songs from a playlist:

1. Open the playlist in the **Playlists** tab of the music library.
2. Touch and hold the song or touch  next to the song you want to remove.
3. Select **Remove from playlist**.

To rename or delete a playlist:

1. Swipe to the **Playlists** tab in the music library to see all the playlists.
2. Touch and hold a playlist or touch  next to the playlist.
3. Touch **Rename** or **Delete** in the menu that opens.

Video Player

Use the video player to play various kinds of videos.

Opening the Video Library

Touch  in the Home Screen and select **Video Player** to view your video library.

Touch the tabs at the top of the screen to view the available videos.

- **ALL:** videos on your phone.
- **LAST ADDED:** recently added videos on your phone.
- **CAMERA VIDEOS:** videos you have recorded with the phone's camera.

Playing and Controlling Videos

Touch a video in the video library to play it. Rotate the phone on its side to watch the video in landscape view.

Touch the video to show the playback controls. You can pause and resume the playback, or jump to any part of the video. You can also exit the video by touching the **Back Key**.

Managing Video Files

To delete videos:

1. Touch and hold a video in the video library. The video is highlighted.
2. To remove more videos, touch them.
3. Touch  at the bottom left of the screen.
4. Touch **OK**.

To share videos:

1. Touch and hold a video in the video library. The video is highlighted.
2. To share more videos, touch them.
3. Touch  at the bottom right of the screen and select how you want to share them.

To rename a video:

1. Touch  next to the video you want to rename.
2. Touch **Rename**.
3. Type the new video name and touch **OK**.





To view details of a video:

1. Touch  next to the video you want to view the details of.
2. Touch **Details**.

Sound Recorder

Sound Recorder enables you to record voice memos and listen to them whenever you like.

Recording a Voice Memo

1. Touch  in the Home Screen and select **Sound Recorder**.
2. Touch  to start recording. Touch  to cancel recording if you change your mind.
3. Touch  to stop recording. The memo is automatically saved.

If you don't want to save the memo after recording it, touch  to delete it.

Playing a Voice Memo

To play a memo you just recorded:

Touch  at the bottom of the screen.

To play any saved memo:

1. Touch  at the top right of the screen to see all recordings.
2. Touch the title of a memo to play it.

NOTE: You can also touch  at the right of the memo to share, rename, delete it, check its file information, or set it as your phone ringtone.

Alarm

Set alarms or turn the phone into a bedside clock.

Setting a New Alarm

1. Touch  in the Home Screen and select **Alarm**.
2. Touch a default alarm to configure it, or touch **Add alarm** at the bottom of the screen to create a new alarm.
3. Set up the alarm options, such as time, repeat, and ringtone.
4. Touch **SAVE** to save and exit.

Using Bed Clock

Bed clock displays the current time and the next alarm.

1. Touch  in the Home Screen and select **Alarm**.
2. If necessary, touch **Menu Key > Bed Clock Preferences** in the **Alarm** screen to set up bed clock options. Then touch the **Back Key** to return to the **Alarm** screen.

Enable bed clock	Turn on or off the bed clock function.
Bed clock never sleeps	Keep the bed clock screen turned on when charging the phone.

3. Touch **Menu Key > Bed Clock** to open the bed clock screen.



Backup and Restore

Touch  in the Home Screen and select **Settings > Backup & restore**. You can back up your user data, such as contacts and messages, and installed applications to the memory card regularly. If the data get lost, restore it from the memory card.

Touch  > **Help** to view detailed guide.

Calculator

Touch  in the Home Screen and select **Calculator**.

TIP: Touch  or , or swipe left or right to switch between different panels. You can also hold the phone on its side to see all of the calculator buttons.

Downloads

The **Downloads** app keeps a record of the files you have downloaded using the **Browser**, **Email**, or **Gmail** app.

Touch  in the Home Screen and select **Downloads** to check the record.

- Touch a file to open it with the appropriate applications.
- Touch and hold a file, or check the box in front of it, to delete or share it.

File Manager

Quickly access all of your images, videos, audio clips, and other types of files on your phone and on the memory card.

Touch  in the Home Screen and select **File Manager**. Touch the folder name at the top of the screen to switch between the memory card storage and the phone storage.

Full Share

Full Share offers a wireless solution to sharing media files among devices connected to the same Wi-Fi network. You can use this feature to easily access media content on different devices without having to transfer files.

Sharing Media Files on Your Phone

1. Connect your phone to a Wi-Fi network.
2. Touch  in the Home Screen and select **Full Share**.
3. Touch **Menu > Settings** and check or uncheck **Share music**, **Share videos**, or **Share images**. Only checked types of files will be shared.
4. Check **Allow media sharing**.



Now your phone works as a media server and you can access the shared files from other devices that support Full Share and are connected to the same Wi-Fi network as your phone.

Accessing Shared Files on Other Devices

After another device has shared its media contents while connected to a Wi-Fi network, you can access them with your phone.

1. Connect your phone to the same Wi-Fi network as the other device.
2. Touch  in the Home Screen and select **Full Share**.
3. Touch the **Server List** tab. The other device should appear in the Server List.
4. Touch the device and select a category to access its contents.
5. Touch a file (and select a media render if prompted) to start playing it with the dedicated player for shared media contents.

You can also touch the checkboxes after the files to select multiple items and then touch the following button.

- ▶ Touch  (and select a media render if prompted) to play the selected files on the media render one by one.
- ▶ Touch  to add the files to the playlist. You can access them in the Playlist tab.
- ▶ Touch  to copy the files to a media server within the network.

NotePad

Touch  in the Home Screen and select **NotePad** to save and

view your text notes.

Touch **New+** to create a new note. Then enter your text and touch  to save it.

Touch a note to view its entire content. You can also delete it, share it, or change its title.

Play Books

Touch  in the Home Screen and select **Play Books** to read ebooks purchased from Play Store.

Touch a book cover displayed in Play Books to start reading it. You can also touch the shop bag icon at the top to buy more books from Play Store, or touch  to search by book title or author name.

Play Movies & TV

Touch  in the Home Screen and select **Play Movies & TV** to watch movies you rent from Play Store as well as your personal videos stored on the phone.

- **MY RENTALS** tab displays your recent movie rentals. You can stream them for online watching or download them to watch offline.
- The **PERSONAL VIDEOS** tab displays videos from other sources. Touch one video to play it.

Task Manager

Touch  in the Home Screen and select **Task Manager** to view or stop applications.

- Touch a task in the **Tasks** tab to switch to its screen, abort it, or see its detail.
- Touch the **Apps** tab to manage all the apps on your phone.
- Touch the **Resources** tab to view the real-time system resources information.

Timer

Touch  in the Home Screen and select **Timer** to use the stopwatch or the timer.

Stopwatch allows you to record lap times, while Countdown allows you to set a time and count down to zero.

World Time

Touch  in the Home Screen and select **World time** to check local time for cities around the world.

Touch **+** at the bottom to add a new city or country.

YouTube

Touch  in the Home Screen and select **YouTube**.

You can watch YouTube videos or upload your own.

Play Store

Touch  in the Home Screen and select **Play Store**. You can buy or rent music, books, movies, and apps and download them to your phone.

NOTE: The content you can access in Play Store depends on your region and your service provider.

Browsing and Searching for Apps

You can browse apps by category and sort them in different ways. Touch a top-level category, such as **Games** and touch the app from any subcategory.

You can also search for apps using an app's name or description, or the developer's name. Just touch  and enter the search terms.

Downloading and Installing Apps

When you find the app you are interested in through browsing or searching, touch it to open its details screen, where more information about the app is displayed.

1. Touch **Download** (free apps) or the price (paid apps) in the app details screen.
2. If the app is not free, you need to sign in to your Google Wallet account and select a payment method.
3. Touch **Accept & download** (free apps) or **Accept & buy**

(paid apps) to accept the permissions for the app. Your app will start downloading immediately or once payment is successfully authorized.

Managing Your Downloads

After you've downloaded and installed an app, you can rate it, view it in a list with your other downloaded apps, configure it to update itself automatically, and so on.

View Your Downloaded Apps

1. On the Apps screen of Play Store, touch **Menu Key > My Apps**.
2. Your list of installed apps opens. You can touch one to rate it, uninstall it, request a refund and so on.

Uninstall an App

1. On the Apps screen of Play Store, touch **Menu Key > My Apps**.
2. Touch an app to open its details screen.
3. Touch **Uninstall > OK**.

Settings

Touch  in the Home Screen and select **Settings**. The **Settings** app contains most of the tools for customizing and configuring your device.

General Settings

Airplane mode

In the **Settings** app, drag the **Airplane mode** switch to turn it on. All the phone's radios that transmit voice or data are turned off.

Wi-Fi

Turn Wi-Fi on or off and configure your Wi-Fi connections. See [Connecting to Networks and Devices – Connecting to Wi-Fi](#).

Bluetooth

Turn Bluetooth on or off and configure your Bluetooth connections. See [Connecting to Networks and Devices – Connecting to Bluetooth Devices](#).

Mobile Networks

Control mobile data use and select mobile network. See [Connecting to Networks and Devices – Connecting to Mobile Networks](#).

Sound

Adjust volumes (see [Personalizing – Adjusting Volumes](#)), toggle sound and mute (see [Switching to Silent Mode](#)), set up ringtone (see [Personalizing – Changing Ringtone](#)), set up notification sound ([Personalizing – Changing Notification Sound](#)), and select system sounds (refer to [Turning On/Off Touch Sounds](#)).

Touch **Silent mode** to turn off all sounds except media and alarm, or enable silent mode with vibration.

Display

- **Brightness:** Set the brightness of the display.
- **Wallpaper:** Select a background image for the Home Screen.
- **Sleep:** Set the length of time of inactivity before the screen turns off.
- **Font size:** Set the font size of the text on the screen.
- **Pulse notification light:** Flash the LED light to notify you of missed calls, new messages, and other events.

Date & Time

Set date, time, time zone, and how date and time are displayed. You can also use network-provided data.

Language & Input

- **Language:** Select a language and region for your system.
- **Personal dictionary:** Add new words to the phone's dictionary or remove words from the dictionary. The words you add are used for spelling check and word suggestion.
- **KEYBOARD & INPUT METHODS:** Configure text input settings. See [Knowing the Basics – Entering Text – Touch Input Settings](#).
- **Voice Search:**
 - ▶ **Language:** Select the language you use when entering text by speaking or searching by speaking.
 - ▶ **Speech output:** Select Always speak or Hands-free only.
 - ▶ **Block offensive words:** Replace offensive words with an asterisk (*) when you use Google voice recognition to transcribe your voice into text.
 - ▶ **Hotword detection:** Detect the hot word to launch the corresponding task.
- **Text-to-speech output:**
 - ▶ **PREFERRED ENGINE:** Select the speech synthesis engine you want to use or change its settings.
 - ▶ **Speech rate:** Select how quickly you want the synthesizer to speak.
 - ▶ **Listen to an example:** Play a brief sample of the speech synthesizer, using your current settings.

- **Pointer speed:** Select how fast the pointer/mouse should scroll when you connect the phone to a trackpad or mouse accessory.

Wireless and Networks

Data Usage

Touch the **ON/OFF** switch to turn on or off mobile data.

You can check how much data has been used during the time cycle you set, set a mobile data limit and warning, see what apps have been using mobile data, or restrict background data for individual apps.

VPN

Set up and connect to virtual private networks. See [Connecting to Networks and Devices – Connecting to Virtual Private Networks](#).

Device

Storage

Check memory information for your memory card and internal storage.

- **Unmount SD card:** Unmount the memory card from your phone so that you can safely remove the card while the

phone is on.

- **Erase SD card:** Erase all data on your memory card and prepare it for use with your phone.

Touch **Menu Key > USB computer connection** to set the connection type for your phone.

Battery

Check how much power remains for the battery and what has been using the battery.

Apps

See apps installed on your phone and manage them.

Touch an app in the **DOWNLOADED, ON SD CARD, RUNNING**, or **ALL** tab to see its information. You can stop the app, uninstall the app, clear data and cache, or move the app between the internal storage and the memory card.

NOTE: Not all applications can be moved or uninstalled.

Connect to PC

Choose one of the following options:

- ▶ **Charge only:** Charge your phone via USB.
- ▶ **Install driver:** Install the driver needed for connecting your phone to your PC.
- ▶ **Media device (MTP):** Transfer media files on Windows, or using Android File Transfer on Mac.

- ▶ **Camera (PTP):** Transfer photos using camera software, and transfer any files on computers that don't support MTP.

To disconnect the device from the computer, simply unplug the USB cable when you're finished.

Accounts

Manage your accounts and synchronization settings.

- Touch **Add account** to sign in to or create accounts on your phone.
- Touch an account to set the sync settings for that account. You can then touch **Menu Key > Sync now** to sync all checked items.
- Touch an account and then touch **Menu Key > Remove account** to remove the account and all information related to it from your phone.

Personal

Location services

Activate location services to determine your location. See [Maps, Navigation, Places and Latitude – Activating Location Services](#).

Select **Location & Google search** to improve Google search results and other services using your location information.

Security

- **Screen lock:** Lock the screen with slide, pattern, PIN, or password. See [Personalizing – Protecting Your Phone With Screen Locks](#).
- **Make pattern visible:** Show the pattern as you draw it.
- **Automatically lock:** Set the time needed for the lock protection to be activated after the screen turns off.
- **Vibrate on touch:** Vibrate as you draw the pattern or enter the PIN/password to unlock the phone.
- **Owner info:** Set the text that you may display on the lock screen.
- **Encrypt phone:** Encrypt your data on the phone to protect your privacy. See [Personalizing – Protecting Your Phone With Encryption](#).
- **Make passwords visible:** Display passwords as you enter them.
- **Device administrators:** View or deactivate apps you have authorized to be device administrators.
- **Unknown sources:** Check this option to permit installation of apps from sources other than the Play Store.
- **Trusted credentials:** Display trusted CA certificates.
- **Install from SD card:** Install certificates from the memory card.
- **Clear credentials:** Delete all certificates.

Backup & reset

- **Back up my data:** Back up app data, Wi-Fi passwords, and other settings to Google servers after you sign in to your Google account.
- **Backup account:** Set the backup account for backup your data.
- **Automatic restore:** Restore previously backed up settings and data when you reinstall an app.
- **Factory data reset:** Reset your phone to factory default settings. All your personal data from the phone's internal storage will be erased. You can also erase the data on the memory card during the process.

System

Accessibility

Configure accessibility plug-ins on your phone, such as using **TalkBack** for low-vision users.

Developer options

Developer options contains settings that are useful when developing Android applications.

About phone

View phone status and legal information. You can also upgrade

your phone system from update packages copied to the storage card.

Upgrading the Phone Software

There are several ways to upgrade your phone software:

1. Use the online upgrade tool for mobile terminal products.
2. Use the one-press upgrade package offered by your mobile service provider.
3. Use the upgrade package on your microSD card.

NOTE: Visit ZTE official handset service support website (<http://www.zte.com.cn/endata/mobile/>) and click your country or region to learn more about the above upgrade methods, as well as which phones and methods are supported.

Troubleshooting

If you encounter problems while using the phone, or if it performs abnormally, you can refer to the chart below. If your particular problem cannot be resolved using the information in the chart, contact the dealer where you purchased the phone.

Problem	Possible causes	Possible solution
Poor reception	The network signal is too weak at your current location, for example, in a basement or near a tall building, because wireless transmissions can not effectively reach it.	Move to a location where the network signal can be properly received.
	The network is busy at the current time (for example, during peak times, there may be too much network traffic to handle additional calls).	Avoid using the phone at such times, or try again after waiting a short time.
	You are too far away from a base station for your service provider.	You can request a service area map from your service provider.













Problem	Possible causes	Possible solution
Echo or noise	Poor network link quality on the part of your service provider.	End the call and dial again. You may be switched to a better-quality network link or phone line.
	Poor local telephone line quality.	End the call and dial again. You may be switched to a better-quality network link or phone line.
Unable to select certain features	Your service provider does not support these features, or you have not applied for services that provide these features.	Contact your service provider.
Battery not charging	The battery or battery charger is damaged.	Contact the dealer.
	The phone's temperature is below 0°C or higher than 45 °C.	Adjust the battery charging environment to avoid extremes of temperature.
	Poor contact between the battery and charger.	Check all connectors to make sure all connections have been properly made.







Problem	Possible causes	Possible solution
Shortened standby time	The standby time is related to your service provider system configuration. The same phone used with different service providers' systems will not provide exactly the same length of standby time.	If you are located in an area where signaling is weak, temporarily power off the phone.
	The battery is depleted. In high temperature environments, battery life will be shortened.	Use a new battery.
	If you are not able to connect to the network, the phone will continue to send out signals as it attempts to locate a base station. Doing so consumes battery power and will consequently shorten standby time.	Change your location to one where the network is accessible, or temporarily turn off your phone.

Problem	Possible causes	Possible solution
Cannot turn your phone on	Battery power has been depleted.	Recharge the phone's battery.
Unable to connect to the network	You are not within the network's service area.	Check the service area with your service provider.
	Poor signal.	Move to an open space, or if you are inside a building, move closer to a window.
You cannot make outgoing calls.	You have activated the Fixed dial numbers feature.	Go to Call settings to check the Fixed Dialing Numbers and disable it.
PIN Code blocked	You have entered an incorrect PIN code three consecutive times.	Contact your service provider.
Unable to enter information into the phonebook	The phonebook's memory is already full.	Delete unnecessary data from the contacts.

Problem	Possible causes	Possible solution
Phone crashes, reboots, freeze, or cannot be powered on	Some third-party software is not compatible with your phone.	Reset the phone to factory status.
		Enter safety mode and uninstall the software that may cause the problem.
		Upgrade the phone software.

General Safety

	Don't make or receive handheld calls while driving. Never text while driving.		Don't use at gas stations.
	Keep your phone at least 15 mm away from your ear or body while making calls.		Your phone may produce a bright or flashing light.
	Small parts may cause choking.		Don't dispose of your phone in fire.
	Your phone can produce a loud sound.		To prevent possible hearing damage, do not listen at high volume levels for long periods.
	Avoid contact with anything magnetic.		Avoid extreme temperatures.
	Keep away from pacemakers and other electronic medical devices.		Avoid contact with liquids. Keep your phone dry.

	Turn off when asked to in hospitals and medical facilities.		Don't take your phone apart.
	Turn off when told to in aircrafts and airports.		Only use approved accessories.
	Turn off when near explosive materials or liquids.		Don't rely on your phone for emergency communications.

Radio Frequency (RF) Exposure for CE

General Statement on RF Energy

Your phone contains a transmitter and a receiver. When it is ON, it receives and transmits RF energy. When you communicate with your phone, the system handling your call controls the power level at which your phone transmits.

Specific Absorption Rate (SAR)

Your mobile device is a radio transmitter and receiver. It is designed not to exceed the limits for exposure to radio waves recommended by international guidelines. These guidelines were developed by the independent scientific organization ICNIRP and include safety margins designed to assure the protection of all persons, regardless of age and health.

The guidelines use a unit of measurement known as Specific Absorption Rate, or SAR. The SAR limit for mobile devices is 2 W/kg and the highest SAR value for this device when tested at the ear was 0.857 W/kg*. As mobile devices offer a range of functions, they can be used in other positions, such as on the body as described in this user guide**.

As SAR is measured utilizing the device's highest transmitting power, the actual SAR of this device while operating is typically below that indicated above. This is due to automatic changes to the power level of the device to ensure it only uses the minimum power required to communicate with the network.

* The tests are carried out in accordance with EN 50360, EN 62311, EN 62209-1, EN 62209-2.

** Please see body worn operation.

Body Worn Operation

Important safety information regarding radio frequency radiation (RF) exposure:

To ensure compliance with RF exposure guidelines the phone must be used with a minimum of 15 mm separation from the body.

Failure to observe these instructions could result in your RF exposure exceeding the relevant guideline limits.

Limiting Exposure to Radio Frequency (RF) Fields

For individuals concerned about limiting their exposure to RF fields, the World Health Organization (WHO) provides the following advice:

Precautionary measures: Present scientific information does not indicate the need for any special precautions for the use of mobile phones. If individuals are concerned, they might choose to limit their own or their children's RF exposure by limiting the length of calls, or using 'hands-free' devices to keep mobile phones away from the head and body.

Further information on this subject can be obtained from the WHO home page <http://www.who.int/peh-emf> (WHO Fact sheet 193: June 2000).

Regulatory Information

The following approvals and notices apply in specific regions as noted.

Please find the section Declaration of RoHS Compliance and CE DOC in the end of this manual.

FCC Regulations:

This mobile phone complies with part 15 of the FCC Rules. Operation is subject to the following two conditions: (1) This device may not cause harmful interference, and (2) this device must accept any interference received, including

interference that may cause undesired operation.

This mobile phone has been tested and found to comply with the limits for a Class B digital device, pursuant to Part 15 of the FCC Rules. These limits are designed to provide reasonable protection against harmful interference in a residential installation. This equipment generates, uses and can radiate radio frequency energy and, if not installed and used in accordance with the instructions, may cause harmful interference to radio communications. However, there is no guarantee that interference will not occur in a particular installation. If this equipment does cause harmful interference to radio or television reception, which can be determined by turning the equipment off and on, the user is encouraged to try to correct the interference by one or more of the following measures:

- Reorient or relocate the receiving antenna.
 - Increase the separation between the equipment and receiver.
 - Connect the equipment into an outlet on a circuit different from that to which the receiver is connected.
 - Consult the dealer or an experienced radio/TV technician for help.
- Caution: Changes or modifications not expressly approved by the party responsible for compliance could void the user's authority to operate the equipment.

RF Exposure Information (SAR)

This phone is designed and manufactured not to exceed the emission limits for exposure to radio frequency (RF) energy set by the Federal Communications Commission of the United States, Industry Canada of Canada.

During SAR testing, this device was set to transmit at its highest certified power level in all tested frequency bands, and placed in positions that simulate RF exposure in usage against the head with no separation, and near the body with the separation of 15 mm. Although the SAR is determined at the highest certified power level, the actual SAR level of the device while operating can be well below the maximum value. This is because the phone is designed to operate at multiple power levels so as to use only the power required to reach the network. In general, the closer you are to a wireless base station antenna, the lower the power output.

The exposure standard for wireless devices employing a unit of measurement is known as the Specific Absorption Rate, or SAR. The SAR limit set by the FCC is 1.6W/kg, and 1.6W/kg by Industry Canada.

This device is complied with SAR for general population /uncontrolled exposure limits in ANSI/IEEE C95.1-1992 and Canada RSS 102, and had been tested in accordance with the measurement methods and procedures specified in OET Bulletin 65 Supplement C, and Canada RSS 102. This

device has been tested, and meets the FCC, IC RF exposure guidelines when tested with the device directly contacted to the body.

The FCC has granted an Equipment Authorization for this model phone with all reported SAR levels evaluated as in compliance with the FCC RF exposure guidelines. SAR information on this model phone is on file with the FCC and can be found under the Display Grant section of www.fcc.gov/oet/ea/fccid after searching on FCC ID: Q78-Z796C.

For this device, the highest reported SAR value for usage against the head is 0.95 W/kg, for usage near the body is 1.18 W/kg.

While there may be differences between the SAR levels of various phones and at various positions, they all meet the government requirements.

SAR compliance for body-worn operation is based on a separation distance of 15 mm between the unit and the human body. Carry this device at least 15 mm away from your body to ensure RF exposure level compliant or lower to the reported level. To support body-worn operation, choose the belt clips or holsters, which do not contain

metallic components, to maintain a separation of 15mm between this device and your body.

RF exposure compliance with any body-worn accessory, which contains metal, was not tested and certified, and use such body-worn accessory should be avoided.

Z796C does not have embedded software to support VOIP by default, and RF exposure compliance has not been assessed for possible VOIP operation. Installing 3rd party application to enable VOIP operation should be avoided

National Restrictions on Wi-Fi Usage

2400.0-2483.5 MHz

Country	Restrictions	Reason/remark
Bulgaria		General authorization required for outdoor use and public service
France	Please don't use WIFI function outdoors	Military Radiolocation use. Refarming of the 2.4 GHz band has been ongoing in recent years to allow current relaxed regulation. Full implementation planned 2012.

Italy		If used outside of own premises, general authorization is required.
Luxembourg	None	General authorization required for network and service supply (not for spectrum).
Norway	Implemented	This subsection does not apply for the geographical area within a radius of 20 km from the centre of Ny-Ålesund.
Russian Federation		Only for indoor applications.

Distraction

Driving

Full attention must be given to driving at all times in order to reduce the risk of an accident. Using a phone while driving (even with a hands free kit) can cause distraction and lead to an accident. You must comply with local laws and regulations restricting the use of wireless devices while driving.

Operating Machinery

Full attention must be given to operating machinery in order to reduce the risk of an accident.

Product Handling

General Statement on Handling and Use

You alone are responsible for how you use your phone and any consequences of its use.

You must always turn off your phone wherever the use of a phone is prohibited. Use of your phone is subject to safety measures designed to protect users and their environment.

- Always treat your phone and its accessories with care and keep it in a clean and dust-free place.
- Keep the screen and camera lens clean. Unclean screen or camera lens may slow down the phone's reaction to your operations or lower image quality.
- Clean the device and its accessories with a soft material such as cleaning cloth for eyeglass lenses. Do not use alcohol or other corrosive substances for cleaning or allow them to get inside.
- Do not expose your phone or its accessories to open flames or lit tobacco products.
- Do not expose your phone or its accessories to liquid,

moisture or high humidity.

- Do not drop, throw or try to bend your phone or its accessories.
- Do not paint your phone or its accessories.
- Do not attempt to disassemble your phone or its accessories. Only authorized personnel can do so.
- Do not expose or use your phone or its accessories in a environment with or that can reach extreme temperatures, minimum - [5] and maximum + [50] degrees Celsius.
- Do not place your phone inside or near heating equipments or high pressure containers, such as water heaters, microwave ovens, or hot cooking utensils. Otherwise, your phone may be damaged.
- Please check local regulations for disposal of electronic products.
- Do not carry your phone in your back pocket as it could break when you sit down.

Small Children

Do not leave your phone and its accessories within the reach of small children or allow them to play with it.

They could hurt themselves or others, or could accidentally damage the phone.

Your phone contains small parts with sharp edges that may cause an injury or may become detached and create a choking

hazard.

Demagnetization

To avoid the risk of demagnetization, do not allow electronic devices or magnetic media to be close to your phone for a long time.

Electrostatic Discharge (ESD)

Do not touch the metal connectors of the phone.

Antenna

Do not touch the antenna unnecessarily.

Normal Use Position

When placing or receiving a phone call, hold your phone to your ear, with the bottom towards your mouth.

Air Bags

Do not place a phone in the area over an air bag or in the air bag deployment area as an airbag inflates with great force and serious injury could result.

Store the phone safely before driving your vehicle.

Seizures/Blackouts

The phone can produce a bright or flashing light. A small

percentage of people may be susceptible to blackouts or seizures (even if they have never had one before) when exposed to flashing lights or light patterns such as when playing games or watching video. If you have experienced seizures or blackouts or have a family history of such occurrences, please consult a physician.

Repetitive Strain Injuries

To minimize the risk of Repetitive Strain Injury (RSI) when texting or playing games with your phone:

- Do not grip the phone too tightly.
- Press the buttons lightly.
- Use the special features which are designed to minimize the times of pressing buttons, such as Message Templates and Predictive Text.
- Take many breaks to stretch and relax.

Emergency Calls

This phone, like any wireless phone, operates using radio signals, which cannot guarantee connection in all conditions. Therefore, you must never rely solely on any wireless phone for emergency communications.

Loud Noise

This phone is capable of producing loud noises, which may damage your hearing. Turn down the volume before using

headphones, Bluetooth stereo headsets or other audio devices.

Phone Heating

Your phone may become warm during charging and during normal use.

Electrical Safety

Accessories

Use only approved accessories.

Do not connect with incompatible products or accessories.

Take care not to touch or allow metal objects, such as coins or key rings, to contact or short-circuit in the battery terminals.

Never puncture the surface of the battery with sharp objects.

Connection to a Car

Seek professional advice when connecting a phone interface to the vehicle electrical system.

Faulty and Damaged Products

Do not attempt to disassemble the phone or its accessories.

Only qualified personnel can service or repair the phone or its accessories.

If your phone (or its accessories) has been submerged in water,

punctured, or subjected to a severe fall, do not use it until you have taken it to be checked at an authorized service center.

Radio Frequency Interference

General Statement on Interference

Care must be taken when using the phone in close proximity to personal medical devices, such as pacemakers and hearing aids.

Pacemakers

Pacemaker manufacturers recommend that a minimum separation of 15 cm be maintained between a mobile phone and a pacemaker to avoid potential interference with the pacemaker. To achieve this, use the phone on the opposite ear to your pacemaker and do not carry it in a breast pocket.

Hearing Aids

People with hearing aids or other cochlear implants may experience interfering noises when using wireless devices or when one is nearby.

The level of interference will depend on the type of hearing device and the distance from the interference source. Increasing the separation between them may reduce the interference. You may also consult your hearing aid manufacturer to discuss alternatives.

Medical Devices

Please consult your doctor and the device manufacturer to determine if operation of your phone may interfere with the operation of your medical device.

Hospitals

Turn off your wireless device when requested to do so in hospitals, clinics or health care facilities. These requests are designed to prevent possible interference with sensitive medical equipment.

Aircraft

Turn off your wireless device whenever you are instructed to do so by airport or airline staff.

Consult the airline staff about the use of wireless devices onboard the aircraft. If your device offers a 'flight mode', this must be enabled prior to boarding an aircraft.

Interference in Cars

Please note that because of possible interference with electronic equipment, some vehicle manufacturers forbid the use of mobile phones in their vehicles unless a hands-free kit with an external antenna is included in the installation.

Explosive Environments

Gas Stations and Explosive Atmospheres

In locations with potentially explosive atmospheres, obey all posted signs to turn off wireless devices such as your phone or other radio equipment.

Areas with potentially explosive atmospheres include fueling areas, below decks on boats, fuel or chemical transfer or storage facilities, and areas where the air contains chemicals or particles, such as grain, dust, or metal powders.

Blasting Caps and Areas

Power off your mobile phone or wireless device when in a blasting area or in areas posted power off "two-way radios" or "electronic devices" to avoid interfering with blasting operations.