

ZTE BLADE L7

User Manual

LEGAL INFORMATION

Thank you for choosing this ZTE mobile device. In order to keep your device in its best condition, please read this manual and keep it for future reference.

Copyright

Copyright © 2017 ZTE CORPORATION

All rights reserved.

No part of this publication may be quoted, reproduced, translated or used in any form or by any means, electronic or mechanical, including photocopying and microfilm, without the prior written permission of ZTE Corporation.

Notice

ZTE Corporation reserves the right to make modifications on print errors or update specifications in this guide without prior notice. This manual has been designed with the utmost care to ensure the accuracy of its content. However, all statements, information and recommendations contained therein do not constitute a warranty of any kind, either expressed or implied. We offer self-service for our smartphone users. Please visit the ZTE official website (at www.ztedevice.com) for more information on self-service and supported product models. Information on the website takes precedence.

Disclaimer

ZTE Corporation expressly disclaims any liability for faults

and damages caused by unauthorized modifications of the software.

Images and screenshots used in this manual may differ from the actual product. Content in this manual may differ from the actual product or software.

Trademarks

ZTE and the ZTE logos are trademarks of ZTE Corporation.

Google and Android are trademarks of Google, Inc.

The *Bluetooth*[®] trademark and logos are owned by the Bluetooth SIG, Inc. and any use of such trademarks by ZTE Corporation is under license.



microSDXC Logo is a trademark of SD-3C, LLC.

Other trademarks and trade names are the property of their respective owners

Version No.: R1.0

Edition Time: March 07, 2017

Contents

For Your Safety	8
General Safety	8
FCC RF Exposure Information (SAR)	9
FCC Regulations	11
Distraction	12
Product Handling	13
Electrical Safety	16
Interference	17
Explosive Environments	19
Getting Started	20
Overview	20
Keys Explained	22
Starting up	23
Powering On/Off	30
Getting Around Your Phone	31
Phone Calls	34
Making Calls	34
Receiving Calls	36
Call settings	37
Contacts	38
Creating a Contact	38
Searching for a Contact	39
Messaging	39













The Message Box	39
Sending a Message	39
Message Settings	40
Connecting to Networks and Devices.....	41
Set Access Point Names.....	41
Turn Wi-Fi On and Connect to a Wi-Fi Network.....	41
Bluetooth.....	42
Tethering & portable hotspot	43
Browser	44
Opening the Browser	44
Using Multiple Browser Tabs.....	45
Downloading Files.....	45
Changing Browser Settings.....	45
Using Multimedia Apps	46
Taking Pictures With Your Camera	46
Recording Videos With Your Camcorder	46
Listening to Your FM Radio.....	47
Playing Your Music	47
Opening Your Gallery.....	48
Making Voice Memos.....	48
Using Your Google Applications.....	49
Gmail	49
Google Play™ Store	49
Other Applications.....	50







Clock	50
File Explorer	50
Settings.....	50
Wi-Fi.....	51
Bluetooth.....	51
Wi-Fi hotspot	51
Airplane Mode	51
Data Usage	52
VPN.....	52
Bluetooth Tethering	52
Hotspot Settings	53
Hard keys	53
Themes & Wallpapers	53
Display	53
Prompt & notification	53
Audio Profiles	54
Apps.....	54
Storage & USB	54
Battery.....	54
Memory	55
Location.....	55
Security	55
Accounts	56
Google.....	56
Language & input	56
Backup and Reset	56

Timer Switch Machine.....	57
Date & Time.....	57
Accessibility	57
Printing	57
About Phone	58

For Your Safety

General Safety

	Don't make or receive handheld calls while driving. And never text while driving.		Don't use at petrol stations.
	Keep your phone at least 10 mm away from your body while making calls.		Your phone may produce a bright or flashing light.
	Small parts may cause a choking.		Don't dispose of your phone in fire.
	Your phone can produce a loud sound.		Avoid contacting with anything magnetic.
	Keep away from pacemakers and other electronic medical devices.		To prevent possible hearing damage, do not listen at high volume levels for long periods.
	Avoid extreme temperatures.		Switch off when asked to in hospitals and medical facilities.

	Avoid contacting with liquids. Keep your phone dry.		Switch off when told to in aircrafts and airports.
	Don't take your phone apart.		Switch off when near explosive materials or liquids.
	Only use approved accessories.		Don't rely on your phone for emergency communications.

FCC RF Exposure Information (SAR)

This phone is designed and manufactured not to exceed the emission limits for exposure to radio frequency (RF) energy set by the Federal Communications Commission of the United States.

During SAR testing, this device was set to transmit at its highest certified power level in all tested frequency bands, and placed in positions that simulate RF exposure in usage against the head with no separation, and near the body with the separation of 10 mm. Although the SAR is determined at the highest certified power level, the actual SAR level of the device while operating can be well below the maximum value. This is because the phone is designed to operate at multiple power levels so as to use only the power required to reach the network. In general, the closer you are to a wireless base station antenna, the lower the power output.

The exposure standard for wireless devices employs a unit of measurement known as the Specific Absorption Rate, or SAR. The SAR limit set by the FCC is 1.6 W/kg.

This device is complied with SAR for general population /uncontrolled exposure limits in ANSI/IEEE C95.1-1992 and had been tested in accordance with the measurement methods and procedures specified in IEEE1528.

The FCC has granted an Equipment Authorization for this model phone with all reported SAR levels evaluated as in compliance with the FCC RF exposure guidelines. SAR information on this model phone is on file with the FCC and can be found under the Display Grant section of www.fcc.gov/oet/ea/fccid after searching on FCC ID: SRQ-ZTEBLADEL7.

For this device, the highest reported SAR value for usage against the head is 0.768W/kg, for usage near the body is 1.253 W/kg.

While there may be differences between the SAR levels of various phones and at various positions, they all meet the government requirement.

SAR compliance for body-worn operation is based on a separation distance of 10 mm between the unit and the human body. Carry this device at least 10 mm away from your body to ensure RF exposure level compliant or lower to the reported level. To support body-worn operation, choose the belt clips or holsters that do not contain metallic

components to maintain a separation of 10 mm between this device and your body.

RF exposure compliance with any body-worn accessory that contains metal was not tested nor certified, and using such body-worn accessory should be avoided.

FCC Regulations

This mobile phone complies with part 15 of the FCC Rules. Operation is subject to the following two conditions: (1) This device may not cause harmful interference, and (2) this device must accept any interference received, including interference that may cause undesired operation.

This mobile phone has been tested and found to comply with the limits for a Class B digital device, pursuant to Part 15 of the FCC Rules. These limits are designed to provide reasonable protection against harmful interference in a residential installation. This equipment generates, uses and can radiate radio frequency energy and, if not installed and used in accordance with the instructions, may cause harmful interference to radio communications. However, there is no guarantee that interference will not occur in a particular installation. If this equipment does cause harmful interference to radio or television reception, which can be determined by turning the equipment off and on, the user is encouraged to try to correct the interference by one or more of the following measures:

- Reorient or relocate the receiving antenna.
- Increase the separation between the equipment and receiver.
- Connect the equipment into an outlet on a circuit different from that to which the receiver is connected.
- Consult the dealer or an experienced radio/TV technician for help.

 **CAUTION:**

Changes or modifications not expressly approved by the party responsible for compliance could void the user's authority to operate the equipment.

Distraction

Driving

Full attention must be given to driving at all times in order to reduce the risk of an accident. Using a phone while driving (even with a hands free kit) can cause distraction and lead to an accident. You must comply with local laws and regulations restricting the use of wireless devices while driving.

Operating Machinery

Full attention must be given to operating the machinery in order to reduce the risk of an accident.

Product Handling

General Statement on Handling and Use

You alone are responsible for how you use your phone and any consequences of its use.

You must always switch off your phone wherever the use of a phone is prohibited. Use of your phone is subject to safety measures designed to protect users and their environment.

- Always treat your phone and its accessories with care and keep it in a clean and dust-free place.
- Do not expose your phone or its accessories to open flames or lit tobacco products.
- Do not expose your phone or its accessories to liquid, moisture or high humidity.
- Do not drop, throw or try to bend your phone or its accessories.
- Do not use harsh chemicals, cleaning solvents, or aerosols to clean the device or its accessories.
- Do not paint your phone or its accessories.
- Do not attempt to disassemble your phone or its accessories, only authorized personnel can do so.
- Do not expose your phone or its accessories to extreme temperatures, minimum - [20] and maximum + [60] degrees Celsius.

- The phone's normal operating temperature is 0°C ~ 45°C .In order to ensure the normal phone functions, do not use this phone outside the temperature range.
- Please check local regulations for disposal of electronic products.
- Do not carry your phone in your back pocket as it could break when you sit down.
- Use careful with the earphone maybe possible excessive sound pressure from earphones and headphones can cause hearing loss.

Small Children

Do not leave your phone and its accessories within the reach of small children or allow them to play with it.

They could hurt themselves or others, or could accidentally damage the phone.

Your phone contains small parts with sharp edges that may cause an injury or may become detached and create a choking hazard.

Demagnetization

To avoid the risk of demagnetization, do not allow electronic devices or magnetic media close to your phone for a long time.

Electrostatic Discharge (ESD)

Do not touch the micro-SIM card's metal connectors.

Antenna

Do not touch the antenna unnecessarily.

Normal Use Position

When placing or receiving a phone call, hold your phone to your ear, with the bottom towards your mouth.

Air Bags

Do not place a phone in the area over an air bag or in the air bag deployment area.

Store the phone safely before driving your vehicle.

Seizures/ Blackouts

The phone can produce a bright or flashing light.

Repetitive Motion Injuries

To minimize the risk of RSI when texting or playing games with your phone:

- Do not grip the phone too tightly.
- Press the buttons lightly.
- Use the special features which are designed to minimize the times of pressing buttons, such as Message

Templates and Predictive Text.

- Take lots of breaks to stretch and relax.

Emergency Calls

This phone, like any wireless phone, operates using radio signals, which cannot guarantee connection in all conditions. Therefore, you must never rely solely on any wireless phone for emergency communications.

Loud Noise

This phone is capable of producing loud noises, which may damage your hearing. Turn down the volume before using headphones, Bluetooth stereo headsets or other audio devices.

Phone Heating

Your phone may become warm during charging and during normal use.

Electrical Safety

Accessories

Use only approved accessories.

Do not connect with incompatible products or accessories.

Take care not to touch or allow metal objects, such as coins or key rings, to contact or short-circuit in the battery

terminals.

Connection to a Car

Seek professional advice when connecting a phone interface to the vehicle electrical system.

Faulty and Damaged Products

Do not attempt to disassemble the phone or its accessory.

Only qualified personnel can service or repair the phone or its accessory.

If your phone or its accessory has been submerged in water, punctured, or subjected to a severe fall, do not use it until you have taken it to be checked at an authorized service centre.

Interference

General Statement on Interface

Care must be taken when using the phone in close proximity to personal medical devices, such as pacemakers and hearing aids.

Pacemakers

Pacemaker manufacturers recommend that a minimum separation of 15 cm be maintained between a mobile phone and a pacemaker to avoid potential interference with the

pacemaker. To achieve this, use the phone on the opposite ear to your pacemaker and do not carry it in a breast pocket.

Hearing Aids

People with hearing aids or other cochlear implants may experience interfering noises when using wireless devices or when one is nearby.

The level of interference will depend on the type of hearing device and the distance from the interference source, increasing the separation between them may reduce the interference. You may also consult your hearing aid manufacturer to discuss alternatives.

Medical Devices

Please consult your doctor and the device manufacturer to determine if operation of your phone may interfere with the operation of your medical device.

Hospitals

Switch off your wireless device when requested to do so in hospitals, clinics or health care facilities. These requests are designed to prevent possible interference with sensitive medical equipment.

Aircraft

Switch off your wireless device whenever you are instructed to do so by airport or airline staff.

Consult the airline staff about the use of wireless devices on board the aircraft. If your device offers a 'flight mode', this must be enabled prior to boarding an aircraft.

Interference in Cars

Please note that because of possible interference to electronic equipment, some vehicle manufacturers forbid the use of mobile phones in their vehicles unless a hands-free kit with an external antenna is included in the installation.

Explosive Environments

Petrol Stations and Explosive Atmospheres

In locations with potentially explosive atmospheres, obey all posted signs to turn off wireless devices such as your phone or other radio equipment.

Areas with potentially explosive atmospheres include fuelling areas, below decks on boats, fuel or chemical transfer or storage facilities, areas where the air contains chemicals or particles, such as grain, dust, or metal powders.

Blasting Caps and Areas

Power off your mobile phone or wireless device when in a blasting area or in areas posted power off "two-way radios" or "electronic devices" to avoid interfering with blasting operations.

Getting Started

Overview

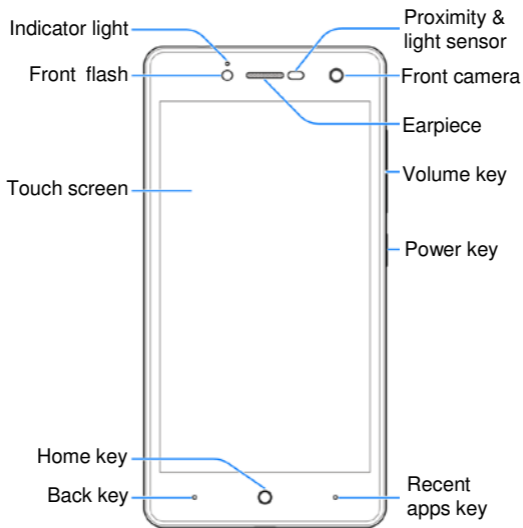

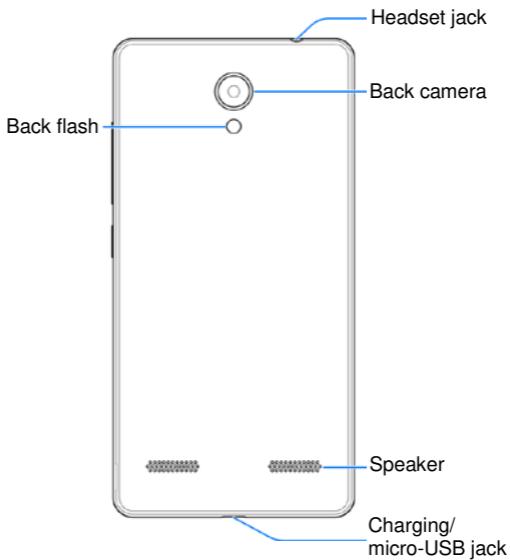

Keys Explained

Key	Function
Power Key	<ul style="list-style-type: none">• Press and hold to turn on or off airplane mode, restart, select phone modes, or power off.• Press to turn off or on the screen display.
Home Key	<ul style="list-style-type: none">• Touch to return to the Home Screen from any application or screen.• Touch and hold to use Google Search.
Back Key	Touch to go to the previous screen.
Recent apps Key	Touch to see recently used apps.
Volume Key	Press or hold either end of the key to turn the volume up or down.



NOTE:

The positions of the **Recent apps** key and the **Back** key are interchangeable through **Settings > Hard key**.

Starting up

Installing the micro-SIM Card and the microSDXC™ Card

WARNING!

To avoid damage to the phone, do not use any other kind of SIM cards, or any non-standard micro-SIM card cut from a SIM card. You can get a standard micro-SIM card from your service provider.

1. Place your finger in the slot at the bottom of the back cover to lift and remove the cover.

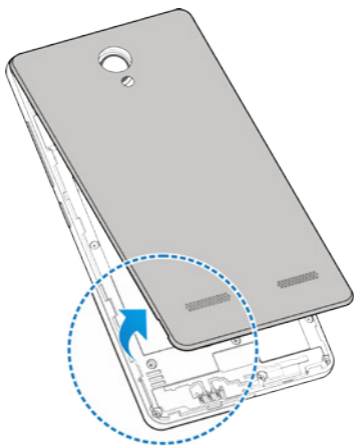

2. Hold the micro-SIM card with their cut corner oriented as shown and slip it into the card holder.

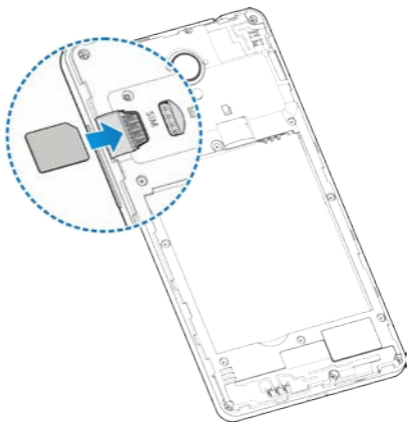

3. Hold your microSDXC card with the metal contacts facing down and slide it into the microSDXC card slot.

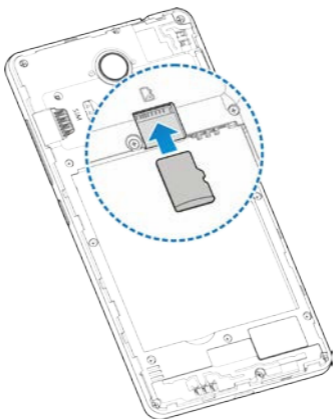

4. Insert the battery by aligning the golden contacts on the battery and those in the battery compartment. Gently push down on the battery until it clicks into place.

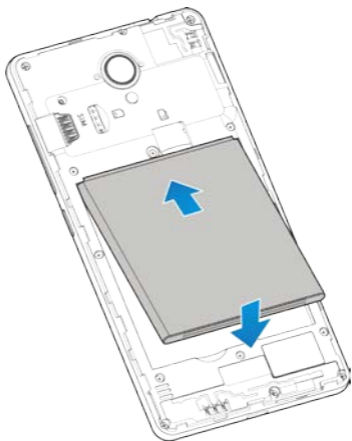

5. Replace the back cover.

Charging the Battery

Your phone's battery should have enough power for the phone to turn on, find a signal, and make a few calls. You should fully charge the battery as soon as possible.



If the battery is low, there will be a pop-up message on the screen. As you charge your phone, open the notification panel and drag the panel downwards, the screen will show you the exact battery level on the status bar.

 **WARNING!**

Use only ZTE-approved chargers and cables. The use of unapproved accessories could damage your phone or cause the battery to explode.

1. Connect the adapter to the charging jack. Ensure that the adapter is inserted with the correct orientation. Do not force the connector into the charging jack.



2. Connect the charger to a standard AC power outlet. If the phone is on, you'll see a charging icon, such as  or , appear on the status bar.
3. Disconnect the charger when the battery is fully charged.

 **NOTE:**

If the battery is extremely low, you may be unable to power on the phone even when it is being charged. In this case, try again after charging the phone for at least 20 minutes. Contact the customer service if you still cannot power on the phone after prolonged charging.

Powering On/Off



- Press and hold the **Power** key to turn on your phone.
- To switch it off, hold **Power** key to open the options menu and touch **Power off**.

Setting Up for the First Time

When you first power on your phone after you purchase it or reset it to factory settings, you need to do some settings before using it.

Touch the language field to select the language you want to use and then touch . Then follow the prompts to set up Wi-Fi, Google services and other options.

Waking Up Your Phone

1. Press the **Power** key to turn the screen on.
2. Drag  towards .
- or -

You can drag  towards any direction to access the application shortcuts.

NOTE:

If you have set an unlock pattern, PIN or complex password for your phone, you'll need to draw the pattern or enter the PIN/password to unlock your screen.

Getting Around Your Phone

Touch Control

You can use finger gestures to control your phone. The controls on your touch-screen change dynamically depending on the tasks you're performing.

- Touch the buttons, icons, or applications to select items or to open applications.
- Flick the screen to scroll up, down, left or right.
- Hold and drag to move particular items across the screen.
- Double-tap the screen to zoom in/out an image.

Home Screen

The Home Screen is the starting point for your phone's applications, functions, and menus. You can customize your Home Screen by adding folders, widgets, and more.

Extended Home Screen

The Home Screen extends beyond the screen width, giving you loads more space to add more stuff. Simply slide your finger to the left or right.

Choosing Your Wallpaper

1. Touch and hold the **Recent apps key** from the Home Screen.
2. In the window that appears at the bottom, touch **Wallpaper**.
3. Slide left or right on the wallpaper tab to select an image as the wallpaper. You can also touch **Gallery** or **Camera** to choose or capture a picture. Some cropping may be needed for **Gallery** images.



NOTE:

In addition, you can touch the **Home key**, slide screen to touch **Settings > Display > Wallpaper** to pick an image from **Gallery**, or **Photos**, or an animation from **Live Wallpapers**.



NOTE:

To change the home screen wallpaper blur effect, touch and hold the **Recent apps key** from the Home Screen, touch

Wallpaper and drag the **Blur level** bar to adjust it. This feature is not available for live wallpapers.

Removing Items From Your Home Screen

1. Touch the **Home** key to return to the Home Screen.
2. Touch and hold the item you want to delete.
3. Drag it to  to delete it.
4. If the item is an application, touch **OK** to uninstall it.















NOTE:

Some preinstalled apps cannot be uninstalled.

Status and Notification Icons

Your phone will tell you exactly what's going on by showing you simple icons. Here's what they mean.

	USB tethering on		Missed call
	Airplane mode		Bluetooth icon
	New Wi-Fi network detected		New message
	Battery charge		Connected to a Wi-Fi [®] network
	Song playing		Portable Wi-Fi hotspot is on
	Alarm set		Vibration on



Open/Close the Notification Panel

Notifications report the arrival of new messages, calendar events, and alarms, as well as ongoing events, such as when you've configured your phone as a Wi-Fi hotspot. You can open the notification panel to view the details of notifications.



- To open the notification panel, swipe your finger down from the top of the screen.
- To close the notification panel, swipe your finger up on the screen or touch the **Back** key.

Phone Calls

Making Calls

You can place calls from the Phone app, the People app, or other apps or widgets that display contact information. Wherever you see a phone number, you can usually touch it to dial.

Calling From the Phone

1. Touch  on the Home Screen.
2. Touch  and enter the phone number with the dialpad.
Touch  to delete incorrect digits.

3. Touch  below the keypad to dial.

 **NOTE:**

To make an international call, touch and hold the 0 key to enter the plus (+) symbol. Next, enter the country code, followed by the city/area code and then the phone number.



Calling From Your Contacts

1. Touch the **Home** key and slide on the screen to select **Contacts**.
2. Slide your finger to scroll the contacts list and touch the contact you want to call.

You can search for a contact by tapping  on the top of the screen.

3. Touch  next to a contact to place the call.

Calling From Your Call History

1. Touch the **Home** key >  > .
2. Touch a listing to call back.

Calling From a Text Message



If a text message contains a phone number that you want to call, you can make the call while viewing the text message.

1. Touch the **Home** key > .

2. Touch the conversation and then find the message that contains the phone number you need.
3. Touch the message, the phone will list the options.
4. Touch .

Receiving Calls

Answering a Call

When you receive a phone call, drag  over  to answer the call.

- or -

If the screen is unlocked, touch the  **icon** to answer the call.

Rejecting a Call

When you receive a phone call, you can:

Drag  over  to reject the call.







- or -

If the screen is unlocked, touch the  **icon** to reject the call.

Using Options During a Call

During a call, you will see a number of onscreen options.

Touch an option to select it.

- Touch  to turn on or off the speaker.
- Touch  to mute or unmute your microphone.
- Touch  to switch to the keypad when you need to enter a code (for example, the PIN for your voicemail or bank account) during the call.
- Touch  to put the call on hold.
- Touch  > **Add call** to make another call separately from the first call, which is put on hold.
- Touch  > **Record** to record phone conversation.

Ending a Call

Tap  to finish a call.

Call settings

Touch the **Home** key >  >  (in the top search field) > **Settings** > **Calls**.

- **Voicemail:** Touch to configure voicemail settings.
- **Fixed Dialing Numbers:** Fixed Dialing Numbers (FDN) allows you to restrict outgoing calls to a limited set of phone numbers.
- **Call forwarding:** Call forwarding feature allows you to forward your incoming calls to another phone number.



- **Call barring:** Call barring feature allows you to forbid certain types of calls from your phone.
- **Additional settings:** Check **Call waiting** to get notified of incoming calls during a call.
- **SDN list:** Show the SDN list.
- **LDN list:** Show the LDN list.

Contacts

You can add contacts on your phone and synchronize them with the contacts in your Google account or other accounts that support contact syncing.

To see your contacts, touch the **Home** key and slide on the screen to select .

Creating a Contact

1. Touch  to add a new contact.
2. Touch the account field to choose where to save the contact. You can save the contact on the phone, a micro-SIM card, or a web account you have added on the phone.
3. Enter the contact name, phone numbers, email addresses, and other information.
4. Touch  to save the contact..

Searching for a Contact

1. Touch  on the top of the Contacts Screen.
2. Input the contact name you want to search for. The contacts matched will be listed.

Messaging



Your SMS (text message) and MMS (multimedia messaging service) are combined into one menu in **Home** key > .

The Message Box

Instead of an inbox and outbox, your phone organizes all Messaging you sent and received into one box, where Messaging exchanged with the same number are grouped into one message thread in the Messaging Screen. You can tap a thread to see the conversation you have had with someone.

Sending a Message

1. On the **Messaging** screen, touch  at the bottom.
2. Add recipients by one of the following ways.
 - ▶ Touch the **To** field and manually enter the recipient's number or the contact name. If the phone presents a few suggestions, touch the one you want to add.

- ▶ Select recipients from your contacts or call log on the screen.
- 3. Touch the **Send message** field and enter the message text.
- 4. If you want to send a multimedia message, touch  to attach a file to the message.
- 5. Touch .

 **NOTES:**

- You can also include email addresses as recipients for a multimedia message.
- Do not add any attachment if you want to send a text message. Otherwise you may be charged for a multimedia message.



Message Settings

The phone's message settings are pre-configured for you to use immediately. To change them, touch  > **Settings** in the Messaging screen to change the messaging settings.

Connecting to Networks and Devices

Set Access Point Names

To connect to the Internet you can use the default Access Point Names (APN). And if you want to add a new APN, please contact the service provider to get the necessary information.

1. Touch the **Home** key and slide on the screen to select **Settings > More > Cellular networks**.
2. Touch **Access Point Names >** .
3. Touch each item to enter the information you get from your service provider.
4. Touch  > **Save** to complete.

NOTE:

To set the APN to default settings, touch  > **Reset to default**.

Turn Wi-Fi On and Connect to a Wi-Fi Network

1. Touch the **Home** key and slide on the screen to select **Settings > Wi-Fi**.

2. Slide the switch next to **Wi-Fi** to turn on Wi-Fi.
3. Touch a network name to connect to it.
4. If the network is secured, enter the password and touch **CONNECT**.



NOTE:

Your phone automatically connects to previously used Wi-Fi networks when they are in range.

Bluetooth

Bluetooth[®] is a short-range wireless communication technology. Phones or other devices with Bluetooth capabilities can exchange information wirelessly within a distance of about 10 meters (32.8 feet). The Bluetooth devices must be paired before the communication is performed.

1. Touch the **Home** key and slide on the screen to select **Settings > Bluetooth**.
2. Slide the switch next to **Bluetooth** to turn on or off Bluetooth.

When Bluetooth is on, the  icon appears in the status bar.

Tethering & portable hotspot

You can share your phone's data capabilities through tethering or by activating the mobile hotspot feature to create a portable Wi-Fi hotspot.

Share Your Mobile Data Connection via Bluetooth

1. Pair your phone with your computer via Bluetooth.
2. Configure your computer to obtain its network connection via Bluetooth. For more information, please see your computer's documents.
3. Touch the **Home** key slide on the screen to select **Settings > More > Tethering & portable hotspot**.
4. Switch on **Bluetooth tethering**. Your computer is now sharing your phone's data connection.



NOTE:

To stop sharing your data connection, switch off **Bluetooth tethering**.

Share Your Mobile Data Connection as a Wi-Fi Hotspot

When the portable Wi-Fi hotspot feature is enabled, you cannot use your phone's Wi-Fi capability to access the Internet. You still remain connected to the Internet via your mobile data network.

1. Touch the **Home** key slide on the screen to select **Settings > More > Tethering & portable hotspot**.

2. Switch on **Portable Wi-Fi hotspot**.

After a moment, the phone starts broadcasting its Wi-Fi network name (SSID).

3. On another device, locate your phone via Wi-Fi and connect with it to start using the phone's mobile data.



NOTE:

To stop sharing your data connection, switch off **Portable Wi-Fi hotspot**.

Browser

Use **Browser** to view web pages and search for information.

Opening the Browser

Touch the **Home** key >  to launch the web browser.

You can also open the browser by touching a web link - for example, in an email or a text message.

1. Open the **Browser** app.
2. Touch the address box.
3. Enter the address (URL) of a web page or enter terms you want to search for.
4. Touch a URL or search suggestion or touch  on the keyboard to open the web page or search results.

Using Multiple Browser Tabs

You can open several web pages at the same time (one page in each tab) and switch between them freely.

To open a new browser tab:

Touch  > **New window**. A new browser tab opens.

To switch between tabs:

1. Touch . Titles of opened tabs appear as a list.
2. Touch the title you want to open.

NOTE:

Swipe a title horizontally or touch its  to close the tab.

Downloading Files

1. Touch and hold an image or a link to a file or to another web page.
2. In the menu that opens, touch **Save image** or **Save link**.

The downloaded files are saved to your phone. You can view or open them in the **Downloads** app.



Changing Browser Settings

You can configure a number of settings to customize the way you browse the web, including several that you can use to control your privacy.



To open the browser settings screen, touch  > **Settings**.

Using Multimedia Apps

Taking Pictures With Your Camera

1. Touch the **Home** key and slide on the screen to touch .
2. Aim the camera at the subject and make any necessary adjustment.
 **NOTE:**
You can spread or pinch on the screen to zoom in or out before taking pictures.
3. Touch the area where you want the camera to focus, or leave the camera to autofocus on the center of the image.
4. Lightly touch . The **Volume** key can also be used to take a photo.

Recording Videos With Your Camcorder

1. Touch the **Home** key and slide on the screen to touch .
2. Slide right on the screen and touch .
3. Aim the camera at the subject. You can touch any area on the screen that you want the camcorder to focus on

before and during recording.



NOTE:

You can spread or pinch on the screen to zoom in or out before and during recording.

4. Touch  to start recording a video.



NOTE:

While the recording is in progress, touch  to pause the recording.

5. Touch  to stop recording.

Listening to Your FM Radio

With the FM Radio, you can search for radio channels, listen to them, and collect them to your phone. Note that the quality of the radio broadcast depends on the coverage of the radio station in your area. The wired headset works as an antenna, so always connect the headset when using the radio.

1. Plug your headset into your phone.
2. Touch the **Home** key and slide on the screen to select **FM Radio**.

Playing Your Music

Music supports a wide variety of audio formats, so it can play music you purchase from online stores, music you copy from your CD collection, and so on.

1. Touch the **Home** key, slide screen to touch **Music** to open the Music Screen.
2. Touch a song in any list.
3. Adjust the volume with **Volume key**.

Opening Your Gallery

Touch the **Home** key and slide on the screen to select **Gallery** to view albums of your pictures and videos. You can also do some basic editing of your pictures – such as setting them as wallpaper or contact photo, and sharing with friends.



Making Voice Memos



Sound Recorder enables you to record voice memos and listen to them whenever you like.

To record voice memo:

1. Touch the **Home** key and slide on the screen to select **Sound Recorder**.

2. Touch  to start recording.

During recording, you can Touch  /  to pause or continue the recording.

3. Touch  to stop recording.
 - ▶ Touch  > **CANCEL** to delete the recording.
 - ▶ Touch  > **OK** to save the recording.

To play any saved memo:

1. Touch  at the bottom right of the screen to see all recordings.
2. Touch the title of a memo to play it.

Using Your Google Applications

Signing in to your Google Account lets you synchronize Gmail, Calendar, and Contacts between your phone and the web. And if you don't have an account, you can easily create one.

Gmail

Gmail is a web-based email service that's configured when you sign in to your Google account. Depending on your synchronization settings, the Gmail on your phone can be automatically synchronized with your Gmail account on the web. This is how to enter Gmail:

To open **Gmail** by touching the **Home** key > **Google**> **Gmail**.

Google Play™ Store

Touch the **Home** key > **Play Store**. You can buy or rent music, books, movies, apps, and download them to your phone.

NOTE:

The content you can access in Google Play Store depends on your region and your service provider.

Other Applications

Clock

Touch the **Home** key and slide on the screen to select **Clock**. The **Clock** app allows you to check local time in places around the world, set alarms, and use timers.

File Explorer

Quickly access all of your images, videos, audio clips, and other types of files on your phone storage.

Touch the **Home** key and slide on the screen to select **File Explorer**. You can touch a file category to find the file you need, or touch **Internal Storage** or **External Storage** to browse folders and files on the phone storage, or the microSDXC card.

Settings

The **Settings** app contains most of the tools for customizing and configuring your phone.

Wi-Fi

Touch the **Home** key and slide on the screen to select **Settings > Wi-Fi**. You can turn Wi-Fi on or off and configure your Wi-Fi connections.

Bluetooth

Touch the **Home** key and slide on the screen to select **Settings > Bluetooth**. You can turn Bluetooth on or off and configure your Bluetooth connections.

Wi-Fi hotspot

Touch the **Home** key and slide on the screen to select **Settings > More > Tethering & portable hotspot > Portable Wi-Fi hotspot** to share your phone's mobile data connection with PCs or other devices via Wi-Fi.

Airplane Mode

Touch the **Home** key and slide on the screen to select **Settings > More**, and then slide the switch beside **Airplane mode** to turn airplane mode on or off. All the phone's radios that transmit voice or data are turned off when airplane mode is on.

Data Usage

Touch the **Home** key and slide on the screen to select **Settings > Data usage** to manage mobile data use.

Touch the **Cellular data** switch to turn on or off mobile data.

Touch the **Set cellular data limit** switch to turn on or off mobile data limit.

You can check how much data has been used during the time cycle you set, set mobile data limit and warning, see what apps have been using mobile data, or restrict background data for individual apps.

NOTE:

The data usage is measured by your phone, and your carrier's data usage accounting may differ.

VPN

Touch the **Home** key and slide on the screen to select **Settings > More > VPN** to set up and connect to virtual private networks.

Bluetooth Tethering

Touch the **Home** key and slide on the screen to select **Settings > More > Tethering & portable hotspot > Bluetooth Tethering** to share your phone's mobile data connection with PCs or other devices via Bluetooth.

Hotspot Settings

Touch the **Home** key and slide on the screen to select **Settings > More > Tethering & portable hotspot > Wi-Fi hotspot settings and user management** to configure hotspot settings.

Hard keys

Touch the **Home** key and slide on the screen to select **Settings > Hard key**. You can exchange the location of the **Recent apps** key and the **Back** key.

Themes & Wallpapers

Touch the **Home** key and slide on the screen to select **Settings > Display > Wallpaper**. You can change the home screen wallpaper.

Display

Touch the **Home** key and slide on the screen to select **Settings > Display** to configure the display options.

Prompt & notification

Touch the **Home** key and slide on the screen to select **Settings > Prompt & notification** to control the display of prompts and notifications.

Audio Profiles

Touch the **Home** key and slide on the screen to select **Settings > Audio Profiles**. You can adjust different types of volume, toggle sound, vibration and mute, set up ringtone and notification sound, or select touch sounds.

Apps

Touch the **Home** key and slide on the screen to select **Settings > Apps** to see apps installed on your phone and manage them.

Storage & USB

Touch the **Home** key and slide on the screen to select **Settings > Storage & USB** to view the memory information of the internal storage and the microSDXC card.

Touch **Internal storage** to get a detailed breakdown of space usage by type. Touch a data type to see more information or delete the files you do not need.

Battery

Touch the **Home** key and slide on the screen to select **Settings > Battery** to view the battery level, check what has been using the battery, and enable the automatically battery saving mode.

Memory

Touch the **Home** key and slide on the screen to select **Settings > Memory** to monitor the average memory use and performance of your phone. You can also check which apps use the most memory.

Location

Touch the **Home** key and slide on the screen to select **Settings > Location** to manage location services, which help your phone and apps determine your location. To use location-related applications, such as finding your location on Google Maps, you must have location services turned on on your phone.

1. Slide the switch at the top to turn location services on or off.
2. When location is enabled, touch **Mode** to select location sources you want to use.

In the **Location** menu, touch **Google Location History** to configure Google location options.

Security

Touch the **Home** key and slide on the screen to select **Settings > Security** to configure options that help keep your phone and data safe.

Accounts

Touch the **Home** key and slide on the screen to select **Settings > Accounts** to manage your web accounts and synchronization. Touch **Add account** to sign in to or create accounts on your phone.

Touch an account type to see that type of accounts you have added and adjust the accounts settings.

Google

Touch the **Home** key and slide on the screen to select **Settings > Google** to easily manage settings for Google apps and features. You can set the options for Google account and services.

Language & input

Touch the **Home** key and slide on the screen to select **Settings > Language & input** to configure options related to system language, input methods, speech input and output as well as mouse/trackpad input.

Backup and Reset

Touch the **Home** key, slide on the screen and touch **Settings > Backup & reset** to manage data backup and restoration options, and to reset the network setting or the phone to factory status.

Timer Switch Machine

Touch the **Home** key and slide on the screen to select **Settings > Timer Switch Machine** to set the repeat and time when the alarm automatically powers on or off. You can also touch the switches on the right to turn the features on or off.

Date & Time

Touch the **Home** key and slide on the screen to select **Settings > Date & time** to set date, time, time zone, time format and more.

Accessibility

Touch the **Home** key and slide on the screen to select **Settings > Accessibility** to configure accessibility plug-ins and services on your phone, such as using **Color inversion** or **High contrast text** for users with sight problems.

Printing

Touch the **Home** key and slide on the screen to select **Settings > Printing** to manage Google Cloud Print service or other printer plug-ins installed from the Google Play Store or your printer manufacturer.

About Phone

Touch the **Home** key and slide on the screen to select **Settings > About phone** to view important phone information and legal information. You can also touch **My Phone Name** to give your phone a name for easy identification when others want to connect to your phone via Bluetooth or Wi-Fi hotspot.