



# ZTE WP659

## GSM Wireless Phone

### User Guide



**ZTE CORPORATION**

NO. 55, Hi-tech Road South, ShenZhen, P.R.China

Postcode: 518057

<http://www.zte.com.cn> [mobile@zte.com.cn](mailto:mobile@zte.com.cn)

Service Hotline: +86-755-26779999

---

The information on the package is only for your reference. Images are for your reference only. Please check the product model before purchasing.  
ZTE reserves the rights to change specifications and parameters of the products without further notice.

## Know Your Phone

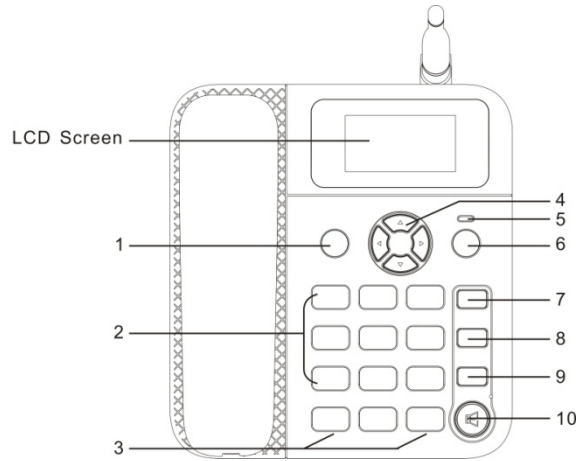

## Key Instruction

Key	Description
<b>1. MENU/SELECT</b>	<ul style="list-style-type: none"><li>• Enter main menu.</li><li>• Performs the function indicated at the left bottom of the screen.</li></ul>







Key	Description
2. <b>Number</b>	<ul style="list-style-type: none"> <li>• Use these keys to enter numbers and characters.</li> </ul>
3. <b># , *</b>	<ul style="list-style-type: none"> <li>• Perform different functions under different conditions.</li> </ul>
4. <b>Scrolling</b>	<ul style="list-style-type: none"> <li>• Press these keys to scroll cursor to the left, right, up or down when inputting characters or selecting items.</li> <li>• Default functions in standby mode are set in Settings menu.</li> </ul>
5. <b>EXT PWR</b>	<ul style="list-style-type: none"> <li>• Lights up when the phone is connected to external power outlet.</li> </ul>
6. <b>NAMES/CLR/BACK</b>	<ul style="list-style-type: none"> <li>• Performs the function indicated at the right bottom of the screen.</li> </ul>
7. <b>MESSAGE</b>	<ul style="list-style-type: none"> <li>• This is the shortcut key to enter message menu in standby mode.</li> </ul>
8. <b>EXIT</b>	<ul style="list-style-type: none"> <li>• End an active call or reject calls.</li> <li>• Power on/power off the phone.</li> </ul>
9. <b>CALL/REDIAL</b>	<ul style="list-style-type: none"> <li>• Make a call or answer an incoming call.</li> <li>• In standby mode, press this key to enter Dialed calls list.</li> </ul>

Key	Description
10.HANDS-FREE	<ul style="list-style-type: none"> <li>• If you are using the handset to call and want to transfer the call to the speakerphone, press this key and hang up the handset to put conversation on the speakerphone.</li> <li>• Press this key to end a hands-free call.</li> </ul>

**Notes:**

*In this manual, "press" a key means to press the key once, "hold" a key means to press the key for 2 or 3 seconds.*

### Interface Icons

Icon	Description	Icon	Description
	Signal strength		New message
	Silent		Unconditional divert
	Power indicator		Alarm clock

### Installation

**1. Handset**

Connect phone and handset via the phone cord.

**2. External power adapter**

Plug the external power adapter to the external AC socket.

### 3. SIM card

Always switch the phone off before removing or inserting SIM card.

Open the bottom cover of the battery. Remove the battery, slide the SIM card into the SIM card slot. Make sure that the contact area of the card is facing down, and the beveled corner matches with the SIM card slot. Put in the battery and install the bottom cover.

## How to Power on/off

- ◆ To power on the phone, connect phone and external power outlet with the power adapter and then hold the **EXIT** key till the phone is powered on.
- ◆ To power off the phone, at standby mode, hold the **EXIT** key till the phone is powered off.

### Notes:

***It is strongly recommended to connect the phone to external power outlet, and use internal battery to power your phone only when external power fails or is not available. The phone will charge the internal battery automatically when it is connected to external power outlet.***

## How to Make a Call

There are two methods for making a call.

### ■ The first method:

1. Pick up the handset or press the **HANDS-FREE** key.
2. Enter the phone number, press **CALL/REDIAL** key to make the call.

### ■ The second method:

Enter the number or select recipient's number from **Contacts**, or press **CALL/REDIAL** key to select a number from the Dialed calls list, then press **CALL/REDIAL** key to make the call.

### Notes:

***Add the international prefix, country code and area code (without the leading 0) before the number when making an international call.***

## **Voice mail server**

Before using voice mail, please contact service provider to confirm that the voicemail has been activated.

The system automatically sends a message to your phone to inform you that there is a new voice mail. Read the message and then dial voice mailbox number to listen to your voice mail.

To read or send your voice mail, please hold "1" key to dial voice mail box number in standby mode.

## **Message**

Select **Message** in **Menu**.

- Select **Write message** to write message, Press **Options** select **Send** or **Save as draft**.
- Select **Inbox** to view messages received.
- Select **Outbox** to view the failure messages.
- Select **Drafts** to view the draft messages.
- Select **Sentbox** to view the successfully sent messages.
- Select **Templates** to View the template messages.
- Select **Voice mail server** to listen to your voice mail messages, or set the voice mailbox number.
- Select **Settings** to make some necessary short message settings.
- Select **Message capacity** to View the message of saved entries and maximum number of entries capacity in phone and SIM.

## **Phone Code**

Phone code could prevent your phone from unauthorized use. The default phone code is 1234. Change it to your own as soon as possible.

If you change the default phone code to a new one, remember it or place it at secure place.

## **PIN Code and PUK Code**

- **PIN** code: PIN code could prevent your SIM card from illegal use. When PIN code is enabled, you should enter the PIN code when powering on the phone again. Change the default PIN code to your own as soon as possible.
- **PUK** code: The SIM card will be locked if you enter a wrong PIN code consecutively for three times. To unlock, you need PUK code.

**Notes:**

***PIN code and PUK code may be offered together with the SIM card. If not, contact your service provider.***

## **Text Input**

<b>Operation</b>	<b>Method</b>
Input digits	"123", press the <b>Number</b> keys to input the digits you want directly.
Input letters	"Abc", "abc", "ABC", press corresponding letter key till the letter appears.
Input words	"En", "en", "EN", press the Number keys to input the characters of the word. Then press <b>MENU/SELECT</b> key to confirm.
Input symbol	Press * key, and then select corresponding symbol by using <b>Scrolling</b> keys.
Input space	Apart from <b>Numbers</b> input mode, press "0" key to add space.

Operation	Method
Erase character	Press <b>NAMES/CLR/BACK</b> key.
Erase all the characters	Hold <b>NAMES/CLR/BACK</b> key until the cursor before the character be erased.
Move the cursor	Press <b>Scrolling</b> keys.
Change input mode	Press <b>#</b> key to change text input mode.

## Menu Function

Hereinafter are brief instructions for menu functions of the phone.

Function	Description	Selection
Create message	Create message and send to others.	Menu→ Message→ Write message
Read message	Read message in Inbox, Outbox, Drafts, Sentbox.	Menu→ Message→ Inbox/Outbox/Drafts/Sentbox
Voice mail	Receive and listen to voice mail messages. Set voice mailbox number.	Menu→ Message→ Voice mail server
Message settings	Make some necessary short message settings.	Menu→ Message→ settings



Function	Description	Selection
Recent calls	View or dial all recent calls.	Menu→ Call logs→ Missed calls/Dialed calls/Received calls
Call duration	Check the Last call, Received calls, Dialed calls or Call history duration.	Menu→ Call logs→ Call timers
Browse contact	View contacts	Menu→ Contacts
Add contact	Save phone number.	Menu→ Contacts→ Options → New
Speed dial list	Set and view speed dial list.	Menu→ Contacts→ Options → Others→ Speed dial
Call divert	Specify the conditions under which the call types should be diverted to another number.	Menu→ Settings→ Call settings→ Call divert
Call waiting	Put the current call on hold to answer the other incoming call.	Menu→ Settings→ Call settings→ Call waiting
Call barring	Restrict the dialing or receiving of certain calls.	Menu→ Settings→ Call settings→ Call barred

Function	Description	Selection
Minute beep	Set Minute beep	Menu→ Settings→ Call settings→ Minute beep
Auto redial	Set auto redial function.	Menu→ Settings→ Call settings→ Auto redial
Time and date	Set the date and the time, and the date and time format.	Menu→ Settings→ Phone settings→ Time & date
Shortcut key	Set the scrolling key as shortcut key of some menu.	Menu→ Settings→ Phone settings→ Shortcut settings
Keypad lock	Lock the keypad automatically. Press # key, then * key to unlock.	Menu→ Settings→ Phone settings→ Auto keypad lock
Backlight	Set the backlight time, when using the phone.	Menu→ Settings→ Backlight
PIN code	Set or change the PIN code	Menu→ Settings→ Security → PIN
Phone code	Set or change the phone lock code.	Menu→ Settings→ Security → Phone locked
Restore	Switch to the factory default	Menu→ Settings→ Security

Function	Description	Selection
factory settings	settings. The phone will clew input password, the password default 1234.	→ Restore factory settings
Profiles	Set profiles of your phone.	Menu→ Settings→ Profiles
Network Settings	Set the way of searching network.	Menu→ Settings→ Network selection
Calculator	Execute basic math calculation.	Menu→ Tools→ Calculator
Alarm clock	Set alarm clock.	Menu→ Tools→ Alarm
FM radio	Listen to FM radio.	Menu→ Tools→ FM radio.
STK	SIM Card Tool Kit (various for different SIM card).	Menu→ STK

### **Warning and Maintenance**

- Some electronic devices are susceptible to electromagnetic interference sent by the phone if inadequately shielded. Keep using the phone at least 20 cm or as far away as you can from TV sets, radio and other automated office equipment so as to avoid electromagnetic interference.
- Operating the phone may interfere with medical devices like hearing aides and pacemakers, or other medical devices in hospital. Consult a physician or the manufacturer of the medical device before using the phone.
- Be aware of the usage limitation when using the phone at places such as oil

warehouses, or chemical factories, where there are explosive gases or explosive products being processed, because even if your phone is in idle state, it still transmits radio frequency (RF) energy. Therefore, power off your phone if required.

- Do not touch the antenna while calling. Otherwise it will affect the quality of calling and waste battery energy. The damaged antenna will cause slight burn while touching your skin.
- Keep the antenna free from obstructions and position the antenna straight up. This will ensure best call quality.
- Keep the phone out of the reach of small children. The phone may cause injury if used as a toy.
- Do not put other things on the terminal to avoid overlaying radiator.
- Use original accessories or accessories that are authorized by the manufacturer. Using any unauthorized accessories may affect your phone's performance, and violate related national regulations about telecom terminals, or even endanger your body.
- As your phone can produce electromagnetic field, do not place it near magnetic items such as computer disks.
- Do not expose your phone to direct sunlight or store it in hot areas. High temperature can shorten the life of electronic devices.
- Prevent liquid from leaking into your phone.
- Disconnect external power supply and do not use your phone during thunderstorm.
- Unplug the external power adapter or remove battery when your phone is not in use, esp. for a long period of time.
- It is highly recommended to charge the battery before initial use. The battery might have been discharged during storage and delivery.
- Do not unplug the connector of the data cable from the phone, and not install or remove battery, when the power is on.
- Do not attempt to disassemble the phone by yourself. Non-expert handling of the devices may damage them.
- The phone is non-waterproof, keep it dry and store in shady and cool place.
- If you want to clean your phone, please use clean fabric that is a bit wet or anti-static. Do not use harsh chemical cleaning solvents or strong detergents to

clean your phone, such as alcohol, dilution agent and benzene. Power off your phone before you clean it.

### **Limited Warranty**

- This warranty does not apply to defects or errors in the Product caused by:
    - i. Reasonable Router Appearance Disfiguration.
    - ii. End User's failure to follow ZTE's installation, operation or maintenance instructions or procedures.
    - iii. End User's mishandling, misuse, negligence, or improper installation, disassemble, storage, servicing or operation of the Product.
    - iv. Modifications or repairs not made by ZTE or a ZTE-certified individual.
    - v. Power failures, surges, fire, flood, accident, actions of third parties or other events outside ZTE's reasonable control.
    - vi. Usage of products of third Parties, or usage in conjunction with third party products provided that such defects is due to the combined usage.
    - vii. Any other cause beyond the range of normal usage for Products.
- End User shall have no right to reject, return, or receive a refund for any product from ZTE under the above-mentioned situations.
- This warranty is end user's sole remedy and ZTE's sole liability for defective or nonconforming items, and is in lieu of all other warranties, expressed, implied or statutory, including but not limited to the implied warranties of merchantability and fitness for a particular purpose, unless otherwise required under the mandatory provisions of the law.

### **Limitation of Liability**

ZTE shall not be liable for any loss of profits or indirect, special, incidental or consequential damages resulting from or arising out of or in connection with using of this product, whether or not ZTE had been advised, knew or should have known of the possibility of such damages, including, but not limited to lost profits, interruption of business, cost of capital, cost of substitute facilities or product, or any downtime cost.

### **Troubleshooting**

If your phone appears following phenomenon in the process of application, read following relative information at first. If the problems still can not be solved, please contact with the distributor or service provider.

<b>Problem</b>	<b>Check Point</b>
When switching on the phone, it prompts Enter "PIN".	Input your PIN code which offered with SIM card together. If you have changed PIN code, input the new PIN code.
When switching on the phone, it prompts "Emergency".	Check whether valid SIM card is inserted or not.
When switching on the phone, it prompts Enter "Phone locked".	Enter lock code you set already to unlock the phone.
No ring tone prompt for a incoming call.	Check volume setting of ring tone. And check whether "mute" is set in Profiles.
No display on screen when disconnect external power supply.	Check whether the battery has electricity, or it is damaged; or power on the phone again.
Press CALL/REDIAL key, but no number is sent.	Check whether you have set call barring.
Certain call cannot be received.	Check whether the number is restricted.
Cannot send short messages.	Check the network condition, or

Problem	Check Point
	message center setting.
Other abnormal phenomenon.	First refer to the user manual, and then check whether the power is connected correctly or not. If there is no problem, restart the phone.

**FCC Regulations:**

This device complies with part 15 of the FCC Rules. Operation is subject to the following two conditions: (1) This device may not cause harmful interference, and (2) this device must accept any interference received, including interference that may cause undesired operation.

This device has been tested and found to comply with the limits for a Class B digital device, pursuant to Part 15 of the FCC Rules. These limits are designed to provide reasonable protection against harmful interference in a residential installation. This equipment generates, uses and can radiated radio frequency energy and, if not installed and used in accordance with the instructions, may cause harmful interference to radio communications. However, there is no guarantee that interference will not occur in a particular installation. If this equipment does cause harmful interference to radio or television reception, which can be determined by turning the equipment off and on, the user is encouraged to try to correct the interference by one or more of the following measures:

- Reorient or relocate the receiving antenna.
- Increase the separation between the equipment and receiver.
- Connect the equipment into an outlet on a circuit different from that to which the receiver is connected.
- Consult the dealer or an experienced radio/TV technician for help.

Changes or modifications not expressly approved by the party responsible for compliance could void the user's authority to operate the equipment.

**RF Exposure Information**

This device meets the government's requirements for exposure to radio waves. This device is designed and manufactured not to exceed the emission limits for exposure to radio frequency (RF) energy set by the Federal Communications Commission of the U.S. Government.

- This device complies with FCC radiation exposure limits set forth for an uncontrolled environment. In order to avoid the possibility of exceeding the FCC radio frequency exposure limits, human proximity to the antenna shall not be less than 20cm (8 inches) during normal operation.