

ZANUSSI

 **Electrolux**

WASHING MACHINE TLE 1116 W

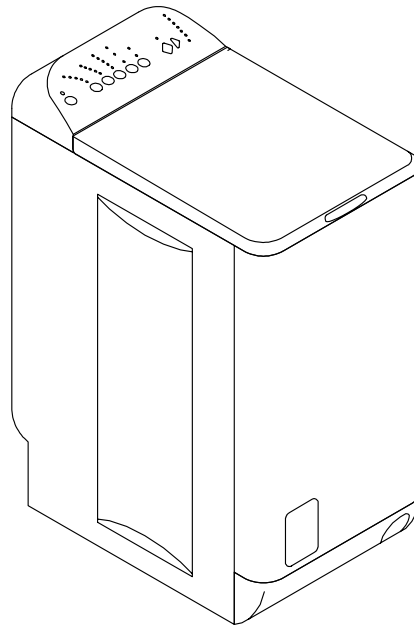

Contents

For the User

Important Safety Information	3
Your New Washing Machine	4
Description of the Appliance	5
Detergent Dispenser	5
The Control Panel	6-8
Operating Sequence	9-11
Before use	9
Load the laundry	9
Measure out the detergent	9
Add the fabric softener	9
Switch the machine on	9
Select the desired programme/fabric	9
Select the temperature	9
Select the spin speed and the rinse hold option	10
Select the soil level	10
Select the desired options	10
Start the programme	10
How to change a programme during a cycle	10
How to cancel a programme during a cycle	10
How to open the lid during the cycle	11
End of programme	11
Washing Hints	12-13
Which detergent ? ...	13
And in which form ?	13
Wash Care Symbols	14
Washing programmes	15-16

Maintenance and Cleaning	17-18
Descaling	17
After each wash	17
External cleaning	17
Cleaning the detergent dispenser	17
Cleaning the drain filter	17-18
Maintenance wash	18
The dangers of freezing	18
Something Not Working	19-20
Service and Spare Parts	21
Customer Care Department	21
Guarantee Conditions	22

For the Installer

Installation Instructions	23
Technical Specifications	23
Unpacking	24
Positioning	24
Levelling	25
Moving the appliance	25
Water inlet	26
Water drainage	26
Electrical connection	27

Guide to use the Instruction Book

The following symbols will be found in the text to guide you throughout the instructions:

 Safety instructions

 Hints and tips

 Environmental information



Important Safety Information

It is most important that this instruction book should be retained with the appliance for future reference. Should the appliance be sold or transferred to another owner, or should you move house and leave the appliance, always ensure that the book is supplied with the appliance in order that the new owner can get to know the functioning of the appliance and the relevant warnings.

These warnings have been provided in the interest of safety. You **MUST** read them carefully before installing or using the appliance.

Installation

- This appliance is heavy. Care should be taken when moving it.
- It is dangerous to alter the specifications or attempt to modify this appliance in any way.
- All packaging and transit bolts must be removed before use. Serious damage can occur to the product and to property if this is not adhered to. See relevant section in instructions.
- Any plumbing work required to install this appliance should be carried out by a qualified plumber or competent person.
- Any electrical work required to install this appliance should be carried out by a qualified electrician or competent person.
- Care must be taken to ensure that the appliance does not stand on the electrical supply cable.
- If the machine is situated on a carpeted floor, please adjust the feet in order to allow air to circulate freely.

Child Safety

- This appliance is designed to be operated by adults. Children should not be allowed to tamper with the controls or play with the appliance.
- Pets and children have been known to climb into washing machines. Please check your drum before use.
- Keep all packaging well away from children.
- Keep all detergents in a safe place out of children's reach.

Use

- Always unplug the appliance and turn off the water supply after use.
- Do not overload the appliance. See relevant section in the instruction book.
- Only wash fabrics which are designed to be machine washed. If in doubt, consult the care label on the clothes.
- Before washing, ensure that all pockets are empty and buttons and zips are fastened. Avoid washing frayed or torn articles and treat stains such as paint, ink, rust, and grass before washing. Underwired bras must **NOT** be machine washed.
- Any objects such as coins, safety pins, nails, screws, stones or any other hard, sharp material can cause extensive damage and must not be placed into the machine.
- Garments which have been in contact with volatile petroleum products should not be machine washed. If volatile cleaning fluids are used, care should be taken to ensure that the fluid is removed from the garment before placing in the machine.
- Wash small items such as socks, laces, washable belts etc in a washing bag or pillow case as it is possible for such items to slip down between the tub and the inner drum.
- Only use the advised quantities of fabric softener. Damage to the fabric can ensue if you over-fill. Refer to the manufacturer's recommendations of quantities.
- As some duvets and eiderdowns should be washed in large commercial machines because of their bulk, please check with the manufacturer of the item before washing in a domestic machine.
- Under no circumstances should you attempt to repair the machine yourself. Repairs carried out by inexperienced persons may cause injury or serious malfunctioning. Contact your local Zanussi Service Force Centre. Always insist on genuine Zanussi spare parts.

Your New Washing Machine



Your new washing machine meets all modern requirements for effective treatment of laundry with low water, energy and detergent consumption.

Ecological hints

To save water and energy and help protect the environment, we recommend that you follow these hints:

- Adjust the quantity of detergent according to the hardness of your water supply, the amount of laundry and the degree of soiling.
- A programme without prewash is sufficient for normally soiled laundry.

In the interest of the environment

- Materials marked with the symbol  are recyclable.
- Check with your local Council or Environmental Health Office to see if there are facilities in your area for re-cycling this appliance.
- When the appliance is to be scrapped, cut off the power supply cable and make the door lock device unusable to prevent young children from being trapped inside.
- Help to keep your country tidy - use authorised disposal sites for your old appliance.
- The symbol  on the product or on its packaging indicates that this product may not be treated as household waste. Instead it shall be handed over to the applicable collection point for the recycling of electrical and electronic equipment. By ensuring this product is disposed of correctly, you will help prevent potential negative consequences for the environment and human health, which could otherwise be caused by inappropriate waste handling of this product. For more detailed information about recycling of this product, please contact your local city office, your household waste disposal service or the shop where you purchased the product.

**How do we help to protect the environment?
We use recycled paper!**



Important

Your machine is fitted with a balance control device, which ensures the machine is stable during the spin. If the wash load appears not to have been spun sufficiently at the end of the wash cycle, because, it is not evenly distributed in the drum, the balance control device may have operated. It will therefore be necessary to redistribute the wash load manually and select a spin programme. For more detailed information see the section headed "Something Not Working".

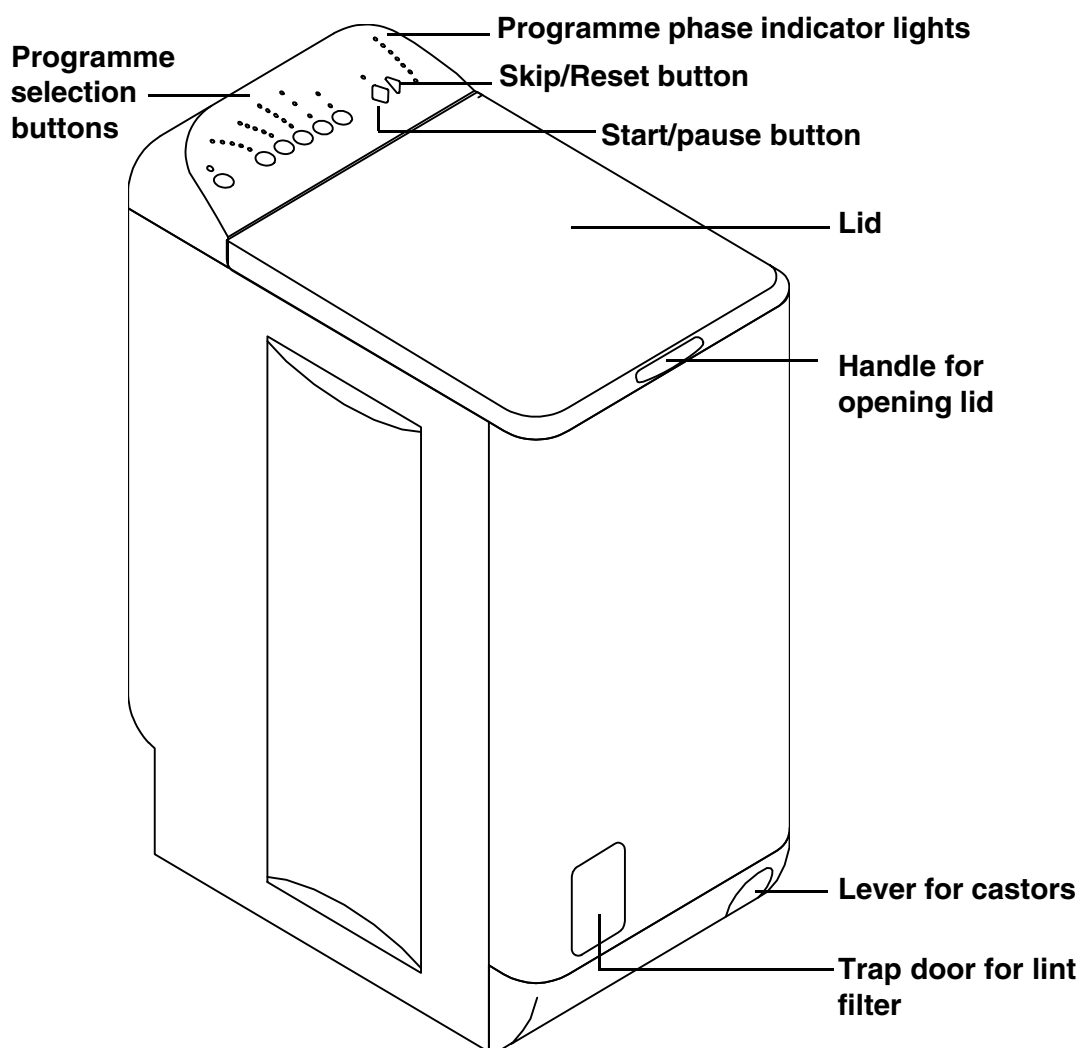
Description of the Appliance



Detergent Dispenser

- 1 Detergent compartment for pre-wash 
- 2 Detergent compartment for main wash 
- 3 Fabric softener 
- 4 Softener overflow

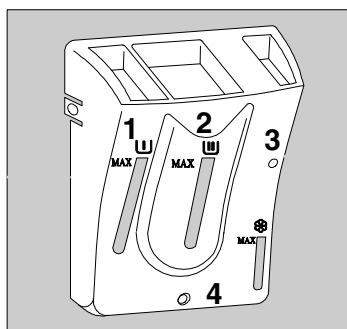

The Control Panel

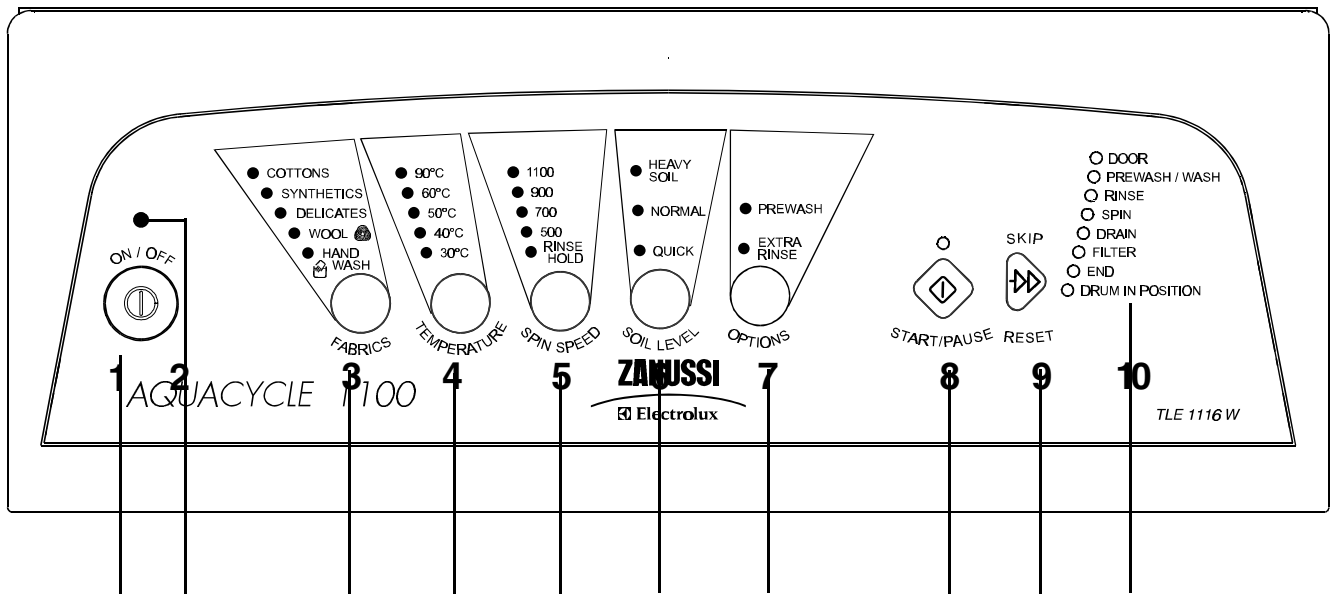

1 ON/OFF button

Press this button to switch the washing machine on.

Press the ON/OFF button again to switch the machine off.

2 MAINS-ON light

This light is connected to the ON/OFF button. It lights up when you press the button, and goes out when you press it again.

3 FABRICS button

Press this button repeatedly to select the programme on the basis of the type of laundry to be washed. The light relevant to the selected programme will illuminate. The washing machine will propose a temperature and automatically select the maximum spin value provided for the programme you have chosen. You can change these values by operating buttons 4 and 5.

You can only select temperatures and spin speeds that are appropriate for the fabric selected.

Hand wash

When you select this programme, you obtain a particularly delicate washing, suitable for articles of clothing whose label indicates that they must be hand-washed .

4 TEMPERATURE button

Press this button repeatedly to increase or decrease the temperature, if you want your laundry to be washed at a temperature different from the one proposed by the washing machine. The relevant light will illuminate.

Maximum temperatures are

- 90°C for cotton,
- 60°C for synthetic fabrics,
- 40°C for delicate fabrics, wool and fabrics to be hand-wash (HAND WASH programme).

5 SPIN SPEED button

Press this button repeatedly to change the spin speed, if you want your laundry to be spun at a speed different from the one proposed by the washing machine. The relevant light will illuminate.

Maximum speeds are

- for cotton: 1100 rpm;
- for synthetic fabrics, wool and fabrics to be hand-wash: 900 rpm;
- for delicate fabrics: 700 rpm.

RINSE HOLD position: when you choose this option, the machine will not drain the water of the last rinse which could crease the laundry.

At the end of the cycle, the light "END" will light to indicate that the water must be drained. To complete the cycle, choose one of the following options:

- **Draining and spin:**
 - Choose a type of laundry with the FABRICS button and then press the SKIP/RESET button once, so as to cause the SPIN light to illuminate (you can also choose the spinning speed by means of button 5), then press the START/PAUSE button.
- **Drain only:**
 - Choose a type of laundry with the FABRICS button and then press the SKIP/RESET button once, so as to cause the DRAIN light to illuminate, then press the START/PAUSE button.

6 SOIL LEVEL button

NORMAL

When selecting a programme, the normal option is proposed by the appliance.

However, by pressing the SOIL LEVEL button repeatedly, the soil level can be changed (levels depend on the soiling of the laundry).

HEAVY SOIL

Suitable for very soiled laundry (only for cotton and synthetic fabrics).

By selecting this option, the washing time is increased by **10 minutes**.

QUICK

Suitable for lightly soiled clothes.

This function cannot be used on the wool and hand-wash programmes.

The washing time is reduced on the basis of the type of FABRICS and TEMPERATURE which have been selected.

7 OPTIONS button

Press this button to select the following options:

PREWASH: select this option if you wish your laundry to be prewashed before the main wash (not available for wool and hand-wash cycle).

The prewash ends with a short spin at 650 rpm in programmes for cotton and synthetics fabrics, whereas in the programme for delicate fabrics the water is only drained.

EXTRA RINSE: this option can be selected with all programmes except the wool programme and

hand-wash. The machine performs 4 rinses instead of 3.

8 START/PAUSE button

This button has two functions:

- **Start:** after you have selected the desired programme and options, press this button to start the washing machine. The light above the button will stop flashing and remain lit.
- **Pause:** when you press this button again, the programme in progress is interrupted. The light above the button will start flashing. To restart the programme, press the button again.

When you PAUSE the cycle, the DOOR light goes out, and it becomes possible to open the lid, provided

- the washing machine is not on the heating phase;
- the level of the water is not high;
- the drum is not turning.

Important!

You must set the washing machine to PAUSE before you make any change in the programme in progress.

9 SKIP/RESET button

This button performs two functions:

- Clears the memory.
- Selects special programmes.

At the end of every programme the RESET button must be pressed at least once to clear the programme memory.

Selecting a special programme:

A wash programme must be selected in the normal way (START button not pressed).

A normal wash cycle consists of the following phases **WASH - RINSE - SPIN** and is confirmed by the illumination of the corresponding LED's.

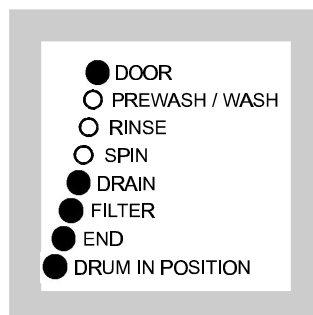

To select **RINSE** and **SPIN**, press the SKIP button once, the **WASH** LED goes out.

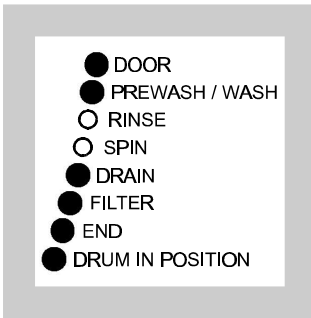

After you have started the programme, only the light relevant to the phase that is currently being carried out will remain lit.

To select **SPIN** only, press the SKIP button twice. The **WASH** and **RINSE** LED's go out.

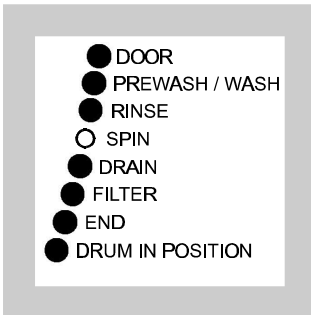

To select **DRAIN**, press the SKIP button three times, the **WASH - RINSE - SPIN** LED's go out.

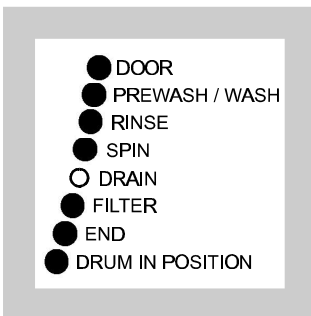

If you wish to cancel or advance the running programme to the required phase, **PAUSE** the cycle and then press the SKIP button as previously described.

10 Programme phase indicator lights

When you select a programme, the lights relevant to the phases that form the programme light up.

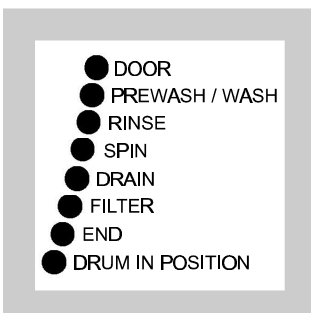

Operating Sequence

Before use

Before using your appliance for the first time, we recommend you to run a 90°C cotton cycle without any laundry, to remove any manufacture residue from the drum and tub:

- Pour 1/2 a measure of detergent into the "detergent dispenser" and start the machine.
- Select the "90°C cottons" programme.
- Press the START/PAUSE button: the wash cycle starts.

1 Load the laundry

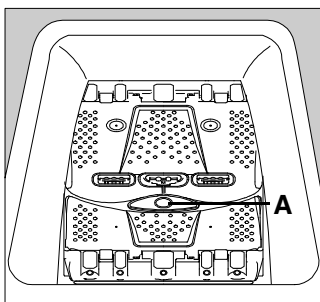

- Lift the lid.
- Open the drum by pressing the release button (A). The 2 flaps will open automatically.
- Shake the laundry out loosely and place into the drum. Close the drum and shut the lid.

Warning: before closing the lid of your appliance, ensure that the drum door is properly closed:

- The two flaps are fastened.
- Button A is released (in the raised position).

An electronic system allows the drum to be in the high position when the cycle is finished. This system allows for easier loading and unloading of the laundry. If an unbalanced weight alters the functioning, turn the drum by hand.

2 Measure out the detergent

Measure out the amount of detergent recommended by the manufacturer in the main wash compartment [1].

If you are carrying out a pre-wash, pour the detergent into the pre-wash compartment [1].

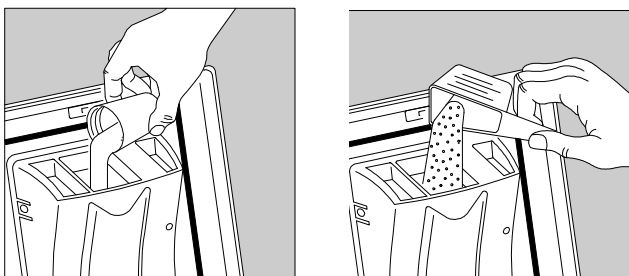

DO NOT exceed the maximum level.

3 Add fabric softener

If required, pour fabric softener into the compartment marked ⊗, without exceeding the maximum level.

4 Switch the machine on

Press the ON/OFF button to switch the machine on. The light above the button will light up.

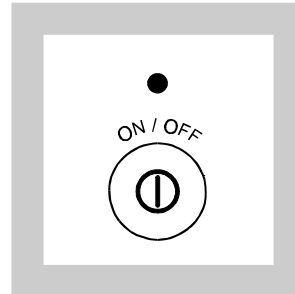

5 Select the desired programme/fabric

Press the FABRICS button repeatedly in order to select the desired programme/fabric. The relevant light will light up.

The lights relevant to the phases which form the programme will light up.

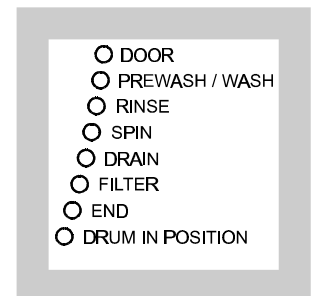
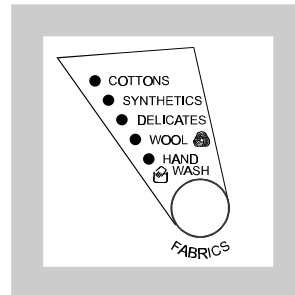

6 Select the temperature

Press the TEMPERATURE button if you wish to select a temperature value different from the one proposed by the washing machine.

The relevant light will illuminate.

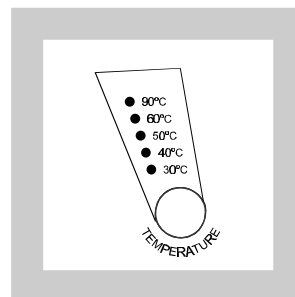

7 Select the spin speed and the RINSE HOLD option

Press the SPIN SPEED button repeatedly in order to select the desired spin speed or the RINSE HOLD option. The relevant light will illuminate.

If you select the RINSE HOLD option, the machine will stop at the end of the programme with the water still in the tub.

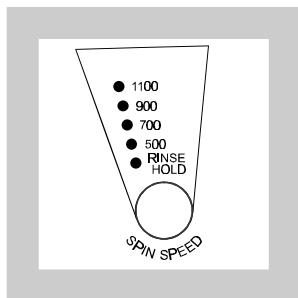

8 Select the SOIL LEVEL

Press the SOIL LEVEL button if you wish to select an option different from the one proposed by the appliance (NORMAL). You can choose between HEAVY SOIL or QUICK on the basis of the soiling of the laundry level.

The relevant light will illuminate.

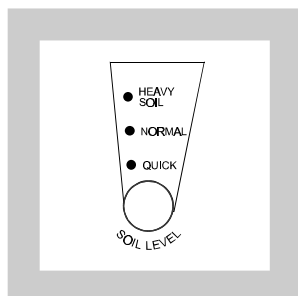

9 Select the desired options

If your laundry is very dirty, it may be advisable to select the PREWASH option.

If you wish the laundry to undergo an extra rinse, select the SUPER RINSE option.

Press the OPTIONS button so as to cause one or both of the lights to illuminate.

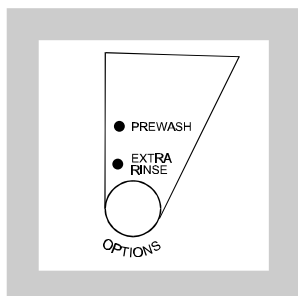

10 Start the programme

Press the START/PAUSE button. The relevant light will stop flashing, the DOOR light will illuminate, and only the light relevant to the phase that is in progress will remain lit.

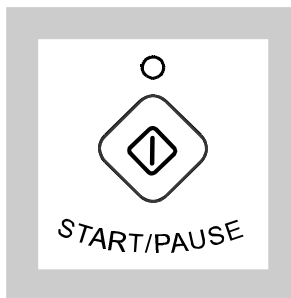

11 How to change a programme during a cycle

Before you make any change, you must pause the washing machine by pressing the START/PAUSE button.

It is possible to change any phase before the programme carries out.

Changing the type of fabric or temperature is possible, obviously, only during the washing phase. When you make a change to the fabric or temperature, the washing machine will resume the cycle from the beginning.

If it is necessary to drain the water in order to change the programme in progress, proceed as follows:

- pause the machine by pressing the START/PAUSE button;
- press the SKIP/RESET button repeatedly, until only the DRAIN light remains lit;
- press the START/PAUSE button again.

You may now select a new programme and press the START/PAUSE button to start it.

12 How to cancel a programme during a cycle

To cancel a programme that is being carried out, press the ON/OFF button to switch the machine off. The light above the button will go out. If it is necessary, carry out a rinse, a spin or a drain.

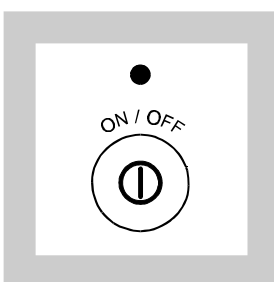

13 How to open the lid during the cycle of the programme

You can open the lid after you have pressed PAUSE, provided the following conditions exist:

- the appliance is not in the heating phase,
- the level of the water is not high,
- the drum is not turning.

If these requirements are met when you pause the washing machine, the DOOR light goes out and the lid can be opened.

Should it not be possible to open the lid, and should it be absolutely necessary to do so, switch the appliance off by pressing the ON/OFF button.

After approximately 2 minutes, you can open the lid.

Pay attention to the level and temperature of the water in the washing machine!

When you close the lid and press the ON/OFF button again, the washing machine will resume the programme from the point where it had been interrupted.

14 End of programme

At the end of the programme, the washing machine stops automatically and gives an audible signal (which can be deactivated, see page 7).

If you had selected the RINSE HOLD option, the END button is lit to indicate that the water must be drained (page 8).

The DOOR light goes out at once.

Note:

When you switch the machine on, if you need to erase the previously performed programme, it is also sufficient to press the FABRICS button and select a new programme.

Press the ON/OFF button to switch the machine off. The relevant light will go out.

Remove the laundry from the washing machine.

Check whether the drum is completely empty, by rotating it with your hand. The purpose of this is to prevent any items of laundry from remaining accidentally in the drum, where they might get damaged in a subsequent wash (e.g. by shrinking) or bleed colour into another load of laundry.

We advise you to close the water supply tap and disconnect the plug from the socket.

Leave the lid open in order to air the washing machine.

Washing Hints

Do **NOT** overload the machine. Weigh the laundry the first few times you use the appliance.

The average weights of the most common items are listed below as a guide:

1000g=1kg

Sheet	700-1000 g
Pillow case	100-200 g
Tablecloth	400-500 g
Serviette	50-100 g
Tea towel	70-120 g
Linen hand towel	100-150 g
Towelling hand towel	150-250 g
Towelling bath towel	700-1000g
Bath robe	1000-1500 g
Man's shirt	200-300 g
Apron	150-200 g

For Best Washing Results:

- Load the laundry loosely alternating large items with small ones.
- Sort the laundry according to the type of fabric, colour fastness and degree of soilage.
- White items should not be washed with coloured items.
- Wash new coloured items separately when washing for the first time.
- Treat stains such as paint, ink, rust and grass before washing.
- Avoid washing frayed or torn articles.
- When washing fabrics requiring different wash temperatures, always select the lowest temperature.

Always:

- Empty pockets.
- Ensure buttons and zips are fastened.
- Consult the care label on the garment. Only wash fabrics which are designed to be machine washed.
- Place small items such as socks, laces, handkerchiefs etc in a washing bag or pillow case, as it is possible for such items to slip down between the tub and the inner drum.

Items that should not be put in the machine:

- Underwired bras.
- Garments which have been in contact with volatile or petroleum based products.
- Some duvets and eiderdowns should be washed in large commercial machines. Check with the manufacturer of the item.

Help the Environment:

To save water, energy and help protect the environment.

- Do not use a pre-wash for normally soiled washing.
- Wash full loads.
- Pre-treat stains and then wash at a lower temperature.
- Only use the advised quantities of detergent and fabric softener.

Which detergent? ...

To ensure you obtain the best wash results from your appliance, it is important to use the right detergent in your everyday wash, and only detergents recommended for use in automatic machines.

To maintain the appearance of your clothes and household textiles and to make them last longer you should use different types of detergent for different washes, whether for whites, colours or delicates.

Whites

We recommend the Ariel product range which is biological and designed to provide excellent cleaning and stain removal even at low temperatures.



Non Biological

If you prefer to use a non biological detergent, which does not contain enzymes we recommend Fairy. Fairy provides good cleaning and stain removal.



Coloureds

For coloured items you should use a detergent which is designed to clean while maintaining the original colour. Ariel Color does not contain bleach and therefore helps to preserve colours.



Delicate items

When washing delicates such as woollens, you should use a product which is specially designed to care for fine fabrics. Dreft Automatic is suitable for woollens and other delicates.



Laundry Bleach

For additional stain removal you may wish to use a product such as Ace Gentle Bleach which is used in addition to your chosen detergent. Ace is suitable for all washable fabrics including silks, woollens and coloureds.



And in which form?

Not only are there different types of detergent, but they are also available in different forms. Whether you choose a powder or liquid in traditional or compact form is down to personal choice.

Traditional Powders

Pour the powder directly into the dispenser drawer. Do not sprinkle powder onto clothes in the machine drum.

Traditional Liquids

Liquid can be placed in the main wash compartment of the detergent drawer marked with the symbol , start the machine immediately upon placing the detergent in the dispenser drawer. Alternatively the detergent is measured into the specially designed dosing device* which should be placed on top of the laundry, and at the back of the machine drum.

Compact Powders and Liquids

Compact detergents (or concentrates as they are also known) are available in liquid or powder form, and generally require a smaller dosage. Follow the manufacturer's instructions to ensure the most economical usage. Pour the detergent directly into the dispenser drawer, or alternatively measure the detergent into the specially designed dosing device* which should be placed on top of the laundry, and at the back of the machine drum.

** if you use a dosing device in a washer dryer, please ensure the dosing device/ball is removed before carrying out a drying programme.*

Fabric Conditioners

These are ideal for improving "softness", and also reduce static cling on synthetics and make ironing easier. They are available in two types.

For example Lenor liquid fabric softener, for use in the **washing machine/washer dryer**. The liquid fabric softener should be poured into the compartment marked with the symbol . Follow the manufacturer's dosage instructions and never exceed the MAX level.



















Bounce conditioning sheets for use in a **tumble dryer**. We recommend the conditioning sheets are pinned (using a safety pin) to an article of laundry and placed in the tumble dryer.







Wash Care Symbols

Wash care labels inside garments recommend how to launder your clothes with the best results. The care labelling code is in line with care labelling used in the rest of Europe. The symbols used make it easy to select the correct programme on your washing machine

WASHING SYMBOL	WASH ACTION	FABRIC
	Normal (Maximum)	White Cotton or Linen without Special Finishes
	Normal (Maximum)	Cotton, Linen or Viscose without Special Finishes, Colourfast at 60°C
	Reduced (Medium)	Nylon, Polyester/Cotton, Viscose with Special Finishes, Cotton/Acrylic Mix
	Normal (Maximum)	Cotton, Linen or Viscose, Colourfast at 40°C but not 60°C
	Reduced (Medium)	Acrylics, Acetate, Triacetate, Wool mixes, Polyester/wool
	Much Reduced (Minimum)	Wool, wool mixtures, Silks
	Hand wash only	Do not machine wash
BLEACHING		
	Chlorine bleach may be used	
IRONING		
	Hot Iron	Cotton, Linen, Viscose
	Warm Iron	Polyester mixtures, Wool
	Cool Iron	Acrylic, Nylon, Polyester
DRY CLEANING		
	May be dry cleaned. Other letters and/or a bar beneath the circle will indicate the required process to the dry cleaner.	
TUMBLE DRYING		
	May be tumble dried	
	With high heat setting	
	With low heat setting	
	A cross through any symbol means "DO NOT"	

Washing Programmes

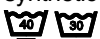
Programmes

Programme Temperature	Type of laundry and symbols on labels	Description of the programme	Available options	Load	Indicative consumptions (*)		
					Energy kWh	Water litres	Time min.
Cottons 60°- 90°	White cotton: e.g. sheets, tableclothes, household linen 	Main wash at 60°- 90°C 3 rinses Long spin	SPIN SPEED RINSE HOLD HEAVY SOIL QUICK PREWASH EXTRA RINSE	4,5 kg	2,00	59	140 - 155
Cottons (●) 30°- 60°	Coloured cotton: e.g. shirts, blouses, underwear, towels, household linen 	Main wash at 30°- 60°C 3 rinses Long spin	SPIN SPEED RINSE HOLD HEAVY SOIL QUICK PREWASH EXTRA RINSE	4,5 kg	1,03	54	140 - 155
Synthetics 30°- 60°	Synthetics fabrics and blends: e.g. shirts, blouses, underwear 	Main wash at 30°- 60°C 3 rinses Short spin	SPIN SPEED RINSE HOLD HEAVY SOIL QUICK PREWASH EXTRA RINSE	2,0 kg	1,10	52	85 - 100
Delicates 40°- 30°	Delicate fabrics: e.g. acrylic fabrics, viscose, polyester, synthetic blends 	Main wash at 40°- 30°C 3 rinses Short spin	SPIN SPEED RINSE HOLD QUICK PREWASH EXTRA RINSE	2,0 kg	0,55	53	65 - 80
Wool 40°- 30°	Wool 	Main wash at 40°- 30°C 3 rinses Short spin	SPIN SPEED RINSE HOLD	1,0 kg	0,40	50	50 - 65
Hand wash 40°- 30°		Main wash at 40°- 30°C 3 rinses Short spin	SPIN SPEED RINSE HOLD	2,0 kg	0,40	50	50 - 65

(●) This programme at 60°C is the reference programme for the Energy label according to EEC Directive 92/75.

(*) The data is given purely as an indication: the consumption values may vary in relation to the quantity and type of laundry, the temperature of the water supply and the ambient temperature. The data refers to the highest temperature provided for each programme.

Washing Programmes

Special programmes

Programme Temperature	Type of laundry	Description of the programme	Available options	Load	Indicative consumptions (*)		
					Energy kWh	Water litres	Time min.
Rinse	Separate rinse cycle for hand washed garments	3 rinses	SPIN SPEED EXTRA RINSE	4,5 kg	0,15	45	40 - 55
Spin	Separate spin for hand washed garments	Spin	SPIN SPEED	-	0,05	-	5 - 20
Drain		For emptying out the last rinse water in programme with the RINSE HOLD option.		-	0,01	-	0 - 15

(*) The data is given purely as an indication: the consumption values may vary in relation to the quantity and type of laundry, the temperature of the water supply and the ambient temperature. The data refers to the highest temperature provided for each programme.

Maintenance and Cleaning

Before carrying out any maintenance or cleaning you must DISCONNECT the appliance from the electricity supply.

Descaling

The water we normally use contains lime. To help prevent the formation of lime deposits we recommend you periodically, particularly in hard water areas, use a water softening powder in the machine. Do this separately from any laundry and according to the manufacturer's instructions.

After each wash

Leave the lid and the drum open for a while. This helps to prevent mould and stagnant smells forming inside the appliance.

External Cleaning

Wipe the exterior cabinet of the appliance with a soft cloth and warm soapy water. Do not use abrasive cleaning products.

Cleaning the detergent dispenser

The detergent dispenser is very easy to remove. Press the pressure tabs located on each side of the detergent dispenser inwards and pull it up (fig.1 and fig.2).

Clean the detergent dispenser under running water with a brush or cloth (fig.3). Check that the syphons located at the back of the detergent dispenser are not obstructed (fig.4).

Replace the detergent dispenser in the notches until it hangs securely in place (fig.5).

Cleaning the drain filter

A clean filter is important for correct functioning of the machine, and should therefore be cleaned after every wash.

However, if the drain filter is dirty, the FILTER indicator light illuminates. In this case, clean the filter at once.

■ Carefully open the door, with a screwdriver for example (fig.6 and fig.7) :

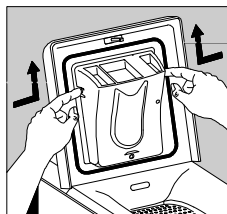

fig.1

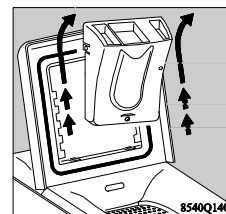

fig.2

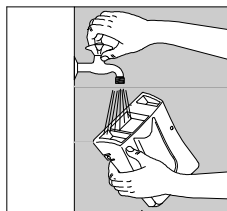

fig.3

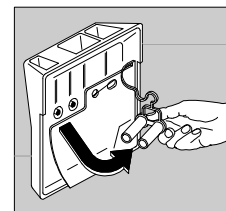

fig.4

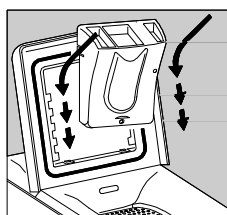

fig.5

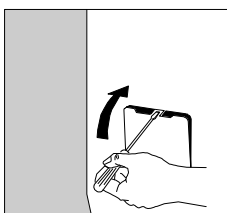

fig.6

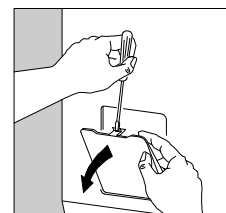

fig.7

- To drain the residual water :
Place a shallow container beneath the trap door. Turn the filter handle anticlockwise until the filter cap handle is vertical, any residual water will be released (fig.8).
- To clean the filter :
Unscrew the filter anticlockwise and remove (fig.9).
Clean the filter carefully under a fast running tap.
Replace the filter and refit by screwing in a clockwise direction. Close the trap door.

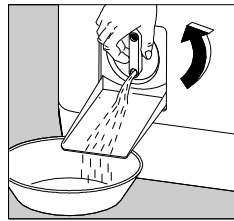

fig.8

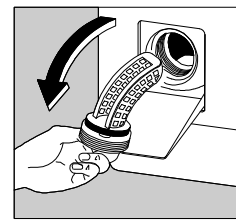



fig.9

 Never remove the water drain filter during a wash cycle.

Maintenance Wash

With the use of low temperature washes it is possible to get a build up of residues inside the drum.

We recommend that a maintenance wash be performed on a regular basis.

To run a maintenance wash:

- The drum should be empty of laundry.
- Select the hottest cotton wash programme.
- Use a normal measure of detergent, must be a powder (such a Ariel Futur).

The dangers of freezing

If the machine is exposed to temperatures below 0°C, certain precautions should be taken.

- Turn off both the water tap.
- Unscrew the inlet hose.
- Unhook the drain hose from the rear support and position the end in a bowl. Run the draining programme.
To do this:
 - Switch the machine on.
 - Select a washing programme.
 - Press the SKIP/RESET button three times.
 - Press START/PAUSE button.
- Disconnect the appliance.
- Screw the inlet hose and reposition the drain hose.
- When you intend to start the machine again, make sure that the room temperature is above 0°C.

Something Not Working

Certain problems are due to lack of simple maintenance or oversights, which can be solved easily without calling out an engineer. Before contacting your local Service Force Centre, please carry out the checks listed below.

IMPORTANT: if you call out an engineer to a fault listed below, or to repair a fault caused by incorrect use or installation, a charge will be made even if the appliance is under guarantee.

During machine operation, it is possible that one of the following alarm codes and an audible signal appear:

- The light END flashes once : filling problem,
- The light END flashes twice: draining problem,
- The light END flashes four times : lid opened.
- The light END flashes ten times : flaps of the drum door opened

SYMPTOM	POSSIBLE CAUSE	SOLUTION
The machine does not start up.	The ON/OFF or START/PAUSE buttons have not been pressed.	Press the ON/OFF or START/PAUSE buttons.
	The lid is not properly closed.	Close the lid.
	The appliance is not plugged in.	Plug in the appliance.
	There is no electricity supply from the wall socket.	Check the fuse.
	The main fuse or the fuse in the plug has blown.	Change the fuse.
The machine does not fill.	The water is not turned on.	Turn on the water.
	The water supply has been cut off.	Wait until the water supply is restored.
	The inlet hose is kinked.	Straighten the inlet hose.
	The water pressure is too low.	Consult a qualified plumber.
	The water inlet filter is clogged.	Clean the filter.
The machine empties as it fills.	The end of the drain hose is too low.	Position the drain hose at the correct height (between 70 and 100 cm).
	The end of the drain hose is submerged in water.	Re-position the drain hose so it is not submerged.
	There is no vent in the end of the drain hose.	Replace the drain hose.
The machine does not drain or spin	The Rinse Hold option has been selected.	Select the SPIN or DRAIN option.
	The drain filter is clogged.	Clean the filter.
	The drain hose is bent.	Straighten the hose.
	The drainage system pipes are blocked.	Consult a plumber.
	The drain hose extension is incorrect.	Consult a plumber.
	The wash load is unbalanced.	Reload the washing and select a SPIN SPEED.
The machine leaks or overfills.	Too much detergent.	Reduce the quantity of detergent.
	Unsuitable detergent.	Use only detergent for automatic washing machines.
	The detergent dispenser is blocked.	Clean the dispenser.
	The end of the drain hose is not correctly positioned.	Re-position the drain hose.

SYMPTOM	POSSIBLE CAUSE	SOLUTION
The machine vibrates or is noisy.	The internal packing and/or transit bolts have not been removed.	Remove internal packing/transit bolts.
	The wash load is unevenly distributed.	See hints and tips section.
	The machine is overloaded.	Observe the maximum loads quoted for the programme.
The lid does not open.	The safety device has locked it.	Wait 2 minutes until the relevant light has gone out.
Unsatisfactory washing results.	Too little detergent or unsuitable detergent has been used.	Use the right detergent and the right quantity.
	Stubborn stains have not been treated prior to washing.	Treat the stains before washing.
	The correct washing programme/temperature has not been selected.	Select the correct washing programme/temperature (see WASHING PROGRAMMES)
	Too much laundry has been placed in the drum.	Observe the maximum loads quoted for the programme.
Spinning starts are late or the machine does not spin.	The electronic unbalance detection device has cut in because the laundry is not evenly distributed in the drum. This may happen several times before the unbalance disappears and a normal spinning can resume.	If, after 15 minutes, the laundry is still not evenly distributed in the drum, the machine will not spin. In this case, redistribute the load manually and select the spin programme.

Service and Spare Parts



In the event of your appliance requiring service, or if you wish to purchase spare parts, please contact your local Service Force Centre by telephoning:

08705 929929

Your telephone call will be automatically routed to the Service Force Centre covering your post code area.

For the address of your local Service Force Centre and further information about Service Force, please visit the website at www.serviceforce.co.uk.

For Customer Service in Ireland please contact us at the address below:

Zanussi-Electrolux
Electrolux Group (Irl) Ltd
Long Mile Road
Dublin 12
Republic of Ireland
Tel: + 353 1 4090751
Email: service.eid@electrolux.ie

Before calling out an engineer, please ensure you have read the details under the heading "Something Not Working."

When you contact the Service Force Centre you will need to give the following details:

1. Your name, address and post code
2. Your telephone number
3. Clear and concise details of the fault
4. The model and serial number of the appliance (found on the rating plate).
5. The purchase date.

Please note that a valid purchase receipt or guarantee documentation is required for in-guarantee service calls.

Customer Care Department

For general enquiries concerning your Zanussi-Electrolux appliance or for further information on Zanussi-Electrolux products, please contact our Customer Care Department by letter or telephone at the address below or visit our website at www.zanussi-electrolux.co.uk

Customer Care Department
Zanussi-Electrolux
55-77 High Street
Slough
Berkshire
SL1 1DZ
Tel 08705 727727 (*)

(*) calls to this number may be recorded for training purposes.

Guarantee Conditions

Standard guarantee conditions

We, Zanussi-Electrolux, undertake that if within 12 months of the date of the purchase this ZANUSSI-ELECTROLUX appliance or any part thereof is proved to be defective by reason only of faulty workmanship or materials, we will, at our option, repair or replace the same FREE OF ANY CHARGE for labour, materials or carriage on condition that:

- The appliance has been correctly installed and used only on the electricity supply stated on the rating plate
- The appliance has been used for normal domestic purposes only, and in accordance with the manufacturer's instructions
- The appliance has not been serviced, maintained repaired, taken apart or tampered with by any person not authorised by us

All service work under this guarantee must be undertaken by a Service Force Centre.

Any appliance or defective part replaced shall come the Company's property.

This guarantee is in addition to your statutory and other legal rights.

Home visits are made between **8.30 am** and **5.30 pm** Monday to Friday. Visits may be available outside these hours in which case a **premium** will be charged.

Exclusions

This guarantee does not cover:

- Damage or calls resulting from transportation, improper use or neglect, the replacement of any light bulbs or removable parts of glass or plastic.
- Costs incurred for calls to put right an appliance which is improperly installed or calls to appliances outside the United Kingdom.
- Appliances found to be in use within a commercial environment, plus those which are subject to rental agreements.
- Products of Zanussi-Electrolux manufacture which are not marketed by Zanussi-Electrolux.

European Guarantee

If you should move to another country within Europe then your guarantee moves with you to your new home subject to the following qualifications:

- The guarantee starts from the date you first purchased your product
- The guarantee is for the same period and to the same extent for labour and parts as exists in the new country of use for this brand or range of products
- This guarantee relates to you and cannot be transferred to another user
- Your new home is within the European Community (EC) or European Free Trade Area
- The product is installed and used in accordance with our instructions and is only used domestically, i.e. a normal household
- The product is installed taking into account regulations in your new country

Before you move please contact your nearest Customer Care centre, listed below, to give them details of your new home. They will then ensure that the local Service Organisation is aware of your move and able to look after you and your appliances.

France	Senlis	+33 (0) 344 62 29 29
Germany	Nuremberg	+49 (0) 800 234 7378
Italy	Pordenone	+39 (0) 0434 39 4700
Sweden	Stockholm	+46 (0) 8 672 53 90
UK	Slough	+44 (0) 1753 219897
Ireland	Dublin	+353 (0) 1 4090751

Installation Instructions

 It is dangerous to alter the specifications or attempt to modify this product in any way.

 Care must be taken to ensure that the appliance does not stand on the electrical supply cable.

 Any electrical work required to install this appliance should be carried out by a qualified electrician or competent person.

 Any plumbing work required to install this appliance should be carried out by a qualified plumber or competent person.

Technical Specifications

Dimensions	Height with panel Height without panel Width Depth	895 mm 850 mm 397 mm 600 mm
Power supply voltage / frequency		230 V - 240 V / 50 Hz
Total power absorbed		2300 W / (10 A)
Heater rating		1950 W
Water pressure	minimum maximum	0,05 MPa (0,5 bar) 0,8 MPa (8 bar)
Maximum load	Cotton Synthetics/delicates Wool	4,5 kg 2 kg 1 kg
Maximum spinning speed		1100 rpm
Electrical consumption (washing at 60°C)		1,03 kWh

 This appliance complies with the following EC Directive :
 - 72/23/EEC of 19.02.1973 - Low-Voltage Directive,
 - 89/336/EEC of 03.05.1989 (including Amendment Directive 92/31/EEC) - EMV Directive.

Unpacking

Packing used to protect internal parts of the washing machine during transport must be removed before the washing machine is used for the first time.

- Remove all packing from the washing machine. Tilt the washing machine sideways and then remove the packing under the motor, and straighten the washing machine (fig. 1).
- Tilt the washing machine backwards, rotate it by a quarter of a turn on one of its corners to remove the transport base (fig. 2).
- Open the washing machine lid and remove the transport packing and plastic films. Close the lid (fig. 3).
- Use a 10 mm spanner to remove the two screws and spacers at the back (fig. 4).
- You can now see the openings that must be closed with the plugs in the pack attached to the washing machine; do not forget to fold down the central capsule (fig. 5).
- Make sure that you have removed all these parts from your washing machine and keep them so that you can use them again if you need them for future transport (fig. 6).
- If you want to keep your washing machine aligned with the adjacent furniture, you can cut the pipe support strip at the back of your washing machine. Leave the two rectangular side closers in place (fig. 7).

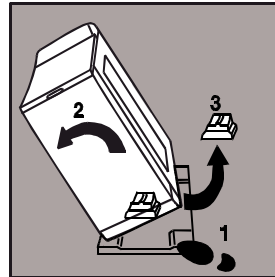

Fig. 1

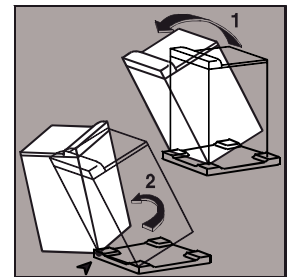

Fig. 2

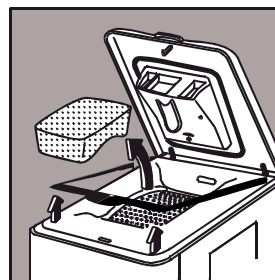

Fig 3

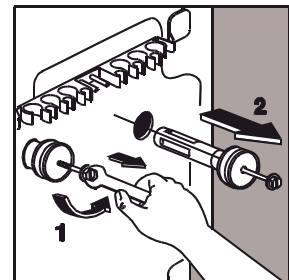

Fig 4

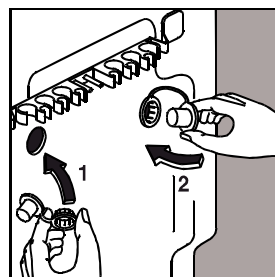

Fig 5

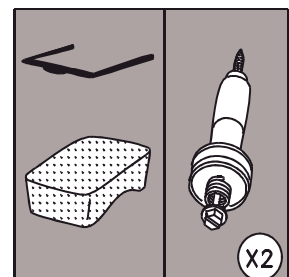

Fig 6

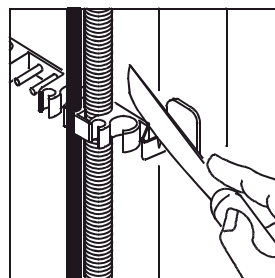

Fig 7

Positioning

- The installation surface must be clean dry and level.
- Do not install on deep pile carpet.
- Do not install the appliance in locations where the temperature may fall below freezing.
- Please ensure that when the appliance is installed it is easily accessible for the engineer in the event of a breakdown.

Levelling the Appliance

- The appliance must be levelled using the adjustable feet.
- Adjust the feet so that the appliance is level. The appliance must not rock when weight is applied.
- Check the appliance is level using a spirit level.

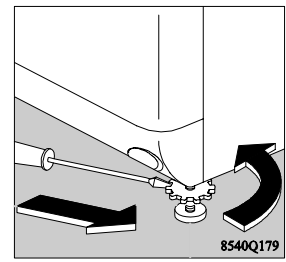
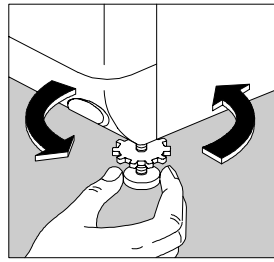

Moving the Appliance

To move the washing machine, release the wheels by pulling the lever at the bottom of the machine. Pull the lever to the right and move the machine to the required position. When the machine has been correctly positioned, push the lever back to its original position.

Do not operate the machine with the wheels released.

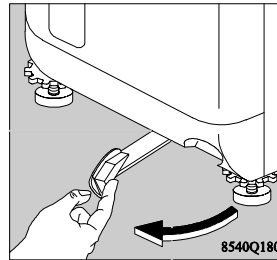

Warning

The machine should NOT be placed on deep pile carpeting.

Note

Please ensure that when the appliance is installed it is easily accessible for the engineer in the event of a breakdown.

Water Connection

This appliance is designed to be permanently plumbed into your home's water supply and drainage system.

Water Inlet

Please install the water inlet hose onto the back of your washing machine :

- Insert the seal in the hole at the bottom of the back panel (fig. 1).
- Screw on the bottom fitting of the water inlet hose as shown in fig. 2 and fig. 3.

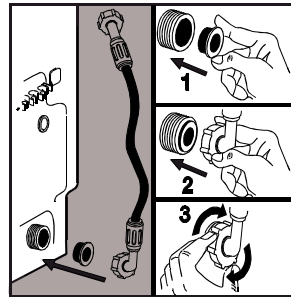

- Connect the feed hose connector onto the water inlet tap, taking care to position the gasket correctly.
- Turn on the water inlet tap.

The water inlet hose cannot be extended. If it is too short, please contact the After Sales Department.

The water inlet hose cannot be extended. If it is too short, please contact the After Sales Department.



Water Drainage

- Assemble the hose holder onto the drain hose.

- Place the assembly in a drainage pipe (or in a sink) at a height between 70 and 100 cm. Make sure that it will not fall out.

You must provide an air intake at the end of the drainage hose, to avoid any water being siphoned.

Important: the drainage hose must not be extended, on any account. If it is too short, contact a qualified engineer.

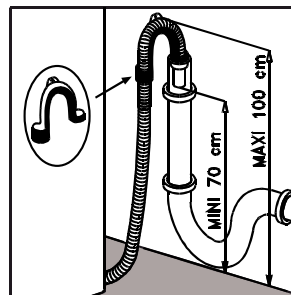

Drainage onto a sink outlet spigot :

If the outlet spigot has not been used before, remove any blanking plug that may be in place.

Push the drain hose onto the spigot and secure with a clip if required, ensure a loop is formed in the drain hose (see diagram) to prevent waste from the sink entering the washing machine.

The drain hose may be extended to a maximum of 4 metres. An additional drain hose and joining piece is available from your local Service Force Centre. The joining piece must have an internal diameter of 18 mm.

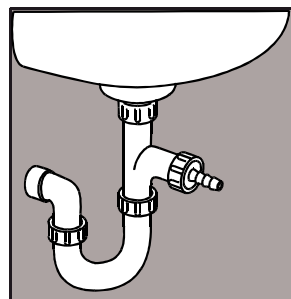

Important

Before connecting up the machine to new pipework or to pipework that has not been used for some time, run off a reasonable amount of water to flush out any debris that may have collected in the pipes.

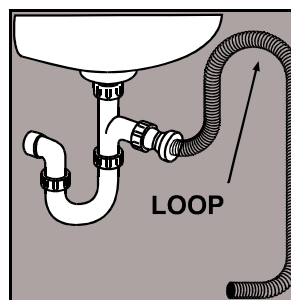

Electrical Connection

Any electrical work required to install this appliance should be carried out by a qualified electrician or competent person.

WARNING: THIS APPLIANCE MUST BE EARTHED.



The manufacturer declines any liability should these safety measures not be observed.

Before switching on, make sure the electricity supply voltage is the same as that indicated on the appliance rating plate. The rating plate is located at the back of the appliance. The appliance is supplied with a 13amp plug supplied, a 13amp ASTA approved (BS1362) fuse must be used.

Should the plug need to be replaced for any reason.

The wires in the mains lead are coloured in accordance with the following code:

Green and Yellow	: Earth
Blue	: Neutral
Brown	: Live

The wire coloured green and yellow must be connected to the terminal marked with the letter "E" or by the earth symbol or coloured green and yellow.

The wire coloured blue must be connected to the terminal "N" or coloured black.

The wire coloured brown must be connected to the terminal marked "L" or coloured red.

Upon completion there must be no cut, or stray strands of wire present and the cord clamp must be secure over the outer sheath.

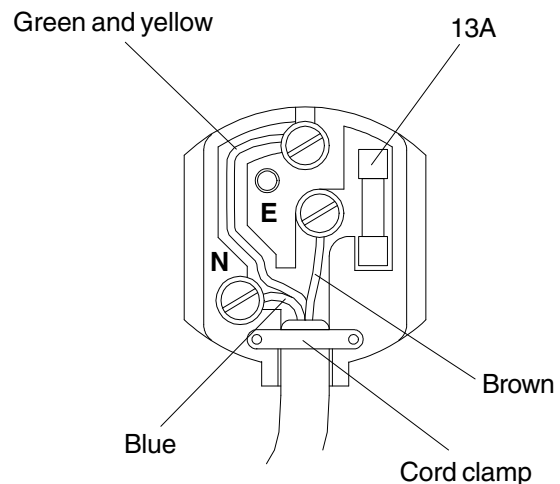

WARNING:



A cut off plug inserted into a 13 amp socket is a serious safety (shock) hazard. Ensure that the cut off plug is disposed of safely.

Permanent connection

In the case of a permanent connection it is necessary that you install a double pole switch between the appliance and the electricity supply (mains), with a minimum gap of 3mm between the switch contacts and of a type suitable for the required load in compliance with the current electrical regulations. The switch must not break the yellow and green earth cable at any point.

 **From the Electrolux Group. The world's No.1 choice.**

The Electrolux Group is the world's largest producer of powered appliances for kitchen, cleaning and outdoor use. More than 55 million Electrolux Group products (such as refrigerators, cookers, washing machines, vacuum cleaners, chain saws and lawn mowers) are sold each year to a value of approx. USD 14 billion in more than 150 countries around the world.