

**User
Manual**

**Washing
Machine**

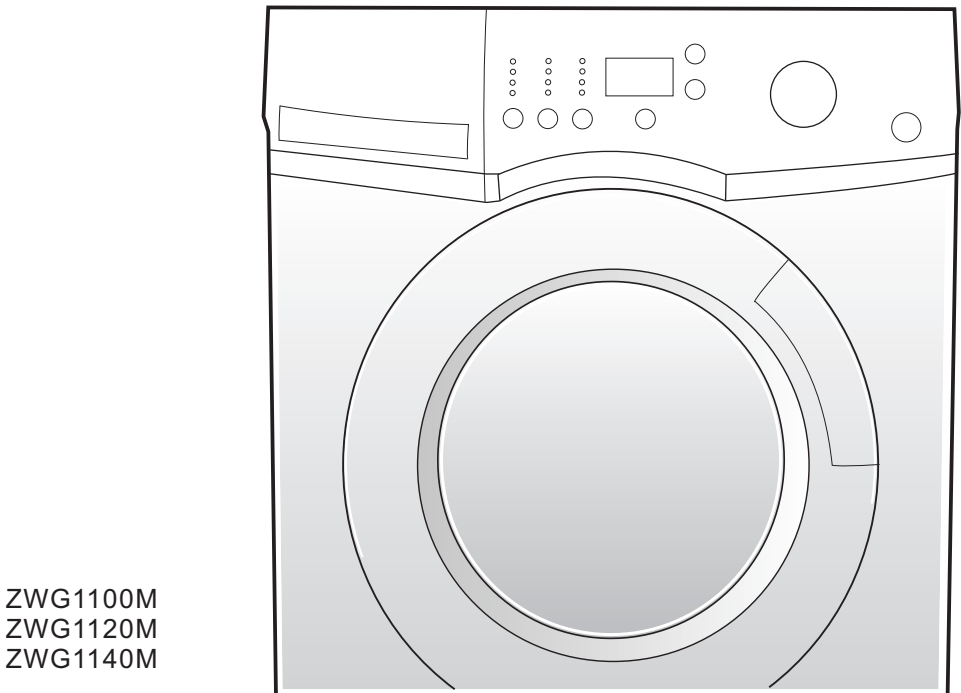

ZWG1100M
ZWG1120M
ZWG1140M

Contents

Safety information _____	2	Care and cleaning _____	13
Product description _____	4	What to do if ... _____	15
Control Panel _____	5	Technical data _____	17
Washing programmes _____	7-8	Installation _____	18
Helpful hints and tips _____	9	Electrical connection _____	19
First use _____	10	Environmental concerns _____	19
Personalisation _____	10		
Daily use _____	11		

Subject to change without notice

Safety information

Important! Read carefully & keep for future reference.

- The safety of your appliance complies with the industry standards and with legal requirements on the safety of appliances. However, as manufacturers, we feel it is our duty to provide the following safety notes.
- It is most important that this instruction book should be retained with the appliance for future reference. Should the appliance be sold or transferred to another owner, or should you move house and leave the appliance, always ensure that the book is supplied with the appliance in order that the new owner can get to know the functioning of the appliance and the relevant warnings.
- You **MUST** read them carefully before installing or using the appliance.
- Before first starting up, check the appliance for any damage incurred during transport. Never connect up a damaged appliance. If parts are damaged, contact your supplier.
- If the appliance is delivered in the winter months when there are minus temperatures, store it at room temperature for 24 hours before using for the first time.

General safety

- It is dangerous to alter the specifications or attempt to modify this product in any way.
- During high temperature wash programmes the doorglass may get hot. Do not touch it!
- Make sure that small children and pets do not climb into the drum. To avoid this, please check into the drum before using.

- Any objects such as coins, safety pins, nails, screws, stones or any other hard, sharp material can cause extensive damage and must not be placed into the machine.
- Only use the advised quantities of fabric softener and detergent. Damage to the fabric can ensue if you over-fill. Refer to the manufacturer's recommendations of quantities.
- Wash small items such as socks, laces, washable belts etc in a washing bag or pillow case as it is possible for such items to slip down between the tub and the inner drum.
- Do not use your washing machine to wash articles with whalebones, material without hems or torn material.
- Always unplug the appliance and turn off the watersupply after use, cleaning and maintenance.
- Under no circumstances should you attempt to repair the machine yourself. Repairs carried out by inexperienced people may cause injury or serious malfunctioning. Contact your local Service Centre. Always insist on genuine spare parts.

Installation

- This appliance is heavy. Care should be taken when moving it.
- When unpacking the appliance, check that it is not damaged. If in doubt, do not use it and contact the Service Centre.

- All packing and transit bolts must be removed before use. Serious damage can occur to the product and to property if this is not adhered to. See relevant section in the user manual.
- After having installed the appliance, check that it is not standing on the inlet and drain hose and the worktop is not pressing the electrical supply cable against the wall.
- If the machine is situated on a carpeted floor, please adjust the feet in order to allow air to circulate freely under the appliance.
- Always be sure, that there is no water leakage from hoses and their connections after the installation.
- If the appliance is installed in a location subject to frost, please read the “dangers of freezing” chapter.
- Any plumbing work required to install this appliance should be carried out by a qualified plumber or competent person.
- Any electrical work required to install this appliance should be carried out by a qualified electrician or competent person.

Use

- This appliance is designed for domestic use. It must not be used for purposes other than those for which it was designed.
 - Only wash fabrics which are designed to be machine washed. Follow the instructions on each garment label.
 - Do not overload the appliance. See the Washing Programme Table.
 - Before washing, ensure that all pockets are empty and buttons and zips are fastened. Avoid washing frayed or torn articles and treat stains such as paint, ink, rust, and grass before washing. Underwired bras must NOT be machine washed.
 - Garments which have been in contact with volatile petroleum products should not be machine washed.
- If volatile cleaning fluids are used, care should be taken to ensure that the fluid is removed from the garment before placing in the machine.
- Never pull the power supply cable to remove the plug from the socket; always take hold of the plug itself.
 - Never use the appliance if the power supply cable, the control panel, the working surface or the base are damaged so that the inside of the washing machine is accessible.

Child safety

- This appliance is not intended for use by person (including children) with reduced physical sensory or mental capabilities or lack of experience and knowledge unless they have been given supervision or instruction concerning use of the appliance by a person responsible for their safety.
- The packaging components (e.g. plastic film, polystyrene) can be dangerous to children - danger of suffocation! - Keep them out of children's reach!
- Keep all detergents in a safe place out of children's reach.
- Make sure that children or pets do not climb into the drum. To prevent children and pets becoming trapped inside the drum this machine incorporates a special feature.

Product description

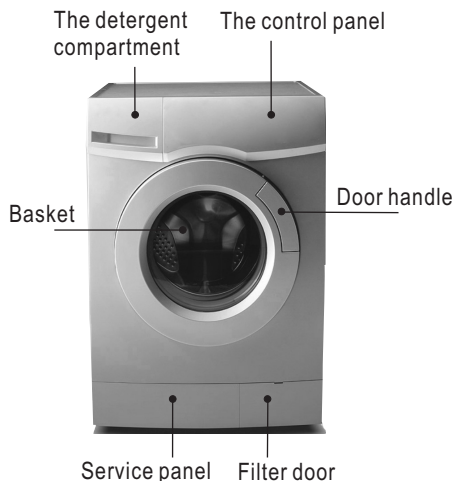



Quick Guide

1. Install the washing machine
2. Load the laundry
3. measure out the detergent
4. Close the machine door
5. Put down (hang up) the drain pipe
6. Turn on the water tap
7. Plug the power supply
8. Select the desired programme
9. Press the [start/pause] key

Detergent dispenser drawer

 Compartment for detergent used for prewash and soak phase or for stain remover used during the stain action phase (if available). The prewash and soak detergent is added at the beginning of the wash programme. The stain remover is added during the stain action phase.

 Compartment for powder or liquid detergent used for main wash. If using liquid detergent pour it just before starting the programme.

 Compartment for liquid additives (fabric softener, starch).

Follow the product manufacturer's recommendations on quantities to use and do not exceed the «MAX» mark in the detergent dispenser drawer. Any fabric softener or starching additives must be poured into the compartment before starting the wash programme.

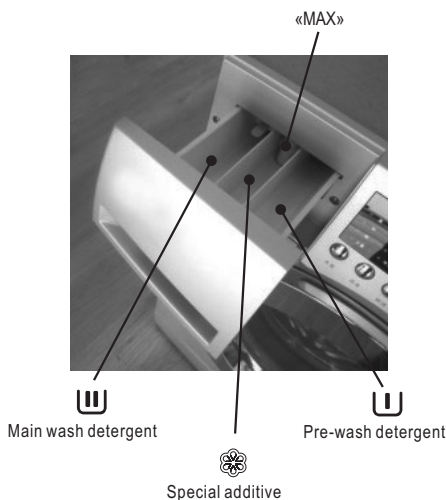

Control panel

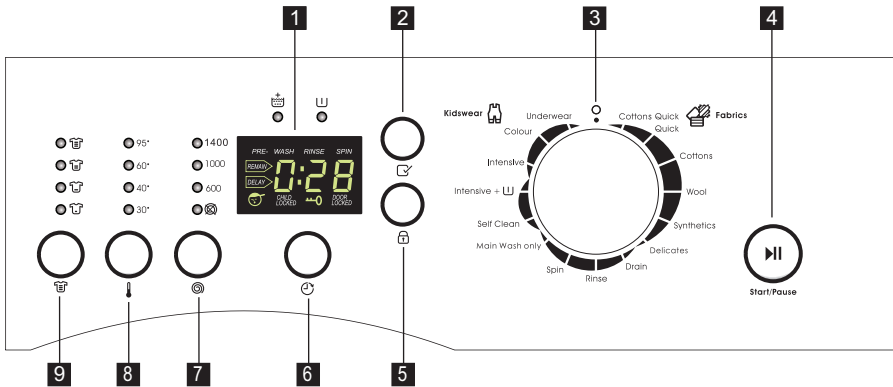

- 1** Display
- 2** OPTIONS button
- 3** Programme selector dial
- 4** START/PAUSE button
- 5** ADDITIONAL CHILD LOCK button
- 6** DELAY START button
- 7** SPIN button
- 8** TEMPERATURE button
- 9** SOIL LEVEL button

Display

- The corresponding lights (pre wash, washing, rinse, spin) will flash when the washing proceeds to each step during the washing process.
- The «DELAY» will light when the delay programme is selected and it will display the delay time. It will start the programme after [xx] hours.
- After the washing procedure is began, [REMAIN] will be lightened, and the displayed time indicates that the washing will be finished within [xxx] time.
- When the child lock function is selected, «CHILD LOCKED» will be light up.
- When the door is at the lock state, «DOOR LOCKED» will be light up. The door can be opened only after the light turns off.

OPTIONS button

- In order to get better care of your clothes you can select the extra rinse or pre wash function.

Programme selector dial

- So your clothes have a more efficient and clean wash different wash cycles can be selected depending on the users needs.

START/PAUSE button

- «Start/Pause» button, has the start and pause function. When this button is pressed continuously, this machine is switched between start and pause.

SOIL LEVEL button

- You can select according to the soil level of the laundry.

TEMPERATURE button

- This button is used to adjust the wash temperature. You can select different water temperature or no heating by pressing the button repeatedly.

SPIN SPEED button

- By pressing this button you can change the spin speed of the selected programme or to select Rinse Hold option.

DELAY START button

- This button is used for delay wash. You can get 0-24 hours through pressing this key continuously. The delay time means the wash will begin in «xx» hours.

Additional child lock.

- There is an additional, selectable child safety feature. To select it, press button **5** for three seconds. The Child Lock button also locks the Start/Pause button. An English text and the image of the head of a child appear in the display when the lock is activated.

You can now also press the Pause button without anything happening.

There will just be an error beep. When the programme has finished, the door can be opened, but to select the next wash you need to press the Child Lock button once more to cancel the child lock.

Turning the machine off and then on again will not cancel the child lock, so it can be left permanently locked.

Washing Programmes for ZWG1100M-ZWG1120M

Fabric Cycle	Maximum temperature (Centigrade)	Maximum spin speed RPM	The maximum washing capacity (kilogram)	Extra Rinse	Pre-Wash	Detergent box		Default operation time	Clothes to be washed (suggestion)
						Pre-wash	Main wash		
Cottons Quick	95	1000 1200	6	Optional	Optional	●	○	1:23	Ordinary clothes
Quick	40	1000 1200	3	Optional	Non-optional	●	○	0:23	Lightly Soiled
Cottons	95	1000 1200	6	Optional	Optional	●	○	2:47	Comparatively thick clothes
Wool	40	800 900	2.5	Optional	Non-optional	●	○	0:43	Woolen clothes
Synthetics	60	800 900	3	Optional	Optional	●	○	0:57	Chemical fibre clothes
Delicates	30	600 600	2	Optional	Non-optional	●	○	0:34	Silk clothes
Hygiene Colour Intensive	95	1000 1200	6	Optional	Optional	●	○	1:34	Children's underwear
Kidswear	40	1000 1200	3	Optional	Optional	●	○	0:53	Ordinary children's wear
Intensive +	60 (Default)	1000 1200	3	Optional	Selected	●	○	1:20	Comparatively dirty children's wear
Self Clean	95 (Default)	600 600	—	Optional	Must	●	○	1:52	Comparatively dirty clothes
Main Wash Only	95	—	6	Non-optional	Non-optional	●	○	1:03	No detergent
Rinse	—	1000 1200	—	Optional	Optional	●	○	0:32	The clothes that only need the single wash
Spin	—	1000 1200	—	Optional	Non-optional	●	○	0:14	
Drain	—	—	—	Non-optional	Non-optional	●	○	0:08	
	—	—	—	Non-optional	Non-optional	●	○	0:01	

● It means it is necessary to add the detergent or the wash effect cannot be reached.

○ It means to add the detergent or the softener when it is needed.

X It means the detergent or the softener cannot be added.

△ The operation time of the wash machine will change with the variance of the water temperature, water level, clothes, inlet water pressure and drain state.

Washing Programmes for ZWG1140M

Fabric Cycle	Maximum temperature (Centigrade)	Maximum spin speed RPM	The maximum washing capacity (kilogram)	Extra Rinse	Pre-Wash	Detergent box		Default operation time	Clothes to be washed (suggestion)	
						Pre-wash	Main wash			Softener
Cottons Quick	95	1400	6	Optional	Optional	○	●	○	1:24	Ordinary clothes
Quick	40	1400	3	Optional	Non-optional	○	●	○	0:24	Lightly Soiled
Cottons	95	1400	6	Optional	Optional	○	●	○	3:05	Comparatively thick clothes
Wool	40	1000	2.5	Optional	Non-optional	○	●	○	0:43	Woolen clothes
Synthetics	60	1000	3	Optional	Optional	○	●	○	0:58	Chemical fibre clothes
Delicates	30	600	2	Optional	Non-optional	○	●	○	0:34	Silk clothes
Hygiene Colour Intensive	95	1400	6	Optional	Optional	○	●	○	1:35	Children's underwear
Kidswear	40	1400	3	Optional	Optional	○	●	○	0:54	Ordinary children's wear
Hygiene + U	60	1400	3	Optional	Selected	○	●	○	1:21	Comparatively dirty children's wear
Intensive	60 (Default)	1400	3	Optional	Must	●	●	○	1:53	Comparatively dirty clothes
Self Clean	95 (Default)	600	—	Non-optional	Non-optional	○	●	○	1:03	No detergent
Main Wash Only	95	—	6	Non-optional	Optional	○	●	○	0:32	The clothes that only need the single wash
Rinse	—	1400	—	Optional	Non-optional	○	●	○	0:15	
Spin	—	1400	—	Non-optional	Non-optional	○	●	○	0:09	
Drain	—	—	—	Non-optional	Non-optional	○	●	○	0:01	

○ It means to add the detergent or the softener when it is needed. ● It means it is necessary to add the detergent or the wash effect cannot be reached.

× It means the detergent or the softener cannot be added.

△ The operation time of the wash machine will change with the variance of the water temperature, water level, clothes, inlet water pressure and drain state.

Helpful hints and tips

Sorting out the laundry

Follow the wash code symbols on each garment label and the manufacturer's washing instructions. Sort the laundry as follows: whites, coloureds, synthetics, delicates, woollens.

Before loading the laundry

Never wash whites and coloureds together. Whites may lose their «whiteness» in the wash.

New coloured items may run in the first wash; they should therefore be washed separately the first time.

Button up pillowcases, close zip fasteners, hooks and poppers. Tie any belts or long tapes.

Remove persistent stains before washing.

Rub particularly soiled areas with a special detergent or detergent paste.

Treat curtains with special care. Remove hooks or tie them up in a bag or net.

Removing stains

Stubborn stains may not be removed by just water and detergent. It is therefore advisable to treat them prior to washing.

Blood: treat fresh stains with cold water. For dried stains, soak overnight in water with a special detergent then rub in the soap and water.

Oil based paint: moisten with benzine stain remover, lay the garment on a soft cloth and dab the stain; treat several times.

Dried grease stains: moisten with turpentine, lay the garment on a soft surface and dab the stain with the fingertips and a cotton cloth.

Rust: oxalic acid dissolved in hot water or a rust removing product used cold. Be careful with rust stains which are not recent since the cellulose structure will already have been damaged and the fabric tends to hole.

Mould stains: treat with bleach, rinse well (whites and fast coloureds only).

Grass: soap lightly and treat with bleach (whites and fast coloureds only).

Ball point pen and glue: moisten with acetone*, lay the garment on a soft cloth and dab the stain.

Lipstick: moisten with acetone as above, then treat stains with methylated spirits. Treat any residual marks with bleach.

Red wine: soak in water and detergent, rinse and treat with acetic or citric acid, then rinse. Treat any residual marks with bleach.

Ink: depending on the type of ink, moisten the fabric first with acetone*, then with acetic acid; treat any residual marks on white fabrics with bleach and then rinse thoroughly.

Tar stains: first treat with stain remover, methylated spirits or benzine, then rub with detergent paste.

Detergents and additives

Good washing results also depend on the choice of detergent and use of the correct quantities to avoid waste and protect the environment.

Although biodegradable, detergents contain substances which, in large quantities, can upset the delicate balance of nature.

The choice of detergent will depend on the type of fabric (delicates, woollens, cottons, etc.), the colour, washing temperature and degree of soiling.

All commonly available washing machine detergents may be used in this appliance:

- powder detergents for all types of fabric
- powder detergents for delicate fabrics (60°C max) and woollens
- liquid detergents, preferably for low temperature wash programmes (60°C max) for all types of fabric, or special for woollens only.

The detergent and any additives must be placed in the appropriate compartments of the dispenser drawer before starting the wash programme.

If using liquid detergents, a programme without prewash must be selected.

Your appliance incorporates a recirculation system which allows an optimal use of the concentrated detergent.

Follow the product manufacturer's recommendations on quantities to use and do not exceed the «MAX» mark in the detergent dispenser drawer.

Quantity of detergent to be used

The type and quantity of detergent will depend on the type of fabric, load size, degree of soiling and hardness of the water used.

Follow the product manufacturers' instructions on quantities to use.

Use less detergent if:

- you are washing a small load
- the laundry is lightly soiled
- large amounts of foam form during washing.

* do not use acetone on artificial silk.

Degrees of water hardness

Water hardness is classified in so-called «degrees» of hardness. Information on hardness of the water in your area can be obtained from the relevant water supply company, or from your local authority. If the water hardness degree is medium or high we suggest you use a water softener, following the manufactures instructions.

When the degree of hardness is soft, re-adjust the quantity of the detergent.

First Use

- Ensure that the electrical and water connections comply with the installation instructions.
- Remove any material from the drum.
- Run a cotton cycle at the highest temperature without any laundry in the machine, to remove any manufacturing residue from the drum and tub. Pour 1/2 a measure of detergent into the main wash compartment and start the machine.

Personalization

Acoustic signals

The machine is provided with an acoustic device, which sounds in the following cases:

- at the end of the cycle
- if there is a fault.

It is not possible deactivate the acoustic signal.

Child safety lock

This device permits you to leave the appliance unattended so you do not need to worry that children might be injured by or cause damage to the appliance. This function remains enabled also when the washing machine is not working.

You can activate it as follow:

1. Press button 4 to start the washing programme.
2. Press button 5 for three seconds to activate the safety device .

Now, it will be impossible to change any other programme or option.

Daily Use

Load the laundry

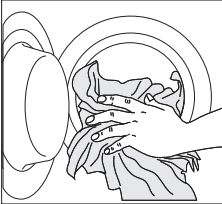

Open the door by carefully pulling the door handle outwards. Place the laundry in the drum, one item at a time, shaking them out as much as possible. Close the door.

Measure out the detergent and the fabric softener

Pull out the dispenser drawer until it stops. Measure out the amount of detergent required, pour it into the main wash compartment or in the appropriate compartment if the selected programme/option it requires (see more details in «Detergent dispenser drawer»).

If required, pour fabric softener into the compartment marked (the amount used must not exceed the «MAX» mark in the drawer). Close the drawer gently.

Select the required programme by means of the programme selector dial (3)

Turn the programme selector dial to the required programme.

The selector dial can be turned either clockwise or anticlockwise.

Turn the selector dial to position **O** to reset the programme or to switch the machine off.

At the end of the programme the selector dial must be turned to position **O**, to switch the machine off.

Important! If you turn the programme selector dial to another programme when the machine is working, the machine will not perform the new selected programme.

Select the spin speed by pressing button 7

When selecting a programme, the appliance proposes automatically a suggested spin speed for that programme. (See «Washing programmes» for the maximum allowed spin speed).

Press this button repeatedly to change the spin speed, if you want your laundry to be spun at a different speed. The relevant pilot light illuminates.

Select the available options by pressing buttons 2

With this button you can select an additional Prewash or an additional Rinse or both.

When this button is pressed, the corresponding pilot light illuminates. When it is pressed again, the pilot light goes out.

Start the programme by pressing button 4

To start the selected programme, press this button. The icon illuminates to indicate that the appliance starts operating and the door is locked.

If you have chosen a delayed start, the machine will begin the countdown.

Select the Delay Start by pressing button 8

Before you start the programme, if you wish to delay the start, press this button to select the desired delay.

The selected delay time value will appear on the display for a few seconds, then the duration of the programme will appear again. By pressing this button, the washing programme can be delayed by 1 hour up to a maximum of 24 hours.

You must select this option after you have set the programme and before you start the programme.

You can cancel or modify the delay time at any moment, before you press button 4.

Selecting the delay start:

1. Select the programme and the required options.
2. Select the delay start by pressing button 8.
3. Press button 4:
 - the machine starts its hourly countdown.
 - the programme will start after the selected delay has expired.

Cancelling the Delay Start after having started the programme:

1. Set the washing machine to PAUSE by pressing button **4**.
2. Press button **6** repeatedly until the display shows 0'.
3. Press button **4** again to start the programme.

Important!

- The door will be locked throughout the delay time. If you need to open the door, you must first set the washing machine to PAUSE by pressing button **4** and wait a few minutes before opening the door. After you have closed the door, press the same button again.

Important! The Delay Start cannot be selected with the draining programme.

Altering an option or a running programme

It is possible to change some options before the programme carries them out.

Before you make any change, you must pause the washing machine by pressing button **4**.

Changing a running programme is possible only by resetting it. Turn the programme selector dial to **0** and then to the new programme position. Start the new programme by pressing button **4** again.

The washing water in the tub will be not emptied out.

Interrupting a programme

Press the button **4** to interrupt a programme which is running.

Press the button again to restart the programme.

Cancelling a programme

Turn the selector dial to **0** to cancel a programme which is running, and wait few minutes to open the door (it is possible only if in the tub there is not water).

At the end of the programme

The machine stops automatically.

The blinking zero appears on the display.

If a programme or an option that ends with water left in the tub has been selected, the door is locked to indicate that the water must be emptied out before opening the door.

Follow the below instructions to empty out the water:

1. Turn the programme selector dial to **0**.
2. Select the draining or spinning programme.

3. Reduce the spin speed if needed, by pressing the relevant button.

4. Press button **4**.

At the end of the programme, the door is released, after few minutes, and can be opened. Turn the programme selector dial to **0** to switch the machine off.

Remove the laundry from the drum and carefully check that the drum is empty. If you do not intend to carry out another wash, close the water tap. Leave the door open to prevent the formation of mildew and unpleasant smells.

Stand-By:

1. Once the programme has finished after a few minutes the energy saving system will be enabled. The brightness of the display and the indicator pilot lights are off.

2. If the appliance is switch on but in PAUSE, only the brightness of the display is off.

By pressing any button the appliance will come out of the energy saving status.

Care and cleaning

⚠ Warning! You must **DISCONNECT** the appliance from the electricity supply, before you can carry out any cleaning or maintenance work.

Descaling

The water we use normally contains lime. It is a good idea to periodically use a water softening powder in the machine.

Do this separately from any laundry washing, and according to the softening powder manufacturer's instructions.

This will help to prevent the formation of lime deposits.

External cleaning

Clean the exterior cabinet of the appliance with soap and water only, and then dry thoroughly.

Cleaning the dispenser drawer

The washing powder and additive dispenser drawer should be cleaned regularly.

1 Press



2 Pull out at the same time

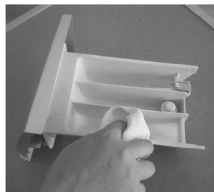

3 Clean

Flush it out under a tap, to remove any traces of accumulated powder.

Cleaning the drawer recess

Have

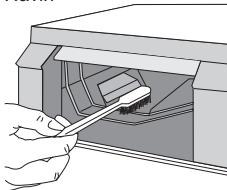

run the rinse programme

g removed the drawer, use a small brush to clean the recess ensuring that all washing powder residue is removed from the upper and lower part of the recess.

Replace the drawer and

without any clothes in the

Cleaning the pump

Important!

According to the soil level within the cycles and the frequency of the cycles, you have to inspect and clean the filter regularly.

The pump should be inspected if:

- the machine does not empty and/or spin;
- the machine makes an unusual noise during draining due to objects such as safety pins, coins etc. blocking the pump.

Proceed as follows:

- 1 disconnect the appliance;
- 2 if necessary wait until the water has cooled down.

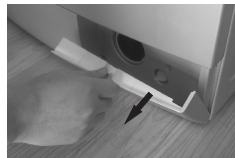

- 3 Open the pump door. Place a container close to the pump to collect any spillage.



Pump cover

4 When no more water comes out, unscrew the pump cover and remove it. Always keep a rag nearby to dry up spillage of water when removing the cover.

5 Remove any objects from the pump impeller by rotating it.

6 Screw the pump cover fully in.

7 Close the pump door.

Warning!

When the appliance is in use and depending on the programme selected there can be hot water in the pump. Never remove the pump cover during a wash cycle, always wait until the appliance has finished the cycle, and is empty. When replacing the cover, ensure it is securely retightened so as to stop leaks and young children being able to remove it.

If you wash rugs, it is compulsory to inspect and clean the filter.

Cleaning the water inlet filters

Important!

If the appliance doesn't fill, takes long to fill with water, the starting button blinks yellow or the display (if available) shows the relevant alarm (see chapter «What to do if...» for more details), check if the water inlet filters are blocked.

To clean the water inlet filters:

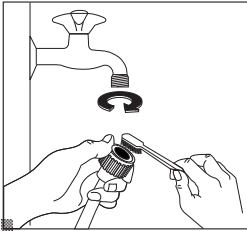

- Turn off the water tap.
- Unscrew the hose from the tap.
- Clean the filter in the hose with a stiff brush.

- Screw the hose back onto the tap. Make sure the connection is tight.

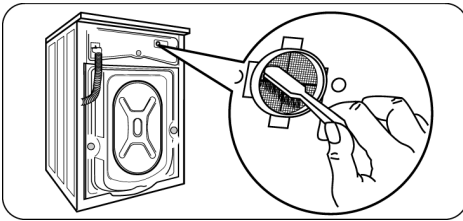

- Unscrew the hose from the machine. Keep a rag nearby because some water may flow.
- Clean the filter in the valve with a stiff brush or with the piece of cloth.

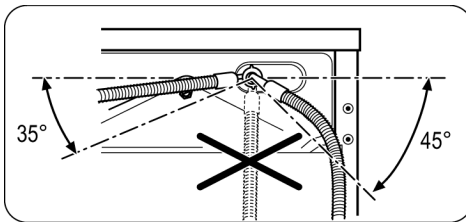

- Screw the hose back to the machine and make sure the connection is tight.
- Turn on the water tap.

Frost precaution or emergency emptied out

If the machine is exposed to temperatures below 0°C or if the water is not discharged, proceed as follows.

- 1 Pull out the plug from the power socket.
- 2 Turn off the water tap.
- 3 Unscrew the inlet hose.
- 4 Place a bowl on the floor and place the end of the inlet and drain hoses into it. The water should drain by gravity into the bowl.
- 5 Select and run a draining programme.
- 6 Clean the pump if necessary as previously described.
- 7 Screw the water inlet hose back on.
- 8 When you intend to start the machine up again, make sure that the room temperature is above 0°C.

What to do if.....

Certain problems are due to lack of simple maintenance or oversights, which can be solved easily without calling out an engineer.





Before contacting your local Service Centre, please carry out the checks listed below.

Malfunction	Possible Cause / Solution
<p>The washing machine does not work</p>	<ul style="list-style-type: none"> • Close the washing machine's door. • Press the ▽Start/Pause▽key.
<p>Water leakage</p>	<ul style="list-style-type: none"> • Correctly connect the inlet water pipe.
<p>The spin of the clothes is abnormal</p>	<ul style="list-style-type: none"> • Reload and distribute the laundry evenly in the drum.
<p>There is the peculiar smell in the washing machine</p>	<ul style="list-style-type: none"> • Run a Self-clean cycle without any clothes.
<p>No water is visible in the drum</p>	<ul style="list-style-type: none"> • No fault-water is under the visible area.
<p>There is the remaining water in the softener's box</p>	<ul style="list-style-type: none"> • No fault- the effect of the softener will not be affected.
<p>The remaining detergent is left on the clothes</p>	<p>The water-fast component of the non-phosphorus detergent will be left on the clothes to form into spot.</p> <ul style="list-style-type: none"> • Please select «Rinse&Spin» programme. • or brush away the fleck after the clothes is dried.
<p>The washing machine does not fill</p>	<ul style="list-style-type: none"> • Turn on the water tap. • Check the selection of the procedure. • Check if the water pressure is sufficient. • Reconnect the water inlet pipe. • Close the washing machine's door. • Check if the inlet water pipe is bent or blocked.
<p>The washing machine fills and drains at the same time.</p>	<ul style="list-style-type: none"> • Make sure the end of the drainage pipe is higher than the water level inside the machine . • Check if the drainage pipe and waste have been sealed.
<p>The washing machine does not drain</p>	<ul style="list-style-type: none"> • Check if the drainage pumps is blocked. • Check if the drainage pipe is bent or blocked. • Check the height of the drainage nozzle, make sure it is 0.6-1 meter high from the bottom of the washing machine.
<p>Vibration of the washing machine</p>	<ul style="list-style-type: none"> • Level the washing machine. • Fasten the footing. • Check if all the delivery bolts have all been removed.

Malfunction	Possible Cause / Solution
Foam spills from the detergent drawer	<ul style="list-style-type: none"> • Check if the amount of detergent is excessive, if it is the specialized detergent for the drum washing machine. • Dip one scoop of the softener mixed with 1/2 liter of water to the detergent box II. • Reduce the amount of detergent used next time.
The machine stops when the procedure has not been finished	<ul style="list-style-type: none"> • Power failure or water cut.
The drainage pump is noisy during operation after the water has been drained.	<ul style="list-style-type: none"> • The water inside the inner barrel has been drained but there is still a small amount of water in the drainage pump and pipe. The drainage pump continuously work and takes in the air, then there will be noise which is normal situation.
The machine stops for some time during the wash procedure.	<ul style="list-style-type: none"> • The washing machine adds water automatically. • There is too much foam in the tube, the foam is being drained.

Alarm codes

⚠ If the washing machine cannot work normally, a alarm code will appear on the display. Please carry out the following checks.

Display	Reason	Solutions
	Inlet water overtime	Open the water tap, to check if the inlet hose is squashed or kinked, check if the filter in the inlet valve is blocked or not; check if the water pressure is too low.
	Overtime of the drainage	Check if the drain pump is blocked (see page 11).
	The door has not been closed	Check if the door of the washing machine is closed; check if the clothes are trapped by the door seal.
	Voltage is too high	Check if the voltage is too high if it is this case, a constant voltage device is needed.
	Others	Try to use again or contact your local service center if the problem persists.

If you are unable to identify or solve the problem, contact our service centre. Before telephoning, make a note of the model, serial number and purchase date of your machine. The Service Centre will require this information.

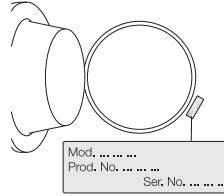

Technical data

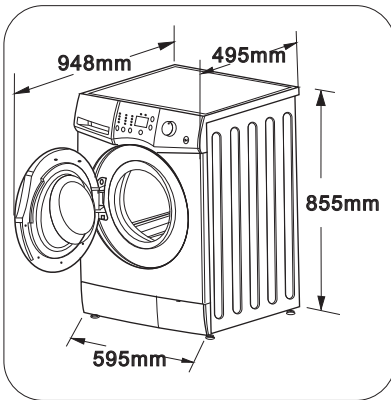

Rated Mains	220-240 V/ 50Hz
Wash power	150W
Spin power	360W
Heat power	2000W
Max. Power	2150W
Water pressure	0.02MPa~1MPa
Net weight	65Kg
Drain method	Upper drain
Spin method	Centrifugal
Washing capacity	6Kg
Maxinum spin speed rpm	1400 (ZWG1140M) 1200 (ZWG1120M) 1000 (ZWG1100M)
Waterproof Level	IPX4
Drain Method	Upper Drainage
Drain Hose	Height from the floor: 60cm minimum, 100cm maximum

Installation

Unpacking

All transit bolts and packing must be removed before using the appliance.

You are advised to keep all transit devices so that they can be refitted if the machine ever has to be transported again.

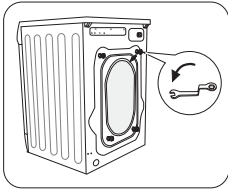

Unscrew the four bolts using a spanner. Slide out the relevant plastic spacers.

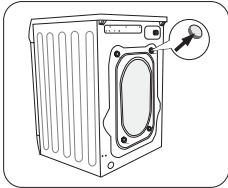

Fill the holes with the corresponding plastic plug caps supplied in the bag containing the instruction booklet.

Positioning

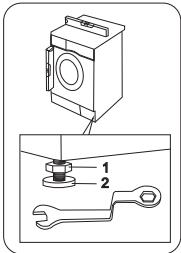

Install the machine on a flat hard floor. Make sure that air circulation around the machine is not impeded by carpets, rugs etc. Check that the machine does not touch the wall or other kitchen units. Level the washing machine by raising or lowering the feet. The feet may be tight to adjust as they incorporate a self locking nut,

but the machine **MUST** be level and stable. Any necessary adjustment can be made with a spanner.

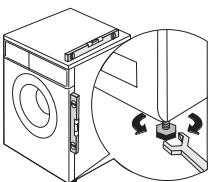

If necessary, check the setting with a spirit level.

Accurate levelling prevents vibration, noise and displacement of the machine during operation. Never place cardboard, wood or similar materials under the machine to compensate for any unevenness in the floor.

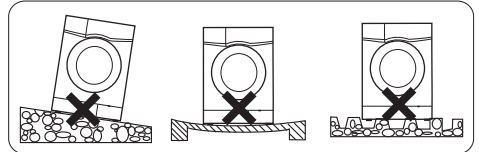

Water inlet

⚠ Caution! This appliance must be connected to a cold water supply.

⚠ Caution! Before connecting up the appliance to new pipework or to pipework that has not been used for some time, run off a reasonable amount of water to flush out any debris that may have collected

⚠ Caution! Do not use the hose from your previous appliance to connect to water supply.

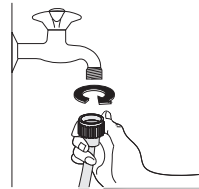

Connect the hose to a tap with a 3/4" thread.

Always use the hose supplied with the appliance.

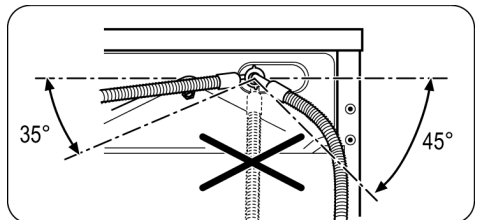

The other end of the inlet hose which connects to the appliance can be turned as showed in the picture. Do not place the inlet hose downwards. Angle the hose to the left or right depending on the position of your water tap. Set the hose correctly by loosening the ring nut. After positioning the inlet hose, be sure to tighten the ring nut again to prevent leaks.

Caution! The inlet hose must not be lengthened. If it is too short and you do not wish to move the tap, you will have to purchase a new, longer hose specially designed for this type of use.

Water drainage

The end of the drain hose can be positioned in three ways:

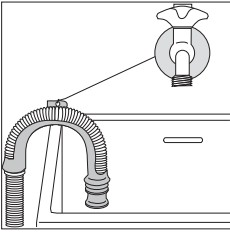

Hooked over the edge of a sink using the plastic hose guide supplied with the machine.

In this case, make sure the end cannot come unhooked when the machine is emptying.

This could be done by tying it to the tap with a piece of string or attaching it to the wall.

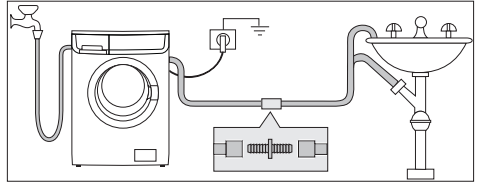

In a sink drain pipe branch.

This branch must be above the trap so that the bend is at least 60 cm above the ground.

Directly into a drain pipe at a height of not less than 60 cm and not more than 90 cm. The end of the drain hose must always be ventilated, i.e. the inside diameter of the drain pipe must be larger than the outside diameter of the drain hose.

The drain hose must not be kinked.

Electrical connection

Information on the electrical connection is given on the rating plate on the inner edge of the appliance door. Check that your domestic electrical installation can take the maximum load required, also taking into account any other appliances in use.

⚠ Caution! Connect the machine to an earthed socket.

⚠ Caution! The manufacturer does not accept any responsibility for damage or injury through failure

to comply with the above safety precaution.

⚠ Caution! Should the appliance power supply cable need to be replaced, this **MUST** be carried out by a Service Centre.

The power supply cable must be easily accessible **⚠** after installing the machine.

Environment concerns

The symbol  on the product or on its packaging indicates that this product may not be treated as household waste. Instead it should be taken to the appropriate collection point for the recycling of electrical and electronic equipment. By ensuring this product is disposed of correctly, you will help prevent potential negative consequences for the environment and human health, which could otherwise be caused by inappropriate waste handling of this product.

For more detailed information about recycling of this product, please contact your local council, your household waste disposal service or the shop where you purchased the product.

Packaging materials

The materials marked with the symbol are recyclable.

>PE<=polyethylene

>PS<=polystyrene

>PP<=polypropylene

>PAP<=paper

ZANUSSI

www.electrolux.com

www.zanussi.be