

MC21XX SERIES MOBILE COMPUTER USER GUIDE

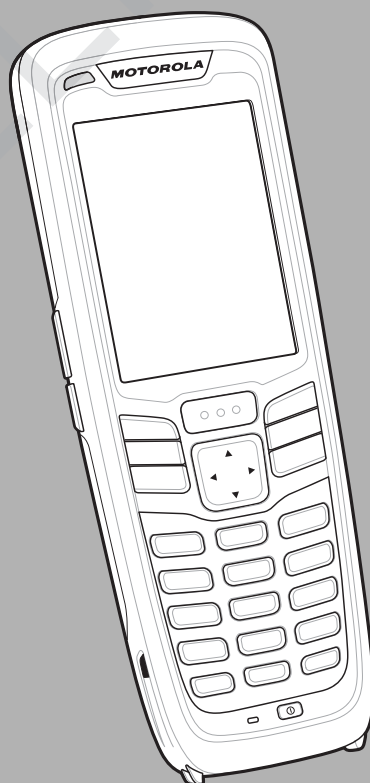

PRELIMINARY

MC21XX SERIES MOBILE COMPUTER USER GUIDE

72E-155020-01

Rev. 101411

October 2011

PRELIMINARY

No part of this publication may be reproduced or used in any form, or by any electrical or mechanical means, without permission in writing from Motorola. This includes electronic or mechanical means, such as photocopying, recording, or information storage and retrieval systems. The material in this manual is subject to change without notice.

The software is provided strictly on an “as is” basis. All software, including firmware, furnished to the user is on a licensed basis. Motorola grants to the user a non-transferable and non-exclusive license to use each software and firmware program delivered hereunder (licensed program). Except as noted below, such license may not be assigned, sublicensed, or otherwise transferred by the user without prior written consent of Motorola. No right to copy a licensed program in whole or in part is granted, except as permitted under copyright law. The user shall not modify, merge, or incorporate any form or portion of a licensed program with other program material, create a derivative work from a licensed program, or use a licensed program in a network without written permission from Motorola. The user agrees to maintain Motorola’s copyright notice on the licensed programs delivered hereunder, and to include the same on any authorized copies it makes, in whole or in part. The user agrees not to decompile, disassemble, decode, or reverse engineer any licensed program delivered to the user or any portion thereof.

Motorola reserves the right to make changes to any software or product to improve reliability, function, or design.

Motorola does not assume any product liability arising out of, or in connection with, the application or use of any product, circuit, or application described herein.

No license is granted, either expressly or by implication, estoppel, or otherwise under any Motorola, Inc., intellectual property rights. An implied license only exists for equipment, circuits, and subsystems contained in Motorola products.

Revision History

Changes to the original guide are listed below:

Change	Date	Description

PRELIMINARY

PRELIMINARY

TABLE OF CONTENTS

Revision History	iii
About This Guide	
Introduction	i
Documentation Set	i
Configurations	ii
Software Versions	ii
Chapter Descriptions	iii
Notational Conventions	iii
Related Documents and Software	iv
Service Information	iv
Chapter 1: Getting Started	
Introduction	1-1
Unpacking the Mobile Computer	1-1
Features	1-2
Mobile Computer Startup	1-3
Install microSD Card	1-3
Install Main Battery	1-4
Battery Charging	1-5
Spare Battery Charging	1-7
Starting the MC21XX	1-7
Calibration Screen	1-7
Main Battery Removal	1-8
Turning Off the Radios	1-9
WLAN Radio	1-9
Safe System Shutdown/Re-boot	1-9
Chapter 2: Operation	
Introduction	2-1
Power Button	2-1
Windows CE Sample Applications Window	2-1

Windows CE Desktop	2-2
Using the Keypad to Navigate Applications	2-2
Key Combinations	2-2
Selecting Items	2-3
Adjusting the Volume	2-4
Adjusting the Screen Brightness	2-4
Windows CE Status Icons	2-5
Battery Unknown Icon	2-6
Start Button	2-6
Programs Menu	2-7
Control Panel	2-8
Keyboard Input Panel Button	2-9
Desktop Display Button	2-9
Task Manager and Properties	2-9
Task Manager	2-9
Properties	2-9
Stylus	2-10
Entering Information	2-11
Entering Information Using Keypad	2-12
Entering Information Using the Keyboard Input Panel	2-12
Entering Data via the Bar Code Scanner	2-12
Resetting the MC21XX	2-12
Performing a Warm Boot	2-12
Performing a Cold Boot	2-13
Waking the MC21XX	2-13
Battery Health	2-14
Using the Keypad	2-15
Browser	2-16
TEAM Express	2-17
Installation	2-17
Group Broadcast Communication Buttons	2-17
Chapter 3: Data Capture	
Introduction	3-1
Linear Imager	3-1
1D Laser Scanner	3-1
2D Imaging	3-1
Operational Modes	3-2
Scanning Considerations	3-2
Laser Scanning and Linear Imaging	3-3

Imager Scanning	3-4
DataWedge	3-5
Enable DataWedge	3-5
Disable DataWedge	3-5
Adjusting the Scan Beeper Volume	3-5
Using CtlPanel	3-5
Using DataWedge	3-5
Chapter 4: Bluetooth	
Introduction	4-1
Adaptive Frequency Hopping	4-1
Security	4-2
Bluetooth Configuration	4-2
Bluetooth Power States	4-3
Cold Boot	4-3
Warm Boot	4-3
Suspend	4-3
Resume	4-3
Using Microsoft Bluetooth Stack	4-4
Power Modes	4-4
Discovering Bluetooth Device(s)	4-4
Available Services	4-5
Chapter 5: Wireless Applications	
Introduction	5-1
Signal Strength Icon	5-3
Turning Off the Radio	5-3
Minimum Setup	5-3
Chapter 6: Accessories	
Introduction	6-1
Single-slot USB Cradle	6-3
Battery Charging	6-3
Four-slot Charge Only Cradle	6-4
Battery Charging	6-4
Power LED	6-4
Four-slot Ethernet Cradle	6-5
Battery Charging	6-5
LED Charge Indications	6-5
Speed LED	6-6
Link LED	6-6
Four-slot Spare Battery Charger	6-7
Spare Battery Charging	6-7
Modem Adapter Cable/Modem Dongle	6-8
Setup	6-9
Connecting to the MC21XX	6-9
USB ActiveSync/Charge Cable	6-11
Battery Charging and Operating Power	6-11

LED Charge Indications	6-12
Holster	6-13
Handstrap	6-14
Installation	6-14
Removal	6-15
Lanyard	6-16
Installation	6-16
Removal	6-16
Tether Installation	6-17

Chapter 7: Maintenance & Troubleshooting

Introduction	7-1
Maintaining the MC21XX	7-1
Battery Safety Guidelines	7-2
Cleaning	7-3
Approved Cleanser Active Ingredients	7-3
Harmful Ingredients	7-3
Cleaning Instructions	7-3
Special Cleaning Notes	7-3
Materials Required	7-3
Cleaning the MC21XX	7-4
Housing	7-4
Display	7-4
Scanner Exit Window	7-4
Connector	7-4
Cleaning Cradle Connectors	7-4
Cleaning Frequency	7-5
Troubleshooting	7-6
MC21XX	7-6
Single-slot USB Cradle	7-8
Four-slot Charge Only Cradle	7-8
Four-slot Spare Battery Charger	7-9
USB ActiveSync/Charge Cable	7-9

Appendix A: Specifications

MC21XX and Accessory Technical Specifications	A-1
---	-----

Appendix B: Keypad

Introduction	B-1
27-Key Keypad	B-1

Glossary

Index

ABOUT THIS GUIDE

Introduction

This guide provides information about using the MC21XX mobile computers and accessories.

✓ **NOTE** Screens and windows pictured in this guide are samples and may differ from actual screens.

Documentation Set

The documentation set for the MC21XX is divided into guides that provide information for specific user needs.

- **MC21XX Series Quick Start Guide** - describes how to use the MC21XX.
- **MC21XX Series Mobile Computer User Guide** - describes how to use the MC21XX.
- **MC21XX Series Mobile Computer Integrator Guide** - describes how to set up the MC21XX and the accessories.
- **Microsoft Applications for Windows Mobile 6.1 and CE 6.0 User Guide** - describes how to use Microsoft developed applications.
- **Application Guide for Motorola Enterprise Mobility Devices** - describes how to use Motorola Enterprise Mobility developed applications.
- **EMDK Help File** - provides API information for writing applications.

Configurations

This guide covers the following configurations:

Configuration	Radios	Display	Memory	Data Capture	Operating System
MC2100	None	Color, no touch	128 MB RAM/ 256 MB Flash	Linear imager or 1D laser	Windows CE 6.0
MC2180	WLAN: 802.11 b/g/n WPAN: Bluetooth	Color touch screen	128 MB RAM/ 256 MB Flash	Linear imager, 1D laser or 2D imager	Windows CE 6.0

Software Versions

This guide covers various software configurations and references are made to operating system or software versions for:

- OEM version
- Fusion version.

OEM Version

To determine the OEM software version:

Tap **Start > Settings > Control Panel > System Info icon > System tab**.



Fusion Software

To determine the Fusion software version:

- ✓ **NOTE** MC2180 only.

Tap **Wireless Strength icon > Wireless Status > Versions**.

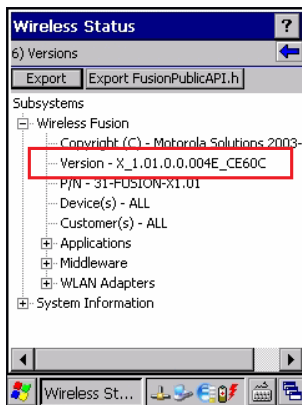

Chapter Descriptions

Topics covered in this guide are as follows:

- [Chapter 1, Getting Started](#), describes the MC21XX's physical characteristics, how to install and charge the batteries, remove and replace the handstrap and how to start the MC21XX for the first time.
- [Chapter 2, Operation](#), provides basic instructions for using the MC21XX and navigating the MC21XX software.
- [Chapter 3, Data Capture](#) provides instructions for using the MC21XX to capture data using the linear, 1D laser or 2D imager.
- [Chapter 4, Bluetooth](#), explains how to perform Bluetooth functionality on the MC21XX
- [Chapter 5, Wireless Applications](#), explains how to use the Wireless applications on the MC21XX.
- [Chapter 6, Accessories](#), describes the accessories available for the MC21XX and how to use the accessories to charge the MC21XX.
- [Chapter 7, Maintenance & Troubleshooting](#), includes instructions on cleaning and storing the MC21XX, and provides troubleshooting solutions for potential problems during MC21XX operation.
- [Appendix A, Specifications](#), includes a table listing the technical specifications for the MC21XX.
- [Appendix B, Keypad](#), contains keypad descriptions and special character generation tables.

Notational Conventions

The following conventions are used in this document:

- The term “mobile computer” refers to the Motorola MC21XX.
- *Italics* are used to highlight the following:
 - Chapters and sections in this and related documents
 - Dialog box, window and screen names
 - Drop-down list and list box names
 - Check box and radio button names
 - Icons on a screen.

- **Bold** text is used to highlight the following:
 - Key names on a keypad
 - Button names on a screen.
- Bullets (•) indicate:
 - Action items
 - Lists of alternatives
 - Lists of required steps that are not necessarily sequential.
- Sequential lists (e.g., those that describe step-by-step procedures) appear as numbered lists.

Related Documents and Software

The following items provide more information about the MC21XX.

- *MC21XX Quick Start Guide*, p/n 72-155017-xx
- *MC21XX Regulatory Guide*, p/n 72-155018-xx
- *MC21XX Integrator Guide*, p/n 72E-155021-xx
- *Application Guide for Motorola Enterprise Mobility Devices*, p/n 72E-68901-xx
- *Microsoft® Applications for Mobile 6.1 and CE 6.0 User Guide*, p/n 72E-108299-xx
- *Enterprise Mobility Developer Kit (EMDK) Help File*
- *Windows CE Platform SDK for MC2100c50*, available at: <http://supportcentral.motorola.com>
- *Enterprise Mobility Developer Kit for C (EMDK for C)*, available at: <http://supportcentral.motorola.com>
- ActiveSync software, available at: <http://www.microsoft.com>.

For the latest version of this guide and all guides, go to: <http://supportcentral.motorola.com>

Service Information

If you have a problem with your equipment, contact Motorola Enterprise Mobility support for your region. Contact information is available at: <http://www.motorola.com/enterprisemobility/contactsupport>.

When contacting Enterprise Mobility support, please have the following information available:

- Serial number of the unit
- Model number or product name
- Software type and version number

Motorola responds to calls by email, telephone or fax within the time limits set forth in support agreements.

If your problem cannot be solved by Motorola Enterprise Mobility Support, you may need to return your equipment for servicing and will be given specific directions. Motorola is not responsible for any damages incurred during shipment if the approved shipping container is not used. Shipping the units improperly can possibly void the warranty.

If you purchased your Enterprise Mobility business product from a Motorola business partner, contact that business partner for support.

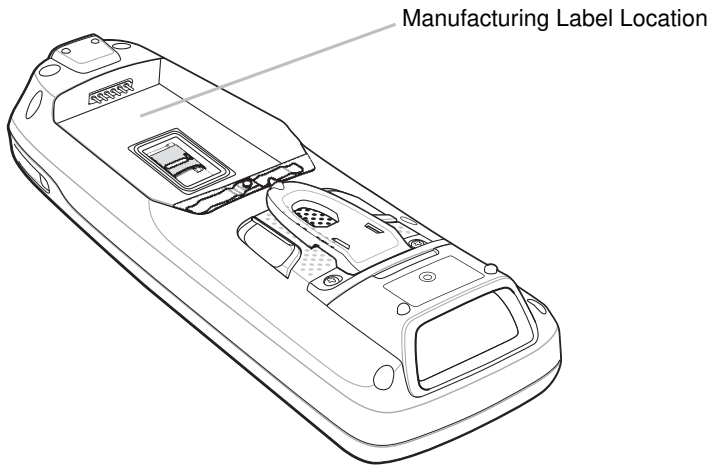

PRELIMINARY

PRELIMINARY

CHAPTER 1 GETTING STARTED

Introduction

This chapter describes the MC21XX physical characteristics, how to install and charge the battery, and how to start the mobile computer for the first time.

Unpacking the Mobile Computer

Carefully remove all protective material from around the mobile computer and save the shipping container for later storage and shipping. Verify that the equipment listed below is included:

- Mobile computer
- Mini stylus (touch screen configurations only)
- Battery
- Power supply
- Regulatory Guide
- Quick Start Guide.

✓ **NOTE** AC line cord has to be ordered separately.

Inspect the equipment for damage. If any equipment is missing or damaged, contact the Motorola Enterprise Mobility Support immediately. See [Service Information on page xvi](#) for contact information.

Features

The features of the MC21XX mobile computer are shown in *Figure 1-1* and *Figure 1-2*.

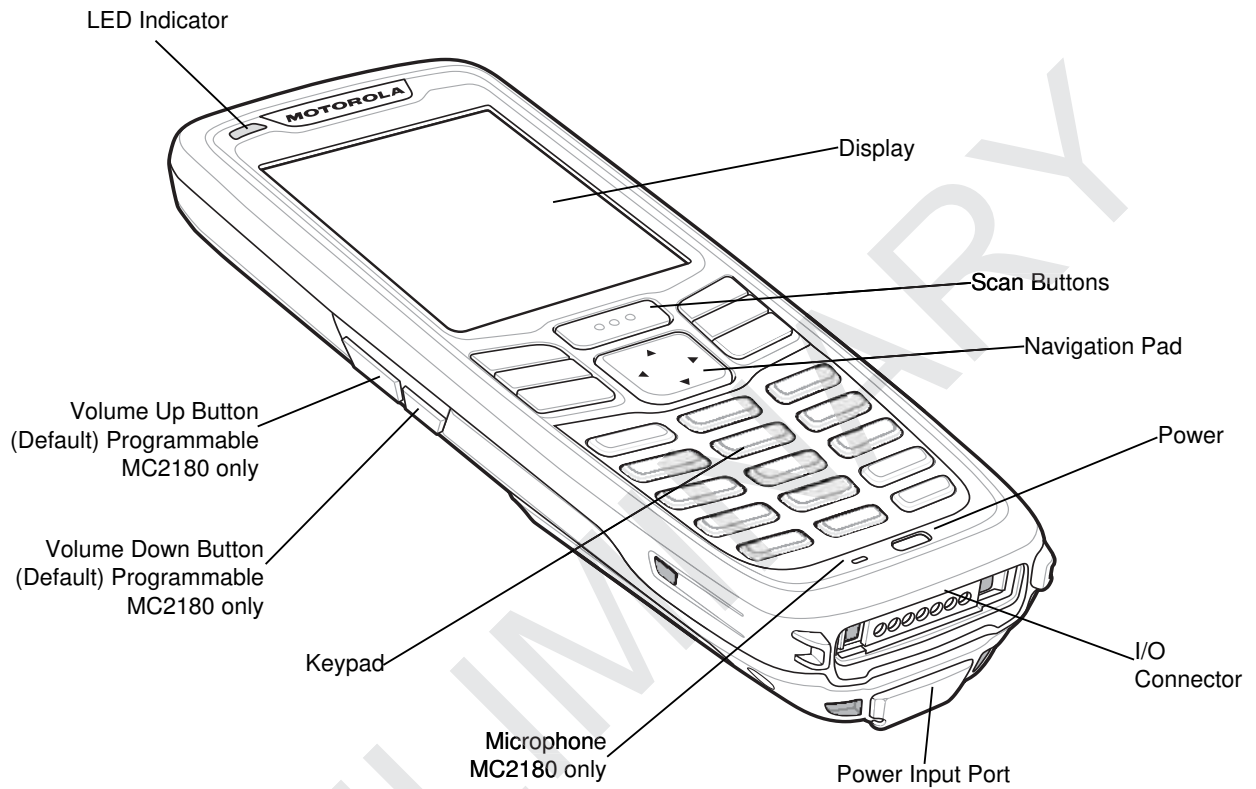

Figure 1-1 MC21XX Mobile Computer (Front View)

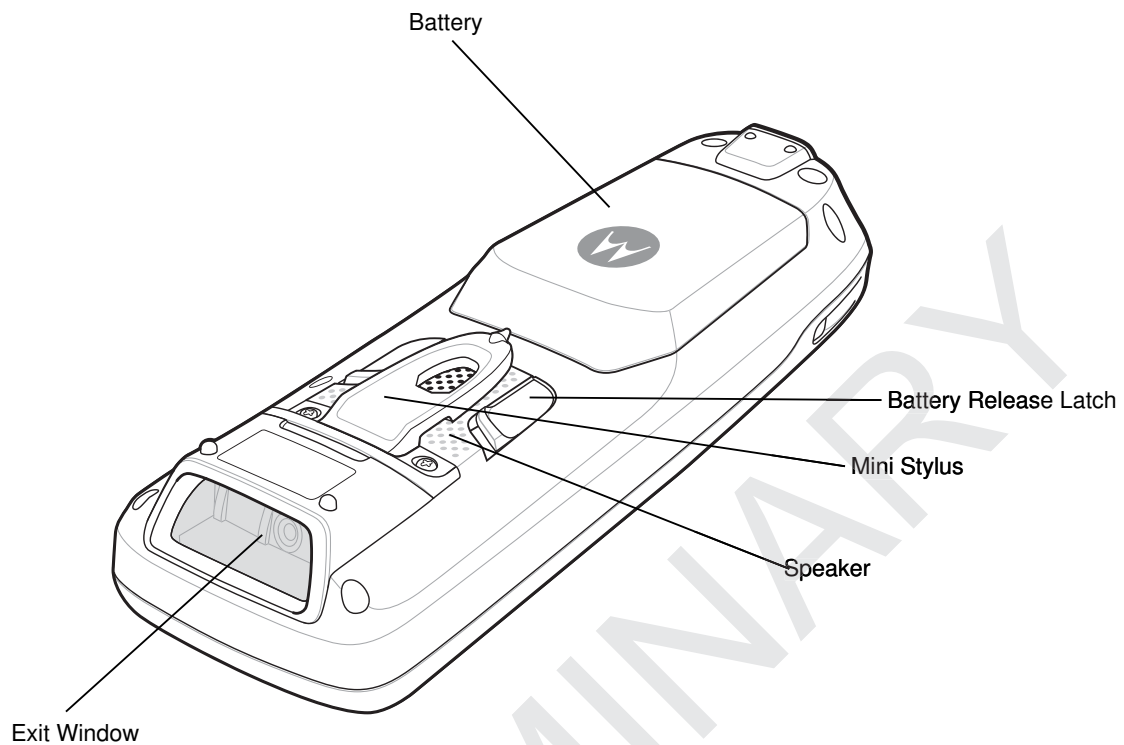

Figure 1-2 MC21XX Mobile Computer (Back View)

Mobile Computer Startup

To start using the MC21XX:

- Install the microSD card (optional).
- Install the main battery.
- Charge the main battery and the backup battery.
- Start the MC21XX.

Install microSD Card

The Secure Device (SD) card provides secondary non-volatile storage (the flash memory is slower than RAM). The SD card holder is located under the battery.



CAUTION Follow proper Electro-Static Discharge (ESD) precautions to avoid damaging the microSD card. Proper ESD precautions include, but are not limited to, working on an ESD mat and ensuring that the operator is properly grounded.

Do not use the microSD card slot for any other accessories.

- ✓ **NOTE** Select microSD cards with environmental and/or the write cycle performance specifications that meet or exceed the application requirements.

To insert the microSD card:

1. Place the MC21XX face-down on surface.
2. Slide the card holder door down to unlock.
3. Lift the microSD card holder door.

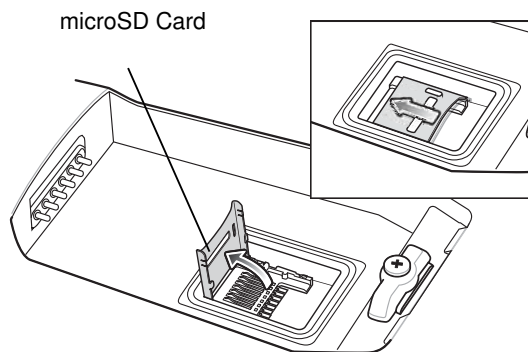

Figure 1-3 Inserting the microSD Card

4. Position the microSD card, with the contacts facing down, into the microSD holder.
5. Close microSD card door.
6. Slide the card holder up to lock.

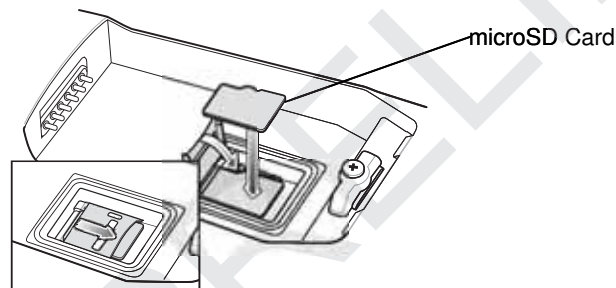

Figure 1-4 Inserting the microSD Card

Install Main Battery

If the main battery is charged, the MC21XX can be used immediately. If the main battery is not charged, see [Battery Charging on page 1-5](#). To remove the main battery, see [Main Battery Removal on page 1-8](#).

Insert the battery into the slot, bottom first and press the battery gently into the slot. The battery latches lock the battery into place.

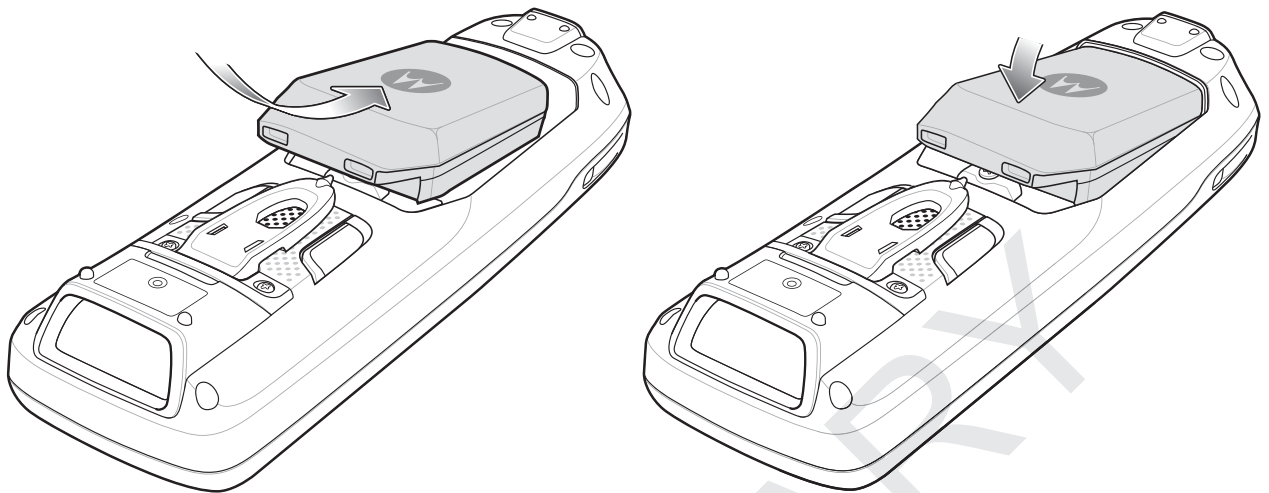

Figure 1-5 Insert Battery

Battery Charging



CAUTION Ensure that you follow the guidelines for battery safety described in [Battery Safety Guidelines on page 7-2](#).

The main battery can be charged before insertion into the MC21XX or after it is installed. Use the Four-slot Battery Charger to charge the main battery (out of the MC21XX) or the supplied power supply to charge the main battery while it is installed in the MC21XX.

Before using the MC21XX for the first time, fully charge the main battery until the LED Indicator remains lit (see [Table 1-1 on page 1-6](#) for charge status indications). The battery fully charges in less than four hours.

The MC21XX is equipped with a memory backup battery which automatically charges from the main battery whether or not the MC21XX is operating or is in suspend mode. The memory backup battery retains data in memory for at least 30 minutes when the MC21XX's main battery is removed or fully discharged. When the MC21XX is used for the first time or after the memory backup battery has fully discharged, the memory backup battery requires approximately 15 hours to fully charge. Do not remove the main battery from the MC21XX for 15 hours to ensure that the memory backup battery fully charges. If the main battery is removed from the MC21XX or the main battery is fully discharged, the memory backup battery completely discharges in several hours.

When the main battery reaches a very low battery state, the combination of main battery and backup battery retains data in memory for at least 72 hours.



NOTE Do not remove the main battery within the first 15 hours of use. If the main battery is removed before the backup battery is fully charged, data may be lost.

Batteries must be charged within the 0° to +40° C (32° to 104° F) ambient temperature range.

To charge the MC21XX using the supplied power supply:

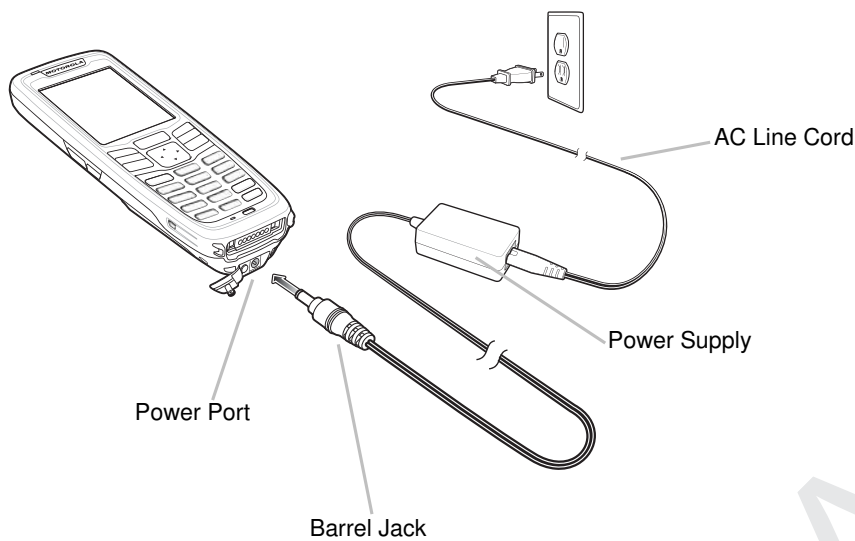

Figure 1-6 Charging Using Power Supply

1. Connect the AC Line Cord to the power supply.
 2. Connect the AC plug to an AC outlet.
 3. Lift the rubber plug covering the MC21XX power port.
 4. Plug the power supply barrel jack into the power port on the bottom of the MC21XX.
- The MC21XX starts to charge. The LED Indicator indicates the charging status.

Table 1-1 LED Indicators

LED	Indication
Off	MC21XX not placed correctly in the cradle; charge cable not connected correctly or charger is not powered.
Fast Blinking Amber	Error in charging. Check placement of the MC21XX.
Slow Blinking Amber	MC21XX is charging.
Solid Amber	Charging complete. Note: When the battery is initially inserted in the MC21XX, the LED flashes once if the battery power is low or the battery is not fully inserted.

The following accessories can also be used to charge the battery:

- Cradle (and a power supply):
 - Single-slot USB Cradle.
- Cables (and a power supply):
 - USB ActiveSync/Charge Cable.
- Chargers (and a power supply):
 - Four-slot Spare Battery Charger.

See [Chapter 6, Accessories](#) for charging instructions using the accessories.

Spare Battery Charging

To charge a spare battery:

1. Connect the Four-slot Battery Charger to the appropriate power source. See [Chapter 6, Accessories](#) for setup instructions.
2. Insert the spare battery, bottom first, into the spare battery charging slot and gently press down on the battery to ensure proper contact.

The battery starts to charge automatically. The LED Indicator blinks amber to indicate the battery is charging. See [Chapter 6, Accessories](#) for charging indications. The battery usually fully charges in less than four hours.

Starting the MC21XX

Press the **Power** button to turn on the MC21XX. If the MC21XX does not power on, perform a cold boot. See [Resetting the MC21XX on page 2-12](#).

When the MC21XX is powered on for the first time, it initializes. The **Splash** screen appears for a short period of time. On the MC2180 the **Calibration** screen appears.

If the MC21XX does not power on, see [Resetting the MC21XX on page 2-12](#).

Calibration Screen

Use the **Calibration** screen to align the touch screen:

1. Remove the stylus from the stylus holder.
2. Carefully press and briefly hold the stylus tip on the center of the **Calibration** screen target. Repeat the procedure as the target moves and stops at different locations on the screen. This enters the new calibration settings.

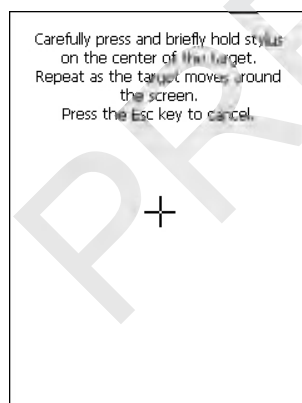

Figure 1-7 Calibration Screen

3. Once all of the new calibration settings are input, tap the screen or press the **ENTER** button to save the new calibration settings. Press **ESC** to discard the new calibration settings.

Main Battery Removal



CAUTION When removing the battery, follow the Safe Battery Swap procedures below otherwise loss of data or system corruption may occur.

When in Safe Battery Swap mode, the MC21XX goes into a low power suspend state. All wakeup are disabled.

To remove the main battery from an MC21XX:

1. If the MC21XX is in suspend mode, press the Power button to wake the MC21XX.
2. Press the Power button to place the MC21XX in suspend mode.
3. On the MC2180, tap **Safe Battery Swap**.
On the MC2100, using the navigation pad, scroll down to **Safe Battery Swap**. Press the **Enter** key.
4. Wait for the LED Indicator to turn red and then turn off.
5. Using thumbs, push the two battery latches up. The battery ejects slightly.

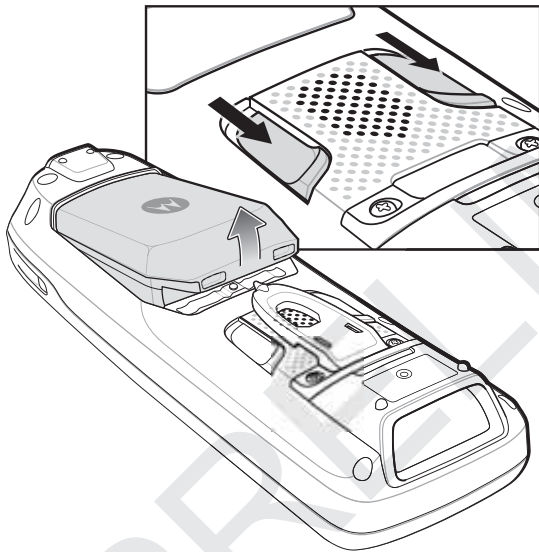

Figure 1-8 Release Latches

6. Remove the battery from the MC21XX.



CAUTION Replace the new battery within five minutes to prevent loss of data.

Turning Off the Radios

✓ **NOTE** MC2180 only.

WLAN Radio

To turn off the WLAN radio tap the **Fusion Signal Strength** icon on the task tray and select **Disable Radio**. An X appears in the icon indicating that the radio is disabled (off).



Figure 1-9 Fusion Signal Strength Icon

To turn the radio back on, tap the **Fusion Signal Strength** icon on the task tray and select **Enable Radio**. The X disappears from the icon indicating that the radio is enabled (on).

See [Chapter 5, Wireless Applications](#) for more information.

Safe System Shutdown/Re-boot

To ensure that data is not lost or that system corruption occurs, the user must follow the Safe Battery Swap procedure when replacing the battery. See [Main Battery Removal on page 1-8](#).

If the MC21XX stops responding first perform a warm boot. A warm boot maintains radio status and registry settings. Do not perform a cold boot unless necessary.

Performing a cold boot resets the MC21XX to factory defaults and loss of all registry settings.

To perform a warm boot, press and hold the Power button for five seconds.

PRELIMINARY

CHAPTER 2 OPERATION

Introduction

This chapter provides basic instructions for using the MC21XX and navigating the operating system software.

Power Button

Press the **Power** button to toggle the MC21XX between suspend and resume. When the screen is off the MC21XX is in suspend mode and when the screen is on the MC21XX is on.

Windows CE Sample Applications Window

The MC21XX contains a set of sample applications that can be installed. By default an installation icon is on the Desktop. Double-tap the icon to install the sample applications. When installed, the **Sample Applications** window appears on the screen whenever the MC21XX re-boots. Refer to the *MC21XX Series Mobile Computer Integrator Guide* for installation and configuration.

The **Sample Applications** window links to sample applications. The sample applications are intended to be used by application developers as application development examples. These applications were not developed to support end users. Refer to the *Application Guide for Motorola Enterprise Mobility Devices* for the *sample* applications.

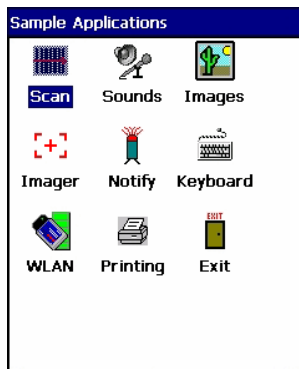

Figure 2-1 Sample Applications Window

Windows CE Desktop

The desktop displays the applications available with the Windows CE configurations. For information on using the Microsoft® applications refer to the *Microsoft® Applications for Mobile and CE 6.0 User Guide*, p/n 72E-78456-xx.

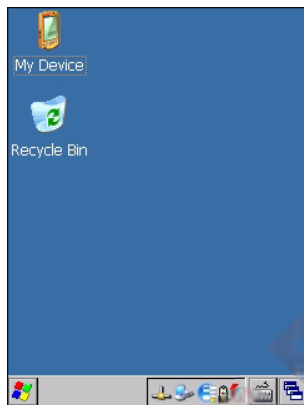

Figure 2-2 Windows CE Desktop

Using the Keypad to Navigate Applications

The MC2100 screen is a non-touch screen and therefore navigation and control of an application is performed using the keypad.

Key Combinations

The MC2100 uses special key combinations to easily navigate applications. [Table 2-1](#) lists the key combinations required to perform various application navigation and control.

Table 2-1 *Key Combinations*

Action	Key Combination
Access the Start menu on the Task bar	Press CTRL - ESC
Switch fields within an application	Press TAB
Close windows or cancel operations	Press ESC
Access the Task Manager	Press ALT - TAB
Minimize current window	Press ALT - ESC
Access a menu bar	Press ALT - CTRL
Press a button in an application window.	Press F - TAB until the button is highlighted. Press A - SPACE
Windows Explorer - Select All	CTRL - A
Windows Explorer - Cut	CTRL - X
Windows Explorer - Copy	CTRL - C
Windows Explorer - Paste	CTRL - V
Toggle IME mode on/off (Simplified Chinese only)	Press CTRL - SPACE

Selecting Items

Use a combination of key sequences to select items in a folder or list.

To select continuous items in a folder or list:

1. Open the folder or list.
2. Use the navigation pad to move to the first item to select.
3. Press Orange key to activate the alpha mode.
4. Press **SHIFT** - navigation pad (either up or down) to select the next item.
5. Repeat the **SHIFT** - navigation pad combination to select remaining items.
6. Perform the desired function (copy, paste, etc.).

To select multiple items in a folder or list:

1. Open the folder or list.
2. Press Orange key to activate the alpha mode.
3. Use the navigation pad to move to the first item.
4. Press **CTRL** - navigation pad to move within the list. The item name is outlined.
5. Repeat step 4 to move to the desired item.
6. Press **SPACE** to highlight the item.
7. Repeat steps 4 through 6 until all items are selected.
8. Perform the desired function (copy, paste, etc.).

Adjusting the Volume

To adjust the beeper volume on the MC2100 and the audio volume on the MC2180:

1. Press **Orange** key - **F1**. The volume control box appears.

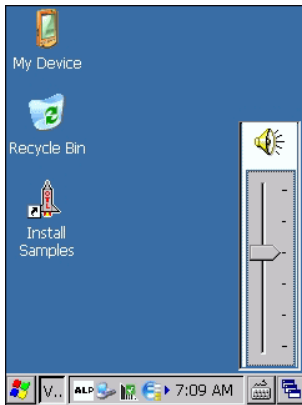

Figure 2-3 Volume Control Box

2. Use the navigation pad to adjust the volume.
3. After three seconds of inactivity, the settings are saved and the box disappears.

Adjusting the Screen Brightness

To adjust the screen brightness:

1. Press **Orange** key - **F2**. The brightness contrast control box appears.

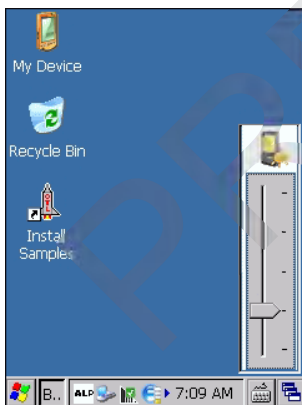

Figure 2-4 Brightness Control Box

2. Use the navigation pad to adjust the contrast.
3. After three seconds of inactivity, the settings are saved and the box disappears.

Windows CE Status Icons

The taskbar (at the bottom of the screen) displays the **Start** button, active programs and status icons. The taskbar icons are described in [Table 2-2](#). The taskbar icons display the function status, indicate what programs are active and indicate the battery charge status. The Taskbar buttons are used to access menus, select/deselect functions or to change display windows.

- **Status Icons:** The status icons indicate the function key status. If the **FUNC**, **SHIFT**, **CTRL**, **ALT** or **ALPHA** functions are active the appropriate status icon is displayed.
- **Active Programs Icons:** The active applications icons are displayed on the taskbar. If more than one program is active, icons can be used to toggle between the open programs (applications). Tap on a taskbar application to maximize the application.
- **AC Power/Battery Status Icons:** The AC Power/Battery Status icons are shown in the taskbar to indicate the present power supply status of the MC21XX. The main battery status icons provide the battery status in 10% increments from 10% to 100%. The backup battery low icon indicates that the backup battery charge is low. See [Battery Charging on page 1-5](#) for backup battery charging instructions.

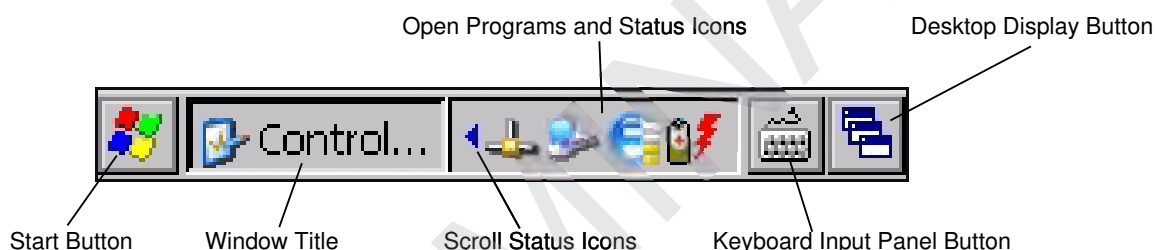











Figure 2-5 Taskbar

Table 2-2 Taskbar Icons

Icon	Description
	Clock: Indicates the current time.
	Battery: This icon indicates that the main battery is charging or that the terminal is operating on AC power. Double tapping on this icon opens the Power Properties window.
	Indicates that communication with the battery has not been established. After a MC21XX reset, this icon may be displayed for up to 30 seconds. See, Battery Unknown Icon on page 2-6 for additional information.
	Indicates that the backup battery is low.
	AC Plug: Indicates that the battery is fully charged and the MC21XX is running on external power.
	Battery: This icon indicates that the battery is fully charged (100% charged). The battery status icons provide the battery status in 10% increments from 10% to 100%.
	Serial Connection: It is displayed when the terminal is connected to a host computer with a serial cable.

Table 2-2 *Taskbar Icons (Continued)*

Icon	Description
	Wireless Connection Status: Indicates WLAN signal strength.
	DataWedge Running: Indicates that the DataWedge application is running.
	DataWedge Idle: Indicates that the DataWedge application is idle.
	Shift: Indicates that the Shift function is selected.
	Shift Lock: Indicates that the Shift Lock function is selected.
	Function: Indicates that the Function feature is selected.
	Function Lock: Indicates that the Function Lock feature is selected.
	CTRL: Indicates that the CTRL button function is selected.
	ALT: Indicates that the ALT character selection is selected.
	ALPHA: Indicates that the MC21XX is in ALPHA button mode is selected.
	Bluetooth:

Battery Unknown Icon

The **Battery Unknown** icon displays when communication with the smart battery has not been established. As part of normal operation this icon may be displayed for 30 seconds following a MC21XX reset.

If the icon displays beyond this 30 second period:

1. Remove and re-seat the battery.
2. If after re-seating the battery, the icon remains, warm boot the MC21XX.
3. If after warm booting the MC21XX, the icon remains, then cold boot the MC21XX.
4. If after cold booting the MC21XX, the icon remains, install a new (tested and working) battery.
5. If the icon remains, return the MC21XX for servicing.

Start Button

Tap the **Start** button to launch the **Start** menu.

- *Programs:* Use to access available programs.
- *Favorites:* Displays files in *Favorites* directory.
- *Documents:* Displays files in *Documents* directory.











- *Settings*: Accesses the Control Panel, the Network and Dial-up Connections and the Taskbar and *Start* menu.
- *Run*: Runs a program or application.
- *Suspend*: Places the MC21XX in the suspend state.

Programs Menu

✓ **NOTE** For the MC2100, see *Using the Keypad to Navigate Applications on page 2-2* for instruction on navigating using the navigation pad.

From the **Start** menu, tap **Programs** to open the **Programs** menu. The programs installed on the MC21XX with Windows CE display in the **Programs** menu. Refer to the *Application Guide for Motorola Enterprise Mobility Devices*, p/n 72-68901-xx and the *Microsoft® Applications for Mobile 6.1 and CE 6.0 User Guide*, p/n 72E-108299-xx for application information.

Table 2-3 Applications in the Programs Menu

Icon	Description	Icon	Description
	Communications Folder: Opens the Communication folder.		Fusion Folder: Open the Wireless Companion folder. See <i>Chapter 5, Wireless Applications</i> for more information.
	Command Prompt: Opens a DOS command prompt window.		CtlPanel: View and change MC21XX settings such as: Scanner Parameters, Display Settings, Audio Settings, Printer Settings, Date and Time Settings, Touch Screen Settings, etc.
	MSP Agent: Interacts with MSP agents to collect monitoring and asset information to enable the configuration, provisioning, monitoring and troubleshooting of the MC21XX. Refer to the <i>MC21XX Integrator Guide</i> for more information.		RhoElements Basic Browser: Browse Web and WAP sites.
	Rapid Deployment Client: Facilitates software downloads from a Mobility Services Platform Console FTP server to the MC21XX. Refer to the <i>MC21XX Integrator Guide</i> for more information.		TEAM Express Configuration - Opens the TEAM Express Configuration window.
	WarmBoot: Warm boots the MC21XX.		Windows Explorer: Organize and manage files on your device.

Control Panel

Table 2-4 lists the applications in the **Control Panel**.

Table 2-4 Programs on the Control Panel

Icon	Description	Icon	Description
	Backlight: Adjust the backlight brightness and power settings.		Bluetooth Device Properties: Launch the Bluetooth application.
	Certificates: See information about certificates installed on the MC21XX.		DataWedge: Sample scanning application. See Chapter 3, Data Capture for more information.
	Date/Time: Change date, time and time zone information.		Device Management: Enables downloading and installation of new software packages.
	Dialing: Set dialing properties for modem communication and change telephony settings.		Display: Change desktop background, appearance, backlight and brightness.
	Error Reporting: Choose whether to MC21XX collects software operation information to use if a serious error occurs.		Input Panel: Switch input methods and set input options.
	Keyboard: Change keyboard repeat delay and rate.		Mouse: Adjust double-click sensitivity for both the speed and timing.
	Network and Dial-up Connections: Connect to other computers, networks and the Internet using a modem.		Owner: Change owner's personal profiles.
	Password: Set a password for the MC21XX.		PC Connection: Change settings for connectivity of a host computer.
	Power: View and control MC21XX power settings.		Regional Settings: Change how numbers, currencies, dates and times appear.
	Remove Programs: Remove programs installed on the MC21XX.		Stylus: Calibrate the touch screen and adjust double-tap timing.
	System: View system information and change memory settings.		System Info: View information on the MC21XX's system components.
	USBConfig: Configure the MC21XX USB port.		Volume & Sounds: Select the type of actions for which to hear sounds and customize notifications for different events.

Keyboard Input Panel Button

On the MC2180, use the **Keyboard Input Panel** as an alternate input device. For more information, see [Entering Information Using the Keyboard Input Panel on page 2-12](#).

Desktop Display Button

On the MC2180, use the **Desktop Display** button to minimize all open programs and display the desktop.

Task Manager and Properties

Use the **Task Manager** to control an application's use and use the **Properties** functions to set display and clock options.

Task Manager

1. Press Blue key - **CTRL** (to activate the **ALT** state) then press **TAB** to display the **Task Manager**.

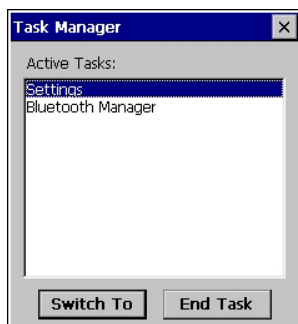

Figure 2-6 Task Manager Window

2. Select a task in the **Active Tasks** list and select **Switch To** to make that task the primary task, or select **End Task** to end the selected task.
3. Tap **X** or press **ESC** to exit the **Task Manager** window.

Properties

1. Select **Start > Settings > Taskbar and Start Menu ...**. The **Task Bar and Start Menu** window displays.

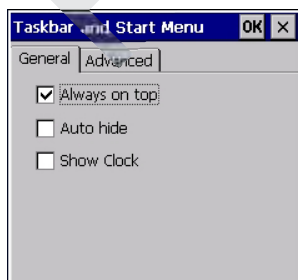

Figure 2-7 Taskbar and Start Menu - General Tab

2. This menu provides taskbar options:
 - Check the **Always on Top** checkbox to keep the taskbar on top of all other windows.

- Check the **Auto hide** checkbox to make the taskbar disappear, touch the bottom of the display to make the taskbar return.
 - Check the **Show Clock** checkbox to display the clock on the taskbar.
3. Select **OK** to save the settings and exit the window.

Advanced Tab

1. Select the **Advanced** tab.
2. Select the **Clear** button to delete all of the documents listed in the **Start > Documents** entry, see [Start Button on page 2-6](#). Typically this list is empty, but if there were documents in the list the **Clear** button would delete them.
3. Select the **Expand Control Panel** checkbox to display the entire contents of the Control Panel in list form, rather than icons.



Figure 2-8 *Taskbar and Start Menu, Advanced Tab*

4. Select **OK** to save the settings and exit the window.

Stylus

To remove the stylus, Lift the point end of the stylus up and slide it out of the bar.

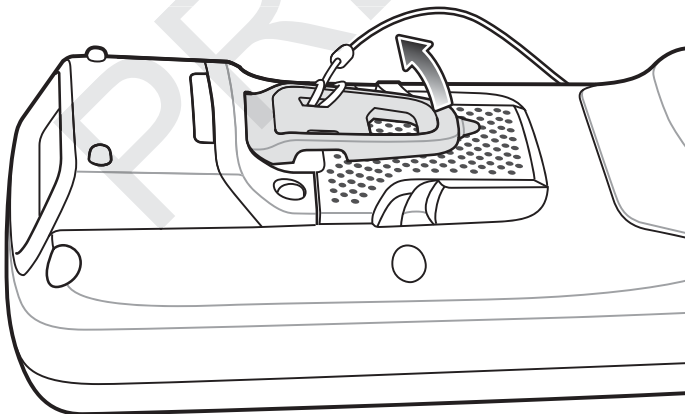

Figure 2-9 *Mini Stylus Removal*

To store the stylus, slide the flat end of the stylus under the bar and then lower to the back of the MC21XX.

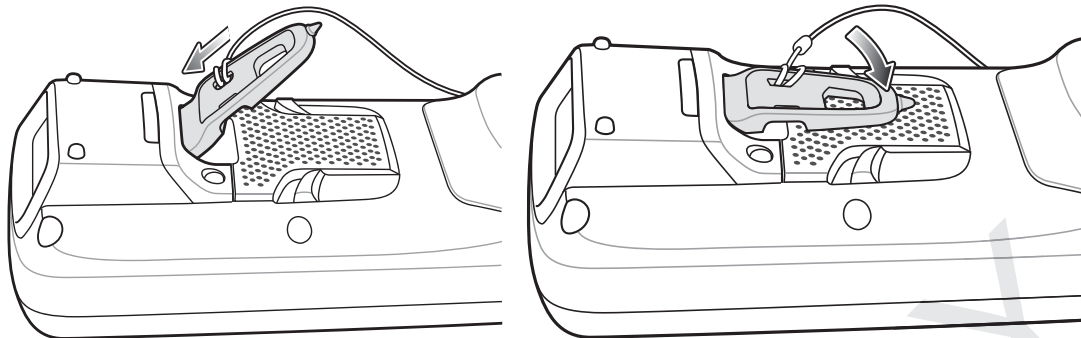

Figure 2-10 *Mini Stylus Installation*

Use the stylus for selecting items and entering information on the screen. The stylus functions as a pen and a mouse. Tap the touch screen once with the stylus to select options and open menu items.

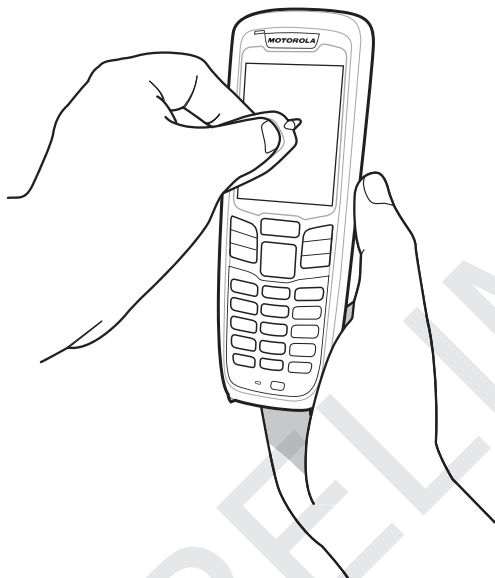

Figure 2-11 *Using the Stylus*

Entering Information

To enter information:

- Use the keypad.
- Use the keyboard input panel (soft keyboard) to enter text.
- Scan bar code data into data fields.
- Use Microsoft® ActiveSync® or Windows Mobile Device Center (WMDC) to synchronize or copy information from the host computer to the MC21XX. For more information on ActiveSync and WMDC, refer to the *MC21XX Series Mobile Computer Integrator Guide*.

Entering Information Using Keypad

The alphanumeric keypad produce the 26-character alphabet (A - Z), numbers (0 - 9), function keys and assorted characters. The keypads default characters/functions are printed white, the **ALPHA** character/functions are printed orange and the functions are printed blue. See [Appendix B, Keypad](#) for keypad special functions and special character generation.

Entering Information Using the Keyboard Input Panel

✓ **NOTE** MC2180 only.

Use the keyboard input panel (soft keyboard) to enter information in any program. To launch the keyboard input panel, tap the  button on the taskbar and then tap **Keyboard**. Tap a key to enter the value. Tap the keyboard input panel button to display or to hide the keyboard input panel.

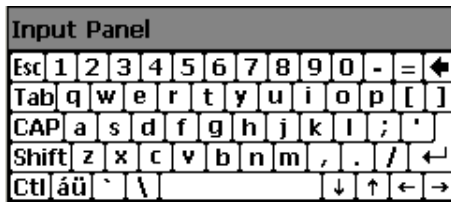

Figure 2-12 Keyboard Input Panel

Entering Data via the Bar Code Scanner

The sample bar code scanner application scans data into data fields in the same way data is entered via the keypad.

Resetting the MC21XX

If the MC21XX stops responding to input, reset it. There are two reset functions, warm boot and cold boot. A warm boot restarts the MC21XX by closing all running programs. All data that is not saved is lost.

A cold boot also restarts the MC21XX, but erases all stored records and entries from RAM. In addition it returns formats, preferences and other settings to the factory default settings.

Perform a warm boot first. If the MC21XX still does not respond, perform a cold boot.

Performing a Warm Boot

To perform a warm boot:

1. Press the **Power** button for five seconds.
2. The MC21XX reboots.



CAUTION Files that remain open during a warm boot may not be retained.

Performing a Cold Boot

A cold boot restarts the MC21XX and erases all user stored records and entries from RAM. *Never perform a cold boot unless a warm boot does not solve the problem.*



CAUTION Cold boot resets the MC21XX, to the default settings. All added applications and all stored data are removed. Do not cold boot without support desk approval.

To perform a cold boot:

1. If the MC21XX is in suspend mode, press the Power button to wake the MC21XX.
2. Press the Power button to place the MC21XX in suspend mode.
3. On the MC2180, tap **Safe Battery Swap**.
On the MC2100, using the navigation pad, scroll down to **Safe Battery Swap**. Press the **Enter** key.
4. Wait for the LED Indicator to turn red and then turn off.
5. Simultaneously press and then release the **1**, **9** and **Power** keys. Do not hold down any other keys or buttons. As the MC21XX initializes, the splash window, *Figure 1-10 on page 1-10*, appears for about a minute.
6. Calibrate the touch screen. See *Calibration Screen on page 1-10* to calibrate the MC21XX screen.

Waking the MC21XX

The wakeup conditions define what actions wake up the MC21XX after it has gone into suspend mode. The MC21XX can go into suspend mode by either pressing the Power button or automatically by Control Panel time-out settings. These settings are configurable and the factory default settings are shown in *Table 2-5*.

Table 2-5 Wakeup Default Settings

Condition for Wakeup	Power Button	Automatic Time-out
AC power is applied.	Yes	Yes
MC21XX is connected to a USB cable.	Yes	Yes
A key is pressed.	No	Yes
The scan triggered is pressed.	Yes	Yes
The screen is touched (MC2180 only).	No	No
USB Host	No	No

To access the Wakeup settings:

Select **Start > Settings > Control Panel > Power** icon > **Wakeup** tab.

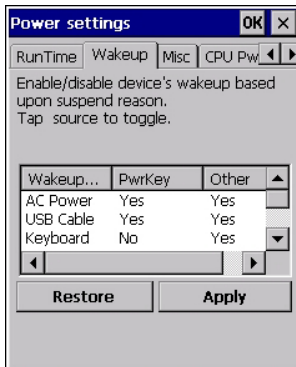

Figure 2-13 Power Settings - Wakeup Tab

Battery Health

The health of the battery can be viewed on the MC21XX Power applet. Select **Start > Settings > Power icon > BatteryMgmt** tab.

Table 2-6 BatteryMgmt Window

Item	Description
State of Health	Indicates the current state of the battery (Healthy or Unhealthy).
Battery Usage Indicator	Indicates the usage of the battery.
Battery Usage Threshold	Indicates the usage indicator threshold.
Battery Serial #	Displays the serial number of the battery.

For information on changing the Battery Usage Threshold, refer to the *MC21XX Series Integrator Guide*.

Using the Keypad

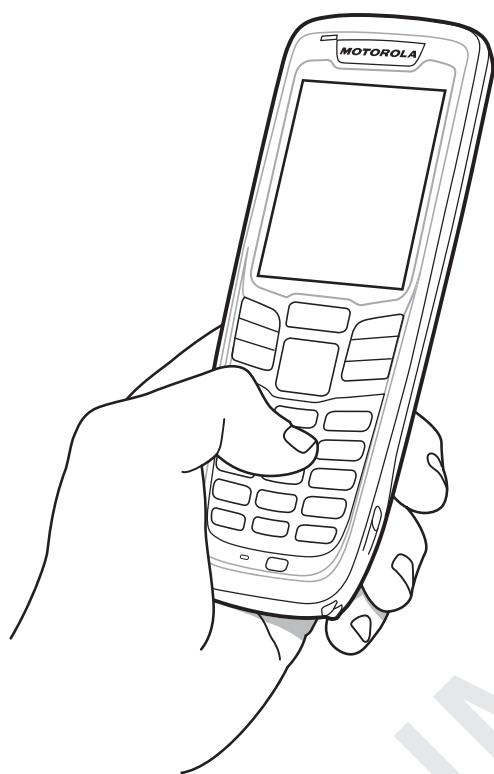

Single-hand Method

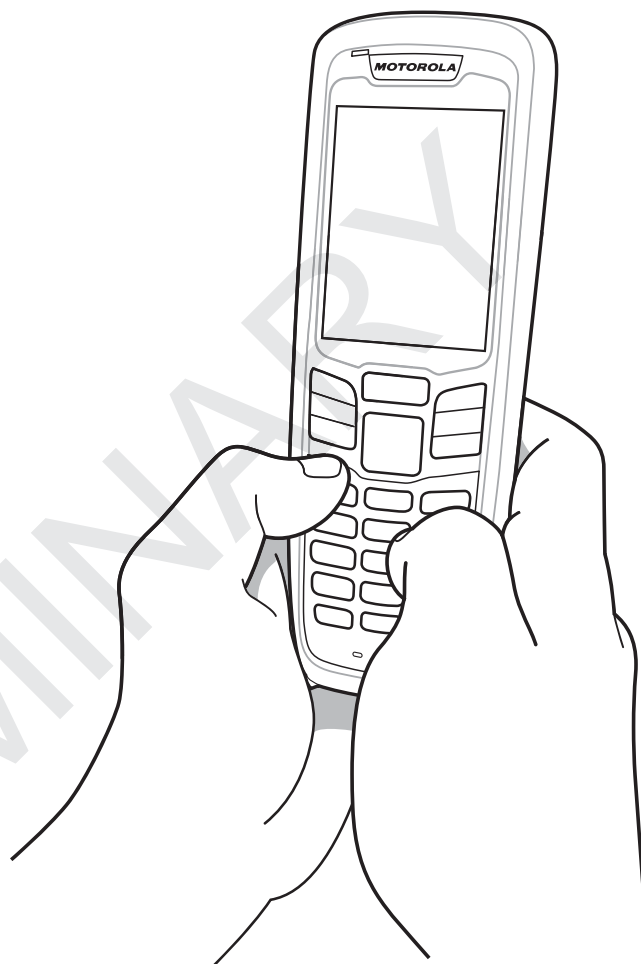

Two-hand Method

Figure 2-14 *Entering Data on the Keypad*

Browser

✓ **NOTE** MC2180 only.

To use the browser:

Tap **Start > Programs > Neon 1**. The browser window appears.

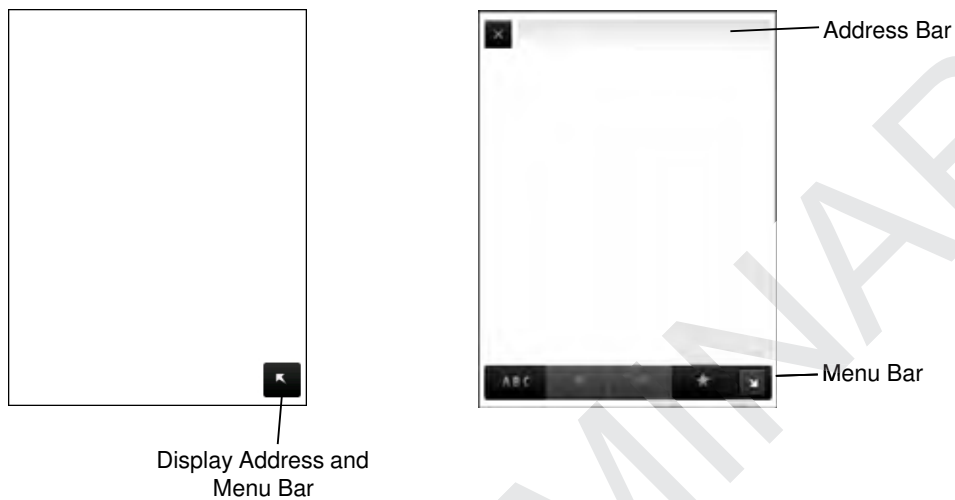

Figure 2-15 *Browser*

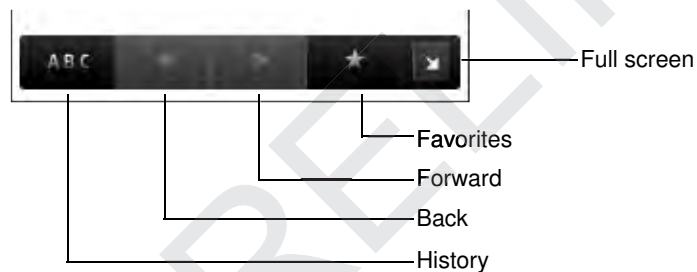

Figure 2-16 *Menu Bar*

1. Enter an address into the Address Bar.
2. Press the **Enter** key. The web page loads.

Installation

To install TEAM Client:

1. Tap **Start > Programs > TEAM Client Configuration**.
2. Follow the on-screen prompts.
3. Warm boot the MC2180.

Group Broadcast Communication Buttons

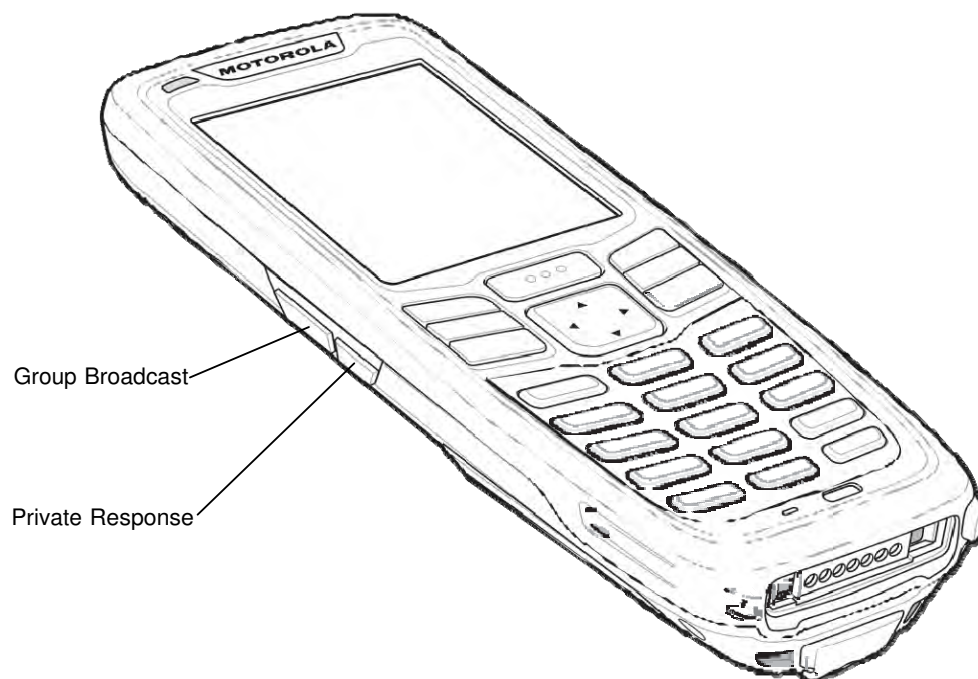

Figure 2-17 MC2180 TEAM Express Button Assignment

- **Group Broadcast:** Press and hold to start communicating with other voice client users or to make a Private Response.
- **Private Response:** Press and hold to respond to the originator of the last broadcast.

PRELIMINARY

CHAPTER 3 DATA CAPTURE

Introduction

The MC21XX provides three types of data capture options:

- linear imager
- 1D laser scanner
- 2D imager (MC2180 only).

Linear Imager

The MC21XX with an integrated linear CCD imager has the following features:

- Reading of a variety of bar code symbologies, including the most popular linear, postal and 1-D code types.
- Intuitive aiming for easy point-and-shoot operation.

1D Laser Scanner

The MC21XX with an integrated 1D laser scanner has the following features:

- Reading of a variety of bar code symbologies, including the most popular linear, postal and 1-D code types.
- Intuitive aiming for easy point-and-shoot operation.

2D Imaging

The MC21XX with an integrated 2D imager has the following features:

- Omnidirectional (360°) reading of a variety of bar code symbologies, including the most popular linear, postal, PDF417, and 2D matrix code types.
- The ability to capture and download images to a host for a variety of imaging applications.
- Advanced intuitive laser aiming for easy point-and-shoot operation.

The imager uses digital camera technology to take a digital picture of a bar code, stores the resulting image in its memory, and executes state-of-the-art software decoding algorithms to extract the data from the image.

Operational Modes

The MC21XX with an integrated imager support three modes of operation, listed below. Activate each mode pressing the **Scan** button.

- **Decode Mode:** In this mode, the MC21XX attempts to locate and decode enabled bar codes within its field of view. The imager remains in this mode as long as the scan button is pressed, or until it decodes a bar code.

✓ **NOTE** To enable Pick List Mode, tap **Start > Programs > CtIPanel**. Select **Scanner Settings > Reader Parameters**. Enable **Pick List** mode. Pick List can also be set in an application using a API command.

- **Pick List Mode:** This mode allows selective bar code decoding when more than one bar code is in the MC21XX's field of view. To accomplish this, move the aiming crosshair center dot over the required bar code to decode only that bar code. This feature is ideal for pick lists containing multiple bar codes and manufacturing or transport labels containing more than one bar code type (either 1D or 2D).
- **Image Capture Mode:** Use this mode to capture an image within the MC21XX's field of view. This is useful for capturing signatures or images of items like damaged boxes.

Scanning Considerations

Scanning consists of; aim, scan and decode. Scanning performance can be optimized by considering the range and the scanning angle:

- Range

Any scanning device decodes well over a particular working range (minimum and maximum distances from the bar code). This range varies according to bar code density and scanning device optics.

Scanning within range brings quick and constant decodes; scanning too close or too far away prevents decodes. Move the scanner closer and further away to find the right working range for the bar codes being scanned. However, the situation is complicated by the availability of various integrated scanning modules. The best way to specify the appropriate working range per bar code density is through a chart called a decode zone for each scan module. A decode zone simply plots working range as a function of minimum element widths of bar code symbols.

- Angle

The scan angle is important for optimizing decode performance. When laser beams reflect directly back into the scanner from the bar code, this specular reflection can "blind" the scanner.

To avoid this, scan the bar code so that the beam does not bounce directly back. But do not scan at too sharp an angle; the scanner needs to collect scattered reflections from the scan to make a successful decode. Practice quickly shows what tolerances to work within.

✓ **NOTE** Contact the Motorola Enterprise Mobility Support Center if chronic scanning difficulties develop. Decoding of properly printed bar codes should be quick and effortless.

Laser Scanning and Linear Imaging

To scan bar codes with the MC21XX:

1. Ensure that the MC21XX is loaded with a scanning application. See *DataWedge on page 3-5* for more information.
2. If the MC21XX is equipped with a rotating head, adjust the head prior to scanning.
3. Aim the scan window at the bar code.

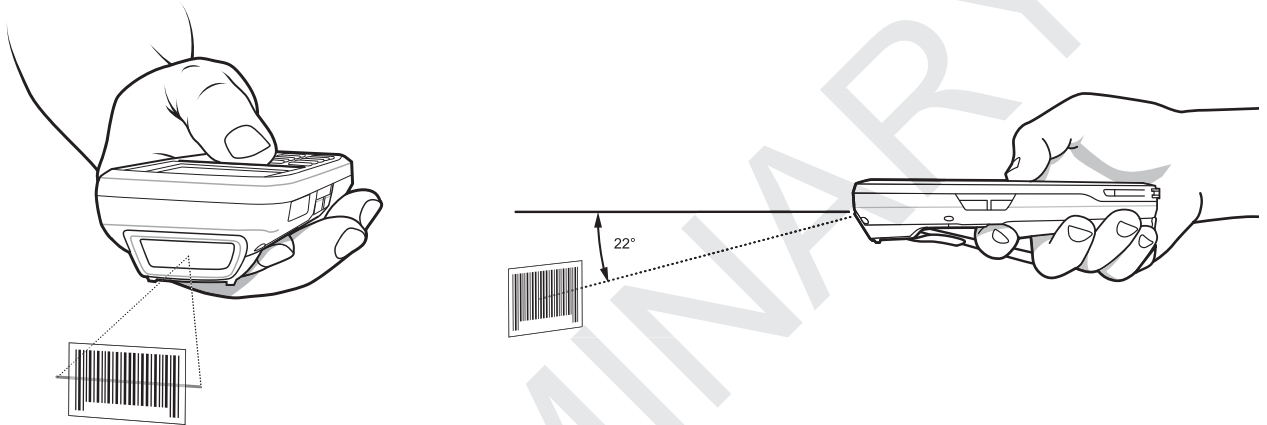

Figure 3-1 *Data Capture*

4. Press the scan button. Ensure the red scan beam covers the entire bar code. The LED Indicators illuminate red to indicate that the beam is on. The LED Indicator turns green and a beep sounds to indicate a successful decode.



Figure 3-2 *Laser Aiming*

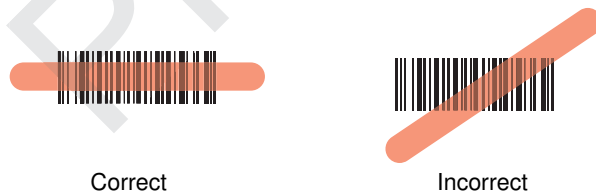

Figure 3-3 *Linear Aiming*

Optimal scanning distance varies with bar code density and scanner optics.

- Hold the scanner farther away for larger symbols.
- Move the scanner closer for symbols with bars that are close together.

- ✓ **NOTE** Scanning procedures depend on the application and MC21XX configuration. An application may use different scanning procedures from the one listed above.

Imager Scanning

To read a bar code, a scan-enabled application is required. The MC21XX contains the DataWedge application that allows the user to enable the scanner to decode bar code data and display the bar code content.

1. Ensure that a scan-enabled application is loaded on the MC21XX. See [DataWedge on page 3-5](#) for more information.
2. Aim the exit window at the bar code.
3. Press the scan button.

The red laser aiming pattern or aiming dot turns on to assist in aiming. Ensure the bar code is within the area formed by the brackets in the aiming pattern or close to the aiming dot. The aiming dot is used for increased visibility in bright lighting conditions.

The Scan/Decode LED lights red to indicate that scanning is in process, then lights green and a beep sounds, by default, to indicate the bar code was decoded successfully. Note that when the MC2180 is in Pick List Mode, the imager does not decode the bar code until the crosshair or aiming dot touches the bar code.



Figure 3-4 Imager Aiming Pattern: Bar Code Centered



Figure 3-5 Imager Aiming Pattern: Bar Code Not Centered



Figure 3-6 Pick List Mode with Multiple Bar Codes in Aiming Pattern

4. Release the scan button.



NOTE Imager decoding usually occurs instantaneously. The MC2180 repeats the steps required to take a digital picture (image) of a poor or difficult bar code as long as the scan button remains pressed.

DataWedge

Enable DataWedge

To enable DataWedge:

1. Tap **Start > Settings > Control Panel > DataWedge**.
2. Tap Running to start the DataWedge process. The **DataWedge Status** changes to **Ready**.
3. Tap **OK**.

Disable DataWedge

To disable DataWedge:

1. Tap **Start > Settings > Control Panel > DataWedge**.
2. Tap the Running option to end the DataWedge process. The **DataWedge Status** changes to **Stopped**.
3. Tap **OK**.

Adjusting the Scan Beeper Volume

The volume level of the scan beep can be changed programmatically using APIs or using applications on the MC21XX.

Using CtlPanel

To change the beep volume using the CtlPanel application:

1. Select **Start > Programs > CtlPanel**.
2. Select **Audio Settings**.
3. Use the navigation pad to change **Beeper Volume**. Select a value between 0 and 3 where 0 is the lowest and 3 the highest.
4. Select **OK**.
5. Select **Exit**.

Using DataWedge

When using **DataWedge**, the beep volume can only be changed using the **DataWedge** setting.

1. Select **Start > Settings > Control panel > DataWedge**.
2. Select **3. Basic format**.
3. Select **2. Keystroke output**.

4. Select **5. Feedback.**
5. Select **2. On Send.**
6. Select **1. Beeper.**
7. Select **4. Volume.**
8. Enter a value between 0 and 3 where 0 is the lowest and 3 the highest.
9. Select **Save.**

PRELIMINARY

Chapter 4 Bluetooth

Introduction

✓ **NOTE** MC2180 only.

Bluetooth-equipped devices can communicate without wires, using frequency-hopping spread spectrum (FHSS) radio frequency (RF) to transmit and receive data in the 2.4 GHz Industry Scientific and Medical (ISM) band (802.15.1). Bluetooth wireless technology is specifically designed for short-range (10 meters /30 feet) communication and low power consumption.

MC2180s with Bluetooth capabilities can exchange information (e.g., files, appointments, and tasks) with other Bluetooth enabled devices such as phones, printers, access points, and other mobile computers. To use the MC2180 as a modem, create a dial-up modem connection between a computer and MC2180.

The MC2180 with Bluetooth technology uses the Microsoft Bluetooth stack.

Adaptive Frequency Hopping

Adaptive Frequency Hopping (AFH) is a method of avoiding fixed frequency interferers, and can be used with Bluetooth voice. All devices in the piconet (Bluetooth network) must be AFH-capable in order for AFH to work. There is no AFH when connecting and discovering devices. Avoid making Bluetooth connections and discoveries during critical 802.11b communications. AFH for Bluetooth consists of four main sections:

- Channel Classification - A method of detecting an interference on a channel-by-channel basis, or pre-defined channel mask.
- Link Management - Coordinates and distributes the AFH information to the rest of the Bluetooth network.
- Hop Sequence Modification - Avoids interference by selectively reducing the number of hopping channels.
- Channel Maintenance - A method for periodically re-evaluating the channels.

When AFH is enabled, the Bluetooth radio "hops around" (instead of through) the 802.11b high-rate channels. AFH coexistence allows Motorola mobile computers to operate in any infrastructure.

The Bluetooth radio in this MC2180 operates as a Class 2 device power class. The maximum output power is 2.5mW and the expected range is 32.8 feet (10 meters). A definition of ranges based on power class is difficult to obtain due to power and device differences, and whether one measures open space or closed office space.



NOTE It is not recommended to perform Bluetooth wireless technology inquiry when high rate 802.11b operation is required.

Security

The current Bluetooth specification defines security at the link level. Application-level security is not specified. This allows application developers to define security mechanisms tailored to their specific need. Link-level security occurs between devices, not users, while application-level security can be implemented on a per-user basis. The Bluetooth specification defines security algorithms and procedures needed to authenticate devices, and if needed, encrypt the data flowing on the link between the devices. Device authentication is a mandatory feature of Bluetooth while link encryption is optional.

Pairing of Bluetooth devices is accomplished by creating an initialization key that is used to authenticate the devices and create a link key for them. Entering a common PIN number in the devices being paired generates the initialization key. The PIN number is never sent over the air. By default, the Bluetooth stack responds with no key when a key is requested (it is up to user to respond to the key request event). Authentication of Bluetooth devices is based-upon a challenge-response transaction. Bluetooth allows for a PIN number or passkey that is used to create other 128-bit keys used for security and encryption. The encryption key is derived from the link key used to authenticate the pairing devices. Also worthy of note is the limited range and fast frequency hopping of the Bluetooth radios that makes long-distance eavesdropping difficult.

Recommendations are:

- Perform pairing in a secure environment
- Keep PIN codes private and don't store the PIN codes in the mobile computer
- Implement application-level security.

The Microsoft stack supports Smart-pairing. For detailed information, refer to the Microsoft MSDN.

Bluetooth Configuration

The services supported by the Microsoft Bluetooth stack:

- Generic Access Profile
- Serial Port Service
- Service Discovery Access Profile
- Dial-Up Networking Profile (Client)

COM5 and COM9 ports are available for the Microsoft Bluetooth stack.

Bluetooth Power States

Cold Boot

Performing a cold boot turns off the state of the Bluetooth radio.

Warm Boot

Performing a warm boot turns off the state of the Bluetooth radio.

Suspend

When there is an active Bluetooth connection, the Bluetooth radio goes into low power mode maintaining the active connection. When there is no active connection, the Bluetooth radio turns off.

Resume

When the MC2180 resumes, the user must re-connect to the Bluetooth device.

Using Microsoft Bluetooth Stack

The following sections provide information on using the Microsoft Bluetooth stack.

Power Modes

The Bluetooth radio switches between normal and low power modes automatically. When data transfer is required, the radio goes into normal mode. When there is no activity, the radio goes into low power mode.

Discovering Bluetooth Device(s)

The MC2180 can receive information from discovered devices without bonding. However, once bonded, the MC2180 and a bonded device exchange information automatically when you turn the Bluetooth radio on.

To find Bluetooth devices in the area:

1. Ensure that Bluetooth is enabled on the device.
2. Ensure that the Bluetooth device to discover is in discoverable and connectable modes.
3. Ensure that the two devices are within 10 meters (30 feet) of one another.
4. Tap **Start > Settings > Control Panel > Bluetooth Device Properties** icon.



Figure 4-1 Bluetooth Manager

5. Tap **Enable Bluetooth**.
6. Tap **Scan Device** button. The MC2180 begins searching for discoverable Bluetooth devices in the area. Discovered devices appear in the list.



Figure 4-2 Searching for Bluetooth Devices

7. Double tap a device from the list.

8. Select **Trusted**. A dialog box appears.
9. Tap **Yes**. The **Bluetooth** window appears.



Figure 4-3 Enter PIN

10. Enter a PIN and then tap **OK**.
11. Enter the PIN on the other device. The device in the list become trusted (key icon).
You are prompted to enter a PIN. If the device has a specific PIN, enter it in the PIN field and tap Next. If the device does not have a specific passcode, enter one in the Passcode field and tap Next. The Bluetooth radio tries to connect with the device.
12. If you created a passcode, you will be prompted by the other device to enter the same passcode. Enter the created passcode to establish a paired connection. (If you entered a passcode from the device, you shouldn't have to do anything on the other device.)
13. When the connection is complete, a list of matching and supported services on the device appears.
14. Select the services you want to use and tap **Finish**. The services on the new devices have to be selected or else the pairing won't include those services, even though the devices are paired. If services are not selected, you will be continually re-prompted for the passcode from the device.
15. The device appears in the list on the main window.

After the passcodes have been accepted on both sides, you have a trusted ("paired") connection.

- ✓ **NOTE** Some devices might not require a PIN. This depends upon the device's authentication.

Available Services

- ✓ **NOTE** In order to connect to the Bluetooth device, the application must create the connection to the remote device. Please refer to the MSDN Help for detailed information.

The MC2180 with Microsoft Bluetooth stack offers the Serial Port service and DUN Client service.

PRELIMINARY

CHAPTER 5 WIRELESS APPLICATIONS

Introduction

- ✓ **NOTE** MC2180 only.

Wireless Local Area Networks (LANs) allow mobile computers to communicate wirelessly and send captured data to a host device in real time. Before using the MC21XX on a WLAN, the facility must be set up with the required hardware to run the wireless LAN and the MC21XX must be configured. Refer to the documentation provided with the access points (APs) for instructions on setting up the hardware.

- ✓ **NOTE** 802.11d is enabled by default. When enabled, the AP must be configured the same in order to connect.

To configure the MC21XX, a set of wireless applications provide the tools to configure and test the wireless radio in the MC21XX. Refer to the *Wireless Fusion Enterprise Mobility Suite User Guide for Version X1.00* for information on configuring wireless profiles. Go to <http://www.motorola.com/enterprisemobility/manuals> for the latest version of this guide. See *Software Versions on page ii* to determine the Fusion version on the MC21XX.

Tap the **Signal Strength** icon to display the **Wireless Launcher** menu.

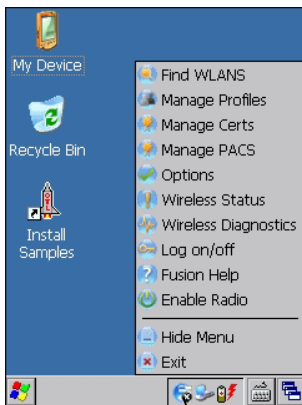

Signal Strength Icon

Figure 5-1 Wireless Launcher Menu

Many of the items in the menu invoke one of the Fusion applications. These menu items and their corresponding applications are summarized in [Table 5-1](#).

Table 5-1 Supported Applications

Application	Description
Find WLANs	Invokes the Find WLANs application which displays a list of the WLANs available in your area.
Manage Profiles	Invokes the Manage Profiles application (which includes the Profile Editor Wizard) to manage and edit your list of WLAN profiles.
Manage Certs	Invokes the Certificate Manager application which allows you to manage certificates used for authentication.
Manage PACs	Invokes the PAC Manager application which helps you manage the list of Protected Access Credentials used with EAP-FAST authentication.
Options	Invokes the Options application which allows you to configure the Fusion option settings.
Wireless Status	Invokes the Wireless Status application which allows you to view the status of the current wireless connection.
Wireless Diagnostics	Invokes the Wireless Diagnostics application which provides tools with which to diagnose problems with the wireless connection.
Log On/Off	Invokes the Network Login dialog which allows you to log on to a particular profile or to log off from the currently active profile.
Fusion Help	Invokes Fusion Help application which provides on-device Fusion Help.







Additional **Wireless Launcher** menu entries include:

- Enable/Disable Radio
- Hide Menu
- Exit.

Signal Strength Icon

The **Signal Strength** icon in the task tray indicates the mobile computer's wireless signal strength as follows:

Table 5-2 *Signal Strength Icons Descriptions*

Icon	Status	Action
	Excellent signal strength	WLAN network is ready to use.
	Very good signal strength	WLAN network is ready to use.
	Good signal strength	WLAN network is ready to use.
	Fair signal strength	WLAN network is ready to use. Notify the network administrator that the signal strength is only "Fair".
	Poor signal strength	WLAN network is ready to use. Performance may not be optimum. Notify the network administrator that the signal strength is "Poor".
	Out-of-network range (not associated)	No WLAN network connection. Notify the network administrator.
	The WLAN radio is disabled.	The WLAN radio is disabled. To enable, choose Enable Radio from the Wireless Applications menu.
None	The Wireless Launcher application was exited.	The Wireless Launcher application has been closed. See the Fusion Functions paragraphs below for how to restart the Wireless Launcher .

Turning Off the Radio

To turn off the **WLAN** radio tap the **Signal Strength** icon on the task tray and select **Disable Radio**. A red X appears across the icon indicating that the radio is disabled (off).

To turn the radio back on, tap the **Signal Strength** icon on the task tray and select **Enable Radio**. The red X disappears from the icon indicating that the radio is enabled (on).

Minimum Setup

Below is a list of the minimum effort to achieve a wireless connection. Note that there are many discrete nuances that may affect the performance of your wireless connection that might be missed if you do not consider them carefully.

You will need to create a profile. It is recommended that you read the profile editor chapter.

1. Find out from your IT administrator what the connection settings should be (Extended Service Set Identifier (ESSID), Enterprise or Personal, authentication type, tunnel type, certificate requirements, Protected Access Credentials (PAC) requirements). Note that not all of the items listed may be relevant.
2. Create the profile using the information provided by the IT administrator.

3. Enter the **Manage Profile** screen, select the profile (press and hold), and select the **Connect** option in the context menu that appears.

PRELIMINARY

Chapter 6 Accessories

Introduction

The MC21XX accessories provide a variety of product support capabilities. Accessories include cradles, cables and spare battery chargers. [Table 6-1](#) lists the MC21XX accessories.

Table 6-1 MC21XX Accessories

Accessory	Part Number	Description
Cradles		
Single-slot USB Cradle	CRD2100-1000UR	Charges the MC21XX main battery and synchronizes the MC21XX with a host computer through a USB connection.
Four-slot Charge Only Cradle	CRD2100-4000CR	Charges up to four MC21XXs.
Four-slot Ethernet Cradle	CRD2100-4000ER	Charges up to four MC21XXs and connects to the MC21XX with an Ethernet network.
Charging		
Four-slot Spare Battery Charger	SAC2100-4000CR	Charges up to four MC21XX spare batteries.
Power Supply	PWRS-14000-249R	Provides power to the MC21XX, Single-slot USB Cradle and the USB ActiveSync/Charge cable.
Power Supply	PWRS-14000-148R	Provides power to the Four-slot Charge Only Cradle and the Four-slot Ethernet cradle.
Power Supply	PWRS-14000-241R	Provides power to the Four-slot Spare Battery Charger.
DC Line Cord	50-16002-042R	Provides power from the power supply to the Four-slot Ethernet cradle or Four-slot Charge Only cradle.
US AC Line Cord	50-16000-182R	Provides power to the 2-wire power supply.

Table 6-1 MC21XX Accessories (Continued)

Accessory	Part Number	Description
International AC Line Cord	-	Provides power to the 2-wire power supply. Purchase separately.
US AC Line Cord	23844-00-00R	Provides power to the 3-wire power supply.
International AC Line Cord	-	Provides power to the 3-wire power supply. Purchase separately.
Cables		
USB ActiveSync/Charge Cable	25-154073-01R	Provides USB client communication capabilities and charges the MC21XX.
USB Cable	25-68596-01R	Provides USB communication through the Single-slot USB cradle.
Soft Goods		
Handstrap	SG-MC2123225-01R	Replacement handstrap.
Holster	SG-MC2121205-01R	Provides a soft, clip on holder and a shoulder strap for the MC21XX.
Lanyard	SG-MC2127225-01R	Optional lanyard for holding the MC21XX.
Miscellaneous		
Modem Dongle	MDM9000-100R	Provides modem connectivity through the MC21XX and Modem Adapter Cable.
Modem Adapter Cable	25-154074-01R	Connects Modem Dongle to the MC21XX.
2400 mAh Battery	BTRY-MC21EAB0E	Replacement battery.
Stylus	11-42794-03R	Replacement stylus (3-pack).
Tether	TBS	Replacement tether (3-pack).
Screen protector	TBS	Replacement screen protectors (3-pack).

Single-slot USB Cradle



CAUTION Ensure that you follow the guidelines for battery safety described in *Battery Safety Guidelines on page 7-2*.

The Single-slot USB cradle:

- Provides 5.4VDC power for operating the MC21XX and charging the battery.
- Provides a USB port for data communication between the MC21XX and a host computer.
- Provides USB host communications between the MC21XX and a peripheral device.

Battery Charging

The Single-slot USB cradle can charge the MC21XX main battery. To charge the MC21XX:

1. Slide the MC21XX into the slot. The MC21XX LED Indicator indicates the MC21XX battery charging status. The battery charges in approximately four hours. See *Table 1-1 on page 1-6* for charging status indications.

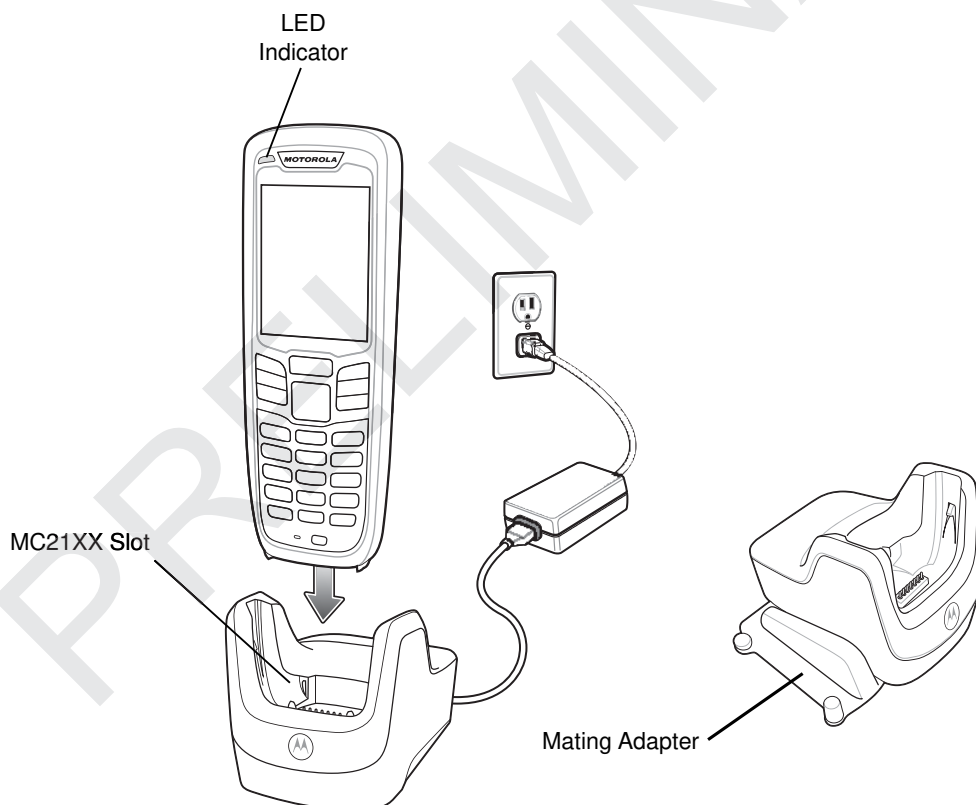

Figure 6-1 Single-slot USB Cradle

2. When charging is complete remove the MC21XX from the cradle.

Each Single-slot USB cradle comes with a mating adapter. Use the mating adapter to connect two or more cradles together. Each cradle still requires a power supply.

Four-slot Charge Only Cradle



CAUTION Ensure that you follow the guidelines for battery safety described in *Battery Safety Guidelines on page 7-2*.

The Four-slot Charge Only cradle:

- Provide 5.4 VDC power for operating the MC21XX and charging the battery.
- Simultaneously charges up to four MC21XXs.

Battery Charging

The Four-slot Charge Only cradle can charge up to four MC21XXs simultaneously. To charge the MC21XX:

1. Slide the MC21XX into the cradle slot.

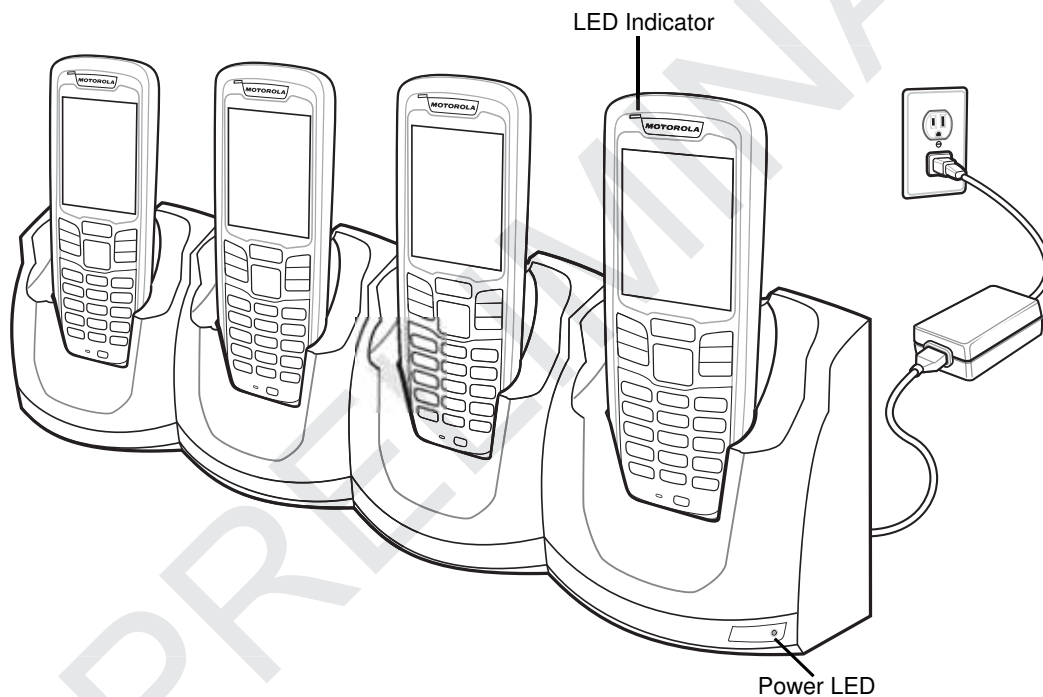

Figure 6-2 Four-slot Charge Only Cradle

2. The MC21XX LED Indicator indicates the MC21XX battery charging status. The battery usually charges in approximately four hours. See *Table 1-1 on page 1-6* for charging status indications.
3. When charging is complete, remove the MC21XX from the cradle.

Power LED

The green Power LED lights to indicate that the Four-slot Charge Only cradle is connected to a power source.

Four-slot Ethernet Cradle



CAUTION Ensure that you follow the guidelines for battery safety described in [Battery Safety Guidelines on page 7-2](#).

The Four-slot Ethernet cradle:

- Provide 5.4 VDC power for operating the MC21XX and charging the battery.
- Simultaneously charges up to four MC21XXs.
- Connects the MC21XX to an Ethernet network.

Battery Charging

The Four-slot Ethernet cradle can charge up to four MC21XXs simultaneously. To charge the MC21XX:

1. Slide the MC21XX into the cradle slot.

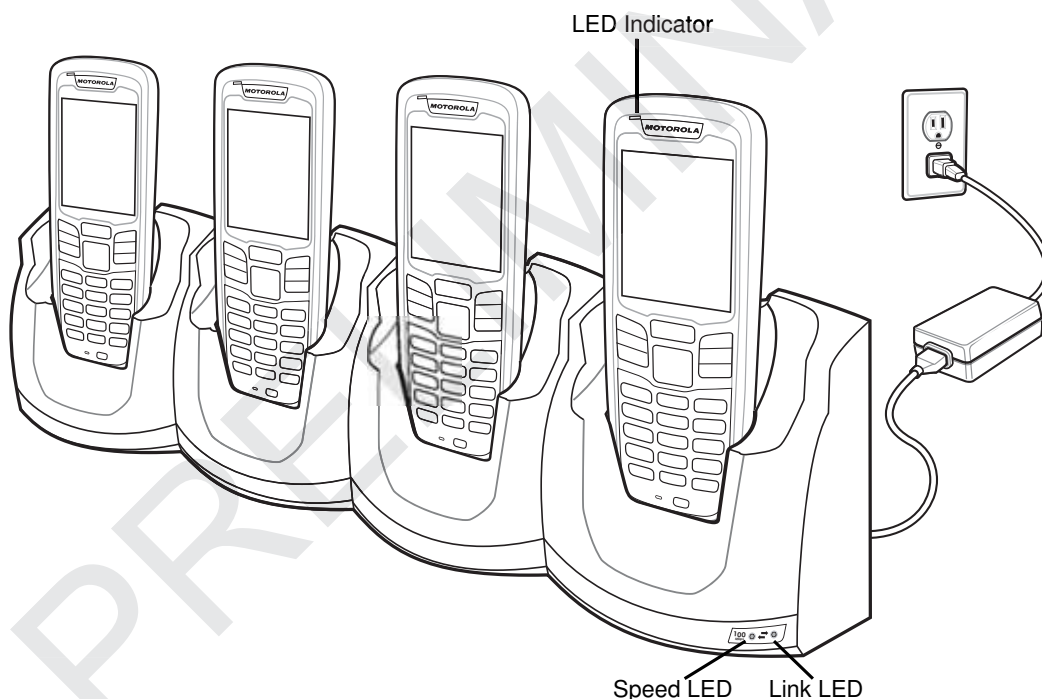

Figure 6-3 Four-slot Ethernet Cradle

2. The MC21XX LED Indicator indicates the MC21XX battery charging status. The battery usually charges in approximately four hours. See [Table 1-1 on page 1-6](#) for charging status indications.
3. When charging is complete, remove the MC21XX from the cradle.

LED Charge Indications

The Four-slot Ethernet cradle use the MC21XX amber LED Indicator to indicate the battery charging status. See [Table 1-1 on page 1-6](#) for charging status indications.

Speed LED

The green Speed LED lights to indicate that the transfer rate is 100 Mbps. When it is not lit it indicates that the transfer rate is 10 Mbps.

Link LED

The yellow Link LED blinks to indicate activity, or stays lit to indicate that a link is established. When it is not lit, it indicates that there is no link.

PRELIMINARY

Four-slot Spare Battery Charger



CAUTION Ensure that you follow the guidelines for battery safety described in [Battery Safety Guidelines on page 7-2](#).

The Four-slot Spare Battery Charger simultaneously charges up to four spare batteries.

Spare Battery Charging

To charge up to four spare batteries:

1. Insert the spare battery into the spare battery charging slot, contact end first.
2. Pivot the battery down into the charging slot.

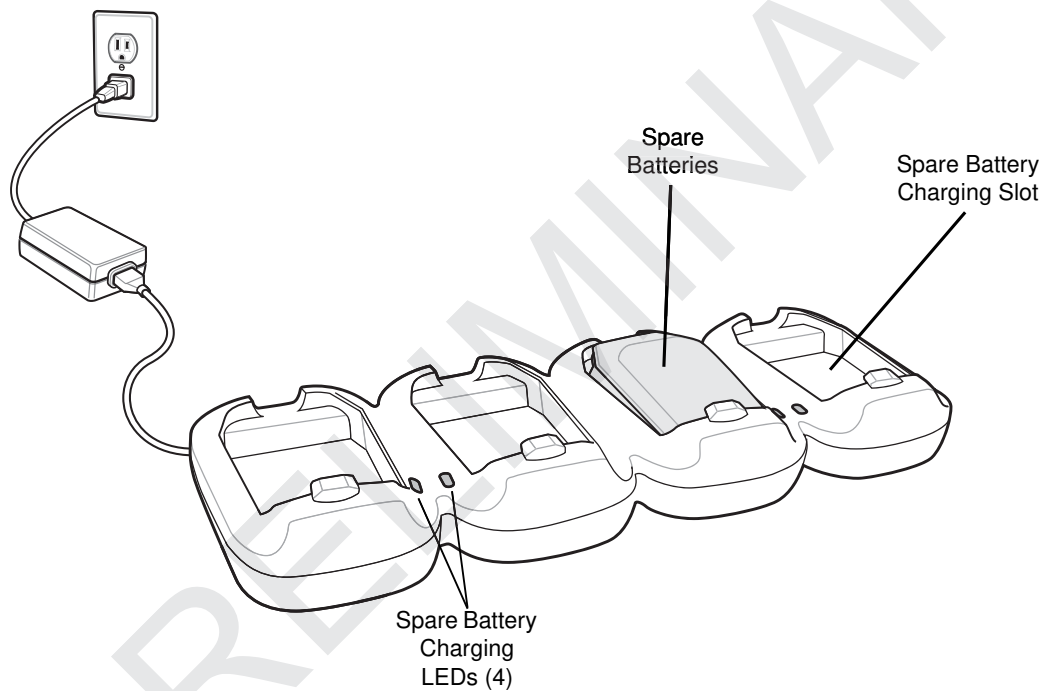

Figure 6-4 Four-slot Spare Battery Charger

3. Gently press down on the battery to ensure proper contact. The battery charges in approximately four hours. See [Table 1-1 on page 1-6](#) for charging status indications.
4. When charging is complete, press the battery clip and lift battery out of the slot.



WARNING! Do not use a tool to remove the battery.

The Spare Battery Charging LEDs indicate the spare battery charging status. See [Table 1-1 on page 1-6](#) for charging status indications.

Modem Adapter Cable/Modem Dongle

Use the Modem Adapter Cable and Modem Dongle to enable data communication between the MC21XX and a host computer, remotely through the phone lines, and synchronizes information between the MC21XX and a host computer.

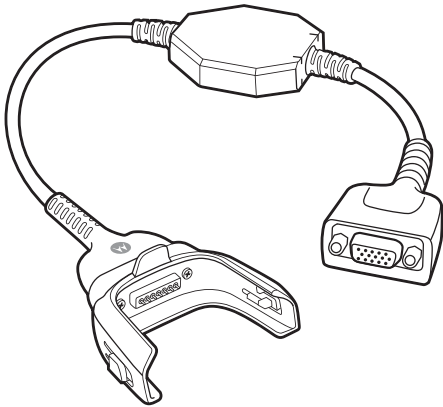

Figure 6-5 Modem Adapter Cable

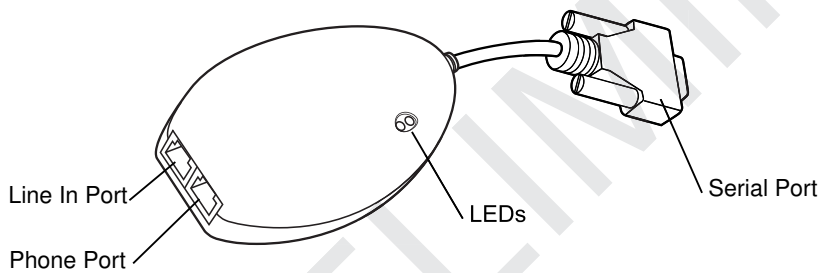

Figure 6-6 Modem Dongle

The following items are required for a modem connection:

- Telephone number, IP address and DNS/WINS address information from the dial-in server administrator
- Dial-in account on the host system, including a user ID and password
- RJ11 or RJ12 modem cable
- Functioning telephone jack that supports plug-in modems connected to the local telephone system
- Setup of Country Codes to use the modem with the appropriate country's telephone network.

Setup

Connecting to the MC21XX

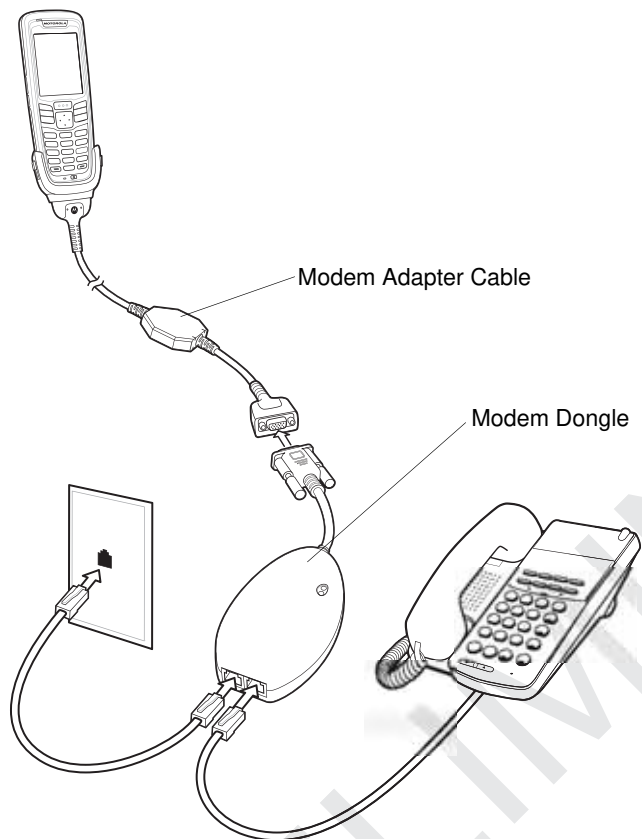

Figure 6-7 *Modem Dongle Setup*



CAUTION Do not connect the modem's 15-pin connector into a VGA port of a host computer.

Using the Correct Telephone Line Type

Use a standard analog phone line, as in most households. In an office, use a line connected to a fax machine or modem. In a hotel, request a room with a standard phone line or data port. If necessary, check with the local phone company or administrator to make sure you are using the right type of line before sending data.



NOTE If using a phone, connect the cord from the phone to the Phone port on the modem.

Table 6-2 *Modem LED Indicator*

LED	Indication
Off	Modem is not properly connected to the MC21XX; modem is not receiving power.
Green	Modem is connected to the MC21XX and is receiving power.
Solid Amber	MC21XX is communicating with the host computer.

PRELIMINARY

USB ActiveSync/Charge Cable

The USB ActiveSync/Charge cable:

- Provide the MC21XX with operating and charging power when used with the approved power supply.
- Synchronize information between the MC21XX and a host computer. With customized or third party software, it can also synchronize the MC21XX with corporate databases.
- Provide USB connection through the USB pass-through port for communication with a USB device, such as a host computer. For communication setup procedures, refer to the *MC21XX Series Mobile Computer Integrator Guide*.

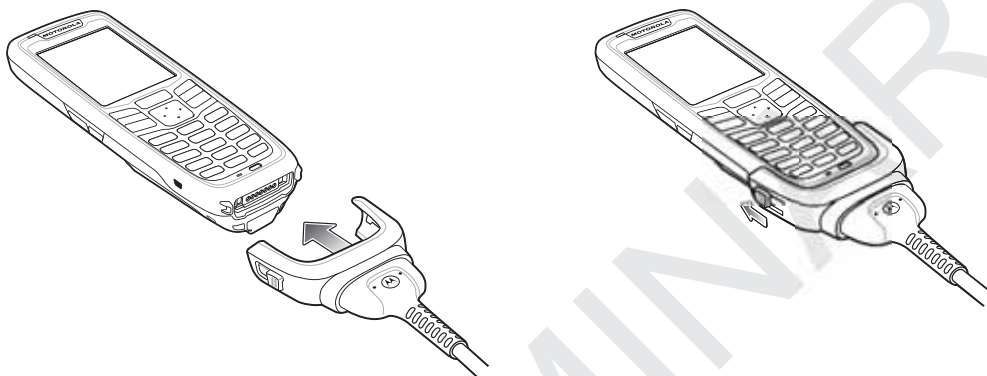

Figure 6-8 USB Charge Cable

Battery Charging and Operating Power



CAUTION Ensure that you follow the guidelines for battery safety described in [Battery Safety Guidelines on page 7-2](#).

To charge the MC21XX battery:

1. Connect the USB Charge Cable power input connector to the approved power source.

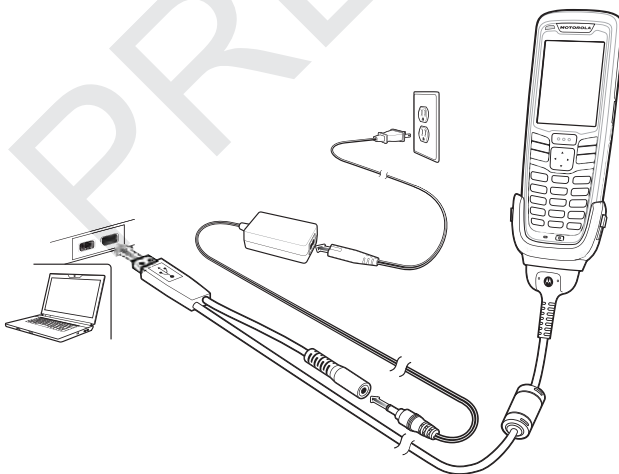

Figure 6-9 USB Charge Cable

2. Slide the bottom of the MC21XX into the MC21XX connector end of the MC21XX Communication/Charge cable and gently press in until the snaps latch into the MC21XX.

3. The MC21XX LED Indicator indicates the MC21XX battery charging status. The battery usually charges in less than four hours. See, [Table 1-1 on page 1-6](#) for charging status indications.
4. When charging is complete, remove the cable by gently pulling the MC21XX and the cable apart until the snaps release the MC21XX.

LED Charge Indications

The MC21XX Charge cable use the amber LED Indicator to indicate the MC21XX battery charging status. See [Table 1-1 on page 1-6](#) for charging status indications.

PRELIMINARY

Holster

The holster provides a holder for the MC21XX.

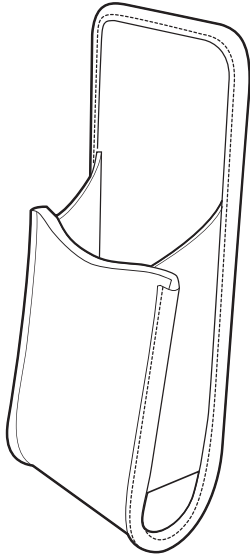

Figure 6-10 *Holster*

The holster holds the MC21XX on a belt or waist band. Slide the MC21XX into the holster with the screen facing the user.

Handstrap

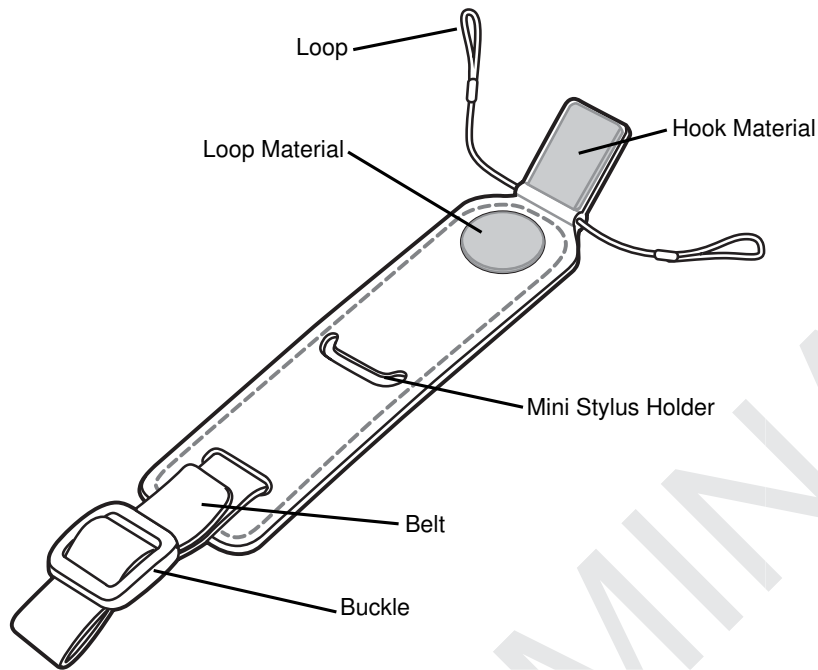

Figure 6-11 Handstrap

Installation

To install the handstrap:

1. Feed both loops through the mounting slots.

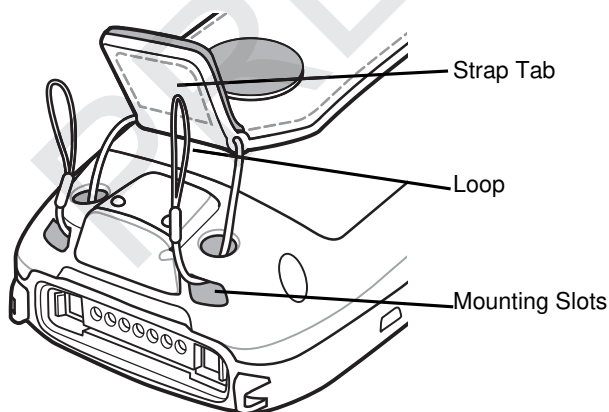

Figure 6-12 Feed Loops Through Mounting Slots

2. Slide each loop over the strap tab and push all the way down.

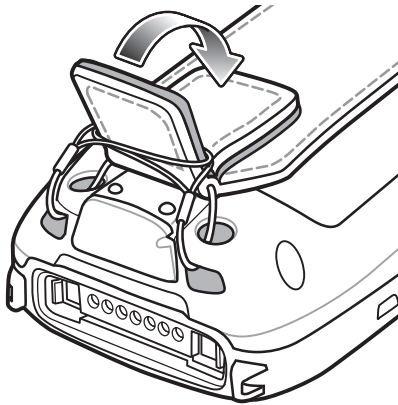

Figure 6-13 *Secure Tab*

3. Press the tab down to secure.
4. Feed the belt through the handstrap bar.

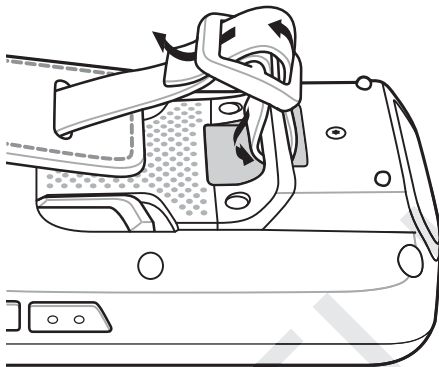

Figure 6-14 *Connect Handstrap to Handstrap Bar*

5. Feed the belt through the buckle.

Removal

To remove the handstrap:

1. Pull the belt through the buckle.
2. Pull the belt through the handstrap bar.
3. Lift the strap tab.
4. Lift both loops off the strap tab.
5. Pull loops through the mounting slots.

Lanyard

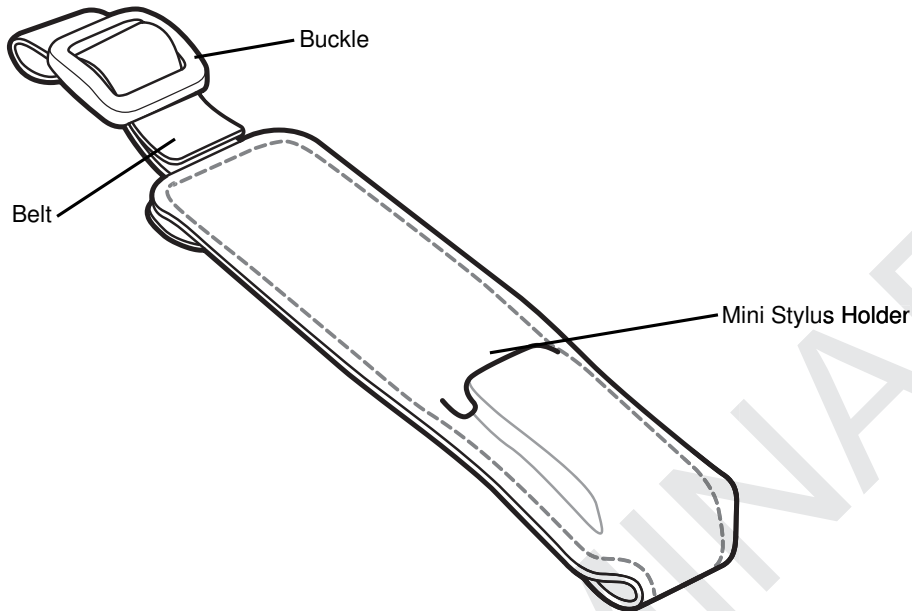

Figure 6-15 Lanyard

Installation

1. Feed the belt through the handstrap bar.

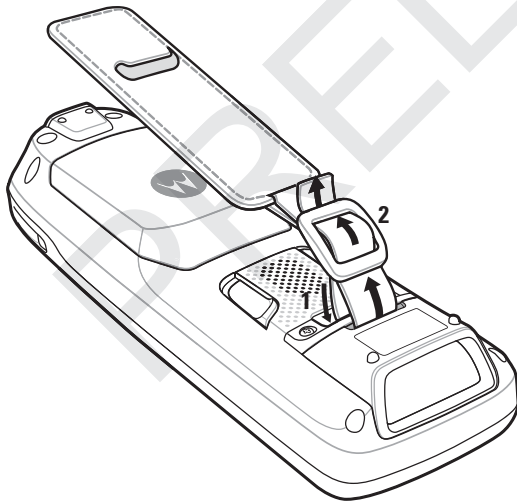

Figure 6-16 Lanyard Installation

2. Feed the belt through the buckle.

Removal

Tether Installation

Use the tether to attach the mini stylus or pen stylus to the MC21XX handstrap bar. To install the tether:

Insert loop into mounting hole on stylus.

Feed other end through loop and pull taught.

Feed loop into mounting hole on handstrap bar.

Feed stylus through loop and pull taught.

PRELIMINARY

PRELIMINARY

Chapter 7 Maintenance & Troubleshooting

Introduction

This chapter includes instructions on cleaning and storing the MC21XX, and provides troubleshooting solutions for potential problems during MC21XX operation.

Maintaining the MC21XX

For trouble-free service, observe the following tips when using the MC21XX:

- Do not scratch the screen of the MC21XX. When working with the MC21XX, use the supplied stylus or plastic-tipped pens intended for use with a touch-sensitive screen. Never use an actual pen or pencil or other sharp object on the surface of the MC21XX screen.

Motorola recommends using a screen protector, p/n TBS.

- The screen of the MC21XX is glass. Do not drop the MC21XX or subject it to strong impact.
- Protect the MC21XX from temperature extremes. Do not leave it on the dashboard of a car on a hot day, and keep it away from heat sources.
- Do not store or use the MC21XX in any location that is dusty, damp, or wet.
- Use a soft lens cloth to clean the MC21XX. If the surface of the MC21XX screen becomes soiled, clean it with a soft cloth moistened with a diluted window-cleaning solution.
- Periodically replace the rechargeable battery to ensure maximum battery life and product performance. Battery life depends on individual usage patterns.

- A screen protector is applied to the MC21XX. Motorola recommends using this to minimize wear and tear. Screen protectors enhance the usability and durability of touch screen displays. Benefits include:
 - Protection from scratches and gouges
 - Durable writing and touch surface with tactile feel
 - Abrasion and chemical resistance
 - Glare reduction
 - Keeping the device's screen looking new
 - Quick and easy installation.

Battery Safety Guidelines



WARNING! Failure to follow these guidelines may result in fire, explosion, or other hazard.

- The area in which the units are charged should be clear of debris and combustible materials or chemicals. Particular care should be taken where the device is charged in a non commercial environment.
- Follow battery usage, storage, and charging guidelines found in the user's guide.
- Improper battery use may result in a fire, explosion, or other hazard.
- Do not use a tool to remove the battery from the MC21XX or battery charging accessory.
- To charge the mobile device battery, the battery and charger temperatures must be between +32 °F and +104 °F (0 °C and +40 °C)
- Do not use incompatible batteries and chargers. Use of an incompatible battery or charger may present a risk of fire, explosion, leakage, or other hazard. If you have any questions about the compatibility of a battery or a charger, contact Motorola Enterprise Mobility support.
- For devices that utilize a USB port as a charging source, the device shall only be connected to products that bear the USB-IF logo or have completed the USB-IF compliance program.
- To enable authentication of an approved battery, as required by IEEE1725 clause 10.2.1, all batteries will carry a Motorola hologram. Do not fit any battery without checking it has the Motorola authentication hologram.
- Do not disassemble or open, crush, bend or deform, puncture, or shred.
- Severe impact from dropping any battery-operated device on a hard surface could cause the battery to overheat.
- Do not short circuit a battery or allow metallic or conductive objects to contact the battery terminals.
- Do not modify or remanufacture, attempt to insert foreign objects into the battery, immerse or expose to water or other liquids, or expose to fire, explosion, or other hazard.
- Do not leave or store the equipment in or near areas that might get very hot, such as in a parked vehicle or near a radiator or other heat source. Do not place battery into a microwave oven or dryer.
- Battery usage by children should be supervised.
- Please follow local regulations to properly dispose of used re-chargeable batteries.
- Do not dispose of batteries in fire.

- In the event of a battery leak, do not allow the liquid to come in contact with the skin or eyes. If contact has been made, wash the affected area with large amounts of water and seek medical advice.
- If you suspect damage to your equipment or battery, contact Motorola Enterprise Mobility support to arrange for inspection.

Cleaning



CAUTION Always wear eye protection.

Read warning label on compressed air and alcohol product before using.

If you have to use any other solution for medical reasons please contact Motorola for more information.



WARNING! Avoid exposing this product to contact with hot oil or other flammable liquids. If such exposure occurs, unplug the device and clean the product immediately in accordance with these guidelines.

Approved Cleanser Active Ingredients

100% of the active ingredients in any cleaner must consist of one or some combination of the following: isopropyl alcohol, bleach/sodium hypochlorite, hydrogen peroxide or mild dish soap.

Harmful Ingredients

The following chemicals are known to damage the plastics on the MC21XX and should not come in contact with the device: ammonia solutions, compounds of amines or ammonia; acetone; ketones; ethers; aromatic and chlorinated hydrocarbons; aqueous or alcoholic alkaline solutions; ethanolamine; toluene; trichloroethylene; benzene; carbonic acid and TB-lysoform.

Cleaning Instructions

Do not apply liquid directly to the MC21XX. Dampen a soft cloth or use pre-moistened wipes. Do not wrap the device in the cloth or wipe, but gently wipe the unit. Be careful not to let liquid pool around the display window or other places. Allow the unit to air dry before use.

Special Cleaning Notes

Many vinyl gloves contain phthalate additives, which are often not recommended for medical use and are known to be harmful to the housing of the MC21XX. The MC21XX should not be handled while wearing vinyl gloves containing phthalates, or before hands are washed to remove contaminant residue after gloves are removed. If products containing any of the harmful ingredients listed above are used prior to handling the MC21XX, such as hand sanitizer that contain ethanolamine, hands must be completely dry before handling the MC21XX to prevent damage to the plastics.

Materials Required

- Alcohol wipes
- Lens tissue

- Cotton tipped applicators
- Isopropyl alcohol
- Can of compressed air with a tube.

Cleaning the MC21XX

Housing

Using the alcohol wipes, wipe the housing including keys and in-between keys.

Display

The display can be wiped down with the alcohol wipes, but care should be taken not to allow any pooling of liquid around the edges of the display. Immediately dry the display with a soft, non-abrasive cloth to prevent streaking.

Scanner Exit Window

Wipe the scanner exit window periodically with a lens tissue or other material suitable for cleaning optical material such as eyeglasses.

Connector

1. Remove the main battery from MC21XX. See [Main Battery Removal on page 1-8](#).
2. Dip the cotton portion of the cotton tipped applicator in isopropyl alcohol.
3. Rub the cotton portion of the cotton tipped applicator back-and-forth across the connector on the bottom of the MC21XX. Do not leave any cotton residue on the connector.
4. Repeat at least three times.
5. Use the cotton tipped applicator dipped in alcohol to remove any grease and dirt near the connector area.
6. Use a dry cotton tipped applicator and repeat steps 4 through 6.



CAUTION Do not point nozzle at yourself and others, ensure the nozzle or tube is away from your face.

7. Spray compressed air on the connector area by pointing the tube/nozzle about ½ inch away from the surface.
8. Inspect the area for any grease or dirt, repeat if required.

Cleaning Cradle Connectors

To clean the connectors on a cradle:

1. Remove the DC power cable from the cradle.
2. Dip the cotton portion of the cotton tipped applicator in isopropyl alcohol.
3. Rub the cotton portion of the cotton tipped applicator along the pins of the connector. Slowly move the applicator back-and-forth from one side of the connector to the other. Do not let any cotton residue on the connector.

4. All sides of the connector should also be rubbed with the cotton tipped applicator.



CAUTION Do not point nozzle at yourself and others, ensure the nozzle or tube is away from your face.

5. Spray compressed air in the connector area by pointing the tube/nozzle about ½ inch away from the surface.
6. Ensure that there is no lint left by the cotton tipped applicator, remove lint if found.
7. If grease and other dirt can be found on other areas of the cradle, use lint free cloth and alcohol to remove.
8. Allow at least 10 to 30 minutes (depending on ambient temperature and humidity) for the alcohol to air dry before applying power to cradle.

If the temperature is low and humidity is high, longer drying time is required. Warm temperature and dry humidity requires less drying time.

Cleaning Frequency

The cleaning frequency is up to the customer's discretion due to the varied environments in which the mobile devices are used. They may be cleaned as frequently as required. However when used in dirty environments it may be advisable to periodically clean the scanner exit window to ensure optimum scanning performance.

Troubleshooting

MC21XX

Table 7-1 Troubleshooting the MC21XX

Problem	Cause	Solution
MC21XX does not turn on.	Main battery not charged.	Charge or replace the main battery.
	Main battery not installed properly.	Ensure the battery is installed properly. See <i>Install Main Battery on page 1-4</i> .
	System crash.	Perform a warm boot. If the MC21XX still does not turn on, perform a cold boot. For more information see, <i>Resetting the MC21XX on page 2-12</i> .
Battery did not charge.	Battery failed.	Replace battery. If the MC21XX still does not operate, try a warm boot, then a cold boot. For more information see, <i>Resetting the MC21XX on page 2-12</i> .
	MC21XX removed from power source while battery was charging.	Connect power source and begin charging. The battery requires up to four hours to recharge fully.
	Extreme battery temperature.	Battery does not charge if ambient temperature is below 32°F (0°C) or above 104°F (40°C).
Cannot see characters on screen.	MC21XX not powered on.	Press the Power button.
During data communication, no data was transmitted, or transmitted data was incomplete.	MC21XX removed from cradle or unplugged from host computer during communication.	Replace the MC21XX in the cradle, or reattach the cable and re-transmit.
	Incorrect cable configuration.	See the system administrator or refer to the <i>MC21XX Series MC21XX Integrator Guide</i> .
	Communication software was incorrectly installed or configured.	See the system administrator or refer to the <i>MC21XX Series MC21XX Integrator Guide</i> .
MC21XX does not emit sound.	Volume setting is low or turned off.	Increase the volume. See <i>Adjusting the Volume on page 2-4</i> for more information.
MC21XX turns itself off.	MC21XX is inactive.	The MC21XX turns off after a period of inactivity. This period can be set from one to five minutes, in one-minute intervals.
	Battery is depleted.	Recharge or replace the battery.

Table 7-1 *Troubleshooting the MC21XX (Continued)*

Problem	Cause	Solution
Tapping the window buttons or icons does not activate the corresponding feature.	Touch screen not calibrated correctly.	Re-calibrate the screen. Tap Start > Control Panel > Stylus > Calibration tab. Tap the Recalibrate button.
	MC2100 does not have a touch screen.	Normal operation.
	The system crashed.	Warm boot the system. To perform a warm boot, see <i>Resetting the Mobile Computer on page 2-27</i> .
A message appears stating that the MC21XX memory is full.	Too many files stored on the MC21XX.	Delete unused memos and records. If necessary, save these records on the host computer.
	Too many applications installed on the MC21XX.	Remove unused installed applications from the MC21XX to recover memory.
The MC21XX does not accept scan input.	Scanning application is not loaded.	Verify that the MC21XX is loaded with a scanning application. See the system administrator.
	Unreadable bar code.	Ensure the symbol is not defaced.
	Distance between scan window and bar code is incorrect.	Ensure the MC21XX is within proper scanning range.
	MC21XX is not programmed for the bar code type.	Ensure the MC21XX is programmed to accept the type of bar code scanned.
	MC21XX is not programmed to generate a beep.	If a beep on a good decode is expected and a beep is not heard, check that the application is set to generate a beep on good decode.
	Battery is low.	Check the battery level. When the battery is low, the MC21XX automatically goes into suspend mode.
Warning appears on screen during boot up.	Battery not removed properly.	Follow Battery Swap procedure. See <i>Main Battery Removal on page 1-8</i> .
MC21XX performs a cold boot after performing a Battery Swap	Battery Swap Procedure not followed.	Follow Battery Swap procedure. See <i>Main Battery Removal on page 1-8</i> .
	Backup battery not adequately charged.	Ensure backup battery charges fully. See <i>Battery Charging on page 1-5</i> .

Single-slot USB Cradle

Table 7-2 Troubleshooting the Single-slot USB Cradle

Symptom	Possible Cause	Solution
MC21XX battery is not charging (LED Indicator does not light).	Cradle is not receiving power.	Ensure the power cable is connected securely to both the cradle and to AC power.
	MC21XX was removed from cradle too soon.	If the MC21XX battery is fully depleted, it can take up to five hours to fully recharge a battery.
	No battery installed.	Install battery.
	Battery is faulty.	Verify that other batteries charge properly. If so, replace the faulty battery.
	The MC21XX is not fully seated in the cradle.	Remove and re-insert the MC21XX into the cradle, ensuring it is correctly seated.
During data communication, no data was transmitted, or transmitted data was incomplete.	MC21XX removed from cradle during communication.	Replace MC21XX in cradle and retransmit.
	Incorrect cable configuration.	See the system administrator or refer to the <i>MC21XX Series Integrator Guide</i> .
	Communication software is not installed or configured properly.	See the system administrator or refer to the <i>MC21XX Series Integrator Guide</i> .
Peripheral device not working properly.	Incorrect communication cable used.	Obtain correct cable from vendor. Cable should be microUSB A to USB B.

Four-slot Charge Only Cradle

Table 7-3 Troubleshooting the Four-slot Charge Only Cradle

Problem	Cause	Solution
MC21XX battery is not charging (Indicator does not light).	Cradle is not receiving power.	Ensure the power cable is connected securely to both the cradle and to AC power.
	No battery installed.	Install battery.
	Battery is faulty.	Verify that other batteries charge properly. If so, replace the faulty battery.
	MC21XX was removed from cradle too soon.	If the MC21XX battery is fully depleted, it can take up to five hours to fully recharge a battery.
	The MC21XX is not fully seated in the cradle.	Remove and re-insert the MC21XX into the cradle, ensuring it is correctly seated.

Four-slot Spare Battery Charger

Table 7-4 Troubleshooting the Four-slot Spare Battery Charger

Symptom	Possible Cause	Solution
Spare battery is not charging (Spare Battery Charging LED does not light).	Charger is not receiving power.	Ensure the power cable is connected securely to both the charger and to AC power.
	Spare battery is not correctly seated.	Remove and re-insert the battery into the charger, ensuring it is correctly seated.
	Spare battery was removed from charger or charger was unplugged from AC power too soon.	Ensure charger is receiving power. Ensure the spare battery is seated correctly. If a battery is fully depleted, it can take up to five hours to fully recharge a battery.
	Spare battery is faulty.	Verify that other batteries charge properly. If so, replace the faulty battery.

USB ActiveSync/Charge Cable

Table 7-5 Troubleshooting the USB ActiveSync/Charge Cable

Symptom	Possible Cause	Solution
MC21XX battery is not charging (LED Indicator does not light).	Cable is not receiving power.	Ensure the power cable is connected securely to both the cable and to AC power.
	No battery installed.	Install battery.
	Battery is faulty.	Verify that other batteries charge properly. If so, replace the faulty battery.
	The MC21XX is not fully seated in the cable.	Remove and re-attach the MC21XX to the cable, ensuring it is correctly seated.
During data communication, no data was transmitted, or transmitted data was incomplete.	Cable removed from MC21XX during communication.	Reattach cable to MC21XX and retransmit.
	Incorrect cable configuration.	See the system administrator or refer to the <i>MC21XX Series MC21XX Integrator Guide</i> .
	Communication software is not installed or configured properly.	See the system administrator or refer to the <i>MC21XX Series MC21XX Integrator Guide</i> .

PRELIMINARY

Appendix A Specifications

MC21XX and Accessory Technical Specifications

Table A-1 summarizes the MC21XX technical specifications and intended operating environments.

Table A-1 MC21XX Technical Specifications

Item	Description
Physical Characteristics	
Dimensions	171.7 mm L x 60.9 mm W x 34.1 mm D (6.76 in L x 2.40 in W x 1.24 in D)
Weight (including battery)	MC2100: 228 g (8.04 oz) MC2180: 236 g (8.32 oz)
Display	2.8 inch TFT Color QVGA (240 x 320) display with backlight
Touch Panel	Analog resistive touch (MC2180 only)
Backlight	LED backlight
Battery	Rechargeable Lithium-ion 2400 mAh minimum (3.7V)
Expansion Slot	User accessible microUSB slot (located under battery); up to 32 GB.
Network Connections	Full-speed USB (host or client)* Bluetooth (MC2180 only) WLAN (MC2180 only) *USB available with appropriate cables only
Notification	LED and audible alert
Keypad Options	27-key Numeric
Audio	Speaker and microphone (MC2180 only) Beeper (MC2100 only)

Table A-1 MC21XX Technical Specifications (Continued)

Item	Description
Performance Characteristics	
CPU	Marvell PXA320 processor at 624 MHz
Operating System	Microsoft® Embedded CE 6.0 Core
Memory	128 MB RAM/256 MB Flash
Output Power	USB: 5 VDC @ 300 mA max.
User Environment	
Operating Temperature	-10°C to 50°C (-14°F to 122°F)
Storage Temperature	-40° to 70°C (-40° to 158°F) without battery
Charging Temperature	0° C to 40° C (32°F to 104°F)
Humidity	5 to 95% non-condensing
Drop Specification	Multiple 1.2 m (4 ft.) to concrete at room temperature Multiple 0.9 m (3 ft.) to concrete across the operating temperature Multiple 1.2 m (4 ft.) MIL-STD 810G specifications
Tumble	500 0.5 m (1.6 ft.) tumbles per IEC tumble specifications.
Electrostatic Discharge (ESD)	+/- 15 kV air discharge +/- 8 kV direct discharge
Sealing	IP54 per IEC sealing specifications.
Wireless LAN Data and Voice Communications	
Wireless Local Area Network (WLAN) radio	IEEE® 802.11b/g/n
Data Rates Supported	1, 2, 5.5, 6, 9, 11, 12, 18, 24, 36, 48, and 54 Mbps
Operating Channels	Channel 1-13 (2412-2472 MHz), Channel 14 (2484 MHz) Japan only; actual operating channels/frequencies depend on regulatory rules and certification agency
Security	Security Modes: Legacy, WPA and WPA2 Encryption: WEP (40 or 128 bit), TKIP and AES Authentication: TLS, TTLS (MS-CHAP), TTLS (MS-CHAP v2), TTLS (CHAP), TTLS (MD5), TTLS (PAP), PEAP-TLS, PEAP (MS-CHAP v2), PEAP (EAP-GTC), EAP-FAST-TLS, EAP-FAST (MS-CHAP v2), EAP-FAST (EAP-GTC) and LEAP
Spreading Technique	Direct Sequence Spread Spectrum (DSSS) and Orthogonal Frequency Division Multiplexing (OFDM)
Antenna	Internal
Voice Communication	TEAM Express push-to-talk over WLAN Wi-Fi Multimedia (WMM)

Table A-1 MC21XX Technical Specifications (Continued)

Item	Description
Wireless PAN (MC2180 only)	
Bluetooth	v2.0 with Enhanced Data Rate (EDR); integrated antenna
Data Capture Specifications	
Options	Linear imager 1D laser scanner 2D imager
Linear Imager Specifications	
Optical Resolution	5 mil minimum element width
Roll	$\pm 25^\circ$ from vertical
Pitch Angle	$\pm 65^\circ$ from normal
Skew Tolerance	$\pm 50^\circ$ from normal
Ambient Light	Sunlight - 9,690 Lux Artificial Light - 4,845 Lux
Scan Rate	50 scans/sec
Scan Angle	$53.3^\circ \pm 3^\circ$
1D Laser Scanner Specifications	
Optical Resolution	5 mil minimum element width
Roll	$\pm 35^\circ$ from vertical
Pitch Angle	$\pm 65^\circ$ from normal
Skew Tolerance	$\pm 40^\circ$ from normal
Ambient Light	Sunlight - 107,640 Lux Artificial Light - 4,844 Lux
Scan Rate	104 (± 12) scans/sec (bidirectional)
Scan Angle	47° (typical)
2D Imager Engine Specifications	
Field of View	Horizontal: 39.2° Vertical: 25.4°
Optical Resolution	752 H x 480 V pixels (gray scale)
Roll	360°
Pitch Angle	$\pm 60^\circ$ from normal
Skew Tolerance	$\pm 60^\circ$ from normal

Table A-1 MC21XX Technical Specifications (Continued)

Item	Description
Ambient Light	Sunlight - 96,900 Lux
Aiming Element (VLD)	655 nm \pm 10 nm Laser
Illumination Element (LED)	625 nm \pm 5 nm LEDs (2x)

PRELIMINARY

Appendix B Keypad

Introduction

The MC21XX is available with a 27-key keypad.

- ✓ **NOTE** For information about using the soft keyboard input panel. For more information, see [Entering Information Using the Keyboard Input Panel on page 2-12](#).

27-Key Keypad

The 27-key keypad contains a **Power** button, application keys, navigation pad and function keys. The keypad is color-coded to indicate the alternate function key (blue) values and the alternate **ALPHA** key (orange) values. Note that keypad functions can be changed by an application so the MC21XX keypad may not function as described. See [Table B-1 on page B-2](#) for key and button descriptions and [Table B-2 on page B-4](#) for the keypad alternate functions.

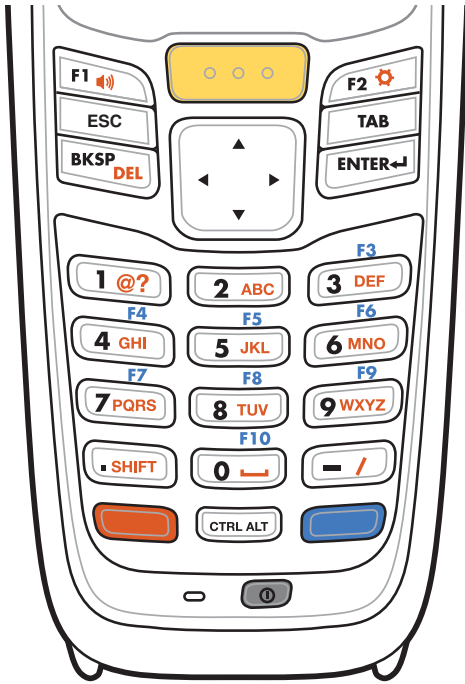

Figure B-1 27-Key Keypad

Table B-1 27-Key Descriptions







Key	Description
Power (red) 	Powers the MC21XX screen on and off (resume and suspend).
Scan (yellow) 	Used in scanning applications, press to scan a bar code. This key has the same function as activating the side mounted scan buttons.
Navigation Pad 	Moves up, down, left and right from one item to another. Increases/decreases specified values.
ESC 	Produces the ESC function by default.
CTRL 	Press and release the CTRL key to activate the keypad alternate CTRL functions. The  icon appears on the taskbar. Press and release the CTRL key again to return to the default keypad functions. Press and release the blue FUNC key and then the CTRL key to activate the ALT functions. The  icon appears on the taskbar. Press and release the CTRL key two times to return to the default keypad functions.

Table B-1 27-Key Descriptions (Continued)











Key	Description
Numeric/Alpha/Special Function 	Numeric, alpha or special function keys. Numeric by default. Produces a special function when the blue FUNC key is activated. Produces alpha values when the orange ALPHA key is activated. In Alpha state, produces the lower case alphabetic characters on the key. Each key press produces the next alphabetic character in sequence. For example, press and release the ALPHA key and then press the 4 key once to produce the letter 'g'; press and release the ALPHA key and then press the 4 key three times to produce the letter 'i'. When the SHIFT key is pressed in Alpha state, the upper case alphabetic characters on the key are produced. For example, press and release the ALPHA key, press and hold the SHIFT key and then press the 4 key once to produce the letter 'G'; press and release the ALPHA key, press and hold the SHIFT key and then press the 4 key three times to produce the letter 'I'.
Period/Decimal Point 	Produces a period for alpha entries and a decimal point for numeric entries by default. Press the Orange key then the SHIFT key to activate the keypad alternate SHIFT functions. The  icon appears on the taskbar. Press the SHIFT key a second time to enable Shift-Lock feature. The  icon appears on the taskbar. Press and release the SHIFT key again to return to the default keypad functions.
Enter 	Executes a selected item or function.
BKSP 	Backspace function by default. Decreases brightness when the blue FUNC key is activated.
Orange 	Press the orange key to access the alternate ALPHA characters (shown on the keypad in orange). The ALP icon appears on the taskbar. Press and release the orange key again to return to the default keypad functions.
Blue 	Press and release the blue key to activate the keypad alternate functions (shown on the keypad in blue). The  icon appears on the taskbar. Press and release the blue key a second time to lock the function. The  icon appears on the taskbar. Press and release again to return to the default keypad functions.

Table B-2 27-key Keypad Input Modes

Key	Numeric Mode		Orange Key (Alpha Lowercase Mode)				Orange + Shift Keys (Alpha Uppercase Mode)			
		SHIFT + Key	1st Press	2nd Press	3rd Press	4th Press	1st Press	2nd Press	3rd Press	4th Press
1	1	1	See Note 2				See Note 2			
2	2	2	a	b	c		A	B	C	
3	3	3	d	e	f		D	E	F	
4	4	4	g	h	i		G	H	I	
5	5	5	j	k	l		J	K	L	
6	6	6	m	n	o		M	N	O	
7	7	7	p	q	r	s	P	Q	R	S
8	8	8	t	u	v		T	U	V	
9	9	9	w	x	y	z	W	X	Y	Z
0	0	0	space				0			
.	.	>	.				.			
-			/				?			

Note 1: An application can change the key functions. The keypad may not function exactly as described.
 Note 2: Press the 1 key up to ten times to create the following characters: @ ? # \$ % ^ & * ()

PRELIMINARY

PRELIMINARY

GLOSSARY

A

API. An interface by means of which one software component communicates with or controls another. Usually used to refer to services provided by one software component to another, usually via software interrupts or function calls

Aperture. The opening in an optical system defined by a lens or baffle that establishes the field of view.

Application Programming Interface. See **API**.

ANSI Terminal. A display terminal that follows commands in the ANSI standard terminal language. For example, it uses escape sequences to control the cursor, clear the screen and set colors. Communications programs support the ANSI terminal mode and often default to this terminal emulation for dial-up connections to online services.

ASCII. American Standard Code for Information Interchange. A 7 bit-plus-parity code representing 128 letters, numerals, punctuation marks and control characters. It is a standard data transmission code in the U.S.

Autodiscrimination. The ability of an interface controller to determine the code type of a scanned bar code. After this determination is made, the information content is decoded.

B

Bar. The dark element in a printed bar code symbol.

Bar Code. A pattern of variable-width bars and spaces which represents numeric or alphanumeric data in machine-readable form. The general format of a bar code symbol consists of a leading margin, start character, data or message character, check character (if any), stop character, and trailing margin. Within this framework, each recognizable symbology uses its own unique format. See **Symbology**.

Bar Code Density. The number of characters represented per unit of measurement (e.g., characters per inch).

Bar Height. The dimension of a bar measured perpendicular to the bar width.

Bar Width. Thickness of a bar measured from the edge closest to the symbol start character to the trailing edge of the same bar.

BIOS. Basic Input Output System. A collection of ROM-based code with a standard API used to interface with standard PC hardware.

Bit. Binary digit. One bit is the basic unit of binary information. Generally, eight consecutive bits compose one byte of data. The pattern of 0 and 1 values within the byte determines its meaning.

Bits per Second (bps). Bits transmitted or received.

Bit. Binary digit. One bit is the basic unit of binary information. Generally, eight consecutive bits compose one byte of data. The pattern of 0 and 1 values within the byte determines its meaning.

bps. See **Bits Per Second**.

Byte. On an addressable boundary, eight adjacent binary digits (0 and 1) combined in a pattern to represent a specific character or numeric value. Bits are numbered from the right, 0 through 7, with bit 0 the low-order bit. One byte in memory is used to store one ASCII character.

BOOTP. A protocol for remote booting of diskless devices. Assigns an IP address to a machine and may specify a boot file. The client sends a bootp request as a broadcast to the bootp server port (67) and the bootp server responds using the bootp client port (68). The bootp server must have a table of all devices, associated MAC addresses and IP addresses.

boot or boot-up. The process a computer goes through when it starts. During boot-up, the computer can run self-diagnostic tests and configure hardware and software.

INDEX

Numerics

- 27-key keypad B-1
- 2-D bar codes 3-1

A

- accessories 1-2
 - four-slot charge only cradle 6-4
 - four-slot cradles
 - battery charging 6-4
 - four-slot spare battery charger
 - battery charging 6-7
 - LED indicators 6-7
 - MC21XX charge cables
 - LED indicators 6-12
 - SD card 1-3
 - single-slot USB cradle 6-3
 - battery charging 6-3
 - stylus 6-2
- active and indicate programs 2-5
- active tasks 2-9
- ActiveSync iv
- adaptive frequency hopping 4-1
- AFH 4-1

B

- bar codes
 - two dimensional 3-1
- battery
 - charging 1-5
 - install 1-4
- battery charge status 2-5
- battery chargers
 - four slot-spare battery charger
 - battery charging 6-7

- four-slot spare battery charger
 - LED indicators 6-7
- MC21XX charge cables
 - LED indicators 6-12
- battery charging
 - backup battery 1-5
 - four-slot cradles 6-4, 6-5
 - four-slot spare battery charger 6-7
 - main battery 1-5
 - temperature range 1-5
- battery icon 2-5
- battery status 2-5
- Bluetooth 4-1
 - adaptive frequency hopping 4-1
 - security 4-2
- bluetooth
 - discovering devices 4-4
- boot
 - cold 4-3
 - warm 4-3
- bullets iv

C

- calibration screen 1-7
- charge LED indicator 1-2
- charging
 - spare batteries 1-7
- charging battery 1-5
- charging, temperature range 1-5
- cleaning 7-1
- clock, display 2-10
- cold boot 2-13, 4-3
- configuration ii
- conventions
 - notational iii
- cradles

- four-slot charge only cradle 6-4
- four-slot cradles
 - battery charging 6-4
- single-slot USB cradle
 - battery charging 6-3
- troubleshooting 7-9
- current time 2-5

D

- data capture ii
- dot aiming 3-4
- imager operational modes
 - decode mode 3-2
 - image capture mode 3-2
 - pick list mode 3-2
- imaging 3-1
- scanning 3-4
- two dimensional bar codes 3-1
- date/time 2-5
- demo window 2-2
- desktop window 2-2
- display ii
- display clock 2-10
- documentation updates iv
- documents 2-6

E

- electro-static discharge
- end task 2-9
- entering data with scanner 2-12
- entering information 2-11
- scanning 2-12
- Enterprise Mobility Developer Kit for .NET, see EMDK
- ESD 1-3

F

- favorites 2-6
- four-slot charge only cradle 1-6, 6-1, 6-4
- four-slot cradles
 - battery charging 6-4
- four-slot spare battery charger 1-6, 6-1
 - battery charging 6-7
 - LED indicators 6-7
 - troubleshooting 7-9
- function status 2-5

H

- hard reset 2-12, 2-13, 4-3

I

- icons
 - alpha mode 2-6
 - ALT 2-6
 - CTRL 2-6
 - function 2-6
 - shift 2-6
- imager. See data capture, imaging
- imaging 3-2
- indicator LED bar 6-3
- information, service iv
- Internet Explorer Mobile 2-7

K

- key combinations
 - using the keypad 2-2
- keypad 2-3
 - 27-key B-1
 - 28-key B-1
- keypads
 - input modes B-4

L

- laser scanning 3-3
- LEDs
 - scan and decode 3-4

M

- main battery 1-5
 - charging 1-3
 - inserting 1-3
- maintenance 7-1
- MC21XX charge cables
 - LED indicators 6-12
- MC21XX parts 1-3
- memory ii
- microphone 1-2
- mobile computer
 - cold boot 2-13
 - hard reset 2-12, 2-13
 - power on 2-1
 - reset 2-12
 - scanning 3-1
 - soft reset 2-12
 - warm boot 2-12
- MSP Agent 2-7

N

- navigating software 2-1

- numeric keypad
 - input modes B-4
- O**
- operating
 - environment A-1
 - operating system ii
- P**
- parts 1-2, 1-3, 2-17
- platform SDKiv
- power button 2-1
- power supply 6-1
- program menu 2-7
- properties 2-9
- R**
- radios ii
- rapid deployment 2-7
- remove battery 1-8
- remove the handstrap 6-15
- reset
 - hard 4-3
 - soft 4-3
- resetting 2-12
- resume 4-3
- run 2-7
- S**
- sample applications demo window 2-1
- scan 2-12
- scan buttons 1-2
- scanning 2-12
 - adjusting the distance 3-3
 - angle 3-2
 - imaging 3-1
 - range 3-2
- scanning considerations 3-2
- screen
 - calibration 1-7
- screen contrast 2-4
- SD card 1-3
 - installation 1-4
- secure device card 1-3
- security
 - Bluetooth 4-2
- selecting items using the keypad 2-3
- settings 2-7
- show clock 2-10
- single-slot USB cradle 1-6, 6-1, 6-3
 - battery charging 6-3
 - soft reset 2-12, 4-3
 - spare battery
 - charging 1-7
 - start menu 2-6
 - starting the mobile computer 1-3, 1-7
 - startup 1-3
 - status icon 2-5
 - storing 7-1
 - stylus 2-10, 2-11, 6-2
 - suspend 2-7, 4-3
- T**
- task manager 2-9
- taskbar 2-5
- technical specifications A-1
- temperature A-2
- terminal
 - charging 2-5
- terminal charging 2-5
- troubleshooting 7-6
 - cables 7-9
 - four-slot charge only cradle 7-8
 - four-slot spare battery charger 7-9
 - mobile computer 7-6
 - single-slot USB cradle 7-8
- turning the radios off
 - WLAN 1-9
- U**
- unpacking 1-1
- updates, documentation iv
- USB charging Cable 6-2
- USB charging cable 1-6
- using stylus 2-10
- W**
- wakeup conditions 2-13
- warm boot 2-12, 4-3
- Windows CE .NET 6.0 Professional 2-2, 2-7
- wireless status icon 2-6
- WLAN status 2-6
- WPAN Bluetooth ii

PRELIMINARY

PRELIMINARY



Motorola Solutions, Inc.
1301 E. Algonquin Rd.
Schaumburg, IL 60196-1078, U.S.A.
<http://www.motorolasolutions.com>

MOTOROLA, MOTO, MOTOROLA SOLUTIONS and the Stylized M Logo are trademarks or registered trademarks of Motorola Trademark Holdings, LLC and are used under license. All other trademarks are the property of their respective owners.

© 2011 Motorola Solutions, Inc. All Rights Reserved.

