

MC55E0



Quick Start Guide

FEATURES

Note: Remove protective shipping film that covers the touch screen, exit window and camera window before using.

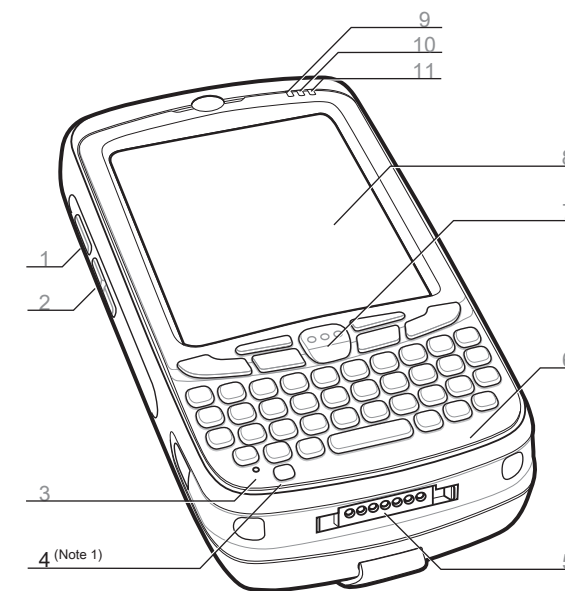

- 1 Scan/Action Button
- 2 Up/Down Button
- 3 Microphone
- 4 Power Button
- 5 I/O Connector
- 6 Keypad
- 7 Scan/Action Button
- 8 Touch Screen (with screen protector)
- 9 Scan/Decode LED
- 10 Charging/Battery Status LED
- 11 Not Used

Note 1: To reset the MC55, press and hold the Power button for five (5) seconds.

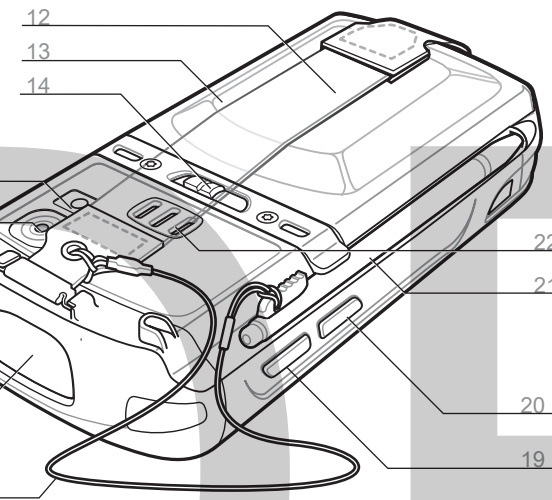

- 12 Handstrap
- 13 Battery
- 14 Battery Latch
- 15 Camera Flash (optional)
- 16 Camera (optional)
- 17 Exit Window (see Data Capture Options)
- 18 Tether
- 19 Scan/Action Button
- 20 Action Button
- 21 Stylus
- 22 Speaker

Notifications

Scan/Decode LED:

- Red: Scanning active
- Green: Good Decode

Charging/Battery Status LED:

- Slow blinking amber: Battery charging
- Solid amber: Fully charged
- Fast blinking amber: Charging error

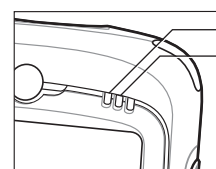

Scan/Decode
Charging/Battery Status

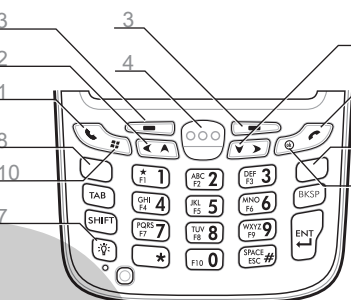

Numeric Keypad

Blue Key

Use this key to access function keys shown on the keypad in blue.
> Press the Blue key once to activate this state, followed by another key.

Orange Key

Use this key to access the secondary layer of characters.
> Press the Orange key once to lock the keypad into Alpha state.
> Press the Orange key a second time to return to the normal state.

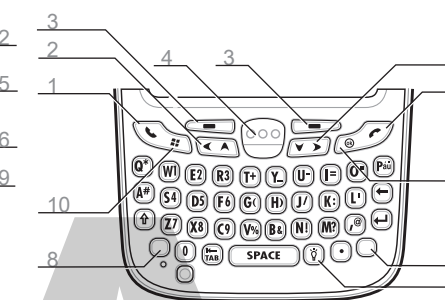

Alpha-Numeric Keypad

Blue Key

Use this key to access function keys shown on the keypad in blue.
> Press the Blue key once to activate this state temporarily, followed by another key.
> Press the Blue key twice to lock this state.
> Press the Blue key a third time to unlock.

Orange Key

Use this key to access the secondary layer of characters and actions.
> Press the Orange key once to activate this state temporarily, followed by another key.
> Press the Orange key twice to lock this state.
> Press the Orange key a third time to unlock.

BATTERY INSTALLATION

Insert the Battery

1. Insert the battery, bottom first, into the battery compartment.
2. Press down on the battery until the battery latch snaps into place.
3. Replace the handstrap.

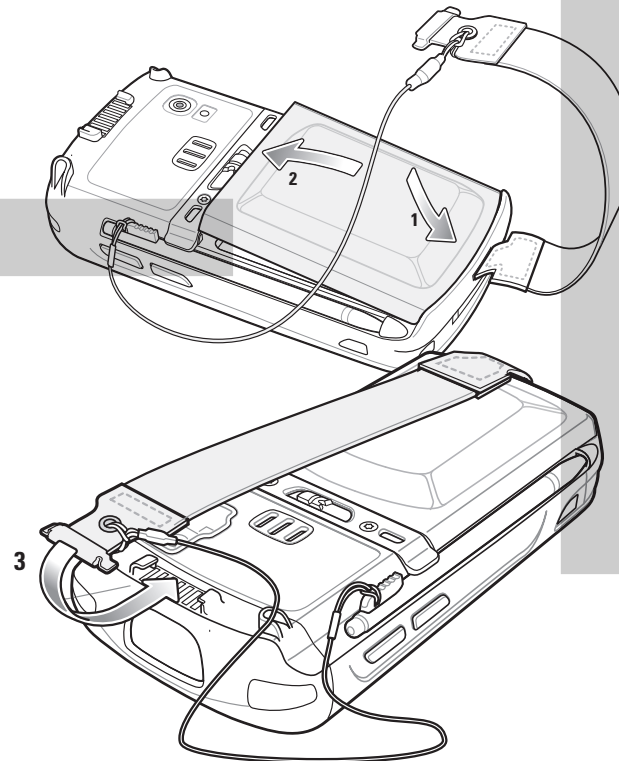

CHARGING

Charge the MC55

Use the Single-slot cradles (USB or Ethernet/Modem/USB), Four-slot cradles (Charge Only or Ethernet) or cables to charge the battery in the MC55.

You can also charge a spare battery using the Single-slot cradle.

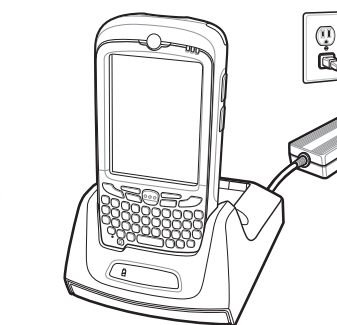

- Charging/Battery Status LED
- Slow Blinking Amber = Charging
- Solid Amber = Fully charged
- Fast Blinking Amber = Charging error

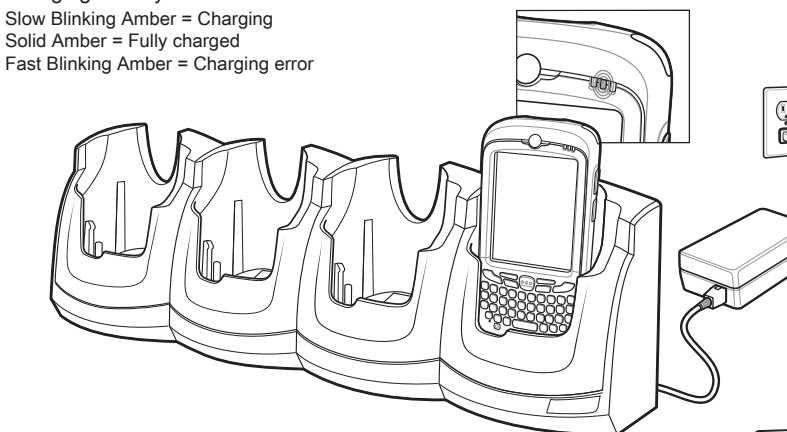

Charge the Battery

Use the Four-slot Battery Charger to charge batteries separately.

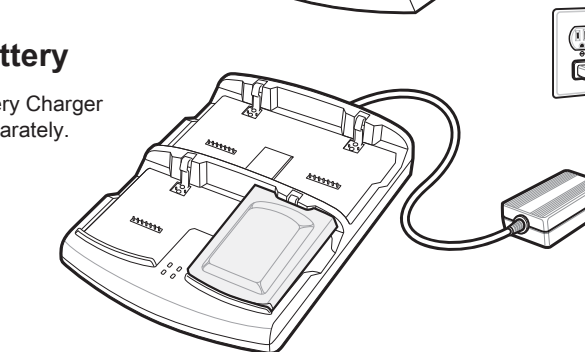

Note: The 3600 mAh battery charges in less than six hours.

COMMUNICATION

Install Synchronization Software

Download ActiveSync® or Windows Mobile Device Center from <http://www.microsoft.com> and follow the instructions to install the software onto the host computer.

Communicate with Host

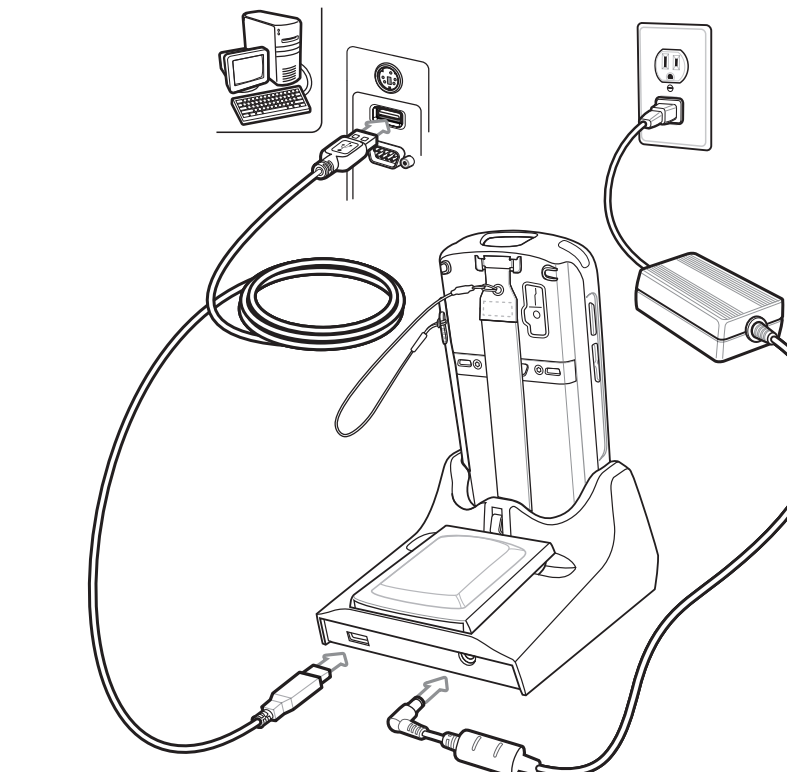

Create a Partnership

Follow the on-screen instructions to establish a connection between the MC55 and the host computer.



ZEBRA

MORE INFORMATION

Setting up, using and troubleshooting the MC55E0

MC55E0 User Guide and Integrator Guide
Software Upgrades
Available at: www.zebra.com/support

Additional Software

Check Zebra web site for approved applications.
www.zebra.com/mc55

Connecting and synchronizing with the host computer

ActiveSync® Help on the host computer. To view help, start ActiveSync®, Click Help - Microsoft ActiveSync Help.
ActiveSync software available at www.microsoft.com.
Information on using programs on the MC55E0
Tap **Start** – **Help** within the specific program.

Service and Warranty

MC55E0 Regulatory Guide
Available with MC55E0 and at www.zebra.com/support



Zebra Technologies Corporation
Lincolnshire, IL U.S.A.
© 2017 ZIH Corp and/or its affiliates. All rights reserved. ZEBRA and the stylized Zebra head are trademarks of ZIH Corp, registered in many jurisdictions worldwide. All other trademarks are the property of their respective owners.



MN-003059-01 Rev. A — August 2017

ACCESSORIES

Screen Protector



Zebra recommends the continued use of a screen protector to minimize wear and tear. Screen protectors enhance the usability and durability of touch screen displays. Benefits include:

- Protection from scratches and gouges
- Durable writing and touch surface with tactile feel
- Abrasion and chemical resistance
- Glare reduction
- Keeping the device's screen looking like new
- Quick and easy installation.

Not using a screen protector can affect your warranty coverage. An initial screen protector is already applied to your MC55E0. Contact your local account manager or Zebra for more information and purchasing details. Part number: KT-67525-01R Screen Protector 3/pk.

MicroSD Card Installation

1. Remove battery.
2. Lift rubber access door.
3. Slide SIM card holder up to unlock.
4. Lift SIM card holder.
5. Carefully lift microSD card holder.
6. Insert microSD card into card holder.

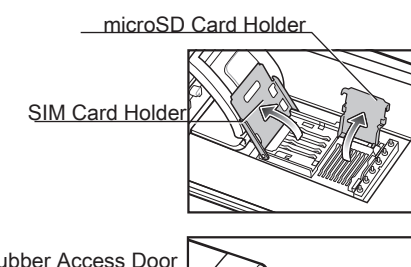

NOTE :

Proper position of the microSD card — the card connector (i.e., gold contacts) should be facing out as shown.

7. Close the microSD card holder.
8. Close the SIM card holder.
9. Slide the SIM card holder down to lock into place.
10. Close rubber access door.
11. Replace battery.

www.zebra.com/MC55

Single-slot USB Cradle Single-slot Ethernet/Modem/USB Cradle

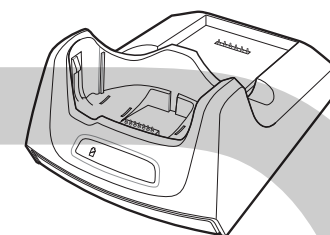

Four-slot Battery Charger

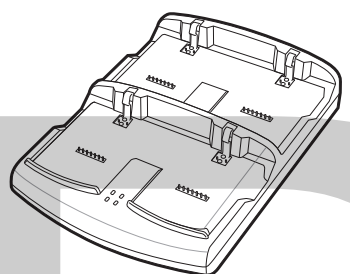

Charge Only Cable

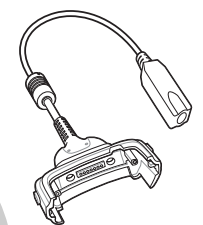

USB/Charge Cable

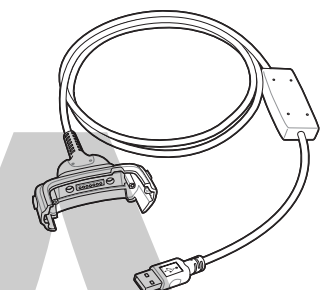

Magnetic Stripe Reader

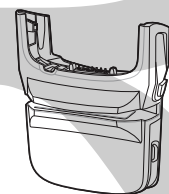

Vehicle Cradle

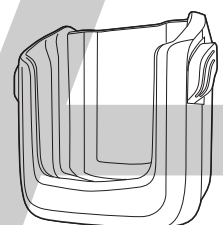

Four-slot Charge Only Cradle Four-slot Ethernet Cradle

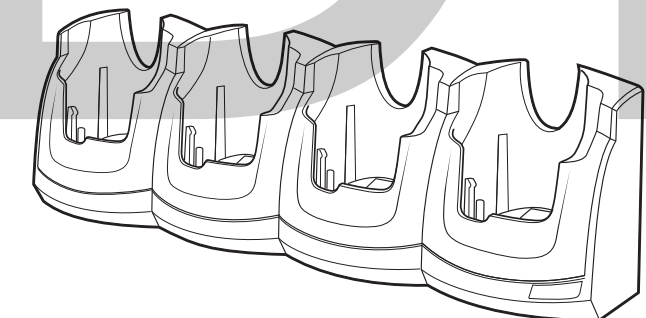

Trigger Handle

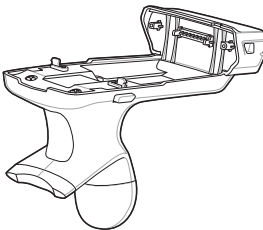

Auto Charge Cable

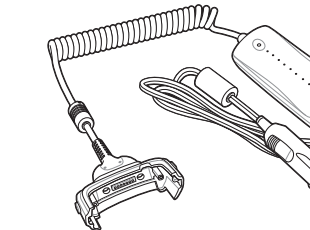

Vehicle Holder

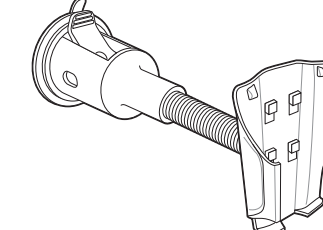

DATA CAPTURE OPTIONS

Imaging

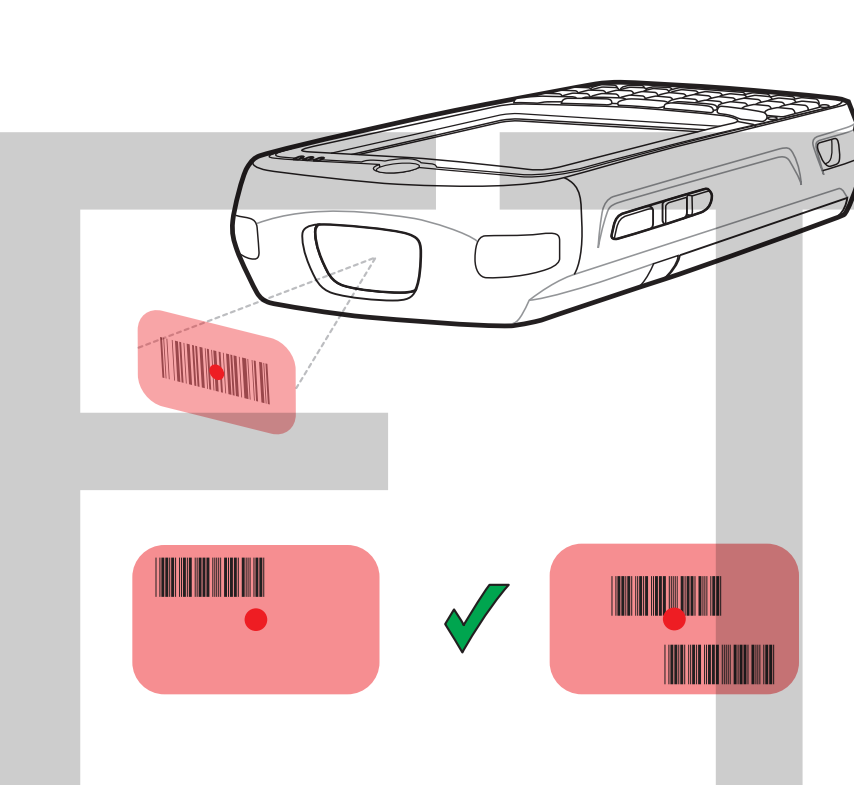

Camera Decode

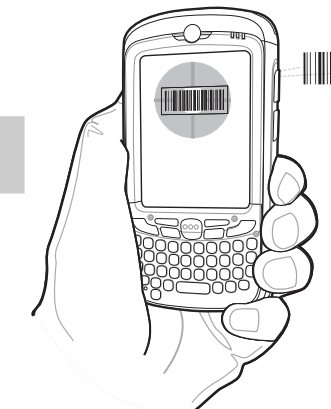

1. Launch a bar code reading application on the MC55E0.
2. Position the MC55E0 toward the bar code.
3. Press the **Scan** button.
4. In the image window align the red target over the bar code. When the MC55E0 decodes the bar code the Scan/Decode LED light green and a beep sounds.
5. Release the **Scan** button.

Camera Photo

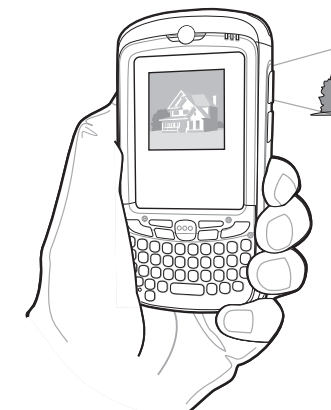

1. Tap **Start** > **Pictures & Videos** > **Camera**.
2. Point the MC55E0 at an object.
3. Press the **Enter** button.
4. Hold MC55E0 still until "Shutter Sound" is heard.

AVOID EXTREME WRIST ANGLES

