



TC8000



Review Copy

Touch Computer

User Guide



Review Copy

**TC8000
User Guide**

MN002410A01

Rev. A

October 2015

Review Copy

No part of this publication may be reproduced or used in any form, or by any electrical or mechanical means, without permission in writing. This includes electronic or mechanical means, such as photocopying, recording, or information storage and retrieval systems. The material in this manual is subject to change without notice.

The software is provided strictly on an “as is” basis. All software, including firmware, furnished to the user is on a licensed basis. We grant to the user a non-transferable and non-exclusive license to use each software or firmware program delivered hereunder (licensed program). Except as noted below, such license may not be assigned, sublicensed, or otherwise transferred by the user without prior written consent. No right to copy a licensed program in whole or in part is granted, except as permitted under copyright law. The user shall not modify, merge, or incorporate any form or portion of a licensed program with other program material, create a derivative work from a licensed program, or use a licensed program in a network without written permission. The user agrees to maintain copyright notice on the licensed programs delivered hereunder, and to include the same on any authorized copies it makes, in whole or in part. The user agrees not to decompile, disassemble, decode, or reverse engineer any licensed program delivered to the user or any portion thereof.

We reserve the right to make changes to any software or product to improve reliability, function, or design.

We do not assume any product liability arising out of, or in connection with, the application or use of any product, circuit, or application described herein.

No license is granted, either expressly or by implication, estoppel, or otherwise under any of our intellectual property rights. An implied license only exists for equipment, circuits, and subsystems contained in our products.

Zebra Technologies Corporation
3 Overlook Point
Lincolnshire, IL 60069 U.S.A.
<http://www.zebra.com>

Zebra and the stylized Zebra head are trademarks of ZIH Corp., registered in many jurisdictions worldwide. All other trademarks are the property of their respective owners.

© 2015 Symbol Technologies LLC. All rights reserved.

Revision History

Changes to the original manual are listed below:

Change	Date	Description
01 Rev. A		Initial release.

Review Copy

Review Copy

TABLE OF CONTENTS

Revision History	iii
------------------------	-----

About This Guide

Introduction	xi
Documentation Set	xi
Configurations	xi
Software Versions	xii
Chapter Descriptions	xii
Notational Conventions	xii
Related Documents and Software	xiii
Service Information	xiii

Chapter 1: Getting Started

Introduction	1-1
Unpacking	1-1
Removing the Screen Protection Film	1-1
Setup	1-4
Installing the Battery	1-4
Charging the Battery	1-5
Starting the TC8000	1-6
Installing the Hand Strap	1-7
Replacing the Battery	1-9
Battery Management	1-10
Monitor Battery Usage	1-10
Low Battery Notification	1-11
Battery Optimization	1-11
Turning Off the Radios	1-12
Setting the Date and Time	1-12
Display Setting	1-12
Setting the Screen Brightness	1-13
Setting Screen Timeout Setting	1-13
Setting Font Size	1-13

General Sound Setting	1-14
Wake-Up Sources	1-15

Chapter 2: Using the TC8000

Introduction	2-1
Home Screen	2-1
Status Bar	2-2
Status Icons	2-2
Notification Icons	2-3
Managing Notifications	2-4
Application Shortcuts and Widgets	2-5
Adding an Application or Widget to the Home Screen	2-5
Moving Items on the Home Screen	2-5
Removing an App or Widget from the Home Screen	2-5
Folders	2-5
Creating a Folder	2-5
Naming Folders	2-5
Removing a Folder	2-6
Home Screen Wallpaper	2-6
Changing the Home Screen Wallpaper	2-6
Using the Touchscreen	2-6
Using the On-screen Keyboard	2-7
Editing Text	2-7
Entering Numbers, Symbols and Special Characters	2-7
Applications	2-8
Accessing Applications	2-10
Switching Between Recent Applications	2-10
Un-Locking the Screen	2-11
Single User Mode	2-11
MultiUser Mode	2-13
MultiUser Login	2-13
MultiUser Logout	2-13
Suspend Mode	2-14
Performing a Soft Reset	2-15
Performing a Hard Reset	2-15

Chapter 3: Data Capture

Introduction	3-1
Status LED	3-1
Laser Scanning	3-2
Imaging	3-2
Operational Modes	3-2
Digital Camera	3-2
Scanning Considerations	3-3
Bar Code Capture with Laser Scanner	3-3
Bar Code Capture with Imager	3-4
Bar Code Capture with Camera	3-6
Bar Code Capture with RS507 Hands-Free Imager	3-7

Pairing the RS507 Hands-Free Imager Using SSI	3-8
Pairing the RS507 Hands-Free Imager Using Bluetooth HID	3-9
Hands Free Scanning	3-10
Scanning Mode	3-10
Proximity Range	3-11
Proper Scanning	3-12
Improper Scanning	3-13
Enable DataWedge	3-14
Disable DataWedge	3-14

Chapter 4: Wireless

Wireless Local Area Networks	4-1
Scan and Connect to a Wi-Fi Network	4-2
Configuring a Wi-Fi Network	4-3
Manually Adding a Wi-Fi Network	4-4
Configuring for a Proxy Server	4-5
Configuring the Device to Use a Static IP Address	4-6
Advanced Wi-Fi Settings	4-6
Remove a Wi-Fi Network	4-8
Wi-Fi Advanced Features	4-8
Zebra Mobility Extensions	4-9
Bluetooth	4-10
Adaptive Frequency Hopping	4-10
Security	4-10
Bluetooth Profiles	4-11
Bluetooth Power States	4-11
Bluetooth Radio Power	4-11
Enabling Bluetooth	4-11
Disabling Bluetooth	4-12
Discovering Bluetooth Device(s)	4-12
Changing the Bluetooth Name	4-13
Connecting to a Bluetooth Device	4-13
Selecting Profiles on the Bluetooth Device	4-13
Unpairing a Bluetooth Device	4-13
Near Field Communications	4-14
Reading NFC Cards	4-14
Sharing Information Using NFC	4-15
Enterprise NFC Settings	4-15
Reader Mode	4-17

Chapter 5: Applications

Introduction	5-1
File Browser	5-1
Adding People	5-3
Editing People	5-3
Deleting People	5-3
Taking Photos	5-4
Taking a Panoramic Photo	5-6

Recording Videos	5-7
Photo Settings	5-9
Video Settings	5-11
Working with Albums	5-12
Share an Album	5-13
Get Album Information	5-13
Deleting an Album	5-13
Working with Photos	5-14
Viewing and Browsing Photos	5-14
Cropping a Photo	5-14
Setting a Photo as a Contact Icon	5-15
Share a Photo	5-15
Deleting a Photo	5-16
Working with Videos	5-16
Watching Videos	5-16
Sharing a Video	5-16
Deleting a Video	5-17
RxLogger Configuration	5-20
Configuration File	5-20
Enabling Logging	5-20
Disabling Logging	5-20
Extracting Log Files	5-21
Disabling Elemez Data Collection	5-22
Enabling Elemez Data Collection	5-23

Chapter 6: Accessories

Accessories	6-1
Battery Charging	6-4
Main Battery Charging	6-4
Spare Battery Charging	6-4
Charging Temperature	6-5
Charging the TC8000	6-6
Battery Charging	6-7
Main Battery Charging	6-7
Battery Charging	6-9
Main Battery Charging	6-9
Spare Battery Charging	6-9
Charging Temperature	6-9
Charging the TC8000	6-10
Battery Charging	6-11
Main Battery Charging	6-11
Charging Temperature	6-11
Establishing Ethernet Communication	6-11
Ethernet LED Indicators	6-11
Charging the TC8000	6-12
Battery Charging	6-13
Main Battery Charging	6-13
Spare Battery Charging	6-13
Charging Temperature	6-13

Establishing Ethernet Communication	6-13
Ethernet LED Indicators	6-14
Battery Installation	6-15
Battery Removal	6-16
Battery Charging	6-16
Spare Battery Charging	6-16
Charging Temperature	6-16
Attaching the USB and Charging Cable	6-18
USB Communication	6-18
Removing the USB and Charging Cable	6-19
Battery Charging	6-19
Main Battery Charging	6-19
Attaching the Audio Adapter	6-21
Connecting the Adapter to a Headset	6-21
Removing the Audio Adapter	6-21
Attaching the Audio Adapter	6-23
Removing the Audio Adapter	6-23
Chapter 7: Maintenance and Troubleshooting	
Introduction	7-1
Maintaining the TC8000	7-1
Battery Safety Guidelines	7-1
Long Term Storage	7-2
Cleaning	7-2
Materials Required	7-2
Cleaning the TC8000	7-3
Housing	7-3
Display	7-3
Scan Exit Window	7-3
Power Connector	7-3
Cleaning Cradle Connectors	7-3
Cleaning Frequency	7-4
TC8000	7-5
Cradles	7-7
Appendix A: Specifications	
Technical Specifications	A-1

Index

Review Copy

ABOUT THIS GUIDE

Introduction

This guide provides information about setting up and configuring TC8000 mobile computers with Android operating system and installing its accessories.

✓ **NOTE** Some screens or windows shown in this guide may differ from the actual screens shown on the TC8000.

Documentation Set

The documentation set for the TC8000 is divided into guides that provide information for specific user needs.

TC8000 documentation includes:

- **TC8000 Quick Reference Guide** - describes basic set up and operation of the TC8000 and it's cradles. The guide also includes regulatory and safety information.
- **TC8000 User Guide** (this guide) - describes how to set up, operate and program the TC8000 with Android operating system and it's accessories.
- **TC8000 Integrator Guide** - describes how to setup and configure TC8000 and accessories.

Configurations

This guide covers the following configurations:

Configuration	Radios	Display	Memory	Data Capture Options	Operating System
TC80N0	WLAN: 802.11 a/b/g/n WPAN: Bluetooth v4.0	WVGA 4.0" color	1 GB RAM/8 GB Flash	SE4750-SR imager SE4850 long range imager	Android Open Source Project (AOSP) 4.4.3.
TC80NH	WLAN: 802.11 a/b/g/n WPAN: Bluetooth v4.0 NFC	WVGA 4.0" color	1 GB RAM/8 GB Flash	SE4750-SR imager SE4850 long range imager	Android Open Source Project (AOSP) 4.4.3.

Software Versions

To determine the current software versions touch  > **About device**.

- Serial number - Displays the serial number.
- Model number- Displays the model number.
- Android version - Displays the operating system version.
- Kernel version - Displays the kernel version number.
- Build number - Displays the software build number.

Chapter Descriptions

Topics covered in this guide are as follows:

- *Chapter 1, Getting Started*, describes the features and basic operation of the TC8000, lists the accessories for the TC8000 and explains how to install and charge the batteries and start the TC8000 for the first time.
- *Chapter 2, Using the TC8000*, provides instructions for connecting the TC8000 to a host computer and using the OS desktop of the TC8000.
- *Chapter 3, Data Capture*, provides information for capturing bar code data.
- *Chapter 4, Wireless*, provides information on the various wireless options.
- *Chapter 5, Applications*, provides information on various applications pre-installed on the TC8000.
- *Chapter 6, Accessories*, Accessories, provides information for using the accessories with the TC8000.
- *Chapter 7, Maintenance and Troubleshooting*, includes instructions on cleaning and storing the TC8000, and provides troubleshooting solutions for potential problems during TC8000 operation.
- *Appendix A, Specifications*, includes a table listing the technical specifications for the TC8000 and accessories.

Notational Conventions

The following conventions are used in this document:

- *Italics* are used to highlight the following:
 - Chapters and sections in this guide
 - Related documents
- **Bold** text is used to highlight the following:
 - Dialog box, window and screen names
 - Drop-down list and list box names
 - Check box and radio button names
 - Icons on a screen
 - Key names on a keypad
 - Button names on a screen

- Bullets (•) indicate:
 - Action items
 - Lists of alternatives
 - Lists of required steps that are not necessarily sequential
 - Sequential lists (e.g., those that describe step-by-step procedures) appear as numbered lists.
- ✓ **NOTE** This symbol indicates something of special interest or importance to the reader. Failure to read the note will not result in physical harm to the reader, equipment or data.



CAUTION This symbol indicates that if this information is ignored, the possibility of data or material damage may occur.



WARNING! This symbol indicates that if this information is ignored the possibility that serious personal injury may occur.

Related Documents and Software

The following documents provide more information about the TC8000 touch computers.

- *TC8000 Regulatory Guide*, p/n MN002270Axx
- *TC8000 Integrator Guide*, p/n MN002411Axx

For the latest version of this guide and all guides, go to: <http://www.zebra.com/support>

Service Information

If you have a problem with your equipment, contact Customer Support for your region. Contact information is available at: <http://www.zebra.com/support>.

When contacting Customer Support, please have the following information available:

- Serial number of the unit
- Model number or product name
- Software type and version number.

We respond to calls by E-mail, or telephone within the time limits set forth in support agreements.

If your problem cannot be solved by Zebra Support, you may need to return your equipment for servicing and will be given specific directions. Zebra is not responsible for any damages incurred during shipment if the approved shipping container is not used. Shipping the units improperly can possibly void the warranty.

If you purchased your business product from a business partner, contact that business partner for support.

Review Copy

CHAPTER 1 GETTING STARTED

Introduction

This chapter describes the features of the TC8000 and explains how to install and charge the battery and how to reset the TC8000.

Unpacking

Carefully remove all protective material from the TC8000 and save the shipping container for later storage and shipping.

Verify that box contains all the equipment listed below:

- TC8000
- Battery
- Regulatory Guide.

Inspect the equipment for damage. If you are missing any equipment or if you find any damaged equipment, contact Support immediately. See [Service Information on page xiii](#) for contact information.

Removing the Screen Protection Film

A screen protection film is applied to the TC8000 screen to protect the screen during shipping. To remove the screen protector, carefully lift the thin film off the display.

Features

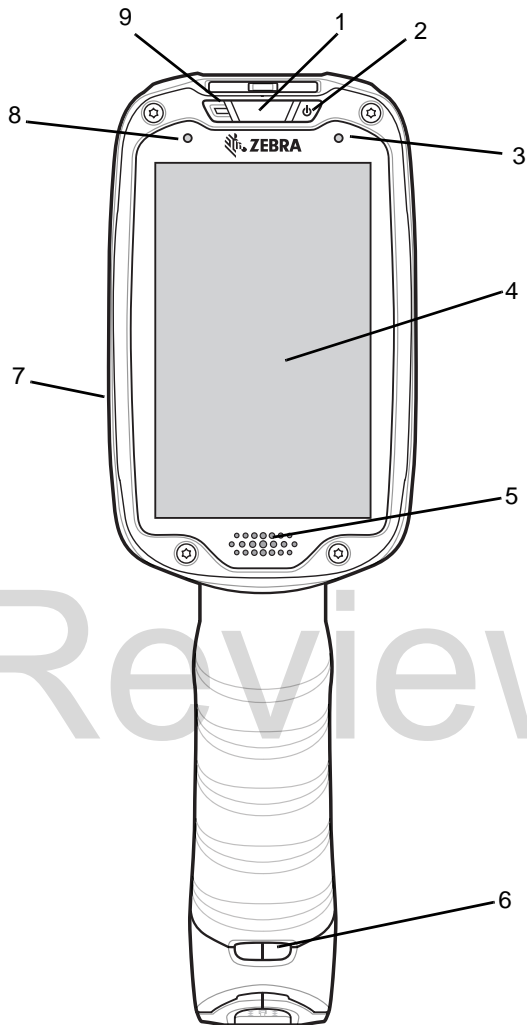

Figure 1-1 Front View

Table 1-1 Front View Descriptions

Number	Item	Function
1	Charging/Scan LED	Indicates battery charging status while charging, good decode indication during data capture and application generated notifications.
2	Power Button	
3	Blue Indication LED	User programmable LED.
4	Display	Displays all information needed to operate the TC8000.
5	Touch Button	Press to select items or
6	Hand Strap Mounting Point	

Table 1-1 Front View Descriptions (Continued)

Number	Item	Function
7	Speakers	Provides audio output for video and music playback.
8	Ambient Light Sensor	
9	Microphone	Use for communication in handset mode.

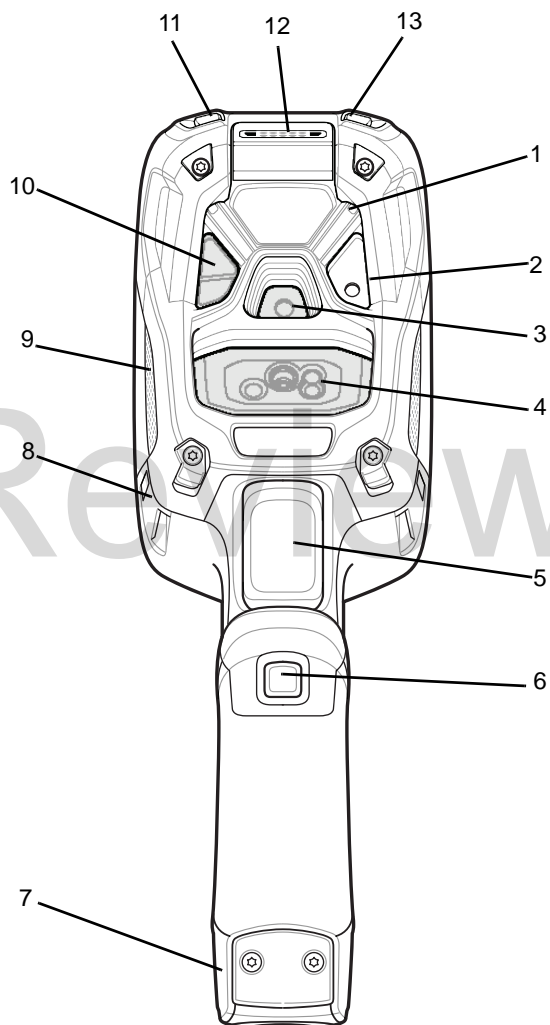
**Figure 1-2** Back View**Table 1-2** Back View Descriptions

Number	Item	Function
1	Rear Microphone	Use during video recording and noise cancellation.
2	Camera Flash	Provides illumination for the camera.
3	Camera	Takes photos and videos.

Table 1-2 Back View Descriptions (Continued)

Number	Item	Function
4	Scanner	Provides data capture using the imager or laser scanner.
5	Trigger	Initiates data capture.
6	Push -To-Talk (PTT) Button	
7	Battery Pack	Provides power to the device.
8	Hand Strap Mounting Point	
9	Speaker	
10	Proximity Sensor	Long range proximity sensor (optional).
11	Volume Up Button	Decreases audio volume.
12	I/O Connector	
13	Volume Up Button	Increases audio volume.

Setup

Perform these procedures to start using the TC8000 for the first time.

1. Install the battery.
2. Charge the TC8000.
3. Power on the TC8000.

Installing the Battery

To install the battery:

1. Slide the battery into the handle of the device.

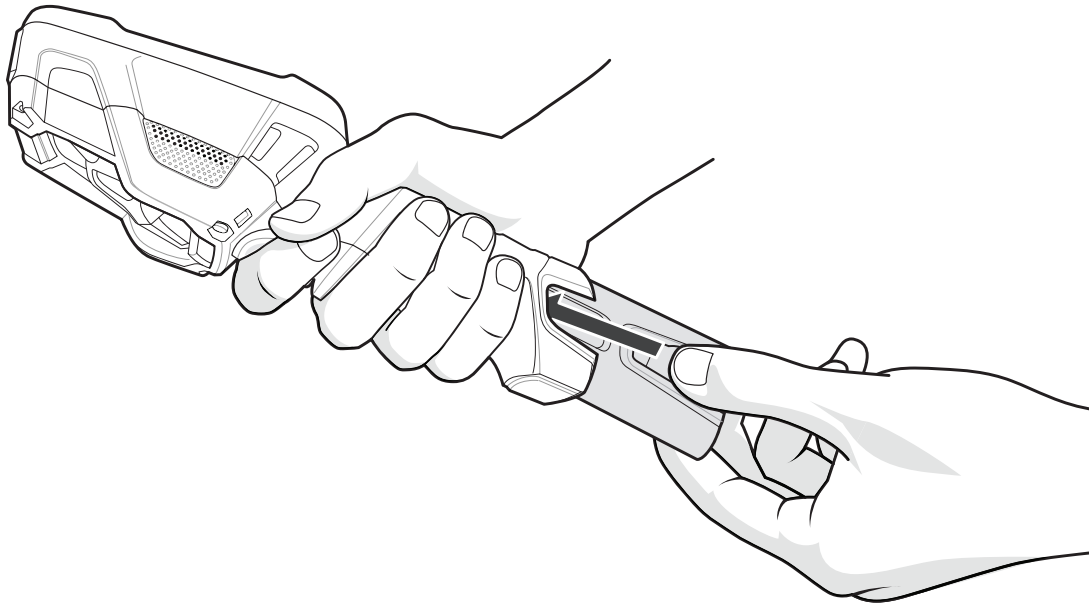

Figure 1-3 *Battery Installation*

2. Snap battery into place.

Charging the Battery

Before using the TC8000 for the first time, charge the battery using a cable or a cradle with the appropriate power supply. For information about the accessories available for the TC8000, see [Chapter 6, Accessories](#).

- 4-Slot Battery Charger
- 2-Slot USB Charge Cradle
- 5-Slot Charge Only Cradle
- 5-Slot Ethernet Cradle
- 5-Slot Charge Only Cradle with 4-Slot Battery Charger
- 5-Slot Charge Only Cradle with 4-Slot Battery Charger.

The 6,400 mAh battery fully charges in approximately six hours at room temperature.

Charge batteries in temperatures from 0 °C to 40 °C (32 °F to 104 °F). The TC8000 or accessory always performs battery charging in a safe and intelligent manner. At higher temperatures (e.g. approximately +37 °C (+98 °F)) the TC8000 or accessory may for small periods of time alternately enable and disable battery charging to keep the battery at acceptable temperatures. The TC8000 or accessory indicates when charging is disabled due to abnormal temperatures via its LED.

1. To charge the main battery, connect the charging accessory to the appropriate power source.
2. Insert the TC8000 into a cradle or attach to a cable. The TC8000 turns on and begins charging. The Charging/Scan LED blinks amber while charging, then turns solid green when fully charged.

Table 1-3 Charging/Scan LED Charging Indicators

State	Indication
Off	TC8000 is not charging. TC8000 is not inserted correctly in the cradle or connected to a power source. Charger/cradle is not powered.
Solid Amber	TC8000 is charging.
Solid Green	Charge complete.
Fast Blinking Red (2 blinks/second)	Charging error, e.g.: - Temperature is too low or too high. - Charging has gone on too long without completion (typically eight hours).
Solid Red	Battery hot swap mode.



IMPORTANT When trying to power on the device, a quick blink of the charging LED indicates that it does not have enough battery power to turn on. You will need to charge the battery or replace it.

Starting the TC8000

The TC8000 starts automatically as soon as power is applied; either with a charged battery installed or when inserted into a cradle.

If charged battery is installed and the TC8000 is turned off, press the Power button to turn on.

When the TC8000 is powered on for the first time, it initializes its system. The splash screen appears for a short period of time.

NEED DRAWING

Figure 1-4 Splash Screen

The splash screen is followed by the boot animation screen and then the **Home Screen**.



Figure 1-5 Home Screen

Installing the Hand Strap

To install the hand strap:

✓ **NOTE** Installation of the hand strap is optional. Skip this section if not installing the hand strap.

1. Remove battery if installed.
2. Thread the lanyard loop through the opening near the base of the handle.

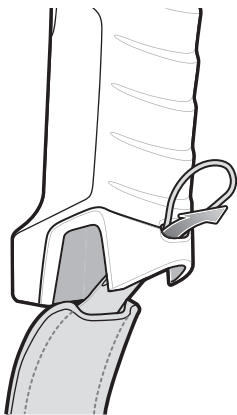

Figure 1-6 Insert Loop through Handle Slot

3. Insert the top end of the hand strap through the loop.

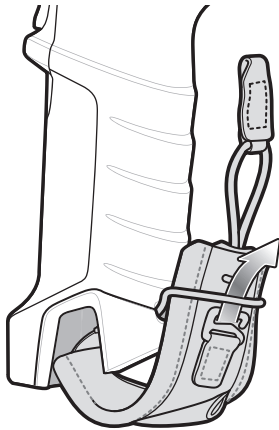

Figure 1-7 *Thread Hand Strap Through Loop*

4. Thread the hand-strap through the lanyard.
5. Pull the hand strap through the loop.
6. Thread the lanyard through the slot on the left or right side of the unit, depending on your preference.

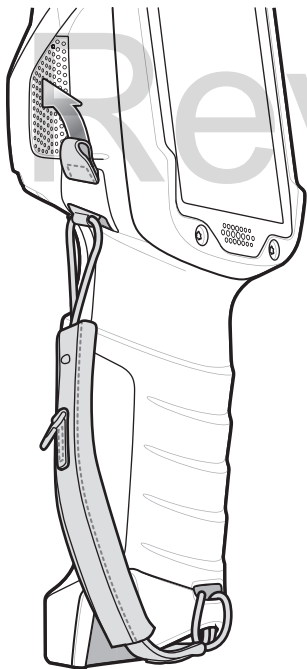

Figure 1-8 *Tread Tab Through Side Slot*

7. Slide the tab onto the clip.

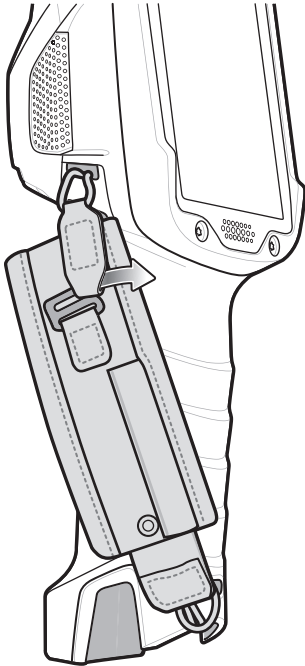

Figure 1-9 *Slide Tab onto Clip*

Replacing the Battery

To remove the battery:

1. Press the two battery release latches in.

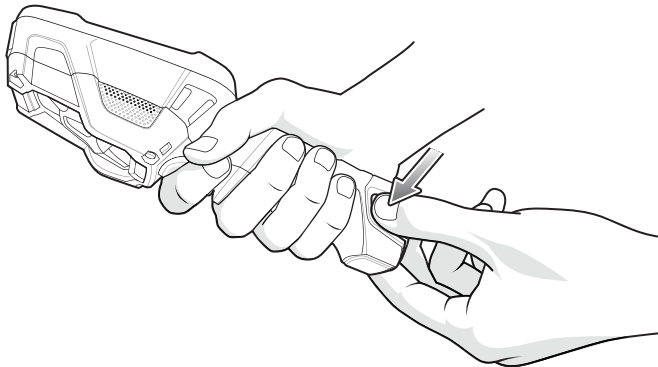

Figure 1-10 *Battery Removal*

2. Pull the battery out of the device.

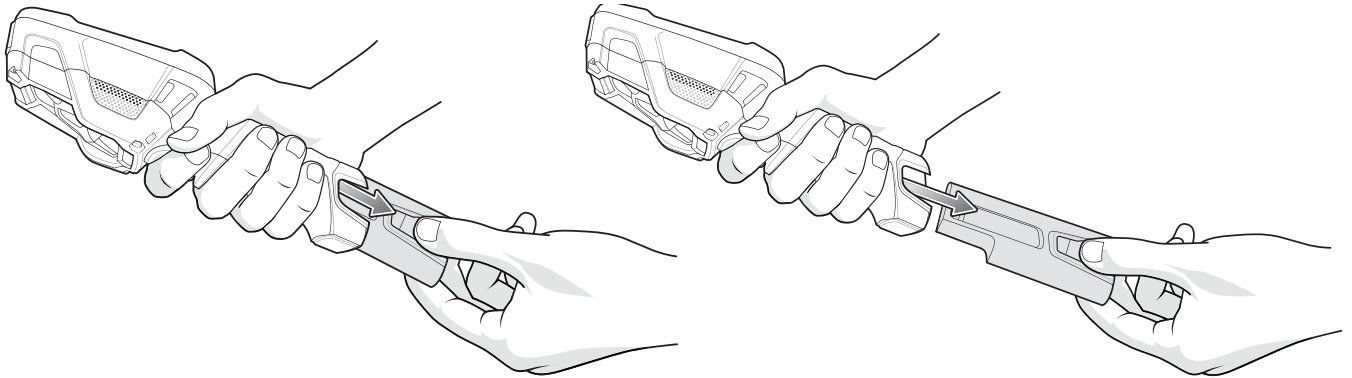

Figure 1-11 *Battery Removal*

3. Slide the replacement battery into the handle.

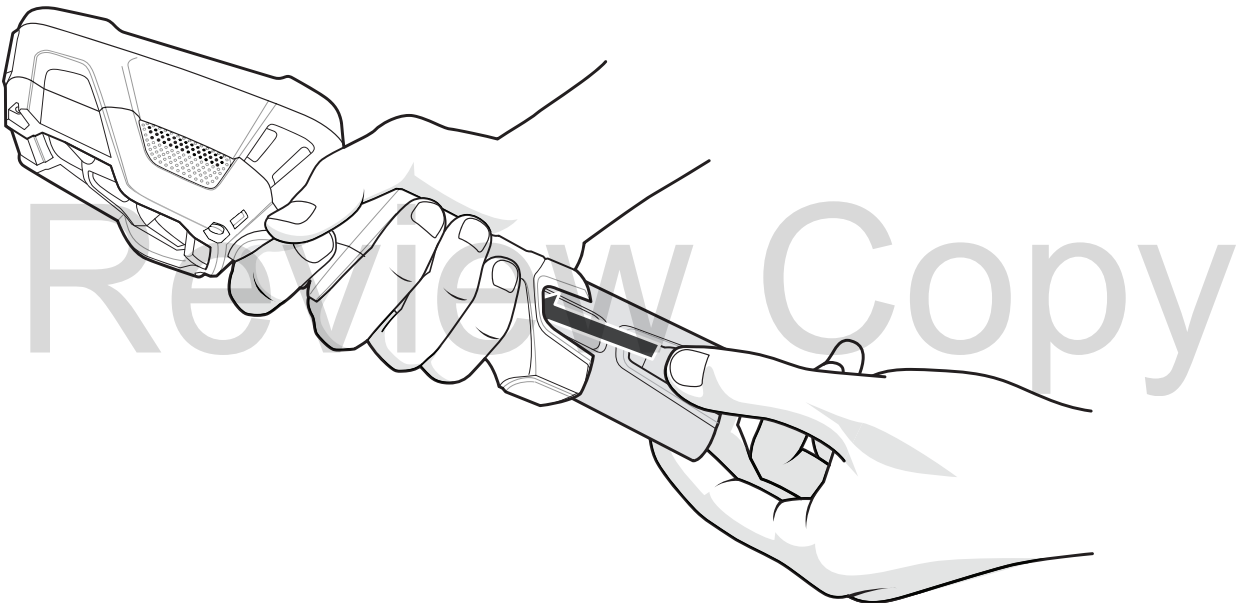



Figure 1-12 *Battery Installation*

4. Press the battery into the handle until it snaps into place.

Battery Management

To check the charge status of the main battery, on the Home screen touch  >  **About device** > **Status**.

Battery status indicates that the battery is discharging (not charging) and **Battery level** lists the battery charge (as a percentage of fully charged).

Monitor Battery Usage

The Battery screen lists which applications consume the most battery power. Also use it to turn off applications that were downloaded if they are consuming too much power.

Touch  > **Battery**.



Figure 1-13 *Battery Screen*

The Battery screen lists the applications using the battery. The discharge graph at the top of the screen shows the rate of the battery discharge since last charged (short periods of time when connected to a charger are shown as thin green lines at the bottom of the chart), and how long it has been running on battery power.

Touch an application in the Battery screen to display details about its power consumption. Different applications display different information. Some applications include buttons that open screens with settings to adjust power use.

Low Battery Notification

When the battery charge level drops below 15%, the TC8000 displays a notice to connect the TC8000 to power. Place the TC8000 into a cradle to charge the battery.

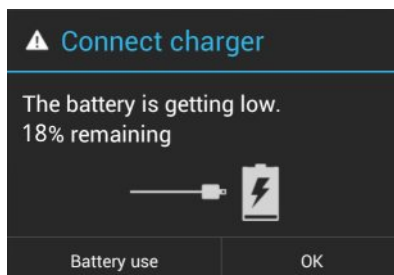

Figure 1-14 *Low Battery Notification*

When the battery charge drops below 10%, the TC8000 displays a notice to connect the TC8000 to power. The user must charge the battery using one of the charging accessories.

When the battery charge drops below 5%, the TC8000 turns off.

TC8000Place the TC8000 into a cradle to charge the battery.

Battery Optimization

Observe the following battery saving tips:

- Set the screen to turn off after a short period of non-use. See [Setting Screen Timeout Setting on page 1-13](#).

- Reduce screen brightness. See [Setting the Screen Brightness on page 1-13](#).
- Turn off all wireless radios when not in use.
- Turn off automatic syncing for Email, Calendar, Contacts and other applications.
- Use the Power Control widget to check and control the status of radios, the screen brightness, and syncing.
- Minimize use of applications that keep the TC8000 from suspending, for example, music and video applications.

Turning Off the Radios



To turn off all the radios:

✓ **NOTE** Alternately, you can place the device into **Airplane mode** using the **Quick Settings** option.

1. Press the power button until the menu appears.
2. Touch **Airplane mode**. The airplane icon  appears in the Status bar indicating that all the radios are off.

Setting the Date and Time

The date and time is automatically synchronized using a NITZ server when the TC8000 is connected to a cellular network. The user is only required to set the time zone or set the date and time when not connected to a cellular network.

1. Touch  >  **Date & time**.
2. Touch **Automatic date & time** to disable automatic date and time synchronization.
3. Touch **Set date**.
4. Move the sliders up and down to select the month, date and year.
5. Touch **Done**.
6. Touch **Set time**.
7. Move the sliders up and down to select the hour, minutes and part of the day.
8. Touch **Done**.
9. Touch **Select time zone**.
10. Select the current time zone from the list.
11. Touch .

Display Setting

Use Display settings to change the screen brightness, set sleep time and change font size.

Setting the Screen Brightness

To set the screen brightness:

1. Touch  >  **Display**.
2. Touch **Brightness**.

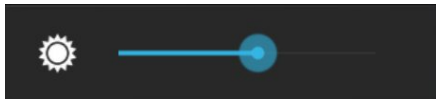





Figure 1-15 *Brightness Dialog Box*

3. In the Brightness dialog box, use the slider to set a brightness level.
4. Touch .



Setting Screen Timeout Setting

To set the screen sleep time:





1. Touch  >  **Display** > **Sleep**.
2. Select one of the sleep values.
 - **15 seconds**
 - **30 seconds**
 - **1 minute**
 - **2 minutes**
 - **5 minutes** (default)
 - **10 minutes**
 - **30 minutes**
 - **Never.**
3. Touch .

Setting Font Size

To set the size of the font in system applications:

1. Touch  >  **Display** > **Font size**.
2. Select one of the font size values.
 - **Small**
 - **Normal** (default)
 - **Large**
 - **Huge.**
3. Touch .

General Sound Setting

Use the Sounds settings to configure media and alarm volumes. On the Home screen, touch  >  **Sounds**. Alternately, touch the Status bar and drag down to open the Notification panel. Touch  >  >  **Sounds**.

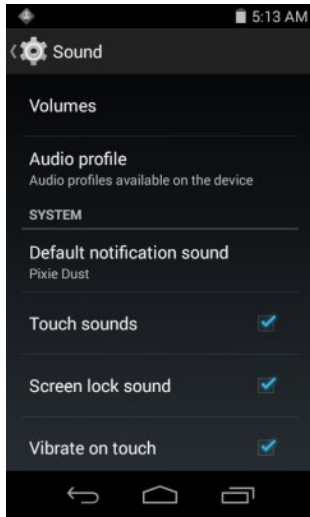

Figure 1-16 Sounds Screen

- **Volumes** – Use to change the volume of media, ringtones, notifications and alarms.

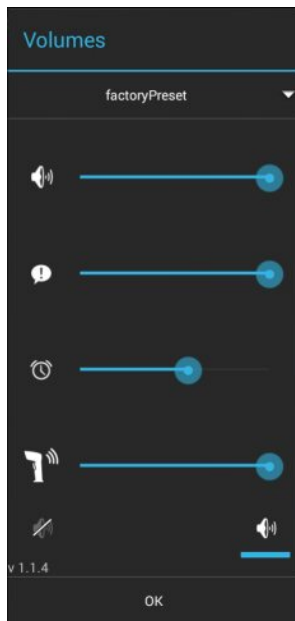









Figure 1-17 Volumes Dialog Box

-  - Controls the music and media volume.
-  - Controls the system notification volume.
-  - Controls the alarm clock volume.
-  - Controls the scan good decode beep volume.
- Bottom row icons:
 -  - Places the system notification in silent mode.
 -  - Places the system notification in sound mode.
- **System**
 - **Default notification sound** - Touch to select a sound to play for all system notifications.
 - **Touch sounds** - Check to play a sound when making screen selections (default – enabled).
 - **Screen lock sounds**- Check to play a sound when locking and unlocking the screen (default – disabled).

Wake-Up Sources

By default the TC8000 wakes from suspend mode when one of the activities in the screen below occurs. The user can disable any of these wake-up sources.

1. Touch  > **Wake-Up Sources**.
2. Touch a checkbox to enable or disable the source.

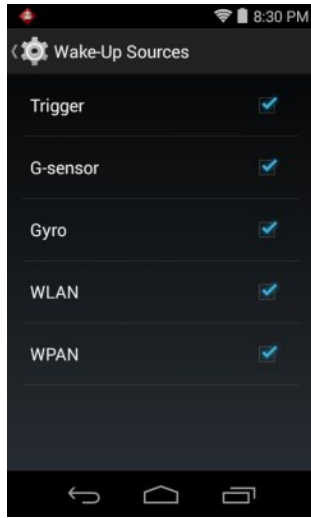

Figure 1-18 *Wake-Up Sources Dialog Box*

3. Touch .

Review Copy

CHAPTER 2 USING THE TC8000

Introduction

This chapter describes the screens, status and notification icons, and controls on the TC8000, and provides basic instructions for using the TC8000.

Home Screen

The Home screen displays when the TC8000 turns on. Depending upon the configuration, the Home screen might appear different. Contact your system administrator for more information.

After a suspend or screen time-out, the Home screen displays with the lock sliders. Slide to the right toward to unlock the screen. For screen locking information see [Un-Locking the Screen on page 2-11](#).



Figure 2-1 Home Screen



NOTE The Home screen icons can be configured by the user and may look different than shown.

The Home screen consists of the following:

Table 2-1 Home Screen Items

Item	Description
1 — Status Bar	Displays the time, status icons (right side), and notification icons (left side). For more information see Status Icons on page 2-2 and Managing Notifications on page 2-4 .
2 — PTT Express Icon	Opens the PTT Express Client application.
3 — Menu Icon	Displays running applications.
4 — Home Icon	Displays the Home screen.
5 — All Apps Icon	Opens the APPS window.
6 — Back Icon	Displays the previous screen.
7 — Settings Icon	Opens the Settings window.
8 — Shortcut Icons	Opens applications installed on the TC8000. See Application Shortcuts and Widgets on page 2-5 for more information.
9 — Widgets	Launches stand-alone applications that run on the Home screen. See Application Shortcuts and Widgets on page 2-5 for more information.

The Home screen provides four additional screens for placement of widgets and shortcuts. Swipe the screen left or right to view the additional screens.

Status Bar

The Status bar displays the time, notification icons (left side) and status icons (right side).

If there are more notifications than can fit in the Status bar, displays indicating that more notifications exist. Open the Notifications panel to view all notifications and status.

Status Icons

Table 2-2 Status Icons











Icon	Description
	Indicates that the Alarm is active.
	Indicates that the ringer is silenced.
	Indicates that the battery is fully charged.
	Indicates that the battery is partially drained.

Table 2-2 *Status Icons (Continued)*

Icon	Description
	Indicates that the battery charge is low.
	Indicates that the battery charge is very low.
	Indicates that the battery is charging.
	Indicates that the Airplane Mode is active. All radios are turned off.
	Indicates that Bluetooth is on.
	Connected to a Wi-Fi network.
	No Wi-Fi signal.

Notification Icons

Table 2-3 *Notification Icons*















Icon	Description
	Indicates that more notifications are available for viewing.
	Indicates that data is syncing.
	Indicates an upcoming event.
	Indicates that an open Wi-Fi network is available.
	Indicates that a song is playing.
	Indicates that a problem with sign-in or sync has occurred.
	Indicates that the TC8000 is uploading data.
	Indicates that the TC8000 is downloading data when animated and download is complete when static.
	Indicates that the TC8000 is connected via USB cable.
	Indicates that the TC8000 is connected to or disconnected from virtual private network (VPN).

Table 2-3 *Notification Icons (Continued)*

Icon	Description
	Preparing Internal Storage.
	Indicates that USB debugging is enabled on the TC8000.
	Indicates that the MultiUser feature is enabled. Appears only when MultiUser Administrator application is installed.
	Indicates that a new user is logging in. Appears only when MultiUser Administrator application is installed.
	Indicates that the RxLogger application is running and capturing data.

Managing Notifications

Notification icons report the arrival of new messages, calendar events, and alarms, as well as ongoing events. When a notification occurs, an icon appears in the Status bar with a brief description. See [Notification Icons on page 2-3](#) for a list of possible notification icons and their description. Open the Notifications panel to view a list of all the notifications.

To open the Notification panel, drag the Status bar down from the top of the screen.

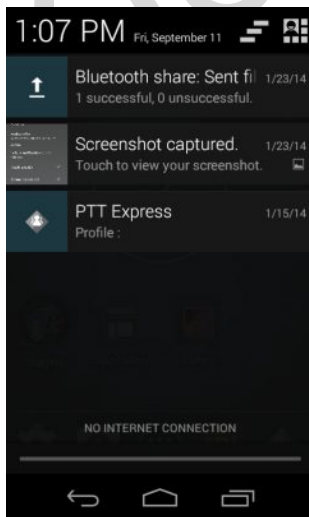
**Figure 2-2** *Notification Panel*

To respond to a notification, open the Notifications Panel and then touch a notification. The Notifications Panel closes and the subsequent activity is dependent on the notification.

To clear all notifications, open the Notifications Panel and then touch . All event-based notifications are removed.

Ongoing notifications remain in the list.

To close the Notification Panel, drag the bottom of the Notifications Panel to the top of the screen or press.

Application Shortcuts and Widgets

Application shortcuts placed on the Home screen allow quick and easy access to applications. Widgets are self-contained applications placed on the Home screen to access frequently used features.

Adding an Application or Widget to the Home Screen

1. Go to the desired Home screen.
2. Touch .
3. Swipe right, if necessary, to find the application icon or widget.
4. Touch and hold the icon or widget until the Home screen appears.
5. Position the icon on the screen and then release.

Moving Items on the Home Screen

1. Touch and hold the item until it floats on the screen.
2. Drag the item to a new location. Pause at the edge of the screen to drag the item onto an adjacent Home screen.
3. Lift finger to place the item on the Home screen.

Removing an App or Widget from the Home Screen

1. Go to the desired Home screen.
2. Touch and hold the application shortcut or widget icon until it floats on the screen.
3. Drag the icon to  **Remove** on the top of the screen and then release.

Folders

Use Folders to organize similar applications together. Tap the folder to open and display items in the folder.

Creating a Folder

To create a folder, there must be at least two app icons on the Home screen.

1. Go to the desired Home screen.
2. Touch and hold on one application icon.
3. Drag the icon and stack on top of another icon.
4. Lift and release.

Naming Folders

1. Touch the folder.

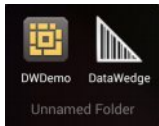

Figure 2-3 Open Folder

2. Touch the title area and enter a folder name using the keyboard.
3. Touch **Done**.
4. Touch anywhere on the Home screen to close the folder. The folder name appears under the folder.



Figure 2-4 Renamed Folder

Removing a Folder

1. Touch and hold the folder icon until it enlarges.
2. Drag the icon to **X Remove** and release.

Home Screen Wallpaper

✓ **NOTE** Use of Live Wallpaper may reduce battery life.

Changing the Home Screen Wallpaper

✓ **NOTE** Use of Live Wallpaper may reduce battery life.

1. Touch and hold the desktop until the menu appears.
2. From the **Choose wallpaper from** menu, touch **Gallery**, **Live wallpapers** or **Wallpapers**.
 - **Gallery** - Select to use an image stored on the device.
 - **Live wallpapers** - Select to use an animated wallpaper image.
 - **Wallpapers** - Select to use a wallpaper image.
3. Touch **Save** or **Set wallpaper**.

Using the Touchscreen

Use the multi-tap sensitive screen to operate the device.

- **Tap** - Tap to:
 - select items on the screen
 - type letters and symbols using the on-screen keyboard
 - press on-screen buttons.

- **Tap and Hold** - Tap and hold:
 - an item on the Home screen to move it to a new location or to the trash.
 - an item in Apps to create a shortcut on the Home screen.
 - the Home screen to open a menu for customizing the Home screen.
 - an empty area on the Home screen until the menu appears.
- **Drag** - Tap and hold an item for a moment and then move finger on the screen until reaching the new position.
- **Swipe** - Move finger up and down or left and right on the screen to:
 - unlock the screen
 - view additional Home screens
 - view additional application icons in the Launcher window
 - view more information on an application's screen.
- **Double-tap** - Tap twice on a web page, map, or other screen to zoom in and out.
- **Pinch** - In some applications, zoom in and out by placing two fingers on the screen and pinching them together (to zoom out) or spreading them apart (to zoom in).

Using the On-screen Keyboard



Use the on-screen keyboard to enter text in a text field. To configure the keyboard settings, touch and hold  (comma) >  and then select **Android keyboard settings**.

Editing Text

Edit entered text and use menu commands to cut, copy, and paste text within or across applications. Some applications do not support editing some or all of the text they display; others may offer their own way to select text.

Entering Numbers, Symbols and Special Characters

To enter numbers and symbols:

- Touch and hold one of the top-row keys until a menu appears then select a number. Keys with alternate characters display an ellipsis (...) below the character.
- Touch and hold the Shift key with one finger, touch one or more capital letters or symbols to enter them, and then lift both fingers to return to the lowercase keyboard.
- Touch  to switch to the numbers and symbols keyboard.
- Touch the  key on the numbers and symbols keyboard to view additional symbols.

To enter special characters, touch and hold a number or symbol key to open a menu of additional symbols.

- A larger version of the key displays briefly over the keyboard.
- Keys with alternate characters display an ellipsis (...) below the character.

Applications

The APPS screen displays icons for all installed applications. The table below lists the applications installed on the TC8000. Refer to the TC8000 Integrator Guide for information on installing and uninstalling application.

Table 2-4 Applications















Icon	Description
	App Gallery - Provides links to utilities and demonstration applications that can be installed on the TC8000.
	Bluetooth Pairing Utility – Use to pair the RS507 Hans-free Imager with the TC8000 by scanning a bar code.
	Browser - Use to access the Internet or intranet.
	Calculator - Provides the basic and scientific arithmetic functions.
	Camera - Take photos or record videos.
	Calendar - Use to manage events and appointments.
	Clock - Use to schedule alarms for appointments or as a wake-up.
	DataWedge - Enables data capture using the imager.
	Downloads - Lists all downloads files.
	DWDemo - Provides a way to demonstrate the data capture features using the imager. See DataWedge Demonstration on page 5-18 for more information.
	elemez - Use to provide diagnostic information. See Elemesz on page 5-22 for more information.
	Email - Use to send and receive email.
	File Browser - Organize and manage files on the TC8000. See File Browser on page 5-1 for more information.
	Gallery - Use to view photos stored on the device. For more information, see Gallery on page 5-12 for more information.

Table 2-4 Applications (Continued)





















Icon	Description
	MLog Manager - Use to capture log files for diagnostics. See MLog Manager on page 5-19 for more information.
	Mobi Control Stage – Opens the Mobi Control Stage application to stage the device.
	Movie Studio - Create movie videos.
	MSP Agent - Enables management of the TC8000 from an MSP server. Requires the purchase of an appropriate MSP client license per device to suit the level of management functionality required.
	Music - Play music stored on the device.
	People - Use to manage contact information. People on page 5-3 for more information.
	Print Station - Use to print labels and receipts directly to a Zebra ZPL printer via USB, Bluetooth or WLAN.
	PTT Express - Use to launch PTT Express client for VoIP communication.
	Rapid Deployment - Allows the TC8000 to stage a device for initial use by initiating the deployment of settings, firmware and software. Requires the purchase of an MSP client license per device.
	RxLogger - Use to diagnose device and application issues. See the <i>TC8000 Integrator Guide</i> for more information.
	Search - Use the Google search engine to search the Internet and the TC8000.
	Settings - Use to configure the TC8000.
	SimulScan Demo - Use to demonstrate the document capture feature of the TC8000.
	Sound Recorder - Use to record audio.
	StageNow - Allows the TC8000 to stage a device for initial use by initiating the deployment of settings, firmware and software.
	Zebra Tap & Pair - Use to pair the TC8000 with a Zebra Bluetooth printer.

Table 2-4 Applications (Continued)

Icon	Description
	Zebra Utilities - Use to print bar code labels and receipts directly to a Zebra printer via Bluetooth or WLAN.
	AppLock Administrator - Use to configure the Application Lock feature. This icon appears after the optional application is installed.
	MultiUser Administrator - Use to configure the MultiUser feature. This icon appears after the optional application is installed.
	Secure Storage Administrator - Use to configure the Secure Storage feature. This icon appears after the optional application is installed.

Accessing Applications

All applications installed on the device are accessed using the **APPS** window.

1. On the Home screen, touch .



Figure 2-5 APPS Window

2. Slide the **APPS** window left or right to view more application icons. Touch an icon to open the application.



NOTE See [Application Shortcuts and Widgets on page 2-5](#) for information on creating a shortcut on the Home screen.

Switching Between Recent Applications

1. Touch and hold . A window appears on the screen with icons of recently used applications.

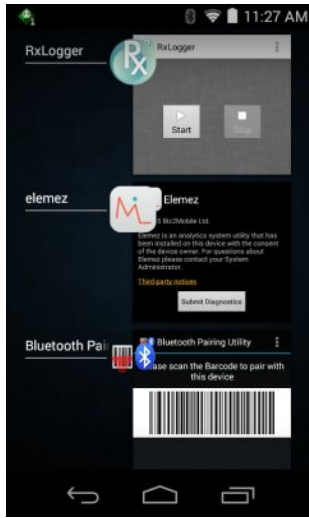

Figure 2-6 *Recently Used Applications*

2. Slide the window up and down to view all recently used applications.
3. Swipe left or right to remove application from the list and force close the application.
4. Touch an icon to open it or touch ↶ to return to the current screen.

Un-Locking the Screen

Use the Lock screen to protect access to data on the TC8000. Some email account require locking the screen. See [Chapter 11, Settings](#) for information on setting up the locking feature. The Locking feature functions differently in Single User mode or Multiple User mode.

Single User Mode

When locked, a pattern, PIN or password is required to unlock the device. Press the Power button to lock the screen. The device also locks after a pre-defined time-out.

Press and release the Power button to wake the device.

The Lock screen displays. Slide 🔒 to the right toward 🔓 to unlock the screen.

If the Pattern screen unlock feature is enabled, the Pattern screen appears instead of the Lock screen.

If the PIN or Password screen unlock feature is enabled, enter the PIN or password after unlocking the screen.



Figure 2-7 *Lock Screen*



Figure 2-8 *PIN Screen*



Figure 2-9 *Pattern Screen*

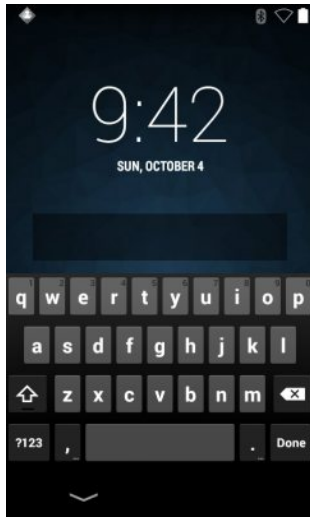

Figure 2-10 Password Screen

MultiUser Mode

With MultiUser login, multiple users can log on to the device with each user having access to various applications and features. When enabled, the Login screen appears after powering on, resetting or after the device wakes from suspend mode.

MultiUser Login

1. In the **Login** text field, enter the username.

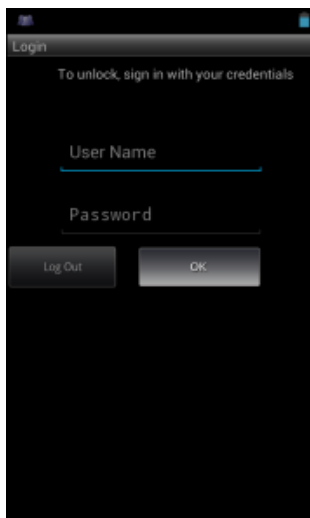

Figure 2-11 Multiple User Log In Screen

2. In the **Password** text field, enter the password.
3. Touch **OK**. After a resume from suspend, the user must enter the password.

MultiUser Logout



1. Drag the Status Bar down from the top of the screen.

2. Touch **MultiUser is active**.
3. Touch **Logout**.
4. The **Login** screen appears.

Suspend Mode

The TC8000 goes into suspend mode when the user presses the Power button or after a period of inactivity (set in the Display settings window).

To wake the TC8000 from Suspend mode, press the Power button. Alternately, press the Trigger button to wake the device.

The Lock screen displays. Slide  to the right toward  to unlock the screen. If the Pattern screen unlock feature is enabled, the Pattern screen appears instead of the Lock screen. See [Un-Locking the Screen on page 2-11](#).

✓ **NOTE** If the user enters the PIN, password or pattern incorrectly five times, they must wait 30 seconds before trying again.

If the user forgets the PIN, password or pattern contact the system administrator.



Figure 2-12 Lock Screen

Resetting the TC8000

There are four reset functions:

- Soft reset
- Hard reset.

Performing a Soft Reset

Perform a soft reset if applications stop responding.

1. Press the power button until the menu appears.
2. Touch **Reset**.
3. The device reboots.

Performing a Hard Reset



CAUTION Perform a hard reset only if the TC8000 stops responding.

To perform a hard reset, simultaneously press and hold the power button, trigger and PTT button for five seconds. When the device reboots, release the buttons and trigger.

Review Copy

CHAPTER 3 DATA CAPTURE

Introduction

The TC8000 has the following data capture options.

- integrated SE-965 Standard Range Laser
- integrated SE-4750-SR Standard Range Imager
- integrated digital camera
- optional RS507.

✓ **NOTE** By default, the good decode beep is set to system volume (Notifications). The good decode beep can be set to another sound (Ringer, Music and Media or Alarms) and the volume can be independently controlled. See the DataWedge section in the *TC8000 Integrator Guide* for more information.

Status LED

The Charging/Scan LED indicates data capture status. [Table 3-1](#) describes the Status LED indications.

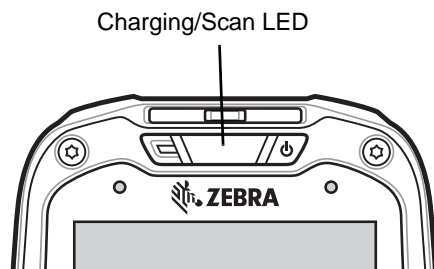

Figure 3-1 Charging/Scan LED

Table 3-1 Charging/Scan LED Indicators

LED Status	Indication
Off	Not scanning.
Solid Green	Successful decode.

Laser Scanning

The TC8000 with laser scanner has the following features:

- Reading of a variety of bar code symbologies, including the most popular linear, postal, and 1-D code types.
- Intuitive aiming for easy point-and-shoot operation.

Imaging

The TC8000 with an integrated imager has the following features:

- Omnidirectional (360°) reading of a variety of bar code symbologies, including the most popular linear, postal, PDF417, and 2D matrix code types.
- The ability to capture and download images to a host for a variety of imaging applications.
- Advanced intuitive laser aiming for easy point-and-shoot operation.

The imager uses digital camera technology to take a digital picture of a bar code, stores the resulting image in its memory, and executes state-of-the-art software decoding algorithms to extract the data from the image.

Operational Modes

The TC8000 with an integrated imager supports three modes of operation, listed below. Activate each mode pressing the Scan button.

- **Decode Mode:** In this mode, the TC8000 attempts to locate and decode enabled bar codes within its field of view. The imager remains in this mode as long as you hold the scan button, or until it decodes a bar code.
- **Pick List Mode:** This mode allows you to selectively decode a bar code when more than one bar code is in the TC8000's field of view. To accomplish this, move the aiming crosshair center dot over the required bar code to decode only that bar code. This feature is ideal for pick lists containing multiple bar codes and manufacturing or transport labels containing more than one bar code type (either 1D or 2D).
- **Image Capture Mode:** Use this mode to capture an image within the TC8000's field of view. This is useful for capturing signatures or images of items like damaged boxes.

Digital Camera

The device with an integrated camera based bar code scanning solution has the following features:

- Omnidirectional reading of a variety of bar code symbologies, including the most popular linear, postal, QR, PDF417, and 2D matrix code types.

- Cross-hair reticle for easy point-and-shoot operation.
- Picklist mode to decode a particular bar code from many in the field of view.

The solution uses the advanced camera technology to take a digital picture of a bar code, and executes state-of-the-art software decoding algorithms to extract the data from the image.

Scanning Considerations

Scanning consists of; aim, scan and decode. Scanning performance can be optimized by considering the range and the scanning angle:

- Range

Any scanning device decodes well over a particular working range (minimum and maximum distances from the bar code). This range varies according to bar code density and scanning device optics.

Scanning within range brings quick and constant decodes; scanning too close or too far away prevents decodes. Move the scanner closer and further away to find the right working range for the bar codes being scanned. However, the situation is complicated by the availability of various integrated scanning modules. The best way to specify the appropriate working range per bar code density is through a chart called a decode zone for each scan module. A decode zone simply plots working range as a function of minimum element widths of bar code symbols.

- Angle

The scan angle is important for optimizing decode performance. When laser beams reflect directly back into the scanner from the bar code, this specular reflection can “blind” the scanner.

To avoid this, scan the bar code so that the beam does not bounce directly back. But do not scan at too sharp an angle; the scanner needs to collect scattered reflections from the scan to make a successful decode. Practice quickly shows what tolerances to work within.

✓ **NOTE** Contact the Zebra Support if chronic scanning difficulties develop. Decoding of properly printed bar codes should be quick and effortless.

Bar Code Capture with Laser Scanner

To read a bar code, a scan-enabled application is required. The TC8000 contains the **DataWedge** application that allows the user to enable the scanner to decode bar code data and display the bar code content. See [DataWedge on page 3-14](#) for information on enabling **DataWedge**.

1. Launch a scanning application.
2. Point the exit window at a bar code.



Figure 3-2 *Laser Scanning*

3. Press the trigger button. Ensure the red scan beam covers the entire bar code. The Charging/Scan LED Indicators illuminate green and a beep sounds to indicate a successful decode.



Figure 3-3 *Laser Aiming*

4. Release the trigger or scan button.

Bar Code Capture with Imager

To read a bar code, a scan-enabled application is required. The TC8000 contains the **DataWedge** application that allows the user to enable the scanner to decode bar code data and display the bar code content. See [DataWedge on page 14](#) for more information on launching DataWedge.

1. Launch a scanning application.
2. Point the exit window at a bar code.

3. Press the trigger button.



Figure 3-4 *Imager Scanning*

4. Ensure the red scan beam covers the entire bar code. The Charging/Scan LED Indicators illuminate green and a beep sounds to indicate a successful decode.

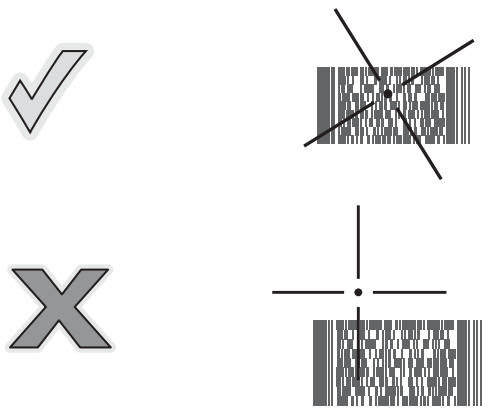

Figure 3-5 *Imager Aiming Pattern*



Figure 3-6 *Imager Pick List Mode with Multiple Bar Codes*

5. Release the trigger.

Bar Code Capture with Camera

To read a bar code, a scan-enabled application is required. The TC8000 contains the **DataWedge** application that allows the user to enable the scanner to decode bar code data and display the bar code content. See [DataWedge on page 3-14](#) for more information on launching DataWedge.

1. Launch a scanning application.
2. Point the camera window at a bar code.
3. Press and hold the trigger. By default, a preview window appears on the screen.

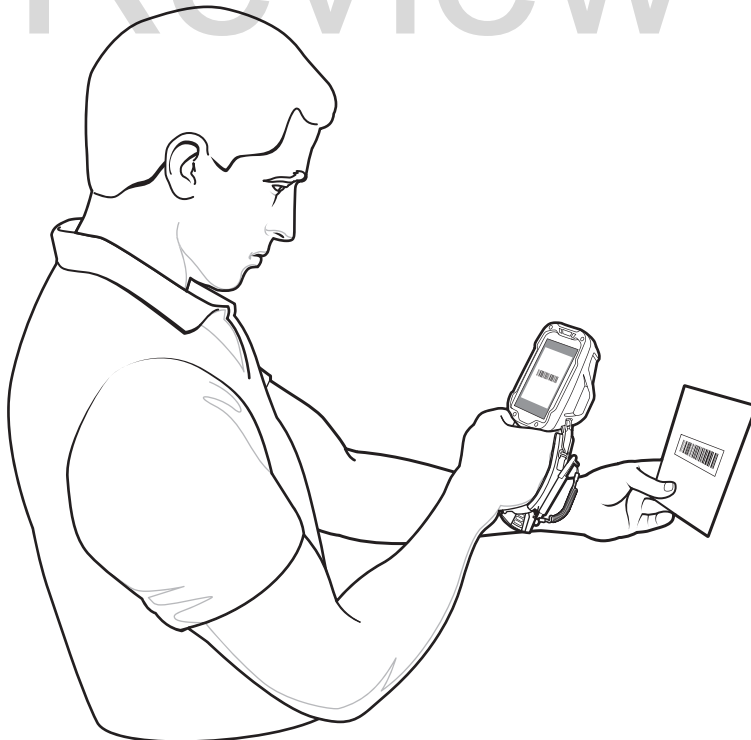

Figure 3-7 *Camera Scanning*

- ✓ **NOTE** When Picklist mode is enabled, move the TC8000 until the bar code is centered under the red target on the screen.

4. Move the TC8000 until the bar code is visible on the screen.
5. The Decode LED lights green, a beep sounds and the device vibrates, by default, to indicate the bar code was decoded successfully.
6. The captured data appears in the text field.
7. Release the trigger.

Bar Code Capture with RS507 Hands-Free Imager

Pair the RS507 with the TC8000. See [Pairing the RS507 Hands-Free Imager Using SSI on page 3-8](#) or [Pairing the RS507 Hands-Free Imager Using Bluetooth HID on page 3-9](#) for more information.

1. Ensure that an application is open on the device and a text field is in focus (text cursor in text field).
2. Point the RS507 at a bar code.

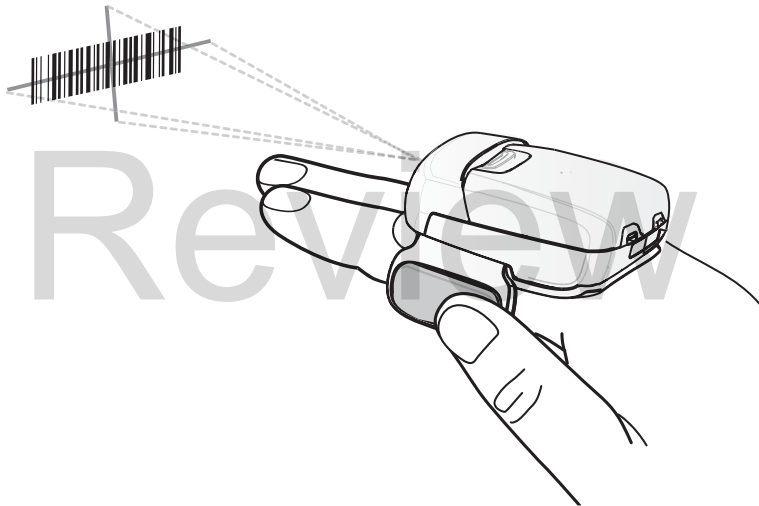

Figure 3-8 Bar Code Scanning with RS507

3. Press and hold the trigger.

The red laser aiming pattern turns on to assist in aiming. Ensure the bar code is within the area formed by the cross-hairs in the aiming pattern. The aiming dot is used for increased visibility in bright lighting conditions.

The RS507 LEDs light green, a beep sounds to indicate the bar code was decoded successfully. Note that when the RS507 is in Pick List Mode, the RS507 does not decode the bar code until the center of the crosshair touches the bar code.

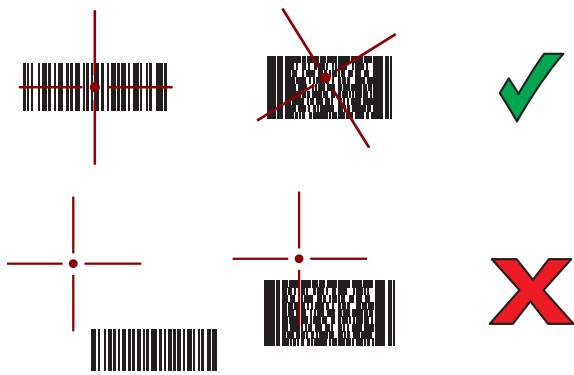

Figure 3-9 Aiming Pattern



Figure 3-10 Pick List Mode with Multiple Bar Codes in Aiming Pattern

4. The captured data appears in the text field.

Pairing the RS507 Hands-Free Imager Using SSI

An RS507 Hands-free Imager can be used with the device to capture bar code data.

1. Ensure that the two devices are within 10 meters (32.8 feet) of one another.
2. Install the battery into the RS507.
3. On the TC8000, touch .
4. Touch (Bluetooth pairing Utility icon).

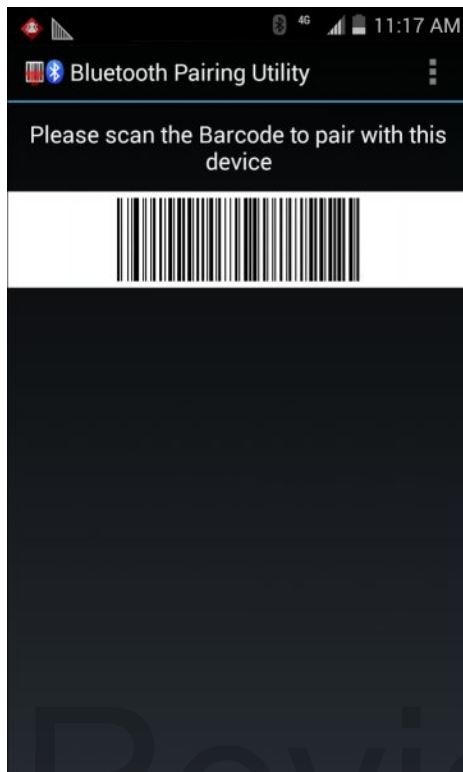

Figure 3-11 *Bluetooth Pairing Utility*

5. Using the RS507, scan the bar code on the screen.

The RS507 emits a high/low/high/low beeps. The Scan LED flashes green indicating that the RS507 is attempting to establish connection with the TC8000. When connection is established, the Scan LED turns off and the RS507 emits one string of low/high beeps.

6. On the TC8000, touch ↩.



Pairing the RS507 Hands-Free Imager Using Bluetooth HID

An RS507 Hands-free Imager can be used with the device to capture bar code data.

1. Ensure that Bluetooth is enabled on both devices.
2. Ensure that the Bluetooth device to discover is in discoverable mode.
3. Ensure that the two devices are within 10 meters (32.8 feet) of one another.
4. Place the RS507 in Human Interface Device (HID) mode. If the RS507 is already in HID mode, skip to step 5.
 - a. Remove the battery from the RS507.
 - b. Press and hold the Restore key.
 - c. Install the battery onto the RS507.
 - d. Keep holding the Restore key for about five seconds until a chirp is heard and the Scan LEDs flash green.
 - e. Scan the bar code below to place the RS507 in HID mode.



Figure 3-12 *RS507 Bluetooth HID Bar Code*

5. Remove the battery from the RS507.
6. Re-install the battery into the RS507.
7. Touch .
8. Touch  **Bluetooth**.
9. Touch **SCAN FOR DEVICES**. The device begins searching for discoverable Bluetooth devices in the area and displays them under **AVAILABLE DEVICES**.
10. Scroll through the list and select RS507.

The device connects to the RS507 and **Connected** appears below the device name. The Bluetooth device is added to the **Bluetooth devices** list and a trusted (“paired”) connection is established.

Hands Free Scanning

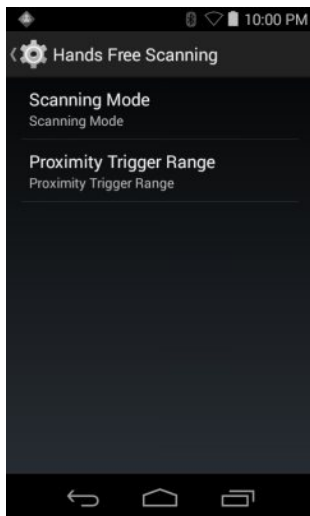

Figure 3-13 *Hands Free Scanning Settings*

Scanning Mode

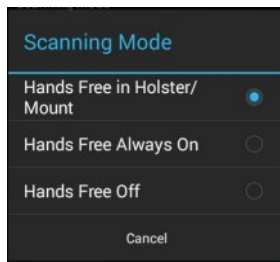

Figure 3-14 *Scanning Mode Dialog Box*

Proximity Range

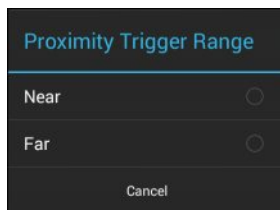

Figure 3-15 *Proximity Trigger Range Dialog Box*

Review Copy

Ergonomic Recommendations During Scanning

Proper Scanning

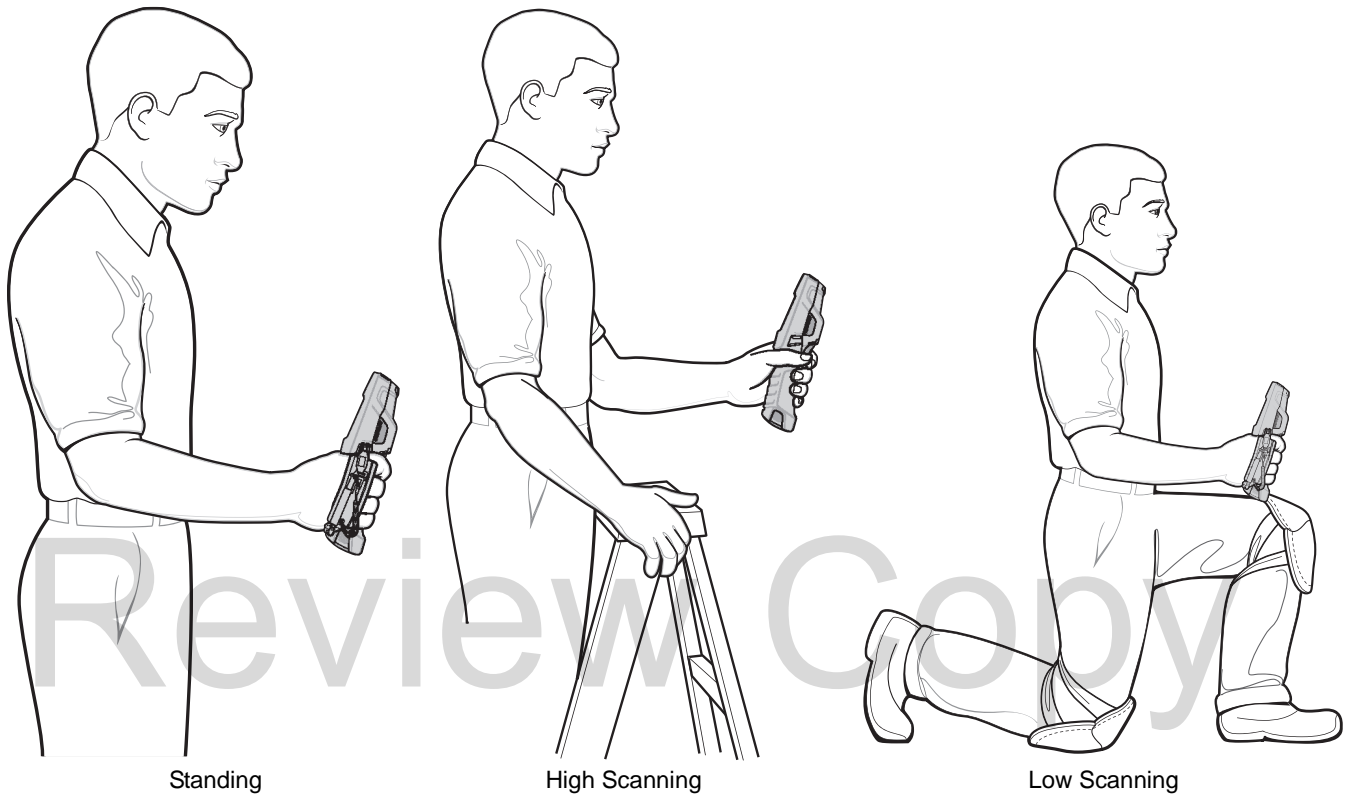

Figure 3-16 *Proper Scanning Position*

Improper Scanning

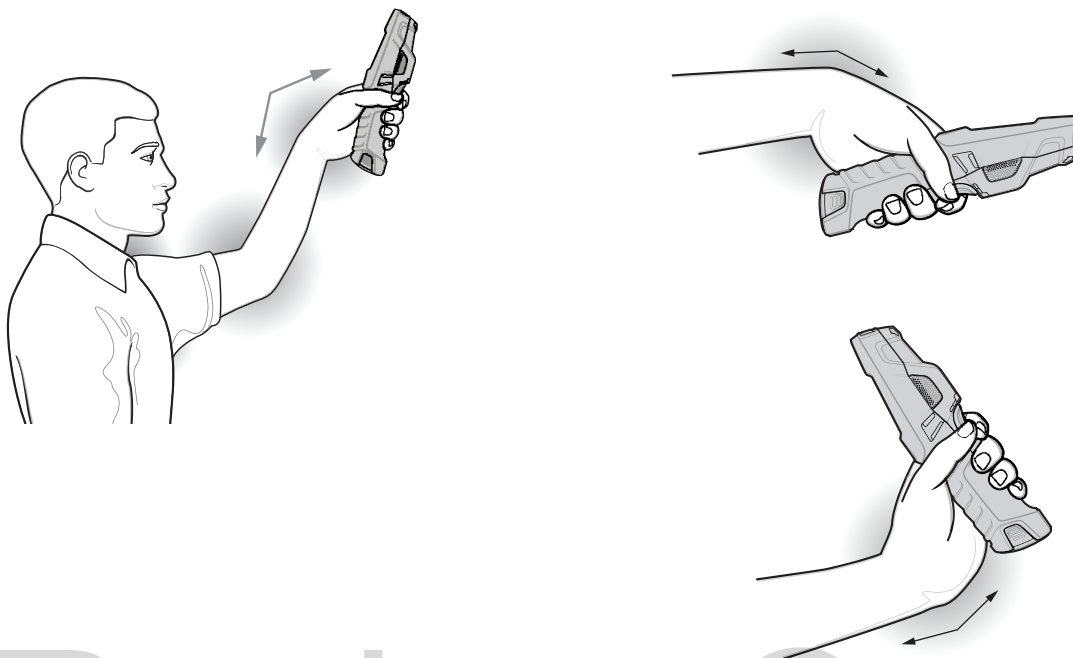





Figure 3-17 *Do Not Bend Wrist Excessively*

Review Copy

DataWedge

Enable DataWedge

To enable DataWedge:

1. Touch  >  > .
2. Touch **Settings**.
3. Touch the **DataWedge enabled** checkbox. A blue checkmark appears in the checkbox indicating that DataWedge is enabled.
4. Touch .

Disable DataWedge

To disable DataWedge:

1. Touch  >  > .
2. Touch **Settings**.
3. Touch the **DataWedge enabled** checkbox. The blue checkmark disappears from the checkbox indicating that DataWedge is disabled.
4. Touch .



Pairing the RS507 Hands-Free Imager using HID

An RS507 Hands-free Imager can be used with the device to capture bar code data.

1. Ensure that Bluetooth is enabled on both devices.
2. Ensure that the Bluetooth device to discover is in discoverable mode.
3. Ensure that the two devices are within 10 meters (32.8 feet) of one another.
4. Place the RS507 in Human Interface Device (HID) mode. If the RS507 is already in HID mode, skip to step 5.
 - a. Remove the battery from the RS507.
 - b. Press and hold the Restore key.
 - c. Install the battery onto the RS507.
 - d. Keep holding the Restore key for about five seconds until a chirp is heard and the Scan LEDs flash green.
 - e. Scan the bar code below to place the RS507 in HID mode.





Figure 3-18 *RS507 Bluetooth HID Bar Code*

5. Remove the battery from the RS507.
6. Re-install the battery into the RS507.
7. On the TC8000, touch .
8. Touch  **Bluetooth**.
9. Touch **SCAN FOR DEVICES**. The device begins searching for discoverable Bluetooth devices in the area and displays them under **AVAILABLE DEVICES**.
10. Scroll through the list and select RS507.

The device connects to the RS507 and **Connected** appears below the device name. The Bluetooth device is added to the **Bluetooth devices** list and a trusted (“paired”) connection is established.

Pairing the RS507 Hands-Free Imager Using SSI

An RS507 Hands-free Imager can be used with the device to capture bar code data.

1. Ensure that the two devices are within 10 meters (32.8 feet) of one another.
2. Install the battery into the RS507.
3. On the TC8000, touch .
4. Touch .

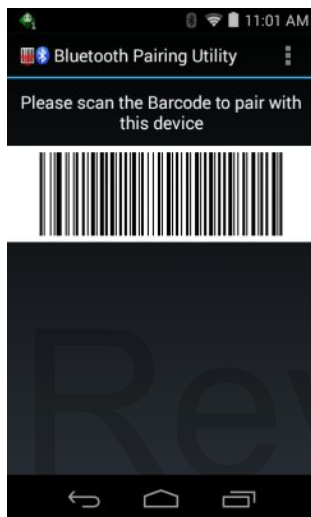



Figure 3-19 Bluetooth Pairing Utility

5. Using the RS507, scan the bar code on the screen.

The RS507 emits a high/low/high/low beeps. The Scan LED flashes green indicating that the RS507 is attempting to establish connection with the TC8000. When connection is established, the Scan LED turns off and the RS507 emits one string of low/high beeps.

6. On the TC8000, touch .

CHAPTER 4 WIRELESS

Wireless Local Area Networks

Wireless local area networks (WLANs) allow the TC8000 to communicate wirelessly inside a building. Before using the TC8000 on a WLAN, the facility must be set up with the required hardware to run the WLAN (sometimes known as infrastructure). The infrastructure and the TC8000 must both be properly configured to enable this communication.

Refer to the documentation provided with the infrastructure (access points (APs), access ports, switches, Radius servers, etc.) for instructions on how to set up the infrastructure.

Once the infrastructure is set up to enforce the chosen WLAN security scheme, use the **Wireless & networks** settings configure the TC8000 to match the security scheme.

The TC8000 supports the following WLAN security options:

- Open
- Wireless Equivalent Privacy (WEP).
- Wi-Fi Protected Access (WPA/WPA2) Personal (PSK).
- Extensible Authentication Protocol (EAP).
 - Protected Extensible Authentication Protocol (PEAP) - with MSCHAPV2 and GTC authentication.
 - Transport Layer Security (TLS)
 - TTLS - with Password Authentication Protocol (PAP), MSCHAP and MSCHAPv2 authentication.
 - LEAP
 - EAP-FAST - with MSCHAPV2 and GTC authentication.

The **Status** bar displays icons that indicate Wi-Fi network availability and Wi-Fi status. See [Status Bar on page 2-2](#) for more information.



NOTE Turn off Wi-Fi when not using it, to extend the life of the battery.

Scan and Connect to a Wi-Fi Network

1. Touch .

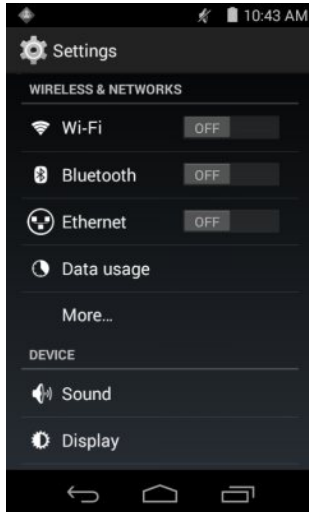



Figure 4-1 Settings Screen

2. Slide the **Wi-Fi** switch to the **ON** position.
3. Touch  **Wi-Fi**. The TC8000 searches for WLANs in the area and lists them.

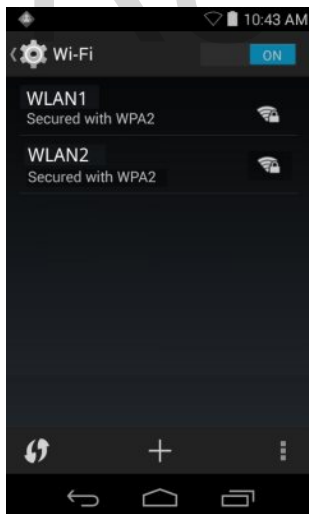



Figure 4-2 Wi-Fi Screen

4. Scroll through the list and select the desired WLAN network.
5. For open networks, touch profile once or press and hold and then select **Connect to network** or for secure networks enter the required password or other credentials then touch **Connect**. See the system administrator for more information.
6. The TC8000 obtains a network address and other required information from the network using the dynamic host configuration protocol (DHCP) protocol. To configure the TC8000 with a fixed internet protocol (IP) address, See [Configuring the Device to Use a Static IP Address on page 4-6](#).
7. In the Wi-Fi setting field, **Connected** appears indicating that the TC8000 is connected to the WLAN.

Configuring a Wi-Fi Network

To set up a Wi-Fi network:

1. Touch .
2. Touch  **Wi-Fi**.
3. Slide the switch to the **ON** position.
4. The device searches for WLANs in the area and lists them on the screen.
5. Scroll through the list and select the desired WLAN network.
6. Touch the desired network. If the network security is **Open**, the device automatically connects to the network. For all other network security a dialog box appears.

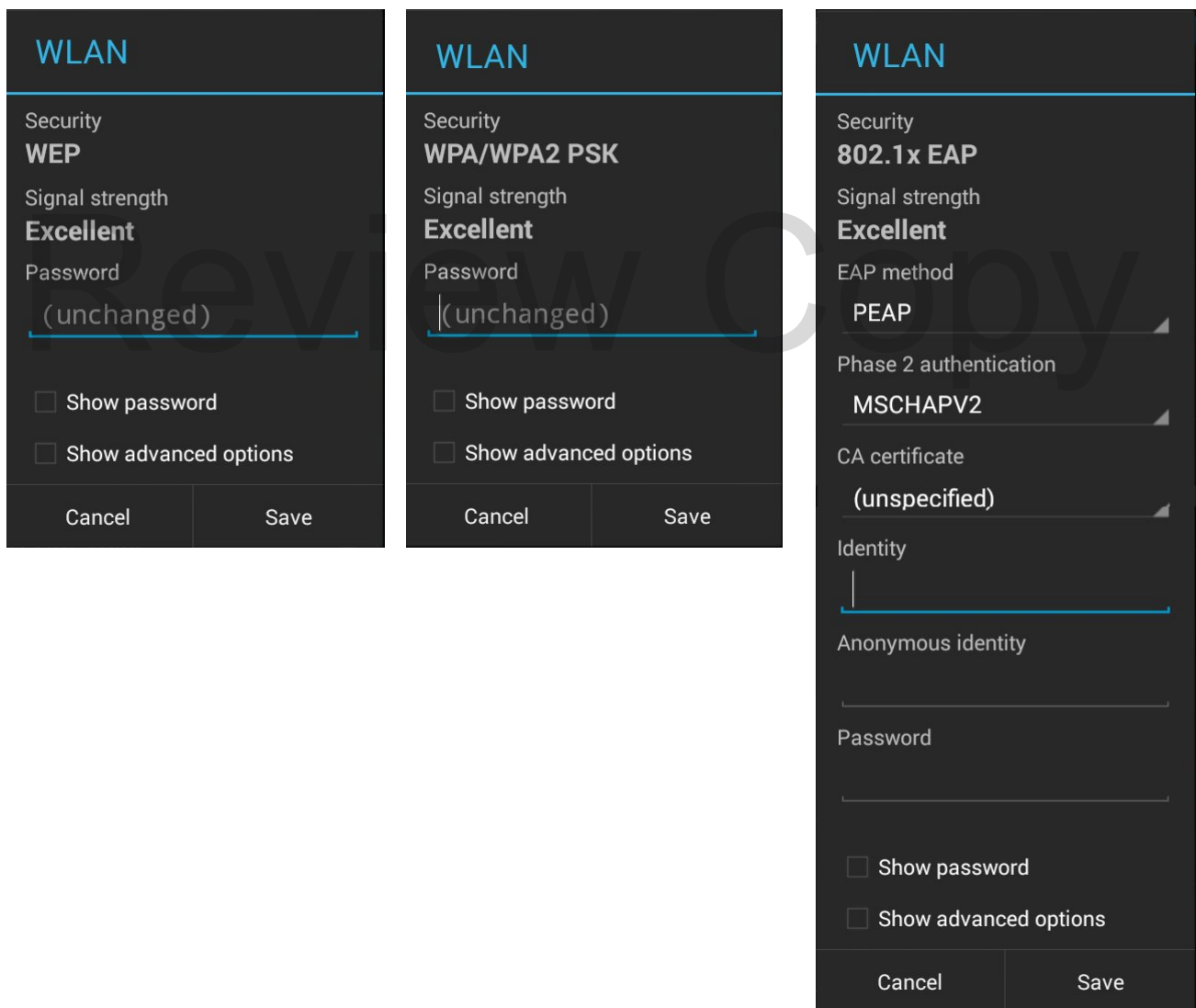

Figure 4-3 WLAN Network Security Dialog Box

7. If the network security is **WEP** or **WPA/WPS2 PSK**, enter the required password and then touch **Connect**.
8. If the network security is 802.1x EAP:

- Touch the EAP method drop-down list and select **PEAP, TLS, TTLS, LEAP** or **FAST**.
- Touch the **Phase 2 authentication** drop-down list and select an authentication method.
- If required, touch **CA certificate** and select a Certification Authority (CA) certificate. Note: Certificates are installed using the **Security** settings.
- If required, touch **User certificate** and select a user certificate. Note: User certificates are installed using the Location & security settings.
- If required, in the **Identity** text box, enter the username credentials.
- If desired, in the **Anonymous identity** text box, enter an anonymous identity username.
- If required, in the **Password** text box, enter the password for then given identity.





NOTE By default, the network Proxy is set to **None** and the IP settings is set to **DHCP**. See [Configuring for a Proxy Server on page 4-5](#) for setting connection to a proxy server and see [Configuring the Device to Use a Static IP Address on page 4-6](#) for setting the device to use a static IP address.

9. Touch **Connect**.

10. Touch .

Manually Adding a Wi-Fi Network

Manually add a Wi-Fi network if the network does not broadcast its name (SSID) or to add a Wi-Fi network when out of range.

1. Touch .
2. Touch  **Wi-Fi**.
3. Slide the Wi-Fi switch to the **On** position.
4. Touch **+** in the bottom left corner of the screen.
5. In the **Network SSID** text box, enter the name of the Wi-Fi network.
6. In the **Security** drop-down list, select the type of security. Options:
 - None
 - WEP
 - WPA/WPA2 PSK
 - **802.1x EAP**.
7. If the network security is **None**, touch **Save**.
8. If the network security is **WEP** or **WPA/WPA2 PSK**, enter the required password and then touch **Save**.
9. If the network security is **802.1x EAP**:
 - Touch the **EAP method** drop-down list and select **PEAP, TLS, TTLS, LEAP** or **FAST**.
 - Touch the **Phase 2 authentication** drop-down list and select an authentication method.
 - If required, touch **CA certificate** and select a Certification Authority (CA) certificate. Note: Certificates are installed using the **Security** settings.

- If required, touch **User certificate** and select a user certificate. Note: User certificates are installed using the **Security** settings.
 - If required, in the **Identity** text box, enter the username credentials.
 - If desired, in the **Anonymous** identity text box, enter an anonymous identity username.
 - If required, in the **Password** text box, enter the password for then given identity.
- ✓ By default, the network Proxy is set to **None** and the IP settings is set to **DHCP**. See [Configuring for a Proxy Server on page 4-5](#) for setting connection to a proxy server and see [Configuring the Device to Use a Static IP Address on page 4-6](#) for setting the device to use a static IP address.

1. Touch **Connect**.
2. Touch .

Configuring for a Proxy Server

A proxy server is a server that acts as an intermediary for requests from clients seeking resources from other servers. A client connects to the proxy server, requesting some service, such as a file, connection, web page, or other resource, available from a different server. The proxy server evaluates the request according to its filtering rules. For example, it may filter traffic by IP address or protocol. If the request is validated by the filter, the proxy provides the resource by connecting to the relevant server and requesting the service on behalf of the client.

It is important for enterprise customers to be able to set up secure computing environments within their companies, and proxy configuration is an essential part of doing that. Proxy configuration acts as a security barrier ensuring that the proxy server monitors all traffic between the Internet and the intranet. This is normally an integral part of security enforcement in corporate firewalls within intranets.

1. In the **Wi-Fi** list, touch a network.
2. Touch **Show advanced options** checkbox.
3. Touch **Proxy settings** and select **Manual**.

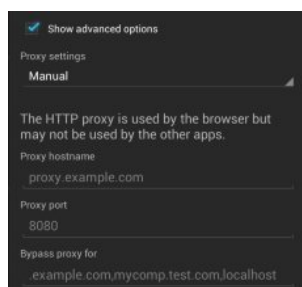

Figure 4-4 Proxy Settings

4. In the **Proxy hostname** text box, enter the address of the proxy server.
5. In the **Proxy port** text box, enter the port number for the proxy server.

✓ **NOTE** When entering proxy addresses the Bypass proxy for field, do not use spaces or carriage returns between addresses.

6. In the **Bypass proxy for** text box, enter addresses for web sites that do not require to go through the proxy server. Use the separator “|” between addresses.

7. Touch **Connect**.
8. Touch .

Configuring the Device to Use a Static IP Address

By default, the device is configured to use Dynamic Host Configuration Protocol (DHCP) to assign an Internet protocol (IP) address when connecting to a wireless network. To configure the device to connect to a network using a static IP address:

1. In the **Wi-Fi** list, touch a network.
2. Touch **Show advanced options** checkbox.
3. Touch **IP settings** and select **Static**.



Figure 4-5 *Static IP Settings*

4. In the **IP address** text box, enter an IP address for the device.
5. If required, in the **Gateway** text box, enter a gateway address for the device.
6. If required, in the **Network prefix length** text box, enter a the prefix length.
7. If required, in the **DNS 1** text box, enter a Domain Name System (DNS) address.
8. If required, in the **DNS 2** text box, enter a DNS address.
9. Touch **Connect**.
10. Touch .

Advanced Wi-Fi Settings

✓ **NOTE** Advanced Wi-Fi settings are for the device not for a specific wireless network.

Use the **Advanced** settings to configure additional Wi-Fi settings. From the **Wi-Fi** screen, touch  > **Advanced** to view the advanced settings.

- **General**
 - **Network notification** - When enabled, notifies the user when an open network is available.
 - **Keep Wi-Fi on during sleep** - Opens a menu to set whether and when the Wi-Fi radio turns off.
 - **Always On** - The radio stays on when the device enters suspend mode.
 - **Only when plugged in** - The radio stays on while the device is connected to external power.

- **Never On** - The radio turns off when the device enters suspend mode (default).
- **Install Certificates** – Touch to install certificates.
- **MAC address** - Displays the Media Access Control (MAC) address of the device when connecting to Wi-Fi networks.
- **Regulatory**
 - **Country selection** - Displays the acquired country code if **Auto** is selected else displays the selected country code. Default: Auto.
 - **Region code** - Displays the configured region code for the device.
- Band and Channel Selection
 - **Wi-Fi frequency band** - Use to select the frequency band. Options: **Auto** (default), **5 GHz only** or **2.4 GHz only**.
 - **Available channels (2.4 GHz)** - Use to select specific channels. Touch to display the **Available channels** menu. Select specific channels. Touch **OK**.
 - **Available channels (5 GHz)** - Use to select specific channels. Touch to display the **Available channels** menu. Select specific channels. Touch **OK**.
- **Logging**
 - **Advanced Logging** – Touch to enable advanced logging.
 - **Wireless logs** - Use to capture Wi-Fi log files.
 - **Fusion Logger** - Touch to open the **Fusion Logger** application. This application maintains a history of high level WLAN events which helps to understand the status of connectivity.

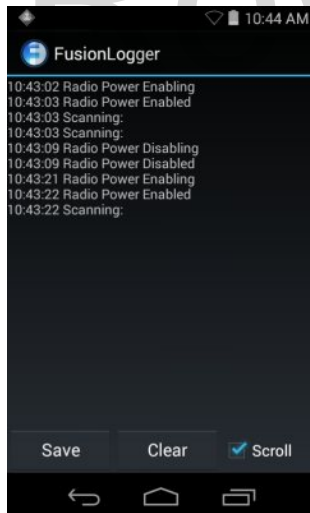

Figure 4-6 Fusion Logger Screen

- **Fusion Status** - Touch to display live status of WLAN state. Also provides information of device and connected profile.

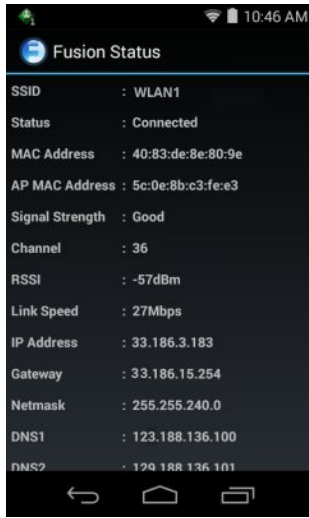





Figure 4-7 Fusion Status Screen

- About
 - **Version** - Displays the current Fusion information.

Remove a Wi-Fi Network

To remove a remembered or connected network:

1. Touch .
2. Touch  **Wi-Fi**.
3. In the **Wi-Fi networks** list, touch and hold the name of the network.
4. In the menu, touch **Forget network**.
5. Touch .

Wi-Fi Advanced Features

Some additional Wi-Fi settings cannot be accessed from the User Interface. They can be configured by using Wi-Fi (CSP). Refer to EMDK documentation for the details on the Wi-Fi settings configuration using the Wi-Fi CSP.

- **Auto Time Config** - Using this feature, the device can sync up its time with Zebra WLAN infrastructure. This feature works only when the device is connected to Zebra WLAN infrastructure and the feature is enabled on the WLAN infrastructure side. Default: disabled.
- **PMKID Caching** - Allows the device to skip 802.1x authentication during roaming if it had previously connected to that AP with a full 802.1x authentication. Default: disabled. Note: disable OKC when enabling PMKID Caching.
- **Opportunistic Key Caching** - Use this feature to skip 802.1x authentication during roaming. The device will go for full 802.1x authentication for the first time it connects to the network. For subsequent roaming, the device skips 802.1x authentication. Default: enabled.

- **Cisco Centralized Key Management** - Allows the device to skip 802.1x and key-handshake phases during roaming. This feature is available only when the device is connected to a Cisco infrastructure that supports Cisco Centralized Key Management (CCKM). Default: enabled.
- **Fast Transition** - Fast Transition (FT) is the fast roaming standard, 802.11r. With this feature, the device can skip 802.1x and key-handshake phases during roam. Default: enabled.
- **Fast Transition Resource Information Container** - Allows the device to request TSPEC as part of reassociation frame exchange. This helps to avoid sending a separate resource request after roaming is completed. Default: disabled.
- **Power Save** - The device can be configured to work in different power save modes:
 - i. **Active** - Keeps the WLAN radio always in active mode (i.e. power save mode disabled).
 - ii. **Power save using WMM-PS** - This is the default power save mode. Device uses WMM-PS power save method if the AP is configured to use this. If the AP is not supporting WMM-PS, the device will use PS-Poll power save method.
 - iii. **Power save using PS-Poll** - In this method, the device will use PS-Poll frames to retrieve buffered frames from the AP.
 - iv. **Null Data Power Save** - In Null Data Power Save (NDP), the device will stay awake for 100 ms after the last frame is sent or received. The device will send a Null Data packet with power management bit cleared to retrieve buffered frames from the AP.
- **FIPS** - The device supports FIPS 140-2 Level 1. In this mode, the device will not support TKIP and WEP encryption modes. When Wi-Fi is enabled, the stack will run predefined tests to make sure that the encryption engine is working correctly and the firmware and firmware loader modules are correct.
- **802.11k** - Using 802.11k, the device can discover neighbor APs and adds support for different types of radio resource measurements. Default: enabled.
- **Band Preference** - The device can be configured to prefer one band over another. By default, device prefers 5 GHz frequency band over 2.4 GHz.
- **Subnet Roaming** - When the device roams between different sub networks, if it detects that it is roaming to a different subnet, the device will request a fresh IP address. Default: disabled.

Zebra Mobility Extensions

Zebra Mobility Extensions make use 802.11 specifications and Zebra proprietary extensions to achieve the highest level of performance, efficiency and reliability. The TC8000 adds support for the following Zebra Mobility Extensions.

- **Coverage Hole Detection** - The TC8000 includes enhancements to the IEEE 802.11k standard. These improvements will report gaps in signal coverage to the Zebra wireless LAN infrastructure. Network administrators can detect and mitigate coverage gaps present in the network for greater reliability. Default: enabled.
- **Aggregated Fast Transition** - Aggregated FT improves on IEEE 802.11r, Over-the-DS fast roaming. In conjunction with Zebra wireless LAN infrastructure, the TC8000 will achieve more reliable and consistent fast roaming. Default: enabled.
- **Scan Assist** - The TC8000 monitors neighbor access points and retrieves roaming related information from the Zebra wireless LAN infrastructure without doing scans. Using this Scan Assist feature, the TC8000 improves roaming. Default: enabled.

Bluetooth

Bluetooth-equipped devices can communicate without wires, using frequency-hopping spread spectrum (FHSS) radio frequency (RF) to transmit and receive data in the 2.4 GHz Industry Scientific and Medical (ISM) band (802.15.1). Bluetooth wireless technology is specifically designed for short-range (10 meters (32.8 feet)) communication and low power consumption.

Devices with Bluetooth capabilities can exchange information (e.g., files, appointments, and tasks) with other Bluetooth enabled devices such as printers, access points, and other mobile devices.

Adaptive Frequency Hopping

Adaptive Frequency Hopping (AFH) is a method of avoiding fixed frequency interferers, and can be used with Bluetooth voice. All devices in the piconet (Bluetooth network) must be AFH-capable in order for AFH to work. There is no AFH when connecting and discovering devices. Avoid making Bluetooth connections and discoveries during critical 802.11b communications. AFH for Bluetooth consists of four main sections:

- **Channel Classification** - A method of detecting an interference on a channel-by-channel basis, or pre-defined channel mask.
- **Link Management** - Coordinates and distributes the AFH information to the rest of the Bluetooth network.
- **Hop Sequence Modification** - Avoids interference by selectively reducing the number of hopping channels.
- **Channel Maintenance** - A method for periodically re-evaluating the channels.

When AFH is enabled, the Bluetooth radio “hops around” (instead of through) the 802.11b high-rate channels. AFH coexistence allows Enterprise devices to operate in any infrastructure.

The Bluetooth radio in this device operates as a Class 2 device power class. The maximum output power is 2.5 mW and the expected range is 10 meters (32.8 ft.). A definition of ranges based on power class is difficult to obtain due to power and device differences, and whether one measures open space or closed office space.

✓ **NOTE** It is not recommended to perform Bluetooth wireless technology inquiry when high rate 802.11b operation is required.

Security

The current Bluetooth specification defines security at the link level. Application-level security is not specified. This allows application developers to define security mechanisms tailored to their specific need. Link-level security occurs between devices, not users, while application-level security can be implemented on a per-user basis. The Bluetooth specification defines security algorithms and procedures required to authenticate devices, and if needed, encrypt the data flowing on the link between the devices. Device authentication is a mandatory feature of Bluetooth while link encryption is optional.

Pairing of Bluetooth devices is accomplished by creating an initialization key used to authenticate the devices and create a link key for them. Entering a common personal identification number (PIN) in the devices being paired generates the initialization key. The PIN is never sent over the air. By default, the Bluetooth stack responds with no key when a key is requested (it is up to user to respond to the key request event). Authentication of Bluetooth devices is based-upon a challenge-response transaction. Bluetooth allows for a PIN or passkey used to create other 128-bit keys used for security and encryption. The encryption key is derived from the link key used to authenticate the pairing devices. Also worthy of note is the limited range and fast frequency hopping of the Bluetooth radios that makes long-distance eavesdropping difficult.

Recommendations are:

- Perform pairing in a secure environment
- Keep PIN codes private and do not store the PIN codes in the device
- Implement application-level security.

Bluetooth Profiles

The device supports the following Bluetooth services:

- **Service Discovery Protocol (SDP)** - Handles the search for known and specific services as well as general services.
- **Serial Port Profile (SPP)** - Allows use of RFCOMM protocol to emulate serial cable connection between two Bluetooth peer devices. For example, connecting the device to a printer.
- **Generic Access Profile (GAP)** - Controls connections in Bluetooth. Makes device visible and determines how two devices communicate.
- GATT -
- **Advanced Audio Distribution Profile (A2DP)** - Allows the device to stream stereo-quality audio to a wireless headset or wireless stereo speakers.
- **Audio/Video Remote Control Profile (AVRCP)** - Allows the device to control A/V equipment to which a user has access. It may be used in concert with A2DP.
- **Human Interface Device Profile (HID)** - Allows Bluetooth keyboards, pointing devices, gaming devices and remote monitoring devices to connect to the device.
- FTP -
- **Object Push Profile (OPP)** - Allows the device to push and pull objects to and from a push server.

Bluetooth Power States

The Bluetooth radio is off by default.

- **Suspend** - When the TC8000 goes into suspend mode, the Bluetooth radio stays on.
- **Airplane Mode** - When the TC8000 is placed in Airplane Mode, the Bluetooth radio turns off. When Airplane mode is disabled, the Bluetooth radio returns to the prior state. When in Airplane Mode, the Bluetooth radio can be turned back on if desired.

Bluetooth Radio Power

Turn off the Bluetooth radio to save power or if entering an area with radio restrictions (e.g., an airplane). When the radio is off, other Bluetooth devices cannot see or connect to the device. Turn on the Bluetooth radio to exchange information with other Bluetooth devices (within range). Communicate only with Bluetooth radios in close proximity.





NOTE To achieve the best battery life turn off radios when not in use.

Enabling Bluetooth

1. Touch .



- Slide the Bluetooth switch to the **ON** position.  also appears in the Status bar.
- Touch .

Disabling Bluetooth

- Touch .
- Slide the Bluetooth switch to the **OFF** position.
- Touch .

Discovering Bluetooth Device(s)

The TC8000 can receive information from discovered devices without pairing. However, once paired, the TC8000 and a paired device exchange information automatically when the Bluetooth radio is on. To find Bluetooth devices in the area:

- Ensure that Bluetooth is enabled on both devices.
- Ensure that the Bluetooth device to discover is in discoverable mode.
- Ensure that the two devices are within 10 meters (32.8 feet) of one another.
- Touch .
- Touch  **Bluetooth**.
- Touch **SCAN FOR DEVICES**. The TC8000 begins searching for discoverable Bluetooth devices in the area and displays them under **AVAILABLE DEVICES**.
- Scroll through the list and select a device. The **Bluetooth pairing request** dialog box appears.

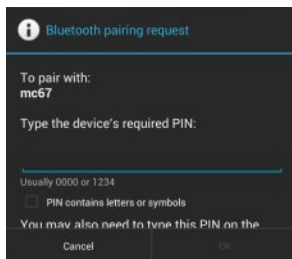

Figure 4-8 Bluetooth Pairing - Enter PIN

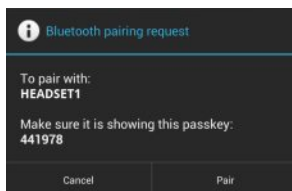





Figure 4-9 Bluetooth Pairing - Smart Pairing

- Enter a PIN in the text box and touch **OK**. Enter the same PIN on the other device.
- For Simple Pairing, touch **Pair** on both devices.
- The Bluetooth device is added to the **Bluetooth devices** list and a trusted ("paired") connection is established.



Changing the Bluetooth Name

By default, the TC8000 has a generic Bluetooth name that is visible to other devices when connected.

1. Touch .
2. Touch  **Bluetooth**.
3. If Bluetooth is not on, slide the switch to the **ON** position.
4. Touch .
5. Touch **Rename device**.
6. Enter a name and touch **Done**.
7. Touch .





Connecting to a Bluetooth Device

Once paired, connect to a Bluetooth device.

1. Touch .
2. Touch  **Bluetooth**.
3. If Bluetooth is not on, slide the switch to the **ON** position.
4. In the **PAIRED DEVICES** list, touch and hold on a unconnected Bluetooth device until a menu appears.
5. Touch **Connect**. When connected, the device is displayed as connected in the list.

Selecting Profiles on the Bluetooth Device

Some Bluetooth devices have multiple profiles. To select a profile:

1. Touch .
2. Touch  **Bluetooth**.
3. In the **PAIRED DEVICES** list, touch  next to the device name.
4. Under **PROFILES**, check or uncheck a profile to allow the device to use that profile.
5. Touch .

Unpairing a Bluetooth Device

To unpair a Bluetooth device and erase all pairing information:

1. Touch .
2. Touch  **Bluetooth**.
3. In the **PAIRED DEVICES** list, touch  next to the device name.

4. Touch **Unpair**.
5. Touch .

Near Field Communications

NFC/HF RFID is a short-range wireless connectivity technology standard that enables secure transaction between a reader and a contactless smartcard. The technology is based on ISO/IEC 14443 type A and B (proximity) and ISO/IEC 15693 (vicinity) standards, using the HF 13.56 MHz unlicensed band. The TC8000 support 3 operating modes:

- Reader mode
- Peer-to-Peer communication
- Card Emulation mode.

Using NFC, the TC8000 can:

- Read contactless cards such as contactless tickets, ID cards and ePassport.
- Read and write information to contactless cards such as SmartPosters and tickets, as well as devices with NFC interface such as vending machines.
- Read information from supported medical sensors.
- Pair with supported Bluetooth devices such as printers and headsets.
- Exchange data with another NFC device.
- Emulate contactless card such as payment, ticket or SmartPoster.

The TC8000 NFC antenna is uniquely positioned to read NFC cards from the back of the device while being held in the user's hand.

Reading NFC Cards

1. Launch an NFC enabled application.
2. Hold device as shown.

Figure 4-10 *Reading Cards*

3. Move TC8000 close to the NFC card until the TC8000 detects the card.
4. Hold the card steadily until the transaction is complete (usually indicated by the application).

Sharing Information Using NFC

You can beam content like a web page, contact cards, pictures, YouTube links or location information from the screen to another device by bringing the devices together back to back.

Make sure both devices are unlocked, support NFC, and have both NFC and Android Beam turned on.

1. Open a screen that contains a web page, video, photo or contact.
2. Move the back of the TC8000 toward the back of the other device.

When the devices connect, you hear a sound, the image on the screen reduces in size, the message **Touch to beam** appears.

3. Touch anywhere on the screen. The transfer begins.

Enterprise NFC Settings

The Enterprise NFC Settings provides advanced configuration of the NFC radio.

To configure the NFC settings, touch **Settings** > **More ...** > **Enterprise NFC Settings**.

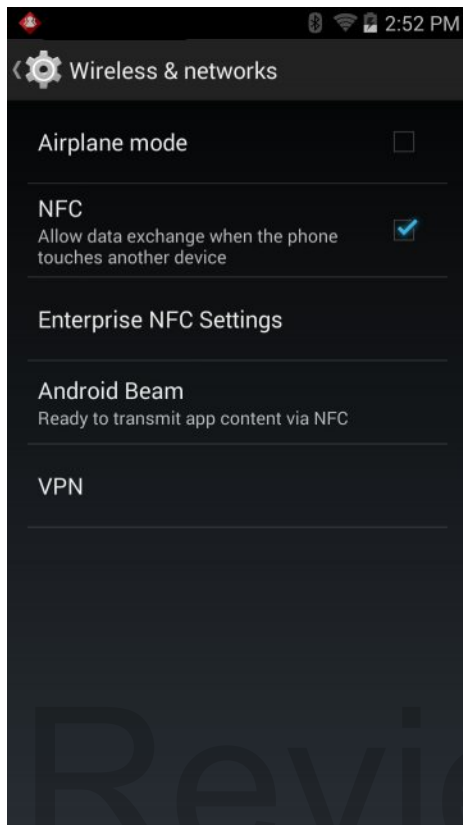

Figure 4-11 Wireless & Networks Screen

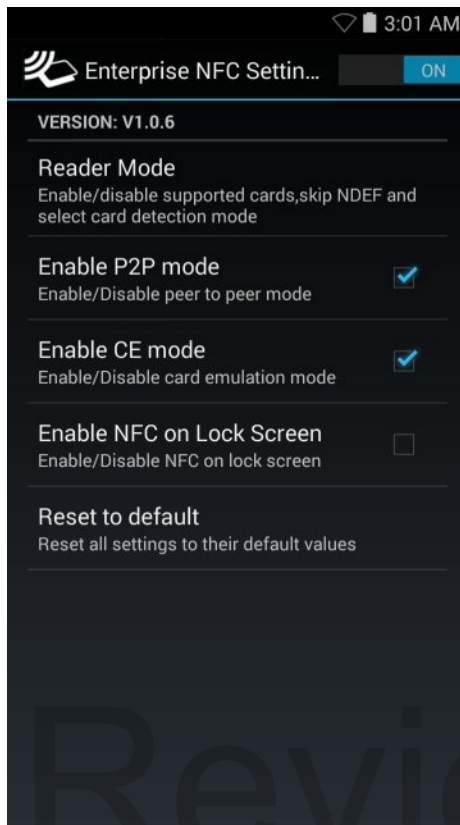

Figure 4-12 Enterprise NFC Settings Screen

- **Reader Mode** – Touch to open the Reader Mode setting screen.
- **Enable P2P mode** – Enable or disable peer to peer mode. Default: Enabled.
- **Enable CE mode** – Touch to enable or disable card emulation mode. Default: Enabled.
- **Enable NFC on Lock Screen** – Enable or disable NFC on lock screen. Default: Disabled.
- **Reset to Default** – Reset all NFC settings to factory default settings.

Reader Mode

Use the **Reader Mode** settings to configure the NFC radio.

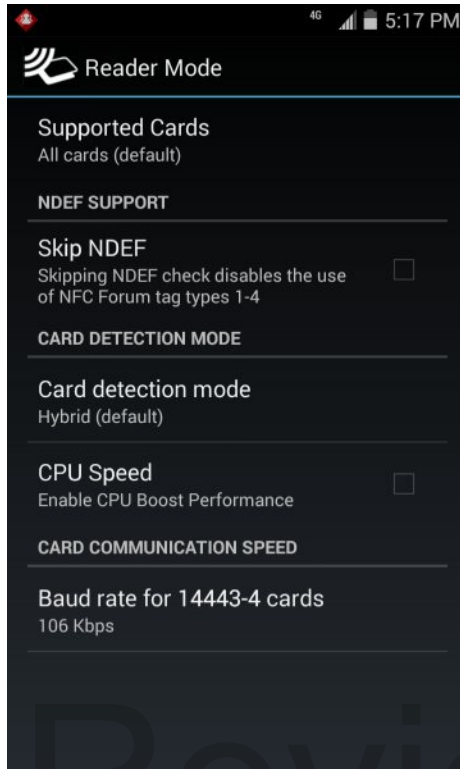

Figure 4-13 Reader Mode Settings

- **Supported Cards** – Touch to select the type of NFC cards to support. Options: **All Cards** (default), **Type A**, **Type B**, **Type F** or **Type V**.
- **NDEF Support**
 - **Skip NDEF** – Enables or disables the use of NFC Forum tag types 1 through 4. Default: Disabled.
- **Card Detection Mode**
 - **Card detection mode** – Touch to select the card detection mode. Options: **Low power**, **Standard** or **Hybrid** (default).
 - **CPU Speed** – Touch to enhance NFC transaction performance while reading small amounts data. Default: Disabled.
 - **Card Communication speed** – Touch to set the baud rate for type A and type B cards. Options: **106 kbps** (default for Type A), **212 kbps**, **424 kbps** or **No restrictions** (default for Type B).
- **Card Communication Speed**
 - **Baud rate for 14443–4 cards** - Options: **106 kbps** (default), **212 kbps**, **424 kbps** or **848 kbps**.

CHAPTER 5 APPLICATIONS

Introduction

This chapter describes the applications installed on the device.

File Browser

Use the **File Browser** application to view and manage files on the device.

To open **File Browser**, touch  > .





Figure 5-1 *File Browser Screen*

The address bar (1) indicates the current folder path. Touch the current folder path to manually enter a path and folder name.

Use  (2) to select multiple files/folder.

Use  (3) to view the internal storage root folder.







Use  (4) to view the Internal Storage root folder.

Use  (5) to view the previous folder or to exit the application.

Touch and hold an item to perform an operation on that item. Select one of the options from the **File Operations** menu:

- **Information** - View detailed information about the file or folder.
- **Move** - Move the file or folder to a new location.
- **Copy** - Copy the select file.
- **Delete** - Delete the selected file.
- **Rename** - Rename the select file.
- **Open as** - Open the selected file as a specific file type.
- **Share** - Share the file with other devices.

Touch  to open additional functionality:

- Touch  > **New Folder** to create a new folder in the current folder.
- Touch  > **Search** to search for a file or folder.
- Touch  > **Sort** to sort the list by name, by type, by size or by date.
- Touch  > **Refresh** to re-display the contents of the current folder.
- Touch  > **List View** to change the folder view from tile to list format.
- Touch  > **Change Size** to change the size of the icons: Large, Normal or Small.
- Touch  > **About File Browser** to view the application version information.

People



Use the **People** application to manage contacts.

From a Home or Apps screen, touch . People opens to the main list of contacts. View contacts in three ways at the top of the screen: Groups, All contacts, and Favorites. Touch the tabs to change how to view the contacts. Swipe up or down to scroll through the lists.



Adding People

1. In the People application, touch .
2. If there are more than one account with contacts, touch the one to use.
3. Type the contact's name and other information. Touch a field to start typing, and swipe down to view all categories.
4. To add more than one entry for a category – for example, to add a work address after typing a personal address – touch **Add new** for that field. To open a menu with preset labels, such as Home or Work for an email address, touch the label to the right of the item of contact information. Or, to create your own label, touch **Custom** in the menu.
5. Touch **Done**.

Editing People

1. In the People application, touch  tab.
2. Touch a person to edit.
3. Touch .
4. Touch **Edit**.
5. Edit the contact information.
6. Touch **Done**.

Deleting People

1. In the People application, touch  tab.
2. Touch a person to edit.
3. Touch .
4. Touch **Delete**.
5. Touch **OK** to confirm.

Camera

This section provides information for taking photos and recording videos using the integrated digital cameras.

- ✓ **NOTE** If a microSD card is installed, The TC8000 saves photos and videos on the microSD card. If a microSD card is not installed, the TC8000 saves photos and videos on the internal storage.

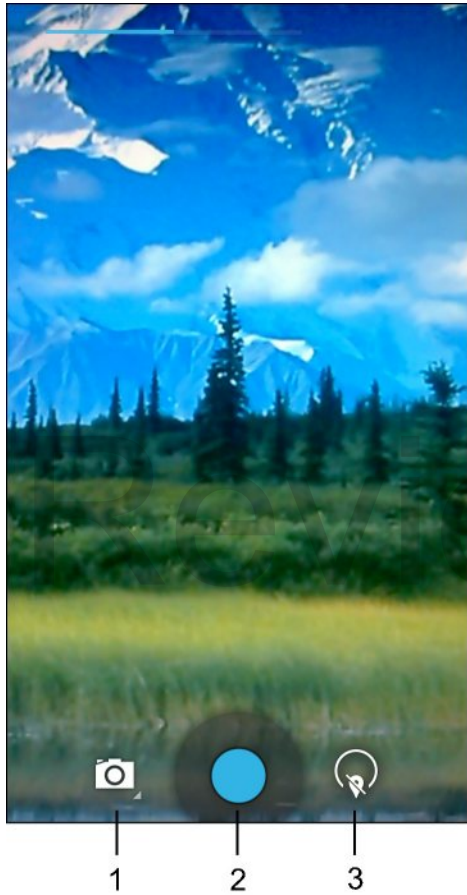

Figure 5-2 Camera Photo Screen

1	Camera Options — Touch to select Camera, Video or Panorama mode.
2	Shutter button - Touch to take a photo, a panoramic photo or to record a video.
3	Photo Settings – Touch to select camera settings.

Taking Photos

- ✓ **NOTE** Camera settings are described in [Photo Settings on page 5-9](#).

1. Touch .

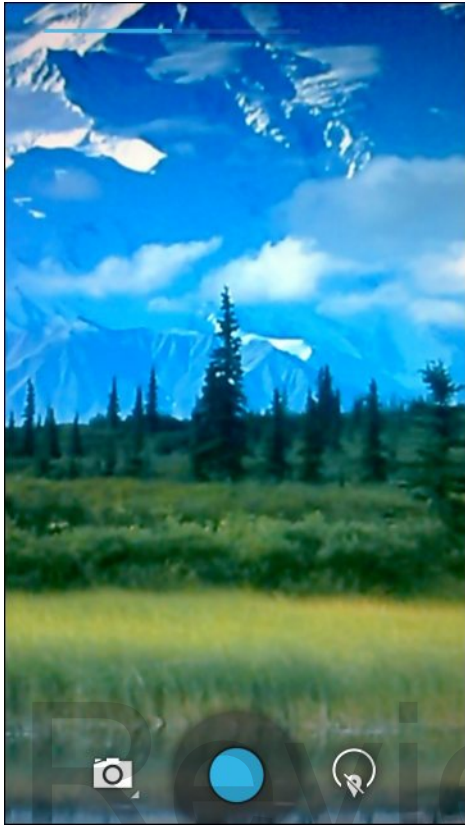



Figure 5-3 *Camera Mode*

2. If necessary, touch the camera options icon and touch .
3. Frame the subject on the screen.
4. To zoom in or out, press two fingers on the display and pinch or expand fingers. The zoom controls appear on the screen.

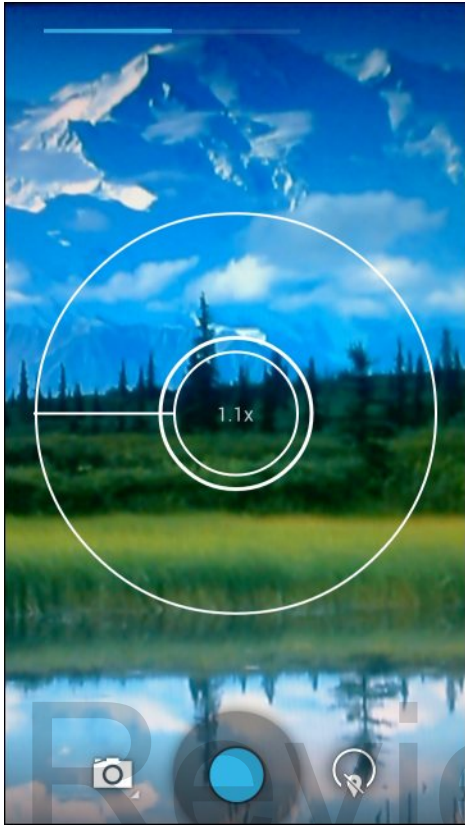





Figure 5-4 Camera Zoom

5. Touch an area on the screen to focus. The focus circle appears on the screen. The two horizontal bars turn green when in focus.
6. Touch .
The camera takes a photo and a shutter sound plays.
Alternately, touch  and hold to focus first, before taking a photo; then release to take a focused photo.
The photo momentarily displays as a thumbnail in the upper right corner.

Taking a Panoramic Photo

Panorama mode lets the user create a single wide image by panning slowly across a scene.

1. Touch .

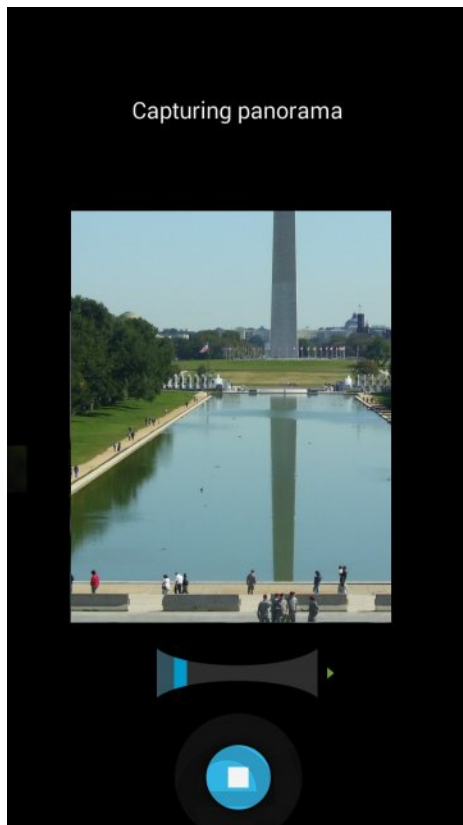





Figure 5-5 Panoramic Mode

2. Touch the options bar and touch .
3. Frame one side of the scene to capture.
4. Touch  and slowly start panning across the area to capture. A small white square appears inside the button indicating the capture is in progress.
If panning too quickly, the message **Too fast** appears.
5. Touch  to end the shot. The panorama appears immediately and a progress indicator displays while it saves the image.

Recording Videos

To record a video:

1. Touch .

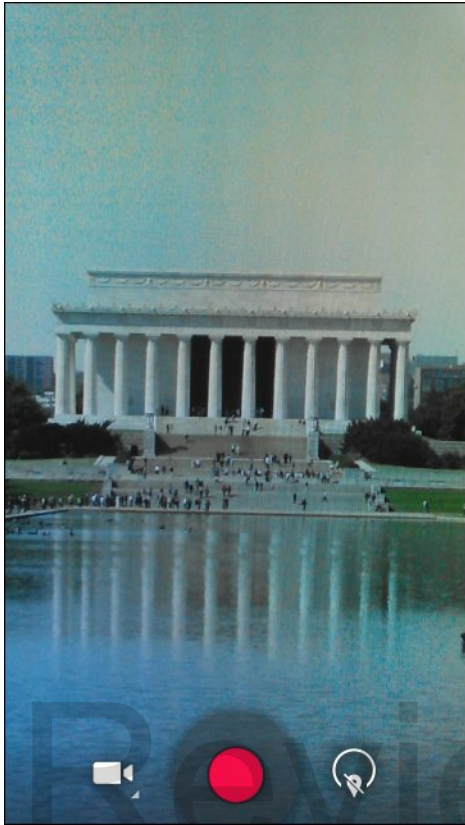



Figure 5-6 *Video Mode*

2. Touch the options bar and touch .
3. Point the camera and frame the scene.
4. To zoom in or out, press two fingers on the display and pinch or expand fingers. The zoom controls appear on the screen.

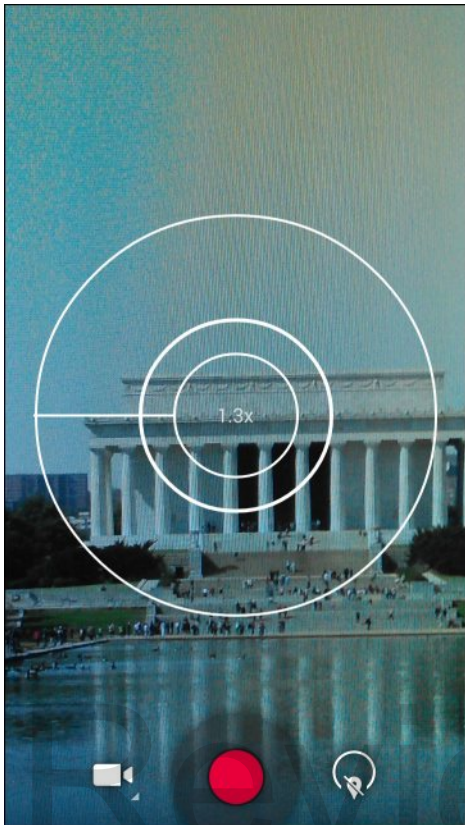

Figure 5-7 Camera Zoom



5. Touch  to start recording.
The device starts recording the video. The video time appears in the top left of the screen.
6. Touch  to end recording.
The video momentarily displays as a thumbnail in the upper right corner.

Photo Settings















When in Photo mode, photo settings are displayed on screen. Touch  to display the photo settings options.
Touch  to display the photo setting options.



Figure 5-8 Photo Setting Options

- **HDR** – Touch to enable High Dynamic Range (HDR) imaging. HDR adds more dynamic range to photographs (the ratio of light to dark). HDR uses three photos, taken at different exposures to create the photo (default - disabled).

- First :
 - **Scene mode** - Touch to select a preset combination of camera settings designed for specific scenes. Options: **Auto** (default), **Night**, **Portrait**, **Landscape**, **Steady Photo**, **Sports** or **Document capture**.
 - **Picture size** - Touch to set the size (in pixels) of the photo. Options: **8M pixels** (default), **5M pixels**, **3M pixels**, **HD 1080p**, **2M pixels**, **1.3M pixels**, **HD720**, **1M pixels**, **WVGA**, **VGA** or **QVGA**.
 - **Picture quality** - Touch to select picture quality setting. Options: **Super fine** (default), **Fine** or **Normal**.
 - **ZSL** - Set the camera to immediately take a picture when the button is pressed (default – disabled)
 - **Countdown timer** - Options: **Off** (default), **1 second**, **2 seconds**, **3 seconds**, **4 seconds**, **5 seconds**, **10 seconds**, **15 seconds**, **20 seconds**, **30 seconds** or **60 seconds**.
 - **Beep during countdown** - Select to play a beep tone during countdown (default – enabled).
- Second :
 - **Face detection** - Select to enable face detection (default – enabled).
 - **Touch AF/AEC** - Select to enable auto focus (default – enabled).
 - **Sharpness** - Touch to select a sharpness level. Options: **Level 0**, **Level 1**, **Level 2**, **Level 3** (default), **Level 4**, **Level 5** or **Level 6**.
 - **Select Auto Exposure** - Touch to select auto exposure setting. Options: **Frame Average** (default), **Center Weighted** or **Spot Metering**.
- Third :
 - **Anti Banding** - Options: **Off**, **50 Hz**, **60 Hz** or **Auto** (default).
 - **Select ISO** - Set how sensitive the camera is to light. Options: **Auto** (default), **ISO Auto (HJR)**, **ISO100**, **ISO200**, **ISO400**, **ISO800** or **ISO1600**.
 - **Exposure** - Touch to adjust the exposure settings. Options: **+2**, **+1**, **0**(default), **-1** or **-2**.
 - **White balance** - Touch to select how Camera adjusts colors in different kinds of light, to achieve the most natural-looking colors.
 -  **Incandescent** - Adjust the white balance for incandescent lighting.
 -  **Fluorescent** - Adjust the white balance for florescent lighting.
 -  **Auto** - Adjust the white balance automatically (default).
 -  **Daylight** - Adjust the white balance for daylight.
 -  **Cloudy** - Adjust the white balance for a cloudy environment.
 - **Flash mode** - Touch to set whether Rear-facing Camera relies on its light meter to decide whether a flash is necessary, or to turn it on or off for all shots.
 -  **Off** - Disable flash.
 -  **Auto** - Camera adjusts flash automatically depending upon light meter (default).
 -  **On** - Enable flash upon taking a photo.
 -  **Torch** - Turn flash on continuously.
 - **Focus Mode** - Touch to select the camera focus setting. Options: **Auto**, **Infinity**, **Macro** or Continuous Auto Focus (**CAF**) (default).
 - **AE-Bracket** - Touch to set Automatic Exposure Bracketing (default – disabled).

Video Settings

When in Video mode, video settings are displayed on screen. Touch  to display the video settings options.









Touch  to display the photo setting options.



Figure 5-9 Video Setting Options

- First 
 - **Time lapse** - Touch to select a time interval to set the frame rate for time lapse photography. Options: **Off** (default), Slide switch to **ON** and then set time interval.
 - **Video quality** - Touch to select video quality:
 - **HD 1080p** - High definition 1080p (default).
 - **HD 720p** - High definition 720p.
 - **SD 480p** - Standard definition 480p.
 - **Video duration** - Options: **30 seconds (MMS)** or **30 minutes** (default).
- Second 
 - **White balance** - Touch to select how Camera adjusts colors in different kinds of light, to achieve the most natural-looking colors.
 -  **Incandescent** - Adjust the white balance for incandescent lighting.
 -  **Fluorescent** - Adjust the white balance for florescent lighting.
 -  **Auto** - Adjust the white balance automatically (default).
 -  **Daylight** - Adjust the white balance for daylight.
 -  **Cloudy** - Adjust the white balance for a cloudy environment.
 - **Flash mode** - Select to turn on flash (default – disabled).

Gallery

✓ **NOTE** The device supports the following image formats: jpeg, gif, png and bmp.

The device supports the following video formats: H.263, H.264 and MPEG4 Simple Profile.

Use Gallery to:

- view photos
- play videos
- perform basic editing of photos
- set photos as wallpaper
- set photos as a contact photo
- share photos and videos.

To open the Gallery application, touch  > .

Gallery presents all photos and videos stored in memory.

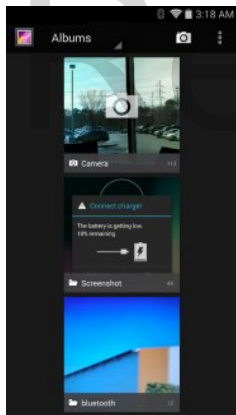



Figure 5-10 Gallery — Albums

- Touch an album to open it and view its contents. The photos and videos in the album are displayed in chronological order.
- Touch a photo or video in an album to view it.
- Touch  icon (top left corner) to return to the main **Gallery** screen.
- Touch  to return to the main **Gallery** screen.

Working with Albums



Albums are groups of images and videos in folders. Touch an album to open it. The photos and videos are listed in a chronologically ordered grid. The name of the album displays at the top of the screen.





Figure 5-11 *Photos Inside an Album*

Swipe left or right to scroll images across the screen.

Share an Album



1. Touch  > .
2. Touch and hold an album until it highlights.
3. Touch other albums as required.
4. Touch . The Share menu opens. Touch the application to use to share the selected albums.
5. Follow the instructions within the selected application.

Get Album Information

1. Touch  > .
2. Touch and hold an album until it highlights.
3. Touch .
4. Touch **Details**.

Deleting an Album

To delete an album and its contents:

1. Touch  > .
2. Touch and hold an album until it highlights.
3. Check other albums to delete. Ensure that other albums are selected.
4. Touch .



5. In the **Delete selected item?** menu, touch **OK** to delete the album.

Working with Photos

Use Gallery to view photos and edit and share photos.

Viewing and Browsing Photos

To view a photo:

1. Touch  > .
2. Touch an album to open it.
3. Touch a photo.

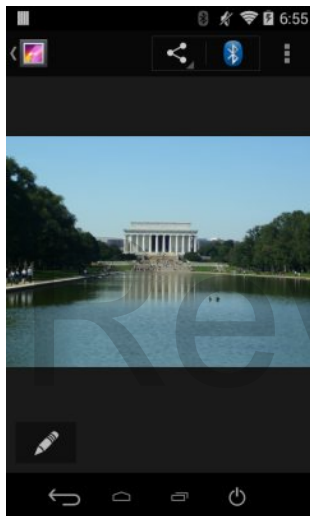



Figure 5-12 Photo Example

4. Swipe left or right to view the next or previous photo in the album.
5. Touch the photo to view the controls.
6. Double-tap the screen to zoom in or pinch two fingers together or spread them apart to zoom in or out.
7. Drag the photo to view parts that are not in view.

Cropping a Photo

1. In Gallery, touch a photo to view the controls.
2. Touch .
3. Touch **Crop**. The white cropping tool appears.
4. Use the cropping tool to select the portion of the photo to crop.
 - Drag from the inside of the cropping tool to move it.
 - Drag an edge of the cropping tool to resize it to any proportion.
 - Drag a corner of the cropping tool to resize it with fixed proportions.

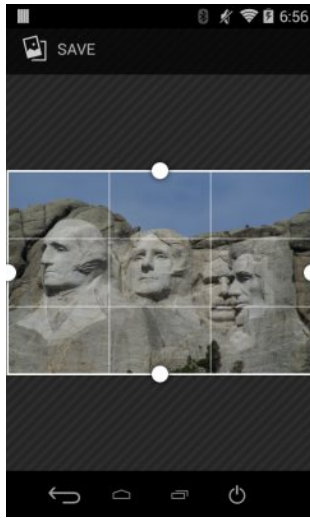







Figure 5-13 *Cropping Tool*

5. Touch **SAVE** to save a copy of the cropped photo. The original version is retained.





Setting a Photo as a Contact Icon

1. Touch  > .
2. Touch an album to open it.
3. Touch the photo to open it.
4. Touch .
5. Touch **Set picture as**.
6. Touch **Contact photo**.
7. In the People application, touch a contact.
8. Touch the white box and crop the photo accordingly.
9. Touch **OK**.

Share a Photo

1. Touch  > .
2. Touch an album to open it.
3. Touch a photo to open it.
4. Touch .
5. Touch the application to use to share the selected photo. The application selected opens with the photo attached to a new message.

Deleting a Photo

1. Touch  > .
2. Touch an album to open it.
3. Touch a photo to open it.
4. Touch .
5. Touch .
6. Touch **Delete**.
7. Touch **OK** to delete the photo.

Working with Videos

Use Gallery to view videos and share videos.

Watching Videos





1. Touch  > .
2. Touch an album to open it.
3. Touch a video.



Figure 5-14 Video Example





4. Touch . The video begins to play.
5. Touch the screen to view the playback controls.

Sharing a Video

1. Touch  > .
2. Touch an album to open it.

3. Touch a video to open it.
4. Touch . The Share menu appears.
5. Touch the application to use to share the selected video. The application selected opens with the video attached to a new message.

Deleting a Video

1. Touch  > .
2. Touch an album to open it.
3. Touch a video to open it.
4. Touch .
5. Touch .
6. Touch **Delete**.
7. Touch **OK**.

Review Copy

DataWedge Demonstration

Use DataWedge Demonstration to demonstrate data capture functionality.

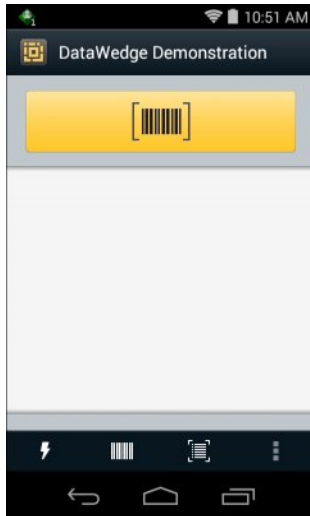

Figure 5-15 DataWedge Demonstration Window

Table 5-1 DataWedge Demonstration Icons

Icon	Description
	Toggles the flash on and off when using the camera to capture bar code data. Use the flash in dimly lit areas.
	Toggles the data capture function between the internal imager/scanner, internal camera or RS507 Hands-free Bluetooth imager (if connected).
	Toggles between normal scan mode and picklist mode when capturing bar code data.
	Opens a menu to view the application information or to set the application DataWedge profile.



NOTE See [Chapter 9, DataWedge](#) for information on DataWedge configuration.

Either press the Scan key or touch the yellow scan button in the application to enable data capture. The captured data appears in the text field below the yellow button.

MLog Manager

Use **MLog Manager** to capture log files for diagnostics. See the *TC8000 Integrator Guide* for detailed information on configuring the application.

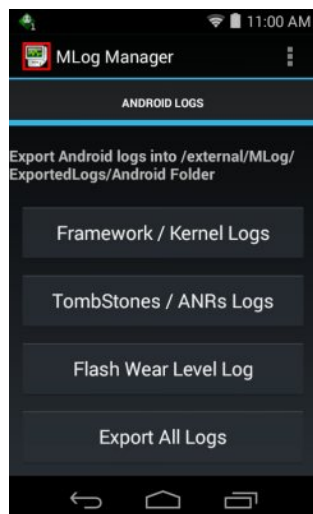

Figure 5-16 MLog Manager

Review Copy

RxLogger

RxLogger is a comprehensive diagnostic tool that provides application and system metrics. It allows for custom plug-ins to be created and work seamlessly with this tool. RxLogger is used to diagnose device and application issues. Its information tracking includes the following: CPU load, memory load, memory snapshots, battery consumption, power states, wireless logging, cellular logging, TCP dumps, Bluetooth logging, GPS logging, logcat, FTP push/pull, ANR dumps, etc. All logs and files generated are saved onto flash storage on the device (internal or external).



Figure 5-17 RxLogger

RxLogger Configuration

RxLogger is built with an extensible plug-in architecture and comes packaged with a number of plugins already built-in. The included plug-ins are described below. Touch  > **Settings** to open the configuration screen.

Configuration File

RxLogger configuration can be set using an XML file. The *config.xml* configuration file is located on the **Enterprise storage** in the *RxLogger\config* folder. Copy the file from the device to a host computer using a USB connection. Edit the configuration file and then replace the .XML file on the device. There is no need to stop and restart the RxLogger service since the file change is automatically detected.

Enabling Logging

1. Touch  > .
2. Touch **Start**.
3. Touch .

Disabling Logging

1. Touch  > .
2. Touch **Stop**.

3. Touch .

Extracting Log Files

1. Connect the device to a host computer using an USB connection.
2. Using a file explorer, navigate to the **On Device Storage** in the `/RxLogger` folder.
3. Copy the file from the device to the host computer.
4. Disconnect the device from the host computer.

Review Copy

Elemez



NOTE Elemez collects specific device information in the background and sends this information to us to help improve product functionality. This feature can be disabled.

See Disabling Elemez Data Collection. Ensure that the date, time and time zone are set correctly prior to using Elemez.

Use **Elemez** to provide diagnostics information to us. Touch **Submit Diagnostics** button to send the data.

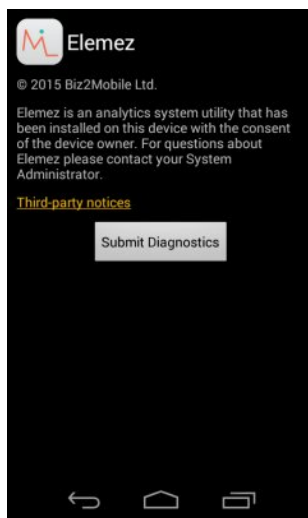



Figure 5-18 Elemez Application





Disabling Elemez Data Collection

The user can disable the Elemez application from collection specific data in the background and sending it to Zebra Technologies.

1. From the Home screen, touch  > **Apps**.
2. Swipe left or right until the **ALL** tab displays.
3. Scroll through the list and touch **Elemez**.
4. In the **App info** screen, touch **Uninstall updates**.
5. In the **Uninstall updates** dialog box, touch **OK**.
6. Touch **OK**.
7. After uninstall is complete, touch **OK**.
8. In the **All** tab, scroll through the list and touch **Elemez**.
9. Touch **Disable**.
10. In the **Disable built-in app?** dialog box, touch **OK**.
11. Touch .

Enabling Elemez Data Collection

The user can re-enable the Elemez application for collection specific data in the background and sending it to Zebra Technologies.

1. From the Home screen, touch .
2. Touch **Manage Apps**.
3. Swipe left or right until the **ALL** tab displays.
4. Scroll through the list and touch **Elemez**.
5. In the **App info** screen, touch **Enable**.
6. Touch  >  > .
7. Touch **Enable Elemez**.

Review Copy

Print Station

Use the **Print Station** app to print labels and receipts directly to a Zebra ZPL printer via USB, Bluetooth or WLAN.

Features include:

- Discovering and pairing with Zebra printers via a Bluetooth, WLAN or USB connection.
- Retrieving and displaying a list of document templates stored on the device and on the printer.
- Using document templates to generate on-screen prompts allowing data entry at print time.
- Using the camera on the device to scan bar codes for data entry.
- Supports multiple Zebra printer models using the ZPL command language.

Review Copy

Zebra Tap & Pair

Use the **Zebra Tap & Pair** application to

Review Copy

Zebra Utilities

Use the **Zebra Utilities** app to print bar code labels and receipts directly to a Zebra printer via Bluetooth or WLAN.

Review Copy

CHAPTER 6 ACCESSORIES

Accessories

Table 6-1 Accessories

Accessory	Part Number	Description
Cradles		
2-Slot USB Charge Cradle	CRD-TC8X-2SUCHG-01	Provides device and spare battery charging and USB communication with a host computer. Use with power supply, p/n PWRS-14000-148R.
5-Slot Charge Only Cradle	CRD-TC8X-5SCHG-01	Charges up to five TC8000 devices. Use with power supply, p/n PWRS-14000-241R and DC line cord, p/n 50-16002-029R.
5-Slot Ethernet Cradle	CRD-TC8X-5SETH-01	Provides device charging and provides Ethernet communication for up to five devices. Use with power supply, p/n PWRS-14000-241R and DC line cord, p/n 50-16002-029R.
5-Slot Charge Only Cradle with Battery Charger	CRD-TC8X-5SC4BC-01	Charges up to four TC8000 devices and four spare batteries. Use with power supply, p/n PWRS-14000-241R and DC line cord, p/n 50-16002-029R.
5-Slot Ethernet Cradle with Battery Charger	CRD-TC8X-5SE4BC-01	Provides device charging and provides Ethernet communication for up to four devices. Provides charging for four spare batteries. Use with power supply, p/n PWRS-14000-241R and DC line cord, p/n 50-16002-029R.
Batteries and Chargers		
Battery	BTRY-TC8X-67MA1-01 BTRY-TC8X-67MA1-10	Replacement battery (single pack). Replacement battery (10-pack).

Table 6-1 Accessories (Continued)

Accessory	Part Number	Description
4-Slot Battery Charger	SAC-TC8X-4SCHG-01	Charges up to four spare batteries. Requires power supply, p/n PWRS-14000-148R.
USB and Charging Cable	CBL-TC8X-USBCHG-01	Provides USB communication and power to the device. Requires power supply PWRS-14000-249R and country specific un-grounded AC line cord.
Audio Accessories		
Quick Disconnect Audio Cable	CBL-TC8X-AUDQD-01	Snaps onto the device and provides audio to a wired headset with Quick Disconnect connector.
3.5 mm Audio Cable	CBL-TC8X-AUDBJ-01	Snaps onto the device and provides audio to a wired headset with 3.5 mm plug.
Mounting Brackets		
2-Slot Cradle Desktop Stand	BRKT-SCRD-SSDK-01	Use for mounting a 2-Slot cradle on a desk.
5-Slot Cradle Desktop Stand	BRKT-SCRD-MSDK-01	Use for mounting a 5-Slot cradle on a desk.
Rack Mount Bracket	BRKT-SCRD-SMRK-01	Use for mounting a 5-Slot cradle or four 4-Slot Battery Chargers on a rack.
Desktop Stand	MNT-TC8X-DKPH-01	Un-powered desktop presentation stand. Allows to use the device on a flat surface (i.e. desktop) for hands-free scanning.
Cart Mount	MNT-TC8X-CMKT-01	Allows to install the device on carts with up to 2" diameter rail/bar and allows to use the device on free-hand scanning mode. Includes: Includes RAM Mount required for installation.
Forklift Mount	MNT-TC8X-FMKT-01	Un-powered forklift mount. Allows to install the device on a roll bar or square surface of a forklift and allows to use the device on landscape or portrait mode. Includes Proclip Mount required for installation.
Carrying Solutions		
Hand Strap	SG-TC8X-HDSTP-01	Replacement hand strap.
Wrist Lanyard	50-12500-006	
Quick Draw Soft Holster	SG-TC8X-QDHLST-01	Use to hold the device. Requires the Universal Belt.
Presentation Soft Holster	SG-TC8X-PMHLST-01	Use to hold the device and scan while in presentation mode. Requires the Universal Shoulder Strap or Universal Belt.
Universal Belt	11-08062-02R	Use to hold the Quick Draw Soft Holster or the Presentation Soft Holster.
Universal Shoulder Strap	WA6010	

Table 6-1 Accessories (Continued)

Accessory	Part Number	Description
Power Supplies		
Power Supply	PWRS-14000-249R	Provides power to the device using the Snap-On USB Cable or Charging Cable Cup. Requires AC line cord.
Power Supply	PWRS-14000-148R	Provides power to the 2-Slot cradles and 4-Slot Spare Battery Charger. Requires AC line cord.
Power Supply	PWRS-14000-241R	Provides power to the 5-Slot Charge Only Cradle, 5-Slot Ethernet Cradle, 5-Slot Charge Only Cradle with Battery Charger and the 5-Slot Ethernet Cradle with Battery Charger. Requires DC Line Cord, p/n 50-16002-029R and country specific three wire grounded AC line cord sold separately.
DC Y Cable	25-85993-01R	Use to provide power from the PWRS-14000-241R power supply to two 4-Slot Battery Chargers.
DC Line Cord	50-16002-029R	Provides power from the power supply to the 5-Slot Charge Only Cradle, 5-Slot Ethernet Cradle, 5-Slot Charge Only Cradle with Battery Charge and 5-Slot Ethernet Cradle with Battery Charger.
Miscellaneous		
Stylus	SG-TC7X-STYLUS-03	Stylus for use with the device (3-pack).
Screen Protectors	MISC-TC8X-SCRN-01	Provides additional protection for display.

2-Slot Charge Only Cradle

- ✓ **NOTE** Ensure that you follow the guidelines for battery safety described in [Battery Safety Guidelines on page 7-1](#).

The 2-Slot Charge Only Cradle:

- provides 5 VDC power for operating the device
- charges a spare battery.

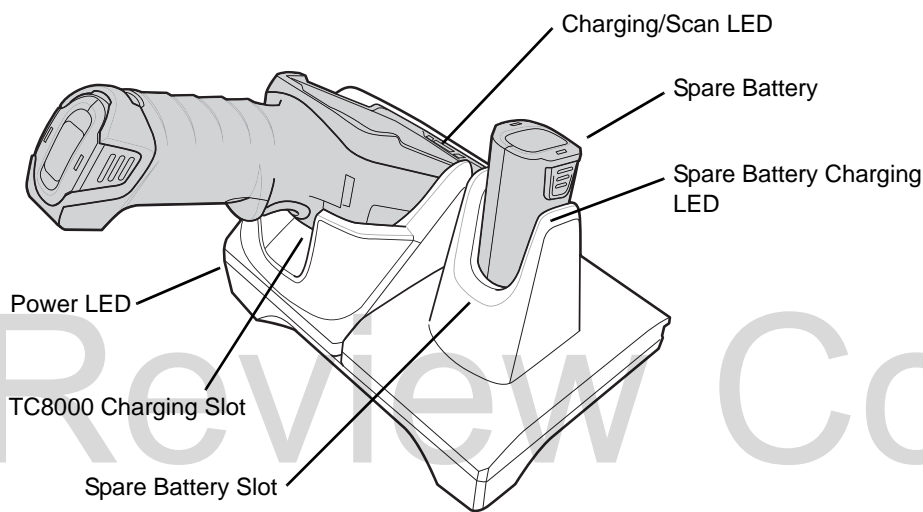

1. Insert the device into the TC8000 charge well.
2. Insert a spare battery into the spare battery charge well.

Battery Charging

Main Battery Charging

The TC8000 Charging/Scan LED indicates the status of the battery charging in the device. See [Table 1-3 on page 1-6](#).

The 6,400 mAh battery fully charges in less than six hours at room temperature.

Spare Battery Charging

The Spare Battery Charging LED indicates the status of the spare battery charging.

The 6,400 mAh battery fully charges in less than six hours at room temperature.

Table 6-2 Spare Battery Charging LED Indicators

State	Indication
Off	TC8000 is not charging. TC8000 is not inserted correctly in the cradle or connected to a power source. Charger/cradle is not powered.
Solid Amber	Battery is charging.
Solid Green	Charging is complete.
Fast Blinking Red (2 blinks/second)	Charging error, e.g.: - Temperature is too low or too high. - Charging has gone on too long without completion (typically eight hours).
Solid Red	Battery is at end of useful life.

Charging Temperature

Charge batteries in temperatures from 0 °C to 40 °C (32 °F to 104 °F). The device or cradle always performs battery charging in a safe and intelligent manner. At higher temperatures (e.g. approximately +37 °C (+98 °F)) the device or cradle may for small periods of time alternately enable and disable battery charging to keep the battery at acceptable temperatures. The device and cradle indicates when charging is disabled due to abnormal temperatures via its LED.

5-Slot Charge Only Cradle

- ✓ **NOTE** Ensure that you follow the guidelines for battery safety described in [Battery Safety Guidelines on page 7-1](#).

The 5-Slot Charge Only Cradle:

- Provides 5 VDC power for operating the TC8000.
- Simultaneously charges up to five TC8000s.

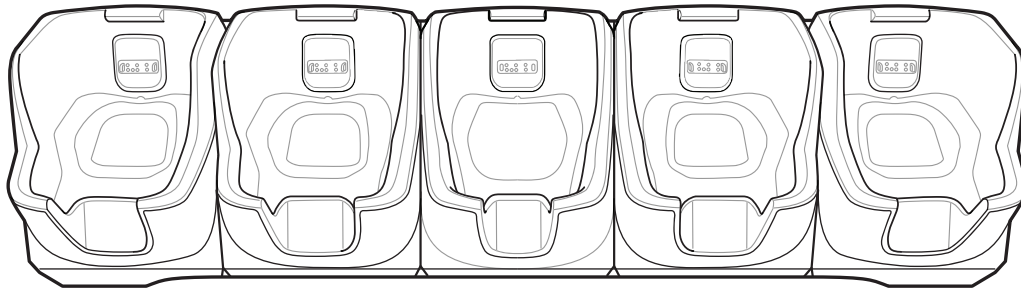

Figure 6-1 5-Slot Charge Only Cradle

Charging the TC8000

To Charge the TC8000:

1. Insert the TC8000 in a charge well to begin charging.

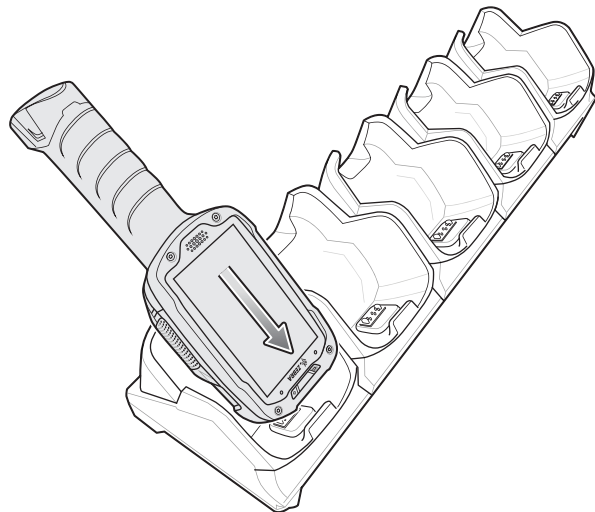

Figure 6-2 TC8000 Battery Charging

2. Ensure that the TC8000 is properly seated in the charge well.

Battery Charging

Main Battery Charging

The TC8000 Charging/Scan LED indicates the status of the battery charging in the device. See [Table 1-3 on page 1-6](#).

The 6,400 mAh battery fully charges in less than six hours at room temperature.

Review Copy

5-Slot Charge Only Cradle with Battery Charger

- ✓ **NOTE** Ensure that you follow the guidelines for battery safety described in [Battery Safety Guidelines on page 7-1](#).

The 5-Slot Charge Only Cradle with Battery Charger:

- Provides 5 VDC power for operating the TC8000.
- Simultaneously charges up to four TC8000s.
- Simultaneously charges up to four spare batteries.

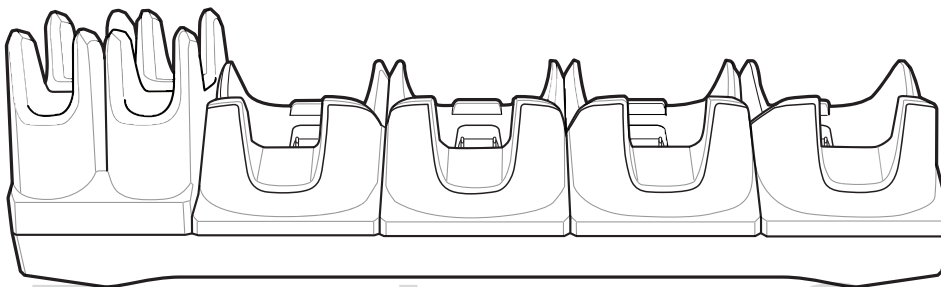

Figure 6-3 5-Slot Charge Only Cradle with Battery Charger

To Charge the TC8000:

1. Insert the TC8000 in a charge well to begin charging.

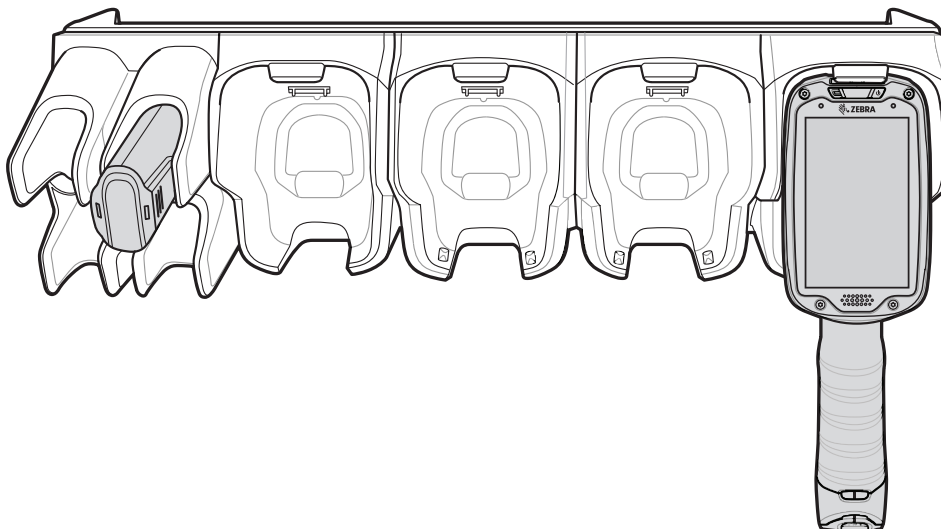

Figure 6-4 TC8000 Battery Charging

2. Ensure that the TC8000 is properly seated in the charge well.

Battery Charging

Main Battery Charging

The TC8000 Charging/Scan LED indicates the status of the battery charging in the device. See [Table 1-3 on page 1-6](#).

The 6,400 mAh battery fully charges in less than six hours at room temperature.

Spare Battery Charging

Each Battery Charging LED indicates the status of the battery charging in each slot. The table below describes the Battery Charging LED status.

The 6,400 mAh battery fully charges in less than six hours at room temperature.

Table 6-3 *Battery Charging Indicators*

State	Indication
Off	Battery is not charging. It is not inserted correctly in the cradle or connected to a power source. Charge is not powered.
Solid Amber	Battery is charging.
Solid Green	Charging is complete.
Fast Blinking Red (2 blinks/second)	Charging error, e.g.: - Temperature is too low or too high. - Charging has gone on too long without completion (typically eight hours).
Solid Red	Battery is at end of useful life.

Charging Temperature

Charge batteries in temperatures from 0 °C to 40 °C (32 °F to 104 °F). The battery charger always performs battery charging in a safe and intelligent manner. At higher temperatures (e.g. approximately +37 °C (+98 °F)) the battery charger may for small periods of time alternately enable and disable battery charging to keep the battery at acceptable temperatures. The battery charger indicates when charging is disabled due to abnormal temperatures via its LED.

5-Slot Ethernet Cradle

- ✓ **NOTE** Ensure that you follow the guidelines for battery safety described in [Battery Safety Guidelines on page 7-1](#).

The 5-Slot Ethernet Cradle:

- Provides 5 VDC power for operating the TC8000.
- Connects up to five TC8000s to an Ethernet network.
- Simultaneously charges up to five TC8000s.

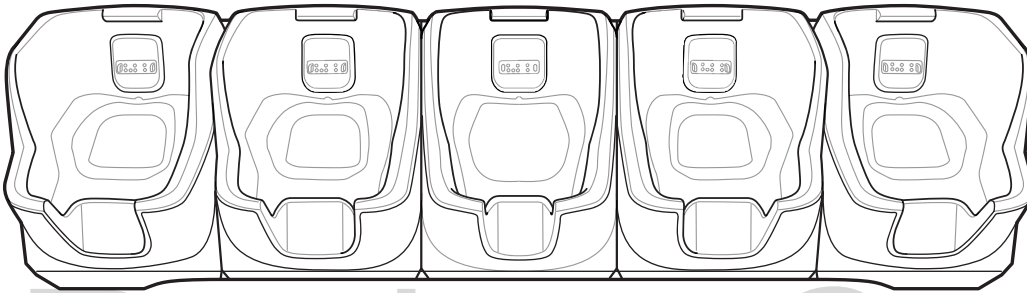

Figure 6-5 5-Slot Ethernet Cradle

Charging the TC8000

To charge the TC8000:

1. Insert the TC8000 in a charge well to begin charging.

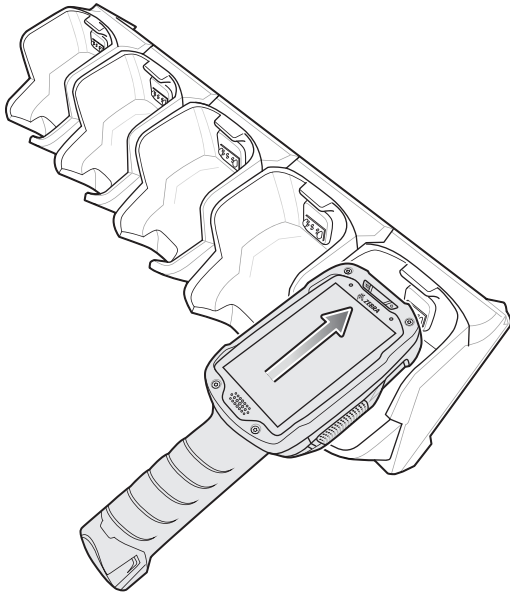

Figure 6-6 TC8000 Battery Charging

2. Ensure that the TC8000 is properly seated in the charge well.

Battery Charging

Main Battery Charging

The TC8000 Charging/Scan LED indicates the status of the battery charging in the device. See [Table 1-3 on page 1-6](#).



The 6,400 mAh battery fully charges in less than six hours at room temperature.

Charging Temperature

Charge batteries in temperatures from 0 °C to 40 °C (32 °F to 104 °F). The battery charger always performs battery charging in a safe and intelligent manner. At higher temperatures (e.g. approximately +37 °C (+98 °F)) the battery charger may for small periods of time alternately enable and disable battery charging to keep the battery at acceptable temperatures. The battery charger indicates when charging is disabled due to abnormal temperatures via its LED.

Establishing Ethernet Communication

NOTE Refer to the TC8000 Integrator Guide for information on configuring the Ethernet settings.

1. Touch .
2. Touch **Ethernet**.
3. Slide the Ethernet switch to the **ON** position.
4. Insert the device into a slot.
5. The  icon appears in the Status bar.
6. Touch **Eth0** to view Ethernet connection details.

Ethernet LED Indicators

There are two green LEDs on the side of the cradle. These green LEDs light and blink to indicate the data transfer rate.

Table 6-4 LED Data Rate Indicators

Data Rate	1000 LED	100/10 LED
1 Gbps	On/Blink	Off
100 Mbps	Off	On/Blink
10 Mbps	Off	On/Blink

5-Slot Ethernet Cradle with Battery Charger

- ✓ **NOTE** Ensure that you follow the guidelines for battery safety described in [Battery Safety Guidelines on page 7-1](#).

The 5-Slot Ethernet Cradle:

- Provides 5 VDC power for operating the TC8000.
- Connects up to four TC8000s to an Ethernet network.
- Simultaneously charges up to four TC8000s.

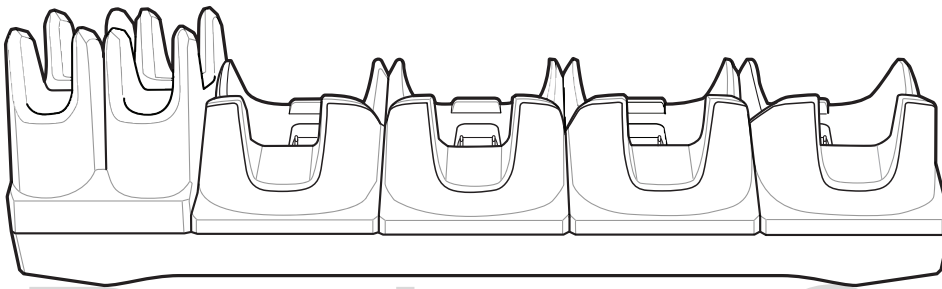

Figure 6-7 5-Slot Ethernet Cradle

Charging the TC8000

To charge the TC8000:

1. Insert the TC8000 in a charge well to begin charging.

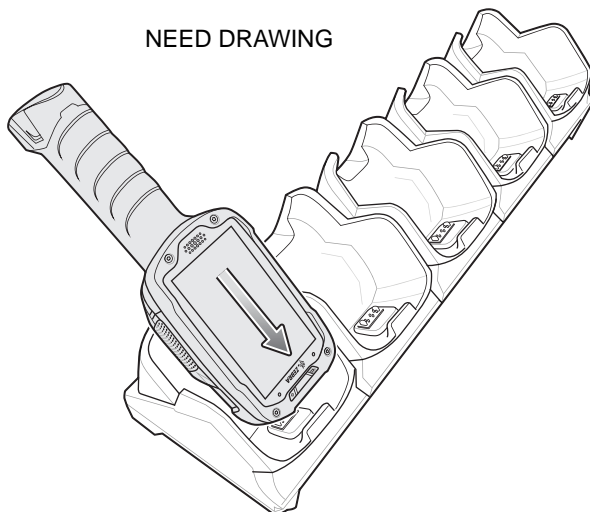

Figure 6-8 TC8000 Battery Charging

2. Ensure that the TC8000 is properly seated in the charge well.

Battery Charging

Main Battery Charging

The TC8000 Charging/Scan LED indicates the status of the battery charging in the device. See [Table 1-3 on page 1-6](#).

The 6,400 mAh battery fully charges in less than six hours at room temperature.

Spare Battery Charging

Each Battery Charging LED indicates the status of the battery charging in each slot. The table below describes the Battery Charging LED status.

The 6400 mAh battery fully charges in less than six hours at room temperature.

Table 6-5 *Battery Charging Indicators*

State	Indication
Off	Battery is not charging. It is not inserted correctly in the cradle or connected to a power source. Charge is not powered.
Solid Amber	Battery is charging.
Solid Green	Charge complete.
Fast Blinking Red (2 blinks/second)	Charging error, e.g.: - Temperature is too low or too high. - Charging has gone on too long without completion (typically eight hours).
Solid Red	Battery is at end of useful life.

Charging Temperature

Charge batteries in temperatures from 0 °C to 40 °C (32 °F to 104 °F). The battery charger always performs battery charging in a safe and intelligent manner. At higher temperatures (e.g. approximately +37 °C (+98 °F)) the battery charger may for small periods of time alternately enable and disable battery charging to keep the battery at acceptable temperatures. The battery charger indicates when charging is disabled due to abnormal temperatures via its LED.

Establishing Ethernet Communication



NOTE Refer to the *TC8000 Integrator Guide* for information on configuring the Ethernet settings.

1. Touch .
2. Touch **Ethernet**.
3. Slide the Ethernet switch to the **ON** position.

4. Insert the device into a slot.
5. The  icon appears in the Status bar.
6. Touch **Eth0** to view Ethernet connection details.

Ethernet LED Indicators

There are two green LEDs on the side of the cradle. These green LEDs light and blink to indicate the data transfer rate.

Table 6-6 *LED Data Rate Indicators*

Data Rate	1000 LED	100/10 LED
1 Gbps	On/Blink	Off
100 Mbps	Off	On/Blink
10 Mbps	Off	On/Blink

Review Copy

4-Slot Battery Charger

- ✓ **NOTE** Ensure that you follow the guidelines for battery safety described in [Battery Safety Guidelines on page 7-1](#).

The 4-Slot Battery Charger charges up to four TC8000 batteries.

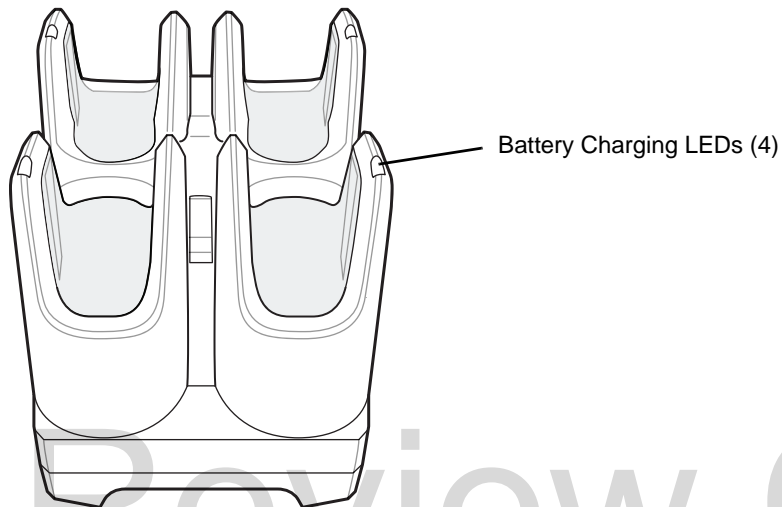

Figure 6-9 4-Slot Battery Charger

Battery Installation

To install the battery:

1. Insert the battery into a battery slot.
2. Gently press down on the battery until it snaps into place.

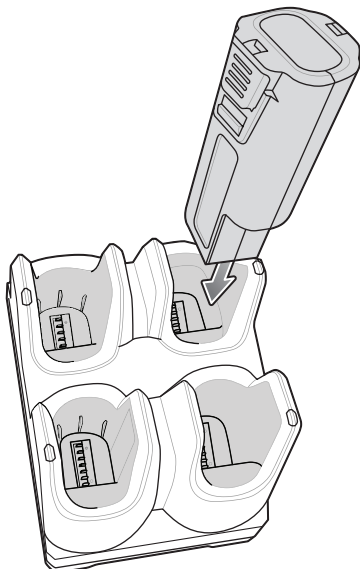

Figure 6-10 Insert Battery into Slot

Battery Removal

To remove the battery, press the two release latches on each side of the battery and lift the battery out of the battery slot.

Figure 6-11 *Remove Battery*

Battery Charging

Spare Battery Charging

Each Battery Charging LED indicates the status of the battery charging in each slot. The table below describes the Battery Charging LED status.

The 6,400 mAh battery fully charges in less than six hours at room temperature.

Table 6-7 *Battery Charging Indicators*

State	Indication
Off	Battery is not charging. It is not inserted correctly in the cradle or connected to a power source. Charger is not powered.
Solid Amber	Battery is charging.
Solid Green	Charge complete.
Fast Blinking Red (2 blinks/second)	Charging error, e.g.: - Temperature is too low or too high. - Charging has gone on too long without completion (typically eight hours).
Solid Red	Battery is at end of useful life.

Charging Temperature

Charge batteries in temperatures from 0 °C to 40 °C (32 °F to 104 °F). The battery charger always performs battery charging in a safe and intelligent manner. At higher temperatures (e.g. approximately +37 °C (+98 °F)) the battery charger may for small periods of time alternately enable and disable battery charging to keep the battery at

acceptable temperatures. The battery charger indicates when charging is disabled due to abnormal temperatures via its LED.

Review Copy

USB and Charging Cable

- ✓ **NOTE** Ensure that you follow the guidelines for battery safety described in [Battery Safety Guidelines on page 7-1](#).

The USB and Charging cable snaps onto the top of the TC8000. When attached to the TC8000, allows the TC8000 to transfer data to a host computer and provide power for charging the TC8000.

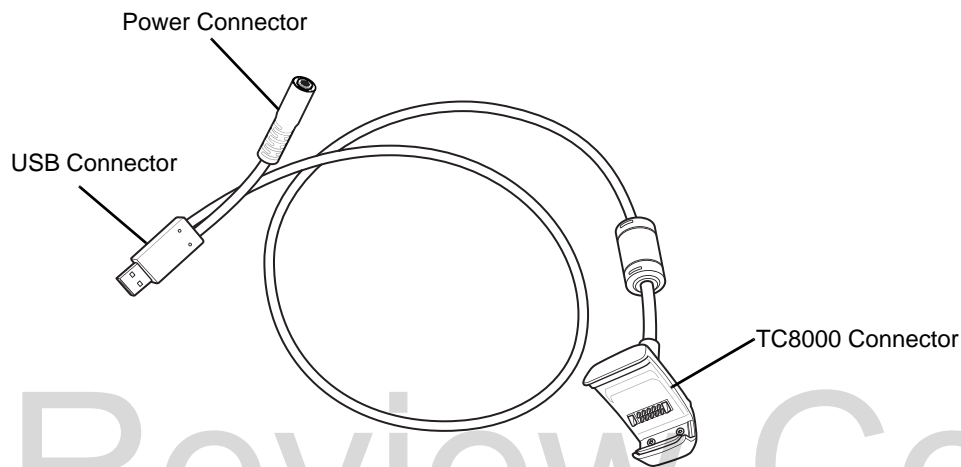

Figure 6-12 Snap-On USB Cable

Attaching the USB and Charging Cable

1. Align the tabs on the Audio Adapter with the slots on the device.
2. Rotate the Adapter toward the back of the device until the Adapter snaps onto the device.

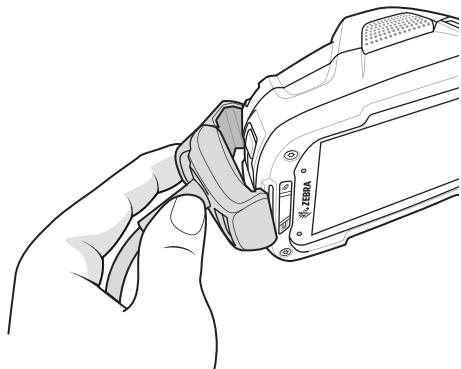

Figure 6-13 Attach Cable to TC8000

3. Attach the USB connection to the host computer.

USB Communication

1. Connect the USB and Charging Cable to the TC8000.
2. Connect the USB connector of the cable to a host computer.

Figure 6-14 *Power Setup*

Removing the USB and Charging Cable

To remove the USB and Charging cable:

1. Press the release level toward the cable.
2. Rotate the adapter toward the front of the device and remove.

Figure 6-15 *Remove Audio Adapter*

Battery Charging

To charge the TC8000, attached the power cable to the Power Connection on the Snap-On USB cable and it in.

Main Battery Charging

The TC8000 Charging/Scan LED indicates the status of the battery charging in the device. See [Table 1-3 on page 1-6](#).

The 6,400 mAh battery fully charges in less than six hours at room temperature.

Review Copy

Quick Disconnect Audio Adapter

The Quick Disconnect Audio Adapter snaps onto the top of the TC8000 and removes easily when not in use. When attached to the TC8000, the Quick Disconnect Audio Adapter allows a user to connect a wired headset to the TC8000.

Attaching the Audio Adapter

1. Align the tabs on the Audio Adapter with the slots on the device.
2. Rotate the Adapter toward the back of the device until the Adapter snaps onto the device.

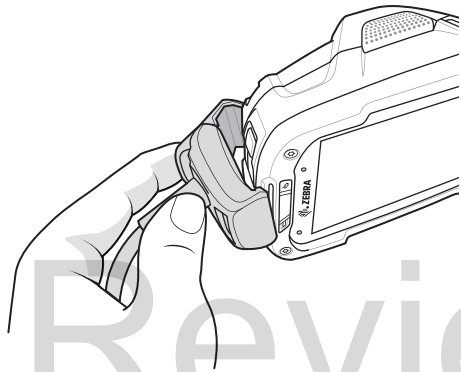

Figure 6-16 *Attach Cable to TC8000*

Connecting the Adapter to a Headset

Figure 6-17

Removing the Audio Adapter

To remove the Audio Adapter:

1. Press the release level toward the cable.

2. Rotate the adapter toward the front of the device and remove.

Figure 6-18 *Remove Audio Adapter*

Review Copy

3.5 mm Audio Adapter

The 3.5 mm Audio Adapter snaps onto the top of the TC8000 and removes easily when not in use. When attached to the TC8000, the Audio Adapter allows a user to connect a wired headset to the TC8000.

Attaching the Audio Adapter

1. Align the tabs on the Audio Adapter with the slots on the device.
2. Rotate the Adapter toward the back of the device until the Adapter snaps onto the device.

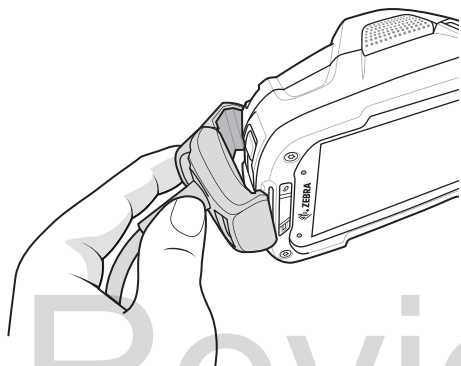

Figure 6-19 *Attach Cable to TC8000*

Removing the Audio Adapter

To remove the Audio Adapter:

1. Press the release level toward the cable.
2. Rotate the adapter toward the front of the device and remove.

Figure 6-20 *Remove Audio Adapter*

Desktop Stand

The Desk Stand provides allows the user place the TC8000 in presentation mode for hands-free scanning.



Figure 6-21 *Desktop Mount*

Review Copy

Cart Mount

The Cart Mount

Review Copy

Figure 6-22 *Cart Mount*

See TC8000 Integrator Guide for assembly instructions.

Quick-Draw Soft Holster

Review Copy

Figure 6-23 *Quick-Draw Holster*

Presentation Holster

Review Copy

Figure 6-24 *Presentation Holster*

Stylus

To install the stylus onto the hand strap:

1. Thread the loop of the tether through the hole in the stylus.

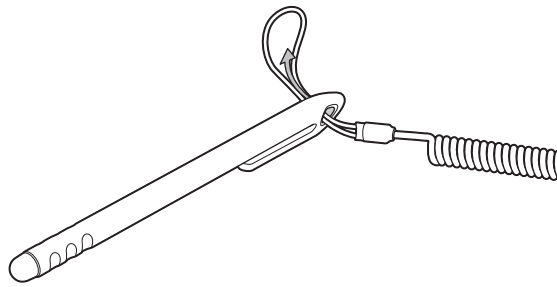

Figure 6-25 Thread Loop through Stylus Hole

2. Thread the other end of the tether through the loop.

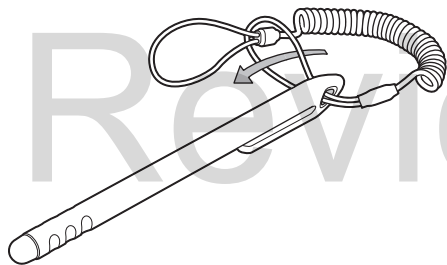

Figure 6-26

- 3.

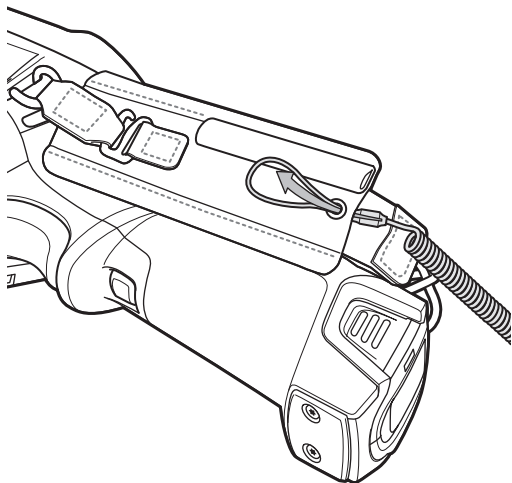

Figure 6-27 Feed Loop through Hand Strap Hole

- 4.

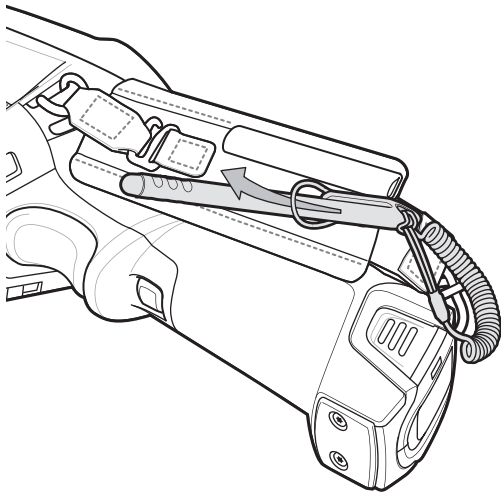

Figure 6-28 *Feed Stylus Through Loop*

5. Pull stylus through the loop and tighten.

Review Copy

Review Copy

CHAPTER 7 MAINTENANCE AND TROUBLESHOOTING

Introduction

This chapter includes instructions on cleaning and storing the TC8000, battery maintenance and provides troubleshooting solutions for potential problems during TC8000 operations.

Maintaining the TC8000

For trouble-free service, observe the following tips when using the TC8000:

- Protect the TC8000 from temperature extremes.
- Do not store or use the TC8000 in any location that is extremely dusty, damp, or wet.
- Use a soft lens cloth to clean the scan exit window of the TC8000. If the surface of the TC8000 screen becomes soiled, clean it with a soft cloth moistened with a diluted window-cleaning solution. Do not use bleach or ammonia.
- Take care not to scratch the screen of the TC8000.
- The display of the TC8000 contains glass. Take care not to drop the TC8000 or subject it to strong impact.

Battery Safety Guidelines

- The area in which the TC8000 units are charged should be clear of debris and combustible materials or chemicals. Particular care should be taken where the device is charged in a non-commercial environment.
- Do not use incompatible batteries and chargers. If you have any questions about the compatibility of a battery or a charger, contact Zebra Support. See [Service Information on page xiii](#) for contact information.
- Do not crush, puncture, or place a high degree of pressure on the battery.
- Follow battery usage, storage, and charging guidelines found in the TC8000 Quick Reference Guide.
- Improper battery use may result in a fire, explosion, or other hazard.
- To charge the mobile device battery, the battery and charger temperatures must be between +32°F and +104°F (0°C and +40°C)

- Do not disassemble or open, crush, bend or deform, puncture, or shred.
- Severe impact from dropping any battery-operated device on a hard surface could cause the battery to overheat.
- Do not short circuit a battery or allow metallic or conductive objects to contact the battery terminals.
- Do not modify or remanufacture, attempt to insert foreign objects into the battery, immerse or expose to water or other liquids, or expose to fire, explosion, or other hazard.
- Do not leave or store the equipment in or near areas that might get very hot, such as in a parked vehicle or near a radiator or other heat source. Do not place battery into a microwave oven or dryer.
- Battery usage by children should be supervised.
- Please follow local regulations to promptly dispose of used re-chargeable batteries.
- Do not dispose of batteries in fire.
- Seek medical advice immediately if a battery has been swallowed.
- In the event of a battery leak, do not allow the liquid to come in contact with the skin or eyes. If contact has been made, wash the affected area with large amounts of water and seek medical advice.
- If you suspect damage to your equipment or battery, call Customer Support to arrange for inspection. See [Service Information on page xiii](#) for contact information.

Long Term Storage

When storing the TC8000 for a long period of time, it is recommended to remove the battery.

When returning the TC8000 to everyday operation, install a fully charged battery.

Cleaning



CAUTION Always wear eye protection.

Read warning label on compressed air and alcohol product before using.

If you have to use any other solution for medical reasons please contact Symbol Technologies for more information.



WARNING! Avoid exposing this product to contact with hot oil or other flammable liquids. If such exposure occurs, unplug the device and clean the product immediately in accordance with these guidelines.

Materials Required

- Alcohol wipes
- Lens tissue
- Cotton tipped applicators
- Isopropyl alcohol

- Can of compressed air with a tube.

Cleaning the TC8000

Housing

Using the alcohol wipes, wipe the housing including the Scan key.

Display

The display can be wiped down with the alcohol wipes, but care should be taken not to allow any pooling of liquid around the edges of the display. Immediately dried the display with a soft, non-abrasive cloth to prevent streaking.

Scan Exit Window

Wipe the scan exit window periodically with a lens tissue or other material suitable for cleaning optical material such as eyeglasses.

Power Connector

1. Remove the main battery from TC8000.
2. Install the battery cover.
3. Dip the cotton portion of the cotton tipped applicator in isopropyl alcohol.
4. Repeat at least three times.
5. Use the cotton tipped applicator dipped in alcohol to remove any grease and dirt near the connector area.
6. Use a dry cotton tipped applicator and repeat steps 3 through 6.
7. Spray compressed air on the connector area by pointing the tube/nozzle about ½ inch away from the surface.



CAUTION Do not point nozzle at yourself and others, ensure the nozzle or tube is away from your face.

8. Inspect the area for any grease or dirt, repeat if required.

Cleaning Cradle Connectors

Use this procedure to clean the connectors on a cradle:

1. Remove power from the cradle.
2. Dip the cotton portion of the cotton tipped applicator in isopropyl alcohol.
3. Rub the cotton portion of the cotton tipped applicator along the pins of the connector. Slowly move the applicator back-and-forth from one side of the connector to the other. Do not let any cotton residue on the connector.
4. All sides of the connector should also be rubbed with the cotton tipped applicator.
5. Spray compressed air in the connector area by pointing the tube/nozzle about ½ inch away from the surface.



CAUTION Do not point nozzle at yourself and others, ensure the nozzle or tube is pointed away from your face.

6. Ensure that there is no lint left by the cotton tipped applicator, remove lint if found.
7. If grease and other dirt can be found on other areas of the cradle, use lint free cloth and alcohol to remove.
8. Allow at least 10 to 30 minutes (depending on ambient temperature and humidity) for the alcohol to air dry before applying power to cradle.

If the temperature is low and humidity is high, longer drying time is required. Warm temperature and dry humidity requires less drying time.

Cleaning Frequency

The cleaning frequency is up to the customer's discretion due to the varied environments in which the TC8000 units are used. They may be cleaned as frequently as required. However when used in dirty environments it may be advisable to periodically clean the scanner exit window to ensure optimum scanning performance.

Review Copy

Troubleshooting

TC8000

Table 7-1 Troubleshooting the TC8000

Problem	Cause	Solution
TC8000 does not turn on.	Battery not charged.	Charge or replace the battery in the TC8000.
	Battery not installed properly.	Ensure battery is installed properly. See Installing the Battery on page 1-4 .
	System crash.	Perform a soft reset. If the TC8000 still does not turn on, perform a hard reset. See Resetting the TC8000 on page 2-15 .
Battery did not charge.	Battery failed.	Replace battery. If the TC8000 still does not operate, try a soft reset, then a hard reset. See Resetting the TC8000 on page 2-15 .
	TC8000 removed from cradle before charging completed.	Insert the TC8000 into the cradle and begin charging. The battery fully charges in approximately four hours.
	Ambient temperature of the cradle is too warm or too cold.	The ambient temperature must be between 0 °C and 40 °C (32 °F and 104 °F).
During data communication, no data was transmitted, or transmitted data was incomplete.	TC8000 unplugged from host computer during communication.	Reconnect the programming cable to the host computer and re-transmit.
	Communication software was incorrectly installed or configured.	See system administrator.
TC8000 turns itself off.	TC8000 is inactive.	The TC8000 turns off after a period of inactivity. If the TC8000 is running on battery power, this period can be set to 15 seconds, 30 seconds, 1 minute, 2 minutes, 5 minutes, 10 minutes, or 30 minutes. TC8000Change the setting if you need a longer delay before the automatic shutoff feature activates.
	Battery is depleted.	Place the TC8000 in the cradle to re-charge the battery.
	Battery is not inserted properly.	Insert the battery properly (see Installing the Battery on page 1-4).
	The TC8000's battery is low and it powers down to protect memory content.	Place the TC8000 in the cradle to re-charge the battery.

Table 7-1 Troubleshooting the TC8000 (Continued)

Problem	Cause	Solution
A message appears stating that the TC8000 memory is full.	Too many files stored on the TC8000.	Delete unused memos and records. You can save these records on the host computer.
	Too many applications installed on the TC8000.	If you have installed additional applications on the TC8000, remove them to recover memory. See <i>Uninstalling an Application</i> on page 10-4.
The TC8000 does not accept scan input.	Scanning application is not loaded.	Verify that the TC8000 is loaded with a scanning application. See the System Administrator.
	Unreadable bar code.	Ensure the symbol is not defaced.
	Distance between imager exit window and bar code is incorrect.	Move the TC8000 closer or further from the bar code to the proper scanning range.
	TC8000 is not programmed for the bar code.	Verify that the TC8000 can read the type of bar code being scanned (See <i>Technical Specifications</i>). Ensure that the bar code parameters are set properly for the bar code being scanned.
	TC8000 is not programmed to generate a beep.	Verify that a beep on a good decode is used. See <i>Bar Code Input</i> on page 9-10 for more information.
	Battery is low.	If the scanner is still not reading symbols, contact the distributor or service.
During USB data communications, no data was transmitted, or transmitted data was incomplete.	Incorrect cable connection.	See <i>Chapter 6, Accessories</i> .
	Communications software is not installed or configured properly.	Perform setup as described in <i>Chapter 6, Accessories</i> . Ensure that a sync program is installed on the host computer.
Cannot sync with Host Computer	Host computer not configured properly.	Ensure that sync program on the host computer is set to allow USB connections.

Cradles

Table 7-2 *Troubleshooting the Cradles*

Symptom	Possible Cause	Solution
TC8000 battery is not charging.	TC8000 was removed from cradle or cradle was unplugged from AC power.	Ensure cradle is receiving power. Ensure TC8000 is seated correctly. Confirm main battery is charging. The battery fully charges in approximately four hours.
	Battery is faulty.	Verify that other batteries charge properly. If so, replace the faulty battery (see Installing the Battery on page 1-4).
	The TC8000 is not fully seated in the cradle.	Remove and re-insert the TC8000 into the cradle, ensuring it is firmly seated.
	Ambient temperature of the cradle is too warm or too cold.	Move the cradle to an area where the ambient temperature is between 0 °C and 40 °C (32 °F and 104 °F).
When the TC8000 is placed in the cradle, the cradle LED does not blink.	Cradle is not powered.	Ensure cradle is receiving power.
	Cradle firmware is corrupted.	Contact system administrator.
	The TC8000 is not operational.	Contact system administrator.
	Cradle - TC8000 communication error.	Contact system administrator.
Cradle LED blinks red.	The cradle is issued an unlock command and it fails to unlock.	Contact system administrator.
	Cradle is overheating due to continuous lock/unlock or other cradle faults.	Contact system administrator.

Review Copy

APPENDIX A SPECIFICATIONS

Technical Specifications

The following tables summarize the TC8000's intended operating environment and general technical hardware specifications.

Table A-1 *Technical Specifications*

Item	Description
Physical and Environmental Characteristics	
Dimensions (H x L x W)	233 mm x 76 mm x 64 mm
Weight	500 g (SE965 scan engine)
Display	Color LCD, 4", 480x800 WVGA resolution, 16 bits/pixel RGB, 450 Nits LED backlight, capacitive touch screen
Speaker	2W speaker
Main Battery	PowerPrecision+ rechargeable 3.7 VDC 6400 mAh Lithium Ion battery
Performance Characteristics	
CPU	Qualcomm 8060 Pro Dual Core 1.7 GHz
Operating System	Android -based AOSP 4.4.3
Memory	1 GB RAM / 4 GB Flash, 1 GB RAM / 8 GB Flash optional
Application Development	Zebra Android EMDK.
Data Capture Method	SE4750 imager (SR and MR), SE965 laser 8 MP auto-focus, color camera w/ flash optional
User Environment	
Operating Temperature	0° C to 40° C (32° F to 104° F)
Storage Temperature	-20° C to 60° C (-4° F to 140° F)

Table A-1 *Technical Specifications (Continued)*

Item	Description
Battery Charging Temperature	0° C to +40° C (32° F to 104° F) ambient temperature range.
Humidity	40° C (RH 10% - 95%) Non-condensing
Flammability	UL94V1
Drop Specification	4 ft.(1.2 m) to vinyl tile over concrete, over product temperature range. 4 ft.(1.2 m) to concrete, at room temperature of 23° C (73.4° F).
Sealing	Liquid penetration per "A4T Casual Spill Test Spec" document number 71-98611-01. Applies ONLY with battery installed.
ESD	± 20k VDC air discharge ± 10k VDC contact discharge
Wireless LAN Data Communications	
Radio	IEEE ® 802.11a/b/g/n/d/h/i/k/r
Data Rates	5GHz: 802.11a/n - up to 72.2 Mbps; 2.4GHz: 802.11b/g/n - up to 72.2 Mbps
Operating Channels	Channels 36 - 165 (5180 - 5825 MHz) Channels 1 - 13 (2412 - 2472 MHz) Actual operating channels/frequencies depend on regulatory rules and certification agency
Security and Encryption	WEP (40 or 104 bit); WPA/WPA2 Personal (TKIP, and AES); WPA/WPA2 Enterprise (TKIP, and AES) - EAP-TTLS (PAP, MSCHAP, MSCHAPv2), EAP-TLS, PEAPv0- MSCHAPv2, PE APv1-EAP-GTC, EAP-FAST (MSCHAPv2 and EAP-GTC) and LEAP
Multimedia	Wi-Fi Multimedia™ (WMM)
Certifications	WFA (802.11n, WMM, WMM-PS), Cisco CCXv4
Fast Roam	PMKID Caching, Opportunistic Key Caching (OKC), Cisco CCKM, 802.11r, Zebra Aggregated FT
Wireless PAN Data Communications	
Bluetooth	V4.0 with Low Energy
USB	USB 2.0 Client for service and maintenance
Imager Decode Capability	
	.

INDEX

A

Numerics

2-D bar codes 3-2

A

accessories 6-1
airplane mode 1-12
albums 5-12
application shortcuts 2-5
aplock administrator 2-10

B

bar codes
 two dimensional 3-2
battery charging temperature A-2
battery usage 1-10
browser 2-8
bullets xiii

C

calculator 2-8
calendar 2-8
camera settings 5-9
cleaning 7-1
clock 2-8
configuration xi
contacts 2-9
conventions
 notational xii
CPU A-1

D

data capture xi
 imager operational modes
 decode mode 3-2
 image capture mode 3-2
 pick list mode 3-2
 imaging 3-2
 two dimensional bar codes 3-2
datawedge 2-8
diagnostics 5-22
dimensions A-1
display xi, A-1
downloads 2-8
drop specification A-2
DWDemo 2-8

E

EAP 4-1
Elemesz 5-22
email 2-8

F

file browser 2-8, 5-1

G

gallery 2-8

H

humidity A-2

I

imager. See data capture, imaging
 imaging 3-2
 information, servicexiii

K

keyboard 2-7

L

laser scanning 3-2
 LED indicators 3-1
 lithium-ion battery 1-1
 low battery notification 1-11

M

maintenance 7-1
 memory xi, A-1
 mobile computer
 scanning 3-1
 starting 1-6
 multiuser administrator 2-10

N

naming folders 2-5

O

operating system xi, A-1
 operating temperature A-1

P

parts of the mobile computer 1-1
 PEAP-GTC 4-1
 PEAP-MSCHAPv2 4-1
 photos 5-4

R

radiosxi
 recording videos 5-7
 RS507 scanning 3-7

S

scanning
 angle 3-3
 imaging 3-2
 range 3-3

scanning considerations 3-3
 screen
 Symbol splash screen 1-6
 screen lock sound 1-15
 screen timeout 1-13
 screen touch notification 1-15
 secure storage administrator 2-10
 service informationxiii
 set date 1-12
 set time 1-12
 set time zone 1-12
 setting
 camera 5-9
 video 5-11
 settings 2-9
 starting the mobile computer 1-6
 storage temperature A-1
 system notification 1-15

T

TLS 4-1
 troubleshooting 7-5
 TTLS
 TTLS-MSCHAP 4-1
 TTLS-MSCHAPv2 4-1
 TTLS-PAP 4-1

U

unpacking 1-1

V

video settings 5-11
 videos 5-4, 5-7

W

weight A-1
 WEP 4-1
 WLAN radio A-2
 WPA 4-1

Review Copy

Review Copy



Zebra Technologies Corporation, Inc.
3 Overlook Point
Lincolnshire, IL 60069, U.S.A.
<http://www.zebra.com>

Zebra and the stylized Zebra head are trademarks of ZIH Corp., registered in many jurisdictions worldwide. All other trademarks are the property of their respective owners.

© 2015 ZIH Corp and/or its affiliates. All rights reserved.