



Zebra[®]

Radio Frequency Identification (RFID)

Programming Guide



© 2008 ZIH Corp. The copyrights in this manual and the software and/or firmware in the printer described therein are owned by ZIH Corp. Unauthorized reproduction of this manual or the software and/or firmware in the printer may result in imprisonment of up to one year and fines of up to \$10,000 (17 U.S.C.506). Copyright violators may be subject to civil liability.

This product may contain ZPL[®], ZPL II[®], and ZebraLink[™] programs; Element Energy Equalizer[®] Circuit; E³[®]; and Monotype Imaging fonts. Software © ZIH Corp. All rights reserved worldwide.

ZebraLink and all product names and numbers are trademarks, and Zebra, the Zebra logo, ZPL, ZPL II, Element Energy Equalizer Circuit, and E³ Circuit are registered trademarks of ZIH Corp. All rights reserved worldwide.

All other brand names, product names, or trademarks belong to their respective holders. For additional trademark information, please see “Trademarks” on the product CD.

This RFID product is manufactured under one or more licenses, which contain certain exclusions. This product may not be sold, used, leased, offered for sale, or otherwise transferred, exported, and imported in the Transportation Market. The Transportation Market means (i) Electronic Toll and Traffic Management (ETTM), (ii) Public Sector Vehicle Registration, Inspection and Licensing Programs, (iii) Railroad Locomotive and Wagon tracking, (iv) airport-based ground transportation management systems (GTMS) and taxi dispatch, (v) revenue-based parking, and (vi) vehicle-initiated mobile payment applications, where the RFID tag is initially attached to the vehicle but not incorporated at the point of vehicle manufacture.

Proprietary Statement This manual contains proprietary information of Zebra Technologies Corporation and its subsidiaries (“Zebra Technologies”). It is intended solely for the information and use of parties operating and maintaining the equipment described herein. Such proprietary information may not be used, reproduced, or disclosed to any other parties for any other purpose without the express, written permission of Zebra Technologies Corporation.

Product Improvements Continuous improvement of products is a policy of Zebra Technologies Corporation. All specifications and designs are subject to change without notice.

Liability Disclaimer Zebra Technologies Corporation takes steps to ensure that its published Engineering specifications and manuals are correct; however, errors do occur. Zebra Technologies Corporation reserves the right to correct any such errors and disclaims liability resulting therefrom.

Limitation of Liability In no event shall Zebra Technologies Corporation or anyone else involved in the creation, production, or delivery of the accompanying product (including hardware and software) be liable for any damages whatsoever (including, without limitation, consequential damages including loss of business profits, business interruption, or loss of business information) arising out of the use of, the results of use of, or inability to use such product, even if Zebra Technologies Corporation has been advised of the possibility of such damages. Some jurisdictions do not allow the exclusion or limitation of incidental or consequential damages, so the above limitation or exclusion may not apply to you.

Contents



About This Document	7
Who Should Use This Document	8
How This Document Is Organized	8
Contacts	10
Document Conventions	11
1 • Introduction to RFID	13
RFID Overview	14
RFID Label Selection	14
Considering RFID Transponder (Tag) Types	14
Accounting for Transponder Inlay Placement	15
Selecting and Purchasing RFID Labels	15
Performing Label Placement Tests	15
Storing RFID Labels	15
Radio Frequency Interference	16
ZPL Commands for RFID Applications	16
SGD Commands for RFID Applications	16
2 • RFID Printer Setup and Operation	17
Set Tag Type	18
Set RF Power Levels	18
Perform RFID Transponder Calibration	18
Download Latest Firmware	19
3 • RFID Control Panel Parameters	21

4 • Creating Basic RFID Label Formats	29
Create and Send an RFID Label Format	30
Sample RFID Label Formats	31
RFID Label Format 1—Encode a Gen 2 Tag in Hexadecimal	31
RFID Label Format 2—Encode a Gen 2 Tag in ASCII	32
RFID Label Format 3—Read Data from Tag and Print Data on Label	33
RFID Label Format 4—Encode Tag, Read Tag, and Print Data on Label	34
RFID Label Format 5—Encode a Class 1 64-bit Tag in Hexadecimal	36
RFID Label Format 6—Encode Tag, Read Tag, and Return Results to Host	37
5 • RFID Antenna Location	39
RXi and RXi HF	40
RZ400 and RZ600	40
R110PAX4	41
RP4T	41
R4Mplus	42
6 • Transponder Characteristics	43
Basic Transponder Characteristics	44
Electronic Product Code (EPC)	45
EPC Fields	45
EPC Structure in RFID Labels	45
EPC Class 1, Generation 2 (Gen 2)	46
Data Content	46
Data and Tag Security	46
Gen 2 Memory Map	46
7 • Troubleshooting	49
RFID Problems	50
RFID Error Codes and Messages	53
Error and Status Messages	53
Error Codes	66
8 • ZPL II Commands for RFID	79
ZPL Overview	81
Printer and Firmware Compatibility	82
^HL or ~HL Return RFID Data Log to Host	84
^HR Calibrate RFID Transponder Position	85
^HV Host Verification	88
^MM Print Mode	89
^RA Read AFI or DSFID Byte	91
^RB Define EPC Data Structure	93
^RE Enable/Disable E.A.S. Bit	95
^RF Read or Write RFID Format	96

^RI Get RFID Tag ID	100
^RM Enable RFID Motion	101
^RN Detect Multiple RFID Tags in Encoding Field	102
~RO Reset Advanced Counters	103
^RQ Quick Write EPC Data and Passwords	105
^RR Specify RFID Retries for a Block	107
^RS Set Up RFID Parameters	108
^RT Read RFID Tag	115
~RV Report RFID Encoding Results	117
^RW Set RF Power Levels for Read and Write	118
^RZ Set RFID Tag Password and Lock Tag	120
^WF Encode AFI or DSFID Byte	123
^WT Write (Encode) RFID Tag	125
^WV Verify RFID Encoding Operation	127
9 • SGD Commands for RFID	129
Printer and Firmware Compatibility	130
odometer.rfid.valid_resetable	132
odometer.rfid.void_resetable	133
rfid.error.response	134
rfid.position.program	135
rfid.reader_1.antenna_port	136
rfid.reader_1.power.read	137
rfid.reader_1.power.single_power	138
rfid.reader_1.power.write	139
rfid.tag.calibrate	141
rfid.tag.data	142
rfid.tag.test	143
rfid.tag.type	144
10 • RFID Applicator Signals	149
Timing Diagrams for RFID	150
Single Signal Mode	150
Double Signal Mode	152
Applicator Interface Connector Pin Configuration	153
Jumper Configurations and Pinouts for +5 V I/O Operation	156
Pinouts for +24-28 V I/O Operation	157
Index	159



Notes • _____



About This Document

This section provides you with contact information, document structure and organization, and additional reference documents.

Contents

Who Should Use This Document	8
How This Document Is Organized	8
Contacts	10
Document Conventions	11

Who Should Use This Document

This Programming Guide is intended for use by the label format developer or printer integrator to create label formats that will encode RFID tags. The following printers/print engines are supported by this Programming Guide:

- R110Xi, R170Xi, and R110Xi HF
- RZ400 and RZ600
- R110PAX4
- R4Mplus
- R2844-Z
- RP4T

How This Document Is Organized

The RFID Programming Guide is set up as follows:

Section	Description
About This Document on page 7	This section provides you with contact information, document structure and organization, and additional reference documents.
Introduction to RFID on page 13	This section describes the basic concepts of Radio Frequency Identification (RFID) and how RFID works with your printer.
RFID Printer Setup and Operation on page 17	How you set up your printer for RFID applications is determined in part by the transponder that you select. This section guides you through some tasks that you may need to perform on your printer to make RFID reading and encoding possible. When you have completed this section, you will be ready to program your RFID label formats.
RFID Control Panel Parameters on page 21	This section shows the control panel parameters that appear on most Zebra RFID printers that have a graphic display.
Creating Basic RFID Label Formats on page 29	After you have selected a transponder type and set your printer appropriately, use the ZPL samples in this section as a base for programming your own RFID label formats.
Troubleshooting on page 49	This section provides information about RFID operational errors that you might need to troubleshoot. For other types of problems, consult the user guide for your printer.
ZPL II Commands for RFID on page 79	This section contains the ZPL II commands for RFID-specific applications.
SGD Commands for RFID on page 129	This section contains the Set/Get/Do (SGD) commands for RFID-specific applications.
RFID Antenna Location on page 39	Operations to test the RFID functions and display RFID tag data require you to place an RFID label over the RFID antenna area. This section shows the location of the RFID antenna in the various Zebra RFID printers.

Section	Description
<i>Transponder Characteristics</i> on page 43	This section describes the different characteristics of some common transponder types.
<i>RFID Applicator Signals</i> on page 149	This section applies to printers that have applicator ports and that are being used in a print and apply system. Included are timing diagrams for good and bad RFID tags and the pin configuration for the applicator port. For basic timing diagrams, see the User Guide for your printer.

Contacts

Technical Support via the Internet is available 24 hours per day, 365 days per year.

Web Site: www.zebra.com

E-mail Back Technical Library:

E-mail address: emb@zebra.com

Subject line: Emailist

Self Service Knowledge Base: www.zebra.com/knowledgebase

Online Case Registration: www.zebra.com/techrequest

Which Department Do You Need?	The Americas	Europe, Africa, Middle East, India	Asia Pacific
Regional Headquarters	Zebra Technologies International, LLC 333 Corporate Woods Parkway Vernon Hills, IL 60061-3109 U.S.A. T: +1 847 793 2600 Toll-free +1 800 423 0422 F: +1 847 913 8766	Zebra Technologies Europe Limited Dukes Meadow Millboard Road Bourne End Buckinghamshire, SL8 5XF United Kingdom T: +44 (0) 1628 556000 F: +44 (0) 1628 556001	Zebra Technologies Asia Pacific Pte. Ltd. 120 Robinson Road #06-01 Parakou Building Singapore 068913 T: + 65 6858 0722 F: +65 6885 0838
Technical Support For questions on the operation of Zebra equipment and software, please call your distributor. For additional assistance, contact us. <i>Please have your model and serial numbers available.</i>	T: +1 877 ASK ZEBRA (275 9327) F: +1 847 913 2578 Hardware: ts1@zebra.com Software: ts3@zebra.com <i>Kiosk printers:</i> T: +1 866 322 5202 E: kiosksupport@zebra.com	T: +44 (0) 1628 556039 F: +44 (0) 1628 556003 E: Tseurope@zebra.com	T: +65 6858 0722 F: +65 6885 0838 E: <i>China:</i> tschina@zebra.com <i>All other areas:</i> tsasiapacific@zebra.com
Repair Service Department For back-to-base service and repair.	T: +1 877 ASK ZEBRA (275 9327) F: +1 847 821 1797 E: repair@zebra.com To request a repair in the U.S., go to www.zebra.com/repair .	T: +44 (0) 1772 693069 F: +44 (0) 1772 693046 New requests: ukrma@zebra.com Status updates: repairupdate@zebra.com	T: +65 6858 0722 F: +65 6885 0838 E: <i>China:</i> tschina@zebra.com <i>All other areas:</i> tsasiapacific@zebra.com
Technical Training Department For Zebra product training courses.	T: +1 847 793 6868 T: +1 847 793 6864 F: +1 847 913 2578 E: ttamerica@zebra.com	T: +44 (0) 1628 556000 F: +44 (0) 1628 556001 E: Eurtraining@zebra.com	T: + 65 6858 0722 F: +65 6885 0838 E: <i>China:</i> tschina@zebra.com <i>All other areas:</i> tsasiapacific@zebra.com
Inquiry Department For product literature and distributor and dealer information.	T: +1 877 ASK ZEBRA (275 9327) E: inquiry4@zebra.com	T: +44 (0) 1628 556037 F: +44 (0) 1628 556005 E: mseurope@zebra.com	E: <i>China:</i> GCmarketing@zebra.com <i>All other areas:</i> APACChannelmarketing@zebra.com
Customer Service Department (US) Internal Sales Department (UK) For printers, parts, media, and ribbon, please call your distributor or contact us.	T: +1 877 ASK ZEBRA (275 9327) E: clientcare@zebra.com	T: +44 (0) 1628 556032 F: +44 (0) 1628 556001 E: cseurope@zebra.com	T: +65 6858 0722 F: +65 6885 0836 E: <i>China:</i> order-csr@zebra.com <i>All other areas:</i> csasiapacific@zebra.com

Key: T: Telephone
F: Facsimile
E: E-mail

Document Conventions

The following conventions are used throughout this document to convey certain information.

Alternate Color (online only) Cross-references contain hot links to other sections in this guide. If you are viewing this guide online in .pdf format, you can click the cross-reference ([blue text](#)) to jump directly to its location.

LCD Display Examples Text from a printer’s Liquid Crystal Display (LCD) appears in **Bubbledot ICG** font.

Command Line Examples Command line examples appear in **Courier New** font. For example, type `ZTools` to get to the Post-Install scripts in the `bin` directory.

Files and Directories File names and directories appear in **Courier New** font. For example, the `Zebra<version number>.tar` file and the `/root` directory.

Icons Used



Important • Advises you of information that is essential to complete a task.



Note • Indicates neutral or positive information that emphasizes or supplements important points of the main text.



Example • Provides an example, often a scenario, to better clarify a section of text.

Illustration Callouts Callouts are used when an illustration contains information that needs to be labeled and described. A table that contains the labels and descriptions follows the graphic. [Figure 1](#) provides an example.

Figure 1 • Sample Figure with Callouts

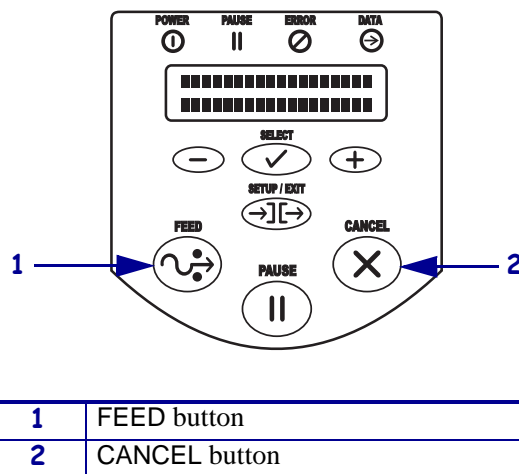



Notes • _____



Introduction to RFID

This section describes the basic concepts of Radio Frequency Identification (RFID) and how RFID works with your printer.

Contents

RFID Overview	14
RFID Label Selection	14
Considering RFID Transponder (Tag) Types	14
Accounting for Transponder Inlay Placement	15
Selecting and Purchasing RFID Labels	15
Performing Label Placement Tests	15
Storing RFID Labels	15
Radio Frequency Interference	16
ZPL Commands for RFID Applications	16
SGD Commands for RFID Applications	16

RFID Overview

An RFID printer encodes (writes) information on ultra-thin HF or UHF RFID transponders that are embedded in “smart” labels, tickets, and tags. The printer encodes the information; verifies proper encoding; and prints bar codes, graphics, and/or text on the label’s surface.

The RFID transponder is sometimes called the RFID tag or an inlay. The transponder is usually made of an antenna that is bonded to an integrated circuit (IC) chip. The IC chip contains the RF circuit, coders, decoders, and memory. If you hold an RFID label up to the light, you can see the transponder’s antenna, and you can feel a bump in the label where the IC chip is located.

Encoding and printing of an RFID label usually are completed on the first try, but some failures may occur. If you experience consistent failures, it may signal a problem with the RFID tags, with your label formats, or with the transponder placement.

RFID Label Selection

To select RFID labels for your printer, consider the type of RFID transponder and where the transponder is placed on the label.

Considering RFID Transponder (Tag) Types

When selecting RFID labels, consider both your RFID printer and your application. Use tag types that have been specifically approved for use in your printer. Failure to do so may result in the inability to read or write to (encode) the embedded RFID tags. To ensure that an approved tag type will perform up to your expectations, evaluate the transponder’s data transmission rates, memory, antenna design, and write capabilities.

As new transponders become commercially available, Zebra will evaluate them for compatibility with your printer. For more information about which tag types can be used with your printer, see [Table 9, Supported Tag Types and Default Values, on page 111](#), or contact your authorized Zebra reseller.



Note • RFID transponders operate on different frequencies. You must use a frequency that complies with local regulations in your country.

For different transponder types, the following characteristics vary:

- The amount of programmable memory, which can include a tag ID (TID), Electronic Product Code (EPC) data, and user memory.
- The way that data is segmented.
- Whether the tag can be locked.

Before you purchase RFID labels, determine what type of RFID transponder to use. Different transponder types can have different attributes. Some transponders can only be read while others can be read and written to repeatedly. Transponders also have different amounts of available memory, which corresponds to the amount of data that can be encoded in it. Select the combination that best suits your needs. For more information on different transponder types, see [Transponder Characteristics on page 43](#).

Accounting for Transponder Inlay Placement

Communication between the RFID label and the printer is established when the label's transponder inlay lines up with the printer's antenna. The optimal transponder programming position varies with the transponder size, its configuration, and the type of RFID IC chip used. For transponder inlay placement information, go to http://www.zebra.com/rfid_transponders.

Print quality may be affected by printing directly over the transponder. In particular, there is an area on each label immediately around the location of the IC chip where the printer may print with low quality. Design your printed label around the location of the chip in the type of approved RFID label that you select.

Selecting and Purchasing RFID Labels

Before you purchase a large quantity of the RFID labels you selected, test a small batch of the labels to make sure they function as you need them to. You may need to adjust the transponder location or switch to a different tag type if the RFID labels do not work in your application.

To order labels with transponders that are approved for your specific RFID printer, contact your authorized Zebra reseller, or go to http://www.zebra.com/smart_labels for more information.

Performing Label Placement Tests

After an RFID label is encoded, how well it functions depends on several things:

- where the label is placed on an item
- the contents of the item (such as metals or liquids)
- the location of the RFID readers.

Perform label placement tests with your readers to identify where labels should be placed on an item to ensure high read rates. Contact the supplier of your RFID transponders for assistance with these types of issues.

Storing RFID Labels

Store RFID labels at temperatures ranging from 60 to 203 °F (15.5 to 95 °C) in environmentally stable conditions. Limit RFID label exposure to electrostatic discharge (ESD). Low-humidity environments may require the use of antistatic mats, straps, or clothing to help counter ESD.

Radio Frequency Interference

Radio Frequency (RF) interference can be caused by many sources. This interference can affect RFID performance by limiting the range of the RFID tags or preventing reading/writing to the tags.

- Foil and metal-based media should not be used for RFID applications. Metal reflects radio frequency signals and is a leading source of RF interference.
- Water and other liquids can absorb RF signals. Some media adhesives and label materials can be unexpected sources of liquids that cause performance problems.
- Other RF equipment can cause interference if the equipment is positioned too close together. Allow sufficient physical space between the RFID printer and other RF products that share the same bandwidth (such as antennas, readers, wireless LANs, or other RFID printer/encoders).

ZPL Commands for RFID Applications

Each RFID label has memory that can be read and most have memory that can be written to through Zebra Programming Language (ZPL) commands. Use ZPL to read and write to (encode) RFID labels just as you would use ZPL to print data on the labels. You can use serialized fields, field variables, and any other ZPL features (such as the command `^HV` on page 88 to return the results to a host computer).

RFID-specific ZPL commands are described in *ZPL II Commands for RFID* on page 79. For examples of how to use the ZPL commands, see *Create and Send an RFID Label Format* on page 30.

For more information about non-RFID ZPL commands and how to use them, refer to the *ZPL II Programming Guide*. A copy is available online at <http://www.zebra.com/manuals>.

SGD Commands for RFID Applications

Your RFID printer is able to use Set/Get/Do (SGD) commands just as it does ZPL commands. Many ZPL commands have equivalent SGD commands. Usually, you will need to run one SGD command for each parameter in the corresponding ZPL command. RFID-specific SGD commands are described in *SGD Commands for RFID* on page 129.

For more information about non-RFID SGD commands and how to use them, refer to the *ZPL II Programming Guide*. A copy is available online at <http://www.zebra.com/manuals>.



RFID Printer Setup and Operation

How you set up your printer for RFID applications is determined in part by the transponder that you select. This section guides you through some tasks that you may need to perform on your printer to make RFID reading and encoding possible. When you have completed this section, you will be ready to program your RFID label formats.

Contents

Set Tag Type	18
Set RF Power Levels	18
Perform RFID Transponder Calibration	18
Download Latest Firmware	19

Set Tag Type

After you select a transponder type and purchase labels, set the transponder (tag) type on the printer. Do this through the control panel menu (see *Specify RFID Tag Type on page 27*) or through the ^RS ZPL command (see *^RS on page 108*).

Set RF Power Levels

Each transponder has specific radio frequency (RF) power setting requirements for read and write operations, which define how much power is necessary to “energize” the transponder in its targeted encoding field. The tag type that you are using must match the RFID power settings of the printer. If necessary, you can change the power settings:

- through the control panel (see *View or Change RFID Read Power on page 24* or *View or Change RFID Write Power on page 25*)
- through the ^RW ZPL command (see *^RW on page 118*)
- through SGD commands (see
 - *rfid.reader_1.power.read on page 137*
 - *rfid.reader_1.power.single_power on page 138*
 - *rfid.reader_1.power.write on page 139*)

Perform RFID Transponder Calibration

If you are using RFID labels that were designed to meet the specifications of your printer, you do not need to perform RFID transponder calibration. The printer will automatically place the labels in the optimal programming position. For transponder placement specifications, go to http://www.zebra.com/rfid_transponders.

If you are using RFID labels that were not designed for your printer, you may need to perform an RFID transponder calibration to determine the optimal programming position for your media. You can perform this calibration through the **RFID TAG CALIB** control panel parameter (see *Calibrate RFID Tag on page 23*) or through the ^HR ZPL command (see *^HL or ~HL on page 84*). To return to the default programming position at any time, use the RESTORE option in the **RFID TAG CALIB** control panel parameter (see *Calibrate RFID Tag on page 23*).

Download Latest Firmware

Zebra may update printer and reader firmware periodically to add new functionality or to fix any known issues with older firmware. At any time, you may download the most recent firmware for your RFID printer. For the firmware files and the downloading instructions, go to <http://www.zebra.com/firmware>.



Important • Download only the firmware designed for your printer and for your region or country. Downloading inappropriate firmware may disable your printer or some or all of the RFID functionality.

Before downloading new firmware, print a printer configuration label and verify that the new printer firmware version is appropriate for your printer. The underlined part of the firmware version shown in [Table 1](#) must match exactly with what was originally installed on your printer.

Table 1 • RFID Printer Firmware Versions

Printer	Firmware Version
R110Xi/R170Xi (UHF)	<u>R60</u> .X.X
R110Xi HF	<u>R65</u> .X.X
R110PAX4	<u>R62</u> .X.X
	<u>R63</u> .X.X
R4Mplus	<u>SP994</u> X
	<u>SP999</u> X
	<u>SP1027</u> X
	<u>SP1056</u> X
	<u>SP1082</u> X
RZ400/RZ600	<u>R53</u> .X.X



Notes • _____



RFID Control Panel Parameters

This section shows the control panel parameters that appear on most Zebra RFID printers that have a graphic display.



Note • The RP4T does not display these parameters.

The parameters shown in [Table 2 on page 22](#) display only if you have an RFID reader and antenna installed. Depending on which type of printer you have and which version of firmware that you are using, not all parameters or options for the parameters may display.



Note • When you enter Setup mode, press PREVIOUS or MINUS (-) (depending on the printer) to access the RFID parameters without scrolling through all of the other printer parameters. Refer to the user guide for your printer for specific instructions on how to use the control panel.

Table 2 • RFID Parameters (Page 1 of 7)

Parameter	Action/Explanation
<div style="border: 1px solid black; padding: 5px; display: inline-block;"> PRINT MODE - RFID + </div>	<p>Select Print Mode</p> <p>Print mode settings tell the printer the method of media delivery to use. Make sure that your printer can support the selected option. Use RFID mode when printing batches of RFID labels to increase throughput time.</p> <p>Default: (R110PAX4) APPLICATOR</p> <p>Default: (all other RFID printers) RFID</p> <p>Selections: vary by printer</p> <p>To change the value shown:</p> <ol style="list-style-type: none"> 1. Press the left oval/MINUS (-) or the right oval/PLUS (+) to scroll through the options.
<div style="border: 1px solid black; padding: 5px; display: inline-block;"> RFID TEST QUICK SLOW </div>	<p>Perform RFID Test</p> <p>In the RFID test, the printer attempts to read and write to a transponder. In the slow version, the printer first displays the hardware version, the reader firmware version, and the program position. If the printer fails the test, the control panel displays READ ERROR. No printer movement occurs with this test.</p> <p>To perform the RFID test:</p> <ol style="list-style-type: none"> 1. Position an RFID label with its transponder over an RFID antenna location. For the location of the RFID antenna on your printer, see RFID Antenna Location on page 39. 2. Press the left oval/MINUS (-) to select QUICK. OR Press the right oval/PLUS (+) to select SLOW. 3. If necessary, press the right oval/PLUS (+) to select CONTINUE.

Table 2 • RFID Parameters (Page 2 of 7)



Parameter	Action/Explanation
<div style="border: 1px solid black; padding: 5px;"> RFID TAG CALIB RESTORE RUN </div>	<p>Calibrate RFID Tag</p> <p>This parameter sets the RFID programming position through a tag calibration, or it restores the programming position back to the printer default.</p> <p>RESTORE Selecting this option resets the RFID programming position to the printer default.</p> <p> Note • With some printers and firmware versions, no label movement or changes to the control panel occur. With others, the printer displays PROGRAM POSITION RESTORED.</p> <ul style="list-style-type: none"> • For the R110PAX4, the RFID programming position is zero (the printer programs the tag without moving the label). By default, the print engine has backfeed set to After, which places the transponder in the optimal place for encoding for Zebra-specified media. If you are using a backfeed setting other than After, do not use the RESTORE function unless the position of the transponder in your media accounts for this change. • For other RFID printers, the RFID programming position is the label length minus 1 mm (0.04 in.). <p>RUN If the media being used does not conform to transponder placement requirements for your printer, use the RUN option to have the printer determine the optimum programming position for the non-standard labels.</p> <p> Important • Do not perform transponder calibration for RFID media that meets the transponder placement specifications for your printer. RFID tag calibration is necessary only if the transponder is not in the ideal location for programming at the printer's default position.</p> <p>The printer feeds an RFID label one millimeter at a time while taking readings (via the READ TAG command and the WRITE TAG commands) to profile the RFID transponder. Based on the results, the printer determines the optimum programming position for the media and saves the position to nonvolatile memory (the value is saved even if the power is turned off). The calibrated value is used as the programming position for the ^RS command unless the command specifies a different value.</p> <p>Tag calibration takes into account the print mode, backfeed mode, and tear off position. The ^HR ZPL command performs the same calibration and returns a results table to the host (see ^HL or ~HL on page 84). An auto-calibration occurs after the tag calibration. This realigns the media to its proper rest position and updates the media tracking values in the printer.</p> <p>To restore the programming position to the default:</p> <ol style="list-style-type: none"> 1. Press the left oval/MINUS (-) to select RESTORE. <p>To calibrate an RFID tag:</p> <ol style="list-style-type: none"> 1. Load the printer with RFID media. 2. Close the printhead. 3. Press the right oval/PLUS (+) to select RUN.

Table 2 • RFID Parameters (Page 3 of 7)

Parameter	Action/Explanation																																																												
RFID VALID CTR 956 RESET	<p>View Valid RFID Label Counter</p> <p>This parameter displays the total number of valid RFID labels that have been printed/encoded. You can use this parameter or odometer.rfid.valid_resetable on page 132 to reset the counter to zero.</p> <p>To reset the counter to zero:</p> <ol style="list-style-type: none"> 1. Press the right oval/PLUS (+) to select RESET. 																																																												
RFID VOID CTR 23 RESET	<p>View Void RFID Label Counter</p> <p>This parameter displays the total number of RFID labels that have been voided. You can use this parameter or odometer.rfid.void_resetable on page 133 to reset the counter to zero.</p> <p>To reset the counter to zero:</p> <ol style="list-style-type: none"> 1. Press the right oval/PLUS (+) to select RESET. 																																																												
RFID READ PWR 16	<p>View or Change RFID Read Power</p> <p>This parameter displays the current value for RFID read power.</p> <p> Note •</p> <ul style="list-style-type: none"> • This parameter does not appear on the R110Xi HF printer. • On some printers, the options vary based on the reader. Check the printer configuration label for the RFID_HW_VER line or perform the RFID SLOW test (see Perform RFID Test on page 22) to determine the reader type. <table border="1" style="width: 100%; border-collapse: collapse;"> <thead> <tr> <th rowspan="2">Printer</th> <th rowspan="2">Firmware Version</th> <th colspan="2">Selections</th> <th rowspan="2">Default</th> </tr> <tr> <th>H, M, L</th> <th>0-30</th> </tr> </thead> <tbody> <tr> <td rowspan="4">RXi</td> <td>R60.15.8Z and earlier</td> <td>X</td> <td>—</td> <td>L</td> </tr> <tr> <td>R60.16.4Z</td> <td>X</td> <td>X</td> <td>L</td> </tr> <tr> <td>R60.16.5Z and later (M4xxx...x reader)</td> <td>X</td> <td>X</td> <td>L</td> </tr> <tr> <td>R60.16.5Z and later (M5xxx...x reader)</td> <td>—</td> <td>X</td> <td>16</td> </tr> <tr> <td rowspan="2">R4Mplus</td> <td>SP994P, SP999F, SP1027F, SP1056E, SP1082F, and earlier</td> <td>X</td> <td>—</td> <td>L</td> </tr> <tr> <td>SP994Q, SP999G, SP1027G, SP1056F, SP1082G, and later</td> <td>X</td> <td>X</td> <td>L</td> </tr> <tr> <td rowspan="4">R110PAX4</td> <td>R62.15.8Z and earlier</td> <td>X</td> <td>—</td> <td>L</td> </tr> <tr> <td>R62.16.4Z and later</td> <td>X</td> <td>X</td> <td>L</td> </tr> <tr> <td>R63.15.8Z and earlier</td> <td>X</td> <td>—</td> <td>L</td> </tr> <tr> <td>R63.16.4Z and later</td> <td>X</td> <td>X</td> <td>L</td> </tr> <tr> <td>RZx00</td> <td>all versions</td> <td>—</td> <td>X</td> <td>16</td> </tr> <tr> <td>RP4T</td> <td>all versions</td> <td>—</td> <td>X</td> <td>16</td> </tr> </tbody> </table> <p>To change the value shown:</p> <ol style="list-style-type: none"> 1. Press the left oval/MINUS (-) or the right oval/PLUS (+) to scroll through the options. 	Printer	Firmware Version	Selections		Default	H, M, L	0-30	RXi	R60.15.8Z and earlier	X	—	L	R60.16.4Z	X	X	L	R60.16.5Z and later (M4xxx...x reader)	X	X	L	R60.16.5Z and later (M5xxx...x reader)	—	X	16	R4Mplus	SP994P, SP999F, SP1027F, SP1056E, SP1082F, and earlier	X	—	L	SP994Q, SP999G, SP1027G, SP1056F, SP1082G, and later	X	X	L	R110PAX4	R62.15.8Z and earlier	X	—	L	R62.16.4Z and later	X	X	L	R63.15.8Z and earlier	X	—	L	R63.16.4Z and later	X	X	L	RZx00	all versions	—	X	16	RP4T	all versions	—	X	16
Printer	Firmware Version			Selections			Default																																																						
		H, M, L	0-30																																																										
RXi	R60.15.8Z and earlier	X	—	L																																																									
	R60.16.4Z	X	X	L																																																									
	R60.16.5Z and later (M4xxx...x reader)	X	X	L																																																									
	R60.16.5Z and later (M5xxx...x reader)	—	X	16																																																									
R4Mplus	SP994P, SP999F, SP1027F, SP1056E, SP1082F, and earlier	X	—	L																																																									
	SP994Q, SP999G, SP1027G, SP1056F, SP1082G, and later	X	X	L																																																									
R110PAX4	R62.15.8Z and earlier	X	—	L																																																									
	R62.16.4Z and later	X	X	L																																																									
	R63.15.8Z and earlier	X	—	L																																																									
	R63.16.4Z and later	X	X	L																																																									
RZx00	all versions	—	X	16																																																									
RP4T	all versions	—	X	16																																																									

Table 2 • RFID Parameters (Page 4 of 7)



Parameter	Action/Explanation																																																												
RFID WRITE PWR 16	<p>View or Change RFID Write Power</p> <p>This parameter displays the current value for RFID write power.</p> <p> Note •</p> <ul style="list-style-type: none"> · This parameter does not appear on the R110Xi HF printer. · On some printers, the options vary based on the reader. Check the printer configuration label for the RFID_HW_VER line or perform the RFID SLOW test (see Perform RFID Test on page 22) to determine the reader type. <table border="1"> <thead> <tr> <th rowspan="2">Printer</th> <th rowspan="2">Firmware Version</th> <th colspan="2">Selections</th> <th rowspan="2">Default</th> </tr> <tr> <th>H, M, L</th> <th>0–30</th> </tr> </thead> <tbody> <tr> <td rowspan="4">RXi</td> <td>R60.15.8Z and earlier</td> <td>X</td> <td>—</td> <td>L</td> </tr> <tr> <td>R60.16.4Z</td> <td>X</td> <td>X</td> <td>L</td> </tr> <tr> <td>R60.16.5Z and later (M4xxx...x reader)</td> <td>X</td> <td>X</td> <td>L</td> </tr> <tr> <td>R60.16.5Z and later (M5xxx...x reader)</td> <td>—</td> <td>X</td> <td>16</td> </tr> <tr> <td rowspan="2">R4Mplus</td> <td>SP994P, SP999F, SP1027F, SP1056E, SP1082F, and earlier</td> <td>X</td> <td>—</td> <td>L</td> </tr> <tr> <td>SP994Q, SP999G, SP1027G, SP1056F, SP1082G, and later</td> <td>X</td> <td>X</td> <td>L</td> </tr> <tr> <td rowspan="4">R110PAX4</td> <td>R62.15.8Z and earlier</td> <td>X</td> <td>—</td> <td>L</td> </tr> <tr> <td>R62.16.4Z and later</td> <td>X</td> <td>X</td> <td>L</td> </tr> <tr> <td>R63.15.8Z and earlier</td> <td>X</td> <td>—</td> <td>L</td> </tr> <tr> <td>R63.16.4Z and later</td> <td>X</td> <td>X</td> <td>L</td> </tr> <tr> <td>RZx00</td> <td>all versions</td> <td>—</td> <td>X</td> <td>16</td> </tr> <tr> <td>RP4T</td> <td>all versions</td> <td>—</td> <td>X</td> <td>16</td> </tr> </tbody> </table> <p>To change the value shown:</p> <ol style="list-style-type: none"> 1. Press the left oval/MINUS (-) or the right oval/PLUS (+) to scroll through the options. 	Printer	Firmware Version	Selections		Default	H, M, L	0–30	RXi	R60.15.8Z and earlier	X	—	L	R60.16.4Z	X	X	L	R60.16.5Z and later (M4xxx...x reader)	X	X	L	R60.16.5Z and later (M5xxx...x reader)	—	X	16	R4Mplus	SP994P, SP999F, SP1027F, SP1056E, SP1082F, and earlier	X	—	L	SP994Q, SP999G, SP1027G, SP1056F, SP1082G, and later	X	X	L	R110PAX4	R62.15.8Z and earlier	X	—	L	R62.16.4Z and later	X	X	L	R63.15.8Z and earlier	X	—	L	R63.16.4Z and later	X	X	L	RZx00	all versions	—	X	16	RP4T	all versions	—	X	16
Printer	Firmware Version			Selections			Default																																																						
		H, M, L	0–30																																																										
RXi	R60.15.8Z and earlier	X	—	L																																																									
	R60.16.4Z	X	X	L																																																									
	R60.16.5Z and later (M4xxx...x reader)	X	X	L																																																									
	R60.16.5Z and later (M5xxx...x reader)	—	X	16																																																									
R4Mplus	SP994P, SP999F, SP1027F, SP1056E, SP1082F, and earlier	X	—	L																																																									
	SP994Q, SP999G, SP1027G, SP1056F, SP1082G, and later	X	X	L																																																									
R110PAX4	R62.15.8Z and earlier	X	—	L																																																									
	R62.16.4Z and later	X	X	L																																																									
	R63.15.8Z and earlier	X	—	L																																																									
	R63.16.4Z and later	X	X	L																																																									
RZx00	all versions	—	X	16																																																									
RP4T	all versions	—	X	16																																																									
RFID POWER LOW	<p>View or Change RFID Read/Write Power</p> <p> Note • This parameter appears only for the R110Xi HF printer, which uses identical RF power settings for read and write operations.</p> <p>This parameter displays the current value for RFID power.</p> <p>Default: LOW</p> <p>Selections: HIGH, MEDIUM, LOW</p> <p>To change the value shown:</p> <ol style="list-style-type: none"> 1. Press the left oval/MINUS (-) or the right oval/PLUS (+) to scroll through the options. 																																																												

Table 2 • RFID Parameters (Page 5 of 7)

Parameter	Action/Explanation
<div style="border: 1px solid black; padding: 2px;"> RFID ANTENNA ANTENNA PORT 1 </div>	<p>Select the RFID Antenna Port</p> <p> Note • This parameter appears only for the R110Xi HF printer.</p> <p>This parameter displays the current antenna port.</p> <p>Default: ANTENNA PORT 1</p> <p>Selections: ANTENNA PORT 1, ANTENNA PORT 2</p> <p>To change the value shown:</p> <ol style="list-style-type: none"> 1. Press the left oval/MINUS (-) or the right oval/PLUS (+) to scroll through the options.
<div style="border: 1px solid black; padding: 2px;"> RFID ERR STATUS </div>	<p>RFID Error Status</p> <p>During an error condition, an error message shows on the second line of the display. See Table 6 on page 53 in the RFID Troubleshooting section for descriptions of the error messages. This field cannot be modified.</p>

Table 2 • RFID Parameters (Page 6 of 7)

Parameter	Action/Explanation
<div style="border: 2px solid black; padding: 2px;"> RFID TAG TYPE CLASS 1 96-BIT </div>	<p>Specify RFID Tag Type</p> <p>Select the RFID tag type that you are using. See Table 9, Supported Tag Types and Default Values on page 111 for tag types that your printer supports. If a tag type is supported but does not appear on your printer's control panel, you may need to upgrade the printer's firmware (see http://www.zebra.com/firmware).</p> <p>UHF Tag Type Selections</p> <ul style="list-style-type: none"> • NONE • CLASS 0 (EPC Class 0) • CLASS 0+ (EPC Class 0 Plus) • CLASS 1 64-BIT (EPC Class 1 64-bit) • CLASS 1 96-BIT (EPC Class 1 96-bit) • UCODE EPC 1.19 • CLASS 0+ IMPINJ (Impinj Class 0 Plus) • ISO18000A (ISO 18000-06A) • GEN2 (EPC Class 1, Gen 2) • ISO18000B (ISO 18000-06B) <p>HF Tag Type Selections</p> <ul style="list-style-type: none"> • NONE • AUTO DETECT (query tag to determine) • TAG-IT (Texas Instruments Tagit tags) • ICODE (Phillips Icode tags) • PICO (Pico Tag Inside Technology's) • ISO15693 • EPC (13.56 MHz) • UID • MIFARE ULTRALT (Mifare UltraLight) <p>To change the value shown:</p> <ol style="list-style-type: none"> 1. Press the left oval/MINUS (-) or the right oval/PLUS (+) to scroll through the options.

Table 2 • RFID Parameters (Page 7 of 7)

Parameter	Action/Explanation
RFID TAG DATA	<p>Read and Display RFID Tag Data</p> <p>When this option is selected, the reader attempts to read a tag over the RFID antenna, even if the printhead is open. Results are displayed in hexadecimal format. The printer rereads the tag every 2 seconds, so if the tag changes, data is displayed for the current tag over the antenna. No printer movement occurs while tag data is read.</p> <ul style="list-style-type: none"> • If no tag data can be read, the text NO DATA appears on the bottom line of the LCD display. • If a tag is present, the data for that tag appears on the bottom line of the display in hexadecimal format. If there is more data than can fit on the bottom line (such as for 96-bit tags), the bottom line will cycle from the first 8 bytes (most significant) to the next 4 bytes (least significant) approximately every 2 seconds. The hexadecimal data that can fit on two screens is displayed and cycled through. <p>For example, if the tag contains the data 0x112233445566778899001122, when this option is selected, the bottom line of the display shows: 1122334455667788 for 2 seconds followed by 99001122 for 2 seconds. The printer cycles through these indefinitely.</p> <p>To read RFID tag data:</p> <ol style="list-style-type: none"> 1. Position an RFID label with its transponder over an RFID antenna location. For the location of the RFID antenna on your printer, see RFID Antenna Location on page 39.



Creating Basic RFID Label Formats

After you have selected a transponder type and set your printer appropriately, use the ZPL samples in this section as a base for programming your own RFID label formats.

For specific information about individual ZPL commands, see [ZPL II Commands for RFID on page 79](#).

Contents

Create and Send an RFID Label Format	30
Sample RFID Label Formats	31
RFID Label Format 1—Encode a Gen 2 Tag in Hexadecimal	31
RFID Label Format 2—Encode a Gen 2 Tag in ASCII	32
RFID Label Format 3—Read Data from Tag and Print Data on Label	33
RFID Label Format 4—Encode Tag, Read Tag, and Print Data on Label	34
RFID Label Format 5—Encode a Class 1 64-bit Tag in Hexadecimal	36
RFID Label Format 6—Encode Tag, Read Tag, and Return Results to Host	37

Create and Send an RFID Label Format

The following pages contain sample RFID label formats that you can modify to create your own RFID label formats.

To create an RFID label based on a sample label, complete these steps:

1. Using any word processor or text editor that is capable of creating ASCII-only files (for example, use Microsoft® Word and save as a .txt file), type in the label format exactly as shown in the desired sample.
2. Save the file to your computer.
When naming the file, use .zpl as the extension for the file (for example, you may choose to name a file format1.zpl).
3. Set up the printer, and turn the power On (I).
4. Copy the file to the printer.
If you are connected to the printer via the parallel port, from the DOS command window, use the “COPY” command to send a file to the printer. For example, if your file name is **format1.zpl**, type:

```
COPY FORMAT1.ZPL XXXX
```

where XXXX is the port to which your printer is connected (such as LPT1).
5. Compare your label results with those shown in the sample. If your printout does not look like the one shown, confirm that the file you created is identical to the format shown, then repeat the printing procedure.
6. Check the RFID data on your label.
 - a. Open the printhead, and place the label above the antenna in the printer.
 - b. Use the control panel to view the transponder data (see [Read and Display RFID Tag Data on page 28](#)).
 - c. Compare your RFID data with that shown in the sample. If your control panel display does not look like what is shown, confirm that the file you created is identical to the format shown, then repeat the printing procedure.
7. When you are certain that the file you created is correct, substitute your data in the label format where necessary.

Sample RFID Label Formats

Use the formats in this section to assist you in creating your own RFID label formats.

RFID Label Format 1—Encode a Gen 2 Tag in Hexadecimal

Line Number	Type This ZPL Code	Function of ZPL Code
1	^XA	Indicates start of label format.
2	^RS8	Sets tag type to Gen 2
3	^FO50,50 ^A0N,65 ^FDSimple write example ^FS	Prints “Simple write example” on the label at location 50,50.
4	^RFW,H ^FD112233445566778899001122 ^FS	W,H = write hex Encodes the 12 bytes of data (96 bits) to the tag. The data written is: 112233445566778899001122
5	^XZ	Indicates end of label format.

Resulting Label

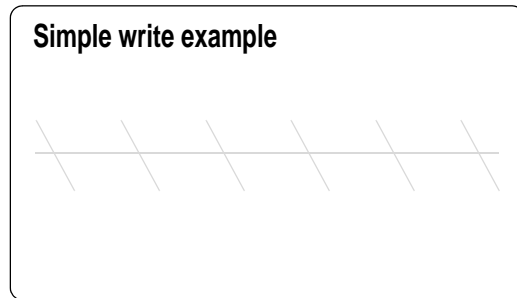

Programmed to Transponder

112233445566778899001122

Control Panel Display (toggles between these two)



RFID Label Format 2—Encode a Gen 2 Tag in ASCII

This label format is different in what shows on the control panel. The control panel always displays RFID data in hexadecimal.

Line Number	Type This ZPL Code	Function of ZPL Code
1	^XA	Indicates start of label format.
2	^RS8	Sets tag type to Gen 2
3	^FO50,50 ^A0N,65 ^FDSimple write example ^FS	Prints “Simple write example” on the label at location 50,50.
4	^RFW,A ^FD00 rfid data ^FS	W,A = write ASCII Encodes the 12 bytes of data (96 bits) to the tag. The data written is: 00 rfid data
5	^XZ	Indicates end of label format.

Resulting Label

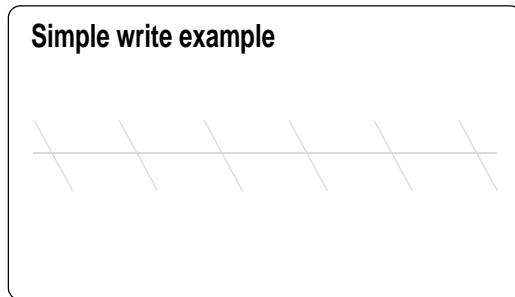

Programmed to Transponder

00 rfid data

Control Panel Display (toggles between these two)

```
RFID TAG DATA
3030207266696420
```

```
RFID TAG DATA
64617461
```

RFID Label Format 3—Read Data from Tag and Print Data on Label

This example assumes that the tag created using *RFID Label Format 1—Encode a Gen 2 Tag in Hexadecimal* on page 31 is being read.

Line Number	Type This ZPL Code	Function of ZPL Code
1	^XA	Indicates start of label format.
2	^RS8	Sets tag type to Gen 2
3	^FO50,50 ^AON,40 ^FN0 ^FS	^FN0 is a placeholder field variable for the tag data that will be read in the following line. When the label prints, the data read from the tag will be printed at location 50,50.
4	^FN0 ^RFR,H ^FS	R,H = read hexadecimal The read results are put into field variable 0 (^FN0). At this point, the printer substitutes previous instances of ^FN0 in the label format with the data from this field. The data read from the tag will be padded with zeroes to the maximum bit size.
5	^XZ	Indicates end of label format.

Read from Transponder

112233445566778899001122

Resulting Label

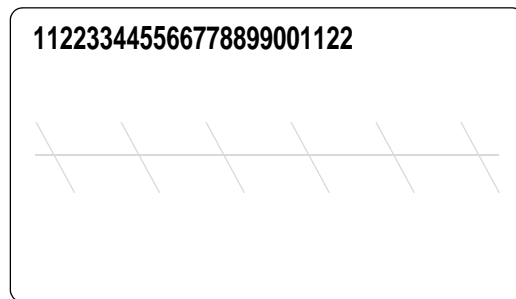

Control Panel Display (toggles between these two)



RFID Label Format 4—Encode Tag, Read Tag, and Print Data on Label

Line Number	Type This ZPL Code	Function of ZPL Code
1	^XA	Indicates start of label format.
2	^RS8	Sets tag type to Gen 2
3	^FO60,60 ^A0N,40 ^FN7 ^FS	When the label prints, the data read from the tag at field variable 7 (^FN7) will be printed at location 60,60.
4	^RFW,A ^FD0data ^FS	W,A = write ASCII Encodes "0data" into the block padded with 8 bytes of zeroes to make the data 12 bytes. The data written is: 306461746100000000000000 ("0data" in ASCII)
5	^FN7 ^RFR,A ^FS	R,A = read ASCII Reads the tag data into field variable 7 (^FN7). After this occurs, any fields in this label format that have ^FN7 will be replaced with this read data.
6	^XZ	Indicates end of label format.

Programmed to Transponder

306461746100000000000000

Read from Transponder

306461746100000000000000

Resulting Label



Control Panel Display (toggles between these two)

```
RFID TAG DATA  
3064617461000000
```

```
RFID TAG DATA  
00000000
```

RFID Label Format 5—Encode a Class 1 64-bit Tag in Hexadecimal

Line Number	Type This ZPL Code	Function of ZPL Code
1	^XA	Indicates start of label format.
2	^RS3	Sets tag type to EPC Class 1 64-bit.
3	^FO50,50 ^A0N,65 ^FDSimple write example ^FS	Prints “Simple write example” on the label at location 50,50.
4	^RFW,H ^FD1122334455667788 ^FS	W,H = write hex Encodes the 8 bytes of data (64 bits) to the tag. The data written is: 1122334455667788
5	^XZ	Indicates end of label format.

Resulting Label

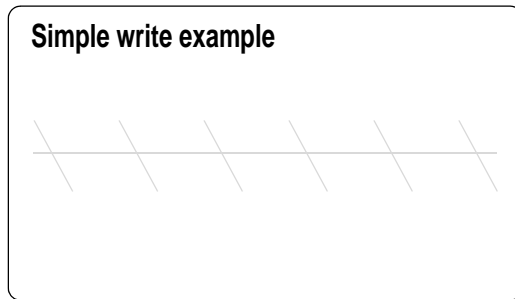

Programmed to Transponder

1122334455667788

Control Panel Display



RFID Label Format 6—Encode Tag, Read Tag, and Return Results to Host

Line Number	Type This ZPL Code	Function of ZPL Code
1	^XA	Indicates start of label format.
2	^RS8	Sets tag type to Gen 2
3	^FO50,50 ^A0N,65 ^FN3 ^FS	When the label prints, the data read from the tag at field variable 3 (^FN3) will be printed at location 50,50.
4	^RFW,H ^FD0102030405 ^FS	W,H = write hex Encodes 12 bytes of data (96 bits) to the tag with 7 bytes of zeroes as padding. The data written is: 010203040500000000000000
5	^FN3 ^RFR,H ^FS	R,H = read hexadecimal Reads the tag data into field variable 3 (^FN3). After this occurs, any fields in this label format that have ^FN3 will be replaced with this read data.
6	^HV3	Returns the value in ^FN3 to the host computer. Data is sent over whichever communication channel is established with the host (such as parallel, serial, USB, Ethernet). In this example, 010203040500000000000000 would be returned to the host.
7	^XZ	Indicates end of label format.

Programmed to Transponder

010203040500000000000000

Read from Transponder

010203040500000000000000

Resulting Label

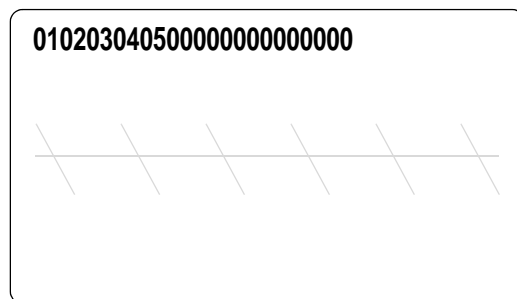

Control Panel Display (toggles between these two)

```
RFID TAG DATA  
0102030405000000
```

```
RFID TAG DATA  
00000000
```

Sent to Host Computer

```
010203040500000000000000
```



RFID Antenna Location

Operations to test the RFID functions and display RFID tag data require you to place an RFID label over the RFID antenna area. This section shows the location of the RFID antenna in the various Zebra RFID printers.

Contents

RXi and RXi HF	40
RZ400 and RZ600	40
R110PAX4	41
RP4T	41
R4Mplus	42

RXi and RXi HF

Figure 2 • RXi and RXi HF Antenna Location

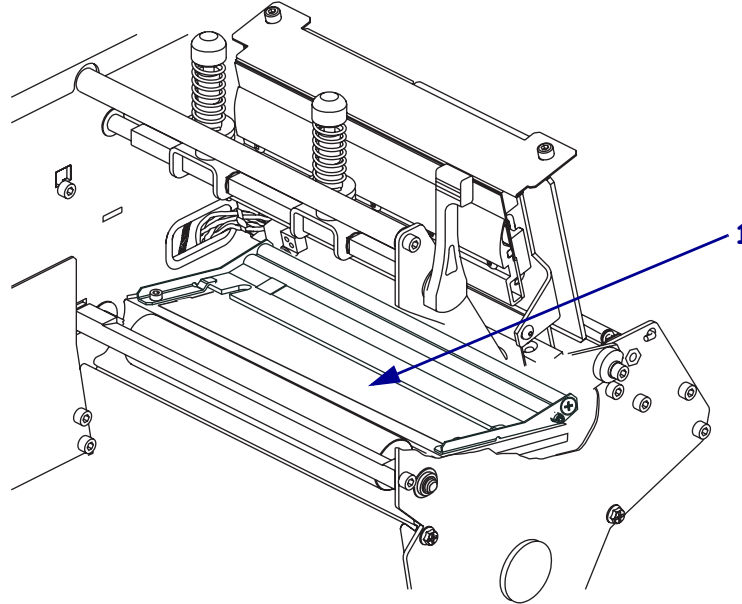

RZ400 and RZ600

Figure 3 • RZ400 and RZ600 Antenna Location

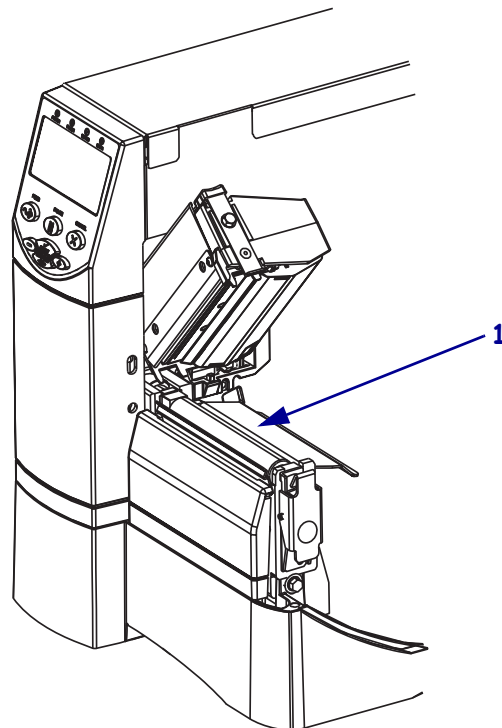

R110PAX4

Figure 4 • R110PAX4 Antenna Location

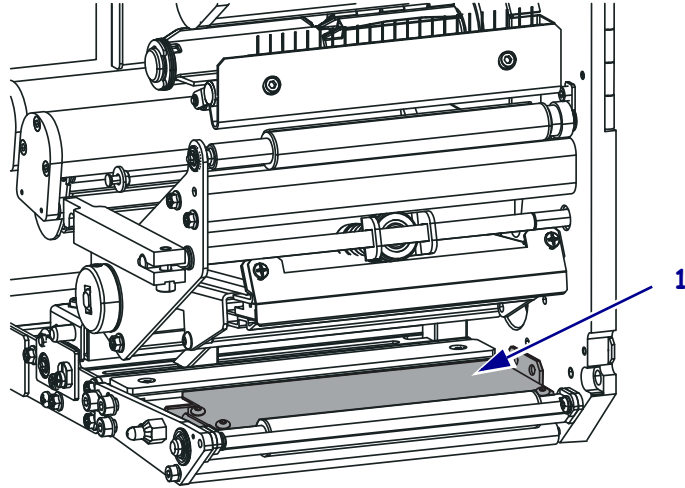

RP4T

Figure 5 • RP4T Antenna Location

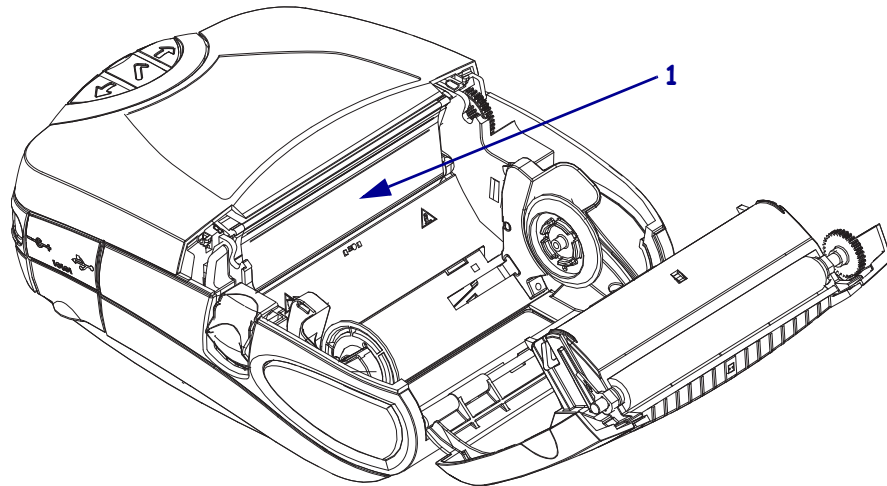

R4Mplus

Figure 6 • R4Mplus Antenna Location

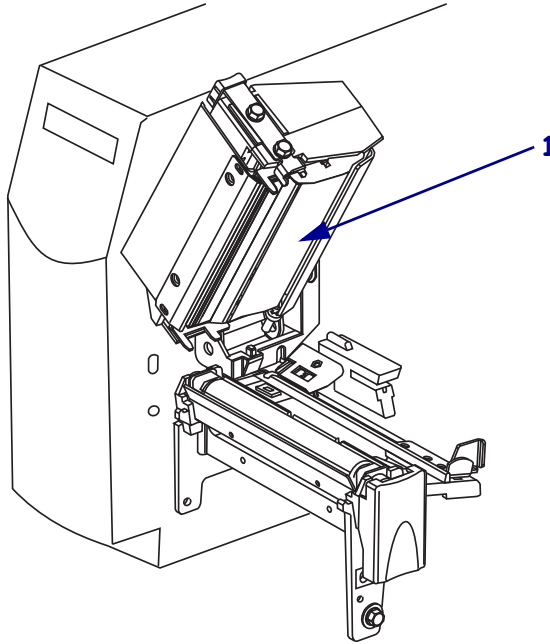



Transponder Characteristics

This section describes the different characteristics of some common transponder types.

Contents

Basic Transponder Characteristics	44
Electronic Product Code (EPC)	45
EPC Fields	45
EPC Structure in RFID Labels	45
EPC Class 1, Generation 2 (Gen 2)	46
Data Content	46
Data and Tag Security	46
Gen 2 Memory Map	46

Basic Transponder Characteristics

Table 3 shows some of the basic characteristics of common transponder types.

Table 3 • Characteristics of Transponder Types

Transponder Type	Read	Write	Size (in bits)
Class 0	Yes	No	96 bits
Class 0+	Yes	Yes	96 bit (TID) 104 bit (USER)
Class 1 64 bits	Yes	Yes	64 bits
Class 1 96 bits	Yes	Yes	96 bits
ISO18000-6A	Yes	Yes	Varies
ISO18000-6B	Yes	Yes	Varies
Gen 2	Yes	Yes	Varies by manufacturer and tag. See Gen 2 Memory Map on page 46 for additional memory information.

Depending on which printer you have and which firmware you are using, you may or may not be able to use the tag types shown in this section. Go to [Table 9, Supported Tag Types and Default Values, on page 111](#) for more information about which tag types work with which printers.

Electronic Product Code (EPC)

EPC is a product numbering standard that can be used to identify a variety of items by using RFID technology. The 96-bit EPC code links to an online database, providing a secure way of sharing product-specific information along the supply chain.



Note • The information in this section is provided for your convenience only and is subject to change. Go to <http://www.epcglobalinc.org> for the latest EPC information.

EPC Fields

As with bar codes, EPC is divided into numbers that identify the manufacturer and product type. However, EPC contains the following additional information:

- **Header**—identifies the length, type, structure, version, and generation of EPC
- **Manager Number**—identifies the company or company entity
- **Object Class**—similar to a stock keeping unit (SKU)
- **Serial Number**—the specific instance of the Object Class being tagged

Additional fields may be used as part of the EPC code to encode and decode information from different numbering systems into human-readable form. For more information about EPC specifications, refer to the EPC Global web site.

EPC Structure in RFID Labels

In the printer, you can subdivide transponder data into unique fields. You can customize these fields to create “smart” labels that meet your needs or that meet the standards necessary in EPC programming.

The `^RB` ZPL command is used to define EPC structure. EPC field data can be delimited with any of the following characters:

`, ~ ! @ # $ % ^ & * | . < > / \ : ;`

See [^RB on page 93](#) for more information about and examples for defining EPC structure.

EPC Class 1, Generation 2 (Gen 2)

EPC Gen 2 tags offer advantages over other tag types. The tag identification (TID) memory in a Gen 2 tag includes the chip manufacturer and model number information, which can be used to identify which optional features are present on the tag. These optional features include those for data content and security.

See [Table 9, Supported Tag Types and Default Values, on page 111](#) for the UHF printers and firmware versions that can use Gen 2 tags.

Data Content

Gen 2 tags typically have a 96-bit EPC identifier, which is different from the 64-bit identifiers common in early EPC tags. Gen 2 tags also support much larger data structures. The size of user memory available (if any) varies by the model and manufacturer of the tag.

Data and Tag Security

Tag Passwords You can set optional 32-bit passwords that allow you to access tag data, to lock tag data, or to permanently disable (kill) a tag. Use the ZPL command [^RZ on page 120](#) to set the passwords (if desired) and [^RF on page 96](#) to read the passwords.

Data Locking Options User-allocated memory can be safeguarded with flexible locking options using [^RZ on page 120](#). For example, you can lock a tag's blank memory to prevent it from being encoded accidentally and later unlock it for writing. A permanent locking feature prevents rewriting of tag data.

Gen 2 Memory Map

[Table 4](#) shows how information is stored on a Gen 2 tag.

Table 4 • Gen 2 Tag Logical Memory Map

Bank	Memory Bank	Memory Contents
3	User	:
2	TID	:
		TID (15:0)
		TID (31:16)
1	EPC	EPC (15:0)
		:
		EPC (N:N-15)
		PC (15:0)
		CRC-16 (15:0)

Table 4 • Gen 2 Tag Logical Memory Map (Continued)

Bank	Memory Bank	Memory Contents
0	Reserved	:
		access password (15:0)
		access password (31:16)
		kill password (15:0)
		kill password (31:16)



Notes • _____



Troubleshooting

This section provides information about RFID operational errors that you might need to troubleshoot. For other types of problems, consult the user guide for your printer.

Contents

RFID Problems	50
RFID Error Codes and Messages	53
Error and Status Messages	53
Error Codes	66

RFID Problems

Table 5 identifies problems that may occur with RFID printers, the possible causes, and the recommended solutions.

Table 5 • RFID Problems

Problem	Possible Cause	Recommended Solution
The RFID-enabled printer voids every label.	The printer is not calibrated for the RFID label being used.	Refer to the User Guide for your printer for instructions.
	The printer is set for the wrong tag type.	Set the correct tag type using <i>Specify RFID Tag Type on page 27</i> . If the tag type is not listed, you may not be able to use the labels with your printer.
	The printer is unable to communicate with the RFID reader.	<ol style="list-style-type: none"> 1. Turn off (O) the printer. 2. Wait 10 seconds. 3. Turn on (I) the printer. 4. If the problem persists, you may have a bad RFID reader or a loose connection between the RFID reader and the printer. Contact Technical Support or an authorized Zebra RFID service technician for assistance.
	The settings are incorrect in your label designer software.	The software settings override the printer settings. Make sure that the software and printer settings match.
	You are using an incorrect programming position, particularly if the tags being used are within printer specifications.	Do one or more of the following as necessary: <ul style="list-style-type: none"> • Check the programming position being used with the ^RS command, or the program position setting in your label designer software. If the position is incorrect, change the setting. • Select RESTORE for the RFID TAG CALIB parameter (see <i>Calibrate RFID Tag on page 23</i>).
	You are sending RFID ZPL commands that are incorrect.	See <i>ZPL II Commands for RFID on page 79</i> .
	Radio frequency (RF) interference from another RF source.	Do one or more of the following as necessary: <ul style="list-style-type: none"> • Move the printer away from fixed RFID readers or other RF sources. • Make sure that the media door is closed at all times during RFID programming.

Table 5 • RFID Problems (Continued)

Problem	Possible Cause	Recommended Solution
Low yields. Too many RFID tags per roll are voided.	The RFID labels are not within specifications for the printer, which means that the transponder is not in an area that can be programmed consistently.	Make sure that the labels meet transponder placement specifications for your printer. See http://www.zebra.com/id/zebra/na/en/index/products/supplies/rfid_supplies/rfid_transponder_inlay.html for transponder placement information. Contact an authorized Zebra RFID reseller for more information.
	Some RFID tags are more sensitive than others and may require special printer settings.	1. Verify that the printer is set for the correct write power. See http://www.zebra.com/id/zebra/na/en/index/products/supplies/rfid_supplies/rfid_transponder_inlay.html for the recommended power setting for each tag type. 2. If necessary, run the ^HR command to manually calibrate the transponder position. 3. If the problem persists, consider using a different tag type. Contact an authorized Zebra RFID reseller for more information.
	Incorrect read and write power levels for the RFID tag type.	Change the RFID read and write power levels (see View or Change RFID Read Power on page 24 or View or Change RFID Write Power on page 25).
	Radio frequency (RF) interference from another RF source.	Do one or more of the following as necessary: <ul style="list-style-type: none"> • Move the printer away from fixed RFID readers. • Make sure that the media door is closed at all times during RFID programming.
	The printer is using outdated printer firmware and reader firmware versions.	Go to http://www.zebra.com/firmware for updated firmware.
With a Gen 2 tag, no data is written to the tag even though the printer says that the write operation succeeded.	The RFID reader/encoder is not enabled for Gen 2.	Check Table 9, Supported Tag Types and Default Values, on page 111 to see if your printer supports Gen 2 tags. <ul style="list-style-type: none"> • If your printer supports Gen 2 tags, make sure that you are using the appropriate firmware version. Download printer and reader firmware, if necessary. • If your printer does not support Gen 2 tags, you will not be able to use these tags with your printer.

Table 5 • RFID Problems (Continued)

Problem	Possible Cause	Recommended Solution
The printer stops at the RFID inlay.	The printer calibrated the label length only to the RFID inlay instead of to the interlabel gap.	<ol style="list-style-type: none"> 1. 2. Refer to the User Guide for your printer for instructions.
The DATA light flashes indefinitely after you attempt to download printer or reader firmware.	The download was not successful. For best results, cycle power on the printer before downloading any firmware.	<ol style="list-style-type: none"> 1. Turn off (O) the printer. 2. Wait 10 seconds. 3. Turn on (I) the printer. 4. Attempt to download the firmware again. 5. If the problem persists, contact Technical Support.
RFID parameters do not appear in Setup mode, and RFID information does not appear on the printer configuration label.	The printer was powered off (O) and then back on (I) too quickly for the RFID reader to initialize properly.	<p>Wait at least 10 seconds after turning the printer power off before turning it back on.</p> <ol style="list-style-type: none"> 1. Turn off (O) the printer. 2. Wait 10 seconds. 3. Turn on (I) the printer. 4. Check for the RFID parameters in Setup mode or for RFID information on a new configuration label.
	An incorrect version of printer or reader firmware was loaded on the printer.	<ol style="list-style-type: none"> 1. Compare the firmware version on your printer to those listed in Table 1, RFID Printer Firmware Versions, on page 19. 2. Download the correct printer or reader firmware if necessary. 3. If the problem persists, contact Technical Support.
	The printer is unable to communicate with the RFID reader.	<ol style="list-style-type: none"> 1. Turn off (O) the printer. 2. Wait 10 seconds. 3. Turn on (I) the printer. 4. If the problem persists, you may have a bad RFID reader or a loose connection between the RFID reader and the printer. Contact Technical Support or an authorized service technician for assistance.

RFID Error Codes and Messages

In the event of an RFID error, the printer does the following:

- displays an RFID error or status message on the second line of the **RFID ERR STATUS** control panel parameter
- returns RFID error codes to the RFID data log (see *^HL or ~HL* on page 84 for more information about the RFID data log)

Table 6 provides the possible problems sorted by the error message, while Table 7 on page 66 provides these problems sorted by the error code.

Error and Status Messages

Table 6 shows the possible error and status messages, the corresponding error codes, and the action required (if any).

Table 6 • RFID Error and Status Message Definitions

Error Code	RFID Error or Status Message	Description/Action Required
8104	ACTIVATE TAG ERR	If the problem persists, contact Technical Support.
0405	AFE NOT ON	Internal problem with the reader. The Analog Front End is turned off. Contact Technical Support.
0033	ANT FAILURE	Antenna failure. Contact Technical Support.
0025	ANT. BAD/GONE	The RFID reader cannot detect the RFID antenna (coupler), or the antenna (coupler) does not work. Contact Technical Support.
900F	ANT. BAD/GONE	The RFID reader cannot detect the RFID antenna (coupler), or the antenna (coupler) does not work. Contact Technical Support.
F003	ANTENNA SEL ERR	The printer firmware could not verify that the selected RFID antenna (coupler) is properly connected. If selecting the antenna through ZPL, ensure that your printer supports this feature and that your parameters are correct. If the problem persists, contact Technical Support.
9401	AUTHEN RDR ERR	If the problem persists, contact Technical Support.
8201	AUTHEN TAG ERR	Tag not authenticated.
0026	BAD ANT.MUX	Internal problem with the reader. Contact Technical Support.
0201	BAD APP END ADD	The RFID reader received a command to erase some part of the flash memory. This typically would happen during a reader firmware upgrade. Make sure that you download the appropriate version of reader firmware. If the problem persists, contact Technical Support.
000A	BAD COMMAND	The reader received a bad command from the printer. If the problem persists, contact Technical Support.

Table 6 • RFID Error and Status Message Definitions (Continued)

Error Code	RFID Error or Status Message	Description/Action Required
0004	BAD CRC	The last valid message string had a bad Cyclic Redundancy Check (CRC). An integrity check of the reader firmware failed. If the problem persists, contact Technical Support.
0005	BAD DATA	The reader received bad data from the printer. If the problem persists, contact Technical Support.
0200	BAD IMAGE CRC	The RFID reader received a command to erase some part of the flash memory. This typically would happen during a reader firmware upgrade. Make sure that you download the appropriate version of reader firmware. If the problem persists, contact Technical Support.
0001	BAD MESSAGE	Internal communications problem with the reader. If the problem persists, contact Technical Support.
0008	BAD MSG HEAD	Internal communications problem with the reader. If the problem persists, contact Technical Support.
0009	BAD MSG TAIL	Internal communications problem with the reader. If the problem persists, contact Technical Support.
0052	BAD PASSCODE	Bad passcode for kill tag function.
000B	BAD SUBCMD	Internal communications problem with the reader. If the problem persists, contact Technical Support.
0053	BAUD ERR	Internal problem with the reader. If the problem persists, contact Technical Support.
8005	BLOCK(S) LOCKED	A write operation could not be performed because a block was locked.
9103	BOOTLOADER ERR	The reader failed to enter bootloader mode, which is necessary to upgrade firmware. If the problem persists, contact Technical Support.
8409	CLEAR FILE ERR	Internal problem with the reader. If the problem persists, contact Technical Support.
0054	CMD FAIL	Internal communications problem with the reader. If the problem persists, contact Technical Support.
0010	CMD INHIBITED	Internal communications problem with the reader. If the problem persists, contact Technical Support.
8003	COLLISION ERR	Multiple tags in the field have the same tag ID.
8303	CREATE APPLI ERR	Internal problem with the reader. If the problem persists, contact Technical Support.
8403	CREATE FILE ERR	Internal problem with the reader. If the problem persists, contact Technical Support.
8508	CREDIT VALUE ERR	If the problem persists, contact Technical Support.

Table 6 • RFID Error and Status Message Definitions (Continued)

Error Code	RFID Error or Status Message	Description/Action Required
0100	DATA AMOUNT ERR	Two situations can result in this error: <ul style="list-style-type: none"> • The data length in a message to the RFID reader from the printer is less than the number of arguments in the message. • The data length is greater than the number of arguments. The reader will wait indefinitely until it receives all of the data specified in the data length field. If the problem persists, contact Technical Support.
0037	DATA CRC	An integrity check of the reader firmware failed. If the problem persists, contact Technical Support.
040B	DATA TOO LARGE	Internal problem with the reader. If the problem persists, contact Technical Support.
8105	DEACTIV. TAG ERR	If the problem persists, contact Technical Support.
8509	DEBIT VALUE ERR	If the problem persists, contact Technical Support.
840B	DEC VAL FILE ERR	Internal problem with the reader. If the problem persists, contact Technical Support.
800D	DECRYPT TAG ERR	The data read from the tag was not decrypted properly or was corrupted.
8408	DELETE FILE ERR	Internal problem with the reader. If the problem persists, contact Technical Support.
8502	DISABLE EAS ERR	There was an error while clearing the EAS bit. Verify that the tag that you are using supports this feature.
9403	DISABLE_DEBG ERR	If the problem persists, contact Technical Support.
8501	ENABLE EAS ERR	There was an error while setting the EAS bit. Verify that the tag that you are using supports this feature.
9402	ENABLE_DEBUG ERR	If the problem persists, contact Technical Support.
800C	ENCRYPT TAG ERR	The data to be written to the tag was not encrypted properly.
810B	ERASE TAG ERR	If the problem persists, contact Technical Support.
8ACA	EXIT TAGLOOP ERR	Internal problem with the reader. If the problem persists, contact Technical Support.
8011	FILE NOT FOUND	The specified file was not found on the application.
0300 0301 0302 0303 0304 0305 0306	FLASH ERROR	An error occurred reading or writing from the reader's Flash memory. If the problem persists, contact Technical Support.
810C	FORMAT TAG ERR	If the problem persists, contact Technical Support.

Table 6 • RFID Error and Status Message Definitions (Continued)

Error Code	RFID Error or Status Message	Description/Action Required
0048	FPGA OLD	The FPGA code is out of date. This would typically happen during a reader firmware upgrade. Make sure you download the appropriate version of reader firmware. If the problem persists, contact Technical Support.
0423	GEN2 BAD PC	Internal problem with the reader. If the problem persists, contact Technical Support.
042F	GEN2 ERROR	Internal problem with the reader. If the problem persists, contact Technical Support.
042B	GEN2 LOW PWR	Internal problem with the reader. If the problem persists, contact Technical Support.
0424	GEN2 MEM LOCKED	Internal problem with the reader. If the problem persists, contact Technical Support.
0420	GEN2 PROT OTHER	Internal problem with the reader. If the problem persists, contact Technical Support.
0430	GEN2 UNKNWN ERR	Internal problem with the reader. If the problem persists, contact Technical Support.
8301	GET APPLI ID ERR	Internal problem with the reader. If the problem persists, contact Technical Support.
9302	GET DEFAULT ERR	There was a problem reading a parameter from the non-volatile memory of the reader. If the problem persists, contact Technical Support.
8401	GET FILE IDs ERR	Internal problem with the reader. If the problem persists, contact Technical Support.
8404	GET FILE SET ERR	Internal problem with the reader. If the problem persists, contact Technical Support.
8108	GET LOCK STA ERR	The reader was unable to acquire the lock status from the tag.
8107	GET TAG INFO ERR	The reader was unable to acquire the information from the tag. The reader may not contain information for the selected tag.
0046	HARDWARE ERR	If the problem persists, contact Technical Support.
0601	ID BUFFER FULL	The tag ID buffer is full. If the problem persists, contact Technical Support.
840A	INC VAL FILE ERR	Internal problem with the reader. If the problem persists, contact Technical Support.
800E	INVALID SIGNATURE	The HMAC written to the tag did not match the data and the key.
0409	INVALID ADDR	The RFID reader received a command to write to an invalid address in the tag data address space. Make sure that the address specified is within the scope of the tag data address space.
9005	INVALID ADDRESS	The address specified for the command was invalid. If the problem persists, contact Technical Support.

Table 6 • RFID Error and Status Message Definitions (Continued)

Error Code	RFID Error or Status Message	Description/Action Required
800F	INVALID AUTH KEY	The key number does not exist or is invalid for authentication with a specific reader or tag.
010A	INVALID BAUD	Internal problem with the reader. If the problem persists, contact Technical Support.
0109	INVALID CMD	The command does not exist or is invalid for the reader. Internal problem with the reader. If the problem persists, contact Technical Support.
9002	INVALID CMD	The command does not exist or is invalid for the reader. Internal problem with the reader. If the problem persists, contact Technical Support.
9003	INVALID CRC	Invalid CRC sent in the request to the reader. If the problem persists, contact Technical Support.
9009	INVALID DATA LEN	The length of the data specified in the request was invalid for the command specified. If the problem persists, contact Technical Support.
9006	INVALID FLAGS	The flags specified were invalid for the command specified. If the problem persists, contact Technical Support.
0104	INVALID FREQ	The RFID reader received a command to set the frequency outside of the supported range. If the problem persists, contact Technical Support.
0500	INVALID FREQ	The RFID reader received a command to set the frequency outside of the supported range. If the problem persists, contact Technical Support.
8014	INVALID KEY LEN	The key length is not valid for the tag type, the command, or the reader.
8013	INVALID KEY NO.	The key number does not exist or is out of the range of valid keys.
9004	INVALID MESS LEN	The number of bytes sent to the reader was invalid for the command or for the message length passed in. If the problem persists, contact Technical Support.
0101	INVALID OPCODE	The opCode received by the RFID reader is invalid or not supported with the current version of reader firmware. Make sure you download the appropriate version of reader firmware. If the problem persists, contact Technical Support.
000C 000D	INVALID PARAM	The RFID reader received a valid command with an unsupported or invalid value for one of the parameters. If the problem persists, contact Technical Support.
0105	INVALID PARAM	The RFID reader received a valid command with an unsupported or invalid value for one of the parameters. If the problem persists, contact Technical Support.

Table 6 • RFID Error and Status Message Definitions (Continued)

Error Code	RFID Error or Status Message	Description/Action Required
0402	INVALID PROTOC	The RFID reader received a command for a protocol value that is not supported with the current version of reader firmware. Make sure you have the right tag type selected and that you are using a tag that is supported by your printer.
8001	INVALID TAG TYPE	The tag type was not valid for the command specified. Make sure that you are using the right tag type for your operation. If the problem persists, contact Technical Support.
0045	INVALID VAR.	Invalid configuration variable. Internal problem with the reader. If the problem persists, contact Technical Support.
0408	INVALID WR DATA	In EPC 0+, the first two bits determine the tag ID length. If the first two bits are 0b00, then the tag ID must be 96 bits. Otherwise, the tag ID is 64 bits. Make sure that the first two bits have the correct values, depending on the tag ID length.
810F	INVENTORY DONE	Status message indicating that the reader exited the Inventory mode. No action required.
9007	INVLD ASCII BYTE	A non-ASCII byte value was sent in an ASCII mode command. If the problem persists, contact Technical Support.
9008	INVLD NO. BLOCKS	The number of blocks field in the request was invalid for the command specified. If the problem persists, contact Technical Support.
8109	KILL TAG ERR	If the problem persists, contact Technical Support.
0029	LISTEN BUSY	Listen before transmit; all frequencies occupied. Internal problem with the reader. If the problem persists, contact Technical Support.
9101	LOAD DEFAULT ERR	The reader was unable to successfully load its default parameters. If the problem persists, contact Technical Support.
8602	LOAD KEY ERR	If the problem persists, contact Technical Support.
0403	LOCK ERROR	The lock process failed during a write tag data for an ISO18000-6B tag. The write tag command passed, but the lock did not. This could indicate a bad tag. Repeat the process with another RFID tag. Make sure that the tag is placed within the RF field.
0039	LOCKED BLOCK	Attempt to write to a read-only tag or to a locked block. Make sure you have the right tag type selected and that you are using a tag that is supported by your printer. Ensure that the block that you are trying to write to is not already locked.
003A	LOST LOCK	UHF synthesizer error. Internal problem with the reader. If the problem persists, contact Technical Support.
0042	MEMORY ERR	Non-volatile memory data element does not exist or was not found when requesting a read of a specific element in non-volatile memory. If the problem persists, contact Technical Support.

Table 6 • RFID Error and Status Message Definitions (Continued)

Error Code	RFID Error or Status Message	Description/Action Required
0003	MESSAGE SYNCH	Point-to-point only. Current message head or “}” character interrupted a previous message. Turn the printer power off (O). Wait ten seconds, and then turn the printer power on (I). If the problem persists, contact Technical Support.
8405	MOD FILE SET ERR	Internal problem with the reader. If the problem persists, contact Technical Support.
1237	MULTIPLE TAGS	More than one RFID tag was detected in the RF field. Make sure only one label is in the RF field and that another tag is not elsewhere in the field. Make sure that the labels meet transponder placement specifications.
8010	NO APPLI PRESENT	The application specified could not be found.
0404	NO DATA READ	The RFID tag used failed or does not have the correct CRC. Try to read a few other tags. If the problem persists, contact Technical Support.
8012	NO FILE SELECTED	The command requires a file, but none was selected.
0044	NO NUM PRESENT	Internal problem with the reader. If the problem persists, contact Technical Support.
0401	NO PROTOCOL	The RFID reader received a command to perform a protocol command, but no protocol was initially set. The reader powers up with no protocols set. Make sure you have the right tag type selected and that you are using a tag that is supported by your printer.
0035	NO RF FIELD	Internal problem with the reader. If the problem persists, contact Technical Support.
0036	NO TAG NO TAG FOUND	 Note • This error message varies by reader type. No RFID tag was detected in the RF field. Several things can cause this error: <ul style="list-style-type: none"> • No acceptable RFID tag is in the RF field. This can happen if an RFID label is present but the transponder is not placed correctly within the label or if the wrong tag type is used. • The read/write power being used is too low. • The RFID tag is weak or dead. Retry with another RFID tag. Make sure you have the right tag type selected and that you are using a tag that is supported by your printer. If the problem persists, contact Technical Support.

Table 6 • RFID Error and Status Message Definitions (Continued)



Error Code	RFID Error or Status Message	Description/Action Required
0400	NO TAG NO TAG FOUND	 Note • This error message varies by reader type. No RFID tag was detected in the RF field. Several things can cause this error: <ul style="list-style-type: none"> • No acceptable RFID tag is in the RF field. This can happen if an RFID label is present but the transponder is not placed correctly within the label or if the wrong tag type is used. • The read/write power being used is too low. • The RFID tag is weak or dead. Retry with another RFID tag. Make sure you have the right tag type selected and that you are using a tag that is supported by your printer. If the problem persists, contact Technical Support.
8002	NO TAG NO TAG FOUND	 Note • This error message varies by reader type. No RFID tag was detected in the RF field. Several things can cause this error: <ul style="list-style-type: none"> • No acceptable RFID tag is in the RF field. This can happen if an RFID label is present but the transponder is not placed correctly within the label or if the wrong tag type is used. • The read/write power being used is too low. • The RFID tag is weak or dead. Retry with another RFID tag. Make sure you have the right tag type selected and that you are using a tag that is supported by your printer. If the problem persists, contact Technical Support.
0407	NOT IMPLEMENTED	The reader received a command that is not supported by the tag type. Make sure that you have the latest reader firmware, that you have the right tag type selected, and that you are using a tag that is supported by your printer. If the problem persists, contact Technical Support.
0603	NUM IDS TOO LG	Internal problem with the reader. If the problem persists, contact Technical Support.
0043	NUM FULL	Internal problem with the reader. If you are upgrading reader firmware, try resending the file. If the problem persists, contact Technical Support.

Table 6 • RFID Error and Status Message Definitions (Continued)

Error Code	RFID Error or Status Message	Description/Action Required
0102	OPCODE UNAVAIL	The opCode received by the RFID reader is invalid or not supported with the current version of reader firmware. <ol style="list-style-type: none"> 1. Make sure you download the appropriate version of reader firmware. 2. Turn the printer power off (O). Wait ten seconds, and then turn the printer power on (I). If the problem persists, contact Technical Support.
0055	OVERWRITE EPC	Error trying to overwrite a valid EPC code. Internal problem with the reader. If the problem persists, contact Technical Support.
F004	POWER SELECT ERR	The printer could not verify that the intended power setting has been set successfully. If the problem persists, contact Technical Support.
0103	POWER TOO HI	The RFID reader received a command to set the read or write power to a level that is higher than the RFID reader supports. Check the versions of the reader firmware and printer firmware. You may need to download different versions.
0106	POWER TOO LOW	The RFID reader received a command to set the read or write power to a level that is lower than the RFID reader supports. Check the versions of the reader firmware and printer firmware. You may need to download different versions.
0022	RAM ERROR	Internal problem with the reader. If the problem persists, contact Technical Support.
1234	RDR COM TIMEOUT	The printer was not able to communicate with the reader. If the problem persists, contact Technical Support.
F002	RDR COM TIMEOUT	The printer was not able to communicate with the reader. If the problem persists, contact Technical Support.
—	RDR ERR <i>xxxx</i>	Internal problem with the reader. If the problem persists, contact Technical Support.
8505	READ AFI ERR	There was an error reading the AFI byte. Verify that the tag that you are using supports this feature. If the problem persists, contact Technical Support.
8102	READ DATA ERR	This can occur when one of a number of RFID operations fails. Check that the tag is good, and repeat the process with another RFID label. If the problem persists, contact Technical Support.
8507	READ DSFID ERR	There was an error reading the DSFID byte. Verify that the tag that you are using supports this feature. If the problem persists, contact Technical Support.
8406	READ FILE ERR	Internal problem with the reader. If the problem persists, contact Technical Support.

Table 6 • RFID Error and Status Message Definitions (Continued)

Error Code	RFID Error or Status Message	Description/Action Required
9201	READ SYS ERR	There was a problem reading a parameter from the non-volatile memory of the reader. If the problem persists, contact Technical Support.
0602	REPEATED ID	One of the protocols is trying to add an existing tag ID to the buffer. Internal problem with the reader. If the problem persists, contact Technical Support.
9102	RESET DEVICE ERR	The reader was unable to successfully reset the reader. If the problem persists, contact Technical Support.
810A	REVIVE TAG ERR	If the problem persists, contact Technical Support.
0031	RF SECTION ERR	Radio controller does not respond or general RF section failure. Internal problem with the reader. If the problem persists, contact Technical Support.
0000	RFID OK	Normal operation.
0023	ROM ERROR	Internal problem with the reader. If the problem persists, contact Technical Support.
800C	R-T DATARATE ERR	The reader to tag data bit rate is not supported by the reader, the tag, or both.
0051	RX R/T FAIL	Receiver tuning runtime failure. Internal problem with the reader. If the problem persists, contact Technical Support.
0050	RX TUNE FAIL	Receiver tuning training failure. Internal problem with the reader. If the problem persists, contact Technical Support.
0027	RXD POWER HI	RXD reflective power too high. Check antenna or cable connection. If the problem persists, contact Technical Support.
002A	RXD POWER MAX	RXD reflective power max fault. Internal problem with the reader. If the problem persists, contact Technical Support.
0028	RXD WARNING	RXD reflective power warning level. Occurs at –10 dBm. Internal problem with the reader. If the problem persists, contact Technical Support.
8503	SCAN EAS ERR	The reader did not detect an EAS code in the field. Verify that the tag that you are using supports this feature and that the EAS bit is enabled.
8302	SELECT APPLI ERR	Internal problem with the reader. If the problem persists, contact Technical Support.
8402	SELECT FILE ERR	Internal problem with the reader. If the problem persists, contact Technical Support.

Table 6 • RFID Error and Status Message Definitions (Continued)

Error Code	RFID Error or Status Message	Description/Action Required
8101	SELECT TAG ERR	The reader failed to select a specified tag in the RF field. Verify that a tag is within the field and that the current tag type is valid with the printer firmware (see Table 9, Supported Tag Types and Default Values , on page 111).
002F	SELF TST ERR	Self-test error. Internal problem with the reader. If the problem persists, contact Technical Support.
8202	SEND PASSWRD ERR	Internal problem with the reader. If the problem persists, contact Technical Support.
0024	SERIAL # ERR	Serial number chip error. Internal problem with the reader. If the problem persists, contact Technical Support.
000E	SERIAL ERROR 1	High level serial error 1. Internal problem with the reader. If the problem persists, contact Technical Support.
000F	SERIAL ERROR 2	High level serial error 2. Internal problem with the reader. If the problem persists, contact Technical Support.
0011	SERIAL OVERFLW	Serial overflow error. Internal problem with the reader. If the problem persists, contact Technical Support.
9301	SET DEFAULT ERR	There was a problem writing a parameter to the non-volatile memory of the reader. If the problem persists, contact Technical Support.
810D	SET RDR DAT RATE	Internal problem with the reader. If the problem persists, contact Technical Support.
8106	SET TAG DAT RATE	If the problem persists, contact Technical Support.
8601	STORE KEY ERR	If the problem persists, contact Technical Support.
7F00	SYS UNKNWN ERR	Internal problem with the reader. If the problem persists, contact Technical Support.
0041	TAG DATA LOST	In serial polled or RF continuous mode, incoming new tag data overwrote old tag data between polls. Internal problem with the reader. If the problem persists, contact Technical Support.
040A	TAG ERROR	Internal problem with the reader. If the problem persists, contact Technical Support.

Table 6 • RFID Error and Status Message Definitions (Continued)

Error Code	RFID Error or Status Message	Description/Action Required
0600	TAG ID FAULT	The reader received a command to get a certain number of tag IDs from the tag ID buffer. The reader contains less tag IDs stored in its tag ID buffer than the number the host sent. Internal problem with the reader. If the problem persists, contact Technical Support.
8004	TAG INTEGRITY ERR	Response from the tag failed the CRC check.
8006	TAG NOT AUTHENTIC	An operation could not be performed on the tag because the tag was not authenticated.
0038	TAG NOT FOUND	Good tag data is available, but the tag specifically requested was not found (^RT, ^WT commands). Repeat the process with another RFID label. If the problem persists, contact Technical Support.
8007	TAG NOT IN FIELD	The tag specified was not in the RFID field.
0021	TEMP ERROR	Temperature sensor error. Internal problem with the reader. If the problem persists, contact Technical Support.
0107	TIMEOUT TO LONG	Internal problem with the reader. If the problem persists, contact Technical Support.
7F01	TM ASSERT FAIL	Internal problem with the reader. If the problem persists, contact Technical Support.
800B	T-R DATARATE ERR	The tag to reader data bit rate is not supported by the reader, the tag, or both.
9001	UNKNOWN ERR	An unidentified error occurred. If the problem persists, contact Technical Support.
1236	VERIFY FAIL	Internal problem with the reader. If the problem persists, contact Technical Support.
003B	VERIFY FAILED	The write operation could not be verified because the tag data could not be read. Check that the tag is good, and repeat the process with another RFID label. If the problem persists, contact Technical Support.
8504	WRITE AFI ERR	There was an error writing to the AFI byte. Verify that the tag that you are using supports this feature and that they byte is unlocked. If the problem persists, contact Technical Support.
8103	WRITE DATA ERR	This can occur when one of a number of RFID operations fails. Check that the tag is good, and repeat the process with another RFID label. If the problem persists, contact Technical Support.

Table 6 • RFID Error and Status Message Definitions (Continued)

Error Code	RFID Error or Status Message	Description/Action Required
8506	WRITE DSFID ERR	There was an error writing to the DSFID byte. Verify that the tag that you are using supports this feature and that they byte is unlocked. If the problem persists, contact Technical Support.
0406	WRITE FAILED	This can occur when one of a number of RFID operations fails. Check that the tag is good, and repeat the process with another RFID label. If the problem persists, contact Technical Support.
8407	WRITE FILE ERR	Internal problem with the reader. If the problem persists, contact Technical Support.
9202	WRITE SYS ERR	There was a problem writing a parameter to the non-volatile memory of the reader. If the problem persists, contact Technical Support.

Error Codes

Table 7 shows the possible error codes, the corresponding error or status message, and the action required (if any).

Table 7 • RFID Error Code Definitions

Error Code	RFID Error or Status Message	Description/Action Required
—	RDR ERR <i>xxxx</i>	Internal problem with the reader. If the problem persists, contact Technical Support.
0000	RFID OK	Normal operation.
0001	BAD MESSAGE	Internal communications problem with the reader. If the problem persists, contact Technical Support.
0003	MESSAGE SYNCH	Point-to-point only. Current message head or “}” character interrupted a previous message. Turn the printer power off (O). Wait ten seconds, and then turn the printer power on (I). If the problem persists, contact Technical Support.
0004	BAD CRC	The last valid message string had a bad Cyclic Redundancy Check (CRC). An integrity check of the reader firmware failed. If the problem persists, contact Technical Support.
0005	BAD DATA	The reader received bad data from the printer. If the problem persists, contact Technical Support.
0008	BAD MSG HEAD	Internal communications problem with the reader. If the problem persists, contact Technical Support.
0009	BAD MSG TAIL	Internal communications problem with the reader. If the problem persists, contact Technical Support.
0010	CMD INHIBITED	Internal communications problem with the reader. If the problem persists, contact Technical Support.
0011	SERIAL OVERFLW	Serial overflow error. Internal problem with the reader. If the problem persists, contact Technical Support.
000A	BAD COMMAND	The reader received a bad command from the printer. If the problem persists, contact Technical Support.
000B	BAD SUBCMD	Internal communications problem with the reader. If the problem persists, contact Technical Support.
000C 000D	INVALID PARAM	The RFID reader received a valid command with an unsupported or invalid value for one of the parameters. If the problem persists, contact Technical Support.
000E	SERIAL ERROR 1	High level serial error 1. Internal problem with the reader. If the problem persists, contact Technical Support.

Table 7 • RFID Error Code Definitions (Continued)

Error Code	RFID Error or Status Message	Description/Action Required
000F	SERIAL ERROR 2	High level serial error 2. Internal problem with the reader. If the problem persists, contact Technical Support.
0021	TEMP ERROR	Temperature sensor error. Internal problem with the reader. If the problem persists, contact Technical Support.
0022	RAM ERROR	Internal problem with the reader. If the problem persists, contact Technical Support.
0023	ROM ERROR	Internal problem with the reader. If the problem persists, contact Technical Support.
0024	SERIAL # ERR	Serial number chip error. Internal problem with the reader. If the problem persists, contact Technical Support.
0025	ANT. BAD/GONE	The RFID reader cannot detect the RFID antenna (coupler), or the antenna (coupler) does not work. Contact Technical Support.
0026	BAD ANT.MUX	Internal problem with the reader. Contact Technical Support.
0027	RXD POWER HI	RXD reflective power too high. Check antenna or cable connection. If the problem persists, contact Technical Support.
0028	RXD WARNING	RXD reflective power warning level. Occurs at -10 dBm. Internal problem with the reader. If the problem persists, contact Technical Support.
0029	LISTEN BUSY	Listen before transmit; all frequencies occupied. Internal problem with the reader. If the problem persists, contact Technical Support.
002A	RXD POWER MAX	RXD reflective power max fault. Internal problem with the reader. If the problem persists, contact Technical Support.
002F	SELF TST ERR	Self-test error. Internal problem with the reader. If the problem persists, contact Technical Support.
0031	RF SECTION ERR	Radio controller does not respond or general RF section failure. Internal problem with the reader. If the problem persists, contact Technical Support.
0033	ANT FAILURE	Antenna failure. Contact Technical Support.
0035	NO RF FIELD	Internal problem with the reader. If the problem persists, contact Technical Support.

Table 7 • RFID Error Code Definitions (Continued)

Error Code	RFID Error or Status Message	Description/Action Required
0036	NO TAG NO TAG FOUND	 Note • This error message varies by reader type. No RFID tag was detected in the RF field. Several things can cause this error: <ul style="list-style-type: none"> • No acceptable RFID tag is in the RF field. This can happen if an RFID label is present but the transponder is not placed correctly within the label or if the wrong tag type is used. • The read/write power being used is too low. • The RFID tag is weak or dead. Retry with another RFID tag. Make sure you have the right tag type selected and that you are using a tag that is supported by your printer. If the problem persists, contact Technical Support.
0037	DATA CRC	An integrity check of the reader firmware failed. If the problem persists, contact Technical Support.
0038	TAG NOT FOUND	Good tag data is available, but the tag specifically requested was not found (^RT, ^WT commands). Repeat the process with another RFID label. If the problem persists, contact Technical Support.
0039	LOCKED BLOCK	Attempt to write to a read-only tag or to a locked block. Make sure you have the right tag type selected and that you are using a tag that is supported by your printer. Ensure that the block that you are trying to write to is not already locked.
003A	LOST LOCK	UHF synthesizer error. Internal problem with the reader. If the problem persists, contact Technical Support.
003B	VERIFY FAILED	The write operation could not be verified because the tag data could not be read. Check that the tag is good, and repeat the process with another RFID label. If the problem persists, contact Technical Support.
0041	TAG DATA LOST	In serial polled or RF continuous mode, incoming new tag data overwrote old tag data between polls. Internal problem with the reader. If the problem persists, contact Technical Support.
0042	MEMORY ERR	Non-volatile memory data element does not exist or was not found when requesting a read of a specific element in non-volatile memory. If the problem persists, contact Technical Support.
0043	NUM FULL	Internal problem with the reader. If you are upgrading reader firmware, try resending the file. If the problem persists, contact Technical Support.
0044	NO NUM PRESENT	Internal problem with the reader. If the problem persists, contact Technical Support.

Table 7 • RFID Error Code Definitions (Continued)

Error Code	RFID Error or Status Message	Description/Action Required
0045	INVALID VAR.	Invalid configuration variable. Internal problem with the reader. If the problem persists, contact Technical Support.
0046	HARDWARE ERR	If the problem persists, contact Technical Support.
0048	FPGA OLD	The FPGA code is out of date. This would typically happen during a reader firmware upgrade. Make sure you download the appropriate version of reader firmware. If the problem persists, contact Technical Support.
0050	RX TUNE FAIL	Receiver tuning training failure. Internal problem with the reader. If the problem persists, contact Technical Support.
0051	RX R/T FAIL	Receiver tuning runtime failure. Internal problem with the reader. If the problem persists, contact Technical Support.
0052	BAD PASSCODE	Bad passcode for kill tag function.
0053	BAUD ERR	Internal problem with the reader. If the problem persists, contact Technical Support.
0054	CMD FAIL	Internal communications problem with the reader. If the problem persists, contact Technical Support.
0055	OVERWRITE EPC	Error trying to overwrite a valid EPC code. Internal problem with the reader. If the problem persists, contact Technical Support.
0100	DATA AMOUNT ERR	Two situations can result in this error: <ul style="list-style-type: none"> • The data length in a message to the RFID reader from the printer is less than the number of arguments in the message. • The data length is greater than the number of arguments. The reader will wait indefinitely until it receives all of the data specified in the data length field. If the problem persists, contact Technical Support.
0101	INVALID OPCODE	The opCode received by the RFID reader is invalid or not supported with the current version of reader firmware. Make sure you download the appropriate version of reader firmware. If the problem persists, contact Technical Support.
0102	OPCODE UNAVAIL	The opCode received by the RFID reader is invalid or not supported with the current version of reader firmware. <ol style="list-style-type: none"> 1. Make sure you download the appropriate version of reader firmware. 2. Turn the printer power off (O). Wait ten seconds, and then turn the printer power on (I). If the problem persists, contact Technical Support.

Table 7 • RFID Error Code Definitions (Continued)

Error Code	RFID Error or Status Message	Description/Action Required
0103	POWER TOO HI	The RFID reader received a command to set the read or write power to a level that is higher than the RFID reader supports. Check the versions of the reader firmware and printer firmware. You may need to download different versions.
0104	INVALID FREQ	The RFID reader received a command to set the frequency outside of the supported range. If the problem persists, contact Technical Support.
0105	INVALID PARAM	The RFID reader received a valid command with an unsupported or invalid value for one of the parameters. If the problem persists, contact Technical Support.
0106	POWER TOO LOW	The RFID reader received a command to set the read or write power to a level that is lower than the RFID reader supports. Check the versions of the reader firmware and printer firmware. You may need to download different versions.
0107	TIMEOUT TO LONG	Internal problem with the reader. If the problem persists, contact Technical Support.
0109	INVALID CMD	The command does not exist or is invalid for the reader. Internal problem with the reader. If the problem persists, contact Technical Support.
010A	INVALID BAUD	Internal problem with the reader. If the problem persists, contact Technical Support.
0200	BAD IMAGE CRC	The RFID reader received a command to erase some part of the flash memory. This typically would happen during a reader firmware upgrade. Make sure that you download the appropriate version of reader firmware. If the problem persists, contact Technical Support.
0201	BAD APP END ADD	The RFID reader received a command to erase some part of the flash memory. This typically would happen during a reader firmware upgrade. Make sure that you download the appropriate version of reader firmware. If the problem persists, contact Technical Support.
0300 0301 0302 0303 0304 0305 0306	FLASH ERROR	An error occurred reading or writing from the reader's Flash memory. If the problem persists, contact Technical Support.

Table 7 • RFID Error Code Definitions (Continued)

Error Code	RFID Error or Status Message	Description/Action Required
0400	NO TAG NO TAG FOUND	 Note • This error message varies by reader type. No RFID tag was detected in the RF field. Several things can cause this error: <ul style="list-style-type: none"> • No acceptable RFID tag is in the RF field. This can happen if an RFID label is present but the transponder is not placed correctly within the label or if the wrong tag type is used. • The read/write power being used is too low. • The RFID tag is weak or dead. Retry with another RFID tag. Make sure you have the right tag type selected and that you are using a tag that is supported by your printer. If the problem persists, contact Technical Support.
0401	NO PROTOCOL	The RFID reader received a command to perform a protocol command, but no protocol was initially set. The reader powers up with no protocols set. Make sure you have the right tag type selected and that you are using a tag that is supported by your printer.
0402	INVALID PROTOC	The RFID reader received a command for a protocol value that is not supported with the current version of reader firmware. Make sure you have the right tag type selected and that you are using a tag that is supported by your printer.
0403	LOCK ERROR	The lock process failed during a write tag data for an ISO18000-6B tag. The write tag command passed, but the lock did not. This could indicate a bad tag. Repeat the process with another RFID tag. Make sure that the tag is placed within the RF field.
0404	NO DATA READ	The RFID tag used failed or does not have the correct CRC. Try to read a few other tags. If the problem persists, contact Technical Support.
0405	AFE NOT ON	Internal problem with the reader. The Analog Front End is turned off. Contact Technical Support.
0406	WRITE FAILED	This can occur when one of a number of RFID operations fails. Check that the tag is good, and repeat the process with another RFID label. If the problem persists, contact Technical Support.
0407	NOT IMPLEMENTED	The reader received a command that is not supported by the tag type. Make sure that you have the latest reader firmware, that you have the right tag type selected, and that you are using a tag that is supported by your printer. If the problem persists, contact Technical Support.

Table 7 • RFID Error Code Definitions (Continued)

Error Code	RFID Error or Status Message	Description/Action Required
0408	INVALID WR DATA	In EPC 0+, the first two bits determine the tag ID length. If the first two bits are 0b00, then the tag ID must be 96 bits. Otherwise, the tag ID is 64 bits. Make sure that the first two bits have the correct values, depending on the tag ID length.
0409	INVALID ADDR	The RFID reader received a command to write to an invalid address in the tag data address space. Make sure that the address specified is within the scope of the tag data address space.
040A	TAG ERROR	Internal problem with the reader. If the problem persists, contact Technical Support.
040B	DATA TOO LARGE	Internal problem with the reader. If the problem persists, contact Technical Support.
0420	GEN2 PROT OTHER	Internal problem with the reader. If the problem persists, contact Technical Support.
0423	GEN2 BAD PC	Internal problem with the reader. If the problem persists, contact Technical Support.
0424	GEN2 MEM LOCKED	Internal problem with the reader. If the problem persists, contact Technical Support.
042B	GEN2 LOW PWR	Internal problem with the reader. If the problem persists, contact Technical Support.
042F	GEN2 ERROR	Internal problem with the reader. If the problem persists, contact Technical Support.
0430	GEN2 UNKNWN ERR	Internal problem with the reader. If the problem persists, contact Technical Support.
0500	INVALID FREQ	The RFID reader received a command to set the frequency outside of the supported range. If the problem persists, contact Technical Support.
0600	TAG ID FAULT	The reader received a command to get a certain number of tag IDs from the tag ID buffer. The reader contains less tag IDs stored in its tag ID buffer than the number the host sent. Internal problem with the reader. If the problem persists, contact Technical Support.
0601	ID BUFFER FULL	The tag ID buffer is full. If the problem persists, contact Technical Support.
0602	REPEATED ID	One of the protocols is trying to add an existing tag ID to the buffer. Internal problem with the reader. If the problem persists, contact Technical Support.
0603	NUM IDS TOO LG	Internal problem with the reader. If the problem persists, contact Technical Support.

Table 7 • RFID Error Code Definitions (Continued)

Error Code	RFID Error or Status Message	Description/Action Required
1234	RDR COM TIMEOUT	The printer was not able to communicate with the reader. If the problem persists, contact Technical Support.
1236	VERIFY FAIL	Internal problem with the reader. If the problem persists, contact Technical Support.
1237	MULTIPLE TAGS	More than one RFID tag was detected in the RF field. Make sure only one label is in the RF field and that another tag is not elsewhere in the field. Make sure that the labels meet transponder placement specifications.
7F00	SYS UNKNWN ERR	Internal problem with the reader. If the problem persists, contact Technical Support.
7F01	TM ASSERT FAIL	Internal problem with the reader. If the problem persists, contact Technical Support.
8001	INVALID TAG TYPE	The tag type was not valid for the command specified. Make sure that you are using the right tag type for your operation. If the problem persists, contact Technical Support.
8002	NO TAG NO TAG FOUND	 Note • This error message varies by reader type. No RFID tag was detected in the RF field. Several things can cause this error: <ul style="list-style-type: none"> • No acceptable RFID tag is in the RF field. This can happen if an RFID label is present but the transponder is not placed correctly within the label or if the wrong tag type is used. • The read/write power being used is too low. • The RFID tag is weak or dead. Retry with another RFID tag. Make sure you have the right tag type selected and that you are using a tag that is supported by your printer. If the problem persists, contact Technical Support.
8003	COLLISION ERR	Multiple tags in the field have the same tag ID.
8004	TAG INTEGRITY ERR	Response from the tag failed the CRC check.
8005	BLOCK(S) LOCKED	A write operation could not be performed because a block was locked.
8006	TAG NOT AUTHENTIC	An operation could not be performed on the tag because the tag was not authenticated.
8007	TAG NOT IN FIELD	The tag specified was not in the RFID field.
800B	T-R DATARATE ERR	The tag to reader data bit rate is not supported by the reader, the tag, or both.
800C	ENCRYPT TAG ERR	The data to be written to the tag was not encrypted properly.
800C	R-T DATARATE ERR	The reader to tag data bit rate is not supported by the reader, the tag, or both.

Table 7 • RFID Error Code Definitions (Continued)

Error Code	RFID Error or Status Message	Description/Action Required
800D	DECRYPT TAG ERR	The data read from the tag was not decrypted properly or was corrupted.
800E	INVALD SIGNATURE	The HMAC written to the tag did not match the data and the key.
800F	INVALID AUTH KEY	The key number does not exist or is invalid for authentication with a specific reader or tag.
8010	NO APPLI PRESENT	The application specified could not be found.
8011	FILE NOT FOUND	The specified file was not found on the application.
8012	NO FILE SELECTED	The command requires a file, but none was selected.
8013	INVALID KEY NO.	The key number does not exist or is out of the range of valid keys.
8014	INVALID KEY LEN	The key length is not valid for the tag type, the command, or the reader.
8101	SELECT TAG ERR	The reader failed to select a specified tag in the RF field. Verify that a tag is within the field and that the current tag type is valid with the printer firmware (see Table 9, Supported Tag Types and Default Values , on page 111).
8102	READ DATA ERR	This can occur when one of a number of RFID operations fails. Check that the tag is good, and repeat the process with another RFID label. If the problem persists, contact Technical Support.
8103	WRITE DATA ERR	This can occur when one of a number of RFID operations fails. Check that the tag is good, and repeat the process with another RFID label. If the problem persists, contact Technical Support.
8104	ACTIVATE TAG ERR	If the problem persists, contact Technical Support.
8105	DEACTIV. TAG ERR	If the problem persists, contact Technical Support.
8106	SET TAG DAT RATE	If the problem persists, contact Technical Support.
8107	GET TAG INFO ERR	The reader was unable to acquire the information from the tag. The reader may not contain information for the selected tag.
8108	GET LOCK STA ERR	The reader was unable to acquire the lock status from the tag.
8109	KILL TAG ERR	If the problem persists, contact Technical Support.
810A	REVIVE TAG ERR	If the problem persists, contact Technical Support.
810B	ERASE TAG ERR	If the problem persists, contact Technical Support.
810C	FORMAT TAG ERR	If the problem persists, contact Technical Support.
810D	SET RDR DAT RATE	Internal problem with the reader. If the problem persists, contact Technical Support.
810F	INVENTORY DONE	Status message indicating that the reader exited the Inventory mode. No action required.
8201	AUTHEN TAG ERR	Tag not authenticated.

Table 7 • RFID Error Code Definitions (Continued)

Error Code	RFID Error or Status Message	Description/Action Required
8202	SEND PASSWRD ERR	Internal problem with the reader. If the problem persists, contact Technical Support.
8301	GET APPLI ID ERR	Internal problem with the reader. If the problem persists, contact Technical Support.
8302	SELECT APPLI ERR	Internal problem with the reader. If the problem persists, contact Technical Support.
8303	CREATE APPLI ERR	Internal problem with the reader. If the problem persists, contact Technical Support.
8401	GET FILE ID _s ERR	Internal problem with the reader. If the problem persists, contact Technical Support.
8402	SELECT FILE ERR	Internal problem with the reader. If the problem persists, contact Technical Support.
8403	CREATE FILE ERR	Internal problem with the reader. If the problem persists, contact Technical Support.
8404	GET FILE SET ERR	Internal problem with the reader. If the problem persists, contact Technical Support.
8405	MOD FILE SET ERR	Internal problem with the reader. If the problem persists, contact Technical Support.
8406	READ FILE ERR	Internal problem with the reader. If the problem persists, contact Technical Support.
8407	WRITE FILE ERR	Internal problem with the reader. If the problem persists, contact Technical Support.
8408	DELETE FILE ERR	Internal problem with the reader. If the problem persists, contact Technical Support.
8409	CLEAR FILE ERR	Internal problem with the reader. If the problem persists, contact Technical Support.
840A	INC VAL FILE ERR	Internal problem with the reader. If the problem persists, contact Technical Support.
840B	DEC VAL FILE ERR	Internal problem with the reader. If the problem persists, contact Technical Support.
8501	ENABLE EAS ERR	There was an error while setting the EAS bit. Verify that the tag that you are using supports this feature.
8502	DISABLE EAS ERR	There was an error while clearing the EAS bit. Verify that the tag that you are using supports this feature.
8503	SCAN EAS ERR	The reader did not detect an EAS code in the field. Verify that the tag that you are using supports this feature and that the EAS bit is enabled.

Table 7 • RFID Error Code Definitions (Continued)

Error Code	RFID Error or Status Message	Description/Action Required
8504	WRITE AFI ERR	There was an error writing to the AFI byte. Verify that the tag that you are using supports this feature and that they byte is unlocked. If the problem persists, contact Technical Support.
8505	READ AFI ERR	There was an error reading the AFI byte. Verify that the tag that you are using supports this feature. If the problem persists, contact Technical Support.
8506	WRITE DSFID ERR	There was an error writing to the DSFID byte. Verify that the tag that you are using supports this feature and that they byte is unlocked. If the problem persists, contact Technical Support.
8507	READ DSFID ERR	There was an error reading the DSFID byte. Verify that the tag that you are using supports this feature. If the problem persists, contact Technical Support.
8508	CREDIT VALUE ERR	If the problem persists, contact Technical Support.
8509	DEBIT VALUE ERR	If the problem persists, contact Technical Support.
8601	STORE KEY ERR	If the problem persists, contact Technical Support.
8602	LOAD KEY ERR	If the problem persists, contact Technical Support.
8ACA	EXIT TAGLOOP ERR	Internal problem with the reader. If the problem persists, contact Technical Support.
9001	UNKNOWN ERR	An unidentified error occurred. If the problem persists, contact Technical Support.
9002	INVALID CMD	The command does not exist or is invalid for the reader. Internal problem with the reader. If the problem persists, contact Technical Support.
9003	INVALID CRC	Invalid CRC sent in the request to the reader. If the problem persists, contact Technical Support.
9004	INVALID MESS LEN	The number of bytes sent to the reader was invalid for the command or for the message length passed in. If the problem persists, contact Technical Support.
9005	INVALID ADDRESS	The address specified for the command was invalid. If the problem persists, contact Technical Support.
9006	INVALID FLAGS	The flags specified were invalid for the command specified. If the problem persists, contact Technical Support.
9007	INVULD ASCII BYTE	A non-ASCII byte value was sent in an ASCII mode command. If the problem persists, contact Technical Support.
9008	INVULD NO. BLOCKS	The number of blocks field in the request was invalid for the command specified. If the problem persists, contact Technical Support.

Table 7 • RFID Error Code Definitions (Continued)

Error Code	RFID Error or Status Message	Description/Action Required
9009	INVALID DATA LEN	The length of the data specified in the request was invalid for the command specified. If the problem persists, contact Technical Support.
9101	LOAD DEFAULT ERR	The reader was unable to successfully load its default parameters. If the problem persists, contact Technical Support.
9102	RESET DEVICE ERR	The reader was unable to successfully reset the reader. If the problem persists, contact Technical Support.
9103	BOOTLOADER ERR	The reader failed to enter bootloader mode, which is necessary to upgrade firmware. If the problem persists, contact Technical Support.
9201	READ SYS ERR	There was a problem reading a parameter from the non-volatile memory of the reader. If the problem persists, contact Technical Support.
9202	WRITE SYS ERR	There was a problem writing a parameter to the non-volatile memory of the reader. If the problem persists, contact Technical Support.
9301	SET DEFAULT ERR	There was a problem writing a parameter to the non-volatile memory of the reader. If the problem persists, contact Technical Support.
9302	GET DEFAULT ERR	There was a problem reading a parameter from the non-volatile memory of the reader. If the problem persists, contact Technical Support.
9401	AUTHEN RDR ERR	If the problem persists, contact Technical Support.
9402	ENABLE_DEBUG ERR	If the problem persists, contact Technical Support.
9403	DISABLE_DEBG ERR	If the problem persists, contact Technical Support.
900F	ANT. BAD/GONE	The RFID reader cannot detect the RFID antenna (coupler), or the antenna (coupler) does not work. Contact Technical Support.
F002	RDR COM TIMEOUT	The printer was not able to communicate with the reader. If the problem persists, contact Technical Support.
F003	ANTENNA SEL ERR	The printer firmware could not verify that the selected RFID antenna (coupler) is properly connected. If selecting the antenna through ZPL, ensure that your printer supports this feature and that your parameters are correct. If the problem persists, contact Technical Support.
F004	POWER SELECT ERR	The printer could not verify that the intended power setting has been set successfully. If the problem persists, contact Technical Support.



Notes • _____



ZPL II Commands for RFID

This section contains the ZPL II commands for RFID-specific applications.

For non-RFID ZPL commands, refer to the *ZPL II Programming Guide*. A copy is available on the User CD provided with your printer and online at <http://www.zebra.com/manuals>.

Contents

ZPL Overview.	81
Printer and Firmware Compatibility	82
^HL or ~HL Return RFID Data Log to Host	84
^HR Calibrate RFID Transponder Position	85
^HV Host Verification	88
^MM Print Mode	89
^RA Read AFI or DSFID Byte	91
^RB Define EPC Data Structure	93
^RE Enable/Disable E.A.S. Bit.	95
^RF Read or Write RFID Format	96
^RI Get RFID Tag ID.	100
^RM Enable RFID Motion.	101
^RN Detect Multiple RFID Tags in Encoding Field.	102
~RO Reset Advanced Counters.	103
^RQ Quick Write EPC Data and Passwords	105
^RR Specify RFID Retries for a Block	107
^RS Set Up RFID Parameters.	108
^RT Read RFID Tag	115
~RV Report RFID Encoding Results	117
^RW Set RF Power Levels for Read and Write	118
^RZ Set RFID Tag Password and Lock Tag	120
^WF Encode AFI or DSFID Byte	123

Contents (Continued)

^WT Write (Encode) RFID Tag..... 125
^WV Verify RFID Encoding Operation 127

ZPL Overview

In addition to reading or encoding RFID tags, the RFID ZPL commands also provide for RFID exception handling, such as setting the number of read/write retries before declaring a transponder defective (set with ^RR, ^RT, and ^WT) or setting the number of labels that will be attempted if an error occurs (set with ^RS).

For example, if an RFID label fails to program correctly or if the transponder cannot be detected, the printer ejects the label and prints VOID across it. The printer will try to print another label with the same data and format for the number of RFID labels specified by the ^RS command. If the problem persists, the printer follows the error handling instructions specified by the ^RS command: the printer may remove the problematic format from the print queue and proceed with the next format (if one exists in the buffer), or it may place the printer in Pause or Error mode.



Important • Consider the following before using any command in this section:

- Before using a particular command, verify that it is compatible with your printer and firmware version. See [Table 8 on page 82](#).
- If a parameter in the following tables is designated as *not applicable* for a particular printer, any value entered for the parameter will be ignored, but the place holder for the field is required.

Printer and Firmware Compatibility

Table 8 shows which RFID ZPL commands you can use with different printers and firmware versions.

Table 8 • Supported Commands Based on Printer and Firmware

Command	Function	UHF Printers				HF Printers											
		R110Xi and R170Xi	RZ400 and RZ600	R110PAX4	R4Mplus	RP4T	R110X/HF	R2844-Z									
Firmware																	
<i>~HL</i> or <i>~HL</i> on page 84	Return RFID Data Log to Host	*	*	*	*	*	*	*	*	*	*	*	*	*	*	*	*
<i>^HR</i> on page 85	Calibrate RFID Transponder Position	*	*	*	*	*	*	*	*	*	*	*	*	*	*	*	*
<i>^HV</i> on page 88	Host Verification	*	*	*	*	*	*	*	*	*	*	*	*	*	*	*	*
<i>^RA</i> on page 91	Read AFI or DSFID Byte	—	—	—	—	—	—	—	—	—	—	—	—	—	—	—	—
<i>^RB</i> on page 93	Define EPC Data Structure	*	*	*	*	*	*	*	*	*	*	*	*	*	*	*	*
<i>^RE</i> on page 95	Enable/Disable E.A.S. Bit	—	—	—	—	—	—	—	—	—	—	—	—	—	—	—	—
<i>^RF</i> on page 96	Read or Write RFID Format	*	*	*	*	*	*	*	*	*	*	*	*	*	*	*	*
<i>^RI</i> on page 100	Get RFID Tag ID	*	*	*	*	*	*	*	*	*	*	*	*	*	*	*	*
<i>^RM</i> on page 101	Enable RFID Motion	*	*	*	*	*	*	*	*	*	*	*	*	*	*	*	*
<i>^RN</i> on page 102	Detect Multiple RFID Tags in Encoding Field	*	*	*	*	*	*	*	*	*	*	*	*	*	*	*	*
<i>~RO</i> on page 103	Reset Advanced Counters	*	*	*	*	*	*	*	*	*	*	*	*	*	*	*	*

* = Supported
 — = Not supported
 a. Not *^FH* capable. Also, parameters t and a do not apply. b. For parameter c, the only accepted value is N for No Action.
 c. Use the *^RF*, *^RM*, and *^RR* commands rather than the *^RT* command. d. Use the *^RF*, *^RM*, *^RR*, and *^RV* commands rather than the *^WT* command.

Table 8 • Supported Commands Based on Printer and Firmware (Continued)

Command	Function	UHF Printers				HF Printers				
		R110X/ and R170X/	RZ400 and RZ600	R110PAX4	R4mpus	RP4T	R110X/HF	R2844-Z		
Firmware										
^RQ on page 105	Quick Write EPC Data and Passwords	* (R60.15.7Z or later)	* (R62.15.7Z or later)	R63.X.X	SP994X	SP999X	SP1027X	SP1056X	SP1082X	all
^RR on page 107	Specify RFID Retries for a Block	*	*	*	*	*	*	*	*	*
^RS on page 108	Set Up RFID Parameters	*	*	*	*	*	*	*	*	**b
^RT on page 115	Read RFID Tag	*c	*c	*c	*c	*c	*c	*c	*c	*c
~RV on page 117	Report RFID Encoding Results	*	*	*	(SP994J or later)	(SP999C or later)	*	*	*	*
^RW on page 118	Set RF Power Levels for Read and Write	*	*	*	*	*	*	*	*	*
^RZ on page 120	Set RFID Tag Password and Lock Tag	*	*	*	*	*	*	*	*	*
^WF on page 123	Encode AFI or DSFID Byte	—	—	—	—	—	—	—	—	*
^WT on page 125	Write (Encode) RFID Tag	*d	*d	*d	*d	*d	*d	*d	*d	*d
^WV on page 127	Verify RFID Encoding Operation	*	*	*	*	*	*	*	*	*

* = Supported
— = Not supported

a. Not ^FH capable. Also, parameters t and a do not apply. b. For parameter e, the only accepted value is N for No Action.

c. Use the ^RF, ^RM, and ^RR commands rather than the ^RT command. d. Use the ^RF, ^RM, ^RR, and ^RV commands rather than the ^WT command.

^HL or ~HL

Return RFID Data Log to Host

Description The printer continually logs RFID data and stores it in the printer's RAM. Use this command to request that the RFID data log be returned to the host computer, to clear the current data log, and to restart data recording. The data returned show the status of the RFID read, write, and lock commands and show any resulting error codes.

Format ^HL or ~HL

Comments

- Data is shown in the format sent by the ^RFW command (ASCII, Hex, or EPC).
- In the log, the data displays in this manner:

```
C,EEEE,DDDDDDDDDDDDDDDDDDDDDDDDDDDD
```

where

C = the RFID operation

UHF:

R = Read

W = Write

L = Lock

Q = Quick Write EPC Data and Passwords

Z = Set RFID Tag Password and Lock Tag

A = Read Password

I = Read RFID Tag ID

HF:

R = read (^RF)

W = write (^RF)

r = read (^RT)

w = write (^WT)

l = Lock

TIDR = Read RFID Tag ID

EASS = Enable/Disable E.A.S. Bit

AFIR = Read AFI Byte

DSFIDR = Read DSFID Byte

AFIW = Encode AFI Byte

DSFIDW = Encode DSFID Byte

EEEE = the RFID error code (see [RFID Error Codes and Messages on page 53](#))

DDDDDDDDDDDDDDDDDDDDDDDDDDDD = data read or written

- If the log exceeds 64K (approximately 2000 operations), the data log is cleared automatically, and data recording restarts. When this happens, the following appears in the log:

```
Logfile automatically reset
```

- If the printer loses power, the log is lost. If the log results are important to you, retrieve the log frequently.

^HR

Calibrate RFID Transponder Position



Important • Consider the following before using this command:

- This command is not supported by all printers or firmware. See *Printer and Firmware Compatibility* on page 82 for the list of printers and firmware with which you can use this command.
- Do not perform transponder calibration for RFID media that meets the transponder placement specifications for your printer. Doing so will slow the printer's throughput unnecessarily. To order media that is designed for use with your RFID printer, contact your authorized Zebra reseller.

Description Use this command to initiate an RFID transponder calibration for a specific RFID label. Results are returned to the host computer. This calibration is used to determine the optimal programming position for RFID media that may not meet the transponder placement specifications for the printer.

During transponder calibration, the printer feeds the RFID label one millimeter at a time while taking readings (via the READ TAG command and the WRITE TAG commands) to profile the RFID transponder. Based on the results, the printer determines the optimal programming position for the label and returns a results table to the host. The calibrated value is used as the programming position for the ^RS command, can be overwritten by the ^RS command, and is saved to nonvolatile memory (the value is saved even if the power is turned off).

This calibration takes into account the print mode, backfeed mode, and tear off position. The **RUN** option in the **RFID TAG CALIB** control panel parameter performs the same calibration but does not create a results table.



Important • If a label format specifies a value for parameter p (read/write position of the transponder) in the ^RS command, that value will be used for the programming position for all RFID labels until a new position is specified or until the printer is turned Off (O) and then back On (I).

Format ^HRa , b

This table identifies the parameters for this format.

Parameters	Details
a = start string	User text to appear before the results table. <i>Accepted values:</i> any string less than 65 characters <i>Default value:</i> start
b = end string	User text to appear after the results table. <i>Accepted values:</i> any string less than 65 characters <i>Default value:</i> end

Comments

- Based on the recommended transponder placement position for most RFID labels, the printer's default RFID programming position is zero for the R110PAX4. For other RFID printers, the default programming position is the label length minus 1 mm (0.04 in.). To return to the default programming position at any time, use the RESTORE option in the **RFID TAG CALIB** control panel parameter (see *Calibrate RFID Tag on page 23*).
- To see the current programming position (shown in dot rows), refer to the printer configuration label:

```

600..... RFID VALID CTR
172..... RFID VOID CTR
2..... RFID READ PWR
2..... RFID WRITE PWR
NO TAG FOUND..... RFID ERR STATUS
Gen2..... RFID TAG TYPE
00000003..... RFID HW VERSION
TM: 20080415..... RFID FW VERSION
0132..... PROG. POSITION
6,217 IN..... NONRESET CNTR
6,217 IN..... RESET CNTR1
6,217 IN..... RESET CNTR2
15,790 CM..... NONRESET CNTR
15,790 CM..... RESET CNTR1
15,790 CM..... RESET CNTR2
  
```

or use the SGD command *rfid.position.program* on page 135.

- At the end of calibration, a results table is returned to the host. Each line in the results table appears as:

Row, Read Result, Write Result

where

Row = the millimeter where calibration occurred

Read Result = results of calibration (R = read, " " = unable to read)

Write Result = results of calibration (W = write, " " = unable to write)

The programming position is indicated in dot rows.



Example • If the following command is sent to the printer:

```
^XA^HR^XZ
```

The printer starts the transponder calibration and returns a results table such as the following:

```
start
position=480
82, ,
80, ,
79, ,
.
.
.
56,R,
55,R,W
54,R,W
53,R,W
52,R,W
51,R,W
50,R,W
49,R,W
48,R,W
47,R,W
46,R,W
45,R,W
44,R,W
43,R,W
42,R,W
41,R,W
40,R,W <---***** 480 dots
39,R,W
38,R,W
37,R,W
36,R,W
35,R,W
34,R,W
33,R,W
32,R,W
31,R,W
30,R,W
29,R,W
28,R,W
27,R,W
26,R,W
25,R,W
24,R,W
23,R,
22, ,
21, ,
.
.
.
end
```

In this example, performed on a 300 dpi printer, the optimal programming position is at 40 mm or 480 dot rows. This is identified at the top of the table (`position=480`) and with an arrow (`<---*****`) in the table.

^HV

Host Verification

Description Use this command to return data from specified fields, along with an optional ASCII header, to the host computer. You can use this command with any field that has been assigned a number with the ^RT command or the ^FN and ^RF commands.

Format ^HV# , n , h , t , a

This table identifies the parameters for this format:

Parameters	Details
# = field number specified with another command	The value assigned to this parameter should be the same as the one used in another command. <i>Accepted Values:</i> 0 to 9999 <i>Default Value:</i> 0
n = number of bytes to be returned	<i>Accepted Values:</i> 1 to 256 <i>Default Value:</i> 64
h = header to be returned with the data	Delimiter characters terminate the string. This field is Field Hex (^FH) capable. <i>Accepted Values:</i> 0 to 3072 bytes <i>Default Value:</i> no header
t = termination	This field is Field Hex (^FH) capable. <i>Accepted Values:</i> 0 to 3072 characters
a = command applies to	When ^PQ is greater than 1, send one response for a label format or one for every label printed. <i>Accepted Values:</i> F = Format L = Label <i>Default Value:</i> F



Example • The following code:

```
^XA
.
.
.
^FH_ ^HV0 , 8 , EPC [ , ] _0D_0A , L ^FS
^PQ2
^XZ
```

Would return data such as this:

```
EPC[ 12345678 ]
EPC[ 55554444 ]
```



Print Mode

Description The ^MM command determines the action the printer takes after a label or group of labels has printed.

Format ^MMa , b

This table identifies the parameters for this format:

Parameters	Details
a = desired mode	<p><i>Accepted Values:</i></p> <ul style="list-style-type: none"> T = Tear-off P = Peel-off (not available on S-300) R = Rewind (depends on printer model) A = Applicator (depends on printer model) C = Cutter (depends on printer model) D = Delayed cutter (depends on printer model) F = RFID (not valid on the RP4T) <p><i>Default Value:</i></p> <p>The values available for parameter a depend on the printer being used and whether it supports the option.</p> <p>For supported RFID printers, the defaults are as follows:</p> <ul style="list-style-type: none"> A = R110PAX4 print engines F = other RFID printers
b = prepeel select	<p><i>Accepted Values:</i></p> <ul style="list-style-type: none"> N = no Y = yes <p><i>Default Value:</i> N</p> <p>The command is ignored if parameters are missing or invalid. The current value of the command remains unchanged.</p>

This list identifies the different modes of operation:

- Tear-off — after printing, the label advances so the web is over the tear bar. The label, with liner attached, can be torn off manually.

- Peel-off — after printing, the label moves forward and activates a Label Available Sensor. Printing stops until the label is manually removed from the printer.

Power Peel – liner automatically rewinds using an optional internal rewind spindle.

Value Peel – liner feeds down the front of the printer and is manually removed.

Prepeel – after each label is manually removed, the printer feeds the next label forward to prepeel a small portion of the label away from the liner material. The printer then backfeeds and prints the label. The prepeel feature assists in the proper peel operation of some media types.

- Rewind — the label and backing are rewound on an (optional) external rewind device. The next label is positioned under the printhead (no backfeed motion).
- Applicator — when used with an application device, the label move far enough forward to be removed by the applicator and applied to an item.
- Cutter — after printing, the media feeds forward and is automatically cut into predetermined lengths.
- Delayed cutter — When the printer is in the Delayed Cut PRINT MODE, it will cut the label when it receives the ~JK (Delayed Cut) command. To activate the ~JK command, the printer's PRINT MODE must be set to Delayed Cut and there must be a label waiting to be cut. When the printer is not in the Delayed Cut PRINT MODE, the printer will not cut the label when it receives the ~JK command.

The Delayed Cut feature can be activated:

- through PRINT MODE on the printer's control panel
- with a ^MMD command
- RFID — increases throughput time when printing batches of RFID labels by eliminating backfeed between labels.

Comments Be sure to select the appropriate value for the print mode being used to avoid unexpected results.

^RA**Read AFI or DSFID Byte**

Important • This command is not supported by all printers or firmware. See [Printer and Firmware Compatibility](#) on page 82 for the list of printers and firmware with which you can use this command.

Description Use this command to read the AFI or DSFID byte. The data can be returned to the host via the ^HV command.

Format ^RA#,f,r,m,b

This table identifies the parameters for this format.

Parameters	Details
# = field number specified with another command	The value assigned to this parameter should be the same as the one used in the ^RT command. <i>Accepted values:</i> 0 to 9999 <i>Default value:</i> 0
f = format	<i>Accepted values:</i> 0 = ASCII 1 = Hexadecimal <i>Default value:</i> 0
r = number of retries	<i>Accepted values:</i> 0 to 10 <i>Default value:</i> 0
m = motion	<i>Accepted values:</i> 0 = Feed label after writing. 1 = No Feed after writing. Other ZPL may cause a feed. <i>Default value:</i> 0
b = type of byte to read	<i>Accepted values:</i> A = AFI byte D = DSFID byte <i>Default value:</i> A



Example 1 • This example reads the AFI byte in ASCII format and returns AFI Byte: x to the host. The printer will retry the command five times if necessary. A voided label is generated if the read is unsuccessful after these retries. The data read will go into the ^FN1 location of the recalled format.

```
^XA
^FO20,120^A0N,60^FN1^FS
^RA1,0,5,0^FS
^HV1,,AFI Byte:^FS
^XZ
```



Example 2 • This example reads the DSFID byte in ASCII format and returns DSFID Byte :x to the host. The printer will retry the command three times if necessary. A voided label is generated if the read is unsuccessful after these retries. The data read will go into the ^FN1 location of the recalled format.

```
^XA  
^FO20,120^A0N,60^FN1^FS  
^RA1,0,3,0,D^FS  
^HV1,,DSFID Byte:^FS  
^XZ
```

^RB

Define EPC Data Structure



Important • This command is not supported by all printers or firmware. See *Printer and Firmware Compatibility* on page 82 for the list of printers and firmware with which you can use this command.

Description Use this command to define the structure of EPC data, which can be read from or written to an RFID transponder. For more information about EPC specifications, refer to the EPC Global web site. All parameters in this command are persistent and will be used in subsequent formats if not provided. The values are initially set to the default values.

RFID transponders can have different partitions defined. This command specifies the number of partitions and how many bits are in each partition.

Format ^RBn,p0,p1,p2, . . . , p15

This table identifies the parameters for this format.

Parameters	Details
n = total bit size of the partitions	Specify the number of bits to include in the partitions. <i>Accepted values:</i> 1 to n, where n is the bit size of the tag. <i>Default value:</i> 96
p0 . . . p15 = partition sizes	Specify the number of bits to include in the individual partitions. The partition sizes must add up to the bit size specified for the previous parameter. The largest individual partition size is 64 bits. <i>Accepted values:</i> 1 to 64 <i>Default value:</i> 1



Example 1 • The following command specifies that there are 96 bits used with three fields. Fields 0, 1, and 2 contain 10, 26, and 60 bits, respectively.

```
^RB96,10,26,60
```

The ZPL code to encode a tag with this format would look like this:

```
^RFW,E^FD1000.67108000.1122921504606846976^FS
```

When the tag is being encoded, the tag stores the data in the following way:

- Field 0 contains 1000. This value is stored in the first 10 bits
- Field 1 contains 67108000. This value is stored in the next 26 bits.
- Field 2 contains 1122921504606846976. This value is stored in the remaining 60 bits.

➔ **Example 2** •The following command specifies that there are 64 bits used with eight 8-bit fields.

```
^RB64,8,8,8,8,8,8,8,8^FS
```

The ZPL code to encode a tag with this format would look like this:

```
^RFW,E^FD1.123.160.200.249.6.1.0^FS
```

When writing to the tag, each set of data is written in its respective 8-bit field.

➔ **Example 3** •This example uses the SGTIN-64 standard, which defines 64-bit structure in the following way:

	Header	Filter Value	Company Prefix Index	Item Reference	Serial Number
SGTIN-64	2 bits	3 bits	14 bits	20 bits	25 bits
	10 (binary value)	8 (decimal capacity)	16,383 (decimal capacity)	9 to 1,048,575 (decimal capacity*)	33,554,431 (decimal capacity)

* Capacity of Item Reference field varies with the length of the company prefix.

The ZPL code to encode a tag with this format would look like this:

```
^XA
^RB64,2,3,14,20,25
^RFW,E^FD0,3,12345,544332,22335221^FS
^XZ
```

These commands would put

- 0 in the header
- 3 as the filter value
- 12345 as the company prefix
- 544332 as the item reference
- 22335221 as the serial number

To read this EPC data and print the results on the label, you would use the following code:

```
^XA
^RB64,2,3,14,20,25
^FO50,50^A0N,40^FN0^FS
^FN0^RFR,E^FS
^XZ
```

The resulting label would look like this:

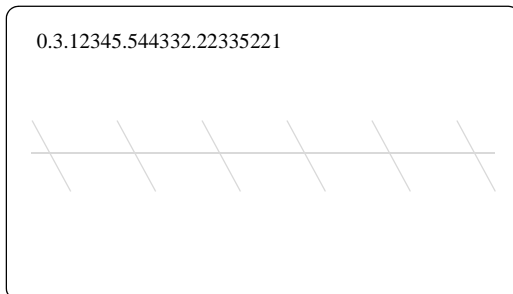

^RE

Enable/Disable E.A.S. Bit



Important • This command is not supported by all printers or firmware. See [Printer and Firmware Compatibility](#) on page 82 for the list of printers and firmware with which you can use this command.

Description Use this command to enable or disable the Electronic Article Surveillance (E.A.S.) bit that is available in some ISO15693 tags (such as Philips). This command works only on those ISO15693 transponders and will be ignored if the tag does not support E.A.S.

Format ^REt , r

The following table identifies the parameters for this format.

Parameters	Details
t = Enable/disable the E.A.S. bit in the ISO15693 transponder	<i>Accepted values:</i> N = Disable E.A.S. Y = Enable E.A.S. <i>Default value:</i> N
r = number of retries	<i>Accepted values:</i> 0 to 10 <i>Default value:</i> 0



Example • This example enables the E.A.S. bit in the transponder. It will retry the command five times if necessary.

```
^XA
^REy , 5
^XZ
```

^RF

Read or Write RFID Format



Important • This command is not supported by all printers or firmware. See [Printer and Firmware Compatibility on page 82](#) for the list of printers and firmware with which you can use this command.

Description Use this command to read or write to (encode) an RFID tag. When using this command to read a tag, you may use a field variable to print the tag data on the label or to return the data to the host. See [Create and Send an RFID Label Format on page 30](#) for examples that use a field variable.

Format ^RF \circ, f, b, n, m

This table identifies the parameters for this format.

Parameters	Details
o = operation	<p>Specifies the action to be performed.</p> <p><i>Accepted Values:</i></p> <ul style="list-style-type: none"> W = write to (encode) the tag L = write with LOCK (if supported by tag type; Gen 2 tag type does not use this locking function) R = read the tag P = read password (Gen 2 tag type only) <p><i>Default Value:</i> W</p>
f = format	<p><i>Accepted Values:</i></p> <ul style="list-style-type: none"> A = ASCII H = Hexadecimal E = EPC (ensure proper setup with the ^RB command) <p><i>Default Value:</i> H</p>

Parameters	Details
<p>b = starting block number</p>	<p>For tag types other Gen 2: Specifies the starting block number. <i>Accepted Values:</i> 0 to <i>n</i>, where <i>n</i> is the maximum number of blocks for the tag. <i>Default Value:</i> 0</p> <p>For Gen 2 tag type only: What you specify for this parameter depends on what you entered for the operation parameter.</p> <ul style="list-style-type: none"> • When W, L, or R are specified for the operation parameter, this parameter specifies a 16-bit word block number. <i>Accepted Values:</i> 0 to <i>n</i>, where <i>n</i> is the maximum number of blocks for the bank specified in the memory bank parameter <i>Default Value:</i> 0 • When P is specified for the operation parameter, this parameter specifies which password to read. <i>Accepted Values:</i> K = kill password A = access password <i>Default Value:</i> K
<p>n = number of bytes to read or write</p>	<p>Specifies the number of bytes to read or write.</p> <p>For high-frequency (HF) printers: <i>Accepted Values:</i> 1 to <i>n</i>, where <i>n</i> is the maximum number of bytes for the tag. <i>Default Value:</i> 1</p> <p>For Gen 2 tag type only: When E is specified for the memory bank parameter, this value is not required. <i>Accepted Values:</i> 1 to <i>n</i>, where <i>n</i> is the maximum number of bytes for the tag. <i>Default Value:</i> 1</p> <p>For all other printers and tag types: This parameter applies only when the starting block number is 1. <i>Accepted Values:</i> 1 to <i>n</i>, where <i>n</i> is the maximum number of bytes for the tag. For UCODE EPC 1.19, <i>n</i> is 32. <i>Default Value:</i> 1</p>

Parameters	Details
m = memory bank	 <p>Note • This parameter applies to Gen 2 tags only.</p> <p>Specifies the Gen 2 memory bank. See Gen 2 Memory Map on page 46 for more information about Gen 2 memory.</p> <p><i>Accepted Values:</i></p> <ul style="list-style-type: none"> E = EPC 96-bit (command automatically performs operation on Gen 2 bit address 20_h and accesses 12 bytes of the EPC memory bank) 0 = Reserved 1 = EPC 2 = TID (Tag ID) 3 = User <p><i>Default Value:</i> E</p>

➔ **Example 1** • This example encodes 96-bit data in ASCII format.

```
^XA
^RS4
^RFw,a^FD00 my data^FS
^XZ
```

➔ **Example 2** • This example encodes 64-bit data in hexadecimal format.

```
^XA
^RS3
^RFw,H^FD1122334455667788^FS
^XZ
```

➔ **Example 3** • This example encodes 96-bit EPC data, as specified by the ^RB command.

```
^XA
^RB96,8,3,3,20,24,38
^RFw,e^FD16.3.5.78742.146165.1234567891^FS
^XZ
```

➔ **Example 4** • This example encodes 4 bytes of hexadecimal formatted data, starting in block 3 of Gen 2 EPC bank 1.

```
^XA
^RS8
^RFw,H,3,4,1^FD11112222^FS
^XZ
```



Example 5 • This example reads the extended Gen 2 tag ID (TID), which is not read by the ^RI command, and returns the results to the host computer. The results are labeled with the header “8-byte Tag ID Data.”

```
^XA  
^RS8  
^RFR,H,0,8,2^FN1^FS^HV1,,8-byte Tag ID Data:^FS  
^XZ
```

^RI

Get RFID Tag ID



Important • This command is not supported by all printers or firmware. See *Printer and Firmware Compatibility* on page 82 for the list of printers and firmware with which you can use this command.

Description Use this command to get the unique serial number of the tag and return it in hexadecimal format. The data can be sent back to the host via the ^HV command.

For Gen 2 tag types, this command will return the 32-bit tag ID (TID) for the tag. If your Gen 2 tag supports TID data beyond 32 bits, see ^RF on page 96 to access the TID memory bank.

Format ^RI#,s,r,m

This table identifies the parameters for this format.

Parameters	Details
# = number to be assigned to the field	<i>Accepted values:</i> 0 to 9999 <i>Default value:</i> 0
s = specify data order	 Note • This parameter applies only to the R110Xi HF and R2844-Z printers. <i>Accepted values:</i> <i>Accepted Values:</i> 0 = Most significant byte first for Tag*It and PicoTag. Least significant byte first for I*code and ISO15693. 1 = Reverse the data order <i>Default value:</i> 0
r = number of retries	<i>Accepted values:</i> 0 to 10 <i>Default value:</i> 0
m = motion	<i>Accepted values:</i> 0 = Feed label after writing 1 = No Feed after writing (other ZPL commands may cause a feed) <i>Default value:</i> 0



Example • This example reads a tag ID, prints it on a label, and sends string Tag ID:xxxxxxxx to the host. The data read will go into the ^FN0 location of the format. The printer will retry the command five times, if necessary.

```

^XA
^FO20,120^A0N,60^FN0^FS
^RI0,,5^FS
^HV0,,Tag ID:^FS
^XZ
    
```

^RM**Enable RFID Motion**

Important • This command is not supported by all printers or firmware. See [Printer and Firmware Compatibility](#) on page 82 for the list of printers and firmware with which you can use this command.

Description Use this command to enable or disable RFID motion. By default, labels automatically print at the end of the format. This command allows you to inhibit the label from actually moving when it reaches the program position, which is useful for debugging, setup, and custom applications. This parameter is not persistent (carried over from label to label).

Format ^RM`e`

This table identifies the parameters for this format.

Parameters	Details
e = enable	<i>Accepted values:</i> Y = Yes, move the label N = No, do not move the label <i>Default value:</i> Y

^RN

Detect Multiple RFID Tags in Encoding Field



Important • This command is not supported by all printers or firmware. See [Printer and Firmware Compatibility](#) on page 82 for the list of printers and firmware with which you can use this command.

Description Use this command to enable or disable detection of multiple RFID tags in the encoding field. By default, the printer checks for more than one tag in the field before attempting to read or write. If more than one tag is found, the label over the antenna support is voided, and the **RFID ERR STATUS** parameter on the control panel displays **MULTIPLE TAGS**. To speed up printing and encoding by up to 200 ms, the check may be disabled. This parameter is persistent (carried over from label to label).

Format ^RNe

The following table identifies the parameters for this format.

Parameters	Details
e = enable	<p><i>Accepted Values:</i></p> <p>Y = Yes, check for multiple tags</p> <p>N = No, do not check for multiple tags</p> <p><i>Default Value:</i> Y</p>

~RO

Reset Advanced Counters



Important • This command is not supported by all printers or firmware. See [Printer and Firmware Compatibility](#) on page 82 for the list of printers and firmware with which you can use this command.

Description The ~RO command resets the advanced counters used by the printer to monitor label generation in inches, centimeters, and number of labels.



Note • For the R4Mplus, the counter values are not saved, so power cycling the printer resets all counters to zero.

Format ~ROc

This table identifies the parameters for this format:

Parameters	Details
c = counter number	<p><i>Accepted Values:</i></p> <ul style="list-style-type: none"> 1 = reset counter 1 2 = reset counter 2 3 = reset valid RFID label counter 4 = reset voided RFID label counter R = reset head replaced counter (R resets the head cleaned counter and the head replaced counter.) C = reset head cleaned counter <p><i>Default Value:</i> a value must be specified or the command is ignored</p>



Example 1 • This example shows how the counter portion of the printer configuration labels looks when counter 1 is reset by sending ~RO1.

Before

```

→ 296862 IN..... NONRESET CNTR
→ 296862 IN..... RESET CNTR1
→ 296862 IN..... RESET CNTR2
→ 753289 CM..... NONRESET CNTR
→ 753289 CM..... RESET CNTR1
→ 753289 CM..... RESET CNTR2
→ 92928 LABLS..... NONRESET CNTR
→ 92928 LABLS..... RESET CNTR1
→ 92928 LABLS..... RESET CNTR2
    
```

After

```

→ 296876 IN..... NONRESET CNTR
→ 0 IN..... RESET CNTR1
→ 296876 IN..... RESET CNTR2
→ 753323 CM..... NONRESET CNTR
→ 0 CM..... RESET CNTR1
→ 753323 CM..... RESET CNTR2
→ 92930 LABLS..... NONRESET CNTR
→ 0 LABLS..... RESET CNTR1
→ 92930 LABLS..... RESET CNTR2
    
```



Example 2 • This example shows how the counter portion of the printer configuration labels looks when the RFID counters are reset by sending ~RO3 and ~RO4.

Before

```
02/10/05..... RTC DATE
07:21..... RTC TIME
507..... RFID VALID CTR
4..... RFID VOID CTR
HIGH..... RFID READ PWR
HIGH..... RFID WRITE PWR
RFID OK..... RFID ERR STATUS
Class 0..... RFID TAG TYPE
TM: 20050201..... RFID VERSION
1950 IN..... NONRESET CNTR
1950 IN..... RESET CNTR1
1950 IN..... RESET CNTR2
```

After

```
02/10/05..... RTC DATE
07:21..... RTC TIME
0..... RFID VALID CTR
0..... RFID VOID CTR
HIGH..... RFID READ PWR
HIGH..... RFID WRITE PWR
RFID OK..... RFID ERR STATUS
Class 0..... RFID TAG TYPE
TM: 20050201..... RFID VERSION
1951 IN..... NONRESET CNTR
1951 IN..... RESET CNTR1
1951 IN..... RESET CNTR2
```

[^]RQ

Quick Write EPC Data and Passwords



Important • This command is not supported by all RFID tags, printers, or firmware. See *Printer and Firmware Compatibility* on page 82 for the list of printers and firmware with which you can use this command.

Description Use this command with an Alien Higgs RFID tag and appropriate firmware to write the EPC data, access password, and kill password with one command. Doing so reduces the encoding time.



Note • The access password on the tag to be written to must be 00000000 prior to sending this command.

Format [^]RQf,c,o[data]

The following table identifies the parameters for this format.

Parameters	Details
f = format	<p><i>Accepted Values:</i></p> <ul style="list-style-type: none"> A = ASCII H = Hexadecimal E = EPC <p><i>Default Value:</i> H</p>
c = chip type	<p><i>Accepted Values:</i> 0 (Higgs IC tag)</p> <p><i>Default Value:</i> 0</p>
o = option	<p><i>Accepted Values:</i> 0 (write 96-bit EPC)</p> <p><i>Default Value:</i> 0</p>
data = the EPC data, access password, and kill password	<p>Use the [^]FD command to specify the passwords in the following format:</p> <p style="text-align: center;">[^]FD[EPC],[access],[kill]</p> <p>where:</p> <ul style="list-style-type: none"> EPC = the EPC data in the format specified by the f parameter. The data should match what would be programmed with the [^]RF command. access = an optional access password in hexadecimal format. If this field is left blank, 0x00000000 is written as the access password. kill = an optional kill password in hexadecimal format. If this field is left blank, 0x00000000 is written as the kill password.

→ **Example 1** • This example writes the EPC data to the tag in hexadecimal format. The unspecified access and kill passwords are written as zeroes (0x00000000).

```
^XA^RQ^FD112233445566778899001122^XZ
```

→ **Example 2** • This example writes the EPC data to the tag in hexadecimal format. The access password is written as 0xAAAAAAAA, and the kill password is written as 0xBBBBBBBB.

```
^XA^RQ^FD112233445566778899001122,AAAAAAAA,BBBBBBBB^XZ
```

→ **Example 3** • This example writes the EPC data to the tag in EPC format. The unspecified access and kill passwords are written as zeroes (0x00000000).

```
^XA^RB96,30,30,30,6^RQE^FD1234.5678.9012.12^XZ
```

→ **Example 4** • This example writes the EPC data to the tag in hexadecimal format. The access password is written as 0xAAAAAAAA, and the unspecified kill password is written as zeroes (0x00000000).

```
^XA^RB96,30,30,30,6^RQE^FD1234.5678.9012.12,AAAAAAAA^XZ
```

^RR

Specify RFID Retries for a Block



Important • This command is not supported by all printers or firmware. See [Printer and Firmware Compatibility on page 82](#) for the list of printers and firmware with which you can use this command.

Description Use this command to change the number of times that the printer attempts to read or write to a particular block of a single RFID tag. By default, the printer will attempt six retries. This command is persistent and will be used in subsequent formats if not provided.



Note • This command's function is different than the “number of labels” parameter in the ^RS command.

Format ^RRn

This table identifies the parameters for this format.

Parameters	Details
n = number of retries	<i>Accepted Values:</i> 0 to 10 <i>Default Value:</i> 0



Example 1 • This example sets read block retries to 5.

```

^XA
^FN1^RR5^RFR,H^FS
^HV1^FS
^XZ

```



Example 2 • This example sets write block retries to 2.

```

^XA
^RR2^RFW,H^FD1234^FS
^XZ

```

^RS

Set Up RFID Parameters

Description Use this command to set up RFID parameters including tag type, read/write position of the transponder, and error handling.







Important • Use care when using this command in combination with ^RT or ^RF for reading tag data. Problems can occur if the data read from the tag is going to be printed on the label. Any data read from the transponder must be positioned to be printed above the read/write position. Failure to do this will prevent read data from being printed on the label.

Format ^RSt ,p,v,n,e,a,c,s

This table identifies the parameters for this format.

Parameters	Details
t = tag type	<p>Tells the printer/print engine which tag type you are using. If you specify a tag type that is not supported by your printer or firmware, the printer uses its default value. For the supported tag types and defaults, see Table 9 on page 111.</p> <p>UHF Printers</p> <ul style="list-style-type: none"> 0 = None 1 = EPC Class 0 2 = EPC Class 0 Plus 3 = EPC Class 1 64-bit 4 = EPC Class 1 96-bit 5 = UCODE EPC 1.19 6 = Impinj Class 0 Plus 7 = ISO 18000-06A 8 = EPC Class 1, Generation 2 (Gen 2) 9 = ISO 18000-06B <p>HF Printers</p> <p> Note • Only the R110Xi HF printer (firmware version R65.X.X) supports the use of letters for this parameter. All other printers use the numbers.</p> <ul style="list-style-type: none"> A or 0 = None B or 1 = Auto detect (query tag to determine) C or 2 = Tag*It (Texas Instruments Tagit tags) D or 3 = I*code (Phillips Icode tags) E or 4 = Pico Tag (Inside Technology's) F or 5 = ISO 15693 G or 6 = EPC tag (13.56 MHz) H or 7 = UID Tag I or 8 = Mifare UltraLight

Parameters	Details
<p>p = read/write position of the transponder</p>	<p>Sets the read/write position of the transponder in vertical (Y axis) dot rows from the top of the label. Set to 0 (no movement) if the transponder is already in the effective area without moving the media.</p> <p> Important • If a label format specifies a value for this parameter, this value will be used for the programming position for all labels until a new position is specified or until the printer is turned off (O) and then back on (I).</p> <p><i>Accepted values:</i> 0 to label length <i>Default value:</i> For the R110PAX4 and R2844-Z: 0 For all other supported printers: label length minus 1 mm (1/16 in.)</p>
<p>v = length of void printout</p>	<p>Sets the length of the void printout in vertical (Y axis) dot rows.</p> <p><i>Accepted values:</i> 0 to label length <i>Default value:</i> label length</p>
<p>n = number of labels</p>	<p>The number of labels that will be attempted in case of read/encode failure.</p> <p><i>Accepted values:</i> 1 to 10 <i>Default value:</i> 3</p>
<p>e = error handling</p>	<p>If an error persists after the specified number of labels are tried, perform this error handling action.</p> <p><i>Accepted values:</i></p> <ul style="list-style-type: none"> N = No action (printer drops the label format causing the error and moves to the next queued label) P = Place printer in Pause mode (label format stays in the queue until the user cancels) E = Place printer in Error mode (label format stays in the queue until the user cancels) <p><i>Default value:</i> N</p> <p> Note • You can set the printer to send an error message to the host for each failure. To enable or disable this unsolicited error message, refer to the [^]SX and [^]SQ ZPL commands. Use V for the condition type for an RFID error.</p>

Parameters	Details
<p>a = signals on applicator</p>	<p> Note • This parameter does not apply to the R2844-Z. For the R4Mplus, this parameter applies only to printers with firmware version SP994X (R4Mplus European version).</p> <p>When the value for parameter p (read/write position of the transponder) is nonzero, this parameter changes the number of start and stop print signals required for printing.</p> <p>In Single mode, one start print command is required. In Double mode, two are required, so the printer will resume printing only after the second start print command is received. For more information, see Timing Diagrams for RFID on page 150.</p> <p><i>Accepted values:</i></p> <ul style="list-style-type: none"> S = single signal D = double signal (For the R110PAX4, Double mode will work only if the read/write position is changed from the default of zero.) <p><i>Default value:</i> S</p>
<p>c = certify tag with a pre-read</p>	<p>Not applicable.</p>
<p>s = void print speed</p>	<p> Note • This parameter does not apply to the R2844-Z. For the R4Mplus, this parameter applies only to printers with firmware version SP994X (R4Mplus European version).</p> <p>If a label is voided, the speed at which “VOID” will be printed across the label.</p> <p><i>Accepted values:</i> any valid print speed</p> <p><i>Default value:</i> the printer’s maximum print speed</p>

Supported Tag Types Table 9 shows the tag types supported by different RFID printers/print engines and firmware versions. Depending on your country or on the firmware version that you are using, your printer may not support all of the tag types listed. If you specify an unsupported tag type, the printer uses the default value. If a tag type is shown as supported but does not work with your printer, you may need to upgrade the printer’s firmware (see <http://www.zebra.com/firmware>).

Table 9 • Supported Tag Types and Default Values

Printer	UHF Printers													HF Printers		
	R110Xi/R170Xi			R110PAX4				R4Mplus				RZ400/RZ600	RP4T	R110Xi/HF	R2844-Z	
Firmware Version	R60.13.X	R60.15.8Z and R60.16.4Z	R60.16.5Z and later	R62.13.X	R62.15.X and later	R63.13.X	R63.15.X and later	SP994O, SP999E, SP1027E, SP1082E, and earlier	SP994P, SP999F, SP1027F, SP1082F, and later	SP1056D and earlier	SP1056E and later	R53.16.X and later	all	R65.13.X	R65.15.X and later	all
Tag Type																
UHF Tag Types and Options																
None (no tag type specified)	*	*	* a	*	*	—	—	—	—	—	—	—	—	—	—	—
EPC Class 0	*	*	* a	*	*	—	—	—	—	—	—	—	—	—	—	—
EPC Class 0 Plus	*	*	* a	*	*	—	—	—	—	—	—	—	—	—	—	—
EPC Class 1 64-bit	*	*	* a	*	*	—	—	—	—	—	—	—	—	—	—	—
EPC Class 1 96-bit	#	*	* a	#	*	—	*	*	*	—	—	—	—	—	—	—
UCODE EPC 1.19	* b	*	* a	—	*	#	*	#	*	#	*	—	—	—	—	—
Impinj Class 0 Plus	*	*	* a	*	*	—	—	—	—	—	—	—	—	—	—	—
ISO 18000-06A	—	—	—	*	—	—	*	*	*	—	—	—	—	—	—	—
EPC Class 1, Generation 2 (Gen 2)	*	#	#	*	#	—	#	*	#	*	#	#	#	—	—	—
ISO 18000-06B	*	*	* a	*	*	—	*	*	*	*	*	—	—	—	—	—
HF Tag Types and Options																
Auto-detect the tag type by querying the tag	—	—	—	—	—	—	—	—	—	—	—	—	—	—	—	#
Tag*It (Texas Instruments Tagit tags)	—	—	—	—	—	—	—	—	—	—	—	—	—	—	—	*
I*code (Phillips Icode tags)	—	—	—	—	—	—	—	—	—	—	—	—	—	—	—	*
Pico Tag (Inside Technology’s)	—	—	—	—	—	—	—	—	—	—	—	—	—	—	—	*
ISO 15693	—	—	—	—	—	—	—	—	—	—	—	—	—	#	#	*

= Default value * = Accepted value — = Not supported

- a. Requires printers with RFID hardware version M4xxx...x. This will not work with RFID hardware version M5xxx...x. For the RFID hardware version, refer to the RFID HW VER line on your printer configuration label, or perform the RFID SLOW test (see [Perform RFID Test on page 22](#)).
- b. Requires R60.13.0.13ZD or later.

Table 9 • Supported Tag Types and Default Values (Continued)

Printer	UHF Printers												HF Printers			
	R110Xi R170Xi			R110PAX4			R4Mplus			RZ400/RZ600	RP4T	R110Xi/HF	R2844-Z			
Firmware Version	R60.13.X	R60.15.8Z and R60.16.4Z	R60.16.5Z and later	R62.13.X	R62.15.X and later	R63.13.X	R63.15.X and later	SP994O, SP999E, SP1027E, SP1082E, and earlier	SP994P, SP999F, SP1027F, SP1082F, and later	SP1056D and earlier	SP1056E and later	R53.16.X and later	all	R65.13.X	R65.15.X and later	all
Tag Type																
EPC tag	—	—	—	—	—	—	—	—	—	—	—	—	—	—	—	*
UID Tag	—	—	—	—	—	—	—	—	—	—	—	—	—	—	—	—
Mifare UltraLight	—	—	—	—	—	—	—	—	—	—	—	—	—	*	*	—

= Default value * = Accepted value — = Not supported

- a. Requires printers with RFID hardware version M4xxx...x. This will not work with RFID hardware version M5xxx...x. For the RFID hardware version, refer to the RFID HW VER line on your printer configuration label, or perform the RFID SLOW test (see [Perform RFID Test on page 22](#)).
- b. Requires R60.13.0.13ZD or later.



Example 1 • This example sets the printer to move the media to 800 dots from the top of the media [or label length minus 800 from the bottom (leading edge) of the media] and voids the rest of the media in case of an error. The printer will try to print two labels and then will pause if printing and encoding fail.

```

^XA
^RS,800,,2,P^FS
^XZ
    
```

Figure 7 shows the resulting voided label. Note where the void starts. The media has been moved 800 dot rows from the top of the label (label length minus 800 dot rows from the bottom (leading edge) of a label) to bring the transponder into the effective area to read/write a tag. If the printer fails the operation, the rest of the media is voided.

Figure 7 • Sample Void Label, Remainder of Label Voided

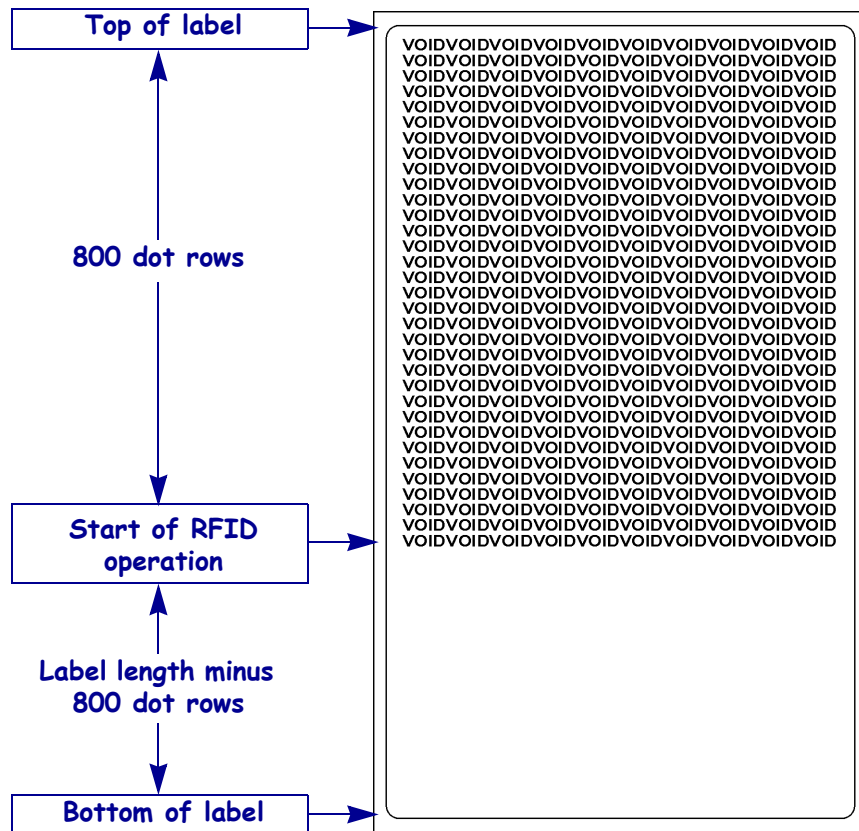



Example 2 • This example sets the printer to move the media to 800 dots from the top of the media [or label length - 500 from the bottom (leading edge) of the media] and prints “VOID” 500 dots in vertical length (Y axis) in case of an error.

```

^XA
^RS, 800, 500, 2, P^FS
^XZ
    
```

Figure 8 shows the resulting voided label. Note where the void starts. The media has been moved 800 dot rows from the top of the label [label length minus 800 dot rows from the bottom (leading edge) of a label] to bring the transponder into the effective area to read/write a tag. If the printer fails the operation, an area that is 500 dot rows of the media is voided instead of the entire rest of the media.

Figure 8 • Sample Void Label, 500 Dot Row Area Voided

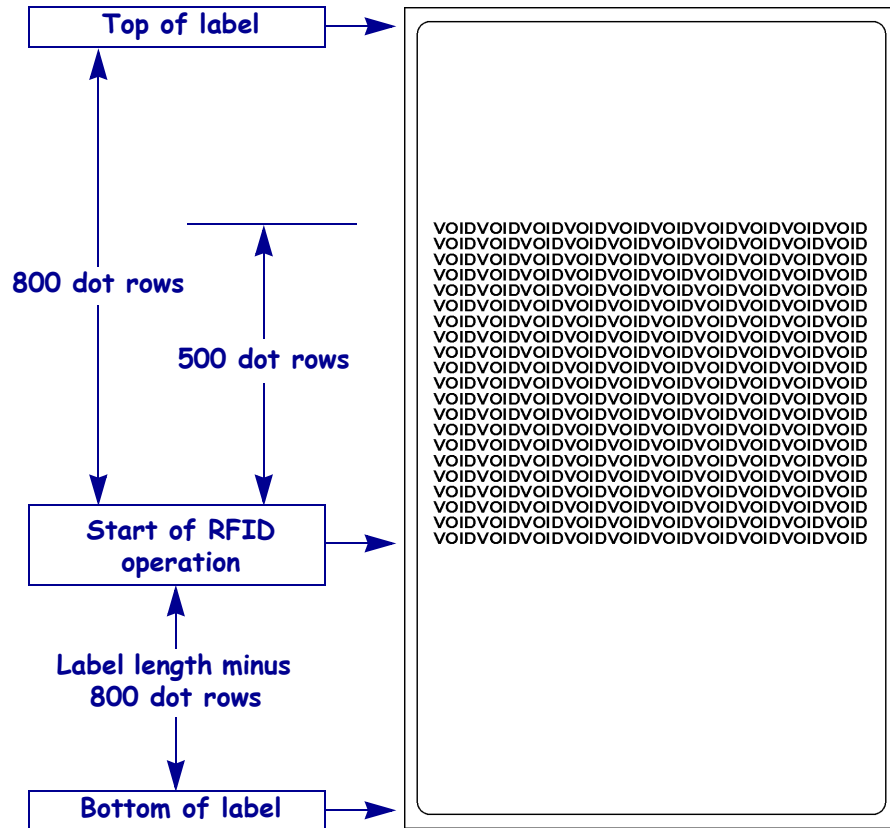

^RT

Read RFID Tag



Note • The ^RT command is provided only for backward-compatibility with label formats that were developed for older Zebra RFID printers. Use ^RF on page 96 instead whenever possible. See *Printer and Firmware Compatibility* on page 82 for the list of printers and firmware with which you can use this command.

Description Use this command to tell the printer to read the current RFID tag data. The data can be returned to the host via the ^HV command.

Format ^RT#,b,n,f,r,m,s

This table identifies the parameters for this format.

Parameters	Details
# = number to be assigned to the field	<i>Accepted values:</i> 0 to 9999 <i>Default value:</i> 0
b = starting block number	<i>Accepted values:</i> 0 to <i>n</i> , where <i>n</i> is the maximum number of blocks for the tag. <i>Default value:</i> 0
n = number of blocks/bytes to read	For R4Mplus printers with firmware version SP994X (European version): This parameter applies only when the starting block number (parameter b) is 1. <i>Accepted values:</i> 1 to <i>n</i> , where <i>n</i> is the maximum number of bytes for the tag. For UCODE EPC 1.19, <i>n</i> is 32. <i>Default value:</i> 1 For all other supported printers: <i>Accepted values:</i> 1 to <i>n</i> , where <i>n</i> is the maximum number of blocks for the tag type minus the starting block number. For example, if the tag has 8 blocks (starting with block 0) and you start with block 6, <i>n</i> can be 2. This would return block 6 and block 7 information. <i>Default value:</i> 1
f = format	<i>Accepted values:</i> 0 = ASCII 1 = Hexadecimal <i>Default value:</i> 0
r = number of retries	Changes the number of times that the printer attempts to read a particular block of a single RFID tag. (Same retry rules as the ^RR command.) <i>Accepted values:</i> 0 to 10 <i>Default value:</i> 0

Parameters	Details
m = motion	<p>Enables or disables RFID motion for the current field.</p> <p><i>Accepted values:</i></p> <p>0 = Feed label after writing.</p> <p>1 = No feed after writing. Other ZPL may cause a feed.</p> <p><i>Default value:</i> 0</p>
s = special mode	<p> Note • This parameter is used only for the printers referenced here.</p> <p>For R110Xi HF and R2844-Z printers:</p> <p>Specify data order.</p> <p><i>Default value:</i> 0</p> <p><i>Accepted values:</i></p> <p>0 = least significant byte first</p> <p>1 = most significant byte first</p>



Example 1 • This example reads a tag, prints the data on a label, and sends the string Tag Data:xxxxxxx back to the host. The data read will go into the ^FN1 location of the format. The printer will retry the command five times, if necessary.

```

^XA
^FO20,120^A0N,60^FN1^FS
^RT1,,,5^FS
^HV1,,Tag Data:^FS
^XZ

```



Example 2 • This example reads from a tag twice and prints the results on a label.

```

^XA
^FO20,120^A0N,60^FN1^FS
^FO20,100^A0N,20^FN2^FS
^RT1,7,3,,5^FS
^RT2,3,2,,5^FS
^XZ

```

The first ^RT command starts at block 7 and reads three blocks of data in ASCII format. The data read will go into the ^FN1 location of the format. The printer will retry the command five times, if necessary.

The second ^RT command starts at block 2 and reads two blocks of data in ASCII format. The data read will go into the ^FN2 location of the format. The printer will retry the command five times, if necessary.

~RV

Report RFID Encoding Results



Important • This command is not supported by all printers or firmware. See [Printer and Firmware Compatibility](#) on page 82 for the list of printers and firmware with which you can use this command.

Description Use this command to tell the printer to send RFID encoding success or failure results to the host computer after each label completes.

Format ~RVa

This table identifies the parameters for this format:

Parameters	Details
a = enable/disable	Enables or disables the results reporting feature. <i>Accepted Values:</i> E = Enable D = Disable <i>Default Value:</i> D



Example 1 • Assume that the following code is sent and that there is no RFID tag in the field.

```
~RVE
^XA
^RS8,0,,3
^RMY
^RFR,H
^XZ
```

The printer attempts to program a tag three times and then returns the following to the host:

```
_-,3_
```

The minus sign indicates that the programming attempt failed entirely and voided three labels.



Example 2 • Assume that the same code is sent and that the first two attempts at programming a tag are unsuccessful. The third attempt succeeds.

```
~RVE
^XA
^RS8,0,,3
^RMY
^RFR,H
^XZ
```

The printer attempts to program a tag three times and then returns the following to the host:

```
_+,2_
```

The plus sign indicates that the programming attempt was successful and voided two labels.

^RW

Set RF Power Levels for Read and Write





Important • This command is not supported by all printers or firmware. See [Printer and Firmware Compatibility on page 82](#) for the list of printers and firmware with which you can use this command.

Description Use this command to set the RFID read and write power levels. This function is useful when using different tag types or transponders that require different power levels to obtain the best read and write abilities. If not enough power is applied, the transponder may not have sufficient power for programming, and tag data will fail to encode. If too much power is applied, the extra power may disable the tag may or cause data communication errors.

Format ^RW*r*,*w*

This table identifies the parameters for this format:

Parameters	Details																																																												
<i>r</i> = read power	<p>Sets the power level to match the desired output as calibrated in the factory.</p> <p> Note • On some printers, the options vary based on the reader. Check the printer configuration label for the RFID_HW_VER line or perform the RFID SLOW test (see Perform RFID Test on page 22) to determine the reader type.</p> <table border="1"> <thead> <tr> <th rowspan="2">Printer</th> <th rowspan="2">Firmware Version</th> <th colspan="2">Selections</th> <th rowspan="2">Default</th> </tr> <tr> <th>H, M, L</th> <th>0–30</th> </tr> </thead> <tbody> <tr> <td rowspan="4">RXi</td> <td>R60.15.8Z and earlier</td> <td>X</td> <td>—</td> <td>L</td> </tr> <tr> <td>R60.16.4Z</td> <td>X</td> <td>X</td> <td>L</td> </tr> <tr> <td>R60.16.5Z and later (M4xxx...x reader)</td> <td>X</td> <td>X</td> <td>L</td> </tr> <tr> <td>R60.16.5Z and later (M5xxx...x reader)</td> <td>—</td> <td>X</td> <td>16</td> </tr> <tr> <td rowspan="2">R4Mplus</td> <td>SP994P, SP999F, SP1027F, SP1056E, SP1082F, and earlier</td> <td>X</td> <td>—</td> <td>L</td> </tr> <tr> <td>SP994Q, SP999G, SP1027G, SP1056F, SP1082G, and later</td> <td>X</td> <td>X</td> <td>L</td> </tr> <tr> <td rowspan="4">R110PAX4</td> <td>R62.15.8Z and earlier</td> <td>X</td> <td>—</td> <td>L</td> </tr> <tr> <td>R62.16.4Z and later</td> <td>X</td> <td>X</td> <td>L</td> </tr> <tr> <td>R63.15.8Z and earlier</td> <td>X</td> <td>—</td> <td>L</td> </tr> <tr> <td>R63.16.4Z and later</td> <td>X</td> <td>X</td> <td>L</td> </tr> <tr> <td>RZx00</td> <td>all versions</td> <td>—</td> <td>X</td> <td>16</td> </tr> <tr> <td>RP4T</td> <td>all versions</td> <td>—</td> <td>X</td> <td>16</td> </tr> </tbody> </table>	Printer	Firmware Version	Selections		Default	H, M, L	0–30	RXi	R60.15.8Z and earlier	X	—	L	R60.16.4Z	X	X	L	R60.16.5Z and later (M4xxx...x reader)	X	X	L	R60.16.5Z and later (M5xxx...x reader)	—	X	16	R4Mplus	SP994P, SP999F, SP1027F, SP1056E, SP1082F, and earlier	X	—	L	SP994Q, SP999G, SP1027G, SP1056F, SP1082G, and later	X	X	L	R110PAX4	R62.15.8Z and earlier	X	—	L	R62.16.4Z and later	X	X	L	R63.15.8Z and earlier	X	—	L	R63.16.4Z and later	X	X	L	RZx00	all versions	—	X	16	RP4T	all versions	—	X	16
Printer	Firmware Version			Selections			Default																																																						
		H, M, L	0–30																																																										
RXi	R60.15.8Z and earlier	X	—	L																																																									
	R60.16.4Z	X	X	L																																																									
	R60.16.5Z and later (M4xxx...x reader)	X	X	L																																																									
	R60.16.5Z and later (M5xxx...x reader)	—	X	16																																																									
R4Mplus	SP994P, SP999F, SP1027F, SP1056E, SP1082F, and earlier	X	—	L																																																									
	SP994Q, SP999G, SP1027G, SP1056F, SP1082G, and later	X	X	L																																																									
R110PAX4	R62.15.8Z and earlier	X	—	L																																																									
	R62.16.4Z and later	X	X	L																																																									
	R63.15.8Z and earlier	X	—	L																																																									
	R63.16.4Z and later	X	X	L																																																									
RZx00	all versions	—	X	16																																																									
RP4T	all versions	—	X	16																																																									

Parameters	Details																																																												
<p>w = write power</p>	<p>Sets the power level to match the desired output as calibrated in the factory.</p> <p> Note •</p> <ul style="list-style-type: none"> This parameter is ignored on the R110Xi HF printer because read and write powers cannot be specified separately. The printer uses the value that you specified for read power for both the read and write power settings. On some printers, the options vary based on the reader. Check the printer configuration label for the RFID_HW_VER line or perform the RFID SLOW test (see Perform RFID Test on page 22) to determine the reader type. <table border="1" data-bbox="727 751 1416 1365"> <thead> <tr> <th rowspan="2">Printer</th> <th rowspan="2">Firmware Version</th> <th colspan="2">Selections</th> <th rowspan="2">Default</th> </tr> <tr> <th>H, M, L</th> <th>0-30</th> </tr> </thead> <tbody> <tr> <td rowspan="4">RXi</td> <td>R60.15.8Z and earlier</td> <td>X</td> <td>—</td> <td>L</td> </tr> <tr> <td>R60.16.4Z</td> <td>X</td> <td>X</td> <td>L</td> </tr> <tr> <td>R60.16.5Z and later (M4xxx...x reader)</td> <td>X</td> <td>X</td> <td>L</td> </tr> <tr> <td>R60.16.5Z and later (M5xxx...x reader)</td> <td>—</td> <td>X</td> <td>16</td> </tr> <tr> <td rowspan="2">R4Mplus</td> <td>SP994P, SP999F, SP1027F, SP1056E, SP1082F, and earlier</td> <td>X</td> <td>—</td> <td>L</td> </tr> <tr> <td>SP994Q, SP999G, SP1027G, SP1056F, SP1082G, and later</td> <td>X</td> <td>X</td> <td>L</td> </tr> <tr> <td rowspan="4">R110PAX4</td> <td>R62.15.8Z and earlier</td> <td>X</td> <td>—</td> <td>L</td> </tr> <tr> <td>R62.16.4Z and later</td> <td>X</td> <td>X</td> <td>L</td> </tr> <tr> <td>R63.15.8Z and earlier</td> <td>X</td> <td>—</td> <td>L</td> </tr> <tr> <td>R63.16.4Z and later</td> <td>X</td> <td>X</td> <td>L</td> </tr> <tr> <td>RZx00</td> <td>all versions</td> <td>—</td> <td>X</td> <td>16</td> </tr> <tr> <td>RP4T</td> <td>all versions</td> <td>—</td> <td>X</td> <td>16</td> </tr> </tbody> </table>	Printer	Firmware Version	Selections		Default	H, M, L	0-30	RXi	R60.15.8Z and earlier	X	—	L	R60.16.4Z	X	X	L	R60.16.5Z and later (M4xxx...x reader)	X	X	L	R60.16.5Z and later (M5xxx...x reader)	—	X	16	R4Mplus	SP994P, SP999F, SP1027F, SP1056E, SP1082F, and earlier	X	—	L	SP994Q, SP999G, SP1027G, SP1056F, SP1082G, and later	X	X	L	R110PAX4	R62.15.8Z and earlier	X	—	L	R62.16.4Z and later	X	X	L	R63.15.8Z and earlier	X	—	L	R63.16.4Z and later	X	X	L	RZx00	all versions	—	X	16	RP4T	all versions	—	X	16
Printer	Firmware Version			Selections			Default																																																						
		H, M, L	0-30																																																										
RXi	R60.15.8Z and earlier	X	—	L																																																									
	R60.16.4Z	X	X	L																																																									
	R60.16.5Z and later (M4xxx...x reader)	X	X	L																																																									
	R60.16.5Z and later (M5xxx...x reader)	—	X	16																																																									
R4Mplus	SP994P, SP999F, SP1027F, SP1056E, SP1082F, and earlier	X	—	L																																																									
	SP994Q, SP999G, SP1027G, SP1056F, SP1082G, and later	X	X	L																																																									
R110PAX4	R62.15.8Z and earlier	X	—	L																																																									
	R62.16.4Z and later	X	X	L																																																									
	R63.15.8Z and earlier	X	—	L																																																									
	R63.16.4Z and later	X	X	L																																																									
RZx00	all versions	—	X	16																																																									
RP4T	all versions	—	X	16																																																									
<p>a = RFID antenna selection</p>	<p> Note • This parameter applies only to the R110Xi HF printer.</p> <p>Selects the antenna port that provides the best results for reading and writing.</p> <p><i>Accepted Values:</i></p> <ul style="list-style-type: none"> 1 = antenna port 1 2 = antenna port 2 <p><i>Default Value:</i> 1</p>																																																												

^RZ

Set RFID Tag Password and Lock Tag



Important • This command is not supported by all printers or firmware. See [Printer and Firmware Compatibility on page 82](#) for the list of printers and firmware with which you can use this command.

Description Use this command to define a password for a tag during writing.

With Gen 2 tags, you can lock a tag’s memory bank with an access password or define a kill password that can be used to permanently disable the tag. If you do not set access or kill passwords for a tag, the tag ignores any read or write commands that try to use these functions.





Note • The printer can set a kill password, but the printer cannot kill a tag.

Format ^RZp,m,l

The following table identifies the parameters for this format.

Parameters	Details
p = password	<p>Sets a password.</p> <p>For tag types other than Gen 2: The password is 8 bits. The memory bank and lock style parameters are ignored. The password must be 2 hexadecimal characters long. <i>Accepted Values:</i> 00 to FF (hexadecimal) <i>Default Value:</i> 00</p> <p>For Gen 2 tag type only: Gen 2 tags use a 32-bit password and specify the memory bank and lock style. The password must be 8 hexadecimal characters long. Use ^RF on page 96 to read the passwords. <i>Accepted Values:</i> 00000000 to FFFFFFFF (hexadecimal) <i>Default Value:</i> none</p>

Parameters	Details
m = memory bank	<p>Specifies the memory bank to perform the lock style. If κ is specified, the p parameter is written to the kill password. Otherwise, the p parameter is written to the access password.</p> <p> Note • This parameter applies to Gen 2 tags only.</p> <p><i>Accepted Values:</i></p> <ul style="list-style-type: none"> κ = kill password A = access password E = EPC T = tag identifier (TID) U = user <p><i>Default Value:</i> none</p>
l = lock style	<p>Specifies the lock style to perform on the memory bank. A non-zero password must be specified to lock or permanently lock a memory bank.</p> <p> Note • This parameter applies to Gen 2 tags only.</p> <p><i>Accepted Values:</i></p> <ul style="list-style-type: none"> U = unlocked L = locked O = permanently unlocked (open) P = permanently locked (protected) W = write value (used only for the kill password memory bank) <p><i>Default Value:</i> none</p>



Example 1 • On a tag that is not Gen 2, this example encodes 5A as the tag password.

```
^XA
^RZ5A^FS
^XZ
```



Example 2 • On a Gen 2 tag, this example encodes EPC data 112233445566778899001122 to the tag in Hex format, write protects the tag's EPC data with password 1234ABCD, and leaves the tag's access password unlocked.

```
^XA
^RFW,H^FD112233445566778899001122^FS
^RZ1234ABCD,E,L^FS
^XZ
```



Example 3 • On a Gen 2 tag, this example encodes EPC data 112233445566778899001122 to the tag in Hex format, write protects the tag's EPC data with password 1234ABCD, and makes the tag's access password unreadable.

```
^XA
^RFW,H^FD112233445566778899001122^FS
^RZ1234ABCD,E,L^FS
^RZ1234ABCD,A,L^FS
^XZ
```

The following code unprotects EPC data 112233445566778899001122 using the password 1234ABCD, encodes EPC data *newdata* to the tag in ASCII format, and then write protects the tag's new EPC data. The access password and its lock state are not changed, so the access password remains unreadable.

```
^XA
^RZ1234ABCD,E,U^FS
^RFW,A^FDnewdata^FS
^RZ1234ABCD,E,L^FS
^XZ
```



Example 4 • On a Gen 2 tag, this example unlocks the locked access password from the previous example.

```
^XA
^RZ1234ABCD,A,U^FS
^XZ
```

^WF**Encode AFI or DSFID Byte**

Important • This command is not supported by all printers or firmware. See [Printer and Firmware Compatibility](#) on page 82 for the list of printers and firmware with which you can use this command.

Description Use this command to encode the AFI or DSFID byte to a tag. Error handling is set by the ^RS command.

Format ^WF r, m, w, f, b

The following table identifies the parameters for this format.

Parameters	Details
r = number of retries	<i>Accepted values:</i> 0 to 10 <i>Default value:</i> 0
m = motion	<i>Accepted values:</i> 0 = Feed label after writing. 1 = No Feed after writing. Other ZPL may cause a feed. <i>Default value:</i> 0
w = write protect	<i>Accepted values:</i> 0 = Not write protected 1 = Write protect <i>Default value:</i> 0
f = data format	<i>Accepted values:</i> 0 = ASCII 1 = Hexadecimal <i>Default value:</i> 0
b = type of byte to read	<i>Accepted values:</i> A = AFI byte D = DSFID byte <i>Default value:</i> A



Example 1 • This example encodes data “R” (hex 52) as the AFI byte. The printer will try the command up to five times, if necessary.

```
^XA
^WF5^FDR
^XZ
```

→ **Example 2** • This example encodes data hex 66 as the AFI byte. The printer will try the command up to three times, if necessary.

```
^XA  
^WF3 , , , 1 ^FD66  
^XZ
```

→ **Example 3** • This example encodes data hex 77 as the DSFID byte. The printer will try the command up to four times, if necessary.

```
^XA  
^WF4 , , , 1 , D ^FD77  
^XZ
```

^WT**Write (Encode) RFID Tag**

Note • The ^WT command is provided only for backward-compatibility with label formats that were developed for older Zebra RFID printers. Use ^RF on page 96 instead whenever possible. See *Printer and Firmware Compatibility* on page 82 for the list of printers and firmware with which you can use this command.

Description Use this command to encode the current RFID tag. Check the amount of data memory available for the tag that you will be using. If you send more data than the memory can hold, the printer truncates the data.

Format ^WT**b**,*r*,*m*,*w*,*f*,*v*

This table identifies the parameters for this format.

Parameters	Details
b = block number	Specifies the block number to encode. This parameter is tag-dependent. <ul style="list-style-type: none"> For most tags, use block 0. For EPC Class 0 Plus, block 0 is EPC data, and block 1 is user data. For the R4Mplus, you can encode 12 bytes (96 bits) to block 0, but you can encode only the first byte of block 1. <i>Accepted values:</i> 0 to <i>n</i> , where <i>n</i> is the maximum number of blocks for the tag. <i>Default value:</i> 0
r = number of retries	Changes the number of times that the printer attempts to encode a particular block of a single RFID tag. (Same function as the ^RR command.) <i>Accepted values:</i> 0 to 10 <i>Default value:</i> 0
m = motion	Enables or disables RFID motion. (Same function as the ^RM command.) <i>Accepted values:</i> <ul style="list-style-type: none"> 0 = Feed label after writing 1 = No feed after writing (other ZPL may cause a feed) <i>Default value:</i> 0
w = write protect	<i>Accepted values:</i> <ul style="list-style-type: none"> 0 = Not write protected 1 = Write protected <i>Default value:</i> 0

Parameters	Details
f = data format	<p><i>Accepted values:</i></p> <p>0 = ASCII 1 = Hexadecimal</p> <p><i>Default value:</i> 0</p>
<p>For the R110Xi HF and R2844-Z:</p> <p>v = reverse the data order</p>	<p>For the R110Xi HF and R2844-Z:</p> <p>Reverses the data order.</p> <p><i>Accepted values:</i></p> <p>N = Do not reverse the data order (Most significant byte first for Tag*It and PicoTag. Last significant byte first for I*code and ISO 15693)</p> <p>Y = Reverse the data order</p> <p><i>Default value:</i> N</p>
<p>For other printers:</p> <p>v = verify valid data</p>	<p>For other printers:</p> <p>For reliability, some manufacturers encode tags with known data (such as A5A5). This parameter flags whether the preprogrammed data is verified. (Same function as the ^WV command.)</p> <p><i>Accepted values:</i></p> <p>N = Do not verify Y = Verify valid data before writing</p> <p><i>Default value:</i> N</p>



Example • This sample encodes data “RFIDRFID” and will try writing up to five times, if necessary.

```
^XA
^WT,5^FDRFIDRFID^FS
^XZ
```



Verify RFID Encoding Operation



Important • This command is not supported by all printers or firmware. See [Printer and Firmware Compatibility on page 82](#) for the list of printers and firmware with which you can use this command.

Description Use this command to enable or disable the write verify function. When write verify is enabled, this command verifies the RFID encoding operation to ensure that the tag about to be programmed contains the hex data “A5A5” in the first two bytes. This parameter is not persistent (carried over from label to label).

Format ^WVe

This table identifies the parameters for this format.

Parameters	Details
e = enable	<i>Accepted values:</i> Y or N <i>Default value:</i> N



Notes • _____



SGD Commands for RFID

This section contains the Set/Get/Do (SGD) commands for RFID-specific applications.

For non-RFID SGD commands, refer to the *ZPL II Programming Guide*. A copy is available on the User CD provided with your printer and online at <http://www.zebra.com/manuals>.

Contents

Printer and Firmware Compatibility	130
odometer.rfid.valid_resettable	132
odometer.rfid.void_resettable	133
rfid.error.response	134
rfid.position.program	135
rfid.reader_1.antenna_port	136
rfid.reader_1.power.read	137
rfid.reader_1.power.single_power	138
rfid.reader_1.power.write	139
rfid.tag.calibrate	141
rfid.tag.data	142
rfid.tag.test	143
rfid.tag.type	144

Printer and Firmware Compatibility

Table 10 shows the minimum firmware versions required to use specific RFID SGD commands.

Table 10 • SGD RFID Printer and Firmware Compatibility

SGD Commands	R110Xi (UHF) and R170Xi	RZ400 and RZ600	R110PAX4	R4Mplus	RP4T	R110Xi HF
<i>odometer.rfid.valid_resettable</i>	R60.16.4Z	R53.16.4Z	R62.16.4Z R63.16.4Z	SP994Q SP999G SP1027G SP1056F SP1082G	all	R65.16.4Z
<i>odometer.rfid.void_resettable</i>	R60.16.4Z	R53.16.4Z	R62.16.4Z R63.16.4Z	SP994Q SP999G SP1027G SP1056F SP1082G	all	R65.16.4Z
<i>rfid.error.response</i>	R60.15.8Z	all	R62.15.8Z R63.15.8Z	SP994P SP999F SP1027F SP1056E SP1082F	all	R65.15.8Z
<i>rfid.position.program</i>	R60.15.8Z	all	R62.15.8Z R63.15.8Z	SP994P SP999F SP1027F SP1056E SP1082F	all	R65.15.8Z
<i>rfid.reader_1.antenna_port</i>	R60.15.8Z	all	R62.15.8Z R63.15.8Z	SP994P SP999F SP1027F SP1056E SP1082F	all	R65.15.8Z
<i>rfid.reader_1.power.read</i>	R60.15.8Z	all	R62.15.8Z R63.15.8Z	SP994P SP999F SP1027F SP1056E SP1082F	all	R65.15.8Z
<i>rfid.reader_1.power.single_power</i>	R60.15.8Z	all	R62.15.8Z R63.15.8Z	SP994P SP999F SP1027F SP1056E SP1082F	all	R65.15.8Z
<i>rfid.reader_1.power.write</i>	R60.15.8Z	all	R62.15.8Z R63.15.8Z	SP994P SP999F SP1027F SP1056E SP1082F	all	R65.15.8Z
<i>rfid.tag.calibrate</i>	R60.16.4Z	R53.16.4Z	R62.16.4Z R63.16.4Z	SP994Q SP999G SP1027G SP1056F SP1082G	all	R65.16.4Z

Table 10 • SGD RFID Printer and Firmware Compatibility (Continued)

SGD Commands	R110Xi (UHF) and R170Xi	RZ400 and RZ600	R110PAX4	R4Mplus	RP4T	R110Xi HF
<i>rfid.tag.data</i>	R60.16.4Z	R53.16.4Z	R62.16.4Z R63.16.4Z	SP994Q SP999G SP1027G SP1056F SP1082G	all	R65.16.4Z
<i>rfid.tag.test</i>	—	—	—	—	all	—
<i>rfid.tag.type</i>	R60.16.4Z	R53.16.4Z	R62.16.4Z R63.16.4Z	SP994Q SP999G SP1027G SP1056F SP1082G	all	R65.16.4Z

odometer.rfid.valid_resetable

Description This command gets the RFID valid label counter value or resets the counter to zero.

Type getvar; setvar

This table identifies the command for this format:

Commands	Details
getvar	This command instructs the printer to respond with the current RFID valid counter value. <i>Format:</i> ! U1 getvar "odometer.rfid.valid_resetable"
setvar	This command instructs the printer to set the RFID valid counter to zero. <i>Format:</i> ! U1 setvar "odometer.rfid.valid_resetable" "value" <i>Values:</i> "reset"



Example • This setvar example shows how the counter portion of the printer configuration labels looks when the RFID valid counter is reset by sending:

```
! U1 setvar "odometer.rfid.valid_resetable" "reset"
```

Before

```

02/10/05..... RTC DATE
07:21..... RTC TIME
507..... RFID VALID CTR
4..... RFID VOID CTR
HIGH..... RFID READ PWR
HIGH..... RFID WRITE PWR
RFID OK..... RFID ERR STATUS
Class 0..... RFID TAG TYPE
TM: 20050201..... RFID VERSION
1950 IN..... NONRESET CNTR
1950 IN..... RESET CNTR1
1950 IN..... RESET CNTR2

```

After

```

02/10/05..... RTC DATE
07:21..... RTC TIME
0..... RFID VALID CTR
0..... RFID VOID CTR
HIGH..... RFID READ PWR
HIGH..... RFID WRITE PWR
RFID OK..... RFID ERR STATUS
Class 0..... RFID TAG TYPE
TM: 20050201..... RFID VERSION
1951 IN..... NONRESET CNTR
1951 IN..... RESET CNTR1
1951 IN..... RESET CNTR2

```

odometer.rfid.void_resettable

Description This command gets the RFID void label counter value or resets the counter to zero.

Type getvar; setvar

This table identifies the command for this format:

Commands	Details
getvar	This command instructs the printer to respond with the current RFID void counter value. <i>Format:</i> ! U1 getvar "odometer.rfid.void_resettable"
setvar	This command instructs the printer to set the RFID void counter to zero. <i>Format:</i> ! U1 setvar "odometer.rfid.void_resettable" "value" <i>Values:</i> "reset"



Example • This setvar example shows how the counter portion of the printer configuration labels looks when the RFID void counter is reset by sending:

```
! U1 setvar "odometer.rfid.void_resettable" "reset"
```

Before

```

02/10/05..... RTC DATE
07:21..... RTC TIME
507..... RFID VALID CTR
4..... RFID VOID CTR
HIGH..... RFID READ PWR
HIGH..... RFID WRITE PWR
RFID OK..... RFID ERR STATUS
Class 0..... RFID TAG TYPE
TM: 20050201..... RFID VERSION
1950 IN..... NONRESET CNTR
1950 IN..... RESET CNTR1
1950 IN..... RESET CNTR2

```

After

```

02/10/05..... RTC DATE
07:21..... RTC TIME
0..... RFID VALID CTR
0..... RFID VOID CTR
HIGH..... RFID READ PWR
HIGH..... RFID WRITE PWR
RFID OK..... RFID ERR STATUS
Class 0..... RFID TAG TYPE
TM: 20050201..... RFID VERSION
1951 IN..... NONRESET CNTR
1951 IN..... RESET CNTR1
1951 IN..... RESET CNTR2

```

rfid.error.response

Description During an error condition, an error message shows on the second line of the display. This command can be used to retrieve that error message. See [Table 6 on page 53](#) in the RFID Troubleshooting section for descriptions of the error messages.

Type getvar

This table identifies the command for this format:

Commands	Details
getvar	This command instructs the printer to respond with any active RFID error messages. <i>Format: ! U1 getvar "rfid.error.response"</i>



Example • This `getvar` example shows responses that you may get in different situations:

```
! U1 getvar "rfid.error.response"
```

If no RFID tag is present, you get the following response:

```
NO TAG FOUND
```

If an RFID tag is present and there are no errors, you get the following response:

```
RFID OK
```

rfid.position.program

Description This command gets the read/write position of the transponder or sets the read/write position in vertical (Y axis) dot rows from the top of the label. Set to 0 (no movement) if the transponder is already in the effective area without moving the media.



Important • If a label format specifies a value for this parameter, this value will be used for the programming position for all labels until a new position is specified or until the printer is turned off (O) and then back on (I).

Type getvar; setvar

This table identifies the command for this format:

Commands	Details
getvar	This command instructs the printer to respond with the current programming position. <i>Format:</i> ! U1 getvar "rfid.position.program"
setvar	This command instructs the printer to set the programming position. <i>Format:</i> ! U1 setvar "rfid.position.program" "value" <i>Values:</i> 0 to label length <i>Default value:</i> For the R110PAX4 and R2844-Z: 0 For all other supported printers: label length minus 1 mm (1/16 in.) <i>Default:</i> 1



Example • This setvar example shows the programming position being set at 15 dot rows from the top of the label.

```
! U1 setvar "rfid.position.program" "15"
```

When the setvar value is set to "15", the getvar result is "15".

rfid.reader_1.antenna_port

Description This command sets or gets the RFID antenna port.

Type getvar; setvar

This table identifies the command for this format:

Commands	Details
getvar	This command instructs the printer to respond with the current antenna port. <i>Format:</i> ! U1 getvar "rfid.reader_1.antenna_port"
setvar	This command instructs the printer to set the antenna port. <i>Format:</i> ! U1 setvar "rfid.reader_1.antenna_port" "value" <i>Values:</i> 1 = antenna port 1 2 = antenna port 2 <i>Default:</i> 1



Example • This setvar example shows the selection of antenna port 2.

```
! U1 setvar "rfid.reader_1.antenna_port" "2"
```

When the setvar value is set to "2", the getvar result is "2".

rfid.reader_1.power.read

Description This command sets or gets the RFID reader power level for reading RFID tags.



Note • This parameter is ignored on the R110Xi HF printer because read and write powers cannot be specified separately. See *rfid.reader_1.power.single_power* on page 138 to set the power level for the R110Xi HF printer.

Type getvar; setvar

This table identifies the command for this format:

Commands	Details																																																																										
getvar	This command instructs the printer to respond with the reader's current read power level. <i>Format:</i> ! U1 getvar "rfid.reader_1.power.read"																																																																										
setvar	This command instructs the printer to set the read power level on the RFID reader. <i>Format:</i> ! U1 setvar "rfid.reader_1.power.read" "value" <div style="display: flex; align-items: flex-start;"> <p>Note • On some printers, the options vary based on the reader. Check the printer configuration label for the RFID_HW_VER line or perform the RFID SLOW test (see <i>Perform RFID Test</i> on page 22) to determine the reader type.</p> </div> <table border="1" style="margin-top: 10px; width: 100%;"> <thead> <tr> <th rowspan="2">Printer</th> <th rowspan="2">Firmware Version</th> <th colspan="3">Selections</th> <th rowspan="2">Default</th> </tr> <tr> <th>high, medium, low</th> <th>0-30</th> <th>up, down</th> </tr> </thead> <tbody> <tr> <td rowspan="4">RXi</td> <td>R60.15.8Z and earlier</td> <td>X</td> <td>—</td> <td>—</td> <td>low</td> </tr> <tr> <td>R60.16.4Z</td> <td>X</td> <td>X</td> <td>—</td> <td>low</td> </tr> <tr> <td>R60.16.5Z and later (M4xxx...x reader)</td> <td>X</td> <td>X</td> <td>—</td> <td>low</td> </tr> <tr> <td>R60.16.5Z and later (M5xxx...x reader)</td> <td>—</td> <td>X</td> <td>X</td> <td>16</td> </tr> <tr> <td rowspan="2">R4Mplus</td> <td>SP994P, SP999F, SP1027F, SP1056E, SP1082F, and earlier</td> <td>X</td> <td>—</td> <td>—</td> <td>low</td> </tr> <tr> <td>SP994Q, SP999G, SP1027G, SP1056F, SP1082G, and later</td> <td>X</td> <td>X</td> <td>—</td> <td>low</td> </tr> <tr> <td rowspan="4">R110PAX4</td> <td>R62.15.8Z and earlier</td> <td>X</td> <td>—</td> <td>—</td> <td>low</td> </tr> <tr> <td>R62.16.4Z and later</td> <td>X</td> <td>X</td> <td>—</td> <td>low</td> </tr> <tr> <td>R63.15.8Z and earlier</td> <td>X</td> <td>—</td> <td>—</td> <td>low</td> </tr> <tr> <td>R63.16.4Z and later</td> <td>X</td> <td>X</td> <td>—</td> <td>low</td> </tr> <tr> <td>RZx00</td> <td>all versions</td> <td>—</td> <td>X</td> <td>X</td> <td>16</td> </tr> <tr> <td>RP4T</td> <td>all versions</td> <td>—</td> <td>X</td> <td>X</td> <td>16</td> </tr> </tbody> </table>	Printer	Firmware Version	Selections			Default	high, medium, low	0-30	up, down	RXi	R60.15.8Z and earlier	X	—	—	low	R60.16.4Z	X	X	—	low	R60.16.5Z and later (M4xxx...x reader)	X	X	—	low	R60.16.5Z and later (M5xxx...x reader)	—	X	X	16	R4Mplus	SP994P, SP999F, SP1027F, SP1056E, SP1082F, and earlier	X	—	—	low	SP994Q, SP999G, SP1027G, SP1056F, SP1082G, and later	X	X	—	low	R110PAX4	R62.15.8Z and earlier	X	—	—	low	R62.16.4Z and later	X	X	—	low	R63.15.8Z and earlier	X	—	—	low	R63.16.4Z and later	X	X	—	low	RZx00	all versions	—	X	X	16	RP4T	all versions	—	X	X	16
Printer	Firmware Version			Selections				Default																																																																			
		high, medium, low	0-30	up, down																																																																							
RXi	R60.15.8Z and earlier	X	—	—	low																																																																						
	R60.16.4Z	X	X	—	low																																																																						
	R60.16.5Z and later (M4xxx...x reader)	X	X	—	low																																																																						
	R60.16.5Z and later (M5xxx...x reader)	—	X	X	16																																																																						
R4Mplus	SP994P, SP999F, SP1027F, SP1056E, SP1082F, and earlier	X	—	—	low																																																																						
	SP994Q, SP999G, SP1027G, SP1056F, SP1082G, and later	X	X	—	low																																																																						
R110PAX4	R62.15.8Z and earlier	X	—	—	low																																																																						
	R62.16.4Z and later	X	X	—	low																																																																						
	R63.15.8Z and earlier	X	—	—	low																																																																						
	R63.16.4Z and later	X	X	—	low																																																																						
RZx00	all versions	—	X	X	16																																																																						
RP4T	all versions	—	X	X	16																																																																						



Example • This setvar example sets the reader to high power for reading RFID tags.

```
! U1 setvar "rfid.reader_1.power.read" "high"
```

When the setvar value is set to "high", the getvar result is "high".

rfid.reader_1.power.single_power

Description This command sets or gets the RFID reader power level for reading and writing to RFID tags for readers with a single power level.



Note • This command applies only to the R110Xi HF printer, firmware version R65.X.

Type getvar; setvar

This table identifies the command for this format:

Commands	Details
getvar	This command instructs the printer to respond with the current power level. <i>Format:</i> ! U1 getvar "rfid.reader_1.power.single_power"
setvar	This command instructs the printer to set the power level for reading and writing. <i>Format:</i> ! U1 setvar "rfid.reader_1.power.single_power" "value" <i>Values:</i> high medium low <i>Default:</i> low



Example • This setvar example sets the reader to high power for writing to RFID tags.

```
! U1 setvar "rfid.reader_1.power.single_power" "high"
```

When the setvar value is set to "high", the getvar result is "high".

rfid.reader_1.power.write

Description This command sets or gets the RFID reader power level for writing to RFID tags.



Note • This parameter is ignored on the R110Xi HF printer because read and write powers cannot be specified separately. See *rfid.reader_1.power.single_power* on page 138 to set the power level for the R110Xi HF printer.

Type getvar; setvar

This table identifies the command for this format:

Commands	Details
getvar	This command instructs the printer to respond with the reader's current write power level. <i>Format:</i> ! U1 getvar "rfid.reader_1.power.write"
setvar	This command instructs the printer to set the write power level on the RFID reader. <i>Format:</i> ! U1 setvar "rfid.reader_1.power.write" "value" <div data-bbox="581 1010 647 1075" data-label="Image"> </div> Note • On some printers, the options vary based on the reader. Check the printer configuration label for the RFID_HW_VER line or perform the RFID SLOW test (see <i>Perform RFID Test</i> on page 22) to determine the reader type.

Printer	Firmware Version	Selections			Default
		high, medium, low	0-30	up, down	
RXi	R60.15.8Z and earlier	X	—	—	low
	R60.16.4Z	X	X	—	low
	R60.16.5Z and later (M4xxx...x reader)	X	X	—	low
	R60.16.5Z and later (M5xxx...x reader)	—	X	X	16
R4Mplus	SP994P, SP999F, SP1027F, SP1056E, SP1082F, and earlier	X	—	—	low
	SP994Q, SP999G, SP1027G, SP1056F, SP1082G, and later	X	X	—	low
R110PAX4	R62.15.8Z and earlier	X	—	—	low
	R62.16.4Z and later	X	X	—	low
	R63.15.8Z and earlier	X	—	—	low
	R63.16.4Z and later	X	X	—	low
RZx00	all versions	—	X	X	16
RP4T	all versions	—	X	X	16



Example • This setvar example sets the reader to high power for writing to RFID tags.

```
! U1 setvar "rfid.reader_1.power.write" "high"
```

When the setvar value is set to "high", the getvar result is "high".

rfid.tag.calibrate

Description This command sets the RFID programming position through a tag calibration, or it restores the programming position back to the printer default. Before running this command, load the printer with RFID media, and close the printhead. For more information about this option, see *Calibrate RFID Tag* on page 23.

Type setvar

This table identifies the command for this format:

Commands	Details
setvar	This command instructs the printer to set the programming position. <i>Format:</i> ! U1 setvar "rfid.tag.calibrate" "value" <i>Values:</i> restore run



Example • This setvar example performs a quick RFID test.

```
! U1 setvar "rfid.tag.calibrate" "restore"
```



Example • This setvar example performs a slow RFID test.

```
! U1 setvar "rfid.tag.calibrate" "run"
```

rfid.tag.data

Description This command tells the RFID reader to attempt to read a tag over the RFID antenna, even if the printhead is open. Results are returned to the host.

Before running this command, position an RFID label over the printer's RFID antenna. To locate the RFID antenna on your printer, see [RFID Antenna Location on page 39](#).

Type getvar

This table identifies the command for this format:

Commands	Details
getvar	This command instructs the printer to respond with the current tag's data. <i>Format: ! U1 getvar "rfid.tag.data"</i>



Example • This getvar example gets the current tag's data, assuming that an RFID label with data "0123456789ABCDEF12345678" is in place over the antenna.

```
! U1 setvar "rfid.tag.data"
```

The printer responds with **0123456789ABCDEF12345678**.



Example • This getvar example gets the current tag's data, assuming that no tag data can be read or that no tag is present.

```
! U1 setvar "rfid.tag.data"
```

The printer responds with **NO DATA**.

rfid.tag.test

Description This command performs an RFID test. In the RFID test, the printer attempts to read and write to a transponder that you place over the RFID antenna. Results are displayed on the printer’s control panel display. To locate the RFID antenna on your printer, see [RFID Antenna Location on page 39](#).

In the slow version of the RFID test, the printer first displays the hardware version, the reader firmware version, and the program position.



Note • This command is valid only on RP4T printers.

Type setvar

This table identifies the command for this format:

Commands	Details
setvar	<p>This command instructs the printer to set the programming position.</p> <p><i>Format:</i> ! U1 setvar "rfid.tag.test" "value"</p> <p><i>Values:</i></p> <p> quick</p> <p> slow</p>



Example • This setvar example performs a quick RFID test, which shows a pass or fail message.

```
! U1 setvar "rfid.tag.test" "quick"
```



Example • This setvar example performs a slow RFID test, which shows the success or failure of each read or write tag operation.

```
! U1 setvar "rfid.tag.test" "slow"
```

rfid.tag.type

Description This command sets or gets the reader's RFID tag type.

Type getvar; setvar

This table identifies the command for this format:

Commands	Details
getvar	This command instructs the printer to respond with the reader's current tag type. <i>Format:</i> ! U1 getvar "rfid.tag.type"
setvar	This command instructs the printer to set the reader's tag type. For the supported tag types, see Table 11 on page 145 . <i>Format:</i> ! U1 setvar "rfid.tag.type" "value" <i>Values:</i> UHF Printers none = None class0 = EPC Class 0 class0+ = EPC Class 0 Plus class1_64bit = EPC Class 1 64-bit class1_96bit = EPC Class 1 96-bit ucode_epc_1_19 = UCODE EPC 1.19 class0+_impinj = Impinj Class 0 Plus ISO18000A = ISO 18000-06A gen2 = EPC Class 1, Generation 2 (Gen 2) ISO18000B = ISO 18000-06B HF Printers none = None detect = Auto detect (query tag to determine) tagit = Tag*It (Texas Instruments Tagit tags) icode = I*code (Phillips Icode tags) pico = Pico Tag (Inside Technology's) ISO15693 = ISO 15693 EPC = EPC tag (13.56 MHz) UIC = UID Tag mifare_ultralight = Mifare UltraLight



Example • This setvar example shows the reader's tag type being set to Gen 2.

```
! U1 setvar "rfid.tag.type" "gen2"
```

Supported Tag Types Table 11 shows the tag types supported by different RFID printers/print engines and firmware versions. Depending on your country or on the firmware version that you are using, your printer may not support all of the tag types listed. If you specify an unsupported tag type, the printer uses the default value. If a tag type is shown as supported but does not work with your printer, you may need to upgrade the printer’s firmware (see <http://www.zebra.com/firmware>).

Table 11 • Supported Tag Types and Default Values

Printer	UHF Printers												HF Printers			
	R110Xi/R170Xi			R110PAX4			R4Mplus			RZ400/RZ600	RP4T	R110Xi/HF	R2844-Z			
Firmware Version	R60.13.X	R60.15.8Z and R60.16.4Z	R60.16.5Z and later	R62.13.X	R62.15.X and later	R63.13.X	R63.15.X and later	SP994O, SP999E, SP1027E, SP1082E, and earlier	SP994P, SP999F, SP1027F, SP1082F, and later	SP1056D and earlier	SP1056E and later	R53.16.X and later	all	R65.13.X	R65.15.X and later	all
Tag Type																
UHF Tag Types and Options																
None (no tag type specified)	*	*	* a	*	*	—	—	—	—	—	—	—	—	—	—	—
EPC Class 0	*	*	* a	*	*	—	—	—	—	—	—	—	—	—	—	—
EPC Class 0 Plus	*	*	* a	*	*	—	—	—	—	—	—	—	—	—	—	—
EPC Class 1 64-bit	*	*	* a	*	*	—	—	—	—	—	—	—	—	—	—	—
EPC Class 1 96-bit	#	*	* a	#	*	—	*	*	*	—	—	—	—	—	—	—
UCODE EPC 1.19	* b	*	* a	—	*	#	*	#	*	#	*	—	—	—	—	—
Impinj Class 0 Plus	*	*	* a	*	*	—	—	—	—	—	—	—	—	—	—	—
ISO 18000-06A	—	—	—	*	—	—	*	*	*	—	—	—	—	—	—	—
EPC Class 1, Generation 2 (Gen 2)	*	#	#	*	#	—	#	*	#	*	#	#	#	—	—	—
ISO 18000-06B	*	*	* a	*	*	—	*	*	*	*	*	—	—	—	—	—
HF Tag Types and Options																
Auto-detect the tag type by querying the tag	—	—	—	—	—	—	—	—	—	—	—	—	—	—	—	#
Tag*It (Texas Instruments Tagit tags)	—	—	—	—	—	—	—	—	—	—	—	—	—	—	—	*
I*code (Phillips Icode tags)	—	—	—	—	—	—	—	—	—	—	—	—	—	—	—	*
Pico Tag (Inside Technology’s)	—	—	—	—	—	—	—	—	—	—	—	—	—	—	—	*
ISO 15693	—	—	—	—	—	—	—	—	—	—	—	—	—	#	#	*

= Default value * = Accepted value — = Not supported

- a. Requires printers with RFID hardware version M4xxx...x. This will not work with RFID hardware version M5xxx...x. For the RFID hardware version, refer to the RFID HW VER line on your printer configuration label, or perform the RFID SLOW test (see [Perform RFID Test on page 22](#)).
- b. Requires R60.13.0.13ZD or later.

Table 11 • Supported Tag Types and Default Values (Continued)

Printer	UHF Printers												HF Printers			
	R110Xi R170Xi			R110PAX4			R4Mplus			RZ400/RZ600	RP4T	R110Xi/HF	R2844-Z			
Firmware Version	R60.13.X	R60.15.8Z and R60.16.4Z	R60.16.5Z and later	R62.13.X	R62.15.X and later	R63.13.X	R63.15.X and later	SP994O, SP999E, SP1027E, SP1082E, and earlier	SP994P, SP999F, SP1027F, SP1082F, and later	SP1056D and earlier	SP1056E and later	R53.16.X and later	all	R65.13.X	R65.15.X and later	all
Tag Type																
EPC tag	—	—	—	—	—	—	—	—	—	—	—	—	—	—	—	*
UID Tag	—	—	—	—	—	—	—	—	—	—	—	—	—	—	—	—
Mifare UltraLight	—	—	—	—	—	—	—	—	—	—	—	—	—	*	*	—

= Default value * = Accepted value — = Not supported

- a. Requires printers with RFID hardware version M4xxx...x. This will not work with RFID hardware version M5xxx...x. For the RFID hardware version, refer to the RFID HW VER line on your printer configuration label, or perform the RFID SLOW test (see [Perform RFID Test on page 22](#)).
- b. Requires R60.13.0.13ZD or later.



RFID Applicator Signals

This section applies to printers that have applicator ports and that are being used in a print and apply system. Included are timing diagrams for good and bad RFID tags and the pin configuration for the applicator port. For basic timing diagrams, see the User Guide for your printer.

Contents

Timing Diagrams for RFID	150
Single Signal Mode	150
Double Signal Mode	152
Applicator Interface Connector Pin Configuration	153
Jumper Configurations and Pinouts for +5 V I/O Operation	156
Pinouts for +24-28 V I/O Operation	157

Timing Diagrams for RFID

The following timing diagrams show how applicator signals function while an RFID label is printing and being programmed in Mode 1. For more information about Single and Double signal modes, see [^RS on page 108](#).

Single Signal Mode

Figure 9 and Figure 10 show the applicator signals for label formats using programming positions other than zero.

Figure 9 • Single Signal Mode, Good RFID Tag

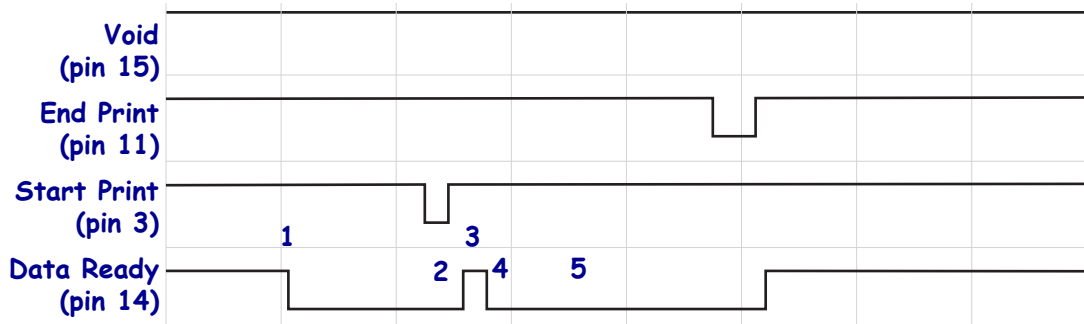

1	Label ready for printing.
2	After receiving start print signal, begin printing label.
3	When program position is reached, pause and encode RFID tag.
4	Check void signal (high means good tag).
5	Print label.

Figure 10 • Single Signal Mode, Bad RFID Tag

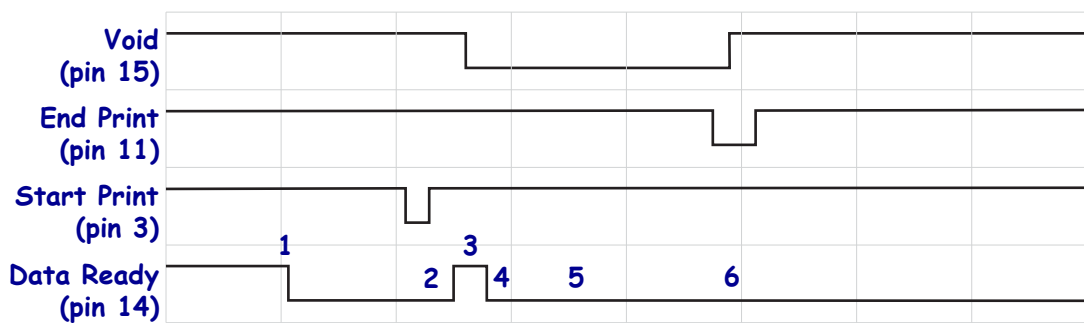

1	Label ready for printing.
2	After receiving start print signal, begin printing label.
3	When program position is reached, pause and encode RFID tag.
4	Check void signal (low means bad tag).
5	Print void label (if applicable).
6	Discard bad label. Data Ready stays low if format to be retried on next label.

Figure 11 and Figure 12 show the applicator signals for label formats using zero for their programming position.

Figure 11 • Single Signal Mode, Good RFID Tag

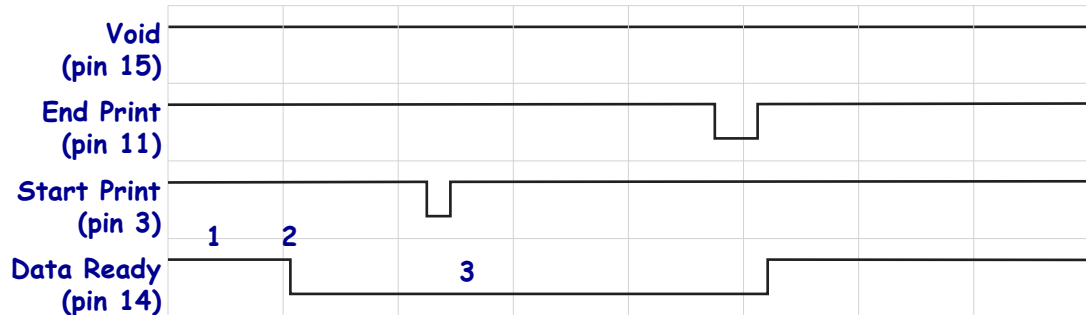

1	Encode RFID tag.
2	Check void signal (high means good tag). Label ready for printing.
3	After receiving start print signal, print label.

Figure 12 • Single Signal Mode, Bad RFID Tag

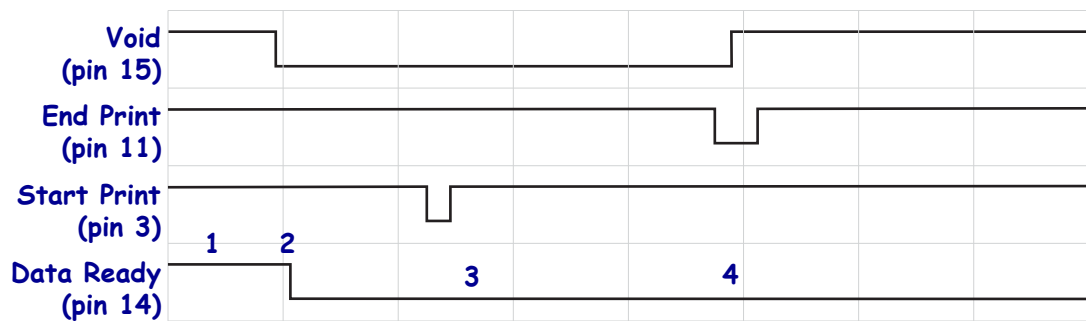

1	Encode RFID tag.
2	Check void signal (low means bad tag).
3	After receiving start print signal, print void label (if applicable).
4	Discard bad label. Data Ready stays low if format to be retried on next label.

Double Signal Mode

Figure 13 and Figure 14 show the applicator signals for good and bad tags using double signal mode.

Figure 13 • Double Signal Mode, Good RFID Tag

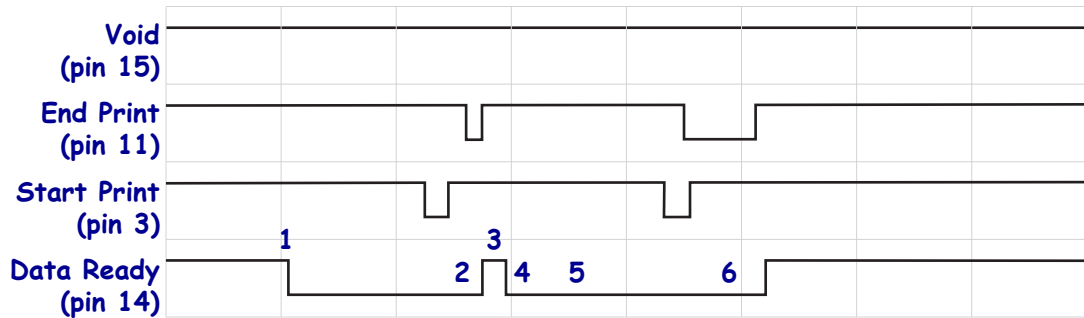

1	Label ready for printing.
2	After receiving start print signal, print first part of label.
3	When program position is reached, stop and encode RFID tag.
4	Check void signal (high means good tag).
5	Wait for second start signal.
6	Print second part of label.

Figure 14 • Double Signal Mode, Bad RFID Tag

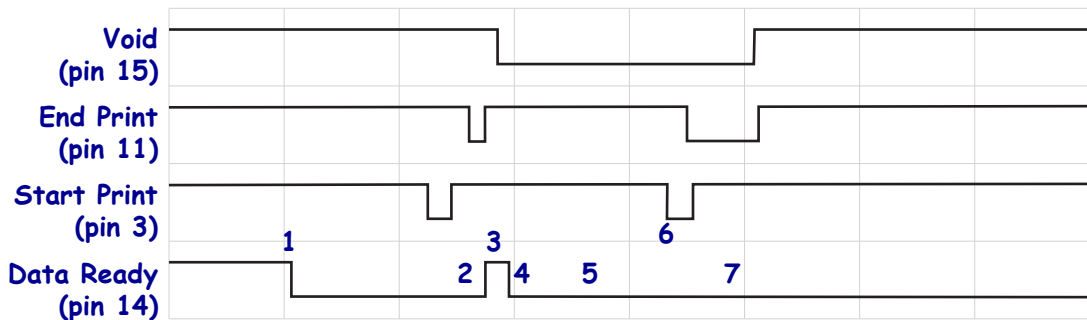

1	Label ready for printing.
2	After receiving start print signal, print first part of label.
3	When program position is reached, stop and encode RFID tag.
4	Check void signal (low means bad tag).
5	Wait for second start signal.
6	Void remainder of label (if applicable).
7	Discard bad label. Data Ready stays low if format to be retried on next label.

Applicator Interface Connector Pin Configuration

The Applicator Interface Assembly is available in two versions: a +5 V I/O and a +24–28 V I/O. Table 12 lists the pin configurations and functions of the applicator interface connector for both +5 V and +24–28 V operation.

Table 12 • Applicator Interface Connector Pin Configuration



Pin No.	Signal Name	Signal Type	Description
1	I/O SIGNAL GROUND (+5V Return)	I/O Signal Ground	Using jumper J5 (PAX4 print engines) or JP2 (Xi-series printers), this pin can be configured as isolated or non-isolated from the printer signal ground. See Jumper Configurations and Pinouts for +5 V I/O Operation on page 156 for more information.
1	I/O SIGNAL GROUND (+24-28V Return)	I/O Signal Ground	No jumpers to configure.  Important • Customer must provide this external ground. (This ground can come from pin 8 when operating at 28V for all printers except the 110XiIIIPlus.) See Pinouts for +24-28 V I/O Operation on page 157 for more information.
2	+5V I/O (Fused at 1 A) Caution • Replace the fuse only with one of the same type and rating.	Power	Using jumper J4 (PAX4 print engines) or JP1 (Xi-series printers), this pin can be configured as isolated or non-isolated from the Applicator Interface Circuit +5 V Supply. See Jumper Configurations and Pinouts for +5 V I/O Operation on page 156 for more information.
2	+24-28V I/O	Power	No jumpers to configure. This +24-28V power source also supplies voltage for output signal pull-up resistors.  Important • Customer must provide this external power. (This power can come from pin 7 when operating at 28V for all printers except the 110XiIIIPlus.) See Pinouts for +24-28 V I/O Operation on page 157 for more information.
3	START PRINT	Input	<ul style="list-style-type: none"> • Pulse Mode—The label printing process begins on the HIGH to LOW transition of this signal if a format is ready. Deassert this signal HIGH to inhibit printing of a new label. • Level Mode—Assert LOW to enable the printer to print if a label format is ready. When deasserted HIGH, the printer completes the label that is printing then stops and waits for this input to be reasserted LOW.
4	FEED	Input	When the printer is idle or has been paused, assert this input LOW to trigger repeated feeding of blank labels. Deassert HIGH to stop feeding blank labels and register to the top of the next label.

Table 12 • Applicator Interface Connector Pin Configuration (Continued)



Pin No.	Signal Name	Signal Type	Description
5	PAUSE	Input	To toggle the current Pause state, this input must be asserted LOW for 200 milliseconds, or until the SERVICE REQUIRED output (pin 10) changes state.
6	REPRINT	Input	<ul style="list-style-type: none"> • If the Reprint feature is enabled, this input must be asserted LOW to cause the printer to reprint the last label. • If the Reprint feature is disabled, this input is ignored.
7	+28 V (On PAX4 printers, fused at 500 mA. On Xi-series printers, fused at 500 mA for the 24–28V board and fused at 2 A for the 5V board.) Caution • Replace the fuse only with one of the same type and rating.	Power	<p>The Interface Power Supply. Supplies power to external sensors as required.</p>  <p>Note • If operating with 28V signals only, pin 7 may be used to supply power to pin 2, which creates a non-isolated mode of operation. (This is applicable for all printers except the 110XiIIIPlus.)</p>
8	POWER GROUND (+28 V DC Return)	Ground	<p>The Interface Power Ground.</p>  <p>Note • If pin 7 is used to supply power to pin 2, use this pin to ground pin 1. (This is applicable for all printers except the 110XiIIIPlus.)</p>
9	RIBBON LOW	Output	<p>No function in RXi printers.</p> <p>In the R110PAX4 print engine, asserted if the Ribbon Low feature is enabled and the amount of ribbon remaining on the supply spool is below a specific threshold level.</p> <ul style="list-style-type: none"> • For print engines with the Ribbon Low Output parameter, asserted HIGH or LOW depending on the ribbon low output mode selected. • For print engines without the Ribbon Low Output parameter, asserted HIGH.
10	SERVICE REQUIRED	Output	<p>Asserted LOW in the following circumstances:</p> <ul style="list-style-type: none"> • the printhead is open • the ribbon or media is out • the printer is paused • an operational fault occurs • a Resynch error occurs while the applicator Resynch mode is set to Error mode

Table 12 • Applicator Interface Connector Pin Configuration (Continued)

Pin No.	Signal Name	Signal Type	Description
11	END PRINT	Output	<ul style="list-style-type: none"> • MODE 0—The applicator port is OFF. • MODE 1—Asserted LOW only while the printer is moving the label forward; otherwise deasserted HIGH. • MODE 2—Asserted HIGH only while the printer is moving the label forward; otherwise deasserted LOW. • MODE 3—(Default) Asserted LOW for 20 milliseconds when a label is completed and positioned. Not asserted during continuous printing. • MODE 4—Asserted HIGH for 20 milliseconds when a label is completed and positioned. Not asserted during continuous printing.
12	MEDIA OUT	Output	Asserted LOW while there is no media in the printer.
13	RIBBON OUT	Output	Asserted LOW while there is no ribbon in the printer.
14	DATA READY	Output	<ul style="list-style-type: none"> • Asserted LOW when sufficient data has been received to begin printing the next label. • Deasserted HIGH whenever printing stops after the current label, due to either a pause condition or the absence of a label format.
15	VOID	Output	<p>See <i>Timing Diagrams for RFID</i> on page 150 for more information about this signal.</p> <ul style="list-style-type: none"> • Asserted LOW when the RFID transponder over the antenna is “voided.” • Deasserted HIGH when the end print signal is asserted.

Jumper Configurations and Pinouts for +5 V I/O Operation

Jumpers are used to produce isolated or non-isolated modes of operation for applicator input and output control signals. RPAX4 printers use J4 and J5 while RXi printers use JP1 and JP2. J4/JP1 configures the +5 V source for the optoisolator circuits, and J5/JP2 configures the ground. For proper operation, when J4/JP1 is installed, J5/JP2 must be installed, and when J4/JP1 is removed, J5/JP2 must be removed.

Table 13 describes the pin and jumper configurations for +5 V I/O operation.

Table 13 • Non-Isolated and Isolated Modes for +5V Operation

	Non-Isolated (Jumpers In)	Isolated (Jumpers Out)
Pin 1	Ground +5V, Jumper J5/JP2 In I/O ground is connected to the printer signal ground.	External Ground +5V, Jumper J5/JP2 Out I/O ground is disconnected from the printer signal ground. Ground must be provided externally to this pin.
Pin 2	+5V Output, Jumper J4/JP1 In +5 V I/O is connected to the applicator interface circuit +5 V Supply.	External +5V Input, Jumper J4/JP1 Out +5 V I/O is disconnected from the applicator interface circuit +5 V Supply. The +5 V for the applicator interface optoisolator circuits must be provided externally. This input also supplies voltage for output signal pull-up resistors.
Pinouts		

Pinouts for +24-28 V I/O Operation

Table 14 describes the pin configurations for +24–28 V I/O operation. There are no jumpers to configure for this mode.

Table 14 • Non-Isolated and Isolated Modes for +24–28V Operation

	Isolated (External Power)	Non-Isolated (Internal Printer Power)
Pin 1	<p>External Ground +24-28V I/O ground must be connected to an external ground. (Required for the 110XiIIIPlus.)</p>	<p>Ground +28V from Pin 8 If pin 7 is used to supply power to pin 2, use pin 8 to ground pin 1. (Does not apply to the 110XiIIIPlus.)</p>
Pin 2	<p>+24-28V External Input +24-28 V I/O must be connected to an external power supply. This input also supplies voltage for output signal pull-up resistors. (Required for the 110XiIIIPlus.)</p>	<p>+28V Input from Pin 7 If operating with 28V signals only, pin 7 may be shorted to pin 2, which creates a non-isolated mode of operation. This input also supplies voltage for output signal pull-up resistors. (Does not apply to the 110XiIIIPlus.)</p>
Pinouts		



Notes • _____

Index



A

- access password
 - set via ^RQ, 105
 - set via ^RZ, 120
- advanced counter reset, 103
- AFI byte
 - read command (^RA), 91
 - write command (^WF), 123
- antenna location, 39
- antenna port
 - select through control panel, 26
 - select using ZPL, 119
- applicator
 - +24-28V isolated and non-isolated modes, 157
 - +5V isolated and non-isolated modes, 156
 - interface pin configuration, 153
 - timing diagrams for RFID, 150

C

- calibration
 - RFID tag from control panel, 23
 - RFID tag using SGD, 141
 - RFID tag using ZPL (^HR), 85
- characteristics of transponders, 44
- contacts, 10
- creating basic label formats, 30
- customer service, 10

D

- data log for RFID, 84
- define EPC data structure (^RB), 93
- detect multiple RFID tags (^RN), 102
- display RFID tag data
 - LCD, 28
 - SGD, 142
- double signal mode
 - setting, 110
 - timing diagrams, 152
- download firmware, 19

E

- E.A.S. bit enable/disable command (^RE), 95
- Electronic Product Code (EPC)
 - define EPC data structure (^RB), 93
 - EPC structure in RFID labels, 45
 - Gen 2 overview, 46
 - overview, 45
 - write EPC data via ^RQ, 105
 - write EPC data via ^RZ, 120
- electrostatic discharge (ESD), 15
- enable RFID motion (^RM), 101
- encoding results, 117
- environmental conditions for RFID labels, 15
- error codes, 66
- error handling, 109
- error messages, 53

F

firmware
 supported tag types for each version, 111, , 145
 upgrades, 19
 ZPL command compatibility, 82

G

Gen 2
 memory map, 46
 overview, 46
 printers and firmware that support Gen 2, 111, 145
 setting password or locking tag, 120
 specify tag type using SGD, 144
 specify tag type using ZPL, 108
 write EPC data to tag via ^RQ, 105
 write EPC data to tag via ^RZ, 120

H

host verification command (^HV), 88

I

inlays, 15
 isolated mode for applicator control signals
 +24-28V operation, 157
 +5V operation, 156

J

jumper configurations for +24-28V operation, 157
 jumper configurations for +5V operation, 156

K

kill password, 120
 set via ^RQ, 105
 set via ^RZ, 120

L

label formats for RFID, 30
 label placement, 15
 labels (purchasing RFID labels), 15
 liability, 2
 lock RFID tag
 Gen 2, 120
 not Gen 2, 96
 log file for RFID, 84

M

media
 ordering, 10
 media (purchasing RFID labels), 15
 memory map for Gen 2 tags, 46
 motion in RFID label, 101

N

non-isolated mode for applicator control signals
 +28V operation, 157
 +5V operation, 156
 non-standard label programming, 23
 number of retries for block (^RR), 107

O

ordering ribbon and media, 10

P

password for RFID tag, 120
 permanently lock Gen 2 tag data, 120
 pin configuration for applicator interface, 153
 placement
 labels on items after encoding, 15
 specifications for transponders, 15
 print mode
 selection via control panel, 22
 selection via ZPL, 89
 programming position
 set through calibration or reset to default, 23
 set using ZPL, 109

R

read power
 change through control panel, 24, , 25
 change using ZPL, 118
 read RFID tag
 read or write RFID format (^RF), 96
 read RFID tag (^RT), 115
 read/write position
 set through calibration or reset to default, 23
 set using ZPL, 109
 reader firmware upgrades, 19
 report RFID encoding results, 117
 reset advanced counter, 103
 reset programming position, 23
 return data to host computer (^HV), 88
 return RFID data log to host, 84

RFID

- antenna location, 39
 - antenna port selection, 26
 - calibrate RFID tag from control panel, 23
 - calibrate RFID tag using SGD, 141
 - calibrate RFID tag using ZPL (^HR), 85
 - change read power through control panel, 24, 25
 - change read power using ZPL, 118
 - change write power through control panel, 25
 - change write power using ZPL, 118
 - create label formats, 30
 - detect multiple tags (^RN), 102
 - display tag data
 - LCD, 28
 - SGD, 142
 - enable motion (^RM), 101
 - error codes and messages, 53
 - error status, 26
 - number of retries for block (^RR), 107
 - power settings, 18
 - RFID setup command (^RS), 108
 - RFID test
 - control panel, 22
 - SGD command, 143
 - tag type, 27
 - timing diagrams, 150
 - troubleshooting, 50
 - verify write operation (^WV), 127
 - when to perform calibration, 18
- RFID labels**
- label formats, 30
 - placement after encoding, 15
 - purchasing, 15
 - storage requirements, 15
- RFID mode**
- selection via control panel, 22
 - selection via ZPL, 89
- RFID tag ID command (^RI), 100**
- RFID valid label counter**
- reset by SGD, 132
 - reset by ZPL, 103
- RFID void counter**
- reset by SGD, 133
 - reset by ZPL, 103
- ribbon**
- ordering, 10

S

- sales, 10
- sample RFID label formats, 31
- set RFID tag or kill password (^RZ), 120
- set up RFID information (^RS), 108
- SGTIN-64 standard programming example, 94
- single signal mode
 - setting, 110
 - timing diagrams, 150
- specify number of retries for block (^RR), 107
- specify RFID tag type, 27
- status messages, 53

T

- tag type
 - selecting, 14
 - specify using control panel, 27
 - specify using SGD, 144
 - specify using ZPL, 108
- technical support, 10
- temperature requirements for RFID labels, 15
- timing diagrams
 - basic, 149
 - RFID, 150
- transponders
 - calibrate from control panel, 23
 - calibration using ZPL (^HR), 85
 - characteristics of different types, 44
 - description, 14
 - placement in labels, 15
 - selecting type, 14
 - setting tag type, 18
 - when to calibrate, 18
- troubleshooting
 - RFID error codes and messages, 53
 - RFID problems, 50
 - RFID test
 - control panel, 22
 - SGD command, 143

V

- valid RFID label counter
 - reset by SGD, 132
 - reset by ZPL, 103
- verify RFID write operation (^WV), 127
- void handling, 109
- void RFID label counter
 - reset by SGD, 133
 - reset by ZPL, 103

W

- write AFI byte command (^WF), 123
- write data to tag
 - via ^RQ, 105
 - via ^RZ, 120
- write power
 - change through control panel, 25
 - change using ZPL, 118
- write RFID format (^RF), 96
- write RFID tag (^WT), 125

Z

- Zebra Programming Language (ZPL II)
 - command compatibility with printers and firmware, 82
 - ^HL or ~HL, Return RFID Data Log to Host (^HL or ~HL), 84
 - ^HR, Calibrate RFID Transponder, 85
 - overview, 81
 - ^RA, Read AFI Byte, 91
 - ^RB, Define EPC Data Structure, 93
 - ^RE, Enable/Disable E.A.S. Bit, 95
 - ^RF, Read or Write RFID Format, 96
 - RFID label formats, 30
 - ^RI, Get RFID Tag ID, 100
 - ^RM, Enable RFID Motion, 101
 - ^RN, Detect Multiple RFID Tags, 102
 - ^RQ, Quick Write EPC Data and Passwords, 105
 - ^RR, Specify RFID Retries for a Block, 107
 - ^RS, RFID Setup, 108
 - ^RT, Read RFID Tag, 115
 - ~RV, Report RFID Encoding Results, 117
 - ^RW, Set RFID Read and Write Power, 118
 - ^RZ, Set RFID Tag Password and Lock Tag, 120
 - ^WF, Write AFI Byte, 123
 - ^WT, Write Tag, 125
 - ^WV, Verify RFID Write Operation, 127



Zebra Technologies International, LLC

333 Corporate Woods Parkway
Vernon Hills, Illinois 60061.3109 U.S.A
T: +1 847 793 2600
Toll-free +1 800 423 0422
F: +1 847 913 8766

Zebra Technologies Europe Limited

Dukes Meadow
Millboard Road
Bourne End
Buckinghamshire, SL8 5XF, UK
T: +44 (0)1628 556000
F: +44 (0)1628 556001

Zebra Technologies Asia Pacific, LLC

120 Robinson Road
#06-01 Parakou Building
Singapore 068913
T: +65 6858 0722
F: +65 6885 0838

<http://www.zebra.com>