

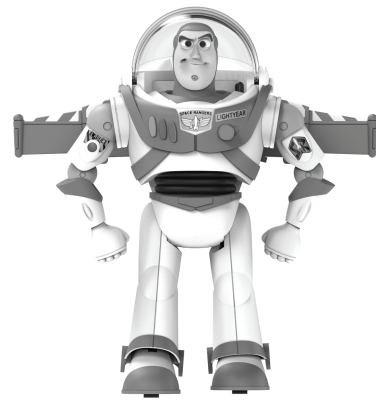

8+

BUZZ LIGHTYEAR Remote Control Figure Instruction Manual

Thank you for purchasing the RC Buzz Lightyear. This manual provides more information about this RC Buzz Lightyear, please read the instructions before using.



Product Overview

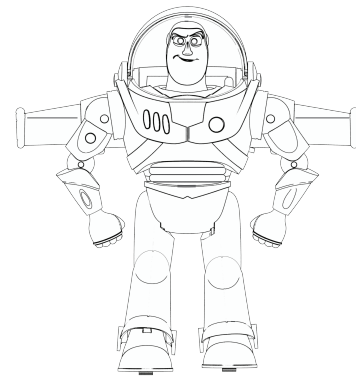

RC Buzz Lightyear

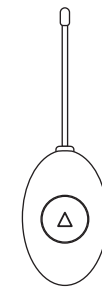

Remote Control

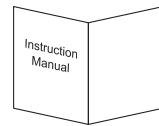

Instruction Manual

Package Contents

- RC Buzz Lightyear x 1
- Remote Controller x 1
- Instruction Manual x 1

Specifications

RC Buzz Lightyear
Power supply: 3 x "AAA" 1.5V Batteries (alkaline type preferred, not included)

Remote Controller:
Power supply: 2 x "AAA" 1.5V Batteries (alkaline type preferred, not included)

Frequency: 27 MHz

Remote Controller

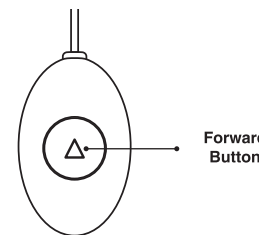

Forward Button

Standard Control

Note: To avoid losing control, always pay attention when controlling the RC Buzz Lightyear.

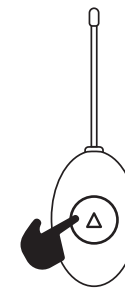

Forward Button

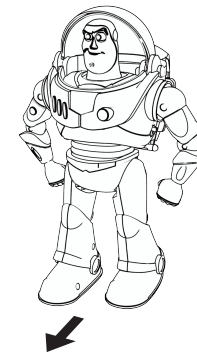

Control RC Buzz Lightyear to move forward

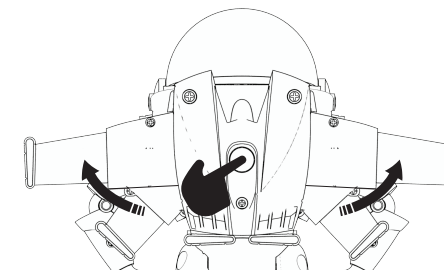

Extend the wings of RC Buzz Lightyear

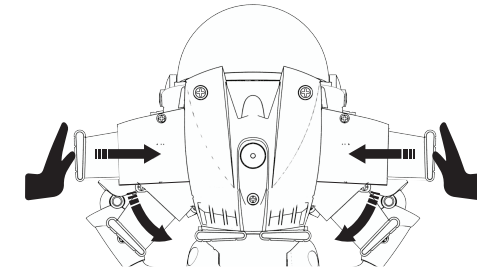

Push the small wings inside the big wings then retract the wings to original position

Power On/Off

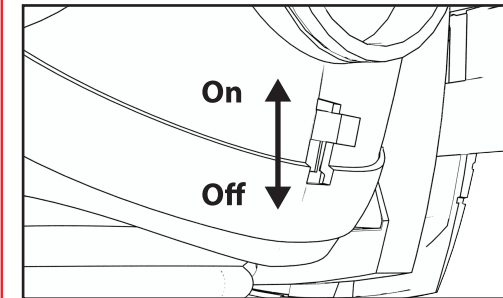

Power On/Off

Slide the ON/OFF Switch to ON to turn on the RC Buzz Lightyear. Slide the ON/OFF Switch to OFF to turn off the RC Buzz Lightyear.

Batteries Installation

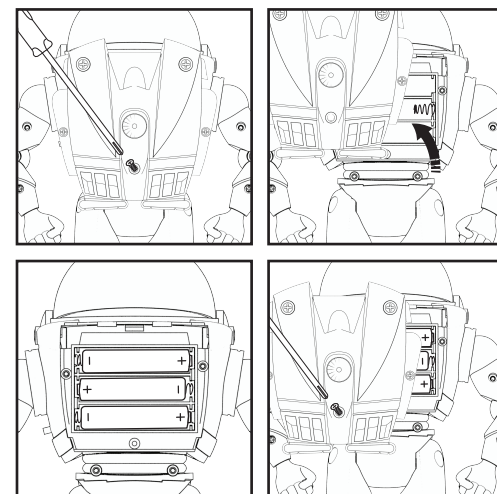

To install batteries into the RC Buzz Lightyear, unscrew the screws on the battery box cover to open the cover. Insert 3 x "AAA" 1.5V batteries (Not Included) into the battery box. Batteries should be placed as shown on the diagram. Replace the battery box cover and tighten the screws.

Notice:

When inserting the batteries, you must insert according to the correct polarity, the RC Buzz Lightyear won't function if batteries are reversed.

Batteries Installation

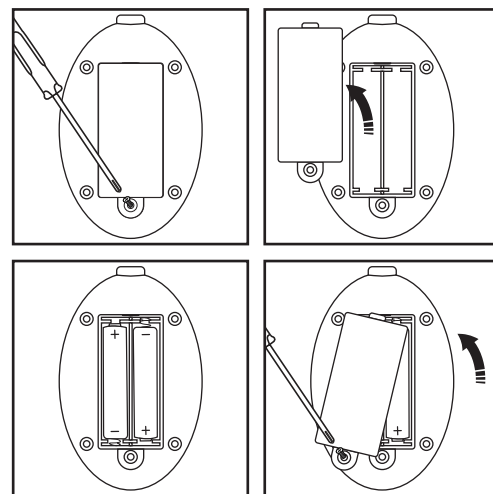

To install batteries into the RC Buzz Lightyear Remote Controller, unscrew the screw on the battery box cover to open the cover. Insert 2 x "AAA" 1.5V batteries (Not Included) into the battery box. Batteries should be placed as shown on the diagram. Replace the battery box cover and tighten the screw.

Notice:

When inserting the batteries, you must insert according to the correct polarity, the RC Buzz Lightyear Remote Controller won't function if batteries are reversed.

Performance Tips

- Do not drive the RC Buzz Lightyear on grass, sand or go through water.
- Do not drive the RC Buzz Lightyear in windy or rainy weather.
- Do not drive the RC Buzz Lightyear into any sharp object.
- Keep fingers, hair and loose clothing away from RC Buzz Lightyear.

Care and Maintenance

Always use dry and soft cloth to clean this product.

Avoid this product from being exposed to sunlight or heat.

Avoid immersing these toys in water, otherwise, the electronic parts may be damaged.

Check the product regularly. If any damages are discovered, please stop using immediately, until it is completely repaired in good working condition.

IMPORTANT: BATTERY INFORMATION

CAUTION:

- TO AVOID BATTERY LEAKAGE
 - Always follow the instructions carefully. Use only batteries specified and be sure to insert them correctly by matching the + and - polarity markings.
 - Do not mix old batteries and new batteries or standard (carbon-zinc) with alkaline batteries.
 - Remove exhausted or dead batteries from the product.
 - Remove batteries if product is not to be played with for a long time.
 - Do not short-circuit the supply terminals.
- Should this product cause, or be affected by local electrical interference, move it away from other electrical equipment. Reset (switching ON/OFF again or removing and re-inserting batteries) if necessary.

Warning

This product is suitable to be used by people who has operating experience in remote toy or aged no less than 8 years old.

Please do not put the product in your mouth to prevent choking hazard of small parts.

Please do not put the finger into available interspaces.

Please do not play the product in a brutal way such as throwing, crashing or twisting it.

Please store the smaller-sized product accessories in places that are out of reach of children, in order to avoid the occurrence of accidents.

Avoid placing the batteries in places in high temperatures and avoid exposure to heat.

When young children are operating the product, it shall be ensured that the adults are guiding and making sure the product control is within the viewing range of the controller (or instructor) so that it makes the control of the toy more convenient.

When the product is not in use, please switch off the power supplies of the toy, and remove the batteries from the product.

Please note that we won't take any responsibility for any wrong operation as this may result in severe injury or loss of property, and we cannot control the operating process during the time when the user assembles or uses this product.

Once this product is sold, we won't be responsible for any safety responsibility during the time the user operates or uses controls this products.

FCC Statement

- This device complies with Part 15 of the FCC Rules. Operation is subject to the following two conditions:
 - This device may not cause harmful interference.
 - This device must accept any interference received, including interference that may cause undesired operation.
- Changes or modifications not expressly approved by the party responsible for compliance could void the user's authority to operate the equipment.

NOTE: This equipment has been tested and found to comply with the limits for a Class B digital device, pursuant to Part 15 of the FCC Rules. These limits are designed to provide reasonable protection against harmful interference in a residential installation. This equipment generates uses and can radiate radio frequency energy and, if not installed and used in accordance with the instructions, may cause harmful interference to radio communications. However, there is no guarantee that interference will not occur in a particular installation. If this equipment does cause harmful interference to radio or television reception, which can be determined by turning the equipment off and on, the user is encouraged to try to correct the interference by one or more of the following measures:

- Reorient or relocate the receiving antenna.
- Increase the separation between the equipment and receiver.
- Connect the equipment into an outlet on a circuit different from that to which the receiver is connected.
- Consult the dealer or an experienced radio/TV technician for help.

RF warning statement:
The device has been evaluated to meet general RF exposure requirement. The device can be used in portable exposure condition without restriction.

FCC ID: 2ADM5-ET-0050



Keep All Relevant Information for Future Reference