



Instructions

**ZEISS IKON**  
S 310

# 1 Loading the camera

Do not load or unload film in direct sunlight.

1<sub>1</sub>

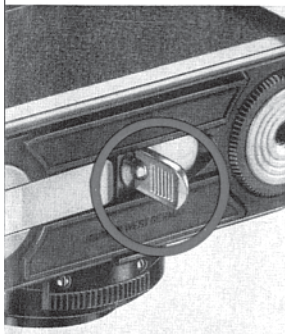

Flip up locking lever of camera back.

1<sub>2</sub>

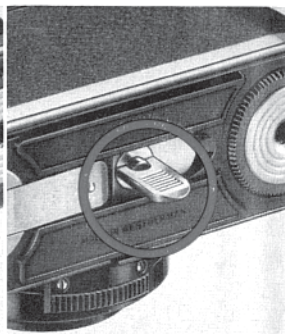

Turn locking lever 90° (to either side).

1<sub>3</sub>

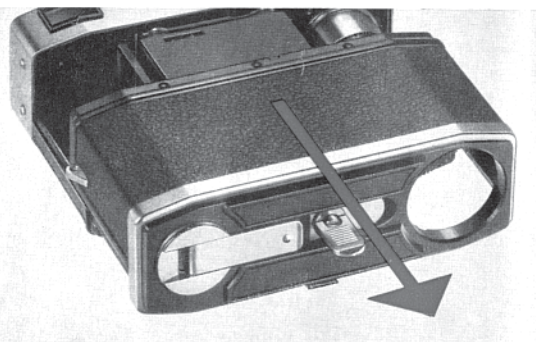

Remove camera back.

14

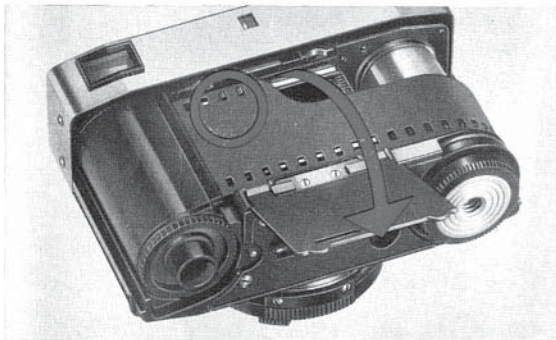

Flip up film pressure plate.  
Insert film cartridge.  
Pull out sufficient leader so that the upper perforations engage in the sprockets of the little red wheel.

15

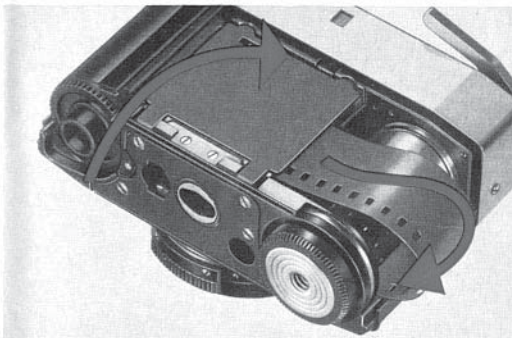

Push approximately one inch of film leader between camera housing and take-up drum. Flip-down film pressure plate.

16

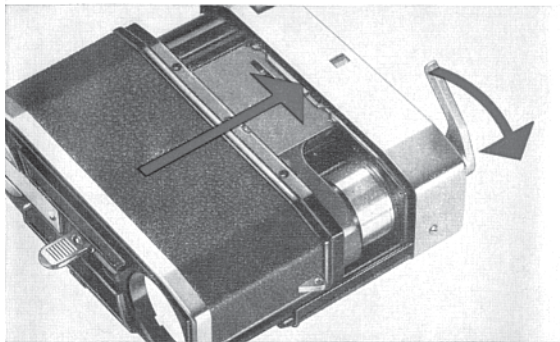

Rotate rapid advance lever until film is advanced by take-up drum and is tightly stretched. The rapid advance lever remains in the "out" position. Safety position! – (The rapid advance lever moves by itself in the original position only at the end of the film leader.) Press shutter release so that rapid advance lever returns to original "rest" position. Replace camera back, push it upward as far as possible and lock it.

17

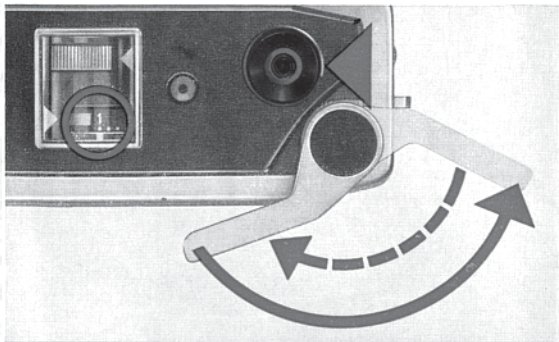

Release shutter and advance film as many times as necessary to bring number 1 in the frame counter over the index mark.

**"READY" POSITION**

The rapid advance lever stays in the "ready" position after film has been advanced to 1. Before closing the eveready case, push the rapid advance lever in the "rest" position (flush against camera body).

18

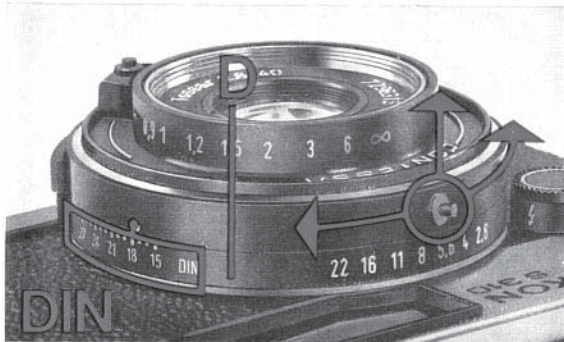

### IMPORTANT Set Film Speed

The speed is indicated in Din and ASA on the film box. Turn diaphragm ring (D) by means of its knurled finger grip to the lower stop. Hold camera from the rear, and keep diaphragm in its position by placing one finger on the knurled finger grip. With the other hand, hold the smooth front section of the ring between thumb and index finger and pull it forward

19

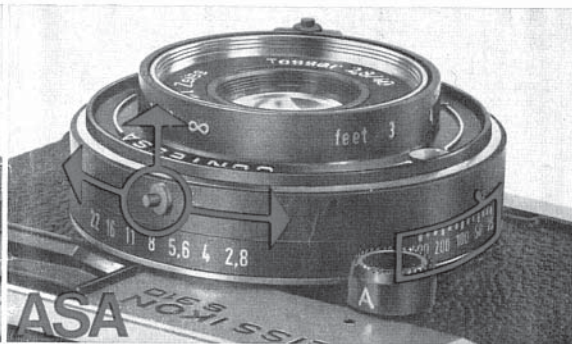

approximately 0.5 mm by means of the small round stop button. This disengages the click stop. Set index over the correct Din or ASA value by turning the ring: The ring clicks in position when it is released.  
**The camera is now ready for picture taking.**

## 2 Rewinding film

2<sub>1</sub>

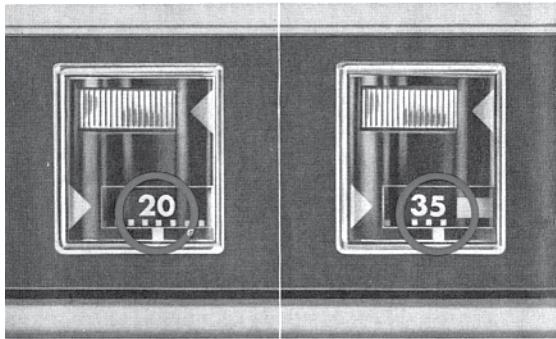

Do not actuate rapid advance lever any more after the last exposure (when film counter indicates 20 or 36 exposures respectively). If you continue taking pictures, the rapid advance lever may stop half-way. Do not use force. Simply press the shutter release. Rapid advance lever then returns to "original" position and you can rewind film. There will be no exposure made.

2<sub>2</sub>

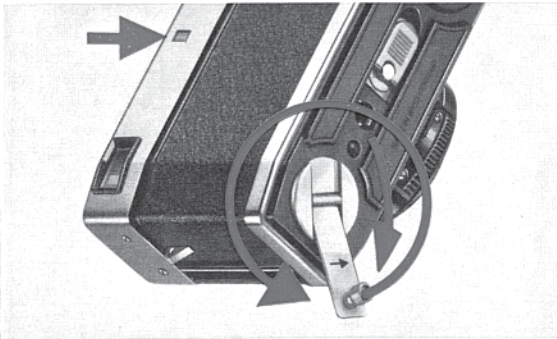

**Always press release before rewinding film.**

(This disengages rewind lock).  
Flip up rewind crank and turn it in direction of arrow until the "flicker" control stands still, or the "clicking" stops. Fold back crank and remove camera back.

## 2<sub>3</sub>

### Rewinding or reloading partially exposed film

**Rewind** as described in 2.2

Note number in film counter on film cartridge.

**Load** as described in 1.4–1.7 but, after releasing the shutter the first time (which is necessary to be able to advance the film) **press shutter release once more and keep it depressed.**

Now, actuate rapid advance lever as often as necessary until film counter indicates the number of exposures already made. For added safety, advance film by one more frame, let go the release button and, turn rapid advance lever completely to its stop.

Set film speed as described under 1.8 or 1.9.

## 3 Power supply

### 3<sub>1</sub>

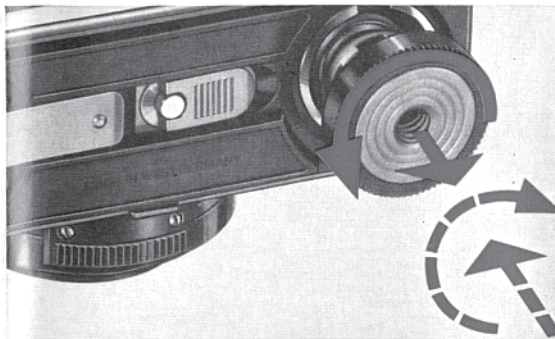

To insert or replace the batteries, unscrew battery holder.

**This can be done at any time.**

Use thin coin or similar object to push out used batteries.

#### **Replacement batteries**

4 batteries of 1.5 V each such as:

Pertrix 246 or Mallory Mn 625 G

Available in camera stores.

3<sub>2</sub>

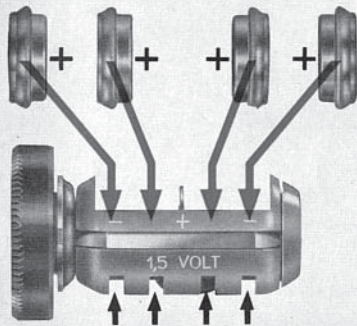

Make certain the contact surfaces are clean and watch polarity. The + side of all batteries must face the contact plate in the middle of the battery holder.

For temporary use, 2 batteries placed together in either the upper or the lower compartment will be sufficient.

3<sub>3</sub>

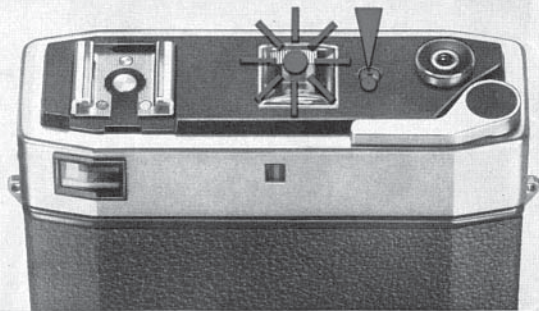

### Checking batteries.

Depress red button.

Control lamp should light up for at least 5 seconds.

If it does not, replace all four batteries.

When camera is not in use, interrupt the circuit. Set knob (E) for flash. Exposure meter needle then does not move any more (see 5.1 and 5.5).



## 4 Camera settings

4<sub>1</sub>

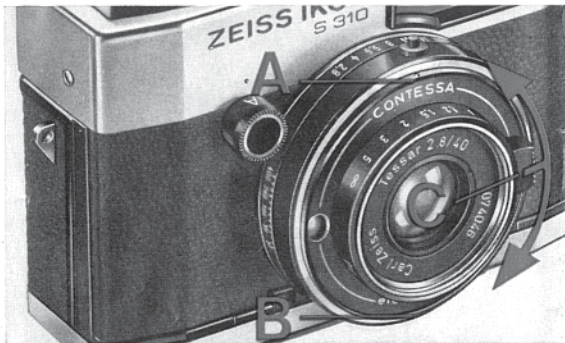

### Distance setting according to scale.

Move finger grip (C) up or down.  
Meter scale on lens mount is visible from above.  
Index point (A).  
Footage scale on lens mount below.  
Index point (B).

4<sub>2</sub>



### Portrait (approx. 4 feet).

### Set distance according to symbol in finder.

Red indicator moves when finger grip (C) is turned.  
The inside frame shows the picture area.

4<sub>2</sub>



Groups (approx. 10 feet).

4<sub>2</sub>



Landscapes (30 feet or more).

43



**Diaphragm setting using exterior scale.**

Turn diaphragm ring with finger grip (D).  
Index point (A).

44

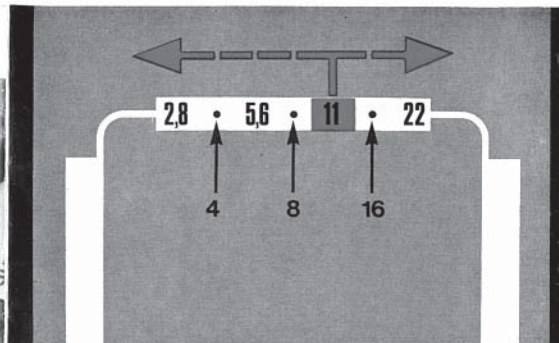

**Diaphragm setting with scale in viewer.**

Red indicator moves when rotating diaphragm ring.



### **Aperture f/2,8**

2.8 = small diaphragm number, but large lens opening.  
Shallow depth of field, but short shutter speed  
(necessary with fast moving subjects).

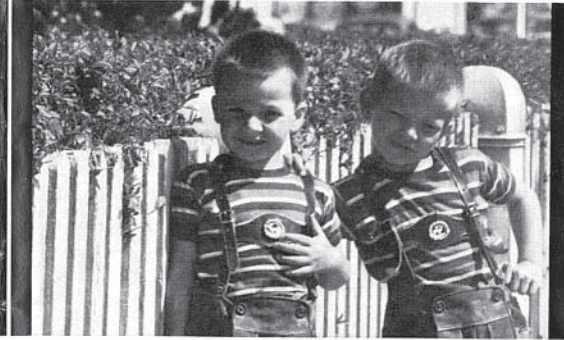

### **Aperture f/22**

22 = large diaphragm number, but small lens opening.  
Great depth of field, but long shutter speed.

## 5 Electronic exposure

5<sub>1</sub>



The electronic exposure works only when:

- Letter "A" (automatic) on knob (E) is visible from above. Watch stop position.
- The photoresistor (F) is not covered by a finger.
- The batteries are inserted properly.

Without batteries, the shutter is always set for  $\frac{1}{500}$  sec. In this case, exposure may be controlled, as far as possible, with diaphragm ring.

The camera automatically chooses the correct shutter speed for the pre-selected diaphragm opening. It is dependent on the lighting conditions and the film speed set on the camera.

5<sub>2</sub>



**Shutter speed indication in finder.**  
Specifically computed for this camera.  
**Not to be transferred to other cameras.**

5<sub>3</sub>

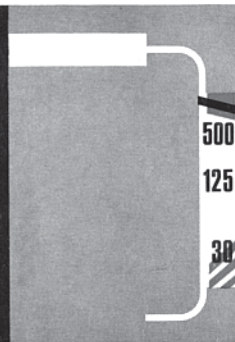

**Indicator in upper warning area**  
**Danger of over exposure.**  
Select smaller diaphragm, if possible.

5<sub>4</sub>

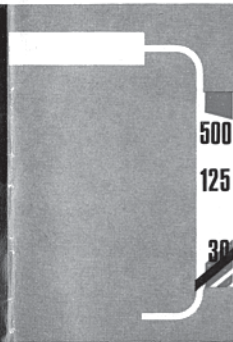

**Indicator in lower warning area**  
**Danger of camera movement**  
Set camera on a steady support.  
**Exposure time up to eight seconds.**  
To save battery power, the shutter closes at the latest after 40 seconds.

5<sub>5</sub>

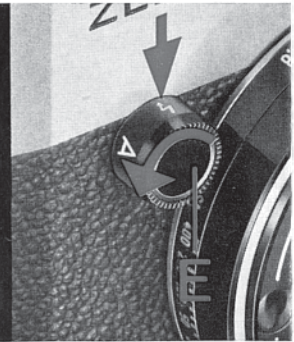

**Intentional interruption of exposure during long exposures.**  
Turn knob (E) to "flash" position.

## 6 Taking the picture

6<sub>1</sub>

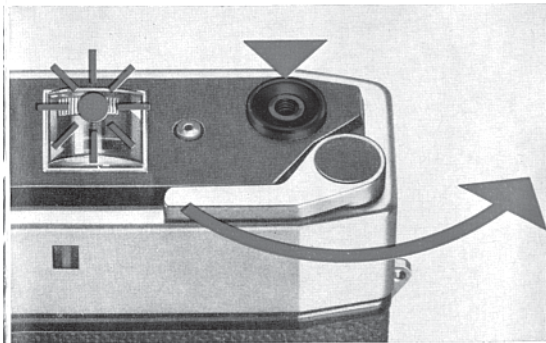

Depress shutter release as far as it goes and let it go,  
Control lamp lights up:

- as long as shutter remains open (control signal for long exposures)
- when using self-timer, after pressing shutter release
- just prior to the point of exposure (ready for exposure). Turn rapid advance lever to its stop after each exposure.

6<sub>2</sub>

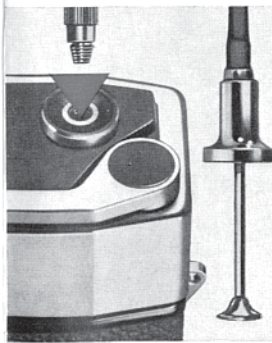

Cable release socket

6<sub>3</sub>

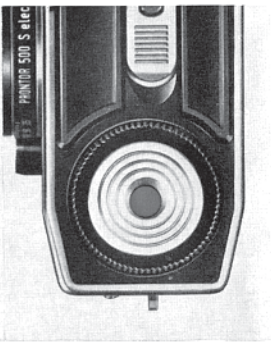

Tripod socket

64

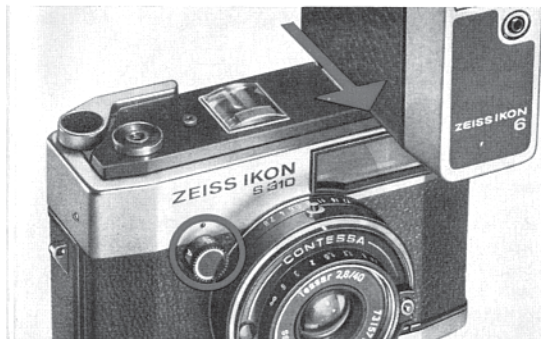

### Flash pictures

Turn knob (E) to its stop so that flash symbol shows on top. Shutter speed, **with batteries inserted**,  $\frac{1}{30}$  sec. The shutter is X-synchronized. Flash units with center contact may be mounted directly on shoe of camera. Flash units with cord require an adapter available in camera stores.

Consult chart supplied with flash unit for proper diaphragm and distance setting.

65

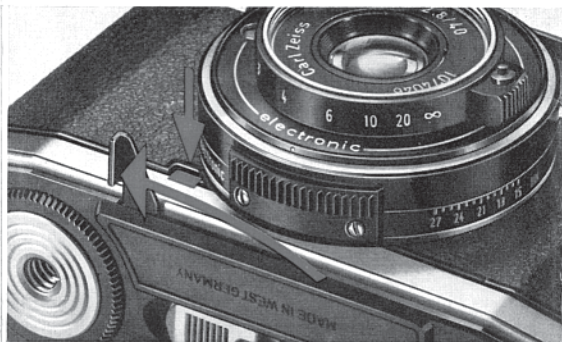

### Use of self-timer

Cock shutter and self-timer.

Red marking indicates self-timer is ready for operation. Self-timer runs for approx. 8 sec. after pressing shutter release.

Use a tripod!



---

## 66

### Use of filters

Make sure filter factor engraved on filter mount (1.5 x, 4 x or 5 x) is properly taken into consideration by readjusting film speed scale on camera. The chart, below, indicates the number of graduation lines by which the film speed must be reduced on the DIN or ASA scale.

**Be certain to reset film speed scale when removing filter.**

Filter	Filter-Factor	Decrease DIN or ASA Film Speed By
Yellow	1.5 x	2 graduation lines
Green	4 x	5 graduation lines
Orange	5 x	7 graduation lines

## Accessories

23.8094	Eveready Case	
23.8100	Leather Pouch	
20.6000	Filter, yellow	for S 30.5 $\phi$
20.6002	Filter, green	black and white S 30.5 $\phi$
20.6003	Filter, orange	film only S 30.5 $\phi$
20.6005	Filter, UV	S 30.5 $\phi$
20.6008	Filter, Skylight	S 30.5 $\phi$
20.5703	Lens Shade (Folding)	S 30.5 $\phi$
20.5801	Close-up Lens F 1	
	f = 1.0 m 1.0 Diopter	S 30.5 $\phi$
20.5802	Close-up Lens F 2	
	f = 0.5 m 2 Diopters	S 30.5 $\phi$
20.0281	Cable Release	

Subject to change in the interest of technical progress.

englisch

GA/10.0351 Printed in West-Germany 3 1270/16-1A  
Author: A. Zimmermann

This document is provided as  
a free service by Mike Elek.

You should not have paid for  
this. If someone sold this to  
you, please let me know at  
[mike@elekm.net](mailto:mike@elekm.net).

Simply throw this page away  
when you print the file.