

Installation and Operating Guide | Warranty

Model Number | XBR413 | VCR / DVD Recorder



Safety Precautions



CAUTION
RISK OF ELECTRIC SHOCK
DO NOT OPEN



CAUTION: TO REDUCE THE RISK OF ELECTRIC SHOCK DO NOT REMOVE COVER (OR BACK) NO USER-SERVICEABLE PARTS INSIDE REFER SERVICING TO QUALIFIED SERVICE PERSONNEL.



This lightning flash with arrowhead symbol within an equilateral triangle is intended to alert the user to the presence of uninsulated dangerous voltage within the product's enclosure that may be of sufficient magnitude to constitute a risk of electric shock to persons.



The exclamation point within an equilateral triangle is intended to alert the user to the presence of important operating and maintenance (servicing) instructions in the literature accompanying the product.

WARNING: TO REDUCE THE RISK OF FIRE OR ELECTRIC SHOCK, DO NOT EXPOSE THIS APPARATUS TO RAIN OR MOISTURE.

CAUTION: TO PREVENT ELECTRIC SHOCK, MATCH WIDE BLADE OF PLUG TO WIDE SLOT, FULLY INSERT.
ATTENTION: POUR ÉVITER LES CHOC ÉLECTRIQUES, INTRODUIRE LA LAME LA PLUS LARGE DE LA FICHE DANS LA BORNE CORRESPONDANTE DE LA PRISE ET POUSSER JUSQU'AU FOND.

WARNING: Do not install this equipment in a confined space such as a bookcase or similar unit.

NOTE TO CABLE/TV INSTALLER: This reminder is provided to call the cable TV system installer's attention to Article 820-40 of the National Electric Code (U.S.A.). The code provides guidelines for proper grounding and, in particular, specifies that the cable ground shall be connected to the grounding system of the building, as close to the point of the cable entry as practical.

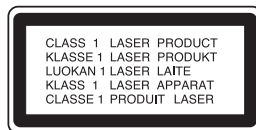

CAUTION:

This VCR/DVD Recorder employs a Laser System.

To ensure proper use of this product, please read this owner's manual carefully and retain for future reference. Should the VCR/DVD Recorder require maintenance, contact an authorized service center.

Use of controls, adjustments, or the performance of procedures other than those specified herein may result in hazardous radiation exposure.

To prevent direct exposure to laser beam, do not try to open the enclosure. Visible laser radiation when open. **DO NOT STARE INTO BEAM.**

CAUTION: The apparatus should not be exposed to water (dripping or splashing) and no objects filled with liquids, such as vases, should be placed on the apparatus.

FCC WARNING: This equipment may generate or use radio frequency energy. Changes or modifications to this equipment may cause harmful interference unless the modifications are expressly approved in the instruction manual. The user could lose the authority to operate this equipment if an unauthorized change or modification is made.

REGULATORY INFORMATION: FCC Part 15

This product has been tested and found to comply with the limits for a Class B digital device, pursuant to Part 15 of the FCC Rules. These limits are designed to provide reasonable protection against harmful interference when the product is operated in a residential installation. This product generates, uses, and can radiate radio frequency energy and, if not installed and used in accordance with the instruction manual, may cause harmful interference to radio communications. However, there is no guarantee that interference will not occur in a particular installation. If this product does cause harmful interference to radio or television reception, which can be determined by turning the product off and on, the user is encouraged to try to correct the interference by one or more of the following measures:

- Reorient or relocate the receiving antenna.
- Increase the separation between the product and receiver.
- Connect the product into an outlet on a circuit different from that to which the receiver is connected.
- Consult the dealer or an experienced radio/TV technician for help.

FCC COMPLIANCE: The responsible party for this product's compliance is: Zenith Electronics Corporation, 2000 Millbrook Drive, Lincolnshire, IL 60069, USA.
Phone: 1-847-941-8000

SERIAL NUMBER: The serial number is found on the back of this VCR/DVD Recorder. This number is for this VCR/DVD Recorder only. You should record requested information here and retain this guide as a permanent record of your purchase.

Model No. _____

Serial No. _____

IMPORTANT SAFETY INSTRUCTIONS

CAUTION: PLEASE READ AND OBSERVE ALL WARNINGS AND INSTRUCTIONS IN THIS OWNER'S MANUAL AND THOSE MARKED ON THE PRODUCT. RETAIN THIS MANUAL FOR FUTURE REFERENCE.

This product has been designed and manufactured to assure personal safety. Improper use can result in electric shock or fire hazard. The safeguards incorporated in this product will protect you if you observe the following procedures for installation, use, and servicing.

This product does not contain any parts that can be repaired by the user.

DO NOT REMOVE THE CABINET COVER, OR YOU MAY BE EXPOSED TO DANGEROUS VOLTAGE. REFER SERVICING TO QUALIFIED SERVICE PERSONNEL ONLY.

- 1. Read these instructions.** - All these safety and operating instructions should be read before the product is operated.
- 2. Keep these instructions.** - The safety, operating and use instructions should be retained for future reference.
- 3. Heed all warnings.** - All warnings on the product and in the operating instructions should be adhered to.
- 4. Follow all instructions.** - All operating and use instructions should be followed.
- 5. Do not use this product near water.** - For example: near a bath tub, wash bowl, kitchen sink, laundry tub, in a wet basement; or near a swimming pool; and other areas located near water.
- 6. Clean only with dry cloth.** - Unplug this product from the wall outlet before cleaning. Do not use liquid cleaners.
- 7. Do not block any ventilation openings. Install in accordance with the manufacturer's instructions.** - Slots and openings in the cabinet are provided for ventilation and to ensure reliable operation of the product and to protect it from over-heating. The openings should never be blocked by placing the product on a bed, sofa, rug or other similar surface. This product should not be placed in a built-in installation such as a bookcase or rack unless proper ventilation is provided or the manufacturer's instructions have been adhered to.
- 8. Do not install near any heat sources such as radiators, heat registers, stoves, or other apparatus (including amplifiers) that produce heat.**
- 9. Do not defeat the safety purpose of the polarized or grounding-type plug.** A polarized plug has two blades with one wider than the other. A grounding type plug has two blades and a third grounding prong. The wide blade or the third prong are provided for your safety. If the provided plug does not fit into your outlet, consult an electrician for replacement of the obsolete outlet.
- 10. Protect the power cord from being walked on or pinched particularly at plugs, convenience receptacles, and the point where they exit from the product.**
- 11. Only use attachments/accessories specified by the manufacturer.**
- 12. Use only with the cart, stand, tripod, bracket, or table specified by the manufacturer, or sold with apparatus. When a cart is used, use caution when moving the cart/product combination to avoid injury from tip-over.**
- 13. Unplug this product during lightning storms or when unused for long periods of time.**
- 14. Refer all servicing to qualified service personnel. Servicing is required when the product has been damaged in any way, such as power-supply cord or plug is damaged, liquid has been spilled or objects have fallen into the product, the product has been exposed to rain or moisture, does not operate normally, or has been dropped.**



Table of Contents

INTRODUCTION

Safety Precautions	2
IMPORTANT SAFETY INSTRUCTIONS	3
Table of Contents	4-5
XBR413 Overview	6-9
Recordable Discs	6
Playable Discs	6
Disc-related terms	6
About DVD-R and DVD-RW disc	7
• What are 'recording modes'?	7
• Is editing a DVD like editing a video tape?	7
• About word 'Original' and 'Playlist'	7
About DVD recording	7-8
• Disc types and recording formats, modes, and settings	7
• Notes for recording	8
• Recording TV audio channels	8
• Restrictions on video recording	8
• What is 'CPRM'?	8
• Copyright	8
Precautions	9
• Handling the unit	9
• Cleaning the unit	9
• Remote Control Operation Range	9
• Remote Control Battery Installation	9
Notes on Discs	9
• Handling discs	9
• Storing discs	9
• Cleaning discs	9
About Symbols	9
• About the  symbol display	9
• About the disc symbols for instructions	9
Front Panel	10
Function Display Window	11
Remote Control Overview	12
Rear Panel	13

DVR HOOKUP

Connections	14-17
Connecting Antenna/Cable TV to VCR/DVD Recorder	14
Connecting to a TV	15
Connecting to Optional Equipment	16
Accessory Audio/Video (A/V) Connections to VCR/DVD Recorder	17
Connecting a Digital Camcorder	17
Before Operation	18-29
Initial Settings	18
• General Operation	18
GENERAL	18-20
• Tuning Band Select	18
• Auto Channel Set	18
• To Add or Erase Channels from Memory	19
• Auto Clock Set	19
• Manual Clock Set	19
• TV Aspect Ratio	20
• Progressive Scan	20
• Factory Setting	20
LANGUAGE	20
• Display Menu	20
• Disc Language	20
AUDIO	21
• Dolby Digital	21
• DTS	21
• MPEG	21
• Sampling Freq. (Frequency)	21
• DRC (Dynamic Range Control)	21
• Vocal	21
LOCK (Parental Control)	22-23
• Movie Rating	22
• Set Password	22
• Country Code	23
RECORD	23-24
• DISC Record Mode	23
• VCR Record Mode	23
• DV Record Audio	24
• Auto Chapter	24
DISC	24-25
• DISC Initialize	24
• DISC Finalize	25
• DISC Protect	25
• DISC Name	26
General Explanation of On-Screen Display	27
• Displaying Information on-screen	27
• Displaying OSD While Watching TV	27
• Changing TV Channels	27
• Changing TV Audio Channel	27
OSD Menu Options by Media Type	28-29
• DVD	28
• VR	28
• Video	29
• VHS	29

Table of Contents

PLAYBACK

Operation with DVD	30-33
Playing a DVD	30
• Moving to another TITLES	30
• Moving to another CHAPTERs	30
• Slow Motion	30
• Still Picture and Frame-by-Frame Playback	31
• Search	31
• Random	31
• Repeat	31
• Repeat A-B	31
• Time Search	32
• Zoom	32
• Marker Search	32
• Disc Menu	32
• Title Menu	32
• Camera Angle	33
• Changing the Audio Language	33
• 3D Surround	33
• Subtitles	33
• Last Condition Memory	33
Audio CD and MP3 Operation	34-35
Playing an Audio CD or MP3 Disc	34
Notes on MP3 Recordings	34
• Pause	35
• Moving to Another Track	35
• Repeat	35
• Random	35
• Search	35
• Repeat A-B	35
Programmed Playback with Audio CD and MP3	36
Photo Disc Operation	37
Viewing a Photo Disc	37
• Selecting other Files	37
• To rotate the picture	37
• To view Slide Show	37
• Notes on JPEG Files	37
VCR Mode Tape Playback	38
Preparation	38
Normal Playback	38
• Tracking Control	38
Special Effect Playback	38
• Search	38
• Still Picture and Frame-by-Frame Playback	38
• Slow Motion	38
• Counter Memory Function	38

RECORDING

Basic Recording	39-40
Basic Recording from a TV	39
Instant Timer Recording	39
Copying from DVD to VCR	40
Copying from VCR to DVD	40
Timer Recording	41
Checking Timer Recording Details	41
Canceling a Timer Recording	41
Stopping a Timer Recording in Progress	41
Timer Recording Troubleshooting	41
Recording from an External Input	42-43
Recording from External Components	42
Recording from a Digital Camcorder	42
Playing Recordings on Other DVD players	42
• Finalizing a Disc	42
What is DV?	43
• DV-Related Messages	43
• Troubleshooting	43



EDITING

VR Mode: Original and Playlist Editing	44-50
Titles, Chapters and Parts	44
Adding Chapter Markers	44
Changing Title or Chapter Thumbnails	44
Using the Original (Title) menu	45
Using the Original (Chapter) menu	45
Using the Playlist (Title) menu	46
Using the Playlist (Chapter) menu	46
Naming a Title	47
Deleting an Original or Playlist Title/Chapter	47
Making a New Playlist	48
Adding Titles/Chapters to the Playlist	48
Combining Two Chapters Into One	49
Moving a Playlist Chapter	49
Deleting a Part	50
Video Mode: Original editing	51
Using the Title List	51
Deleting a Title	51
If the disc has already been finalized	51

REFERENCE

Controlling Your TV with the Supplied Remote	52
Language Code List	53
Country Code List	54
Troubleshooting	55-56
Specifications	57-58

About the symbols for instructions

-  Indicates hazards likely to cause harm to the unit itself or other material damage.
-  Indicates special operating features of this unit.
-  Indicates tips and hints for making the task easier.

XBR413 Overview

Recordable Discs



12cm/8cm, single-sided, single layer disc
Approx. max. recording time (LP mode):
240 minutes (4.7GB), 80 minutes (1.46GB)



12cm/8cm, single-sided, single layer disc
Approx. max. recording time (LP mode):
240 minutes (4.7GB), 80 minutes (1.46GB)

Notes

- This recorder cannot record CD-R or CD-RW discs.
- DVD-R/RW and CD-R/RW discs recorded using a personal computer or a DVD or CD recorder may not play if the disc is damaged or dirty, or if there is dirt or condensation on the recorder's lens.
- If you record a disc using a personal computer, even if it is recorded in a compatible format, there are cases in which it may not play because of the settings of the application software used to create the disc. (Check with the software publisher for more detailed information.)

Playable Discs



DVD
(8 cm/12 cm disc)



Audio CD
(8 cm/12 cm disc)

In addition, the VCR/DVD Recorder can play DVD±R/DVD±RW discs, CD-R/CD-RW discs that contain audio titles, MP3 files, or JPEG files and Kodak Picture CDs.

Notes

- Depending on the conditions of the recording equipment or the CD-R/RW (or DVD±R/±RW) disc itself, some CD-R/RW (or DVD±R/±RW) discs cannot be played on the VCR/DVD Recorder.
- Do not attach any seal or label to either side (the labeled side or the recorded side) of a disc.
- Do not use irregularly shaped CDs (e.g., heart-shaped or octagonal). Doing so may result in malfunctions.

Regional code of the VCR/DVD Recorder and DVDs

This VCR/DVD Recorder is designed and manufactured for playback of Region 1 encoded DVD software. The region code on the labels of some DVD discs indicates which type of VCR/DVD Recorder can play those discs. This VCR/DVD Recorder can play only DVD discs labeled 1 or ALL. If you try to play any other discs, the message "Incorrect region code. Can't playback" will appear on the TV screen. Some DVD discs may not have a region code label even though their playback is prohibited by area limits.



Notes on DVDs

Some playback operations of DVDs may be intentionally fixed by software manufacturers. As this VCR/DVD Recorder plays DVDs according to disc content designed by the software manufacturer, some playback features of the VCR/DVD Recorder may not be available or other functions may be added. Refer also to the instructions supplied with the DVDs. Some DVDs made for business purposes may not be played on the VCR/DVD Recorder.

Disc-related terms

Title (DVD only)

The main film content or accompanying feature content or music album.

Each title is assigned a title reference number enabling you to locate it easily.

Chapter (DVD only)

Sections of a picture or a musical piece that are smaller than titles. A title is composed of one or several chapters. Each chapter is assigned a chapter number to enable you to locate the chapter you want. Depending on the disc, chapters may not be labeled.

Track (Audio CD only)

Sections of a picture or a musical piece on an audio CD. Each track is assigned a number, enabling you to easily locate the track you want.

XBR413 Overview (Continued)

About DVD-R and DVD-RW disc

How are DVD-R and DVD-RW discs different?

The essential difference between DVD-R and DVD-RW is that DVD-R is a record-once medium, while DVD-RW is a re-recordable/erasable medium. You can re-record/erase a DVD-RW disc approximately 1,000 times.

Can I play my recordable discs in a regular DVD player?

Generally, DVD-R discs and DVD-RW discs recorded in Video mode are playable in a regular DVD player, but they must be 'finalized' first. This process fixes the contents of the disc to make them readable to other DVD players as DVD-Video discs. DVD-RW discs recorded in VR (Video Recording) mode are playable in some players.



This indicates a product feature that is capable of playing DVD-RW discs recorded with Video Recording (VR) format.

What are 'Recording modes'?



There are two recording modes available using this recorder: VR mode and Video mode. When recording to a DVD-R disc, recordings are always in Video mode. DVD-RW discs can be formatted for VR mode recording or Video mode recording.

VR mode recording

- 3 different picture quality/recording time settings available (SP, LP, XP)
- Not playable on regular DVD players
- Recordings can be extensively edited

Video mode recording

- 3 different picture quality/recording time settings available (SP, LP, XP)
- Playable on regular DVD players (after finalizing)
- Limited editing features

Many functions of this recorder are dependent on the recording mode. One or more of the symbols (, ) appears by each function explained in this manual so that you can see at a glance whether it's relevant for the disc loaded. You can find more information on disc formats and recording modes on next page.

Note

DVD-Video Format (Video mode) is a new format for recording on DVD-R/RW discs that was approved by the DVD Forum in 2000. You may therefore experience problems playing recordable DVD discs in some players. Symptoms include video artifacts, audio and/or video dropouts and playback suddenly stopping. Our company cannot take responsibility for problems playing discs recorded on this VCR/DVD Recorder in other players.

Is editing a DVD like editing a video tape?

No. When you edit a video tape you need one video deck to play the original tape and another to record the edits. With DVD, you edit by making a 'Playlist' of what to play and when to play it. On playback, the VCR/DVD Recorder plays the disc according to the Playlist.

About word 'Original' and 'Playlist'

Throughout this manual, you will often see the words Original and Playlist to refer to the actual content and the edited version.

- **Original:** content refers to what's actually recorded on the disc.
- **Playlist:** content refers to the edited version of the disc — how the Original content is to be played.

About DVD recording

Notes

- This recorder cannot make recordings on CD-R or CD-RW discs.
- Our company takes no responsibility for recording failure due to power cuts, defective discs, or damage to the recorder.
- Fingerprints and small scratches on a disc can affect playback and/or recording performance. Please take proper care of your discs.

Disc types and recording formats, modes, and settings

This recorder can play three different kinds of DVD disc: pre-recorded DVD-Video discs, DVD-RW and DVD-R discs. The disc format for DVD-R discs is always "Video format"—the same as pre-recorded DVD-Video discs. This means that once finalized, you can play a DVD-R in a regular DVD player.

The recording mode is closely related to the disc format. If the disc format is Video Recording format, then the recording mode is VR mode; if the disc format is Video mode, then the recording mode is Video mode (except for DVD-Video, which is not recordable, and so does not have a recording mode).

Within the recording modes (which are fixed for the whole disc) are the record settings. These can be changed as required for each recording and determine the picture quality and how much space the recording will take up on the disc.

XBR413 Overview (Continued)

Notes for recording

- The recording times shown are not exact because the VCR/DVD Recorder uses variable bit-rate video compression. This means that the exact recording time will depend on the material being recorded.
- When recording a TV broadcast, if the reception is poor or the picture contains interference, the recording times may be shorter.
- If you record still pictures or audio only, the recording time may be longer.
- The displayed times for recording and time remaining may not always add up to exactly the length of the disc.
- The recording time available may decrease if you heavily edit a disc.
- If using a DVD-RW disc, make sure you change the recording format (Video mode or VR mode) before you record anything on the disc. See page 24 (DISC Initialize) for how to do this.
- When using a DVD-R disc, you can keep recording until the disc is full, or until you finalize the disc. Before you start a recording session, check the amount of recording time left on the disc.
- When using a DVD-RW disc in Video mode, recording time available will only increase if you erase the last title recorded on the disc.
- The Erase Title option in the Original (Title) menu only hides the title, it does not actually erase the title from the disc and increase the recording time available (except for the last recorded title on a DVD-RW disc in Video mode).

Recording TV audio channels

This recorder can record one or two channel audio. For TV broadcasts, this usually means mono or stereo, but some programs are broadcast with a main and a SAP (Secondary Audio Program) audio channel. If you're recording in Video mode (or in VR mode), you can record either the main audio or the SAP audio.

Restrictions on video recording

- You cannot record copy-protected video using this recorder. Copy-protected video includes DVD-Video discs and some satellite broadcasts. If copy-protected material is encountered during a recording, recording will pause or stop automatically and an error message will be displayed on-screen.
- Video that is 'copy-once only' can only be recorded using a DVD-RW disc in VR mode with CPRM (see below).

What is 'CPRM'?

CPRM is a copy protection system (with scramble system) only allowing the recording of 'copy once' broadcast programs. CPRM stands for Content Protection for Recordable Media.

This recorder is CPRM compatible, which means that you can record copy-once broadcast programs, but you cannot then make a copy of those recordings. CPRM recordings can only be made on DVD-RW discs formatted in VR mode, and CPRM recordings can only be played on players that are specifically compatible with CPRM.

Copyright

- Audio and video recordings you make using this recorder are for your personal use only. You may not sell, lend or rent them to other people.
- This product incorporates copyright protection technology that is protected by method claims of certain U.S. patents and other intellectual property rights owned by Macrovision Corporation and other rights owners. Use of this copyright protection technology must be authorized by Macrovision Corporation, and is intended for home and other limited viewing uses only unless otherwise authorized by Macrovision corporation. Reverse engineering or disassembly is prohibited.

Disc type	Disc format	Recording mode	Functions
DVD-Video	Video format	n/a	Playback only
DVD-RW	Video Recording format (default)	VR mode	Playback, recording, Original/Playlist editing
	Video format	Video mode	Playback, limited recording, limited editing
DVD-R	Video format	Video mode	Playback, limited recording, limited editing
DVD+R	Video format	n/a	Playback only
DVD+RW	Video format	n/a	Playback only

XBR413 Overview (Continued)

Precautions

Handling the unit

When shipping the unit

The original shipping carton and packing materials come in handy. For maximum protection, re-pack the unit as it was originally packaged at the factory.

When setting up the unit

The picture and sound of a nearby TV, VCR, or radio may be distorted during playback. In this case, position the unit away from the TV, VCR, or radio, or turn off the unit after removing the disc.

To keep the surface clean

Do not use volatile liquids, such as insecticide spray, near the unit. Do not leave rubber or plastic products in contact with the unit for a long period of time. They will leave marks on the surface.

Cleaning the unit

To clean the cabinet

Use a soft, dry cloth. If the surfaces are extremely dirty, use a soft cloth lightly moistened with a mild detergent solution. Do not use strong solvents such as alcohol, benzene, or thinner, as these might damage the surface of the unit.

To obtain a clear picture

The VCR/DVD Recorder is a high-tech, precision device. If the optical pick-up lens and disc drive parts are dirty or worn, the picture quality will be poor. Regular inspection and maintenance are recommended after every 1,000 hours of use. (This depends on the operating environment.)
For details, please contact your nearest dealer.

Remote Control Operation Range

Point the remote control at the remote sensor and press the buttons.

- **Distance:** About 23 ft (7 m) from the front of the remote sensor.
- **Angle:** About 30° in each direction of the front of the remote sensor.

Remote Control Battery Installation

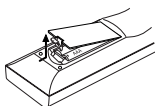

Detach the battery cover on the rear of the remote control, and insert two R03 (size AAA) batteries with **+** and **-** aligned correctly.



Caution

Do not mix old and new batteries. Never mix different types of batteries (standard, alkaline, etc.).

Notes on Discs

Handling discs

Do not touch the playback side of the disc. Hold the disc by the edges so that fingerprints will not get on the surface. Do not stick paper or tape on the disc.



Storing discs

After playing, store the disc in its case. Do not expose the disc to direct sunlight or sources of heat, or leave it in a parked car exposed to direct sunlight, as there may be a considerable temperature increase inside the car.

Cleaning discs

Fingerprints and dust on the disc can cause poor picture quality and sound distortion. Before playing, clean the disc with a clean cloth. Wipe the disc from the center outward.

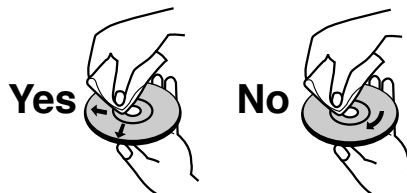

Do not use strong solvents such as alcohol, benzene, thinner, commercially available cleaners, or anti-static spray intended for older vinyl records.







About Symbols

About the symbol display

“  ” may appear on the TV screen during operation. This icon means the function explained in this owner's manual is not available on that specific disc.

About the disc symbols for instructions

A section whose title has one of the following symbols are applicable only to those discs represented by the symbol.

-  DVD-R/RW with Video recording mode
-  DVD-RW with VR recording mode
-  DVD-Video disc
-  Audio CDs.
-  MP3 Discs.
-  JPEG Discs.
-  VHS Tape.

Front Panel

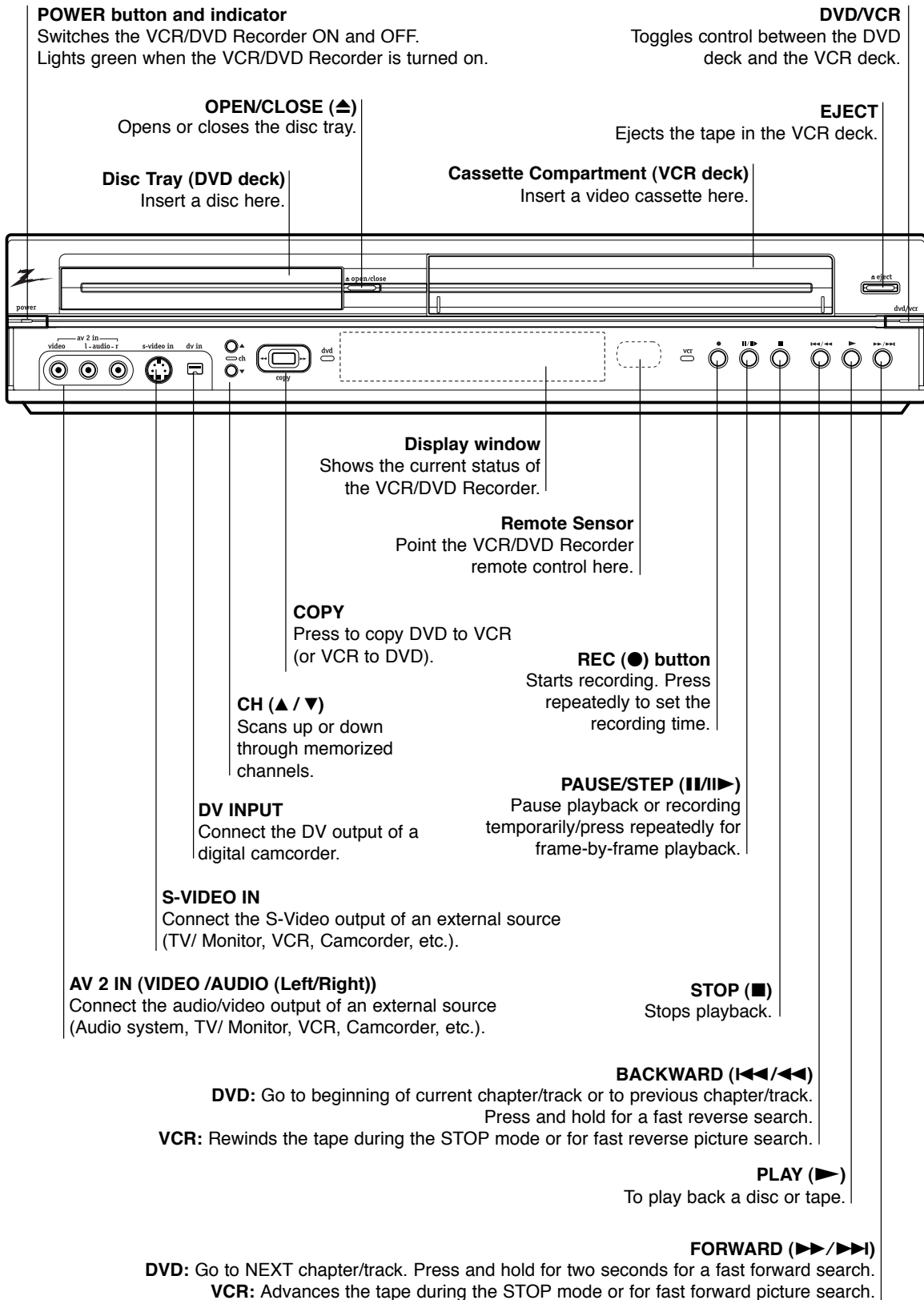

Function Display Window

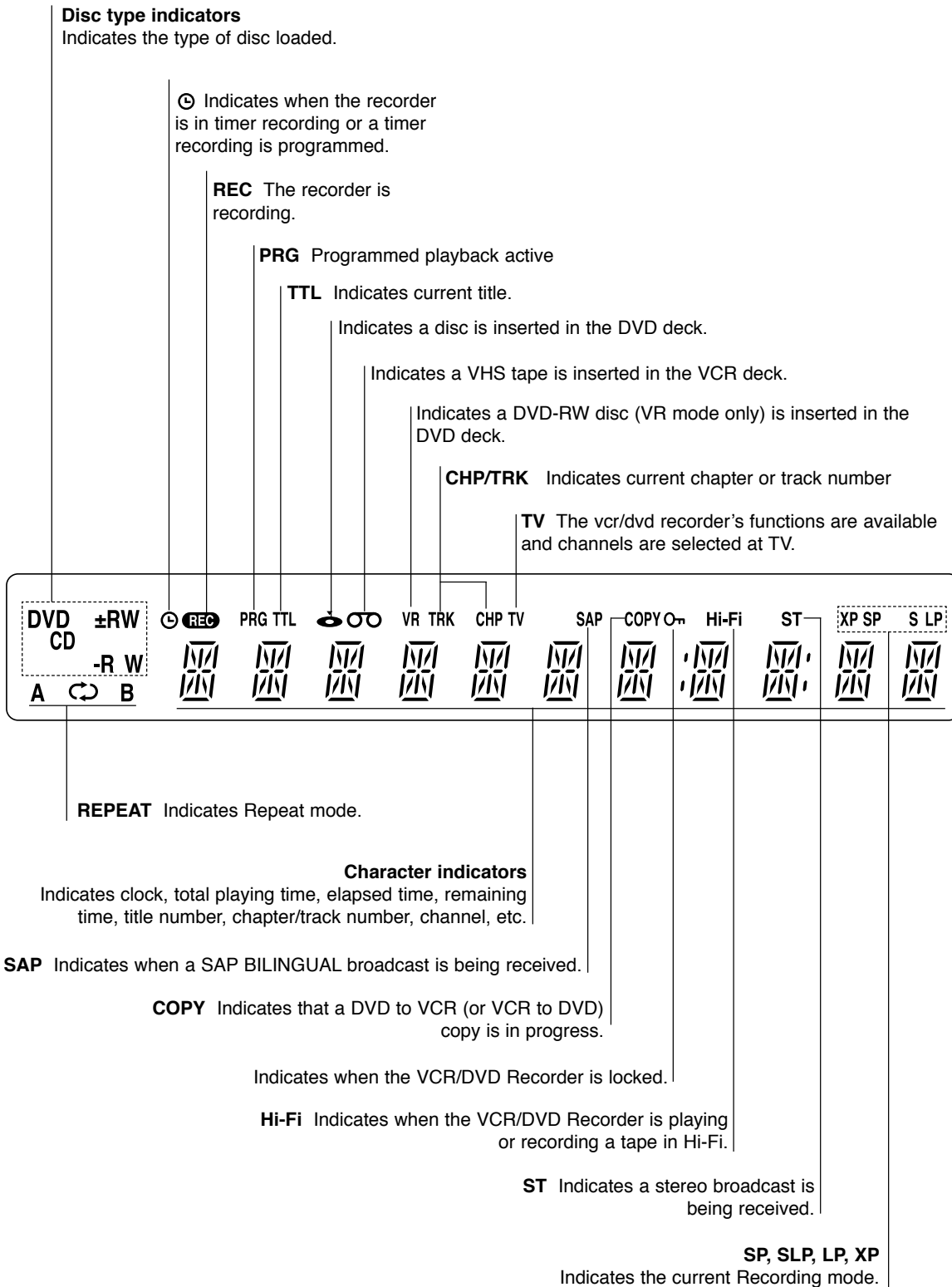

Remote Control Overview

POWER
Turns VCR/DVD Recorder ON and OFF.

TV/VCR
To view channels selected by the VCR tuner or by the TV tuner.

DVD
Select the VCR/DVD Recorder's function mode to DVD.

VCR
Select the VCR/DVD Recorder's function mode to VCR.

INPUT
Changes the input to use for recording (Tuner, AV1, AV2, or DV IN).

0-9 numerical buttons
Selects numbered options in a menu.
Selects TV's channel.

TV Control Buttons
POWER: Switches TV ON and OFF.
Input: Selects the TV's source.
CH +/-: Selects TV's channel.
VOL +/-: Adjusts TV's volume.
MUTE: Turns on or off TV sound.

REC MODE
Selects the recording mode:
- DVD : SP, LP, or XP.
- VCR : SP or SLP.

TIMER REC
Displays Timer Record menu.

REC (●)
Starts recording. Press repeatedly to set the recording time.

BACKWARD / FORWARD (◀▶)
- DVD: Search backward or forward.
- VCR: Rewinds/Advances the tape during the STOP mode, for fast reverse/forward picture search.

SKIP (◀◀ / ▶▶)
Go to next chapter or track. Returns to beginning of current chapter or track or go to previous chapter or track.

AUDIO
Selects an audio language (DVD) or an audio channel.

SUBTITLE
Selects a subtitle language.

ANGLE
Selects a DVD camera angle, if available.

ZOOM
Enlarges DVD video image.

LOCK

The Lock feature disables the front panel buttons to prevent children from tampering with the VCR/DVD Recorder. Simply press LOCK on the remote control to toggle this feature on and off.

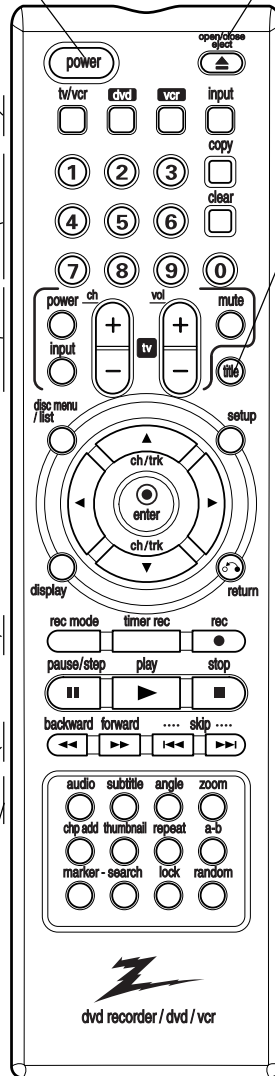

OPEN/CLOSE, EJECT

- Opens and closes the disc tray.
- Ejects the tape in the VCR deck.

COPY

Press to copy DVD to VCR (or VCR to DVD).

CLEAR

Removes a mark on the Marker Search menu.

TITLE

Displays the disc's Title menu, if available.

DISC MENU / LIST

Accesses menu on a DVD disc. Switches between Original and Playlist editing in VR mode.

SETUP

Accesses or removes the Setup menu.

DISPLAY

Accesses On-Screen Display. Displays information while viewing a TV program.

RETURN (↶)

Exits or returns to previous screen in Setup menu.

◀ ▶ ▲ ▼ (left/right/up/down)

Selects menu options.

CH/TRK(▲/▼)

Selects channels in VCR mode. Manually adjusts tracking.

ENTER

Confirms menu selections.

PAUSE/STEP (||)

Pause playback or recording temporarily, press again to exit pause mode. press repeatedly for frame-by-frame playback.

PLAY (▶)

Starts playback.

STOP (■)

Stops playback or recording.

CHP ADD

Inserts a chapter marker when playing/recording a DVD-RW disc in VR mode.

THUMBNAIL

Selects a thumbnail picture for the current title for use in the Original (Title).

REPEAT

Repeat chapter, track, title or all.

A-B

Repeats sequence between two points (A and B)

MARKER

Marks any point during playback.

SEARCH

Displays Marker Search menu.

LOCK

Locks/unlocks front panel buttons.

RANDOM

Plays tracks in random order.

Rear Panel

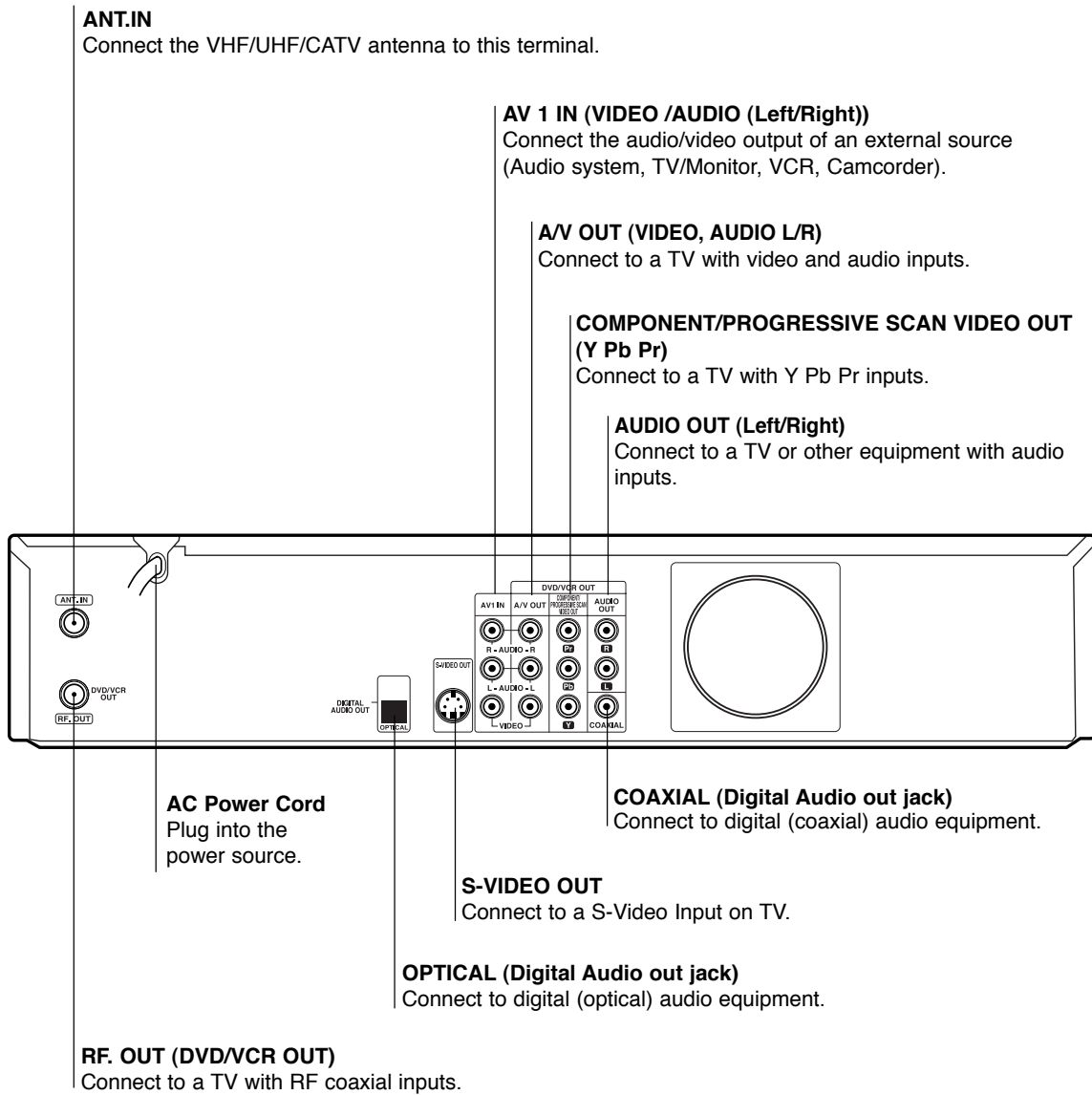

Caution

Do not touch the inner pins of the jacks on the rear panel. Electrostatic discharge may cause permanent damage to the VCR/DVD Recorder.

Connections

Tips

- Depending on your TV and other equipment you wish to connect, there are various ways you could connect the VCR/DVD Recorder. Use only one of the connections described below.
- Please refer to the manuals of your TV, VCR, Stereo System or other devices as necessary to make the best connections.
- For better sound reproduction, connect the recorder's AUDIO OUT jacks to the audio in jacks of your amplifier, receiver, stereo or audio/video equipment. See "Connecting to Optional Equipment" on page 16.

Caution

- Make sure the VCR/DVD Recorder is connected directly to the TV. Tune the TV to the correct video input channel.
- Do not connect the VCR/DVD Recorder's AUDIO OUT jack to the phono in jack (record deck) of your audio system.
- Do not connect your VCR/DVD Recorder via your VCR. The DVD image could be distorted by the copy protection system.

Cable Service Without Cable Box

If your cable wire is connected to your TV without a converter or descrambler box, unscrew the wire from your TV and attach it to the ANT.IN jack on the VCR/DVD Recorder. Use the supplied round coaxial cable to connect between the VCR/DVD Recorder's OUT TO TV jack and the 75 ohm antenna input jack on the TV. With this connection, you can receive all midband, super band, and hyperband channels. (All cable channels.)

Cable Service With Cable Box

If a converter is required in your cable system, follow the instruction below:

The cable hookup permits both TV and VCR/DVD Recorder operation.

To view or record a CATV channel

- 1 Tune the TV to the correct video input channel.
- 2 Set the VCR/DVD Recorder channel selector to the output channel of the Cable Converter box using CH (▲ / ▼) or number (0-9) of your VCR/DVD Recorder. (Example: CH3)
- 3 Select the channel to view at the Cable Converter Box.

Note

If you are using a cable box to tune channels, it is not necessary to do Auto Channel Set as indicated on page 18.

Connecting Antenna/Cable TV to VCR/DVD Recorder

- 1 Disconnect the antenna leads from the rear of the TV.
- 2 Identify the type of cable from your antenna. If it is a round cable as illustrated, it is a 75 ohm coaxial antenna cable. This cable will connect directly to the jack marked ANT.IN on your Recorder.

Tip

If your antenna lead wire is a flat type antenna cable, connect it to an Antenna Adapter (300-ohm to 75-ohm) (not supplied) and slip the Adapter onto the ANT.IN jack. The Adapter does not screw on to the VCR/DVD Recorder, it just slips over the jack.

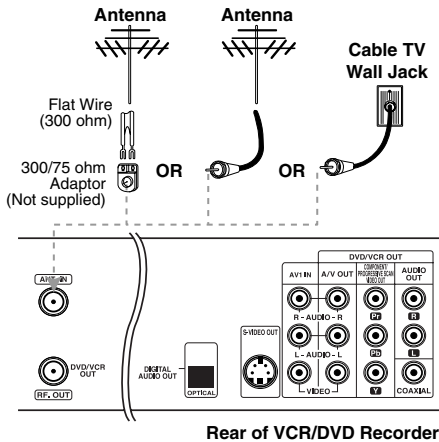
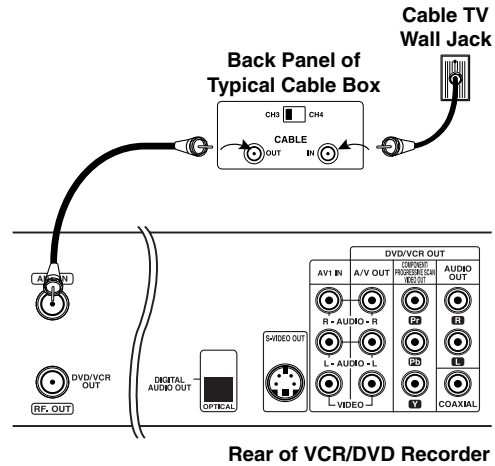

Connections (Continued)

Connecting to a TV

- Make one of the following connections, depending on the capabilities of your existing equipment.

RF coaxial connection

Connect the RF.OUT jack on the VCR/DVD Recorder to the antenna in jack on the TV using the 75-ohm Coaxial Cable supplied (R).

Note

If you use this connection, tune the TV to the VCR/DVD Recorder's RF output channel (CH 3 or 4).

How to set the VCR/DVD Recorder's RF output channel

When the VCR/DVD Recorder is turned off, press and hold CH (▲/▼) on the front panel for about five seconds to change the RF output channel (CH 03 or CH 04). "RF 03" or "RF 04" appears in the display window.

Audio/Video connection

- 1 Connect the VIDEO OUT jack on the VCR/DVD Recorder to the video in jack on the TV using the video cable (V).
- 2 Connect the Left and Right AUDIO OUT jacks from the VCR/DVD Recorder to the audio left/right in jacks from the TV using the audio cables (A).

S-Video connection

- 1 Connect the S-VIDEO OUT jack on the VCR/DVD Recorder to the S-Video in jack on the TV using the S-Video cable (S).
- 2 Connect the Left and Right AUDIO OUT jacks from the VCR/DVD Recorder to the audio left/right in jacks on the TV using the audio cables (A).

Component Video (Color Stream®) connection

- 1 Connect the COMPONENT/PROGRESSIVE SCAN VIDEO OUT jacks on the VCR/DVD Recorder to the corresponding in jacks on the TV using an Y Pb Pr cable (C).
- 2 Connect the Left and Right AUDIO OUT jacks from the VCR/DVD Recorder to the audio left/right in jacks on the TV using the audio cables (A).

Progressive Scan (ColorStream® pro) connection

- If your television is a high-definition or "digital ready" television, you may take advantage of the VCR/DVD Recorder's progressive scan output for the highest video resolution possible.
- If your TV does not accept the Progressive Scan format, the picture will appear scrambled if you try Progressive Scan on the VCR/DVD Recorder.

- 1 Connect the COMPONENT/PROGRESSIVE SCAN VIDEO OUT jacks on the VCR/DVD Recorder to the corresponding in jacks on the TV using an optional Y Pb Pr cable (C).

- 2 Connect the Left and Right AUDIO OUT jacks from the VCR/DVD Recorder to the audio left/right in jacks on the TV using the supplied audio cables (A).

Notes

- Set Progressive Scan option to "ON" in the General menu, see page 20.
- Progressive Scan does not work with the RF, Audio/Video or S-Video connections.

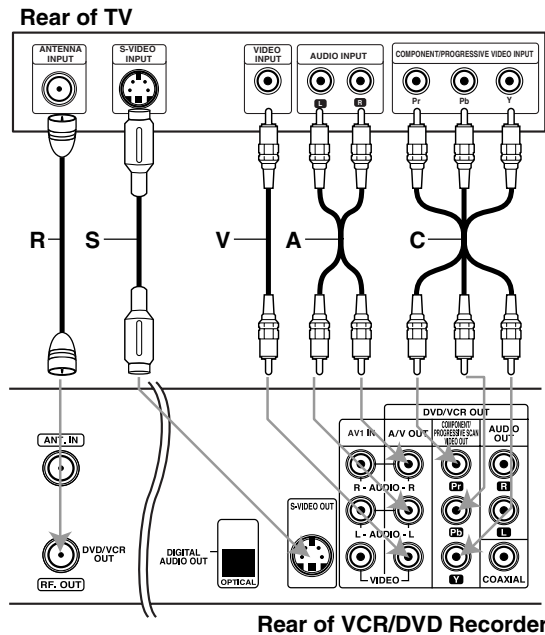

Connections (Continued)

Connecting to Optional Equipment

Connecting to an amplifier equipped with two channel analog stereo or Dolby Pro Logic II/ Pro Logic

Connect the Left and Right AUDIO OUT jacks on the VCR/DVD Recorder to the audio left and right in jacks on your amplifier, receiver, or stereo system, using the audio cables (A).

Connecting to an amplifier equipped with two channel digital stereo (PCM) or to an Audio/ Video receiver equipped with a multi-channel decoder (Dolby Digital™, MPEG 2, or DTS)

- 1 Connect one of the VCR/DVD Recorder's DIGITAL AUDIO OUT jacks (OPTICAL O or COAXIAL X) to the corresponding in jack on your amplifier. Use an optional digital (optical O or coaxial X) audio cable.
- 2 You will need to activate the recorder's digital output. (See "AUDIO" on page 21).

Digital Multi-channel sound

A digital multi-channel connection provides the best sound quality. For this you need a multi-channel Audio/Video receiver that supports one or more of the audio formats supported by your VCR/DVD Recorder (MPEG 2, Dolby Digital and DTS). Check the receiver manual and the logos on the front of the receiver.



Caution:

Due to the DTS Licensing agreement, the digital output will be in DTS digital out when DTS audio stream is selected.

Notes

- If the audio format of the digital output does not match the capabilities of your receiver, the receiver will produce a strong, distorted sound or no sound at all.
- Six Channel Digital Surround Sound via digital connection can only be obtained if your receiver is equipped with a Digital Multi-channel decoder.
- To see the audio format of the current DVD in the on-screen display, press AUDIO.

Note

This VCR/DVD Recorder does not perform internal (2 channel) decoding of a DTS sound track. To enjoy DTS multi channel surround, you must connect this VCR/DVD Recorder to a DTS compatible receiver via one of this VCR/DVD Recorder's digital audio outputs.

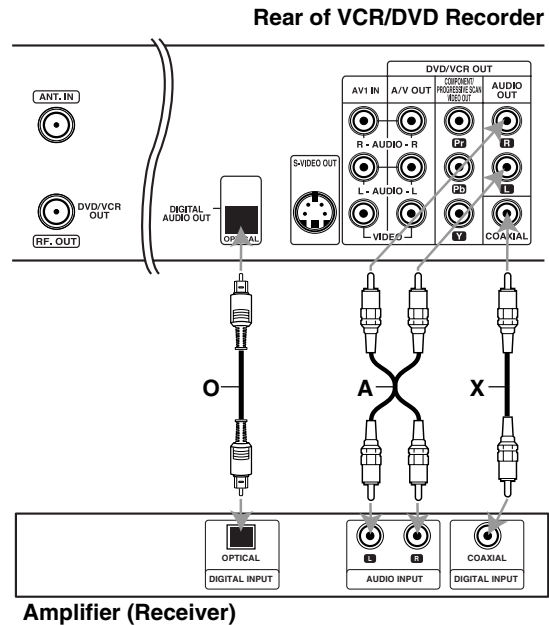

Connections (Continued)

Accessory Audio/Video (A/V) Connections to VCR/DVD Recorder

Connect the AV 1 IN or AV 2 IN jacks on the VCR/DVD Recorder to the audio/video out jacks on your accessory component, using optional audio/video cables.

Note

If you use the S-VIDEO IN jack on the front panel, the VIDEO jack on the front panel is not available.

Jack panel of Accessory Component
(VCR, Camcorder, etc.)

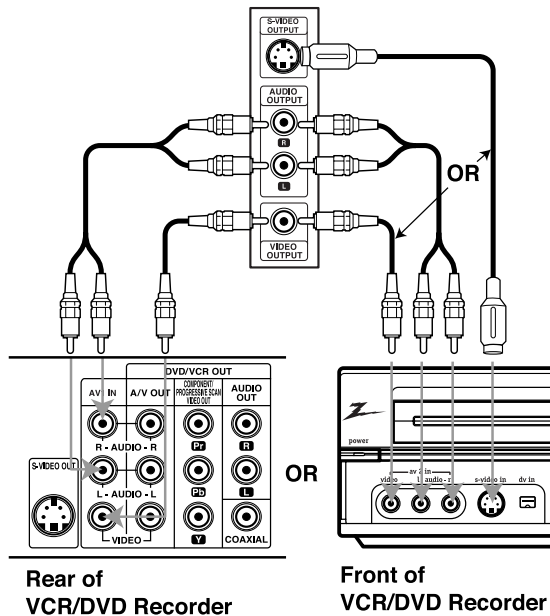

Connecting a Digital Camcorder

Using the front panel DV IN jack, it is possible to connect a DV digital camcorder or video deck or DVD-R/RW recorder and digitally transfer DV tapes or DVD-R/RW discs to DVD-R/RW.

Use a DV cable (not supplied) to connect the DV in/out jack of your DV Digital Camcorder to the front panel DV IN jack of this VCR/DVD Recorder.

Note

This jack is for connection to DV equipment only. It is not compatible with digital satellite tuners or D-VHS video decks.

DV Digital Camcorder

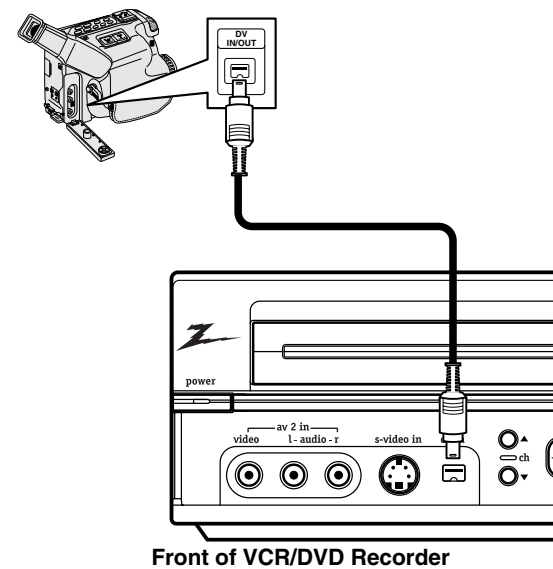

DVR HOOKUP

Before Operation

Initial Settings

In this menu system, there are several ways to customize the settings provided. Most menus consist of three levels to set up the options, but some require greater depth for the variety of settings. If you press SETUP, only the first and second level of the menu system will appear on the TV screen. The third level can be displayed by pressing ►. For navigating the menu levels, you will see “►” on the right side of the menu label to help you go to the next level.

To bring up and exit the Menu:

Press SETUP to bring up the menu. A second press of SETUP will take you back to initial screen.

To go to the next level:

Press ► on the remote control.

To go back to the previous level:

Press ◀ on the remote control.

General Operation

- 1 Press SETUP.**
The Setup menu appears.
- 2 Use ▲ / ▼ to select the desired option.**
- 3 While the desired item is selected, press ► to move to the second level.**
- 4 Use ▲ / ▼ to select the second desired option.**
- 5 Press ► to move to the third level.**
- 6 Use ▲ / ▼ to select the desired setting then press ENTER to confirm your selection.**
Some items require additional steps.
- 7 Press SETUP to exit the Setup menu.**

GENERAL

Tuning Band Select

- 1 Press SETUP.**
The Setup menu appears.
- 2 Use ▲ / ▼ to select the GENERAL option.**
- 3 While the GENERAL option is selected, press ► to move to the second level.**
- 4 Use ▲ / ▼ to select the Tuning Band option.**
- 5 Press ► to move to the third level.**
- 6 Use ▲ / ▼ to select the tuning band option (TV or CATV) then press ENTER.**

TV: If you are using a standard antenna to receive channels.
CATV: If you are using basic cable to receive channels.

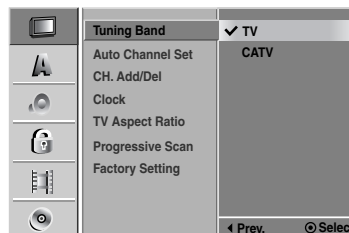

Auto Channel Set

This VCR/DVD Recorder is equipped with a frequency synthesized tuner capable of receiving up to 181 channels. These include VHF channels 2-13, UHF channels 14-69 and CATV channels 1-125.

Preparation:

- Connect the VCR/DVD Recorder to the desired type of antenna or cable TV system, as shown in “Connecting Antenna/Cable TV to VCR/DVD Recorder” on page 14

- 1 Press SETUP.**
The Setup menu appears.
- 2 Use ▲ / ▼ to select the GENERAL option.**
- 3 While the GENERAL option is selected, press ► to move to the second level.**
- 4 Use ▲ / ▼ to select the Auto Channel Set option.**
- 5 Press ► to move to the third level.**
Start icon is highlighted.
- 6 Press ENTER to begin the channel search.**
The tuner will automatically cycle through all available channels in the area and place them in the tuner’s memory.

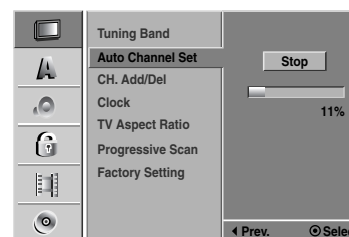

Note

After the Auto Channel Set proceeding is complete, make sure the Tuning Band is set appropriately (TV or CATV) on tuning band, follow steps 1~6 as shown previous (Tuning Band Select) to choose the correct Tuning Band (TV or CATV).

Before Operation (Continued)

To Add or Erase Channels from Memory

This feature allows you to add to or erase channels from memory manually.

- 1 Follow steps 1-3 as shown above to the previous page (Auto Channel Set).
- 2 Use ▲ / ▼ to select the CH. Add/Del option.
- 3 Press ► to move to the third level. Edit icon is highlighted.
- 4 Press ENTER. The Channel Edit menu appears.



- 5 Use ▲ / ▼ or number buttons to select a channel to add or delete then press ENTER. Add or Delete icon is highlighted.
- 6 Press ENTER to confirm your setting.
- 7 Repeat steps 5-6 to add or erase additional channels.

Auto Clock Set

The VCR/DVD Recorder gives you two ways to set the time and date: the Auto Clock Feature or manually. The Auto Clock Feature enables the VCR/DVD Recorder to set up the clock when the VCR/DVD Recorder is turned off.

The Clock Set feature is set to Auto at the factory. In the "Auto" setting, the VCR/DVD Recorder looks for a channel carrying XDS (Extended Data Services) information. XDS updates the clock using the Coordinated Universal Time.



- 1 Press SETUP. The Setup menu appears.
- 2 Use ▲ / ▼ to select the GENERAL menu.
- 3 While the GENERAL menu is selected, press ► to move to the second level.
- 4 Use ▲ / ▼ to select the Clock option.

- 5 Press ► to move to the third level.

- 6 Use ▲ / ▼ to select the Auto option then press ENTER.

The Auto option is set at the factory. In the Auto option, the VCR/DVD Recorder looks for a channel carrying XDS (Extended Data Services) information. XDS updates the clock using the Coordinated Universal Time.

- 7 Use ▲ / ▼ to choose your Time Zone.

You can set your local Time Zone manually. When Timezone is set to Auto, the VCR/DVD Recorder will use XDS information to determine the proper setting.

- 8 Use ► to choose the Daylight Savings option. Use ▲ / ▼ to choose Auto, On, or Off.

You can turn Daylight Savings On or Off manually. When it is set to Auto, the VCR/DVD Recorder will use XDS information to determine the proper setting.

- 9 Press ENTER to confirm your setting, then press SETUP to exit the Setup menu.

Note

If your local TV station does not send date and time information, or sends incorrect information, you can set the clock manually.

Manual Clock Set

- 1 Follow steps 1-5 as shown above to the left (Auto Clock Set).
- 2 Use ▲ / ▼ to select the Manual option then press ENTER.



- 3 Enter the necessary information for date and time.

◀ / ▶ (left/right): Moves the cursor to the previous or next column.

▲ / ▼ (up/down): Changes the setting at the current cursor position.

- 4 Press ENTER to confirm your setting, then press SETUP to exit the Setup menu.

Before Operation (Continued)

TV Aspect Ratio

4:3 Letter Box: Select when a standard 4:3 TV is connected. Displays theatrical images with masking bars above and below the picture.

4:3 Pan Scan: Select when a standard 4:3 TV is connected. Displays pictures cropped to fill your TV screen. Both sides of the picture are cut off.

16:9 Wide: Select when a 16:9 wide TV is connected.

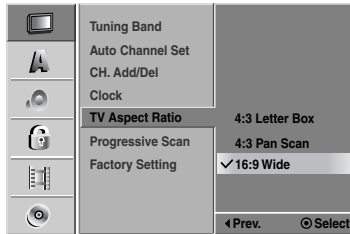

Progressive Scan

Progressive Scan Video provides the highest quality pictures with less flickering.

- If you are using the COMPONENT/PROGRESSIVE SCAN VIDEO OUT jacks, but are connecting the VCR/DVD Recorder to a standard (analog) television, set Progressive Scan to OFF.
- If you are using the COMPONENT/PROGRESSIVE SCAN VIDEO OUT jacks for connection to a TV or monitor that is compatible with a progressive scan signal, set Progressive Scan to ON.

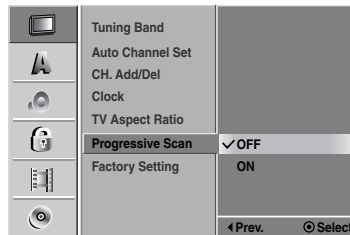

⚠ Caution

Once the setting for Progressive Scan output is entered, an image will only be visible on a Progressive Scan compatible TV or monitor. If you set Progressive Scan to ON in error, you must reset the VCR/DVD Recorder. First, remove the disc in the VCR/DVD Recorder. Next, press STOP (■) and hold it for five seconds before releasing it. The video output will be restored to the standard setting, and a picture will once again be visible on a conventional analog TV or monitor.

Factory Setting

If you wish, you can reset the VCR/DVD Recorder to its original factory settings. Select "SET" then press ENTER.

The Initialize menu will appear. Use the ◀ ▶ buttons to select "Yes" and press ENTER.

📌 Note

Some options cannot be reset. (Movie Rating, Password and Country Code)

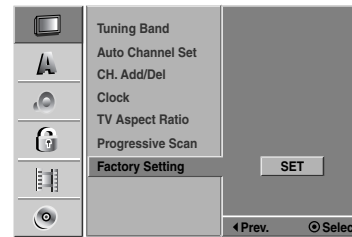

LANGUAGE

Display Menu

Select a language for the Setup menu and on-screen display.



Disc Language

Select a language for the disc's Menu, Audio, and Subtitle.

Original : The original language set for the disc is selected.

Other : To select another language, select Other option then press ENTER. Use the numbered buttons to key-in the corresponding 4-digit number according to the language code list on page 53. If you enter the wrong number, press ◀ repeatedly to delete one by one and correct it.



Before Operation (Continued)

AUDIO

Each DVD disc has a variety of audio output options. Set the VCR/DVD Recorder's Audio Output according to the type of audio system you use.

Dolby Digital

PCM: Select when connected to a 2-channel digital stereo amplifier. The VCR/DVD Recorder's digital audio outputs sounds in the PCM 2ch format when you play a DVD video disc recorded on the Dolby Digital recording system.

Bitstream: Select when connected to a Dolby Digital decoder (or an amplifier or other equipment with a Dolby Digital decoder).

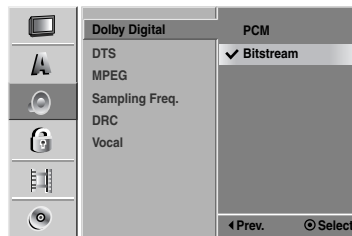

DTS

OFF: The DTS signal will not be output from the DIGITAL AUDIO OUT jack.

Bitstream: Select when connected to a DTS decoder (or an amplifier or other equipment with a DTS decoder).

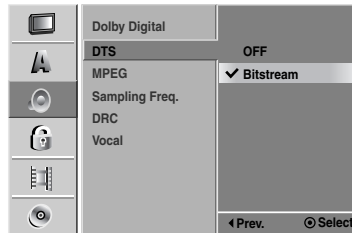

MPEG

PCM: Select when connected to a 2-channel digital stereo amplifier. The VCR/DVD Recorder's digital audio outputs sounds in the PCM 2ch format when you play a DVD video disc recorded on the MPEG1, or MPEG2 recording system.

Bitstream: Select when connected to an MPEG decoder (or an amplifier or other equipment with an MPEG decoder).

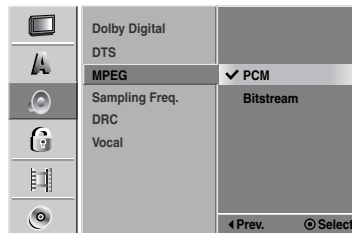

Sampling Freq. (Frequency)

If your receiver or amplifier is NOT capable of handling 96 kHz signals, select 48 kHz. When this choice is made, this VCR/DVD Recorder will automatically convert any 96 kHz signals to 48 kHz so your system can decode them.

If your receiver or amplifier is capable of handling 96 kHz signals, select 96 kHz. When this choice is made, this unit will pass each type of signal through without any further processing.

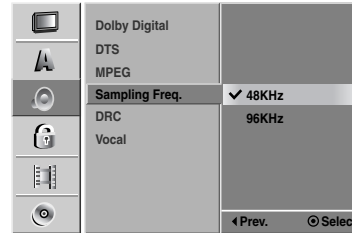

DRC (Dynamic Range Control)

With the DVD format, you can hear a program's soundtrack in the most accurate and realistic presentation possible, thanks to digital audio technology. However, you may wish to compress the dynamic range of the audio output (the difference between the loudest sounds and the quietest ones). Then, you may listen to a movie at a lower volume without losing clarity of sound. Set DRC to ON for this effect.

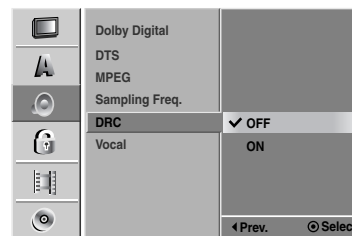

Vocal

Set Vocal to ON only when a multi-channel karaoke DVD is playing. The karaoke channels on the disc will mix into normal stereo sound.

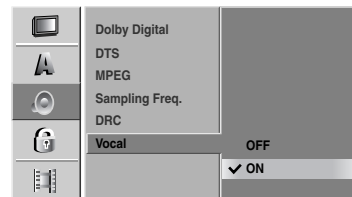

Before Operation (Continued)

LOCK (Parental Control)

Movie Rating

Movies on DVDs may contain scenes not suitable for children. Therefore, discs may contain Parental Control information that applies to the complete disc or to certain scenes on the disc. These scenes are rated from Level 1 to 8, and alternatively, more suitable scenes are available for selection on some discs. Ratings are country-dependent. The Parental Control feature allows you to prevent discs from being played by your children or to have certain discs played with alternative scenes.

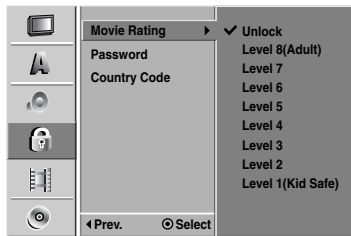

- 1 Press **SETUP**.
The Setup menu appears.
- 2 Use **▲ / ▼** to select the **LOCK** option.
- 3 While the **LOCK** option is selected, press **▶** to move to the second level.
- 4 Use **▲ / ▼** to select the **Movie Rating** option.
- 5 Press **▶** to move to the third level.
- 6 **When you have not entered a password yet.**
Enter a 4-digit password using the numbered buttons to create a personal 4-digit security password. Enter the 4-digit password again to confirm.
When you have already entered a password;
Enter a 4-digit password using the numbered buttons to confirm the personal 4-digit security password.

Tip

If you enter the wrong number, press **◀** repeatedly to delete password numbers one by one then correct it.

- 7 Select a rating from 1 to 8 using the **▲ / ▼** buttons. One (1) has the least playback restrictions. Eight (8) has the most playback restrictions.
Unlock: If you select **Unlock**, **Parental Control** is not active. The disc will play in full.

Level 1 to 8: Some discs contain scenes not suitable for children. If you set a rating for the recorder, all disc scenes with the same rating or lower will be played. Higher rated scenes will not be played unless an alternative scene is available on the disc. The alternative must have the same rating or a lower one. If no suitable alternative is found, playback will stop. You must enter the 4-digit password or change the rating level in order to play the disc.

- 8 Press **ENTER** to confirm your rating selection, then press **SETUP** to exit the menu.

Set Password

Changing the 4-digit code

- 1 Follow steps 1-3 as shown above to the left (Movie Rating).
- 2 Use **▲ / ▼** to select the **Password** option.
- 3 Press **▶** to move to the third level.
- 4 Follow step 6 as shown above to the left (Movie Rating).
- 5 While “**Change**” is selected, press **ENTER**.
If you select “**Delete**” then press **ENTER**. The password is deleted.
- 6 Enter a 4-digit password using the numbered buttons to create a personal 4-digit security password.
- 7 Enter the 4-digit password again.

Tip

If you enter the wrong number, press **◀** repeatedly to delete password numbers one by one then correct it.

If you forget your 4-digit code

If you forget your password, to clear the current password, follow the procedure below.

- 1 Press **SETUP** to display the Setup menu.
- 2 Use the **Number** buttons to enter the 5-digit number “21019”.
The message appears on the TV screen.
- 3 Select “**Yes**” then press **ENTER**. The 4-digit password is cleared. Enter a new code as shown above.

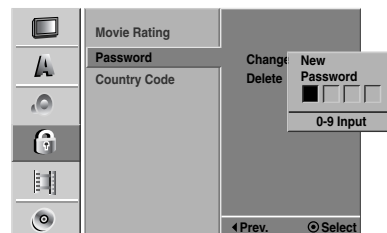

Before Operation (Continued)

Country Code

Enter the code of a country/area whose standards were used to rate the DVD video disc, referring to the list (See "Country Code List", page 54.).



- 1 Press SETUP.**
The Setup menu appears.
- 2 Use ▲ / ▼ to select the LOCK option.**
- 3 While the LOCK option is selected, press ► to move to the second level.**
- 4 Use ▲ / ▼ to select the Country Code option.**
- 5 Press ► to move to the third level.**
- 6 When you have not entered a password yet.**
Enter a 4-digit password using the numbered buttons to create a personal 4-digit security password. Enter the 4-digit password again.
When you have already entered a password;
Enter a 4-digit password using the numbered buttons to confirm the personal 4-digit security password.

Tip

If you enter the wrong number, press ◀ repeatedly to delete password numbers one by one then correct it.

- 7 Select the first character using the ▲ / ▼ buttons.**
- 8 Shift the cursor using ► buttons and select the second character using ▲ / ▼ buttons.**
- 9 Press ENTER to confirm your country code selection, then press SETUP to exit the menu.**

RECORD

DISC Record Mode

You can set the picture quality for DVD recording; SP (Standard quality), LP (Low quality), XP (High quality).

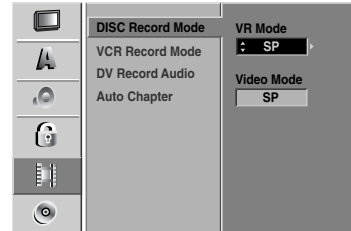

- 1 Press SETUP.**
The Setup menu appears.
- 2 Use ▲ / ▼ to select the RECORD option.**
- 3 While the RECORD option is selected, press ► to move to the second level.**
- 4 Use ▲ / ▼ to select the DISC Record Mode Set option.**
- 5 Press ► to move to the third level.**
- 6 Use ◀ / ► to select the VR Mode or Video Mode.**
- 7 Use ▲ / ▼ to select a desired DISC Record Mode (SP, LP, or XP)**
- 8 Press ENTER to confirm your selection, then press SETUP to exit the menu.**

VCR Record Mode

You can set the picture quality for VCR recording; SP (Standard Play), SLP (Super Long Play).

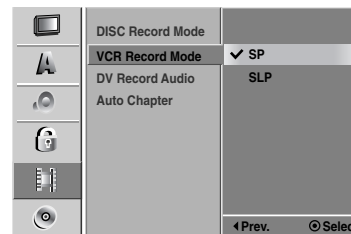

Before Operation (Continued)

DV Record Audio

You need to set this if you have a camcorder using 32kHz/12-bit sound connected to the front panel DV IN jack.

Some digital camcorders have two stereo tracks for audio. One is recorded at the time of shooting; the other is for overdubbing after shooting.

On the Audio 1 setting, the sound that was recorded while shooting is used.

On the Audio 2 setting, the overdubbed sound is used.

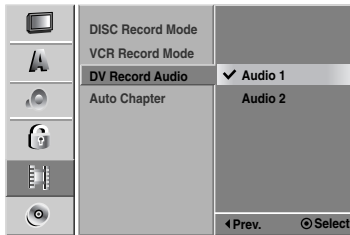

Auto Chapter

During recording (Video mode only), chapter markers are added automatically at fixed intervals. You can set this interval to 3 minutes, 5 minutes or 10 minutes. To turn off automatic chapter marking, select "Not Use".

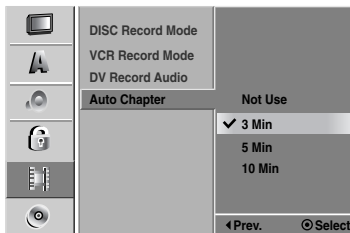

DISC

DISC Initialize

- If you load a blank DVD-R disc, it will always be initialized in Video mode, which allows the disc to be played in most standard DVD players.
- If you load a blank DVD-RW disc, you will be prompted to initialize the disc in Video mode (for maximum compatibility) or VR mode (to enable advanced editing features).
- If you load a DVD-RW that has already been used, you can change between Video mode and VR mode by erasing the disc using the DISC Initialize feature.

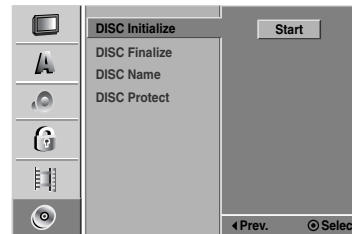

- 1 Press SETUP.**
The Setup menu appears.
- 2 Use ▲ / ▼ to select the DISC option.**
- 3 While the DISC option is selected, press ► to move to the second level.**
- 4 Use ▲ / ▼ to select the DISC Initialize option.**
- 5 Press ► to move to the third level.**
Start icon is highlighted.
- 6 Press ENTER.**
Disc Initialize menu appears.

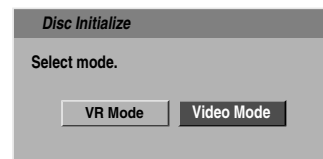

- 7 Use ◀ / ▶ to select a desired DISC Initialize Mode (VR Mode or Video Mode) then press ENTER.**
- 8 Use ◀ / ▶ to select OK, and press ENTER.**
It takes a few moments to initialize the disc.
- 9 Press ENTER.**

⚠ Caution

If you want to change the disc format, everything recorded on the disc will be erased.

Before Operation (Continued)

DISC Finalize

Finalizing 'fixes' the recordings in place so that the disc can be played on a regular DVD player or computer equipped with a suitable DVD-ROM drive. Finalizing a Video mode disc creates a menu screen for navigating the disc. This is accessed by pressing DISC MENU or TITLE.

Caution

Once you have finalized a DVD-R disc, you cannot edit or record anything else on that disc. However, you can record and edit a DVD-RW disc by choosing Unfinalize.

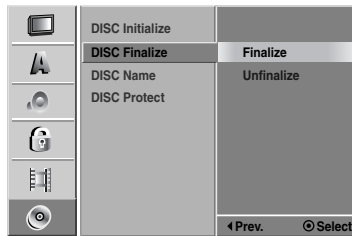

1 Follow steps 1-3 as shown under DISC Initialize.

2 Use ▲ / ▼ to select the DISC Finalize option.

3 Press ► to move to the third level. Finalize is highlighted.

4 Press ENTER. Finalize menu appears.

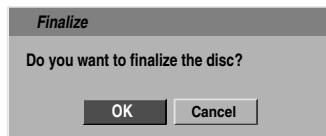

5 Select OK then press ENTER. The VCR/DVD Recorder starts finalizing the disc.

Note

Finalization can take up to 3-4 minutes depending on the type of disc, how much is recorded on the disc, and the number of titles on the disc.

Tips

- If you load a DVD-RW that has already been finalized on a different DVD Recorder, you can 'Unfinalize' it by choosing Unfinalize from the Finalize menu. After doing this, you can edit and re-record onto the disc.
- You cannot unfinalize a DVD-R disc.

DISC Protect

When recording in VR mode, set to ON to prevent accidental recording, editing or erasing of the disc loaded. If you need to unlock the disc to make edits, select OFF.

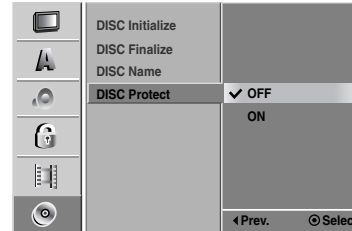

Before Operation (Continued)

DISC Name

Use the DISC Name feature to enter a name for the disc. This name appears when you load the disc and when you display disc information on-screen.

- The disc name can be up to 32 characters long.
- For discs formatted on a different DVD Recorder, you will see only a limited character set.

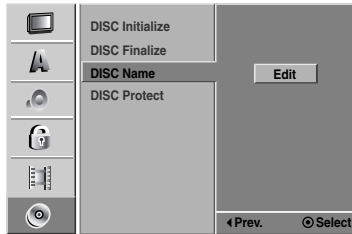

- 1 Follow steps 1-3 as shown DISC Initialize on page 24.
- 2 Use ▲ / ▼ to select the DISC Name option.
- 3 Press ► to move to the third level.
Edit icon is highlighted.
- 4 Press ENTER.
Keyboard menu appears.



- 5 Enter a name for the disc. Use ▲ ▼ ◀ ▶ to select a character then press ENTER to confirm your selection.
 - **English/Latin Capital:** Selects a keyboard with uppercase characters.
 - **English/Latin Lowercase:** Selects a keyboard with lowercase characters .
 - **Symbols:** Selects a keyboard with all symbols.
 - **OK:** Confirms the name you have entered.
 - **Cancel:** Deletes all characters and exits the Keyboard menu.
 - **Space:** Inserts a space at the cursor position.
 - **Delete:** Deletes the character to the left of the cursor.
 - **◀ / ▶:** Moves the cursor left or right.

 You can also use the remote control to enter DISC Names:

- SKIP (◀◀ / ▶▶):** Moves the cursor left or right.
 - PLAY (▶):** Inserts a space at the cursor position.
 - PAUSE/STEP (⏏):** Deletes the character to the right of the cursor position.
 - STOP (■), CLEAR:** Deletes the character to the left of the cursor position.
 - 0-9:** Enters the character corresponding to the selected column.
 - DISC MENU/LIST, DISPLAY:** Switches the keyboard type (English/Latin Capital, English/Latin Lowercase, Symbols).
- 6 Choose OK then press ENTER to fix the name and return to the DISC menu.

- 7 Press SETUP to exit the menu.

Before Operation (Continued)

General Explanation of On-Screen Display

This manual gives basic instructions for operating the VCR/DVD Recorder. Some DVDs require specific operation or allow only limited operation during playback. When this occurs, the symbol  appears on the TV screen, indicating that the operation is not permitted by the VCR/DVD Recorder or is not available on the disc.

Displaying Information on-screen

You can display various information about the disc or tape loaded on-screen.

On-screen display operation



1 Press **DISPLAY** repeatedly to display/change the information displayed on-screen.

2 To remove the on-screen display, press **DISPLAY** or **RETURN** () repeatedly until it disappears. See the descriptions on pages 28 and 29 for detailed explanations of on-screen displays for each media type.

Notes

- Some discs may not provide all the features shown in the on-screen display examples.
- The on-screen display disappears automatically if no button is pressed for seven seconds.

Temporary Feedback Icons

-  Resume play from this point
-  Action prohibited or not available



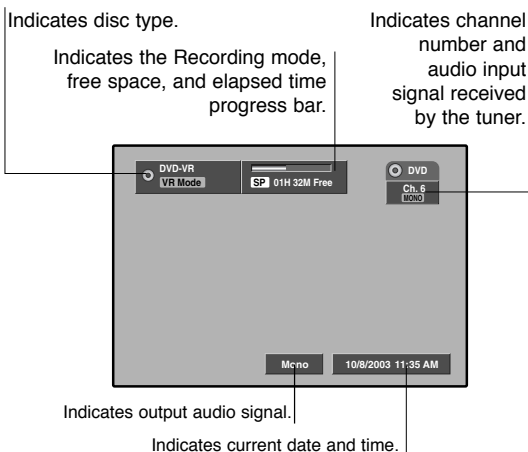

Displaying OSD While Watching TV

While watching TV, press **DISPLAY** to display/remove the on-screen display.

For example, when a DVD-RW in VR mode is inserted, you would see a screen similar to the following:



Changing TV Channels

If no disc is playing, you can change TV channels using the number or CH/TRK ( / ) buttons on the remote control, or the CH ( / ) buttons on the front panel.

Note

Antenna channels are numbered 2 through 69. Cable channels are numbered 1 through 125.

Changing TV Audio Channel

Some TV programs are broadcast with both a main and a Secondary Audio Program (SAP). You can change the TV audio using the **AUDIO** button.

Press **AUDIO** repeatedly to change the TV audio, according to Broadcast audio signal as shown below.

- **STEREO+SAP Audio Signal**
Stereo → SAP → Mono → Stereo
- **STEREO Audio Signal**
Stereo → L → R → Mono Stereo
- **SAP Audio Signal**
Mono → SAP → Mono
- **MONO Audio Signal**
Mono

The current audio channel is displayed on-screen.





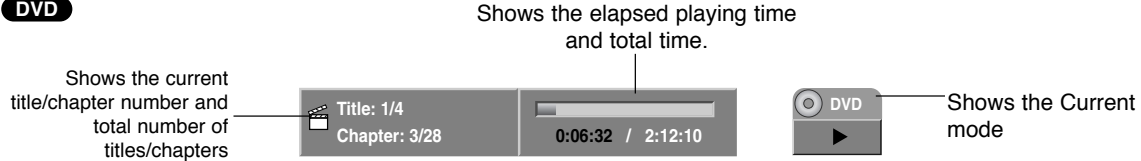

- If SAP is selected, but there is no SAP channel being broadcast, you will still hear the main audio (Mono or STEREO) channel.
- If the sound is poor quality when set to Stereo, you can often improve it by changing to Mono.
- When an external input is selected, the audio channel can be switched only to Stereo.

Before Operation (Continued)

OSD Menu Options by Media Type

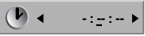
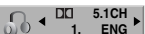



DVD

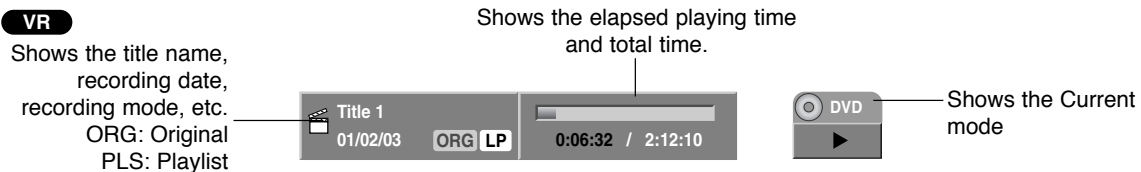

Menu Options	Function (Use ▲ / ▼ to select desired option)	Selection Method
Title Number 	Shows the current title number and total number of titles, and skips to the desired title number.	◀ / ▶, or Numbers, ENTER
Chapter Number 	Shows the current chapter number and total number of chapters, and skips to the desired chapter number.	◀ / ▶, or Numbers, ENTER
Time search 	Shows the elapsed playing time, and searches the point by the elapsed time directly.	Numbers, ENTER
Audio language and Digital Audio Output mode 	Shows the current audio soundtrack language, encoding method, and channel number, and changes the setting.	◀ / ▶
Subtitle language 	Shows the current subtitles language, and changes the setting.	◀ / ▶
Angle 	Shows the current angle number and total number of angles, and changes the angle number.	◀ / ▶
Sound 	Shows the current sound mode, and changes the setting.	◀ / ▶

VR



Menu Options	Function (Use ▲ / ▼ to select desired option)	Selection Method
Title Number 	Shows the current title number and total number of titles, and skips to the desired title number.	◀ / ▶, or Numbers, ENTER
Chapter Number 	Shows the current chapter number and total number of chapters, and skips to the desired chapter number.	◀ / ▶, or Numbers, ENTER
Time search 	Shows the elapsed playing time, and searches the point by the elapsed time directly.	Numbers, ENTER
Sound 	Shows the current sound mode, and changes the setting.	◀ / ▶



Before Operation (Continued)

OSD Menu Options by Media Type (Continued)

Video

Shows the title name, recording date, recording mode, etc.
 ORG: Original
 PLS: Playlist



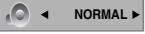

Menu Options	Function (Use ▲ / ▼ to select desired option)	Selection Method
Title Number 	Shows the current title number and total number of titles, and skips to the desired title number.	◀ / ▶, or Numbers, ENTER
Chapter Number 	Shows the current chapter number and total number of chapters, and skips to the desired chapter number.	◀ / ▶, or Numbers, ENTER
Time search 	Shows the elapsed playing time, and searches the point by the elapsed time directly.	Numbers, ENTER
Sound 	Shows the current sound mode, and changes the setting.	◀ / ▶

VHS

Shows playing speed, recording tape information and the elapsed playing progress bar.

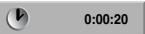

Menu Options	Function (Use ▲ / ▼ to select desired option)	Selection Method
Time 	Shows the elapsed playing time (Display only).	-
Audio Channel 	Shows the audio channel, and changes the audio channel.	◀ / ▶

Operation with DVD

Playing a DVD

Playback Setup

- Before using the remote control, press the **DVD** button to select the device to be operated.
- Turn the TV on and select the video input source connected to the VCR/DVD Recorder.
- Audio system: Turn the audio system on and select the input source connected to the VCR/DVD Recorder.

1 Press **OPEN/CLOSE** to open the disc tray.

2 Load your chosen disc in the tray, with the playback side down.

3 Press **OPEN/CLOSE** to close the tray. **READING** appears on the display window, and playback starts automatically. If playback does not start, press **PLAY** (▶).
In some cases, the disc menu might appear instead.

Tip

If a menu screen is displayed

The menu screen may be displayed first after loading a DVD which contains a menu.

DVD

Use the ◀ ▶ ▲ ▼ buttons to select the title/chapter you want to view, then press **ENTER** to start playback. Press **TITLE** or **DISC MENU** to return to the menu screen.

Notes

- If Parental Control is set and the disc is not within the Movie Rating settings (not authorized), the 4-digit code must be entered and/or the disc must be authorized (see “Movie Rating”, on page 22).
- DVDs may have a Region Code. Your VCR/DVD Recorder will not play discs that have a region code different from your VCR/DVD Recorder. The region code for this VCR/DVD Recorder is 1 (one).

Note

Unless stated otherwise, all operations described use the remote control. Some features may also be available on the Setup menu.

Moving to another TITLES



When a disc has more than one title, you can move to another title as follows:

- Press **DISPLAY** twice and use ▲ / ▼ to select the title icon. Then, press the appropriate numbered button (0-9) or ◀ / ▶ to select a title number and press **ENTER** to confirm.

Moving to another CHAPTERS



When a title on a disc has more than one chapter, you can move to another chapter as follows:

- Press **SKIP** (◀◀ or ▶▶) briefly during playback to select the next chapter or to return to the beginning of the current chapter.
- Press **SKIP** (◀◀) twice briefly to step back to the previous chapter.
- To go directly to any chapter during playback, press **DISPLAY** twice. Use ▲ / ▼ to select chapter icon, then enter the chapter number using the numbered buttons (0-9) or press ◀ / ▶ and press **ENTER**.

Slow Motion



- 1 Press **BACKWARD** (◀◀) or **FORWARD** (▶▶) during pause mode.
The VCR/DVD Recorder will enter **SLOW** mode.
- 2 Use the **BACKWARD** (◀◀) or **FORWARD** (▶▶) to select the required speed: ◀◀ 1/16, ◀◀ 1/8, ◀◀ 1/4, ◀◀ 1/2, or ▶▶ 1/16, ▶▶ 1/8, ▶▶ 1/4, ▶▶ 1/2.
- 3 To exit Slow Motion mode, press **PLAY** (▶).

Operation with DVD (Continued)

Playing a DVD (continued)

Still Picture and Frame-by-Frame Playback

DVD **Video** **VR**

- 1 Press PAUSE/STEP (II) during playback. The recorder will now go into PAUSE mode.
- 2 You can advance or back up the picture frame-by-frame by pressing ◀ / ▶ repeatedly during PAUSE mode.

Search **DVD** **Video** **VR**

- 1 Press BACKWARD (◀◀) or FORWARD (▶▶) during playback. The recorder will now go into SEARCH mode.
- 2 Press BACKWARD (◀◀) or FORWARD (▶▶) to select the required speed: ▶▶X2, ▶▶X4, ▶▶X8, ▶▶X16, ▶▶X100, ▶ (forward) or ◀, ◀◀X2, ◀◀X4, ◀◀X8, ◀◀X16, ◀◀X100 (backward).
- 3 To exit SEARCH mode, press PLAY (▶).

Note

When you press BACKWARD or FORWARD during Search mode to resume normal speed, Search mode is canceled.

Random **Karaoke DVD**

- 1 Press RANDOM during playback. The VCR/DVD Recorder automatically begins Random Playback and "RANDOM" appears on the display window.
- 2 To return to normal playback, press RANDOM until "NORMAL" appears on the display window.

Tip

By pressing SKIP (▶▶I) during Random playback, the VCR/DVD Recorder selects another title (track) and resumes Random playback.

Note

This function only works with DVD Karaoke discs

Repeat **DVD** **Video** **VR**

DVD Video Discs - Repeat Chapter/Title/Off

- 1 To repeat the currently playing chapter, press REPEAT. The REPEAT CHAPTER appears on the TV screen.
- 2 To repeat the title currently playing, press REPEAT a second time. The REPEAT TITLE appears on the TV screen.
- 3 To exit Repeat mode, press REPEAT a third time. The REPEAT OFF icon appears on the TV screen.

Repeat A-B

DVD **Video** **VR** 

To repeat a sequence in a title:

- 1 Press A-B at your chosen starting point. REPEAT A- appears on the TV screen.
- 2 Press A-B again at your chosen end point. REPEAT A-B appears briefly on the TV screen, and the repeat sequence begins.
- 3 To cancel the sequence, press A-B repeatedly to select REPEAT OFF.

Operation with DVD (Continued)

Playing a DVD (continued)

Time Search **DVD** **Video** **VR**



The Time Search function allows you to start playing at any chosen time on the disc.

- 1 Press DISPLAY twice during playback. The on-screen display appears on the TV screen.
The Time Search box shows the elapsed playing time of the current disc.
- 2 Within 7 seconds, use ▲ / ▼ to select the Time Search icon in the on-screen display.
The “-:-:-” appears in the Time Search box.
- 3 Within 7 seconds, use the number buttons to enter the required start time. Enter hours, minutes, and seconds from left to right in the box.
You can not enter an invalid time.
If you enter the wrong numbers, press ◀ / ▶ to move the under bar () to the wrong number. Then reenter the correct numbers.
- 4 Within 7 seconds, press ENTER to confirm the start time.
Playback starts from the selected time on the disc.

Zoom **DVD** **Video** **VR**

The Zoom function allows you to enlarge the video image and to move through the enlarged image.

- 1 Press ZOOM during playback or still playback to activate the Zoom function.
The square frame will be displayed in the right bottom of the picture. If no button is pressed for more than 5 seconds, the square frame will disappear.
Each press of the ZOOM button changes the TV screen in the sequence shown below.
X1(normal size) → X2 size → X4 size → X1(normal size)
- 2 Use the ◀ ▶ ▲ ▼ buttons to move through the zoomed picture.
- 3 To resume normal playback, press CLEAR or press ZOOM repeatedly until the normal picture appears.



The zoom function may not work for some DVDs.

Marker Search



You can start playback from a memorized point. Up to six points can be memorized.
To enter a mark, follow these steps.

- 1 During disc playback, press MARKER when playback reaches the spot that you want to memorize.
The Marker icon will appear on the TV screen briefly.
- 2 Repeat step 1 to enter up to six Marker points on a disc.

To Recall a Marked Scene

- 1 During disc playback, press SEARCH.
The Marker Search menu will appear on the TV screen.

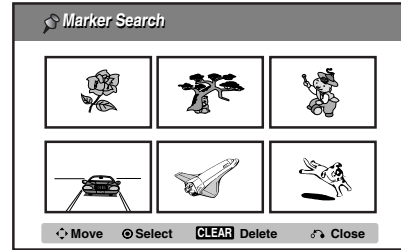

- 2 Use the ◀ ▶ ▲ ▼ buttons to select a Marked scene that you want to recall.
- 3 Press ENTER.
Playback will start from the Marked scene.
- 4 To exit the Marker Search menu, press RETURN (↵).

To clear a Marked Scene

- 1 During disc playback, press SEARCH.
The Marker Search menu will appear on the TV screen.
- 2 Use ◀ ▶ ▲ ▼ to select the Marked scene that you want to erase.
- 3 Press CLEAR.
“Delete selected marker. Continue?” message appears.
- 4 Use ◀ / ▶ to select “Yes” then press ENTER.
- 5 Repeat steps 2-4 to erase additional Marked scene.
- 6 To remove the Marker Search menu, press RETURN (↵).

Disc Menus **DVD**

Many DVDs contain Disc menus that allow you to access special features. To open a Disc menu, press DISC MENU. Then use the 0-9 buttons to directly select the desired option, or use the ◀ ▶ ▲ ▼ buttons to highlight your selection and press ENTER.

- 1 Press DISC MENU.
The Disc menu is displayed.
- 2 To exit the Disc menu, press STOP (■).

Title Menus **DVD**

- 1 Press TITLE.
If the current title has a menu, the Title menu will appear on the TV screen. Otherwise, the Disc menu may appear.
- 2 The Title menu may contain camera angles, spoken languages and subtitle options, as well as the chapters for the title.

Operation with DVD (Continued)

Playing a DVD (continued)

Camera Angle **DVD** 1/3

If the disc contains scenes recorded at different camera angles, you can change to a different camera angle during playback.

- Press ANGLE then press ◀ / ▶ repeatedly during playback to select a desired angle.
The number of the current angle appears on the TV screen.

Tip

The Camera Angle icon is displayed on the TV screen when alternate angles are available.

Changing the Audio Language **DVD**

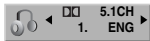

Press AUDIO then press ◀ / ▶ repeatedly during playback to hear a different audio language or audio track.

3D Surround **DVD** **Video** **VR**

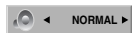

This VCR/DVD Recorder can produce a 3D Surround effect, which simulates multi-channel audio playback from two conventional stereo speakers, instead of the five or more speakers normally required to listen to multi-channel audio from a home theater system.

- 1 Press DISPLAY twice then use ▲ / ▼ to select the sound icon. Then, use ◀ / ▶ to select "3D SUR."
- 2 To turn off the 3D Surround effect, select "NORMAL".

Subtitles **DVD** OFF

Press SUBTITLE then press ◀ / ▶ repeatedly during playback to see the different subtitle languages.

Last Condition Memory **DVD**

This VCR/DVD Recorder memorizes the user settings for the last disc that you have viewed. Settings remain in memory even if you remove the disc from the VCR/DVD Recorder or switch off the VCR/DVD Recorder. If you load a disc that had its settings memorized, the latest stop position is automatically recalled.

Notes

- Settings are stored in memory for use any time.
- This VCR/DVD Recorder does not memorize settings of a disc if you switch off the VCR/DVD Recorder before commencing to play it.
- The Last Condition Memory function may not work on some DVDs.

Audio CD and MP3 Operation

Playing an Audio CD or MP3 Disc

CD **MP3**

The VCR/DVD Recorder can play audio CDs and MP3 files on CD-ROM, CD-R or CD-RW discs. Before playing MP3 files, read “Notes on MP3 Recordings” at right.

1 Insert a disc and close the tray.

AUDIO CD or MP3 CD menu appears on the TV screen.

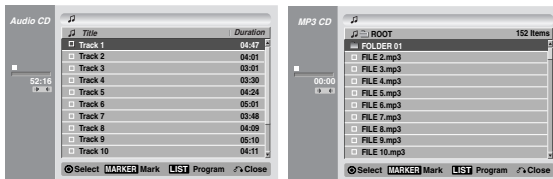

AUDIO CD Menu

MP3 CD Menu

2 Use ▲/▼ to select a track then press PLAY (▶). Playback starts.

During playback, the current track's elapsed playing time will appear on the display window and menu. Playback will stop at the end of the disc.

Tips

- On the MP3 CD menu, you can display the folders on the disc. Use ▲▼◀▶ to select the “Folder” icon on the MP3 CD menu then press ENTER twice. Also, you can display only tracks in the folders. Use ▲▼◀▶ to select a folder then press ENTER.
- If audio tracks and MP3 files are mixed on the disc, you can switch between the AUDIO CD menu and MP3 CD menu by pressing TITLE repeatedly in Stop mode.
- If you select a track and press DISPLAY, the file information is displayed. If you select a folder and press DISPLAY, the number of subfolders and number of MP3 files in the folder are displayed.
- If you are in a file list and want to return to the Folder list, use the ▲/▼ to highlight  and press ENTER to return to the previous menu screen.
- You can view TV channel or video input source by pressing RETURN. If you want to return to the MP3 or AUDIO CD menu, press DISC MENU/LIST.

3 To stop playback at any time, press STOP (■).

Notes on MP3 Recordings

About MP3

- An MP3 file is audio data compressed by using the MPEG1 audio layer-3 file-coding scheme. We call files that have the “.mp3” file extension “MP3 files”.
- The VCR/DVD Recorder can not read an MP3 file that has a file extension other than “.mp3”.

MP3 Disc compatibility with this recorder is limited as follows:

1. CD-R/RW physical format should be “ISO 9660” and “JOLIET”.
2. If you record MP3 files using the software which cannot create a FILE SYSTEM, for example “Direct-CD” etc., it is impossible to playback MP3 files. We recommend that you use “Easy-CD Creator”, which creates an ISO9660 or JOLIET file system.
3. The total number of files and folders on the disc are free but the total number of files and folders on the folder should be less than 1999.

This VCR/DVD Recorder requires discs/recordings to meet certain technical standards in order to achieve optimal playback quality. Pre-recorded DVDs are automatically set to these standards. There are many different types of recordable disc formats (including CD-R containing MP3 files) that require certain pre-existing conditions (see above) to insure compatible playback.

Customers should also note that permission is required in order to download MP3 files and music from the Internet. Our company has no right to grant such permission. Permission should always be sought from the copyright owner.

Audio CD and MP3 Operation (Continued)

Pause **CD** **MP3**

- 1 Press PAUSE/STEP during playback.
- 2 To return to playback, press PAUSE/STEP again.

Moving to Another Track **CD** **MP3**

- Press SKIP **I◀◀** or **▶▶I** briefly during playback to go to the next track or to return to the beginning of the current track.
- Press SKIP **I◀◀** twice briefly to step back to the previous track.
- On an Audio CD, to go directly to any track, enter the track number using the numbered buttons (0-9) during playback.

Repeat **CD** **MP3**

Press REPEAT to select a desired repeat mode.

- Audio CD
 - TRACK: Repeats the current track.
 - ALL: Repeats all the tracks on a disc.
 - OFF: Does not play repeatedly (no display).
- MP3 Disc
 - TRACK: Repeats the current track.
 - FOLDER: Repeats all the tracks on a folder of a disc.
 - OFF: Does not play repeatedly (no display).

Random **CD** **MP3**

- 1 Press RANDOM during playback or when playback has stopped.
The VCR/DVD Recorder automatically begins Random Playback and RANDOM appears on the left side of menu screen.
- 2 To return to normal playback, press RANDOM again, then RANDOM disappears from the menu screen.

Search **CD**

- 1 Press BACKWARD (**◀◀**) or FORWARD (**▶▶**) during playback.
The recorder will now go into SEARCH mode.
- 2 Press BACKWARD or FORWARD to select the required speed: **◀◀X2**, **◀◀X4**, **◀◀X8** (backward) or **▶▶X2**, **▶▶X4**, **▶▶X8** (forward).
Search speed and direction are indicated on the menu screen.
- 3 To exit SEARCH mode, press PLAY (**▶**).

Repeat A-B **CD**

To repeat a sequence in a title:

- 1 Press A-B at your chosen start point.
Repeat icon and "A-" appears on the menu screen.
- 2 Press A-B again at your chosen end point.
The Repeat icon and "A - B" appears on the left side of menu screen, and the repeat sequence begins.
- 3 To exit the sequence and return to normal play, press A-B again.
The Repeat icon disappears from the menu screen.

Programmed Playback with Audio CD and MP3

The Program function enables you to store your favorite tracks from any disc in the recorder memory. Program can contain 99 tracks (Audio CD) or 256 tracks (MP3).

1 Insert an Audio CD or MP3 disc.

Audio CD or MP3 CD menu will appear.

2 Use ▲▼ to select a track or folder on the List then press ENTER.

The options appears on the left side of the menu.

Notes

- Press and hold ▼ for fast to move to the next track or folder.
- Press and hold ▲ for fast to move to the previous track or folder.

3 Use ▲▼ to highlight the “Program Add” icon then press ENTER.

The selected track is added to the Program List.

4 Repeat steps 2-3 to place additional tracks on the Program list.

Tip

You can add multi tracks on the List to the Program List.

1. Select a track then press MARKER.
2. Repeat step 1 to mark additional tracks.
3. Select any track then press ENTER.
The options appears on the left side of the menu.
4. Use ▲ / ▼ to highlight the “Program Add” icon then press ENTER.
The all marked tracks are added to the Program List.

Notes

- Use the CLEAR button to select all tracks, or cancel all marked tracks.
- If you select folder for Programmed Playback, all tracks in the folder are added to the program list.

5 Use ► to move to the Program list.

The programmed track you selected last is highlighted on the program list.

6 Use ▲ / ▼ to select the track you want to start playing.

7 Press PLAY (▶) to start.

Playback begins in the order in which you programmed the tracks and “PRG” indicator appears on the display window.

Playback stops after playing the last programmed track on the program list.

8 To resume normal playback from programmed playback, select a track on the List then press PLAY (▶).

“PRG” indicator disappears from the display window.

Repeat Programmed Tracks

Press REPEAT to select a desired Repeat mode.

- TRACK : Repeats the current track.
- ALL : Repeats all the tracks on a disc.
- OFF : Does not play repeatedly (no display).

Erasing a Track from the Program List

- 1 Select the track that you wish to erase from the Program List then press ENTER.
The options appears on the left side of the menu.
- 2 Select the Delete icon then press ENTER.
The selected track is deleted on the Program List.
- 3 Repeat steps 1-2 to delete additional tracks on the Program List.

Erasing the multi tracks on the Program List

1. Select a track on the Program List then press MARKER.
2. Repeat step 1 to mark additional tracks.
3. Select any track then press ENTER.
The options appears on the left side of the menu.
4. Use ▲ / ▼ to highlight the “Delete” icon then press ENTER.
The all marked tracks are deleted from the Program List.

Changing the order of Program List

- 1 Select the track you wish to move on the Program List then press ENTER.
The options appear on the left side of the menu.
- 2 Select Move then press ENTER.
A yellow bar appears in the Program List.
- 3 Use ▲/▼ to move the yellow bar to the desired location, then press ENTER.
The selected track is moved.
- 4 If you wish to move other tracks repeat stages 1 - 3.

Tip

Use MARKER to move multiple tracks.

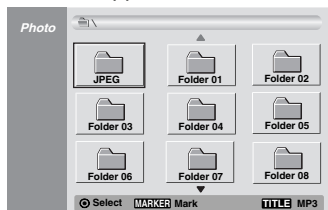

Photo Disc Operation

Viewing a Photo Disc **JPEG**

This VCR/DVD Recorder can play discs with JPEG files. Before playing JPEG files, read the notes on JPEG files on right.

- 1 Insert a disc and close the tray.**
The Photo menu appears on the TV screen.



- 2 Use ▲▼◀▶ to select a folder, and ENTER.**
Open icon is highlighted on the left side of the menu.

- 3 Press ENTER.**
A list of files in the folder appears.



Note

If the  icon displays in a JPEG file list, it means you cannot see those JPEG files.

- 4 Use ▲▼◀▶ to select a file, then press ENTER.**
The options appear on the left side of the menu.

Tip

If you are in a file list and want to return to the Folder list, use the ▲/▼ buttons on the remote to highlight the  icon and press ENTER.

- 5 Use ▲/▼ to select an Full Screen option then press ENTER.**

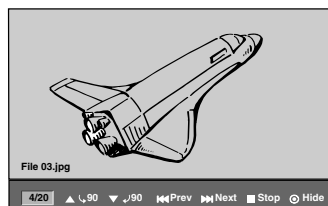

- 6 To stop viewing at any other time, press STOP or RETURN (↵).**
The Photo menu appears.

Selecting other Files

While viewing a picture, press SKIP (⏮/⏭) or ◀▶ once to advance to the next file or return to the previous file.

To rotate the picture

Use ▲/▼ while showing a picture to flip the picture clockwise or counterclockwise.

To view Slide Show

- Select Slide Show option on the menu.
- Press ENTER.
Slide Show menu appears.

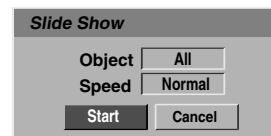

- Use ▲▼◀▶ to set the options.
Object: All files or Selected file.
Speed: Selects Slide Show speed (Slow, Normal, Fast).
- Select START icon then press ENTER to start slide show.
- Press STOP to stop the Slide Show and return to the Photo menu.

Note

Use the MARKER button to select multiple files.

Notes on JPEG Files

- Depending on the size and number of the JPEG files, it could take a long time for the DVD player to read the disc's content. If you don't see an on-screen display after several minutes, some of the files are too big — reduce the resolution of the JPEG files to less than 4 megapixels and burn another disc.
- The total number of files and folders on the disc are free but the total number of files and folders on the folder should be less than 1999.
- Some discs may be incompatible due to different recording format or condition of the disc.
- When you are using software such as "Easy CD Creator" to burn jpeg files on a CD-R, ensure that all the selected files have the ".jpg" extension before copying into the CD layout.
- If the files have ".jpe" or ".jpeg" extensions, please rename them as ".jpg" files.
- File names without ".jpg" extension will not be able to be read by this VCR/DVD Recorder, even though the files are shown as JPEG image files in Windows Explorer.
- On CDs with mixed content (audio tracks, MP3 files and JPEG files), you can select among the AUDIO CD menu, MP3 CD menu, and Photo CD menu by pressing TITLE repeatedly in Stop mode.

VCR Mode Tape Playback

Preparation

- Before using the remote control, press the **VCR** button to select the device to be operated.
- Turn the TV on and select the video input source connected to the VCR/DVD Recorder.
- Audio system: Turn the audio system on and select the input source connected to the VCR/DVD Recorder.

Normal Playback **VHS**

1 Insert a prerecorded video cassette.

The  indicator will light and the VCR/DVD Recorder will power-up automatically.

- Make sure that the **TIMER** indicator in the display window is not lighted. If it is, press **POWER** once.
- If a tape without a safety tab is inserted, the VCR/DVD Recorder will start playback automatically.

2 Press **PLAY** (▶) once.

- PLAY icon appears on the TV screen.
- It is not necessary to select the tape speed for playback. It will be automatically selected by the VCR/DVD Recorder.
 - In playback, the **TV/VCR** selector switches to VCR mode automatically.

3 Press **STOP** (■) to stop playback.

- STOP icon appears on the TV screen.
- If the tape reaches the end before **STOP** (■) is pressed, the VCR/DVD Recorder will automatically stop, rewind and eject the tape, and turn itself off.

Tracking Control **VHS**

Auto Tracking

The automatic tracking function adjusts the picture to remove snow or streaks.

The **AUTO TRACKING** function works in the following cases:

- A tape is played back for the first time.
- Tape speed (SP, LP, SLP) changes.
- Streaks or snow appear because of scratches on the tape.

Manual Tracking

If noise appears on the screen during playback, press either **CH/TRK** (▲/▼) on the remote control or **CH** (▲/▼) on the front panel until the noise on the screen is reduced.

- In case of vertical jitter, adjust these controls very carefully.
- Tracking is automatically reset to normal when the tape is ejected or the power cord is unplugged for more than 3 seconds.

Special Effect Playback **VHS**

Special effects playback notes

- Horizontal lines (noise bars) will appear on the TV screen. This is normal.
- The audio is automatically muted during special effect modes, so there is no sound during search.
- During the high-speed picture search modes, a short time is needed to stabilize tape speed when re-entering the **PLAY** mode. Slight interference may be observed during this time.

Search

This function lets you visually search forward and backward for a desired scene on your tape.

- 1 Press **BACKWARD** (◀◀) or **FORWARD** (▶▶) during playback.

The VCR/DVD Recorder will be activated in the **SEARCH** mode.

- If the VCR/DVD Recorder is left in the **SEARCH** mode for more than 3 minutes, the VCR/DVD Recorder will automatically enter the **PLAY** mode, to protect the tape and video heads.

- 2 To return to playback, press **PLAY** (▶).

Still Picture and Frame-by-Frame Playback

- 1 Press **PAUSE/STEP** (||) during playback.

A still picture appears on the TV screen.

- If a still picture vibrates vertically, stabilize it by using **CH/TRK** (▲/▼) on the remote control.
- If the VCR/DVD Recorder is left in the **STILL** mode for more than 5 minutes, the VCR/DVD Recorder will automatically enter the **STOP** mode to protect the tape and video heads.

- 2 Press **PAUSE/STEP** (||) repeatedly to advance the video picture one frame at a time while viewing a still picture.

- 3 To return to playback, press **PLAY** (▶).

Slow Motion

- 1 While in still mode, press **FORWARD** (▶▶).

The tape will be played back at a speed 1/19 times slower than the normal speed.

- During slow playback, use **CH/TRK** (▲/▼) on the Remote Control to minimize noise bands.
- If slow motion mode continues for more than 3 minutes, the VCR/DVD Recorder will automatically change to normal play mode.

- 2 To return to playback, press **PLAY** (▶).

Counter Memory Function

This is useful if there is a section of tape you want to view immediately after recording or if you want to return to the same point several times.

- 1 Begin recording or playing a tape.
- 2 Press **DISPLAY** repeatedly to display the real-time counter on the TV screen.
- 3 At the point you want to locate later, reset the real-time counter to 0:00:00 by pressing **CLEAR**.

Continue to play or record.

- 4 Press **STOP** when recording or playback finishes.

- 5 Press **RETURN** (↺).

The tape automatically stops when the tape counter returns to about "0:00:00".

Basic Recording

Basic Recording from a TV

Follow the instructions below to record a TV program. Recording starts immediately and continues until the disc or tape is full or you stop the recording.

1 Switch on the recorder, select the device (VCR or DVD) for Recording and load a recordable disc or tape.

Also make sure that the TV input is set to this recorder. If you load a completely blank DVD-RW disc, Disc initialize menu will appear, to select a desired Recording Mode to initialize the disc (See page 24).

2 Set a recording mode as necessary by pressing REC MODE repeatedly.

DVD: SP (Standard quality), LP (Low quality), XP (High quality)

VCR: SP (Standard Play), SLP (Super Long Play)

3 Use CH (▲/▼) on the front panel or CH/TRK(▲/▼) on the remote control to select the TV channel to record.

4 Use AUDIO to select the audio channel to record.

The table below shows what will be recorded on the different settings for different types of broadcast. The last column (Monitor Audio) shows what you'll hear as it is recording.

- If you set the audio channel to SAP, but there is no SAP channel being broadcast, the main audio (mono or stereo) will be recorded.

TV Broadcast	Selected Audio	Broadcast Audio		Monitor Audio
		L Ch	R Ch	
MONO	MONO	MONO	MONO	MONO
STEREO	STEREO	L	R	STEREO
	Left	L	L	Left
	Right	L	R	Right
MONO+SAP	MONO	MONO	MONO	MONO
	SAP	SAP	SAP	SAP
STEREO+SAP	STEREO	L	R	STEREO
	SAP	SAP	SAP	SAP
	MONO	MONO	MONO	MONO

5 Press REC (●) once.

Recording will start. (The REC indicator lights in the display window.)

- Recording continues until you press STOP (■) or the disc (or tape) is full.
- To record for a fixed length of time, see Instant Timer Recording on right.

6 Press STOP (■) to stop recording.

Note

- The available recording DVD title number is 99.
- If the VCR/DVD Recorder is powered off during DVD recording, the recording will not be saved.

Instant Timer Recording

Instant Timer Recording allows you to make a recording easily of a preset length without using the program timer.

1 Follow steps 1-4 as shown left (Basic Recording from a TV).

2 Press REC (●) repeatedly to select the recording time length.

Recording starts after the first press.

DVD: Each subsequent press increases the recording time by 10 minutes (maximum 240 minutes) within free space.

VCR: Each subsequent press increases the recording time by 30 minutes (maximum 540 minutes). Please confirm the VHS tape has enough remaining time to be recorded before recording.

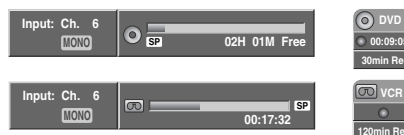

Instant Timer Record Menu

Checking the Recording Time

Press REC (●) or DISPLAY once to check the recording time. The recalled setting will automatically return to the TV screen for a moment.

Also, remaining time of recording is shown in the display window.

To Extend the Recording Time

The recording time can be extended anytime by pressing REC (●).

Each subsequent press increases the recording time by 10 minutes (DVD) within free space or 30 minutes (VCR).

To Pause the Recording

- 1 Press PAUSE/STEP (||) to pause the disc during recording.
- 2 When you want to continue recording, press PAUSE/STEP (||) or REC (●).

Notes

- If you press PAUSE/STEP (||) during the Instant Timer Recording, it will be canceled.
- The VCR/DVD Recorder will automatically power off when the Instant Timer Recording ends.

To record one TV program while watching another

- 1 Press TV/VCR to select the TV mode during recording. The TV indicator appears.
- 2 Using the TV, select the channel to be viewed.

Tip (VCR mode only)

Always use PAUSE/STEP (||) for best results when making changes during recording.

For example: To change channels during recording, first press PAUSE/STEP (||) to put the unit in pause mode. Then select the desired channel on the VCR/DVD Recorder, and press PAUSE/STEP (||) again to resume recording.

Basic Recording

Copying from DVD to VCR

You can copy the contents of a DVD to a VHS tape using the COPY button.

Note

If the DVD (or Discs) you are attempting to copy is copy protected, you will not be able to copy the disc. It is not permitted to copy Macrovision encoded DVDs (or Discs). "Copy-protected. Cannot record." is displayed on the TV screen.

1 Insert a Disc

Insert the disc you wish to copy in the DVD deck and close the disc tray.

2 Insert a VHS Tape

Insert a blank VHS videotape into the VCR deck.

3 Select DVD mode by pressing DVD on the remote control or pressing DVD/VCR on the front panel.

4 Find the place on the DVD (or Disc) from which you want to start recording using the PLAY and PAUSE functions.

For best results, pause playback at the point from which you want to record.

5 Press the COPY button on the remote control or front panel.

The Copy to VCR menu appears.

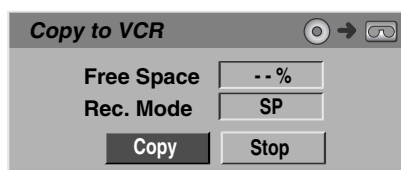

6 Use ▲ / ▼ / ◀ / ▶ to select the desired Record Mode:

- SP (Standard Play)
- SLP (Super Long Play, 3 times SP).

7 Select Copy then press ENTER or COPY to start copying.

Tip

If you press PAUSE during Copy mode, both the DVD and VCR decks go into Pause mode and the "COPY" indicator blinks on the front panel display. While in Pause mode, you can adjust the DVD playback position using PLAY, REW, FF, PAUSE/STEP, etc. The VCR deck will remain in Pause mode. To resume copying, press the COPY button twice.

8 Stop the Copy Process

To stop copying at any other time, press STOP (■). You must stop the Copy process manually when the DVD movie ends, or the unit may replay and record over and over again.

Copying from VCR to DVD

You can copy the contents of a VHS tape to a DVD-R or DVD-RW using the COPY button. This allows you to archive your old VHS tapes to DVD.

Note

If the VHS video tape you are attempting to copy is copy protected, you will not be able to copy the tape. It is not permitted to copy Macrovision encoded tapes.

1 Insert a VHS Tape

Insert the VHS videotape you wish to copy into the VCR deck.

2 Insert a DVD-R or DVD-RW disc.

Insert a blank DVD-R or DVD-RW disc in the DVD deck and close the disc tray.

Note

When using a DVD-RW disc, you must initialize before copying; see page 24.

3 Select VCR mode by pressing VCR on the remote control or pressing DVD/VCR on the front panel.

4 Find the place on the VHS tape from which you want to start recording using the PLAY, FF, REW and PAUSE functions.

For best results, pause playback at the point from which you want to record.

5 Press the COPY button on the remote control or front panel.

The Copy to DVD menu appears.

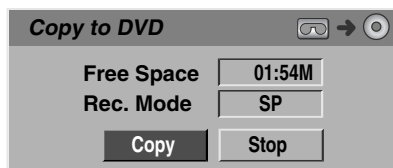

6 Use ▲ / ▼ / ◀ / ▶ to select the desired Record Mode:

- LP (Low Quality)
- SP (Standard Quality)
- XP (High Quality)

7 Select Copy then press ENTER or COPY to start copying.

Tip

If you press PAUSE during Copy mode, both the DVD and VCR decks go into Pause mode and the "COPY" indicator blinks on the front panel display. While in Pause mode, you can adjust the VCR playback position using PLAY, REW, FF, PAUSE/STEP, etc. The DVD deck will remain in Pause mode. To resume copying, press the COPY button twice.

8 Stop the Copy Process

To stop copying at any other time, press STOP (■). Copying will stop automatically when the VHS tape ends.

Timer Recording

The Timer Recording function allows you to record up to 8 programs within a period of one month.

1 Press **TIMER REC.**

The Timer Record menu will appear.

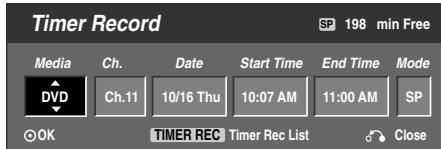

- **Media** – Choose a media (DVD or VCR).
- **Ch.** – Choose a channel (2-69 or 1-125 for antenna or cable channels respectively, excluding skip channels), or one of the external inputs from which to record (AV1 or AV2).
- **Date** – Choose a date up to 1 month in advance, or select a daily or weekly program.
- **Start Time** – Set the recording start time.
- **End Time** – Set the recording end time.
- **Mode** – Choose a record mode.
DVD: SP, LP, XP, or AT (Auto)
VCR: SP, SLP, AT (Auto)
AUTO mode determines how much time is available on the disc or tape and switches record mode, if necessary, to complete recording the program.

2 Enter the necessary information for your timer recording(s).

- ◀ / ▶ (left/right) – Move the cursor left/right
- ▲ / ▼ (up/down) – Change the setting at the current cursor position
- Press RETURN (↵) to exit the Timer Record menu.
- Press ENTER after filling in all the program information.
- Press **TIMER REC** to display Timer Record List.

3 Press **ENTER** to save the program.

The Timer Record List will appear.

4 Press **RETURN** (↵) to exit the Timer Record List.

5 Be sure to load a recordable disc or tape.

Note

- The Timer indicator lights on the front panel display.
- If the Disc and Tape indicator are blinking, either no disc or tape is loaded, or the loaded disc is not recordable.
- The VCR/DVD Recorder will record the audio according to the current TV tuner setting (Stereo, Mono or SAP). Use the AUDIO button to set the audio before switching the VCR/DVD Recorder to Standby mode.
- You must press STOP to stop the Timer Recording.
- The VCR/DVD Recorder will automatically power off when the Timer Recording ends.
- There is a short delay when a timer recording finishes to confirm the recorded program. If two timer recordings are set to record sequentially (one right after the other), the very beginning of the later program may not be recorded.

Checking Timer Recording Details

Programming can be checked whenever the VCR/DVD Recorder is turned on. Press **TIMER REC** twice.

- Use ▲ / ▼ to select a timer recording.
- Press **ENTER** to edit the selected program. Timer Record menu appears.
- Press **CLEAR** to delete the selected program from the Timer Record List.



Canceling a Timer Recording

You can clear a timer setting anytime before the recording actually starts.

- Use ▲ / ▼ to select a program you want to erase on the Timer Recorder List. If you want to erase the program, press **CLEAR**.

Stopping a Timer Recording in Progress

After a timer recording has started, you can still cancel the program.

- Press **STOP**.

Timer Recording Troubleshooting

Even though the timer is set, the recorder will not record when:

- There is no disc (or tape) loaded.
- A non-recordable disc (or tape) is loaded.
- Disc Protect is set to ON in the Disc menu (see page 25).
- There are already 99 titles recorded on the disc.

You cannot enter a timer program when:

- A recording is already underway.
- The time you're trying to set has already passed.
- There are already 8 timer programs set.

If two or more timer programs overlap:

- The earlier program takes priority.
- When the earlier program finishes, the later program starts.
- If two programs are set to start at exactly the same time, the program entered first takes priority.

Confirmation is not possible when:

- Disc Protect setting is set to ON.
- There are already 99 titles recorded on the disc.

If the disc is damaged, the recording may not complete successfully. In this case even though the Check field shows "Rec. OK", it may not be.

Recording from an External Input

Recording from External Components

You can record from an external component, such as a camcorder or VCR, connected to any of the VCR/DVD Recorder's external inputs.

1 Make sure that the component you want to record from is connected properly to the VCR/DVD Recorder. See page 17.

2 Press INPUT repeatedly to select the external input to record from.

- AV1: Audio/Video Input mounted on back panel
- AV2 (AV2 COMP): Audio/Video Input mounted on front panel
- DV: DV Input mounted on front panel

Note

Check that the Audio In settings DV Rec Audio are as you want them. See page 24.

3 Load a recordable disc or tape.

4 Set a recording mode as necessary by pressing REC MODE repeatedly.

- DVD: SP (Standard Quality), LP (Low Quality), XP(High Quality)
- VCR: SP (Standard Play), SLP (Super Long Play)

5 Press REC (●) once.

Recording will start. (The REC indicator lights in the display window.)

- Recording continues until you press STOP (■) or the disc is full.
- To record for a fixed length of time, see Instant Timer Recording on page 39.

6 Press STOP (■) to stop recording.

Note

If your source is copy-protected using CopyGuard, you will not be able to record it using this recorder. See Copyright on page 8 for more details.

Recording from a Digital Camcorder

You can record from a digital camcorder connected to the DV IN jack on the front panel of this VCR/DVD Recorder. You can use the VCR/DVD Recorder's remote to control both the camcorder and the VCR/DVD Recorder. Before recording, make sure that the audio input for the DV IN jack is set up (see page 24).

Tips

- The source signal must be DVC-SD format.
- Some camcorders cannot be controlled using the VCR/DVD Recorder remote.
- If you connect a second DVD recorder using a DV cable, you cannot control the second recorder from this one.
- You cannot control the VCR/DVD Recorder remotely from a component connected to the DV IN jack.
- You cannot record date and time information from a DV cassette.

1 Make sure your digital camcorder is connected to the front panel DV IN jack. See page 17.

2 Check that the DV audio input is as you require.

You can choose between Audio 1 (original audio) and Audio 2 (overdubbed audio).

- DV Input is set from the DV Rec Audio in sub-menu of the General menu. See DV Rec Audio on page 24 for more information.

3 Press INPUT repeatedly to select the DV input. DV appears in the display window.

4 Find the place on the camcorder tape from which you want to start recording.

For best results, pause playback at the point from which you want to record.

- Depending on your camcorder, you can use this VCR/DVD Recorder's remote to control the camcorder using the STOP, PLAY and PAUSE functions.

5 Press REC (●) once to start recording.

- Recording is automatically stopped if the recorder detects no signal.
- You can pause or stop the recording by pressing PAUSE/STEP or STOP. You cannot control the camcorder from this remote control during recording.
- In Video mode, the final frame of the recording may remain displayed on screen for a while after recording stops.

Playing Recordings on Other DVD Players

Most regular DVD players can play finalized discs recorded in Video mode. A small number of players can also play DVD-RW discs recorded in VR mode, finalized or not. Check the manual that came with the other player to check what kinds of discs it will play.

Finalizing a Disc

Finalizing 'fixes' the recordings in place so that the disc can be played on a regular DVD player or computer equipped with a suitable DVD-ROM drive. Finalizing a Video mode disc creates a menu screen for navigating the disc. This is accessed by pressing DISC MENU or TITLE. **To finalize a disc, refer to "Disc Finalize" on page 25.**

Recording from an External Input (Continued)

What is DV?

Using DV, also known as i.LINK, you can connect a DV-equipped camcorder to this recorder using a single DV cable for input and output of audio, video, data and control signals.

The i.LINK interface is also known as IEEE 1394-1995. "i.LINK" and the "i.LINK" logo are trademarks.

- This recorder is only compatible with DV-format (DVC-SD) camcorders. Digital satellite tuners and Digital VHS video recorders are not compatible.
- You cannot connect more than one DV camcorder at a time to this recorder.
- You cannot control this recorder from external equipment connected via the DV IN jack (including two DVD Recorders).
- It may not always be possible to control the connected camcorder via the DV IN jack.
- Digital camcorders can usually record audio as stereo 16-bit/48kHz, or twin stereo tracks of 12-bit/32kHz. The VCR/DVD Recorder can only record one stereo audio track. Set DV Record Audio to Audio 1 or Audio 2 as required (see page 24).
- Audio input to the DV IN jack should be 32 or 48kHz (not 44.1kHz).
- Picture disturbance on the recording may occur if the source component pauses playback or plays an unrecorded section of tape, or if the power fails in the source component, or the DV cable becomes disconnected.
- If DV Record Audio is set to Audio 2 and Audio 2 signal is not present, DV Record Audio will be reset to Audio 1 automatically.

DV-Related Messages

You may see the following messages appear on your TV screen when using the DV IN jack.

Camcorder not connected

The camcorder is not connected properly, or the camcorder is switched off.

Too many devices connected

The DV jack on this recorder supports connection to just one camcorder.

Check tape

There is no cassette loaded into the connected equipment.

Uncontrollable device

The VCR/DVD Recorder cannot control the camcorder.

Updating device information

Camcorder is updating information for DV.

Camera Mode

Camcorder is set to camera mode.

Troubleshooting

If you cannot get a picture and/or audio through the DV IN jack, check the bullet points:

- Make sure the DV cable is properly connected.
- Try switching off the connected equipment then switch back on.
- Try switching the audio input.

Note

Depending on the connected camcorder, you may not be able to control it using the remote control supplied with this VCR/DVD Recorder.

VR Mode: Original and Playlist Editing

Edits you make to the Original content changes the actual content of the disc. For example, if you delete a title or chapter from the Original content (Title or Chapter), that title or chapter is deleted from the disc, freeing up extra recording time.

When you edit the Playlist, on the other hand, you are not changing the content of the disc. For example, when you delete a title from the Playlist, you are just telling the recorder not to play that title; nothing is actually deleted from the disc.

Titles, Chapters and Parts **VR**

Titles in the disc's original content contain one or more chapters. When you insert a title into the Playlist, all the chapters within that title also appear. In other words, chapters in the Playlist behave exactly as chapters on a DVD-Video disc do. Parts are sections of Original or Playlist titles. From the Original and Playlist menu you can add or delete parts. Adding a chapter or title to the Playlist creates a new title made up of a section (i.e., chapter) of an Original title. Deleting a part removes part of a title from the Original or Playlist menu.

Caution

- When editing using the Delete, Add and Move functions, the start and end frames may not be exactly as set in the start and end point display.
- During Playlist playback, you may notice a momentary pause between edits. This is not a malfunction.

Adding Chapter Markers **VR**



You can put a chapter marker anywhere in a Playlist or Original title during recording or playback.

Once the chapter is marked, you can use the Chapter Search feature, as well as Erase, combine and move chapters in the Original (Chapter) or Playlist (Chapter) menu.

You can insert up to 999 chapter markers in both the Original and Playlist contents.

1 Play the title (Original or Playlist).

2 At the point you want to start a new chapter, press **CHP ADD**.

- A chapter marker icon appears on the TV screen.
- You can also put chapter markers during recording.

Changing Title or Chapter Thumbnails



Each title and chapter displayed in the Original or Playlist menu is represented by a thumbnail picture taken from the start of that title or chapter.

If you prefer, select a different still picture from within a title.

1 Play the title (Original or Playlist).

2 Press **THUMBNAIL** to make the currently displayed picture the one that appears in the Original or Playlist menu.

- The still picture that you choose appears in both the Original or Playlist menu.



You can also change the thumbnail picture of the title on the Original (Chapter) or Playlist (Chapter) menu. Select a chapter on the Original (Chapter) or Playlist (Chapter) menu then press **THUMBNAIL**. The thumbnail picture of the title that includes the chapter is changed.

VR Mode: Original and Playlist Editing (Continued)

Using the Original (Title) menu **VR**

The Original (Title) is where you build and edit your Playlist, and where you can delete titles and make other changes to the Original content of the disc. You can also play individual titles directly from the Original (Title) menu.

1 Press DISC MENU/LIST repeatedly to display the Original (Title) menu.

- Use the ▲/▼ buttons to display the previous/next page if there are more than 6 titles or chapters.
- To exit the menu, press RETURN (↵).

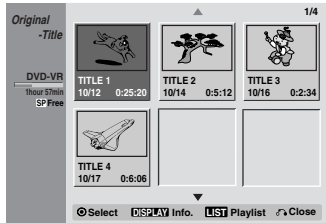

Note

To switch between the Original (Title) and Playlist (Title) menu, press DISC MENU/LIST repeatedly. The Original and Playlist heading at the top of the screen indicate which mode you are in.

2 To view Original (Title) options, select the title you want then press ENTER.

Original (Title) options appears on the left side of the Original (Title) display.

3 Use ▲ / ▼ to select an option then press ENTER to confirm.

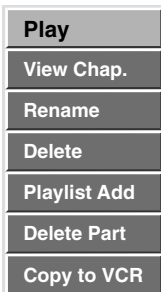

Play: Start playback of the selected title.

View Chap.: Moves to Original (Chapter) menu (Refer to right column on this page).

Rename: Edits the title name. (page 47)

Delete: Deletes the title from the Original (Title) menu. (see page 47)

Playlist Add: Adds the title to the Playlist. (see page 48)

Delete Part: Deletes a part of the Title. (see page 50)

Copy to VCR: Copys the title to a VHS tape.

4 Press RETURN (↵) repeatedly to exit the Original (Title) menu.

Tip

Press DISPLAY to display more detailed title information for selected title.

Using the Original (Chapter) menu **VR**

1 Press DISC MENU/LIST repeatedly to display Original (Title) menu.

2 Use ▲▼◀▶ to choose the title you want to view Original (Chapter) menu then press ENTER.

Original (Title) options appears on the left side of the Original (Title) menu.

3 Use ▲ / ▼ to select 'View Chap.' from Original (Title) options then press ENTER.

Original (Chapter) menu appears on the TV screen.

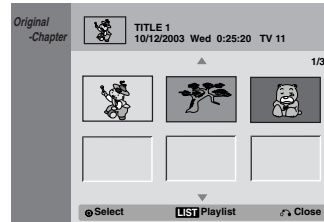

4 To view Original (Chapter) options, select the chapter you want then press ENTER.

Original (Chapter) options appears on the left side of the Original (Chapter) menu.

5 Use ▲ / ▼ to select an option then press ENTER to confirm.



Play: Starts playback of the selected chapter.

View Title: Moves to Original (Title) menu of the chapter. (refer to left on this page)

Delete: Deletes the chapter from the Original (Chapter) menu. (page 47)

Merge: Merges two chapters into one. (page 49)

Playlist Add: Adds the chapter to the Playlist. (page 48)

6 Press RETURN (↵) repeatedly to exit Original (Chapter) menu.

VR Mode: Original and Playlist Editing (Continued)

Using the Playlist (Title) Menu **VR**

- 1 Press **DISC MENU/LIST** repeatedly to display the **Playlist (Title)** menu.
 - Use the **▲/▼** buttons to display the previous/next page if there are more than 6 titles or chapters.
 - To exit the **Playlist (Title)**, press **RETURN** (↵).

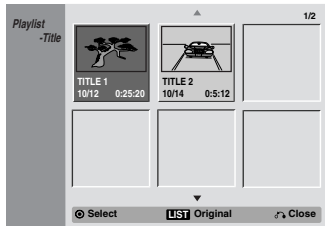

- 2 To view **Playlist (Title)** options, select the title you want then press **ENTER**.
Playlist (Title) options appears on the left side of the **Playlist (Title)** menu.
- 3 Use **▲ / ▼** to select an option then press **ENTER** to confirm.

Play
View Chap.
Rename
Delete
Delete Part
Copy to VCR

- Play:** Start playback the selected title.
- View Chap.:** Moves **Playlist (Chapter)** menu. (Refer to right on this page)
- Rename:** Edits the title name. (page 47)
- Delete:** Deletes the title from the **Playlist (Title)** menu. (page 47)
- Delete Part:** Deletes a part of the Title. (page 50)
- Copy to VCR:** Copys the title to a VHS tape.

- 4 Press **RETURN** (↵) repeatedly to exit **Playlist (Title)** menu.

Using the Playlist (Chapter) Menu **VR**

- 1 Press **DISC MENU/LIST** repeatedly to display the **Playlist (Title)** menu.
- 2 Use **▲ ▼ ◀ ▶** to choose the title you want to view **Playlist (Title)** menu then press **ENTER**.
Playlist (Title) options appears on the left side of the **Playlist (Title)** menu.
- 3 Use **▲ / ▼** to select 'View Chap.' from **Playlist (Title)** options then press **ENTER**.
Playlist (Chapter) menu appears on the TV screen.

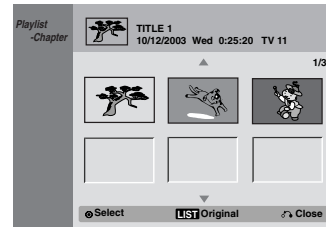

- 4 To view **Playlist (Chapter)** options, select the chapter you want then press **ENTER**.
Playlist (Chapter) options appears on the left side of the **Playlist (Chapter)** menu.
- 5 Use **▲ / ▼** to select an option then press **ENTER** to confirm.

Play
View Title
Delete
Move
Merge

- Play:** Starts playback of the selected chapter.
- View Title:** Moves to **Playlist (Title)** menu. (Refer to left on this page)
- Delete:** Deletes the chapter from the **Playlist (Chapter)** menu. (page 47)
- Move:** Moves a chapter of **Playlist (Chapter)** to a position on the **Playlist (Chapter)** menu. (page 49)
- Merge:** Merges two chapters into one. (page 49)

- 6 Press **RETURN** (↵) repeatedly to exit **Playlist (Chapter)** menu.

VR Mode: Original and Playlist Editing (Continued)

Naming a Title **VR**

You can name Original and Playlist titles independently. Names can be up to 32 characters long.

1 Press **DISC MENU/LIST** repeatedly to display **Original (Title) or Playlist (Title) menu**.

2 Use **▲▼◀▶** to choose the title you want to name then press **ENTER**.

Options appears on the left side of the menu.

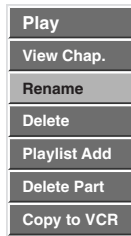

Original (Title)

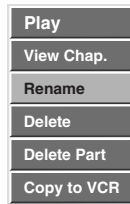

Playlist (Title)

3 Use **▲▼** to select 'Rename' option then press **ENTER**.

The Keyboard menu appears.



4 Enter a name for the title. Use **▲▼◀▶** to select a character then press **ENTER** to confirm your selection. Refer step 5 as shown on page 26 (DISC Name).

5 Choose **OK** then press **ENTER** to save the name and return to the previous menu screen.

6 Press **RETURN** (**↵**) repeatedly to exit the menu.

Note

For discs formatted on a different DVD Recorder, you will see only a limited character set.

Deleting an Original or Playlist

Title/Chapter **VR**

When you erase a title or chapter from the Playlist menu, you only remove it from the Playlist; the title/chapter remains in the Original menu.

If you choose to delete a title or chapter from the Original (title/chapter) menu, the title or chapter is actually deleted from the disc and the remaining time available for recording increases. Titles/chapters deleted from the Original are also removed from the Playlist.

Note

It may not be possible to delete chapters that are less than 3 seconds long.

1 Press **DISC MENU/LIST** repeatedly to display **Original (Title) or Playlist (Title) menu**.

If you want to display the Original (Chapter) or Playlist (Chapter) menu, refer to "Using Original (Chapter) menu" or "Using Playlist (Chapter) menu" on pages 45-46.

2 Use **▲▼◀▶** to choose a chapter or title you want to delete then press **ENTER**.

Options appears on the left side of the screen.

3 Select 'Delete' on the menu.

e.g., If you select "Delete" on Original (Title) menu.

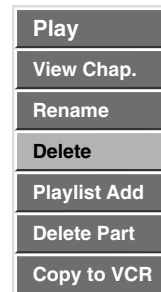

4 Press **ENTER** to confirm. The confirm message for deleting will appear.

5 Use **◀/▶** to select 'Yes' then press **ENTER**.

The selected chapter or title is deleted. After pressing **ENTER**, the new, updated menu is displayed.

6 Repeat steps 2 - 5 to continue to delete from the menu.

7 Press **RETURN** (**↵**) repeatedly to exit the menu.

VR Mode: Original and Playlist Editing (Continued)

Making a New Playlist **VR**

Use this function to add an Original title or chapter to the Playlist. When you do this, the whole title is put into the Playlist (you can delete bits you don't need later — see Deleting an Original or Playlist Title/Chapter on page 48).

The title appears in the Playlist complete with the chapter markers that appear in the Original. However, if you add more chapter markers to the Original later, these are not automatically copied over into the Playlist title.

You can add up to 999 chapters to one disc. If you only want to add a chapter of a title, use the Adding a title/chapter to the Playlist on page 48.

1 Press DISC MENU/LIST repeatedly to display Original (Title) menu.

If you want to display the Original (Chapter) menu, refer to “Using the Original (Chapter) menu” on page 45.

2 Choose a title or chapter on the Original menu to put into the Playlist, then press ENTER.

Original (Title or Chapter) options appears on the left side of the Original (Title or Chapter) menu.

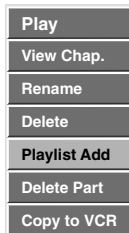

Original (Title)



Original (Chapter)

3 Use ▲ / ▼ to select ‘Playlist Add’ from from the Original (Title or Chapter) options then press ENTER.

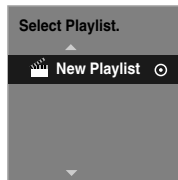

4 Select ‘New Playlist’ then press ENTER.

The new title appears in the updated Playlist. All chapters of the title are added to the Playlist.

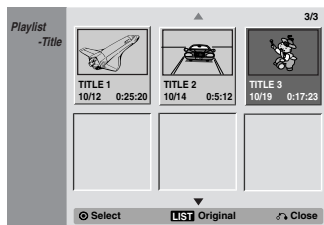

Adding Titles/Chapters to the Playlist **VR**

VR

You can add an Original title or chapter to add to a Playlist title even if it is already registered.

1 Press DISC MENU/LIST repeatedly to display Original (Title) menu.

If you want to show the Original (Chapter) menu, refer to “Using the Original (Chapter)” on page 45.

2 Choose an Original title or chapter to put into the Playlist, then press ENTER.

The Original (Title) or Original (Chapter) options appear on the left side of the screen.

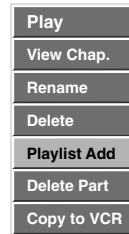

Original (Title)



Original (Chapter)

3 Use ▲ / ▼ to select ‘Playlist Add’ from the Original (Title) or Original (Chapter) options then press ENTER.



4 Choose a Playlist title that is already registered to insert a title, then press ENTER.

The title appears in the updated Playlist menu.

5 Repeat steps 1-4 to continue adding to the Playlist.

6 Press RETURN (↵) to exit, or DISC MENU/LIST to go back to the Original (Title) menu.

VR Mode: Original and Playlist Editing (Continued)

Combining Two Chapters Into One

VR

Use this function to combine two adjacent Playlist or Original chapters into one.

1 Press **DISC MENU/LIST** repeatedly to display **Original (Title)** or **Playlist (Title)** menu.

If you want to display the Original (Chapter) or Playlist (Chapter) menu, refer to "Using the Original (Chapter)" and "Using the Playlist (Chapter)" on page 45-46.

2 First, select the second chapter of the two chapters you want to combine then press **ENTER** on the **Original (Chapter)** or **playlist (Chapter)** menu.

Playlist (Chapter) or Original (Chapter) options appears on the left side of the screen.



Original (Chapter)

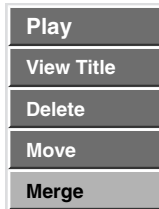

Playlist (Chapter)

3 Use **▲ / ▼** to select 'Merge' option then press **ENTER**.

The confirm message for combining will appear.

4 Use **◀ / ▶** to select 'Yes' then press **ENTER**.

After pressing **ENTER**, the new, updated menu is displayed.

5 Repeat steps 2 - 5 to continue to merge from the menu.

6 Press **RETURN (↵)** repeatedly to exit the menu.

Note

This function cannot operate listed below;

- If there is only one chapter within the title.
- If two chapters created by erasing a part from an original title.
- If two chapters created from different titles.
- If two chapters created by moving an order from an original title.

Moving a Playlist Chapter **VR**

Use this function to re-arrange the playing order of Playlist chapters on the Playlist (Title) menu.

1 Press **DISC MENU/LIST** repeatedly to display **Playlist (Title)** menu.

To display the Playlist (Chapter) menu, refer to "Using the Playlist (Chapter)" on page 46.

Note

This function is not available if there is only one chapter.

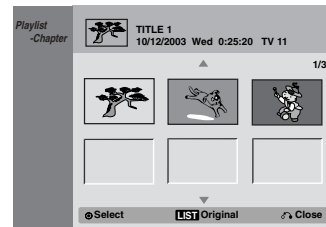

2 Select a chapter from the **Playlist (Chapter)** menu.

3 Press **ENTER**.

Playlist (Chapter) options appears on the left side of the screen.



4 Use **▲ / ▼** to select 'Move' from Playlist options then press **ENTER**.

5 Use **▲ ▼ ◀ ▶** to choose the place you want to move the chapter to then press **ENTER**.

The confirm message for moving will appear.

6 Use **◀ / ▶** to select 'Yes' then press **ENTER**.

After pressing **ENTER**, the new, updated menu is displayed.

7 Repeat steps 2 - 6 to continue to move from the menu.

8 Press **RETURN (↵)** repeatedly to exit the menu.

EDITING

VR Mode: Original and Playlist Editing (Continued)

Deleting a Part **VR**

You can delete a part which you do not want in the title.

1 Press **DISC MENU/LIST** repeatedly to display **Original (Title)** or **Playlist (Title)** menu.

2 Use **▲▼◀▶** to choose a title you want to delete then press **ENTER**.

The options appears on the left side of the menu.

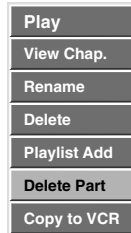

Original (Title)

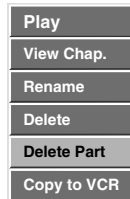

Playlist (Title)

Note

If you select **Cancel** then press **ENTER**, the VCR/DVD Recorder will go to previous option and into **Pause** mode.

3 Use **▲/▼** to select '**Delete Part**' then press **ENTER**.

The Title Edit menu appears on the TV screen and the VCR/DVD Recorder goes into **Pause** mode. The **Start Point** option is highlighted.

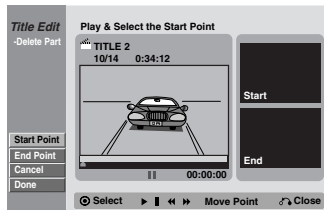

4 Use **PLAY, PAUSE/STEP, FF, REW, and Slow Motion** playback to find the starting point.

The segment is indicated in yellow on the **Progress Bar**.

5 Press **ENTER** at the starting point of the segment you want to erase.

The **End Point** option is selected.

6 Use **PLAY, PAUSE/STEP, FF, REW, and Slow Motion** playback to find the ending point.

7 Press **ENTER** at the ending point of the section you want to edit.

The **Done** option is selected.

To cancel the Edit mode, select **Cancel** using **▲/▼** then press **ENTER**.

8 Press **ENTER** to delete the selected part.

When the confirm menu appears, select "**Yes**" using **◀/▶** then press **ENTER**.

To erase additional segments, repeat steps 4-8.

9 When finished editing, press **RETURN (↵)**.

The **Original (Title)** or **Playlist (Title)** menu appears.

Video Mode: Original Editing

Using the Title List Video

From the Title List display you can play, name and erase titles.

Once a Video mode disc is finalized, the Title List screen changes its appearance and all you can do is select titles to play.

1 Press DISC MENU/LIST to display the Title List.

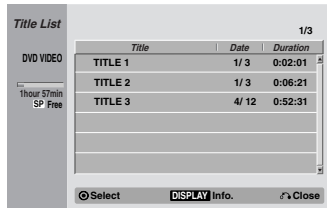

2 Use ▲ / ▼ to choose a title then press ENTER. Title List options appears on the left side of the Title List display. If you get more information, press Display

3 Use ▲ / ▼ to select an option then press ENTER to confirm.



Play: Start playback the selected title.

Rename: Edits the title name (page 47).

Delete: Deletes the title from the Title List.

Copy to VCR: Copys the title to a VHS tape.

4 Press RETURN (↵) repeatedly to exit Title List.

Deleting a Title Video

Before a disc is finalized, you can erase titles recorded on the disc.

⚠ Caution

- If you erase a title from a DVD-R disc, the title will disappear from the Title List, but the available recording time will not increase.
- When erasing a title from a DVD-RW disc, the remaining time available for recording will only increase if it is the last title on the disc.

1 Press DISC MENU/LIST to display Title List

2 Use ▲ ▼ ◀ ▶ to choose a title you want to erase then press ENTER.

Title List options appears on the left side of the Title List screen.

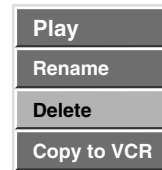

3 Use ▲ / ▼ to select 'Delete' then press ENTER to confirm.

The confirm message for deleting will appear.

4 Use ◀ / ▶ to select 'Yes' then press ENTER.

The selected chapter or title is deleted.
After pressing ENTER, the new, updated menu is displayed.

5 Repeat steps 2 - 4 to continue to delete from the menu.

6 Press RETURN (↵) to exit the menu.

If the disc has already been finalized

You will see a screen as shown below:

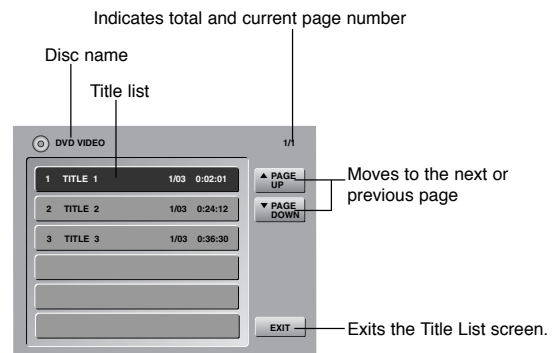

Controlling Your TV with the Supplied Remote

You can control the sound level, input source, and power switch of your LG TV with the supplied remote.

You can control your TV using the buttons below.

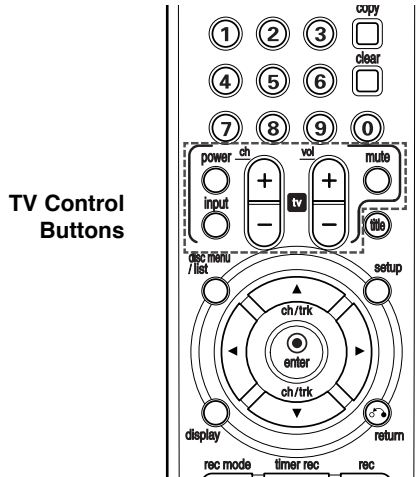

TV Control Buttons

By pressing	You can
POWER	Turn the TV on or off.
INPUT	Switch the TV's input source between the TV and other input sources.
CH +/-	Scans up or down through memorized channels.
VOL +/-	Adjust the volume of the TV.
MUTE	Turns on or off TV sound.

Note

Depending on the unit being connected, you may not be able to control your TV using some of the buttons.

Controlling other TVs with the remote

You can control the sound level, input source, and power switch of non-LG TVs as well. If your TV is listed in the table below, set the appropriate manufacturer code.

1. While holding down TV POWER button, press the number buttons to select the manufacturer code for your TV (see the table below).
2. Release TV POWER button.

Code numbers of controllable TVs

If more than one code number is listed, try entering them one at a time until you find the one that works with your TV.

Manufacturer	Code Number
LG / GoldStar	1 (Default), 2
Zenith	1, 3, 4
Samsung	6, 7
Sony	8, 9
Hitachi	4

Notes

- Depending on your TV, some or all buttons may not function on the TV, even after entering the correct manufacturer code.
- If you enter a new code number, the code number previously entered will be erased.
- When you replace the batteries of the remote, the code number you have set may be reset to the default setting. Set the appropriate code number again.

Language Code List

Enter the appropriate code number for the initial settings “Disc Audio”, “Disc Subtitle” and/or “Disc Menu” (See page 20).

Code	Language	Code	Language	Code	Language	Code	Language
6566	Abkhazian	7074	Fiji	7678	Lingala	8373	Singhalese
6565	Afar	7073	Finnish	7684	Lithuanian	8375	Slovak
6570	Afrikaans	7082	French	7775	Macedonian	8376	Slovenian
8381	Albanian	7089	Frisian	7771	Malagasy	8379	Somali
6577	Amharic	7176	Galician	7783	Malay	6983	Spanish
6582	Arabic	7565	Georgian	7776	Malayalam	8385	Sudanese
7289	Armenian	6869	German	7784	Maltese	8387	Swahili
6583	Assamese	6976	Greek	7773	Maori	8386	Swedish
6588	Aymara	7576	Greenlandic	7782	Marathi	8476	Tagalog
6590	Azerbaijani	7178	Guarani	7779	Moldavian	8471	Tajik
6665	Bashkir	7185	Gujarati	7778	Mongolian	8465	Tamil
6985	Basque	7265	Hausa	7865	Nauru	8484	Tatar
6678	Bengali; Bangla	7387	Hebrew	7869	Nepali	8469	Telugu
6890	Bhutani	7273	Hindi	7879	Norwegian	8472	Thai
6672	Bihari	7285	Hungarian	7982	Oriya	6679	Tibetan
6682	Breton	7383	Icelandic	8065	Panjabi	8473	Tigrinya
6671	Bulgarian	7378	Indonesian	8083	Pashto, Pushto	8479	Tonga
7789	Burmese	7365	Interlingua	7065	Persian	8482	Turkish
6669	Byelorussian	7165	Irish	8076	Polish	8475	Turkmen
7577	Cambodian	7384	Italian	8084	Portuguese	8487	Twi
6765	Catalan	7465	Japanese	8185	Quechua	8575	Ukrainian
9072	Chinese	7487	Javanese	8277	Rhaeto-Romance	8582	Urdu
6779	Corsican	7578	Kannada	8279	Romanian	8590	Uzbek
7282	Croatian	7583	Kashmiri	8285	Russian	8673	Vietnamese
6783	Czech	7575	Kazakh	8377	Samoan	8679	Volapük
6865	Danish	7589	Kirghiz	8365	Sanskrit	6789	Welsh
7876	Dutch	7579	Korean	7168	Scots Gaelic	8779	Wolof
6978	English	7585	Kurdish	8382	Serbian	8872	Xhosa
6979	Esperanto	7679	Laothian	8372	Serbo-Croatian	7473	Yiddish
6984	Estonian	7665	Latin	8378	Shona	8979	Yoruba
7079	Faeroese	7686	Latvian, Lettish	8368	Sindhi	9085	Zulu

Country Code List

Enter the appropriate code number for the initial setting "Country Code" (See page 23).

Code	Country	Code	Country	Code	Country	Code	Country
AD	Andorra	ER	Eritrea	LC	Saint Lucia	SC	Seychelles
AE	United Arab Emirates	ES	Spain	LI	Liechtenstein	SD	Sudan
AF	Afghanistan	ET	Ethiopia	LK	Sri Lanka	SE	Sweden
AG	Antigua and Barbuda	FI	Finland	LR	Liberia	SG	Singapore
AI	Anguilla	FJ	Fiji	LS	Lesotho	SH	Saint Helena
AL	Albania	FK	Falkland Islands	LT	Lithuania	SI	Slovenia
AM	Armenia	FM	Micronesia	LU	Luxembourg	SJ	Svalbard and Jan Mayen Islands
AN	Netherlands Antilles	FO	Faroe Islands	LV	Latvia	SK	Slovak Republic
AO	Angola	FR	France	LY	Libya	SL	Sierra Leone
AQ	Antarctica	FX	France (European Territory)	MA	Morocco	SM	San Marino
AR	Argentina	GA	Gabon	MC	Monaco	SN	Senegal
AS	American Samoa	GB	Great Britain	MD	Moldavia	SO	Somalia
AT	Austria	GD	Grenada	MG	Madagascar	SR	Suriname
AU	Australia	GE	Georgia	MH	Marshall Islands	ST	Saint Tome and Principe
AW	Aruba	GF	French Guyana	ML	Mali	SU	Former USSR
AZ	Azerbaijan	GH	Ghana	MM	Myanmar	SV	El Salvador
BA	Bosnia-Herzegovina	GI	Gibraltar	MN	Mongolia	SY	Syria
BB	Barbados	GL	Greenland	MO	Macau	SZ	Swaziland
BD	Bangladesh	GM	Gambia	MP	Northern Mariana Islands	TC	Turks and Caicos Islands
BE	Belgium	GN	Guinea	MQ	Martinique (French)	TD	Chad
BF	Burkina Faso	GP	Guadeloupe (French)	MR	Mauritania	TF	French Southern Territories
BG	Bulgaria	GQ	Equatorial Guinea	MS	Montserrat	TG	Togo
BH	Bahrain	GR	Greece	MT	Malta	TH	Thailand
BI	Burundi	GS	S. Georgia & S. Sandwich Isls.	MU	Mauritius	TJ	Tadjikistan
BJ	Benin	GT	Guatemala	MV	Maldives	TK	Tokelau
BM	Bermuda	GU	Guam (USA)	MW	Malawi	TM	Turkmenistan
BN	Brunei Darussalam	GW	Guinea Bissau	MX	Mexico	TN	Tunisia
BO	Bolivia	GY	Guyana	MY	Malaysia	TO	Tonga
BR	Brazil	HK	Hong Kong	MZ	Mozambique	TP	East Timor
BS	Bahamas	HM	Heard and McDonald Islands	AN	Namibia	TR	Turkey
BT	Bhutan	HN	Honduras	NC	New Caledonia (French)	TT	Trinidad and Tobago
BV	Bouvet Island	HR	Croatia	NE	Niger	TV	Tuvalu
BW	Botswana	HT	Haiti	NF	Norfolk Island	TW	Taiwan
BY	Belarus	HU	Hungary	NG	Nigeria	TZ	Tanzania
BZ	Belize	ID	Indonesia	NI	Nicaragua	UA	Ukraine
CA	Canada	IE	Ireland	NL	Netherlands	UG	Uganda
CC	Cocos (Keeling) Islands	IL	Israel	NO	Norway	UK	United Kingdom
CF	Central African Republic	IN	India	NP	Nepal	UM	USA Minor Outlying Islands
CG	Congo	IO	British Indian Ocean Territory	NR	Nauru	US	United States
CH	Switzerland	IQ	Iraq	NU	Niue	UY	Uruguay
CI	Ivory Coast	IR	Iran	PA	Panama	UZ	Uzbekistan
CK	Cook Islands	IS	Iceland	PE	Peru	VA	Vatican City State
CL	Chile	IT	Italy	PF	Polynesia (French)	VC	Saint Vincent & Grenadines
CM	Cameroon	JM	Jamaica	PG	Papua New Guinea	VE	Venezuela
CN	China	JO	Jordan	PH	Philippines	VG	Virgin Islands (British)
CO	Colombia	JP	Japan	PK	Pakistan	VI	Virgin Islands (USA)
CR	Costa Rica	KE	Kenya	PL	Poland	VN	Vietnam
CS	Former Czechoslovakia	KG	Kyrgyzstan	PM	Saint Pierre and Miquelon	VU	Vanuatu
CU	Cuba	KH	Cambodia	PN	Pitcairn Island	WF	Wallis and Futuna Islands
CV	Cape Verde	KI	Kiribati	PR	Puerto Rico	WS	Samoa
CX	Christmas Island	KM	Comoros	PT	Portugal	YE	Yemen
CY	Cyprus	KN	Saint Kitts & Nevis Anguilla	PW	Palau	YT	Mayotte
CZ	Czech Republic	KP	North Korea	PY	Paraguay	YU	Yugoslavia
DE	Germany	KR	South Korea	QA	Qatar	ZA	South Africa
DJ	Djibouti	KW	Kuwait	RE	Reunion (French)	ZM	Zambia
DK	Denmark	KY	Cayman Islands	RO	Romania	ZR	Zaire
DM	Dominica	KZ	Kazakhstan	RU	Russian Federation	ZW	Zimbabwe
DO	Dominican Republic	LA	Laos	RW	Rwanda		
DZ	Algeria	LB	Lebanon	SA	Saudi Arabia		
EC	Ecuador			SB	Solomon Islands		
EE	Estonia						
EG	Egypt						
EH	Western Sahara						

Troubleshooting

Check the following guide for the possible cause of a problem before contacting service.

Symptom	Cause	Solution
No power.	<ul style="list-style-type: none"> The power cord is disconnected. 	<ul style="list-style-type: none"> Plug the power cord into the wall outlet securely.
No picture.	<ul style="list-style-type: none"> The TV is not set to receive VCR/DVD Recorder signal output. 	<ul style="list-style-type: none"> Select the appropriate video input on the TV so the picture from the VCR/DVD Recorder appears on the TV screen.
	<ul style="list-style-type: none"> The video cable is not connected securely. 	<ul style="list-style-type: none"> Connect the video cable securely.
	<ul style="list-style-type: none"> The TV power is turned off. 	<ul style="list-style-type: none"> Turn on the TV.
No sound.	<ul style="list-style-type: none"> The equipment connected with the audio cable is not set to receive VCR/DVD Recorder signal output. 	<ul style="list-style-type: none"> Select the correct input mode on the audio receiver so you can listen to the sound from the VCR/DVD Recorder.
	<ul style="list-style-type: none"> The audio cables are not connected securely. 	<ul style="list-style-type: none"> Connect the audio cable securely.
	<ul style="list-style-type: none"> The power of the equipment connected with the audio cable is turned off. 	<ul style="list-style-type: none"> Turn on the equipment connected with the audio cable.
	<ul style="list-style-type: none"> The audio connecting cord is damaged. 	<ul style="list-style-type: none"> Replace it with a new one.
Playback picture is poor.	<ul style="list-style-type: none"> The disc is dirty. 	<ul style="list-style-type: none"> Clean the disc.
	<ul style="list-style-type: none"> Tape heads are dirty. 	<ul style="list-style-type: none"> Clean video heads.
	<ul style="list-style-type: none"> Tape is a rental or was recorded on another VCR. 	<ul style="list-style-type: none"> Use ▲/▼ for manual tracking adjustment while tape is playing.
VCR/DVD Recorder does not start playback.	<ul style="list-style-type: none"> No disc is inserted. No tape is inserted. 	<ul style="list-style-type: none"> Insert a disc or tape. (Check that the disc indicator on the front panel display is lit.)
	<ul style="list-style-type: none"> An unplayable disc is inserted. 	<ul style="list-style-type: none"> Insert a playable disc. (Check the disc type, color system, and regional code.)
	<ul style="list-style-type: none"> The disc is placed upside down. 	<ul style="list-style-type: none"> Place the disc with the playback side down.
	<ul style="list-style-type: none"> The disc is not placed within the guide. 	<ul style="list-style-type: none"> Place the disc on the disc tray correctly inside the guide.
	<ul style="list-style-type: none"> The disc is dirty. 	<ul style="list-style-type: none"> Clean the disc.
	<ul style="list-style-type: none"> The Movie Rating level is set. 	<ul style="list-style-type: none"> Cancel the Movie Rating function or change the rating level.
Picture from external input is distorted	<ul style="list-style-type: none"> The video signal from the external component is copy-protected. 	<ul style="list-style-type: none"> You cannot connect via the VCR/DVD Recorder. Connect the component directly to your TV.
Some channels are skipped over when using CH (▲ / ▼)	<ul style="list-style-type: none"> The skipped channels were deleted with the CH. Add/Del feature. 	<ul style="list-style-type: none"> Use the CH. Add/Del feature to restore channels. See "Channel Add/Delete" on page 18.
Picture or sound of broadcasting channel is weak or missing.	<ul style="list-style-type: none"> Antenna or cables are loose. 	<ul style="list-style-type: none"> Tighten connections or replace cable.
	<ul style="list-style-type: none"> Wrong Tuning Band is selected in the VCR/DVD Recorder Setup menu. 	<ul style="list-style-type: none"> Try all "Tuning Band" options; see page 18 for details.
Camcorder image not shown.	<ul style="list-style-type: none"> Camcorder is off. 	<ul style="list-style-type: none"> Turn camcorder on and operate properly.
Camcorder image via A/V input or DV IN to VCR/DVD Recorder is not shown on TV screen.	<ul style="list-style-type: none"> VCR/DVD Recorder's source is not set to AV1, AV2 (AV2 COMP) or DV IN. 	<ul style="list-style-type: none"> Use INPUT to select AV input channel (AV1, AV2 (AV2 COMP) or DV IN).
Can't play disc recorded on this VCR/DVD Recorder on another DVD player.	<ul style="list-style-type: none"> The disc was recorded in Video mode. 	<ul style="list-style-type: none"> Finalize the disc; see page 25.
	<ul style="list-style-type: none"> Some players will not play even a finalized disc recorded in Video mode. 	<ul style="list-style-type: none"> No solution.
	<ul style="list-style-type: none"> The disc was recorded in VR mode. 	<ul style="list-style-type: none"> The other player must be RW compatible in order to play it.
	<ul style="list-style-type: none"> Discs recorded with copy-once material cannot be played on other players. 	<ul style="list-style-type: none"> No solution.

Troubleshooting (Continued)

Symptom	Cause	Solution
Cannot record or did not record successfully.	<ul style="list-style-type: none"> The remaining blank space on the disc is insufficient. 	<ul style="list-style-type: none"> Use another disc.
	<ul style="list-style-type: none"> The source you are trying to record is copy-protected. 	<ul style="list-style-type: none"> You cannot record the source.
	<ul style="list-style-type: none"> When setting the recording channel, the channel is tuned on the TV's own tuner. 	<ul style="list-style-type: none"> Select the channel on the VCR/DVD Recorder's built-in TV tuner.
	<ul style="list-style-type: none"> When recording to a Video mode disc, programs that are copy-once protected cannot be recorded. 	<ul style="list-style-type: none"> Use a VR mode formatted disc for copy-once material.
Timer Recording not possible.	<ul style="list-style-type: none"> Clock in VCR/DVD Recorder is not set to correct time. 	<ul style="list-style-type: none"> Set clock to correct time. See "Clock (Auto)" or "Clock (Manual)" on page 19.
	<ul style="list-style-type: none"> Timer has been programmed incorrectly. 	<ul style="list-style-type: none"> Reprogram Timer. See "Timer Recording" on page 41.
	<ul style="list-style-type: none"> TIMER indicator light does not appear after programming timer. 	<ul style="list-style-type: none"> Reprogram Timer.
Stereo Audio Record and/or Playback not present.	<ul style="list-style-type: none"> TV is not Stereo-compatible. 	<ul style="list-style-type: none"> No solution.
	<ul style="list-style-type: none"> Broadcast program is not in stereo format. 	<ul style="list-style-type: none"> No solution.
	<ul style="list-style-type: none"> VCR/DVD Recorder A/V Out jacks are not connected to TV A/V In jacks. 	<ul style="list-style-type: none"> Make A/V connections. Stereo is available only via A/V output from VCR/DVD Recorder.
	<ul style="list-style-type: none"> VCR/DVD Recorder Audio/Video Out is not selected for viewing at the TV. 	<ul style="list-style-type: none"> Select AUX or A/V source as TV input.
	<ul style="list-style-type: none"> VCR/DVD Recorder's TV audio channel is set to SAP or MONO. 	<ul style="list-style-type: none"> Set TV audio channel mode to Stereo. See "Changing TV Audio Channel" on page 27.
Remote control does not work properly.	<ul style="list-style-type: none"> The remote control is not pointed at the remote sensor of the VCR/DVD Recorder. 	<ul style="list-style-type: none"> Point the remote control at the remote sensor of the VCR/DVD Recorder.
	<ul style="list-style-type: none"> The remote control is too far from the VCR/DVD Recorder. 	<ul style="list-style-type: none"> Operate the remote control within 23 ft (7 m).
	<ul style="list-style-type: none"> There is an obstacle in the path of the remote control and the VCR/DVD Recorder. 	<ul style="list-style-type: none"> Remove the obstacle.
	<ul style="list-style-type: none"> The batteries in the remote control are exhausted. 	<ul style="list-style-type: none"> Replace the batteries with new ones.

Moisture Condensation

Moisture condensation can occur:	In locations where moisture condensation may occur:
<ul style="list-style-type: none"> When the VCR/DVD Recorder is moved from a cold place to a warm place. Under extremely humid conditions. 	<ul style="list-style-type: none"> Keep the VCR/DVD Recorder plugged into an AC power outlet with POWER On. This will help prevent condensation. When condensation has occurred, wait a few hours for the VCR/DVD Recorder to dry before using it.

Reset the VCR/DVD Recorder

If you observe any of the following symptoms...

- When the VCR/DVD Recorder is plugged in, but the power will not turn on or off.
- When the display window does not working.
- When the VCR/DVD Recorder does not operate normally.

You can reset the VCR/DVD Recorder as follows :

- Press and hold the POWER button for more than five seconds. This will force the VCR/DVD Recorder to power off. Press the POWER button again to turn the VCR/DVD Recorder back on.
- Unplug the power cord and then plug the power cord again after more than five seconds.

Specifications

General

Power requirements	AC 120V, 60 Hz
Power consumption	35W
Dimensions (approx.)	430 X 83.5 X 360 mm (16.9 x 3.25 x 14.2 inches) (w x h x d)
Mass (approx.)	6.8 kg (14.9 lbs)
Operating temperature	5°C to 35°C (41°F to 95°F)
Operating humidity	5 % to 90 %
Signal system	NTSC

Recording

Recording format	DVD VideoRecording, DVD-VIDEO
Recordable discs	DVD-ReRecordable, DVD-Recordable
Recordable time	DVD ; Approx. 1 hour (XP mode), 2 hours (SP mode), 4 hours (LP mode) VCR ; SP: 2 HOURS (T-120), SLP: 6 HOURS (T-120)/8 HOURS (T-160)

Video recording format

Sampling frequency	27MHz
Compression format	MPEG 2

Audio recording format

Sampling frequency	48kHz
Compression format	Dolby Digital

VCR Specifications

Head system	Four head helical scan azimuth system
Timer	12-hour display type with AM, PM
Tape speed	SP: 33.35 mm/sec, LP: 16.67 mm/sec, SLP: 11.12 mm/sec
Tape width	12.7 mm
Rewind time	About 65 seconds (T-120)
Antenna	75 ohms (VHF/UHF)
VHF output signal	Channel 3 or 4 (Switchable)
Channel coverage	VHF: 2-13, UHF: 14-69, CATV: 1-125 (4A, A-W, W+1 - W+84, A-5 - A-1)
Frequency range	20Hz to 20kHz
Signal-to-noise ratio	43dB
Dynamic range	88 dB
Channel separation	60 dB

DVD Specifications

Laser system	Semiconductor laser, wavelength 650 nm
Frequency response	DVD (PCM 48 kHz): 8 Hz to 22 kHz, CD: 8 Hz to 20 kHz
Signal-to-noise ratio	More than 95dB
Harmonic distortion	Less than 0.008%
Dynamic range	More than 90 dB

Inputs

ANTENNA IN	Antenna or CATV input, 75 ohms
VIDEO IN (AV1,2)	1.0 Vp-p 75 ohms, sync negative, RCA jack x 2
AUDIO IN (AV1,2)	-6 dBm more than 47 kohms, RCA jack (L, R) x 2
DV IN	4 pin (i.LINK/IEEE 1394 standard)

Specifications (Continued)

Outputs

VIDEO OUT	1 Vp-p 75 Ω , sync negative, RCA jack x 1
S-VIDEO OUT	(Y) 1.0 V (p-p), 75 Ω , negative sync, Mini DIN 4-pin x 1 (C) 0.286 V (p-p) 75 Ω
COMPONENT VIDEO OUT (PROGRESSIVE SCAN)	(Y) 1.0 V (p-p), 75 Ω , negative sync, RCA jack x 1 (Pb)/(Pr) 0.7 V (p-p), 75 Ω , RCA jack x 2
Audio output (digital audio)	0.5 V (p-p), 75 Ω , RCA jack x 1
Audio output (optical audio)	Optical connector x 1
Audio output (analog audio)	1.1 Vrms (1 kHz, -6 dB), 600 Ω , RCA jack (L, R) x 2
RF OUT	Channel 3 or 4 (Switchable)

Accessory:

Video cable1	Audio cable1
RF 75-ohm Coaxial Cable1	Remote control1
Batteries2		

- Design and specifications are subject to change without notice.

Manufactured under license from Dolby Laboratories. "Dolby", "Pro Logic" and the double-D symbol are trademarks of Dolby Laboratories.

DTS and DTS Digital Out are registered trademarks of Digital Theater Systems, Inc.

**ZENITH ELECTRONICS CORPORATION
VCR/DVD Recorder XBR413 LIMITED WARRANTY – USA**



Zenith will repair or replace your product, at Zenith's option, if it proves to be defective in material or workmanship under normal use, during the warranty period ("Warranty Period") listed below, effective from the date ("Date of Purchase") of original consumer purchase of the product. This limited warranty is good only to the original purchaser of the product and effective only when used in the United States, excluding U.S. Territories.

<p>WARRANTY PERIOD:</p> <p>LABOR: 90 days from the Date of Purchase.</p> <p>Parts: One year from the Date of Purchase.</p> <p>* Parts replaced are warranted for the remaining portion of the original warranty period.</p>	<p>HOW SERVICE IS HANDLED:</p> <p>Carry-in Service: Please retain dealer's dated bill of sale or delivery ticket as evidence of the Date of Purchase for proof of warranty, and submit a copy of the bill of sale to the service person at the time warranty service is provided.</p> <p>Please call 1-877-9Zenith (1-877-993-6484) to locate your nearest Zenith Authorized Service Center.</p> <p>Or visit our website at http://www.zenithservice.com</p>
--	--

THIS WARRANTY IS IN LIEU OF ANY OTHER WARRANTIES, EXPRESS OR IMPLIED, INCLUDING WITHOUT LIMITATION, ANY WARRANTY OF MERCHANTABILITY OR FITNESS FOR A PARTICULAR PURPOSE. TO THE EXTENT ANY IMPLIED WARRANTY IS REQUIRED BY LAW, IT IS LIMITED IN DURATION TO THE EXPRESS WARRANTY PERIOD ABOVE. ZENITH WILL NOT BE LIABLE FOR ANY INCIDENTAL, CONSEQUENTIAL, INDIRECT, SPECIAL OR PUNITIVE DAMAGES OF ANY NATURE, EVEN IF ADVISED OF THE POSSIBILITY OF SUCH DAMAGES, INCLUDING WITHOUT LIMITATION, LOST REVENUES OR PROFITS, LOST OR CORRUPTED PROGRAMMING OR DATA, OR ANY OTHER DAMAGE WHETHER BASED IN CONTRACT, TORT OR OTHERWISE.

Some states do not allow the exclusion or limitation of incidental or consequential damages or limitation on how long an implied warranty lasts, so the above exclusion or limitation may not apply to you. This warranty gives you specific legal rights and you may also have other rights that may vary from state to state.

THIS LIMITED WARRANTY DOES NOT APPLY TO:

1. Damages or operating problems that result from shipping, installation, adjustment of user controls, calibration, maintenance or failure to maintain, or separate system components; and
2. Damages or operating problems that result from normal wear and tear, misuse, abuse, operation outside environmental specifications or contrary to the requirements or precautions in the Operating Guide, accident, lightning strikes or other natural causes, unauthorized modification or alteration, incorrect electrical current or voltage, signal reception or input, software not licensed directly by Zenith, software errors that do not disable functionality, operating and software protocols adopted after date of manufacture or for outside the US, institutional or commercial use, or other causes not arising out of defect in material or workmanship.
3. **Therefore, the cost of repair or replacement of such a defective product shall be borne by the consumer.**

CUSTOMER INTER-ACTIVE CENTER NUMBERS:

<p>For nearest Authorized Service Center, Where to buy, Product Assistance, or Customer Assistance</p>	<p>Call 1-877-9Zenith (1-877-993-6484) (24 hours a day, 365 days per year) and select appropriate option from the menu.</p> <p>Or visit our website at http://www.zenithservice.com</p>
---	---