



FCC ID: XLY-2054

ATTACHMENT E.

- User Manual -

HCT CO., LTD.

SAN 136-1, AMI-RI, BUBAL-EUP, ICHEON-SI, KYOUNGKI-DO, 467-701, KOREA
TEL:+82 31 639 8517 FAX:+82 31 639 8525 www.hct.co.kr

Report No. : HCTR0909FR03

1/1



RF SYSTEM LOCKER LOCK

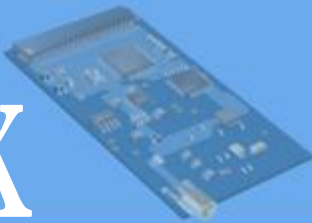

RFID Modules



RFID Locks



RFID Terminals



RFID Solutions

SYSTEM COMPONENTS

PASSTECH
Smartcard / RFID Systems

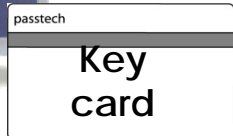

Key Management System

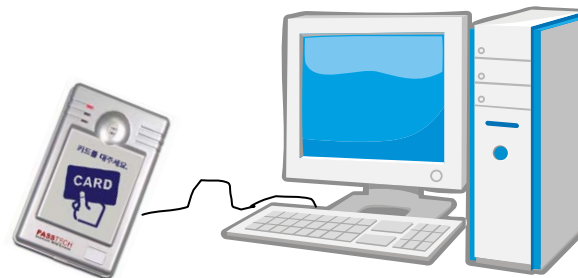

Card Issuing System

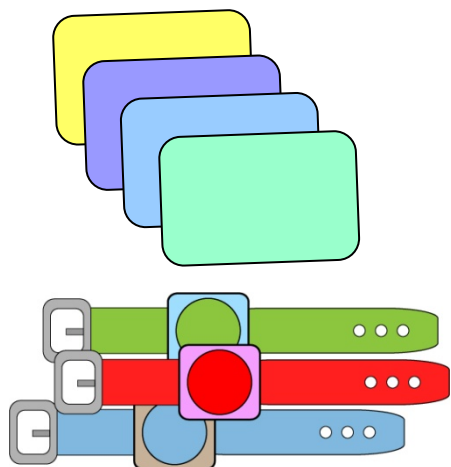

Card set



Info Terminal

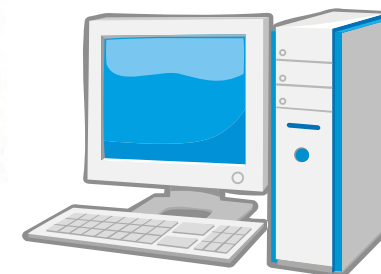

Management Information system

TECHNICAL SPECIFICATIONS



ITEM	FEATURES
Main CPU	8bit Microprocessor
RF Protocol	13.56Mhz ISO 14443 Type A (basic)
Security	Unique key for RF lockers and cards
Power	6V battery operated (AA battery 4 pcs.) External Battery socket for battery override External AC power (Optional)
Operation signal	LED (Green/Red) and Beep
History Tracking	The latest 18 times use
Operation Mode	Free selection / Pre-assigned / Multi-lockers /Multi-users Matrix / Week-day operation (optional)
Time Recording	Built-in Timer
Dimension	Front case : 53.34mm(W) x 19.54mm(D) x 68.58mm (H) Back case : 98.9mm (W) x 34.29mm(D) x 70.00mm (H)
Housing	Polycarbonate & ABS
Operating temperature	- 10°C to +70°C (+14°F to +159°F)
Safety & Reliability	FCC (USA), CE(Europe), MIC (Korea) Designed for waterproof

*drawn by H.S. Park
2008. 10. 13 (Mon)*

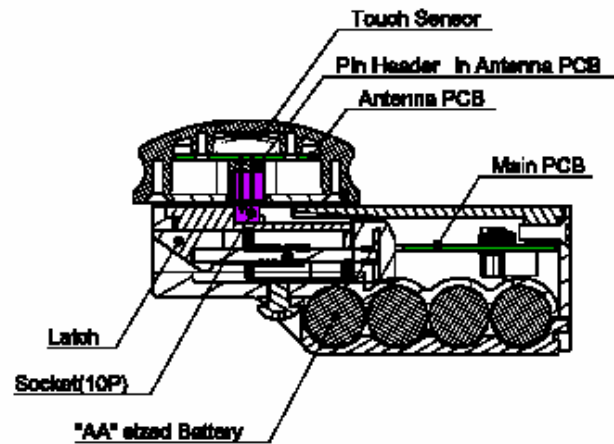

Section view A-A

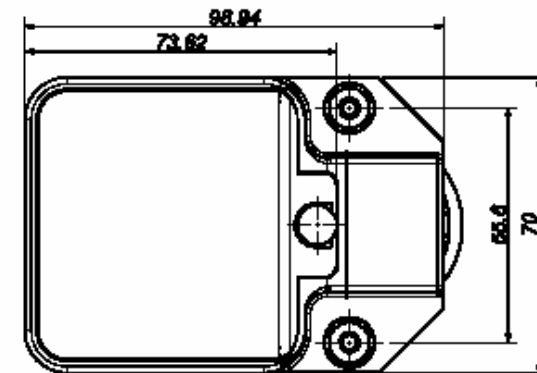
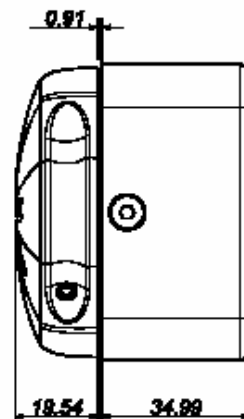
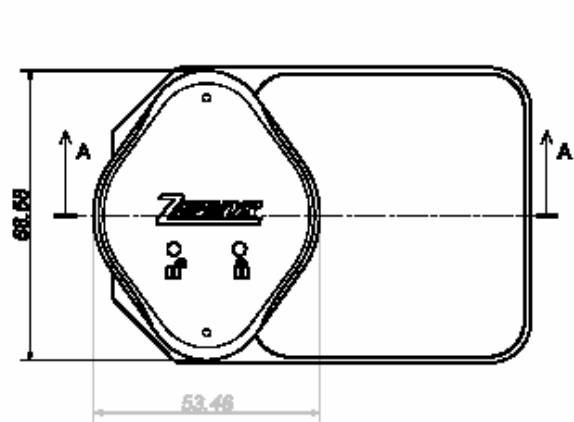
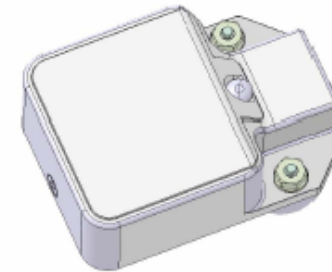
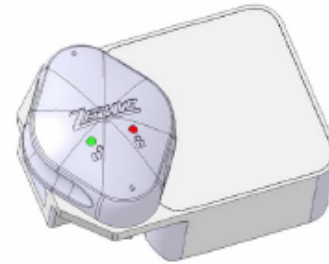

● **Easy Programmable to various operation mode**

- ❖ Free Selection / Pre-assigned mode
- ❖ Multi Users (upto 9 users for a locker) / Multi Lockers (upto 5 lockers for a user)
- ❖ Matrix / Week-day operation
- ❖ Time based program for shifts – time setting for 3 shifts

● **Easy installation and maintenance**

- ❖ Low installation costs for retrofitting existing lockers
- ❖ Program upgrade at site by using embedded communication socket without dismantle the 2054.
- ❖ Just issue new User card in the event User card is lost. No need to replace the 2054.
- ❖ Flexibility in setting the RF locker locks.
 - Setting 2054 is possible before or after the 2054 installation.
- ❖ Suitable for all types of lockers (wood, metal, and HPL)



● **Simple programming the RF locker Lock and management**

- ❖ Just touch the keycard and setup card on the 2054, then setting is finished.
- ❖ By using MIS program, operator can supervise the RF locks in a system.
 - Low battery, Locker occupancy (Pre-Assigned), Tracking the locker usage, statistics generation, User card management.
- ❖ Possible to change the RF locker lock program without dismantling 2054 in the event Locker operation mode needs to be changed.

● **Unique Key with the highest Key Security by Triple DES security algorithm**

- ❖ Same Security level used in Banking Smart cards.
- ❖ Variable unique key for each card

- ◆ Wake-up by touch sensor & 13.56Mhz ISO 14443 Type A RF based operation
- ◆ Off-line 6V battery operated (basic) / On-line AC Power (Optional)

I. Free Selection

- Initial Status : Bolt is recessed (door open)
 - ❖ Put closely the card on the front cover of the 2054
 - ❖ 2054 read the card validity and key, then write the Locker information to the card.
 - ❖ Bolt comes out from the back housing, and Locker is closed.
 - ❖ Put closely the card on the front cover of the 2054.
 - ❖ 2054 authenticates the card, and releases the 2054.



II. Pre-Assigned Mode

- Initial Status : Bolt comes out (door closed)
 - ❖ Put closely the card on the front cover of the 2054
 - ❖ 2054 authenticates the Card (Locker number, key, and validity).
 - ❖ Bolt is released after the authentication process.
 - ❖ Bolt operation can be set as semi-automatic cycle or full automatic cycle.



● Free Selection Mode

- User can select any empty locker.
- LED lamp is blinked to represent locker is empty.
- Programmable to use multiple locks with one User card (max. 5 lockers)
- Programmable to Time based operation

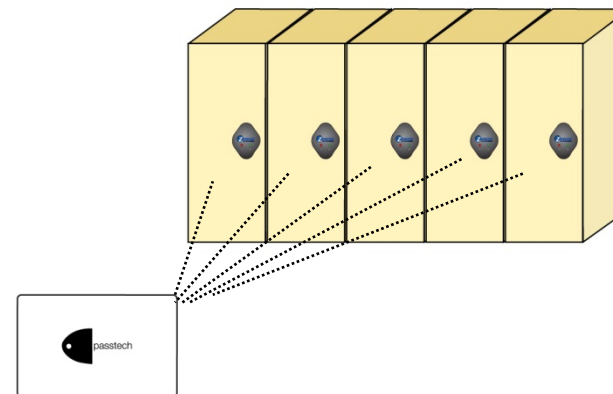

● Pre-Assigned Mode

- Assigned locker number is registered on the card when card is issued.
- 2054 check the locker number and validity of the card.
- Programmable to use multiple assigned lockers with one card (max. 5 lockers in current program).
- Programmable to use multiple user mode.

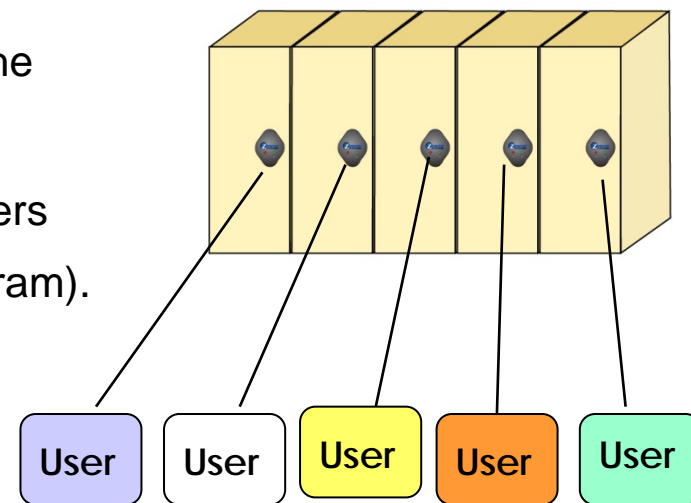

● Multi-user Mode

- Multi user can share one locker.
- Applicable to both Free Selection and Pre-Assigned Operation mode.
- Current program setting : upto 9 users can share a RF locker.

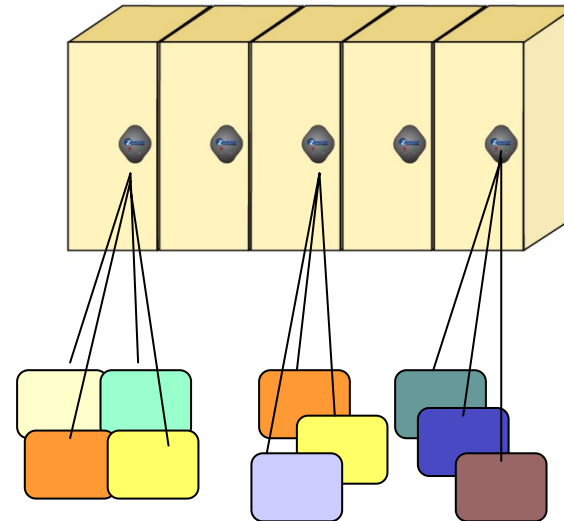

● Multi-Locker Mode

- One user can use multiple lockers.
- Current program setting : upto 5 lockers can be occupied by a User
- Applicable to both Free Selection and Pre-Assigned Operation mode.

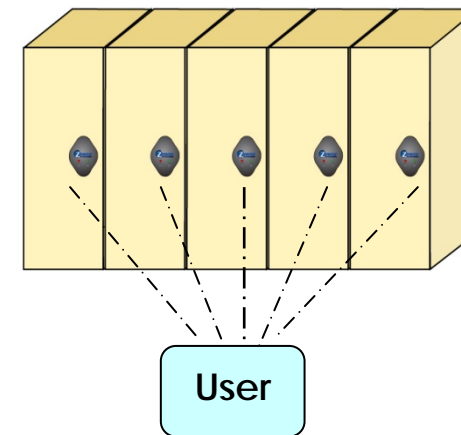

● Matrix Mode

- It is a mixed operation mode of Multiple locker Mode and Multi User Mode.
- A ZP-100 can accept upto 9 users.

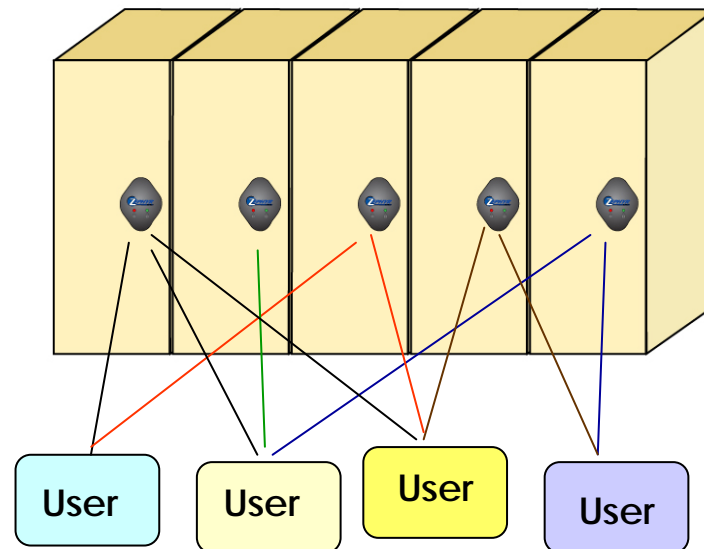

This equipment has been tested and found to comply with the limits for a Class A digital device, pursuant to part 15 of the FCC Rules. These limits are designed to provide reasonable protection against harmful interference in a residential installation. This equipment generates, uses and can radiate radio frequency energy and, if not installed and used in accordance with the instructions, may cause harmful interference to radio communications. However, there is no guarantee that interference will not occur in a particular installation. If this equipment does cause harmful interference to radio or television reception, which can be determined by turning the equipment off and on, the user is encouraged to try to correct the interference by one or more of the following measures:

- Reorient or relocate the receiving antenna.
- Increase the separation between the equipment and receiver.
- Connect the equipment into an outlet on a circuit different from that to which the receiver is connected.
- Consult the dealer or an experienced radio/TV technician for help.

Caution: Any changes or modifications to this device not explicitly approved by manufacturer could void your authority to operate this equipment.

This device complies with part 15 of the FCC Rules. Operation is subject to the following two conditions: (1) This device may not cause harmful interference, and (2) this device must accept any interference received, including interference that may cause undesired operation.