



NAVIGATOR X820

User's Manual

V1.0.1

ZHEJIANG DAHUA VISION TECHNOLOGY CO.,LTD

Copyright

© 2017 ZHEJIANG DAHUA VISION TECHNOLOGY CO.,LTD. All rights reserved.

Any or full contents of the user's manual cannot be copied, transmitted, distributed, partially or wholly, by any means, without the prior written notice of ZHEJIANG DAHUA VISION TECHNOLOGY CO.,LTD.

Dahua or the third party may reserve the right of the product described in this user's manual. Without the prior written approval of the corresponding party, any person cannot (including but not limited to) copy, distribute, amend, excerpt, reverse compile, disassemble, decode, reverse engineering, rent, transfer or sublicense the software.

Trademark

 and **HDCVI** are the trademarks or registered trademarks of Dahua and its branch companies in various jurisdictions. Other trademarks or company names mentioned are the properties of their respective owners.

Update and Modification

- In order to enhance the product security and provide better user experience, Dahua may improve the product via software auto update, but Dahua doesn't need to inform in advance and isn't liable to any responsibility.
- Dahua reserves the right to modify any information in this document at any time; the modified contents will be added into the new version without prior announcement. There may be minor differences about some product functions after it is updated.

Document Overview

The manual is to comprehensively introduce function features, structure parameters, installation, dismounting and flight guide etc. of the product.

Applied Model

X820

Application Object

Main readers of this manual are end users.

Reading Guide





| Chapter No. | Chapter Name | Main Content |
|-------------|--------------------|---|
| 1 | Product Overview | It is to introduce the function features and application scenarios of the product. |
| 2 | Product Component | It is to comprehensively introduce main components of the product. Read the chapter before use; understand product structure and application methods of main components. |
| 3 | Flight Preparation | It is to elaborate the complete flow of aircraft unlock before takeoff. Strictly conform to the installation debugging sequence of the chapter, install each component and make initial debugging before first use. If it is not the first time to use the device, you can select the installation content according to the dismounting situation last time. However, confirm that all the components (unnecessary steps excluded) listed in the chapter have been stably installed. Please conform to the operating steps in this chapter strictly and follow the operating sequence. |
| 4 | Enable Flight | It is to elaborate the complete flow of aircraft formal launch and landing. Complete the preparation steps listed in Chapter 3. Confirm that all the inspection items, including environment and the device itself, conform to flight requirements before enabling flight. Please operate by strictly conforming to the steps described in the chapter; the operation sequence can't be reversed. |
| 5 | End Flight | It is to elaborate the operation steps after aircraft landing. Please operate by strictly conforming to the steps described in this chapter; the operation sequence can't be reversed. |

| | | |
|----|------------|---|
| 6 | Upgrade | It is to introduce upgrade methods and points of attention. |
| 7 | Appendix 1 | It is to introduce the technical parameters. |
| 8 | Appendix 2 | It is to introduce the indicator definition of the aircraft. |
| 9 | Appendix 3 | It is to introduce the matching method among the components. |
| 10 | Appendix 4 | It is to list possible problems and solutions when using the product. |

17803 大華 2018-01-08

Symbol Definition

The following symbol may appear in the document. Please refer to the table below for the respective definition.

| Symbol | Note |
|--|---|
|  Danger | It indicates a potentially hazardous situation which, if not avoided, could result in death or serious injury. |
|  Warning | It indicates a moderate or low level of potential danger which, if not avoided, could result in minor or moderate injury. |
|  Caution | It indicates a potential risk that, if ignored, could result in damage to device, degraded performance, or unpredictable results. |
|  Tips | It means that it can help you to solve some problem or save your time. |
|  Note | It means the additional information, which is the emphasis and supplement of the main body. |

Document Material

The product includes the following document materials. Please search according to your requirements:

- *Quick Start Guide*

It applies to the first simple flight. Please refer to *User's Manual* for operation details when it is used for the second time or it has to use some other advanced functions.

Check the paper material in the packaging box or log in www.dahuasecurity.com to obtain the *User's Manual*.

- *User's Manual* (this document)

It comprehensively introduces the product function features, structure parameters, installation, dismounting and flight guide etc.

Log in www.dahuasecurity.com to obtain the *User's Manual*.

Revision Record

| No. | Version No. | Revision Content | Release Date |
|-----|-------------|------------------|--------------|
| 1 | V1.0.0 | First release | 2017.8.17 |

Important Safeguards and Warnings

The following description is the correct application method of the device. Please read the manual carefully before use, in order to prevent danger and property loss. Strictly conform to the manual during application and keep it properly after reading.

Danger

- Please operate the aircraft in the environment which meets flight conditions, and keep away from no-fly zone.
- After unlocking, operators shall keep at least 3m away from the aircraft, in order to prevent personal injury.

Warning

- Please transport, use and store the product and all its components in the environment which satisfies the requirements.
- Please strictly conform to operation flows described in the manual when dismantling the device. Please do not dismantle other components privately.

Caution

- Before the first flight, please carry out geomagnetic calibration according to 3.9.5.
- Please do not touch the lens of PTZ camera directly. Use hair drier to remove the dust or dirt from the lens surface.
- Please operate the device by strictly conforming to the steps described in the manual; the operation sequence can't be reversed.
- Get to know local laws and regulations before using the aircraft. Please apply to local authorities for flight permission if necessary.
- For the first flight, please adopt loiter mode (before takeoff, it is suggested that GPS satellites are ≥ 12 and horizontal precision factor is ≤ 1).
- Please make sure that the device antenna has been properly installed before enabling the power of remote control, ground station or aircraft. Otherwise, it may cause damages to internal module or shorten the control distance.
- This device only uses antenna of the certification with non-standard connector. No third-party antennas are allowed.

Flight Environment

Warning

Please make flight in the environment which meets the following conditions:

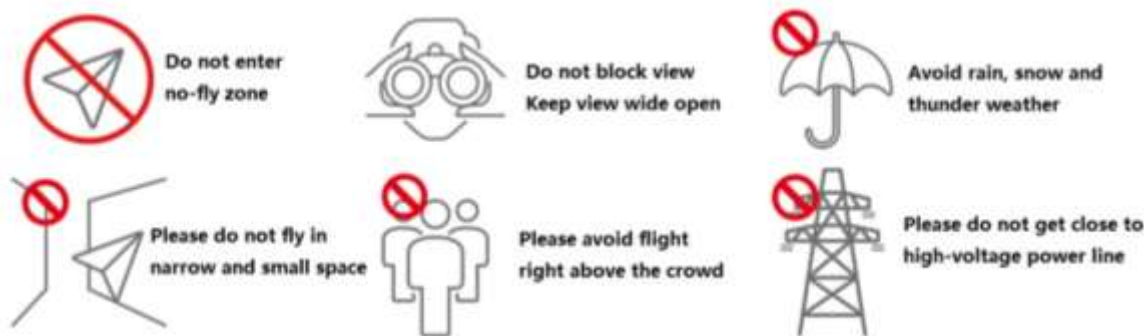

- Keep away from no-fly zone; please do not enter no-fly zone.
- Keep view wide open; make sure the device is flying within field of view; please do not block field of view.
- Please do not fly the aircraft in rain, snow and thunder weather.
- Please do not fly in narrow and small space.
- Try not to fly right above the crowd, in order to prevent personal injury.
- Please do not get close to high-voltage power line. Keep more than 10m distance.

Power Requirement



Caution

- The product shall use electric wires (power wires) recommended by this area, which shall be used within its rated specification!
- Products with category I structure shall be connected to grid power output socket, which is equipped with protective grounding.
- Please conform to local electrical safety standards strictly.
- Before operation, please check whether power supply is correct.
- Please use power supply that meets SELV (safety extra low voltage) requirements, and supply power with rated voltage that conforms to Limited Power Source in IEC60950-1. For specific power supply requirements, please refer to device labels.
- Prevent power cord from being trampled or pressed, especially the plug, power socket and the junction extruded from the device.

Battery Points of Attention



Warning

- It has to use the exclusive power adapter provided by Dahua Technology to charge the device. Otherwise, it may damage the battery or lead to other unpredictable consequences.
- Charge the device at a temperature between 0 and 50°C.
- Distinguish positive and negative poles when charging the device, to prevent short circuit.
- Charge and discharge at least once every month; prohibit storing the device without electricity.
- Please do not place the device close to fire source or inflammables.
- Please do not charge and discharge the device in unattended conditions.

- Please do not use undesignated battery to the device.
- Please do not dismantle and destroy the battery without permission; water is not allowed to enter the device; man-made damages are not covered by warranty.
- Please do not throw the battery into fire or expose it to high-temperature environment.
- Please do not dismantle, modify or deform the battery.
- Avoid short circuit between positive and negative contacts (please do not place the battery together with the objects such as necklace and hairpin etc. when carrying or storing the battery).
- Please replace new battery timely when it is damaged.
- Please charge the battery or discharge it to 30%~40% remaining capacity if it won't be used for a long time, and place it in a dry and cool environment under an ambient temperature of -20°C—35°C.
- If the battery leaks and the liquid enters eyes accidentally, please do not rub your eyes; wash your eyes with clean water and see a doctor immediately.



Caution

- It is normal that the battery heats up after it is running for a period of time, because the discharge power is quite big.
- It is normal that the battery heats up when it is being charged.
- The cycle times of power battery is 300 in normal application situation.
- During charging of power battery, charging is completed when the charger displays “FULL” and beeps for 5 times. Don't take down batteries before charging is completed.

Application Environment Requirements

- Please do not aim the device at strong light (such as lighting, sunlight and so on).
- Please transport, use and store the device within the allowed humidity and temperature range.
- Please do not let any liquid flow into the device.
- Please do not block the device ventilation.
- Please do not press, vibrate or soak the device.
- Please pack the device with default package or material with equivalent quality.
- This device complies with Part 15 of the FCC Rules. Operation is subject to the following two conditions: (1) this device may not cause harmful interference, and (2) this device must accept any interference received, including interference that may cause undesired operation.
- Caution: The user is cautioned that changes or modifications not expressly approved by the party responsible for compliance could void the user's authority to operate the equipment.
- Note: This equipment has been tested and found to comply with the limits for a Class B digital device, pursuant to part 15 of the FCC Rules. These limits are designed to provide reasonable protection against harmful interference in a residential installation. This equipment generates uses and can radiate radio frequency energy and, if not installed and used in accordance with the instructions, may cause harmful interference to radio communications. However, there is no guarantee that interference will not occur in a particular installation. If this equipment does cause harmful interference to radio or

television reception, which can be determined by turning the equipment off and on, the user is encouraged to try to correct the interference by one or more of the following measures:

- Reorient or relocate the receiving antenna.
- Increase the separation between the equipment and receiver.
- Connect the equipment into an outlet on a circuit different from that to which the receiver is connected.
- Consult the dealer or an experienced radio/TV technician for help.

17803 大華 2018-01-08

Operation and Maintenance Requirements



Warning

- Please do not dismantle the device privately.
- Please do not touch sensor CCD or CMOS directly; use hair drier to remove dust or dirt from the lens surface.
- Please use soft dry cloth or clean soft cloth to dip a little mild detergent to clean the device.
- Please do not touch or wipe the lens surface directly.
- Please modify the user's default password in time after login, to avoid being embezzled.
- Please use the accessories provided by manufacturer and it shall be installed and repaired by professional staffs.
- Please avoid laser beam radiation to the surface when using laser beam device.
- Please do not provide two or more power supply modes to the device at the same time; otherwise, it may damage the device.
- Max 3 aircrafts are allowed to fly in the same area at the same time. Two remote controls shall be at least 15m away from each other, thus avoid radio interference and guarantee control distance.
- Please make sure that there is no occlusion above the flight.

Special Announcement

- This manual is for reference only. Please refer to the actual product for more details.
- The user's manual and software will be regularly updated according to the product upgrade without prior announcement.
- The user shall undertake any losses resulting from violation of guidance in the document.
- The document may include technically inaccurate contents, inconsistencies with product functions and operations, or misprint. Final explanations of the company shall prevail.
- Interface in this manual may be slightly different from actual interface. Please refer to actual interface for details.

Table of Contents

| | |
|--|-----------|
| Legal Statement | I |
| Preface | II |
| Important Safeguards and Warnings | V |
| 1. Product Introduction | 1 |
| 1.1 Overview | 1 |
| 1.2 Functional Features | 1 |
| 2. Structure | 4 |
| 2.1 Aircraft..... | 4 |
| 2.1.1 Product Dimensions..... | 4 |
| 2.1.2 Structural Component..... | 6 |
| 2.2 Airborne Device | 7 |
| 2.2.1 Visible Light PTZ Camera..... | 8 |
| 2.2.2 Thermal PTZ Camera (Optional) | 11 |
| 2.3 Remote Control..... | 14 |
| 2.3.1 Dimensions | 14 |
| 2.3.2 Structural Component..... | 15 |
| 2.3.3 Buttons..... | 19 |
| 2.3.4 Operation Interface | 21 |
| 2.4 Ground Control Station (GCS)..... | 27 |
| 2.4.1 Dimensions | 27 |
| 2.4.2 Structural Component..... | 28 |
| 2.4.3 Operation GUI..... | 29 |
| 3. Flight Preparation | 36 |
| 3.1 Unpack..... | 36 |
| 3.2 Check Remaining Power | 37 |
| 3.2.1 Aircraft..... | 37 |
| 3.2.2 Remote Control | 38 |
| 3.2.3 Ground Station Battery Check | 38 |
| 3.3 Charging | 39 |
| 3.3.1 Aircraft Battery Charging..... | 39 |
| 3.3.2 Remote Control Charging | 40 |
| 3.3.3 Ground Station Charging | 41 |
| 3.4 Prepare Equipment..... | 41 |
| 3.4.1 Prepare Airborne Equipment..... | 41 |
| 3.4.2 External Microphone..... | 42 |
| 3.5 Prepare Aircraft..... | 43 |
| 3.5.1 Unfold Aircraft Arm..... | 43 |
| 3.5.2 Open Antenna..... | 43 |
| 3.5.3 Install Aircraft Battery | 44 |
| 3.6 Prepare Ground Station..... | 45 |
| 3.6.1 Set up Antenna..... | 45 |

| | | |
|-----------|---|-----------|
| 3.6.2 | Enable Ground Station Power..... | 46 |
| 3.8 | Prepare Remote Control..... | 47 |
| 3.8.1 | Install SD Card..... | 47 |
| 3.8.2 | Open Antenna..... | 47 |
| 3.8.3 | Enable Remote Control Power..... | 48 |
| 3.8.4 | Confirm Remote Control Mode..... | 48 |
| 3.9 | Enable Aircraft Power..... | 48 |
| 3.10 | Check and Debugging..... | 49 |
| 3.10.1 | Aircraft Diagnosis..... | 49 |
| 3.10.2 | Remote Control Calibration..... | 50 |
| 3.10.3 | Accelerometer Calibration..... | 51 |
| 3.10.4 | Initialization Failure..... | 52 |
| 3.10.5 | Geomagnetic Abnormity..... | 52 |
| 3.10.6 | GPS Satellites Insufficiency..... | 54 |
| 3.11 | Install Propellers..... | 54 |
| 4. | Enable Flight..... | 56 |
| 4.1 | Flight Mode..... | 56 |
| 4.2 | Manual Mode..... | 57 |
| 4.2.1 | Introduction to Manual Flight Flow..... | 57 |
| 4.2.2 | Unlock Flight Control..... | 57 |
| 4.2.3 | Manual Takeoff..... | 58 |
| 4.2.4 | Manual Flight Control..... | 59 |
| 4.2.5 | Manual RTH and Landing..... | 60 |
| 4.2.6 | Manual Locking..... | 61 |
| 4.3 | Intelligent Mode..... | 62 |
| 4.3.1 | Flight Route..... | 62 |
| 4.3.2 | Intelligent Flight Mode..... | 63 |
| 4.3.3 | Intelligent Locking Mode..... | 67 |
| 4.4 | Intelligent Protection Mechanism..... | 69 |
| 4.4.1 | Low Battery..... | 69 |
| 4.4.2 | Out of Control..... | 69 |
| 4.4.3 | Electronic Fence..... | 69 |
| 4.5 | Other Parameters..... | 72 |
| 4.5.1 | Remote Control Parameter Settings..... | 72 |
| 4.5.2 | Ground Station Parameter Settings..... | 76 |
| 5. | End Flight..... | 79 |
| 5.1 | Turn off Power..... | 79 |
| 5.2 | Remove Aircraft Battery..... | 80 |
| 5.3 | Dismantle Airborne Equipment..... | 81 |
| 5.4 | Fold Aircraft..... | 81 |
| 5.5 | Dismantle Image Transmission Antenna..... | 82 |
| 5.6 | Copy Video of Camera SD Card..... | 83 |
| 5.7 | Remove Other Components..... | 83 |
| 6. | Upgrade and Update..... | 84 |
| 6.1 | Aircraft Firmware Update..... | 84 |
| 6.2 | Remote Control Update..... | 84 |
| 6.2.1 | APP Update..... | 84 |

| | |
|---|------------|
| 6.2.2 Download and Update Offline Map of Remote Control | 85 |
| 6.3 Ground Station Update | 87 |
| 6.3.1 Ground Station Software Update..... | 87 |
| 6.3.2 Ground Station Map Update..... | 88 |
| 6.3.3 Ground Station Offline Map | 88 |
| Appendix 1 Main Technical Parameters | 92 |
| Appendix 2 Aircraft Status Indicator..... | 96 |
| Appendix 3 System Pairing..... | 98 |
| Appendix 4 FAQ..... | 100 |
| Appendix 4.1 FAQ and Solutions of Aircraft | 100 |
| Appendix 4.2 FAQ and Solutions of Remote Control | 100 |
| Appendix 4.3 FAQ and Solutions of Ground Station | 101 |
| Appendix 4.4 FAQ and Solutions of Airborne Equipment | 101 |
| Appendix 4.5 FAQ and Solutions of Charger | 101 |

17803 大华 2018-01-08

1 ■ Product Introduction

1.1 Overview

This product is a quadrotor drone designed for public security, transportation, firefighting, border defense, agriculture, forest and energy source fields. It provides integrated solutions of aerial video surveillance.

This product consists of aircraft, airborne device, remote control and ground control station (GCS).

- Aircraft: It consists of navigation system, flight control system and power system.
- Airborne device: It consists of the PTZ control system, task device and servo motor.
- Remote control: It consists of the remote control system and touch screen.
- GCS: It consists of the PC, image transmission system and ground control station software.

1.2 Functional Features

Integrated Design

- The aircraft adopts integrated design and neat appearance. Only the propeller shall be dismantled and installed.
- The remote control integrates the remote control and touch screen together. It is easy to operate and has clear indicator.

Folded Packages

- The aircraft arm can be folded repeatedly.
- Antennas can be folded repeatedly and dismantled, suitable to be carried, transported and stored.

Quick Dismantling

- The propeller adopts quick dismantling structure, easy to open or fold the aircraft arm and antenna.
- The PTZ camera adopts quick dismantling structure. Installation screws are secured on the shock absorber plate, in order to prevent them from being lost.

HD Video

- The shock absorber board and shock absorber ball work together to guarantee PTZ camera stability.
- 30X visible light camera is optional, with professional HD video effect.
- IR thermal camera is optional, suitable for special environments such as fire scene or night environment, so as to guarantee clear video and high restoration.
- The remote control has snapshot button and record button, which are easy to operate and instantly start snapshot and record function.

Accurate Positioning

Empennage has built-in GSP system, so its positioning is accurate and real-time.

Wireless Transmission

- Aircraft has 4 antennas. Connect the remote control and image transmission device to send and receive radio wave signals.
- The remote control has 3 antennas. Connect the aircraft and GCS to send and receive radio wave signals.
- The ground station connects large-size image transmission antenna, to send and receive radio wave signals.

Low Electric Quantity Protection

When electric quantity is lower than estimated safe return value, trigger low electric quantity protection automatically, including alarm, return home and landing.

Flight Log

The ground station automatically records flight logs.

Intelligent Battery

- Display remaining electric quantity: Battery has built-in power indicator light.
- Balanced charging protection function: Automatically balance the battery cell voltage to protect battery.
- Overcharge protection function: Battery automatically stops charging when the voltage is full.
- Sleep protection function: Battery automatically goes to sleep status when there is no operation within 5 minutes.
- Charging temperature protection function: The battery charging temperature ranges from 0°C to 50°C. Once the temperature is too high, battery automatically stops charging; otherwise, it may result in battery damage.
- Communication: The remote control and the GCS can get current remaining capacity and voltage information.

Flight Control

The aircraft adopts quadrotor power system. It can switch among several flight modes and is easy to control the flight direction.

Electronic Fence (e-fence)

- Support e-fence function; prevent the aircraft from leaving the specified flight zone.
- Support customized e-fence settings.

17803 大華 2018-01-08

2. Structure

This product mainly consists of aircraft, airborne device, remote control and ground control station (GCS). This chapter introduces the structures of these four components. The detailed operations will be introduced in Chapter 3.



Note

All figures listed below and all dimensions listed here for reference only. The figure and the dimensions may be slightly different from the user data due to measurement position, measurement accuracy and position indication. Please refer to the actual product for detailed information.

2.1 Aircraft

Please refer to Chapter 3 to install the propeller and unfold the whole device.

2.1.1 Product Dimensions

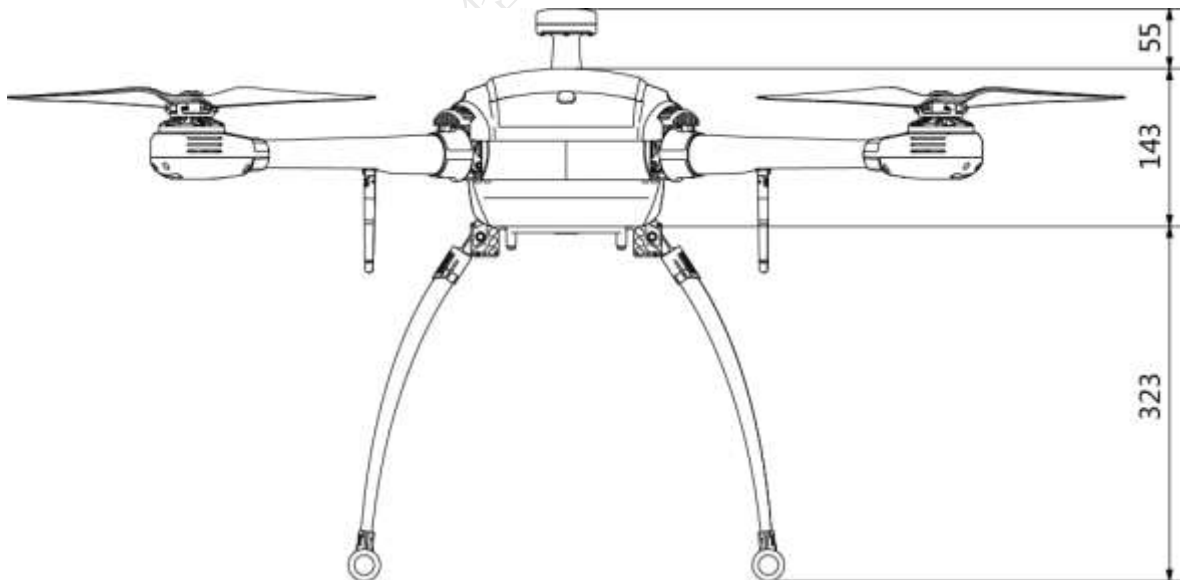

Figure 2-1

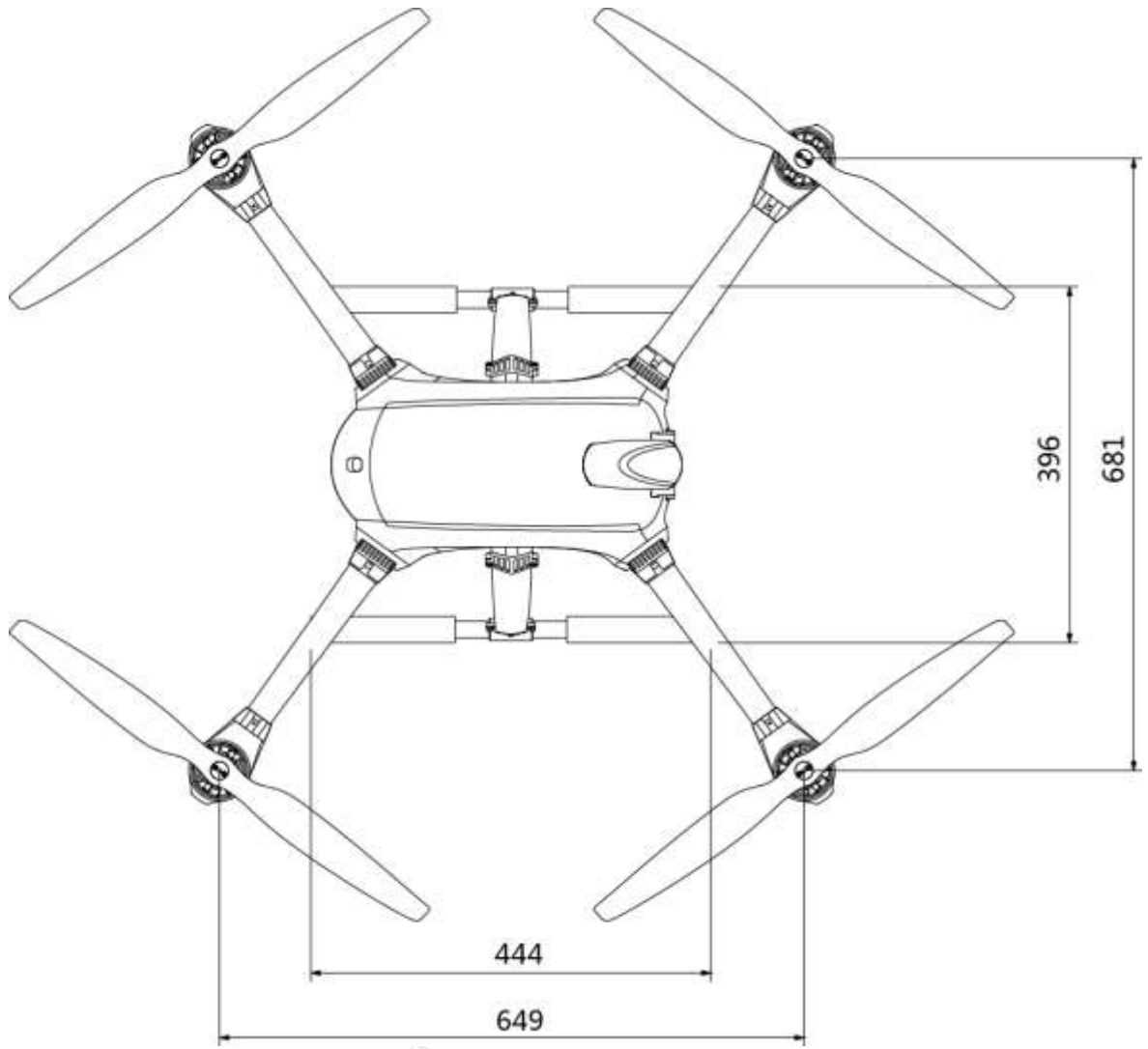

Figure 2-2

2.1.2 Structural Component

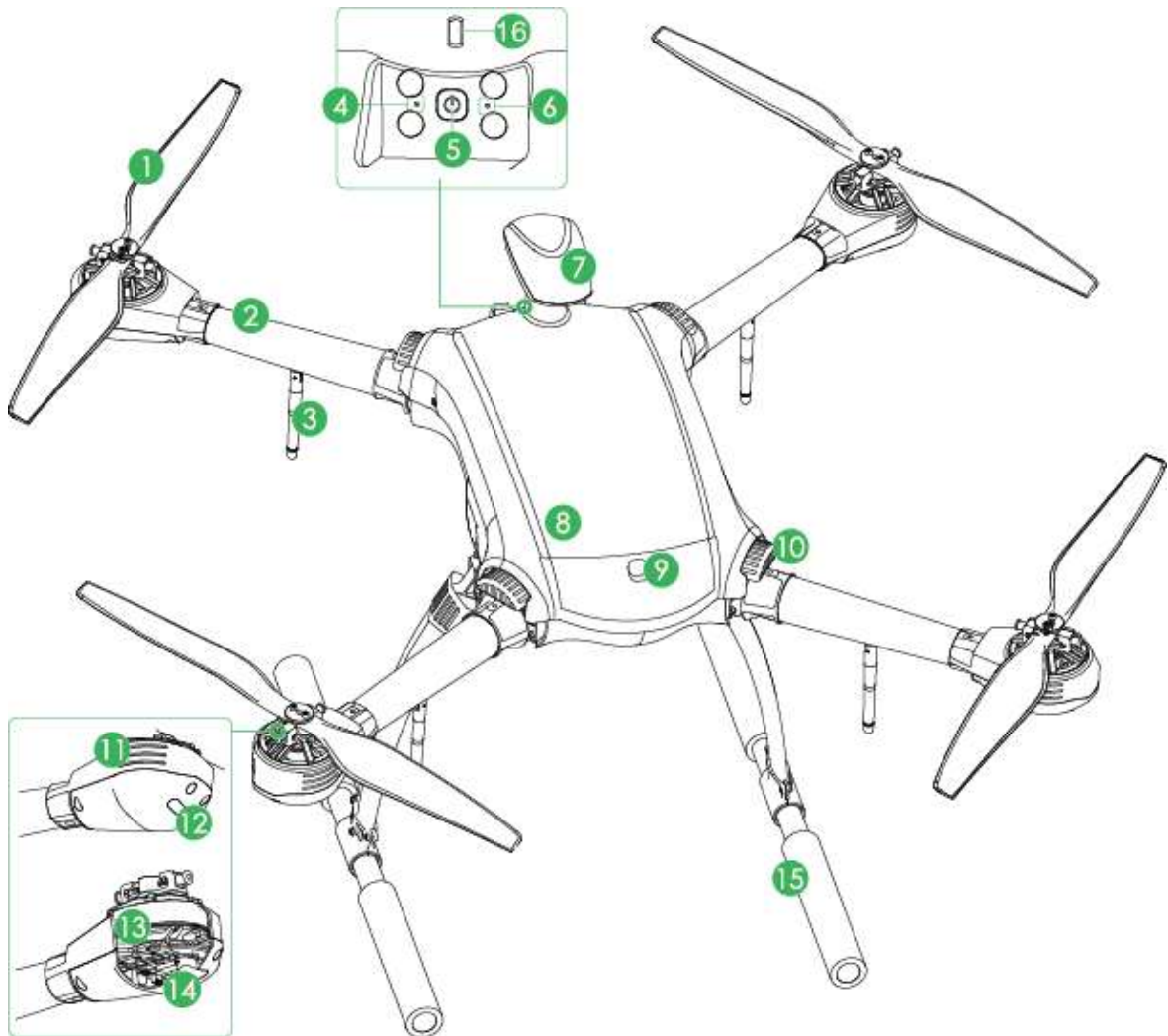

Figure 2-3

| No. | Name | Function |
|-----|-------------------------------|---|
| 1 | Propeller | High-speed revolution to turn the motor power to propulsive force. There are two pairs of propellers with different structures. Please adjust the installation positions according to the actual situation. |
| 2 | Arm | Fold or unfold. |
| 3 | Antenna | Fold or unfold. <ul style="list-style-type: none"> • 2 antennas are to receive the remote control signal. • 1 antenna is for wireless image transmission. • 1 antenna is reserved. |
| 4 | Reserved | Reserved. |
| 5 | Power switch (with indicator) | Built-in indicator light. The light is green after connecting power to the aircraft. |
| 6 | Pair button | When the remote control, GCS and the aircraft loses remote connection, click it to pair again. |
| 7 | Empennage | Built-in GPS and compass. |

| No. | Name | Function |
|-----|---------------------------|--|
| 8 | Battery cover | Open to install or dismantle the battery. |
| 9 | Cover buckle | Move the buckle to open the battery box cover. |
| 10 | Fold arm button | Fold the arm. |
| 11 | Heat emission hole | For heat dissipation purpose when the motor is working. |
| 12 | LED | Red/green lights. <ul style="list-style-type: none"> The adjacent two groups of the indicator lights are normally red, corresponding to the head of the aircraft. The adjacent two groups of the indicator lights are normally green, corresponding to the tail of the aircraft. |
| 13 | Motor | Keep the propeller rotating. |
| 14 | Speed control unit | Use sine wave driving, with excellent acceleration and deceleration performance. |
| 15 | Landing gear | Use remote control to open/close landing gear. |
| 16 | Aircraft status indicator | There are two modes: normally on and flashing. It displays five colors: red, yellow, blue, green and purple, to indicate system status, flight mode, upgrade status and etc. <p> Note</p> Refer to Appendix 2 for indicator light information and definition. |

Table 2-1

2.2 Airborne Device



- This part takes visible light PTZ camera and Thermal PTZ camera as an example, and introduces airborne device.
- For detailed info about various airborne device, please refer to their user's manuals and quick start guides.

The aircraft supports to carry visible light PTZ camera, Thermal PTZ camera and loudspeaker.

2.2.1 Visible Light PTZ Camera

2.2.1.1 Dimensions

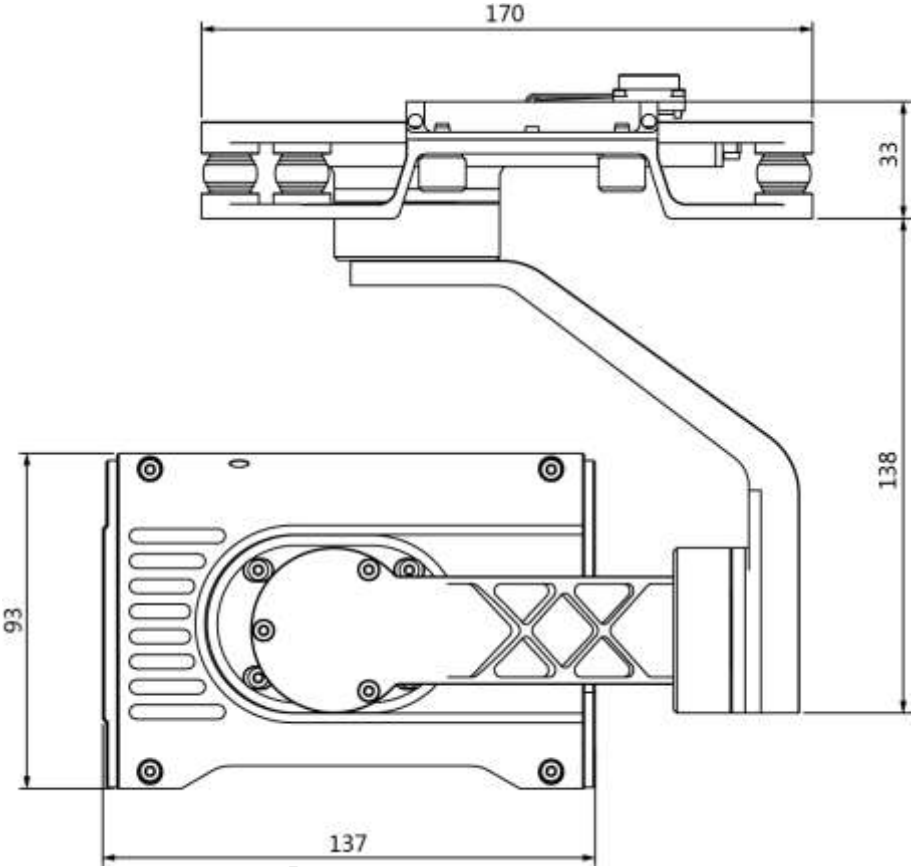

Figure 2-4

17803

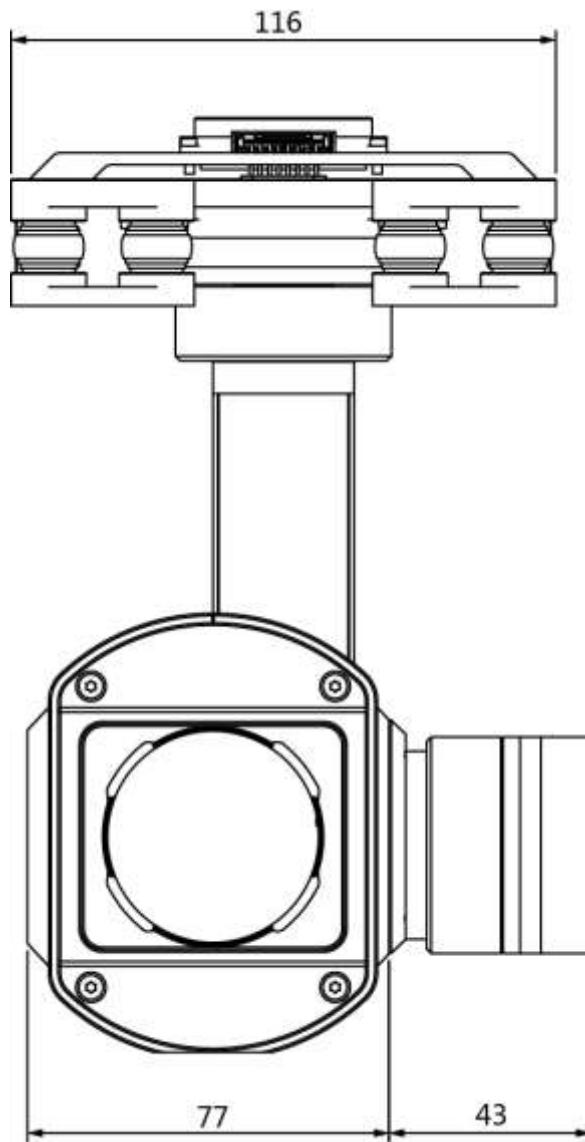

Figure 2-5

2.2.1.2 Structural Component

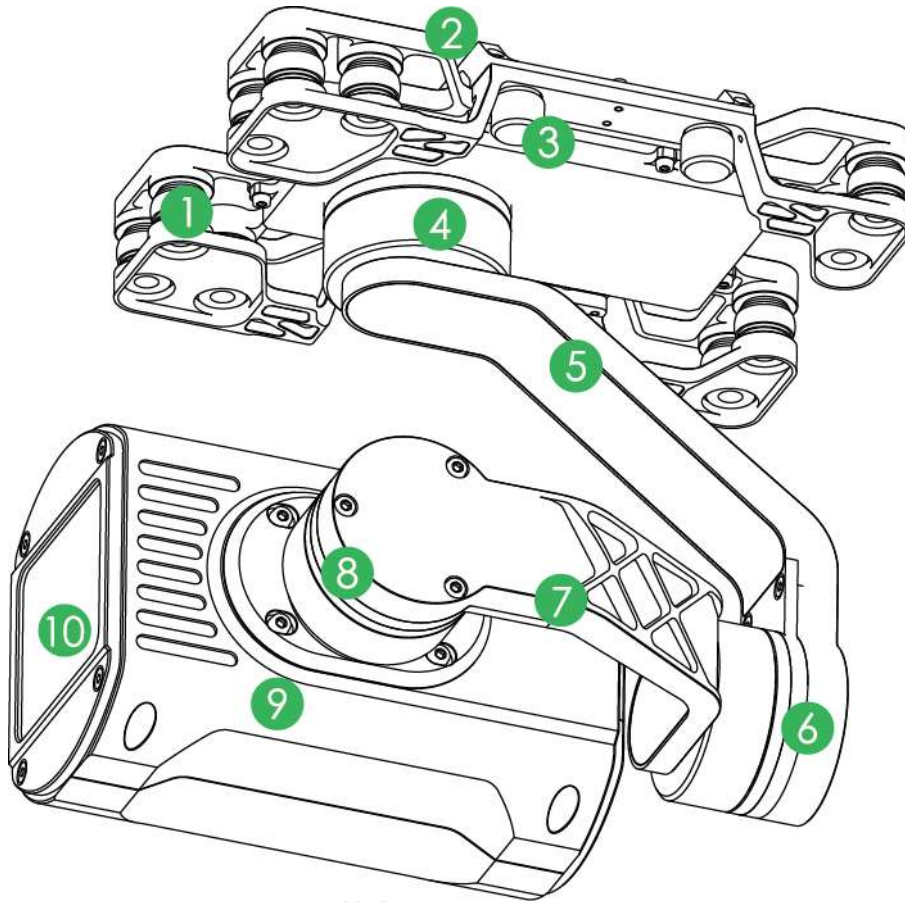

Figure 2-6

| No. | Name | Function |
|-----|----------------------|--|
| 1 | Shock absorber ball | Reduce PTZ camera vibration during the flight, to get clearer video. |
| 2 | Shock absorber board | |
| 3 | Installation screw | Secure the PTZ camera on the aircraft. |
| 4 | Yaw motor | Control rotation angle of yaw axis of the camera. |
| 5 | Yaw rotation arm | |
| 6 | Motor | Control rotation angle of roll axis of the camera. |
| 7 | Rotation arm | |
| 8 | Pitching motor | Control rotation angle of pitch axis of the camera. |
| 9 | Camera | Take pictures. |
| 10 | Lens | |

Table 2-2

2.2.2 Thermal PTZ Camera (Optional)

2.2.2.1 Dimensions

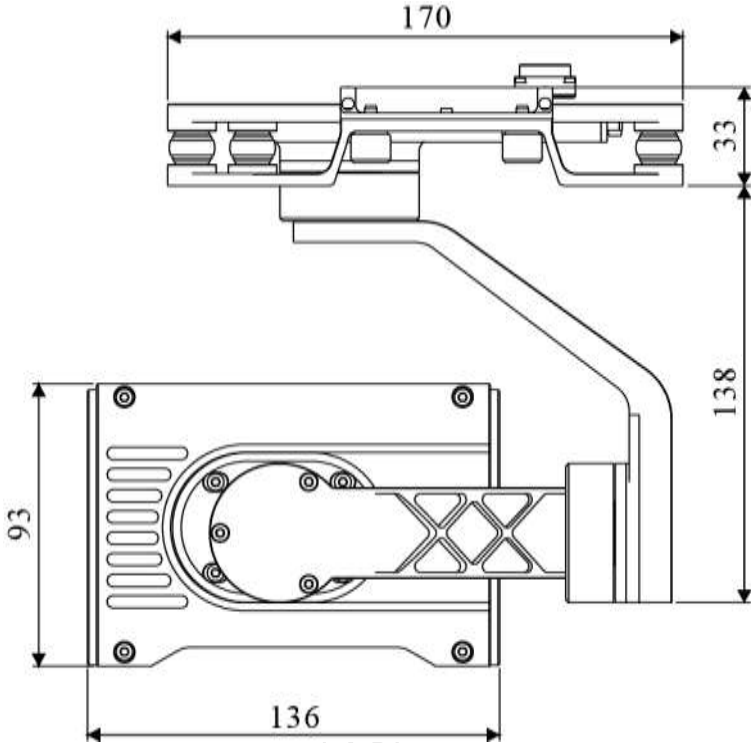

Figure 2-7

17803 大华

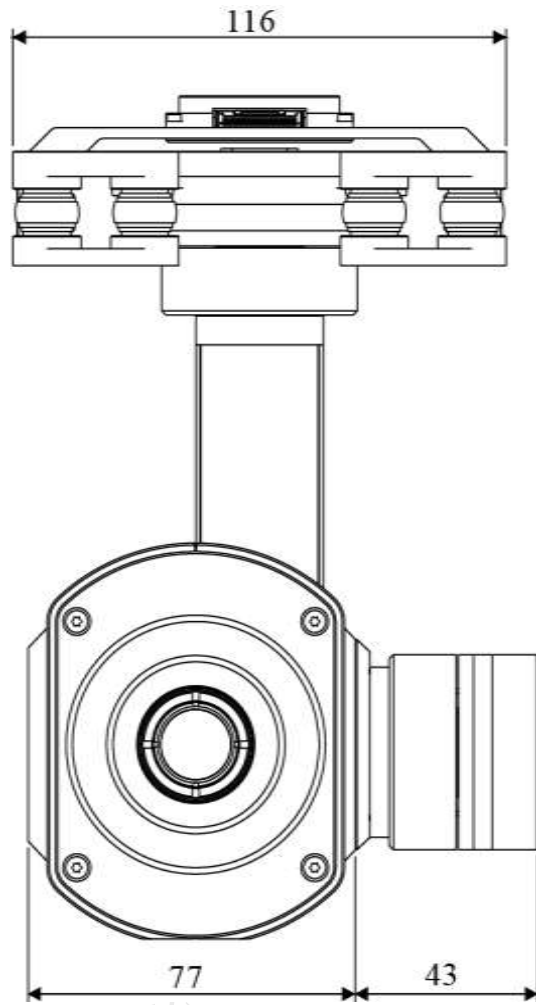

Figure 2-8

17803 大學

2.2.2.2 Structural Component

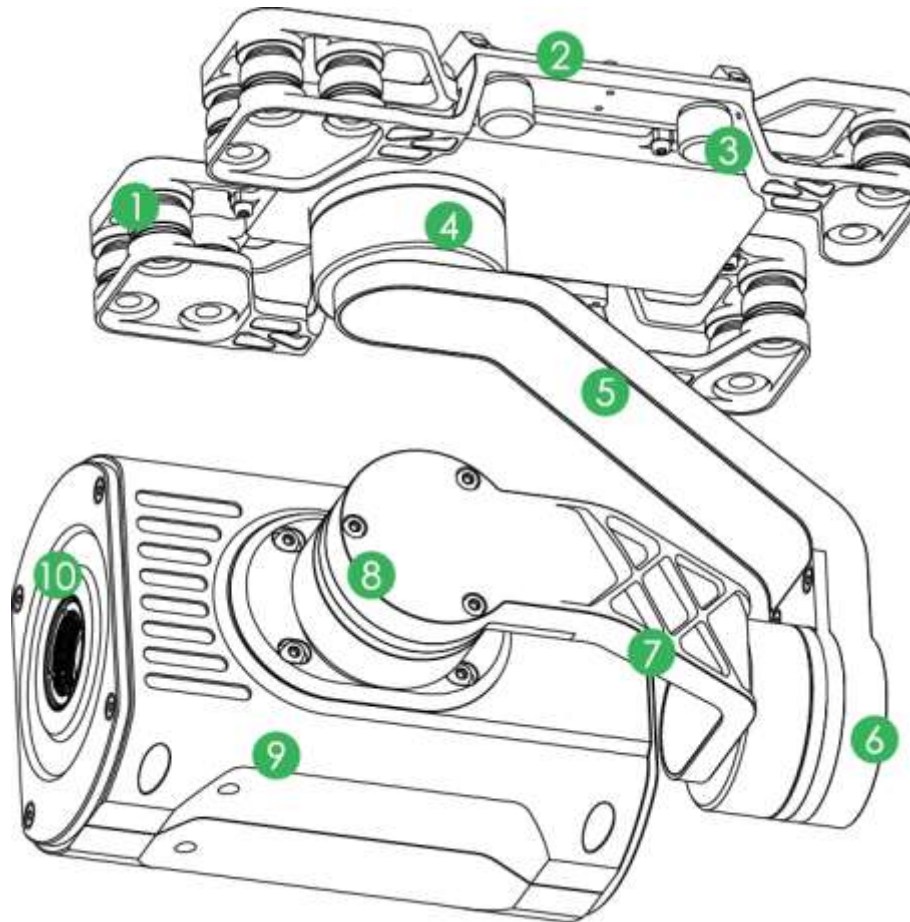

Figure 2-9

| No. | Name | Function |
|-----|----------------------|--|
| 1 | Shock absorber ball | Reduce PTZ camera vibration during the flight, to get clearer video. |
| 2 | Shock absorber board | |
| 3 | Installation screw | Secure the PTZ camera on the aircraft. |
| 4 | Course motor | Control horizontal direction of the camera. |
| 5 | Course rotation arm | |
| 6 | Roll motor | Control rotation angle of horizontal axis of the camera. |
| 7 | Roll rotation arm | |
| 8 | Pitching motor | Control rotation angle of pitch axis of the camera. |
| 9 | Camera | Take pictures. |
| 10 | Lens | |

Table 2-3

2.3 Remote Control

2.3.1 Dimensions

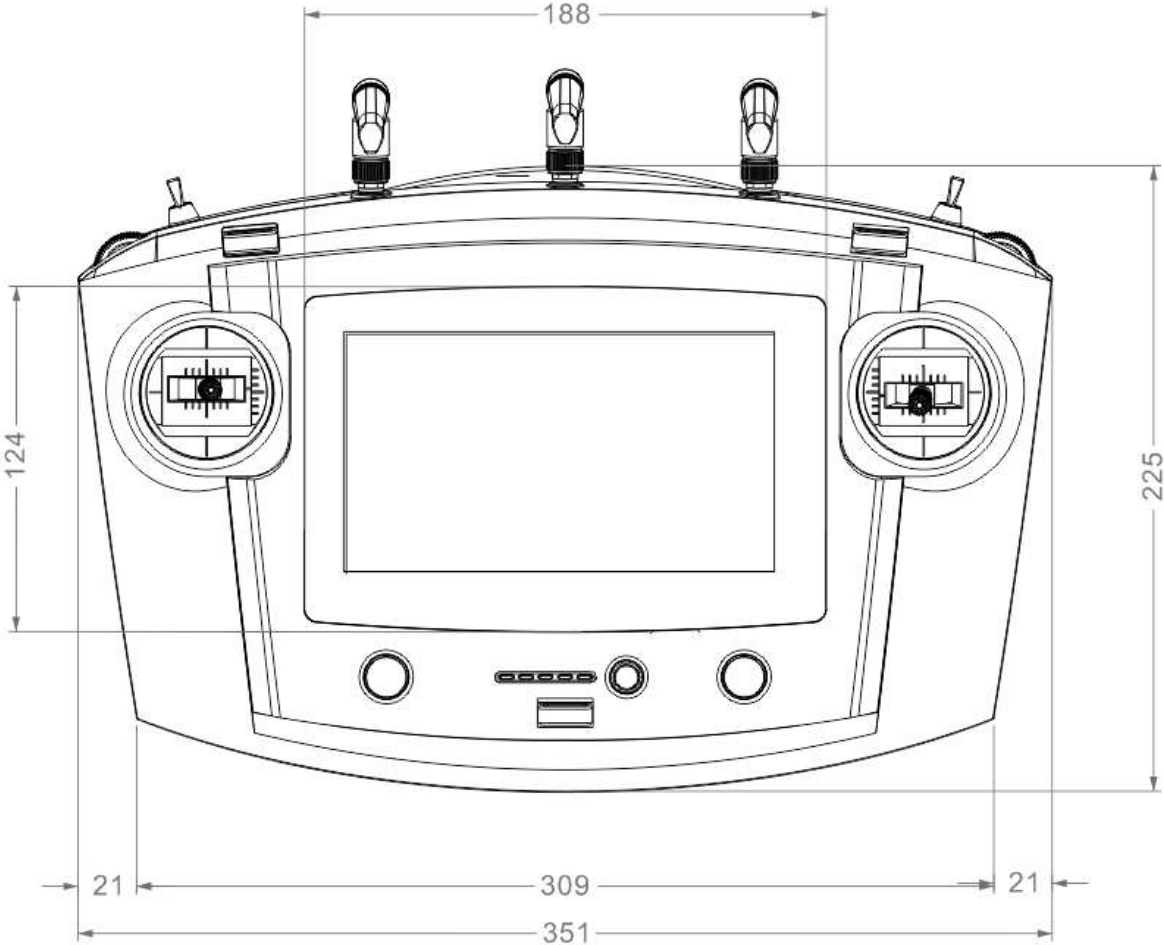

Figure 2-10

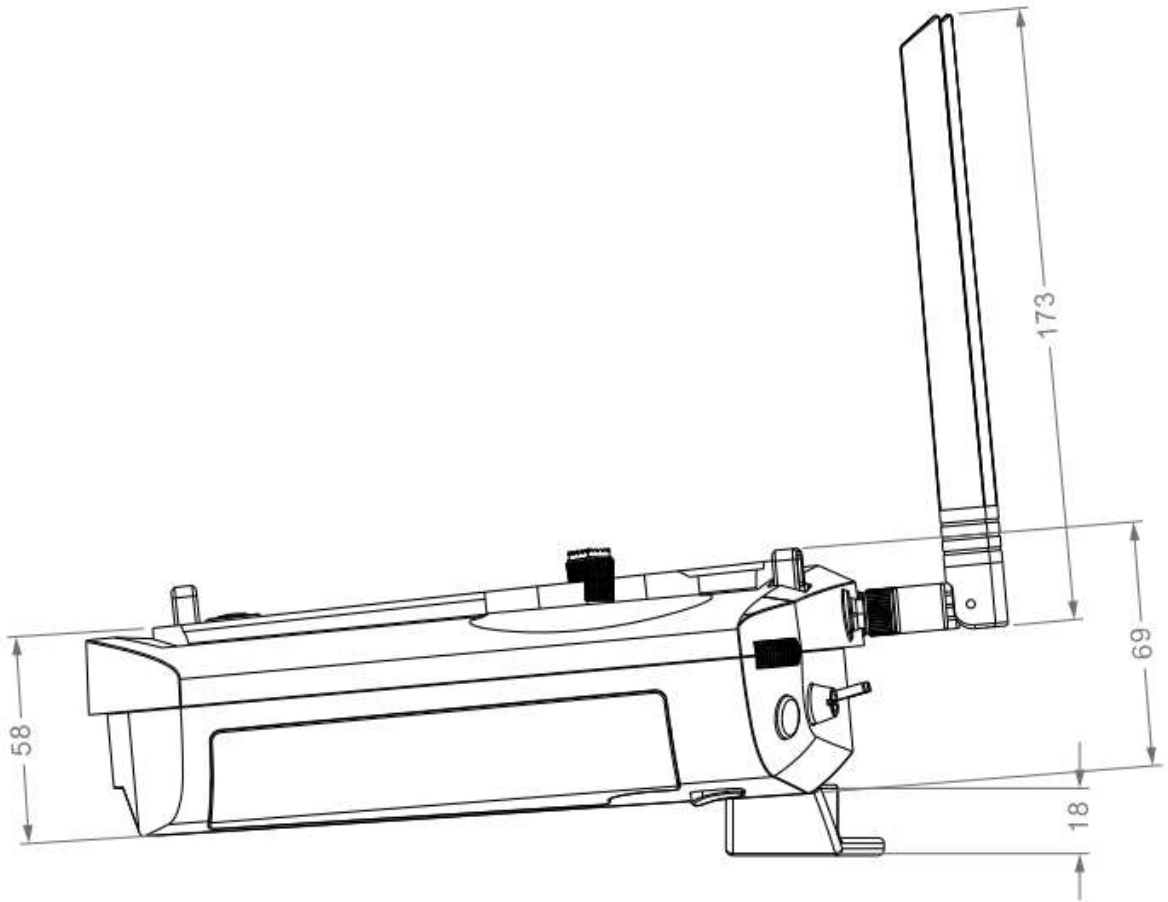

Figure 2-11

2.3.2 Structural Component

Front panel, side panel and rear panel of the remote control are shown in Figure 2-12, Figure 2-13 and Figure 2-14.

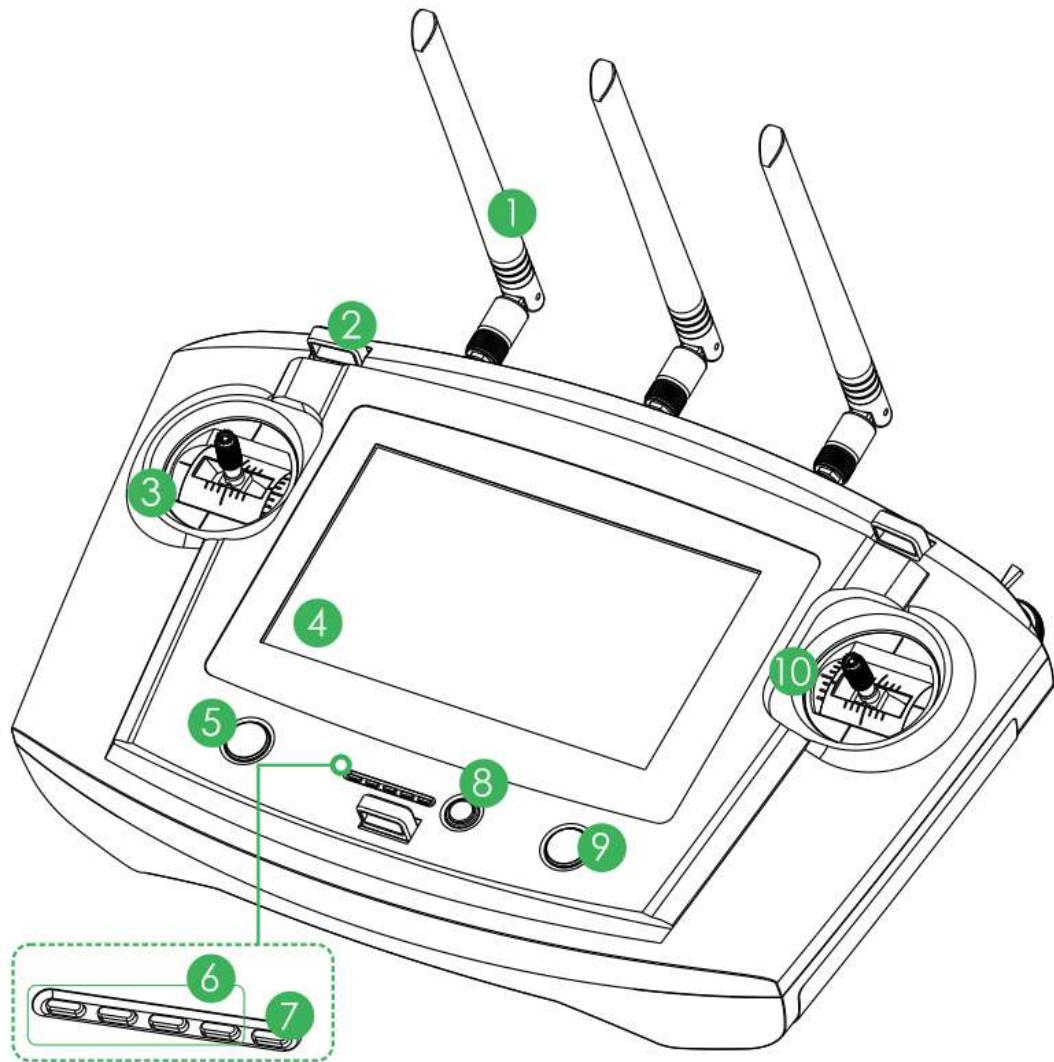

Figure 2-12

| No. | Name | Function |
|-----|-----------------------------------|--|
| 1 | Antenna | Establish the remote control relationship with the aircraft and aircraft state parameters. One silver antenna is installed in the middle, while two red antennas are installed at both sides. |
| 2 | Hanger | Fix the hanger belt. |
| 3 | Left control stick | Control the aircraft flight status. |
| 4 | Touch screen | Set parameters and preview the video. |
| 5 | Landing gear button | Open or close the landing gear. |
| 6 | Battery indicator | Each bar represents 25% battery power. |
| 7 | Charging indicator | Indicator light is on when connecting power to the charging port. <ul style="list-style-type: none"> Red light is normally on: charging. Green light is normally on: charging is finished. |
| 8 | One-click return button | Control aircraft to return home automatically. |
| 9 | One-click take off/landing button | Control aircraft to takeoff or landing automatically. The aircraft will loiter at 2m height when takeoff process is completed. |
| 10 | Right control stick | Control the aircraft flight status. |

Table 2-4

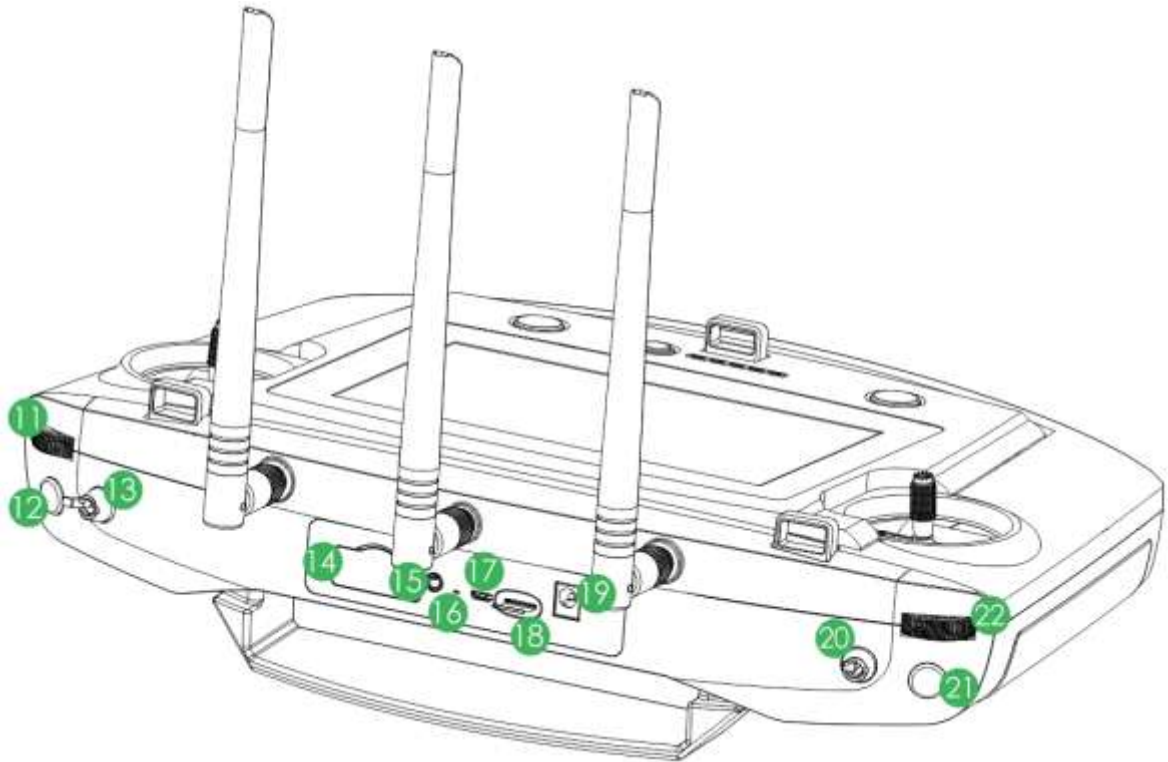

Figure 2-13

| No. | Name | Function |
|-----|--------------------------------|---|
| 11 | PTZ course pulley | Control horizontal shooting angle of camera lens. |
| 12 | Snapshot | Press this button shortly to snapshot present image. |
| 13 | Flight mode lever | 3-level lever to select flight mode. <ul style="list-style-type: none"> • Upper level: intelligent flight mode. The aircraft flights automatically according to the specified course. • Middle level: flight at the specified height. When the throttle lever is at the central mode, the aircraft flights at the same height automatically. • Lower level: flight at the specified position. When all levers are at the central mode, the aircraft hovers at the same position. |
| 14 | 4G SIM slot | Reserved. |
| 15 | Audio output port | Connect to earphone, sound box and etc. It is to play audio. |
| 16 | Reset button of remote control | Reserved. |
| 17 | Micro USB port | Insert data cable to connect PC. It is to transmit the data to the PC. |
| 18 | SD slot | <ul style="list-style-type: none"> • Insert SD card: The SD card with the chip is facing down. Insert the card to the slot horizontally. • Remove SD card: Press SD card inwards, so SD card pops up a little bit, and can be pulled out. |
| 19 | Power port | Input DC 12V power. |

| No. | Name | Function |
|-----|------------------|---|
| 20 | PTZ mode lever | 2-level lever. It is to select PTZ mode. <ul style="list-style-type: none"> Upper level: Course following mode. The PTZ camera angle changes with aircraft flight direction. Lower level: Course locking mode. No matter what the aircraft flight angles are, the PTZ camera always faces the same degree to shoot. |
| 21 | Record button | Press this button shortly to start recording, and press it again to stop recording. |
| 22 | PTZ pitch pulley | Control vertical shooting angle of camera lens. |

Table 2-5

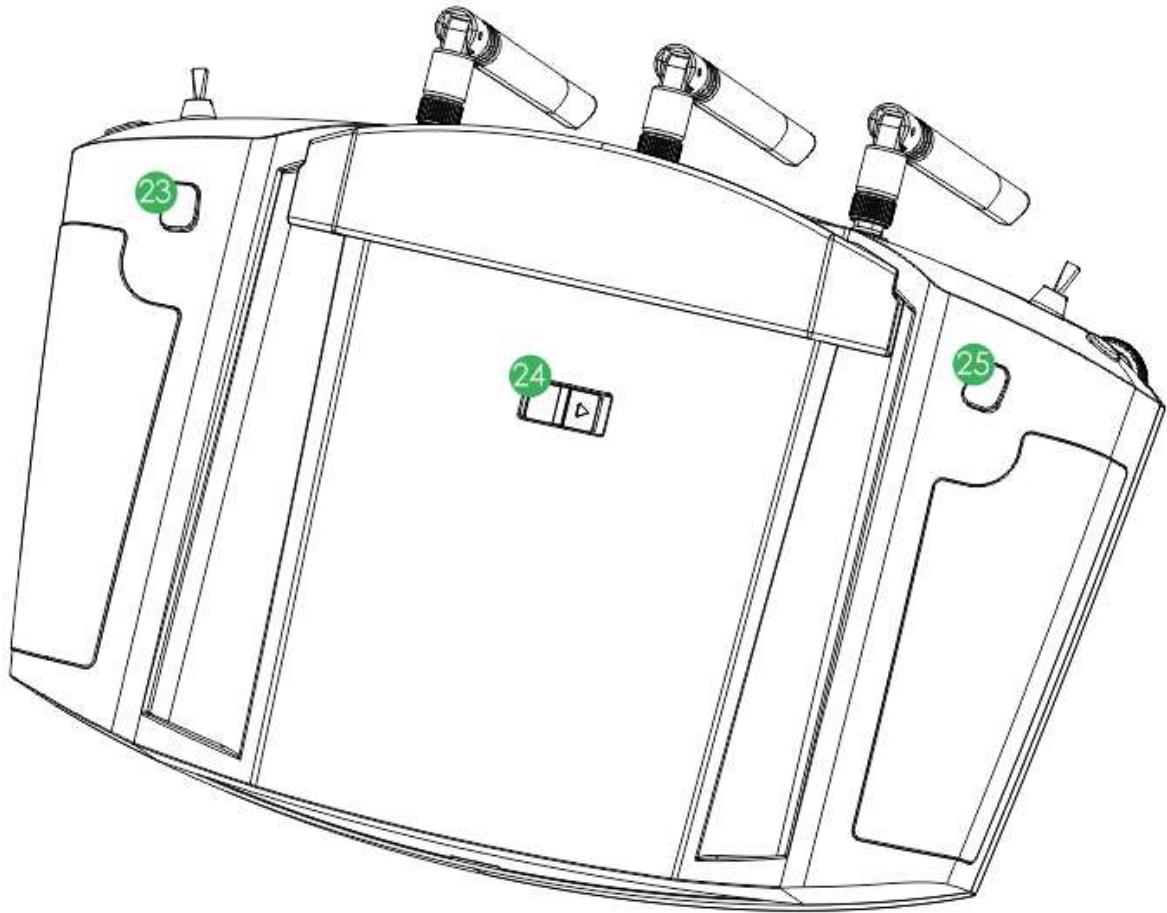

Figure 2-14

| No. | Name | Function |
|-----|-----------------|---|
| 23 | Zoom in button | <ul style="list-style-type: none"> Press it for a short time, to zoom in the camera. Press it for a long time, to zoom in until the camera reaches the maximum magnification. |
| 24 | Power switch | Turn on or turn off the remote control. |
| 25 | Zoom out button | <ul style="list-style-type: none"> Press it for a short time, to zoom out the camera. Press it for a long time, to zoom out until the camera reaches the minimum magnification. |

Table 2-6

2.3.3 Buttons



Refer to Chapter 4 for the joystick and flight mode lever button information.

2.3.3.1 Pulley

- PTZ course pulley: control horizontal shooting angle of camera lens, as shown in Figure 2-15.
 - ◇ Pulley turns to the left: PTZ turns to the left.
 - ◇ Pulley turns to the right: PTZ turns to the right.



Figure 2-15

- PTZ pitching pulley: control vertical shooting angle of camera lens, as shown in Figure 2-16.
 - ◇ Pulley turns to the left: camera lens turns downwards.
 - ◇ Pulley turns to the right: camera lens turns upwards.



Figure 2-16

2.3.3.2 PTZ Mode Lever

Shooting direction of PTZ camera is controlled with PTZ mode lever, as shown in Figure 2-17.

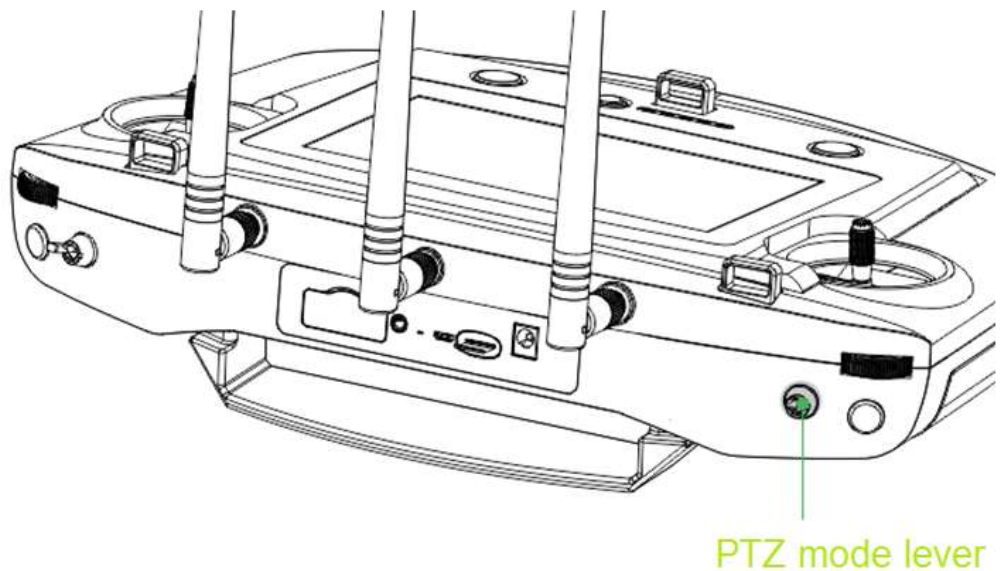

Figure 2-17

2-level lever:

- Upper level: Course following mode. Shooting angle of PTZ camera changes with aircraft flight direction.
- Lower level: Course locking mode. No matter what the aircraft flight angles are, the PTZ camera always faces the same degree to shoot.

2.3.3.3 Shooting

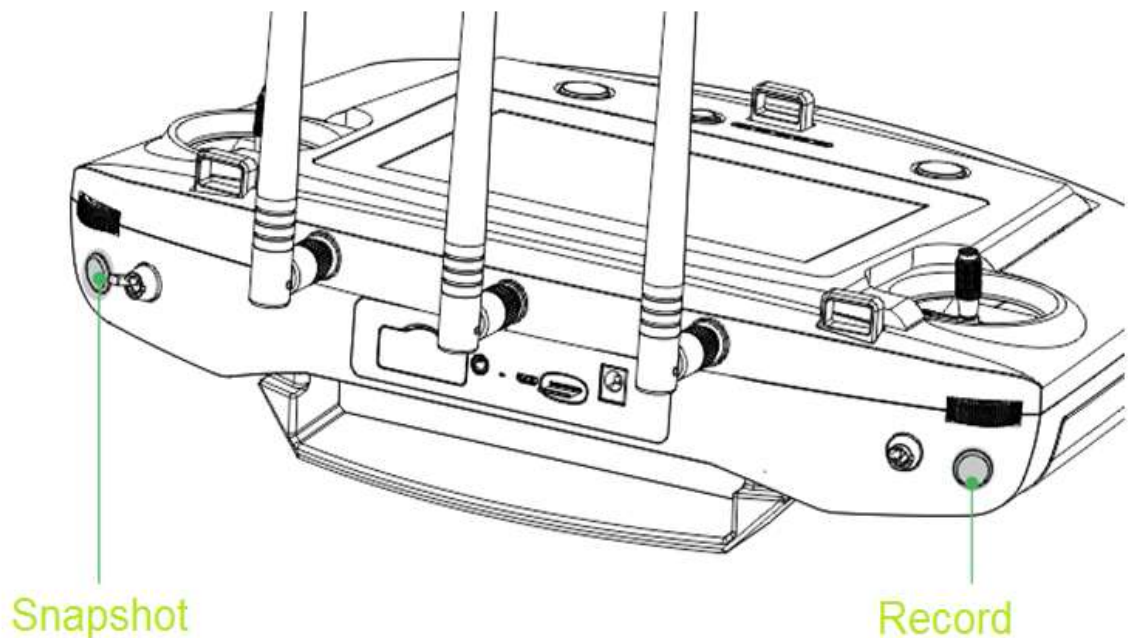

Figure 2-18

- Snapshot: Press snapshot button for a short time to snapshot the present image.
- Record: Press record button for a short time to begin recording video. Press it for a short time again to stop recording.

2.3.4 Operation Interface

After turning on with the remote control, enter main interface. It consists of the following function modules, as shown in Figure 2-19.

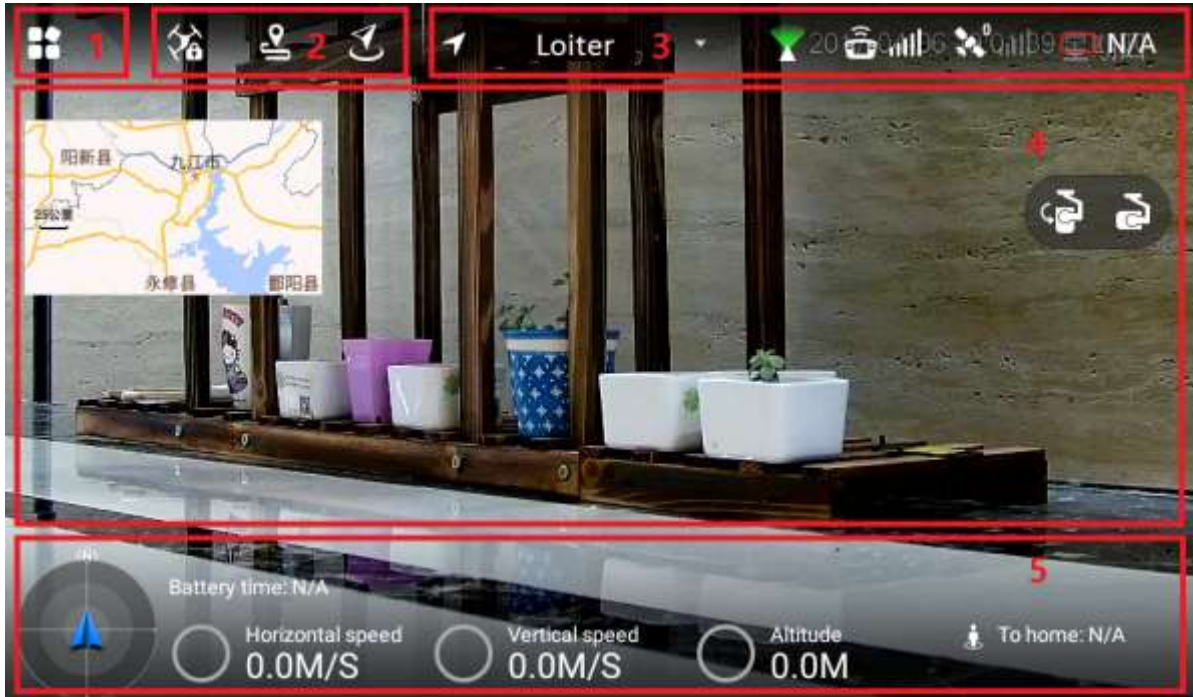

Figure 2-19



Tips

Slide up at any position on the preview interface to hide the setting menu, function bar and status bar. Slide down at any position on the main interface to view them again.

| No. | Name | Function |
|-----|-------------------|---|
| 1 | Settings menu | Click to enter the setting menu. Please refer to “2.3.4.4 Settings” for details. |
| 2 | General functions | Set HOME position and lock mode. Please refer to “2.3.4.3 General Function Buttons” for details. |
| 3 | Status bar1 | Display flight mode, PTZ mode, remote control signal intensity, GPS satellite amount, signal intensity and remaining power of the aircraft. Please refer to “2.3.4.1.1 Status Display Bar 1” for details. |
| 4 | Preview window | Quickly switch video preview and map preview to display prompt information. Please refer to “2.3.4.2 Preview” for details. |
| 5 | Status bar 2 | Display remaining flight time, aircraft speed, height and distance from the HOME. Please refer to “2.3.4.1.2 Status Display Bar 2” for details. |

Table 2-7

2.3.4.1 System Status

2.3.4.1.1 Status Display Bar 1

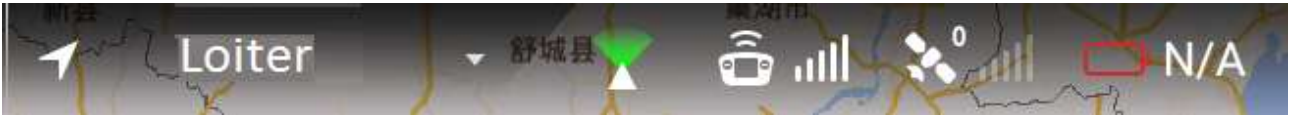

Figure 2-20

| Icon | Name | Function |
|------|------------------------------------|---|
| | Flight mode | Display current flight mode of the aircraft. |
| | PTZ mode | <p>There are two statuses.</p> <ul style="list-style-type: none"> : When the PTZ lever is at the lower level, the PTZ camera has locked the course direction. No matter how aircraft angle changes, the PTZ camera is still facing the same direction to shoot. : When the PTZ lever is at the upper level, the PTZ camera direction is flight following mode. The shooting angle changes with the aircraft course angle. |
| | Remote control intensity | There are max. 5 bars. The more the highlighted bar amount is, the stronger the remote control effect is. |
| | GPS satellite and signal intensity | <ul style="list-style-type: none"> The number on the left side is the GPS satellite amount. The GPS signal intensity is shown on the right. There are max. 5 bars. The more the highlighted bar amount is, the stronger the remote control effect is. |
| | Remaining power | When the remaining power is low, please complete the flight as soon as possible and replace the aircraft battery. |

Table 2-8

2.3.4.1.2 Status Display Bar 2

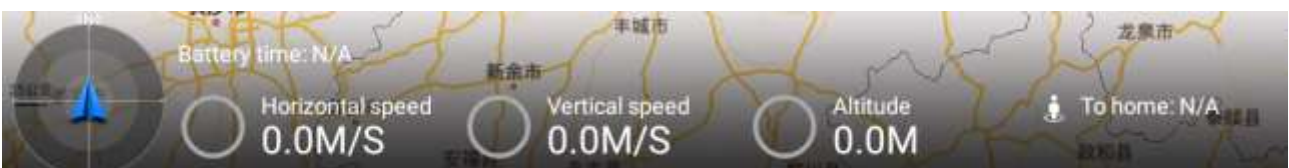

Figure 2-21









| Icon | Name | Function |
|---|------------------------|--|
|  | Aircraft direction | White triangle: it indicates the aircraft direction on the geographic position. |
|  | Remaining flight time | When the flight time is running out, please complete the flight as soon as possible and charge the aircraft.  Note This estimated value is for reference only. Actual flight time may be affected by environment and etc. It may be different from the actual flight time. |
|  | Horizontal speed | Horizontal forward and backward speed of the aircraft. |
|  | Vertical speed | Vertical ascending and descending speed of the aircraft. Positive value represents ascending speed, while negative value represents descending speed. |
|  | Altitude | Relative altitude from the takeoff position. |
|  | Distance from the HOME | Distance between the aircraft and Home.  Note Default Home is GPS coordinate of the aircraft when unlocking loiter mode (actual positioning accuracy is related with environment or weather). |

Table 2-9

2.3.4.2 Preview

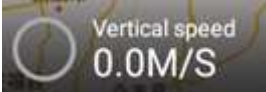
Click the window at the top left corner, to switch between video preview mode and map preview mode.



Prompt information is displayed on the right side of the icon. Click the icon to view message list.

2.3.4.2.1 Video Preview Mode

Default preview mode is shown in Figure 2-22.

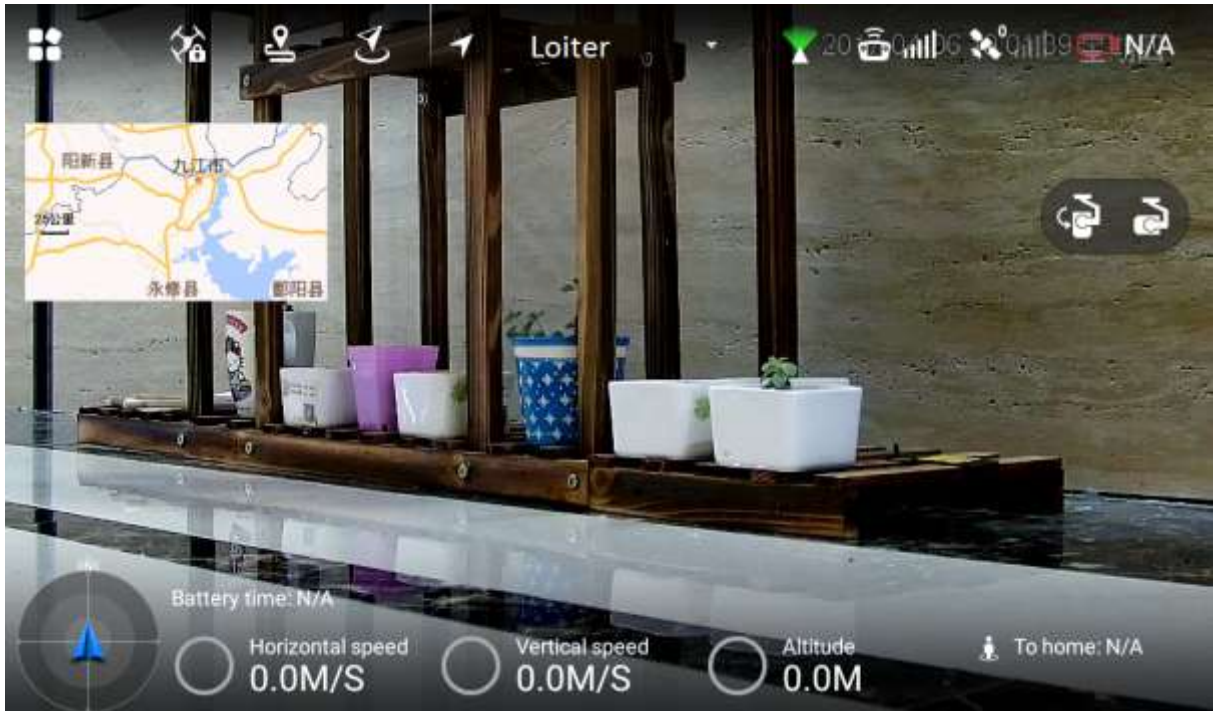

Figure 2-22

- In this mode, the map is displayed in a small window at the top left corner of the preview interface.
- In this mode, the large window displays the real-time image transmitted by the camera to the remote control.

2.3.4.2.2 Map Preview Mode

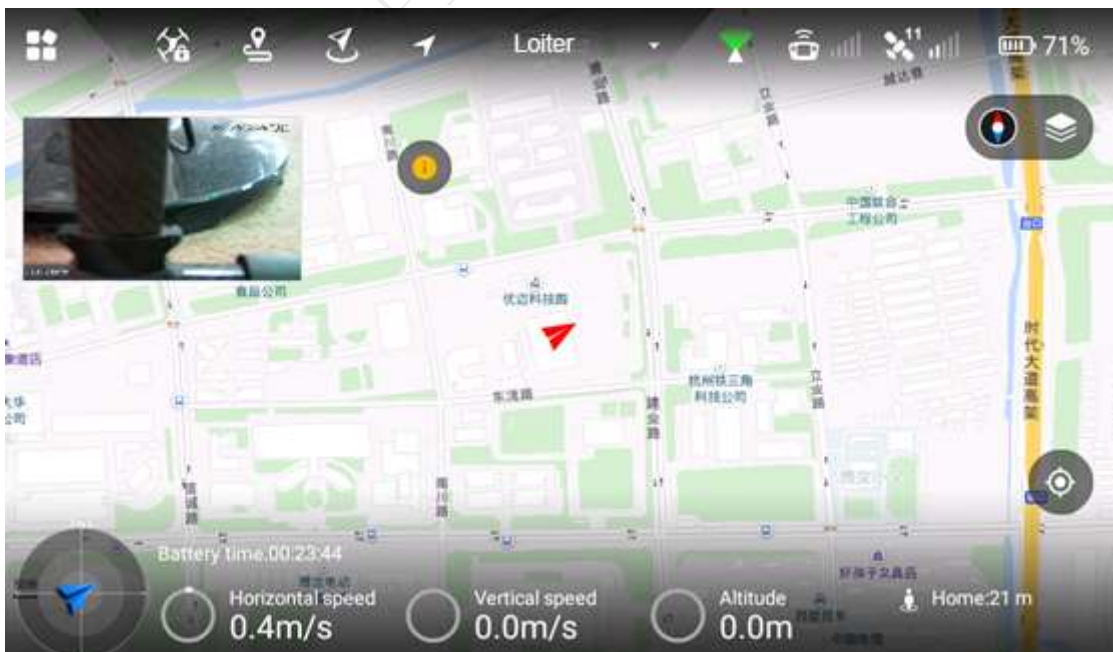





Figure 2-23

- In this mode, the image transmitted by the camera to the remote control is displayed in a small window at the top left corner of the preview interface.
- In this mode, the large window displays aircraft position on the map.

Buttons in map preview mode are described as follows:

- 
 Map direction locking button: Press this button to lock the map direction, so the map cannot be rotated manually. Click it again to unlock, so the map can be rotated manually.
- 
 Map display mode switching button: Switch to display the map in the form of satellite imagery or 2D image.
- 
 Central button: Switch to current position of the aircraft quickly and center at current position of the aircraft.

2.3.4.3 General Function Buttons

Locking Mode

Click it to select locking mode of the aircraft on the popped up dialog box.



Figure 2-24



2.3.4.4 Settings

Click  to enter setting interface, as shown in Table 2-10.

| Level 1 Menu | Level 2 Menu | Level 3 Menu | Function |
|----------------|----------------------------|--------------|---|
| Remote control | Control stick mode | - | There are two modes. Please refer to “4.2.4 Manual Flight Control” for detailed operation methods. |
| | Remote control calibration | - | Calibrate the remote control. Please refer to “3.10.2 Remote Control Calibration” for detailed operation methods. |
| | Remote control pair | - | Pair remote control, ground station and aircraft. Please refer to “Appendix 3 System Pairing” for detailed operation methods. |
| Flight | Enable e-fence | - | Enable or disable e-fence. Please refer to “4.4.3.2 Enable E-fence” for detailed operation methods. |
| | E-fence | - | Set e-fence parameters and trigger actions. Please refer to “4.4.3.1 E-fence Area Settings” for detailed operation methods. |
| Preview | Preview image size | - | Set preview image size. Please refer to “4.5.1.1 Image Transmission Size” for |

| Level Menu | 1 | Level 2 Menu | Level 3 Menu | Function |
|------------|---|-----------------------------|---------------------------|--|
| | | | | detailed operation methods. |
| Camera | | Photo | - | Set snapshot image size. Please refer to “4.5.1.2 Photo Settings” for detailed operation methods. |
| | | Video | - | Set the resolution ratio, frame rate and max. bandwidth of PTZ camera. Please refer to “4.5.1.3 Record Settings” for detailed operation methods. |
| | | Advanced | Image | Set brightness, contrast, saturation, sharpness and gamma value. Please refer to “4.5.1.4 Image Settings” for detailed operation methods. |
| General | | Aircraft firmware upgrade | - | Check firmware status and upgrade. Please refer to “6.1 Aircraft Firmware Upgrade” for detailed operation methods. |
| | | APP upgrade | - | Check APP status and upgrade. Please refer to “6.2.1 APP Upgrade” for detailed operation methods. |
| | | Other | Geomagnetism calibration | Calibrate geomagnetism. Please refer to “3.10.5 Geomagnetic Abnormality” for detailed operation methods. |
| | | | Accelerometer calibration | Calibrate accelerometer. Please refer to “3.10.3 Accelerometer Calibration” for detailed operation methods. |
| | | | Offline map | Add or delete offline map. Please refer to “6.2.2 Download and Upgrade Offline Map of Remote Control” for detailed operation methods. |
| | | | Brightness | Adjust laptop brightness. Please refer to “4.5.1.5 Brightness Adjustment” for detailed operation methods. |
| | | Currently connected to SSID | - | Display currently connected aircraft. |
| | | Date | - | Set the display time of remote control. |
| | | Language | - | Set the language of APP interface. |

Table 2-10

On settings interface, click  to return to the previous menu and click  to exit settings.

2.4 Ground Control Station (GCS)

2.4.1 Dimensions

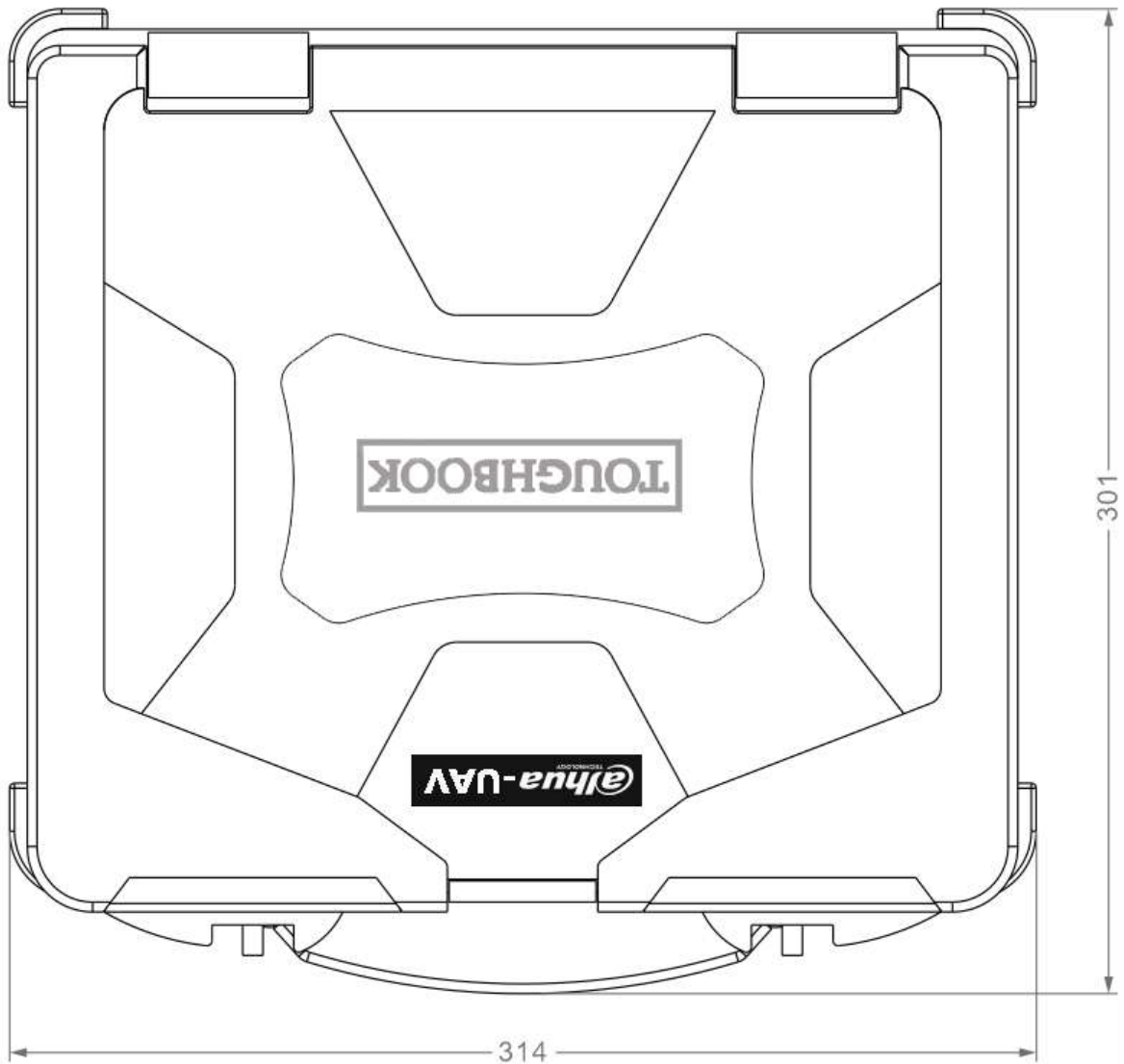

Figure 2-25

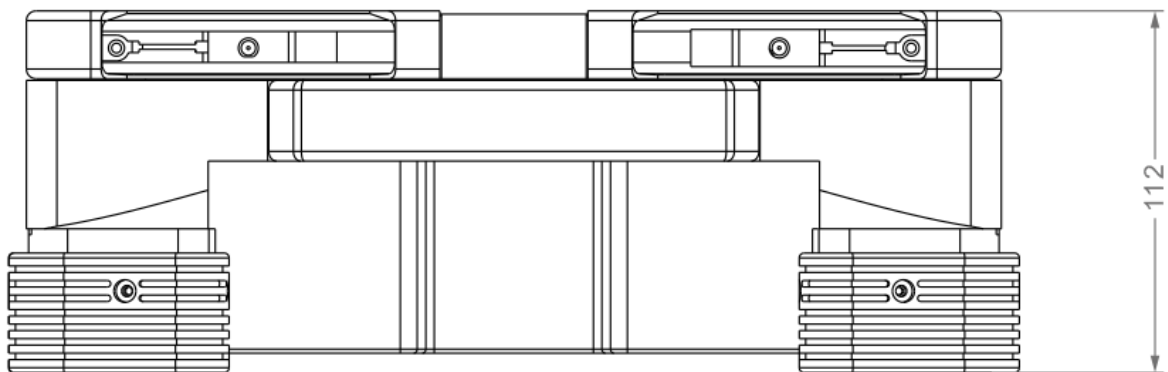

Figure 2-26

2.4.2 Structural Component



Figure 2-27

| No. | Name | Function |
|-----|----------------------------|---|
| 1 | Touch pen | For operations on the ground station. |
| 2 | System boot up button | Boot up ground station OS. <ul style="list-style-type: none"> • When device is off, push to the right to boot up. • When device is on, push to the right and keep for at least 3 seconds to shut down forcibly. |
| 3 | Image transmission button | Enable/disable ground control station image transmission system. <ul style="list-style-type: none"> • When device is off, press once for a short time; the built-in red indicator light is on, the image transmission system is on. • When device on, press once for a short time, the built-in red indicator light is off, the image transmission system is off. |
| 4 | Power port | Charging port of ground station. |
| 5 | Image transmission antenna | For Image transmission between the ground control station and the aircraft. |
| 6 | Screen buckle | Press to open the ground control station. |
| 7 | Relay antenna | For data transmission between the ground control station and the remote control. |
| 8 | Touch screen | For operations on the ground station. |
| 9 | Touchpad | |

Table 2-11

2.4.3 Operation GUI



Please modify initial password, in order to guarantee information security.

Click  to open the Ground Control Station (GCS), enter the main interface.

GCS has the following function modules, as shown in Figure 2-28.

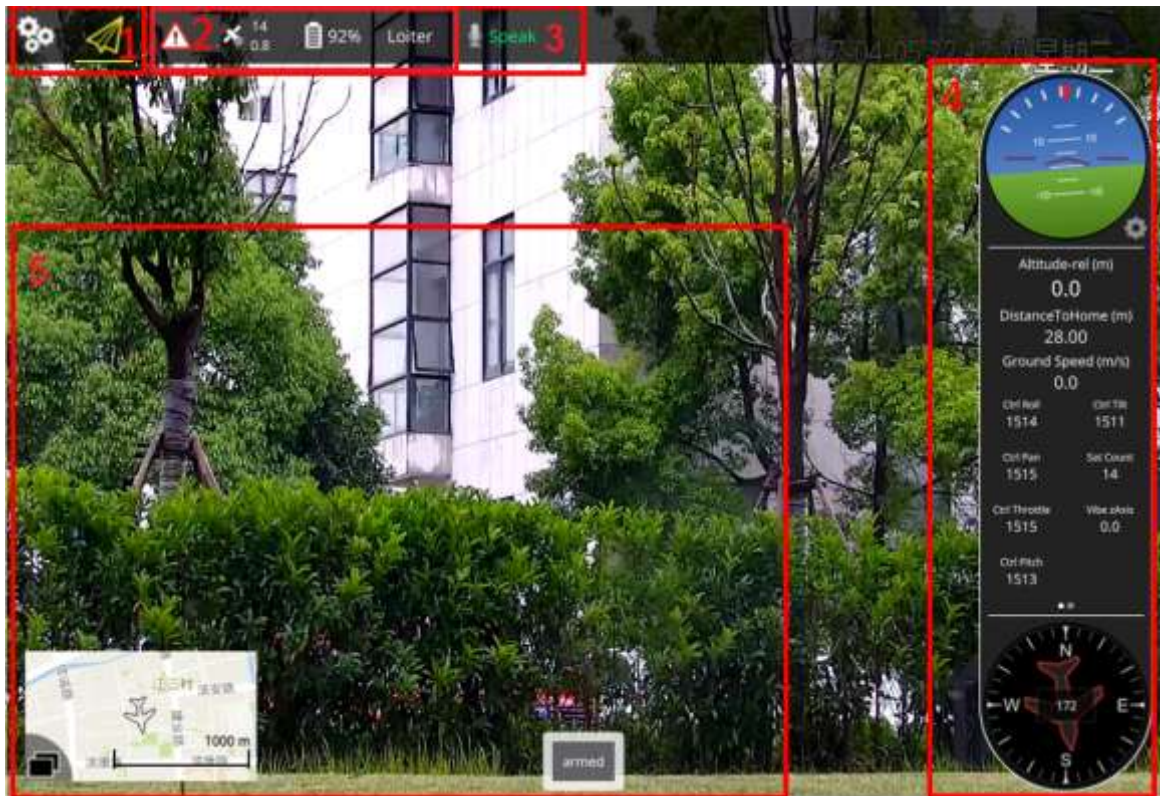

Figure 2-28

| No. | Name | Function |
|-----|----------------------|--|
| 1 | Settings menu | Set aircraft settings and preview interface. Please refer to “2.4.3.1 Settings” for details. |
| 2 | Status display bar 1 | Display preview alarm information, GPS status, battery status and flight mode. Please refer to “2.4.3.2.1 Status Display Bar 1” for details. |
| 3 | Speaker | Set speaker function. Please refer to “2.4.3.1.3 Speaker Settings” for details. |
| 4 | Status display bar 2 | Display aircraft flight attitude, flight parameters and flight directions and etc. Please refer to “2.4.3.2.2 Status Display Bar 2” for details. |
| 5 | Preview window | Switch video preview and map preview quickly. Please refer to “2.4.3.1.2 Preview Settings” for details. |

Table 2-12

2.4.3.1 Settings

2.4.3.1.1 Aircraft Settings



Click  to go to the aircraft setting interface, as shown in Table 2-13.

| Level Menu | Level 2 Menu | Function |
|-------------|----------------|--|
| Preview | Remote control | View the mapping between the control stick and the channel. |
| | Flight mode | View aircraft flight mode. |
| | Battery | View aircraft battery status. |
| | Security | View aircraft security parameters. |
| Offline map | Add new task | Add a new offline map. Please refer to “6.3.3.1 Download Offline Map” for detailed operation methods. |
| | Default Set | Default offline map of the system. When the network connection is OK, system automatically downloads current position map. |
| Settings | UI Settings | Set interface font size and style. |
| Pair | - | <p>Pair aircraft, ground control station and remote control. Please refer to “Appendix 3 System Pairing” for detailed operation methods.</p> <p> Note All corresponding components have completed the pairing process. Usually, it is unnecessary to pair again.</p> |
| Diagnosis | - | Diagnose and repair the ground control station system. Please refer to “3.9.1 Aircraft Diagnosis” for detailed operation methods. |
| Options | - | Set offline map buffer. Please refer to “6.3.3.3 Set Disk Cache of Offline Map” for detailed operation methods. |
| Register | - | Register relevant information and connect ITS (Intelligent Transportation System) general control platform. Please refer to “4.5.2.2 Auto Registration” for detailed operation methods. |

Table 2-13

2.4.3.1.2 Preview Settings



Click  to enter preview setting interface.

Click the map preview window at the bottom left of the preview interface, to switch between the video preview and map preview mode.

Video Preview Mode

Default preview mode of the system is video preview mode, as shown in Figure 2-29.

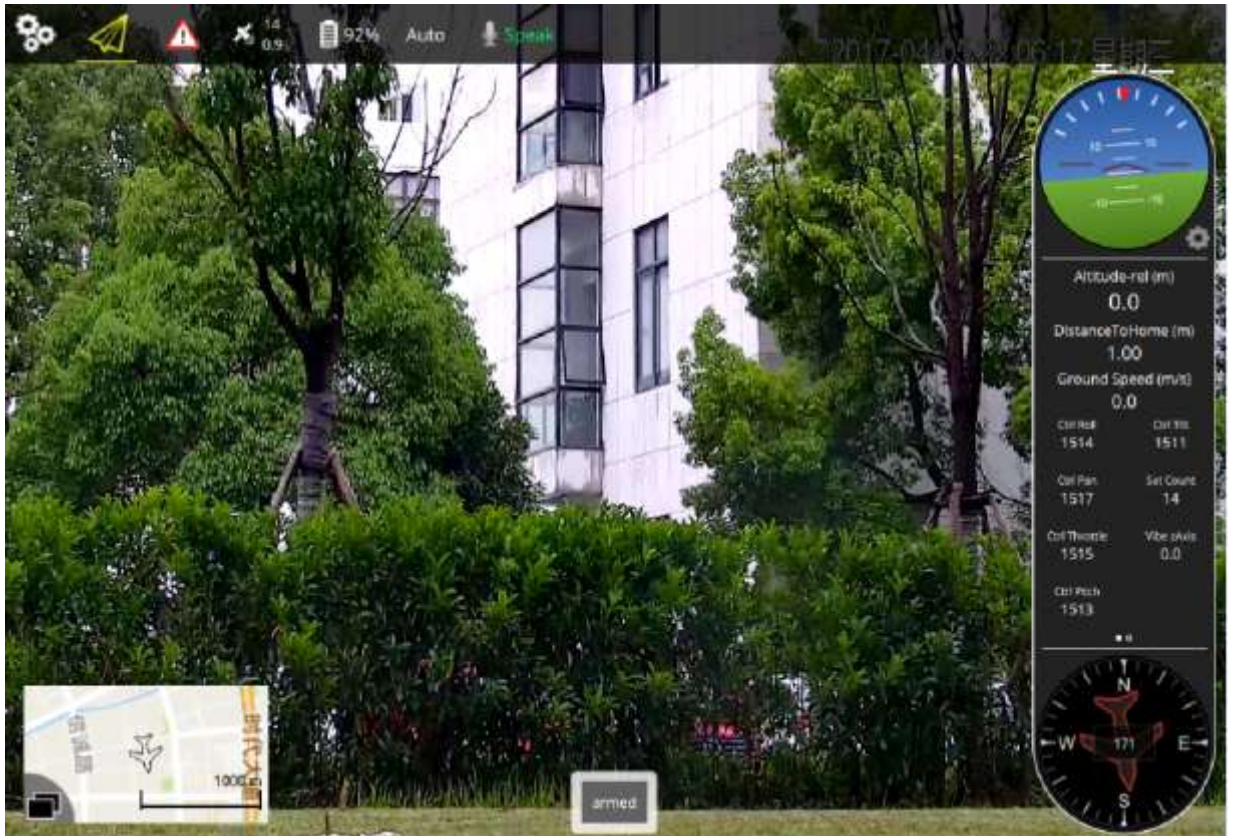



Figure 2-29

- In this mode, the map is displayed in a small window at the bottom left of the preview interface.
- In this mode, the large window displays video that is transmitted by the camera to the ground control station.

Note

-  Aircraft locking button: The aircraft cannot take off if it is not unlocked.
-  Aircraft unlocking button: The aircraft has unlocked and is ready to take off.

Map Preview Mode

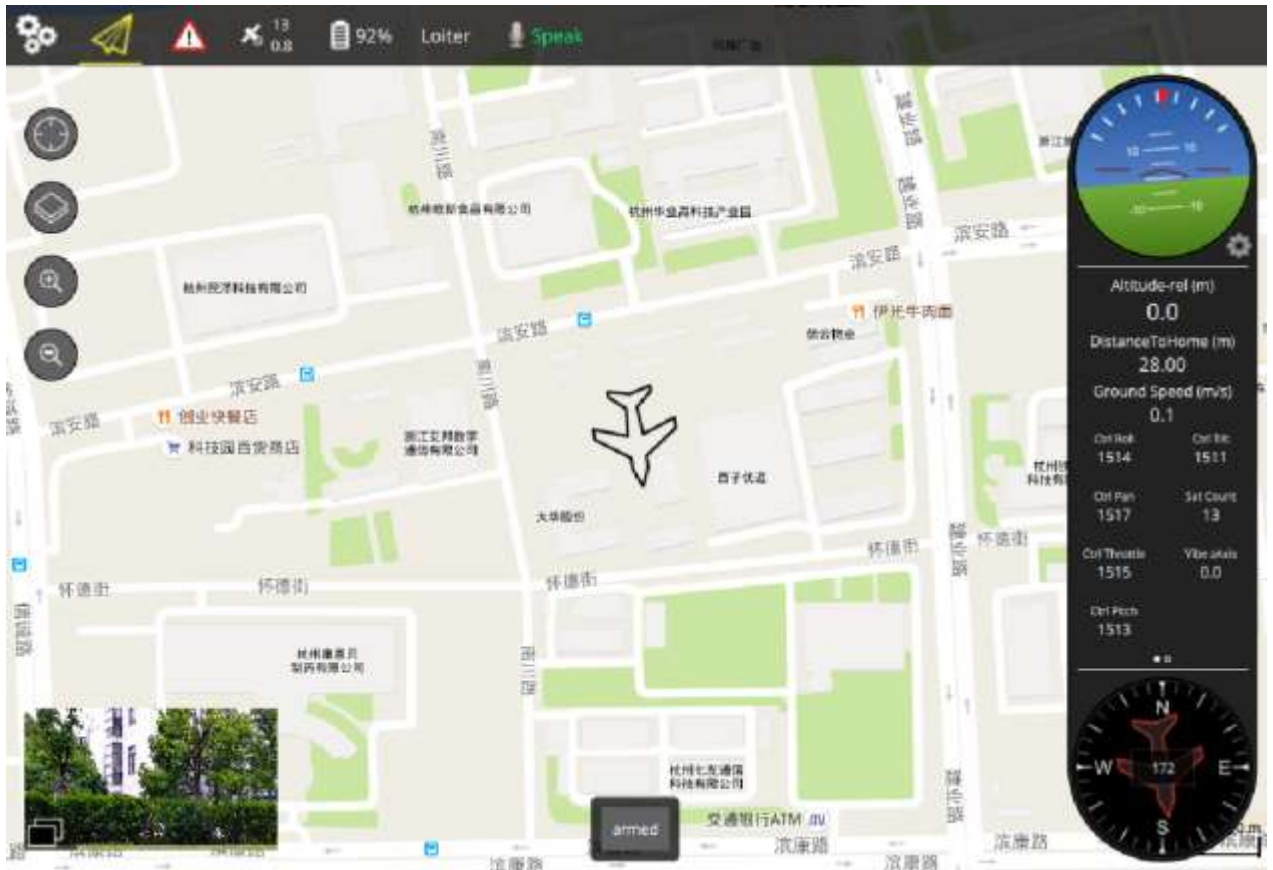



Figure 2-30

- In this mode, there is a small window at the bottom left of the preview interface. It is to display the video from the camera to the ground control station.
- In this mode, the large window is to display the aircraft position on the map.

In map preview mode, the function buttons are listed below:

-  Flight track button: Quickly switch to current map position of the aircraft, and center on current position of the aircraft to follow up.
-  Switch button of map display mode: Quickly switch the map. The map includes satellite map, topography map and street map. It can clear flight track too.

2.4.3.1.3 Speaker Settings

The device is connected with speaker. Voice is transmitted to the device via microphone, and the device diffuses voice to flight area of the aircraft.



Ensure that speaker has been connected.

Step 1 Click “Speak” icon on the main interface.

Step 2 The interface shows “Start to speak”. The icon turns red, representing that it is speaking.

Step 3 Click “Speak” again. The icon turns green, representing that speaking has stopped.

2.4.3.2 System Status Display

2.4.3.2.1 Status Display Bar 1



Figure 2-31







| Icon | Name | Function |
|---|------------------------------------|---|
|  | Alarm information | View all alarm information that appeared on the main interface.  Note In case of alarm prompt, there is a yellow framed alarm information on video preview interface. It lasts for 10 seconds and then disappears. |
|  | GPS satellite amount and precision | Check whether all parameters conform to flight conditions of the aircraft or not. <ul style="list-style-type: none"> The number at the top right corner is the GPS satellite amount. When the GPS amount is equal to or larger than 6, the aircraft is allowed to take off. The number at the bottom right corner is the GPS horizontal precision. When the precision is equal to or smaller than 1.0, the aircraft is allowed to take off.  Note The aircraft can take off after both conditions are met. If only one condition is met or both are not met, the aircraft cannot take off. |
|  | Remaining power percentage | View aircraft remaining power. Please terminate the flight as soon as possible and replace the aircraft battery if the remaining power percentage is too low. |
|  | Flight mode | Display current flight mode of aircraft. Please refer to “4.1 Flight Mode” for detailed operation methods.  Note Flight mode displayed on the ground control station and remote control are the same. |

Table 2-14

2.4.3.2.2 Status Display Bar 2

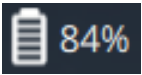
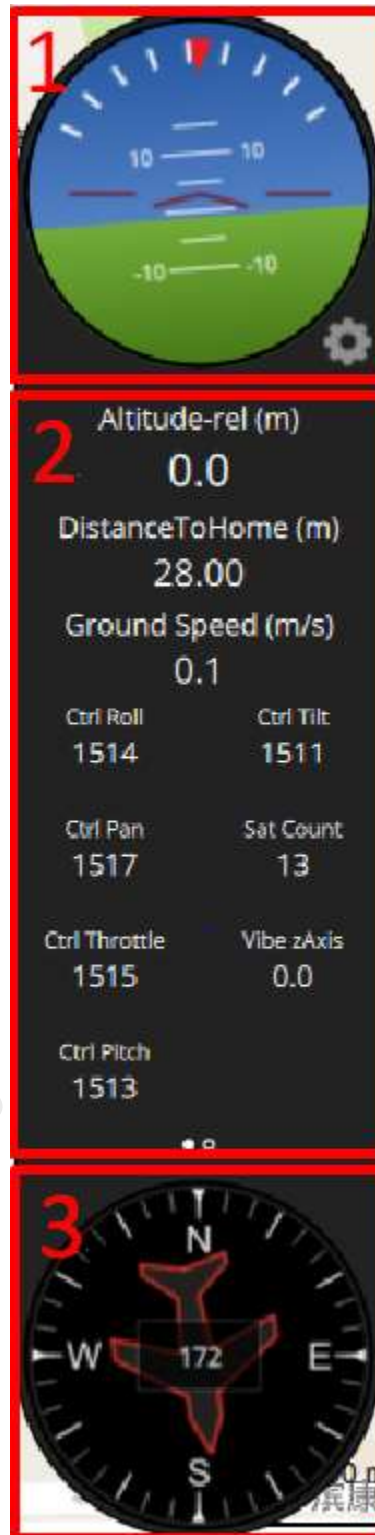

Figure 2-32

| No. | Name | Function |
|-----|---|---|
| 1 | Aircraft flight attitude and control parameter settings | <ul style="list-style-type: none"> • Display real-time flight attitude of the aircraft. Display tilt degree when the aircraft is rolling or pitching. <ul style="list-style-type: none"> ◇ Rolling tilt: each bar represents 15 degrees. ◇ Pitching tilt: each small bar represents 5 degrees and each big bar represents 10 degrees. |

| No. | Name | Function |
|-----|-----------------------------|---|
| | | <ul style="list-style-type: none"> • Aircraft control parameters. <ol style="list-style-type: none"> 1. Click  to select control parameters that will be displayed in a real-time way. 2. Click OK to make configurations take effect. |
| 2 | Aircraft control parameters | Display control parameters of aircraft in a real-time way. |
| 3 | Flight direction | <p>Display course moving angles of the aircraft in a real-time way.</p> <ul style="list-style-type: none"> • The device uses N/S/W/E to represent aircraft flight direction. • The number in the middle of the tray is to display the aircraft moving angles. Each small bar represents 10 degrees, and each large bar represents 30 degrees. |

Table 2-15

17803 大華 2018-01-08

3 ■ Flight Preparation

Note

- This chapter elaborates complete flow before the aircraft is unlocked and takes off.
- Please select operation according to the actual situation after the first flight is over, if it is not the used for the first time.

Caution

Please operate by strictly conforming to the steps described in this chapter; the operation sequence can't be reversed.

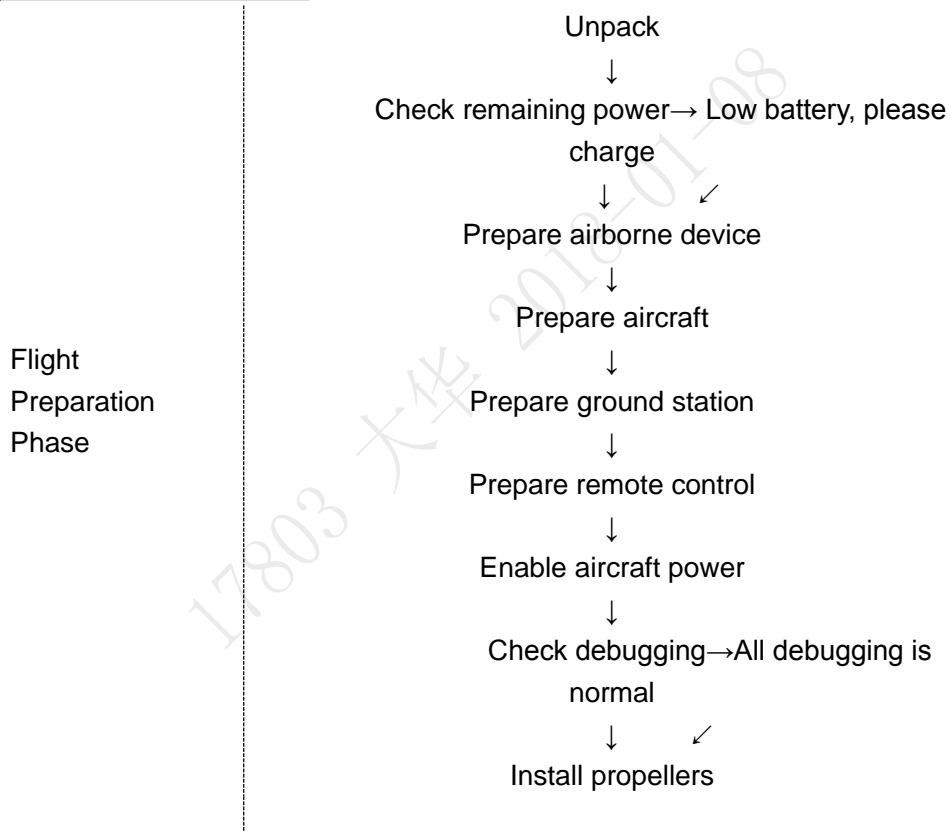

Figure 3-1

3.1 Unpack

Take out aircraft, battery, propellers, remote control and ground station from the packing box.

3.2 Check Remaining Power

Check the remaining power of aircraft battery, remote control and ground station. Implement the subsequent steps after confirming that the battery reaches the standard.

Please refer to “3.3 Charging” when the battery is low. Please implement the subsequent steps after charging.

3.2.1 Aircraft

3.2.1.1 Aircraft Battery Check

Short press the battery indication button of aircraft battery and check the number of indicator lights which are on, as shown in Figure 3-2.

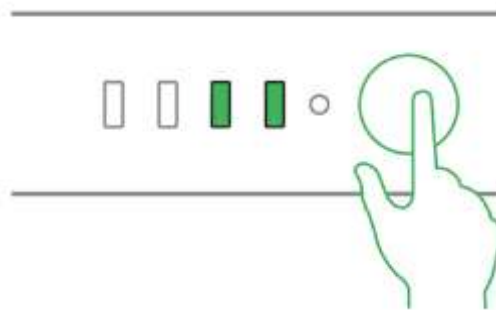

Figure 3-2

- At normal temperature, the remaining power shall be ≥ 2 .
- The aircraft shall take off with full power when temperature is lower than -10°C .

3.2.1.2 Aircraft Remaining Power

There are three statuses for each indicator light of the aircraft battery, which are normally on, flash and off.

The following table describes remaining power percentage in different status. "●" means normally on, "◎" means flash and "○" means off, as shown in Table 3-1.

| No. | Indicator Light Status | Remaining Battery Percentage Range |
|-----|------------------------|------------------------------------|
| 1 | ●●●●~●●●◎ | 100%~87.5% |
| 2 | ●●●◎~●●●○ | 87.5%~75% |
| 3 | ●●●○~●●◎○ | 75%~62.5% |
| 4 | ●●◎○~●●○○ | 62.5%~50% |
| 5 | ●●○○~●◎○○ | 50%~37.5% |
| 6 | ●◎○○~●○○○ | 37.5%~25% |
| 7 | ●○○○~◎○○○ | 25%~12.5% |
| 8 | ◎○○○~○○○○ | 12.5%~0 |

Table 3-1

3.2.2 Remote Control

3.2.2.1 Remote Control Battery Check

Move the power switch to the arrow location; view the number of indicator lights which are on.



Figure 3-3

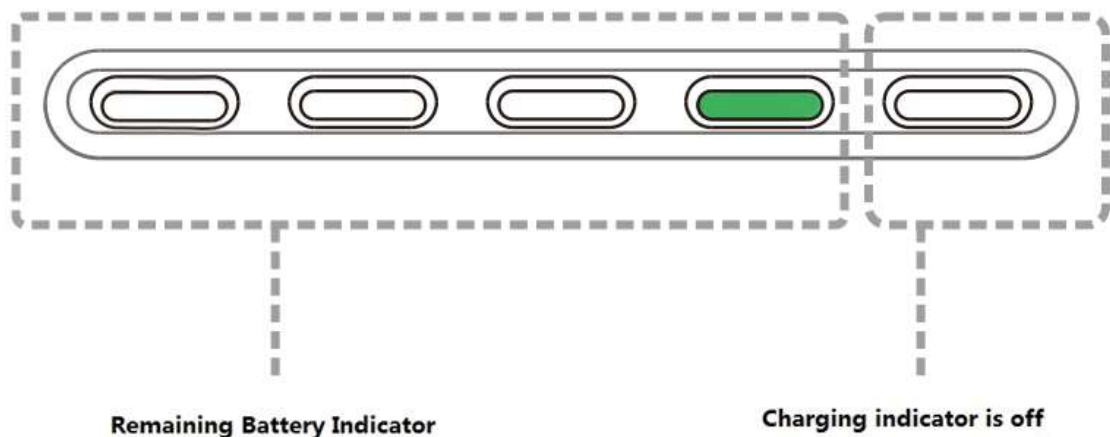

Figure 3-4

- At normal temperature, the remaining power shall be ≥ 2 .
- Remaining power shall be ≥ 3 when the temperature is lower than -10°C .

3.2.2.2 Remaining Power of Remote Control

There are two statuses for each indicator light of remote control, which are normally on and off. The following table describes remaining power percentage in different status, "●" means normally on and "○" means off, as shown in Table 3-2.

| No. | Indicator Light Status | Remaining Battery Percentage Range |
|-----|------------------------|------------------------------------|
| 1 | ●●●●~●●●○ | 100%~75% |
| 2 | ●●●○~●●○○ | 75%~50% |
| 3 | ●●○○~●○○○ | 50%~25% |
| 4 | ●○○○~○○○○ | 25%~0 |

Table 3-2

3.2.3 Ground Station Battery Check

Move the system start button to the right and the system starts up, as shown in Figure 3-5.

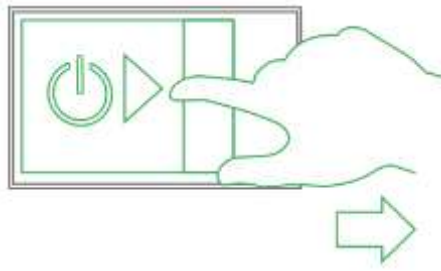

Figure 3-5

Check remaining battery percentage at the upper right corner of the operating system, as shown in Figure 3-6.

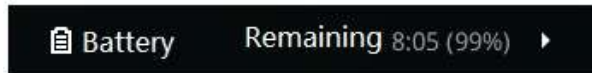

Figure 3-6

- The remaining power is required to be $\geq 30\%$ at normal temperature.
- The remaining power is required to be $\geq 40\%$ when the temperature is lower than -10°C .

3.3 Charging



Note

It doesn't need to implement the following chapter if the remaining power is enough.

3.3.1 Aircraft Battery Charging

The entire charging period (from 0 to 100) is about 2 hours. Charging period is related with remaining power and charging current (power).

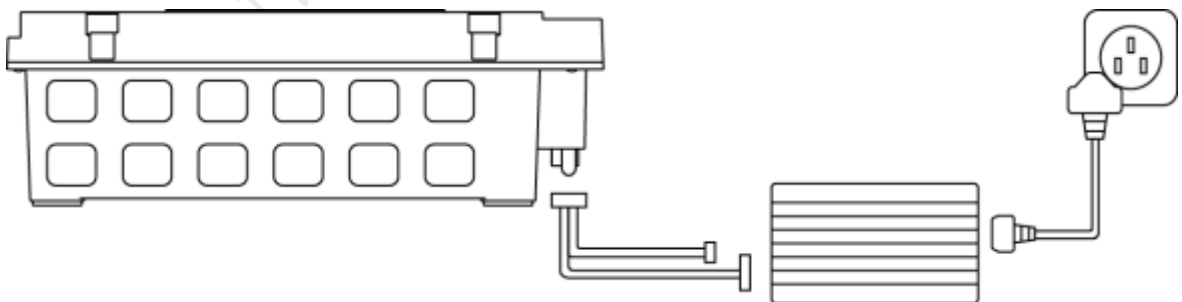

Figure 3-7

- Step 1 Open the battery cover, unfasten the battery fixing band and take out battery.
- Step 2 Connect charging adapter cable to the 6S balance port and charging power port of the charger, and connect the charger to AC power.
- Step 3 Insert the battery into the battery port of the charging adapter cable.
- Step 4 Rotate the black button and select BLC.
- Step 5 Press the button. The value displayed by LED nixie tube bounces and flashes. And then, turn the button to adjust current which is recommended to be 15A. Press the button again to select after adjustment is over.

- Step 6 Short press the battery indicator light button once, and then long press it for 3 seconds, turn on the electric quantity indicator light.
- Step 7 Long press the button to start charging and wait for the charger prompt. It means charging is completed when the charger beeps for 5 times and LED nixie tube displays DONE.



Figure 3-8

- Step 8 Disconnect it from the power socket, and then disconnect other cables after charging is completed.



Note: During charging of power battery, charging is completed when the charger displays "FULL" and beeps for 5 times. Don't take down batteries before charging is completed.

3.3.2 Remote Control Charging

The entire charging period (from 0 to 100) needs approximately 3.5 hours.

Please charge the remote control when its power is off.

- Step 1 Connect the remote control to power adapter with a charging cable.

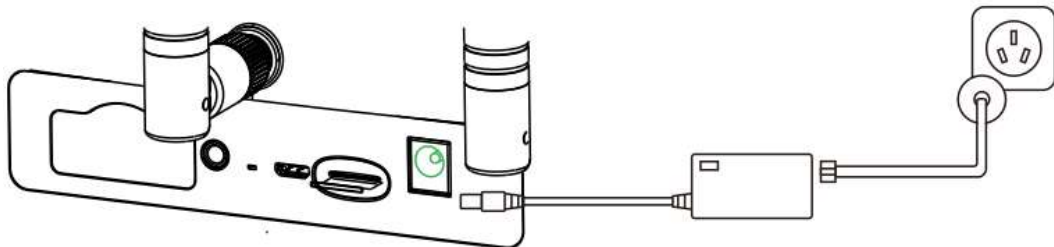

Figure 3-9

- Step 2 Connect power adapter to AC power (AC 100V-240V).
- Step 3 Check charging status: it means the remote control is charging when the indicator light is red and normally on. It means charging is done when the indicator light becomes green and normally on, as shown in Figure 3-10.



Figure 3-10

- Step 4 Disconnect it from the power socket, and then disconnect other cables after charging is completed.

3.3.3 Ground Station Charging

The entire charging period (from 0 to 100) needs approximately 3.5 hours.

Step 1 Connect the ground station to power adapter with a charging cable, as shown in Figure 3-11.

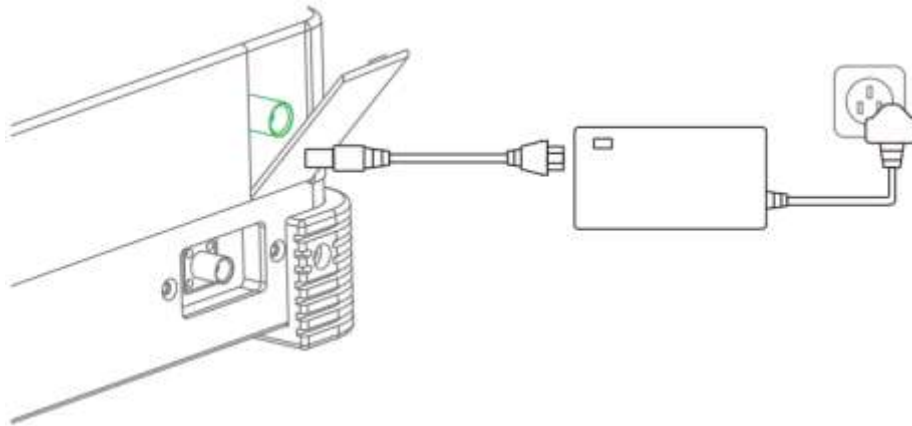

Figure 3-11

Step 2 Connect power adapter to AC power (AC 100V-240V).

Step 3 Check charging status: it means the ground station is charging when the indicator light on the right of ground station handle is orange and normally on. It means charging is done when the indicator light becomes green and normally on.

Step 4 Disconnect it from the power socket, and then disconnect other cables after charging is completed.

3.4 Prepare Equipment

3.4.1 Prepare Airborne Equipment

Note

- The following chapter is optional for operation.
- Please implement demounting step first and then connection step when the PTZ camera needs to be replaced.
- It only needs to implement demounting step when the aircraft flies directly without PTZ camera.

3.4.1.1 Demount PTZ Camera

Step 1 Loosen four mounting screws, as shown in Figure 3-12.

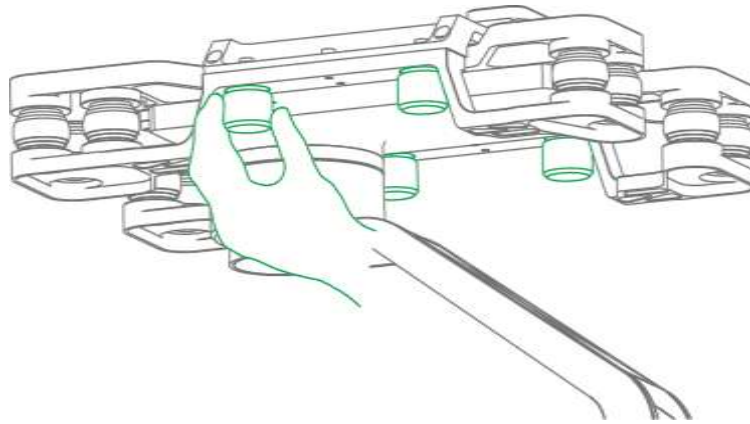

Figure 3-12

Step 2 Take down PTZ camera.

3.4.1.2 Install PTZ Camera

Step 1 Insert the upper port on the vibration damper plate of the PTZ camera into corresponding port at the bottom of the aircraft, as shown in Figure 3-13.

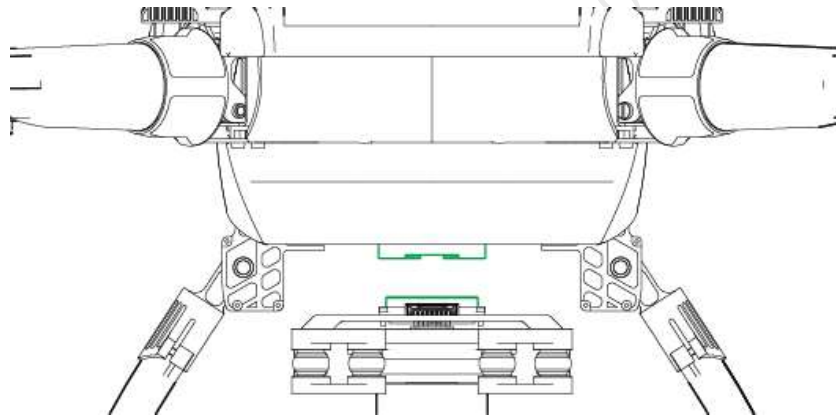
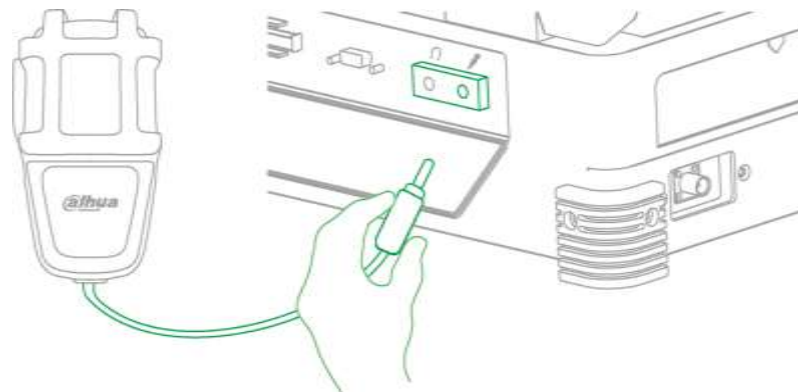

Figure 3-13

Step 2 Align four mounting screws with the hole positions at the bottom of the aircraft, and tighten the screws.

3.4.2 External Microphone

Insert the connector of external microphone into corresponding port of ground station, as shown in Figure 3-14.



3.5 Prepare Aircraft

3.5.1 Unfold Aircraft Arm

Unfold the aircraft arm to horizontal position. The arm is firmly stuck when you hear the sound of “click”, as shown in Figure 3-15.



The subsequent steps can be implemented only when the arm is firmly stuck. Please contact our company when the arm is loose.

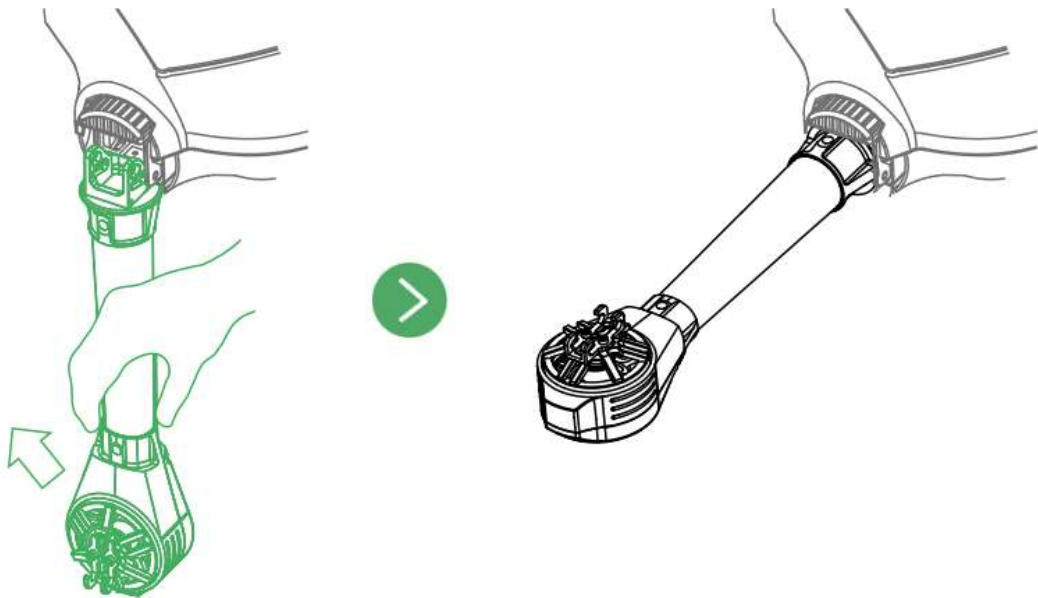

Figure 3-15

3.5.2 Open Antenna



It is recommended to unfold the antenna to vertical position, in order to realize optimum communication effect.

Unfold the aircraft antenna, move it to vertical position and make it firmly stuck, as shown in Figure 3-16.

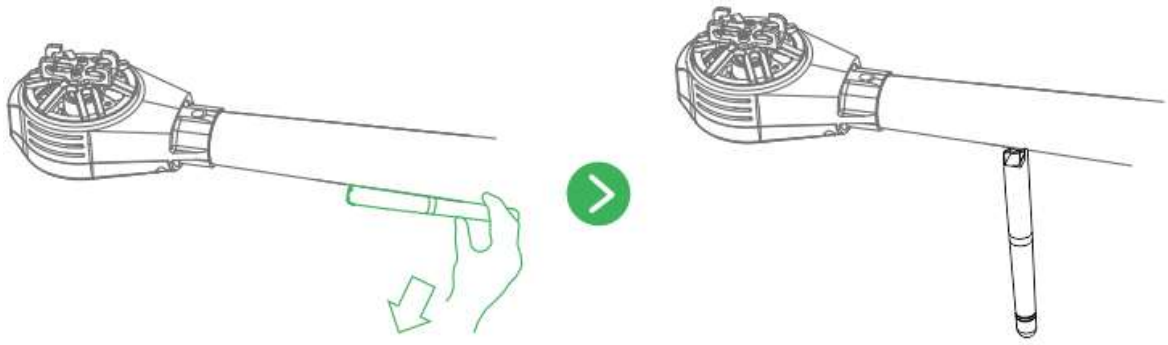

Figure 3-16

3.5.3 Install Aircraft Battery

Step 1 Move the button on the cover and then open the battery cover, as shown in Figure 3-17.

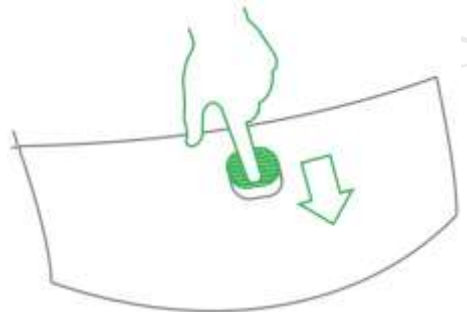

Figure 3-17

Step 2 Put the battery into the aircraft horizontally, fasten the fixing band firmly, as shown in Figure 3-18.

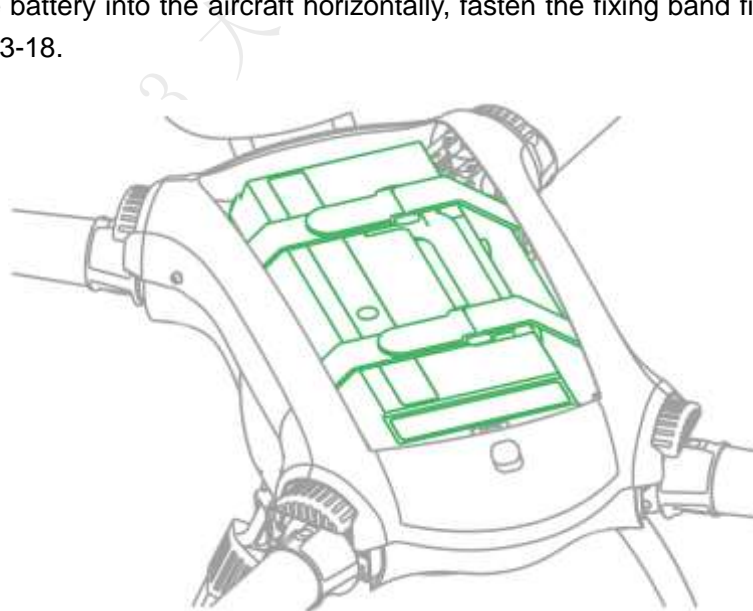

Figure 3-18

Step 3 Close the cover, move the button on the cover and lock it firmly.

3.6 Prepare Ground Station

3.6.1 Set up Antenna

- Step 1 Open the tripod and adjust it to a proper height. Make sure that it is stably installed on the horizontal plane.
- Step 2 Tighten the two image transmission antenna firmly, insert it into the tripod and lock it firmly, as shown in Figure 3-19.

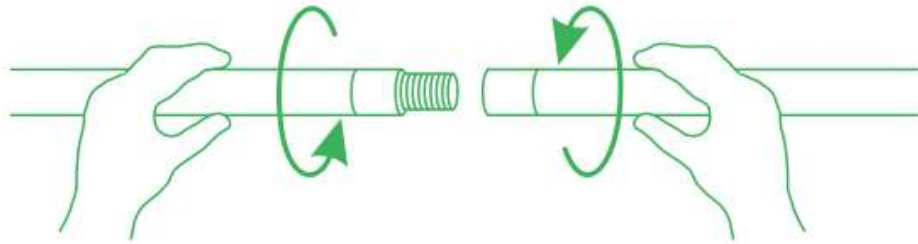

Figure 3-19

- Step 3 Connect the cable of image transmission antenna to the port of image transmission antenna on the left of ground station, as shown in Figure 3-20.

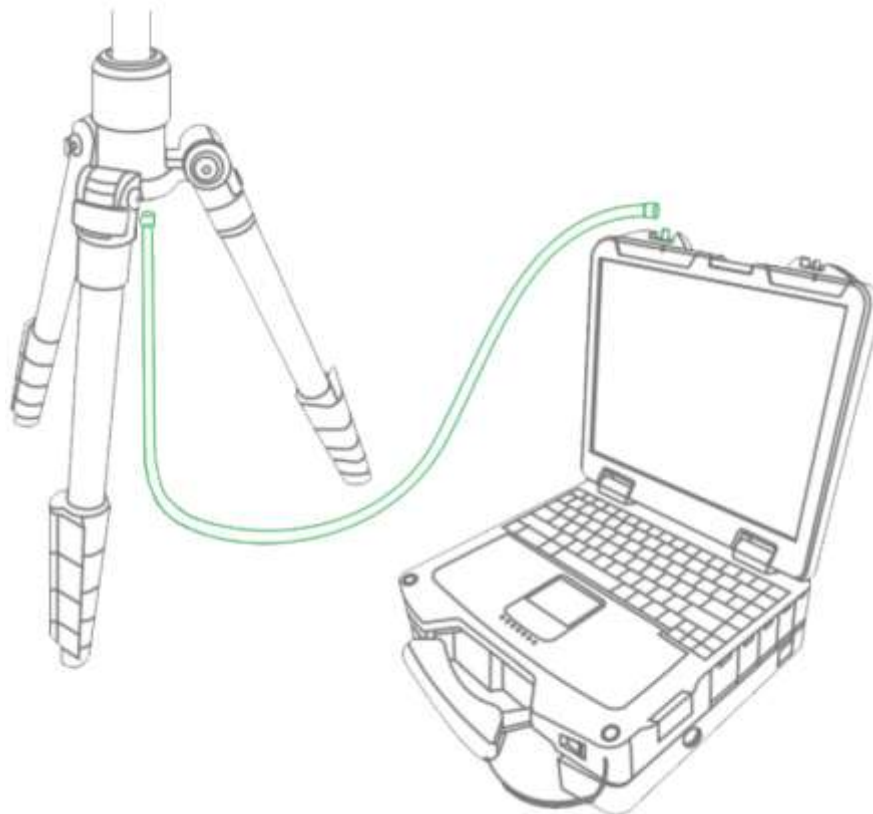

Figure 3-20

- Step 4 Twist the relay antenna into the port on the right of ground station, and adjust it to vertical position, as shown in Figure 3-21.

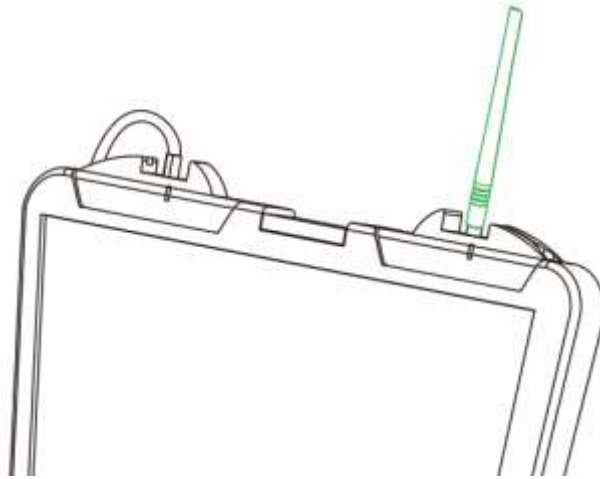

Figure 3-21

3.6.2 Enable Ground Station Power



Note

Please skip the chapter if the power is not turned off after checking remaining power.

Step 1 Move the system start button to the right and the system starts up, as shown in Figure 3-22.

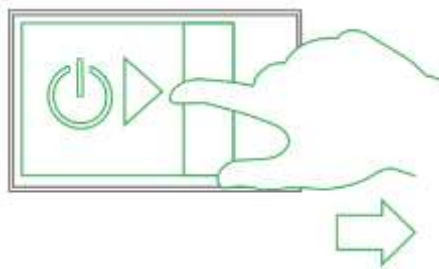

Figure 3-22

Step 2 Short press the image transmission button and the built-in red indicator light is on, as shown in Figure 3-23.

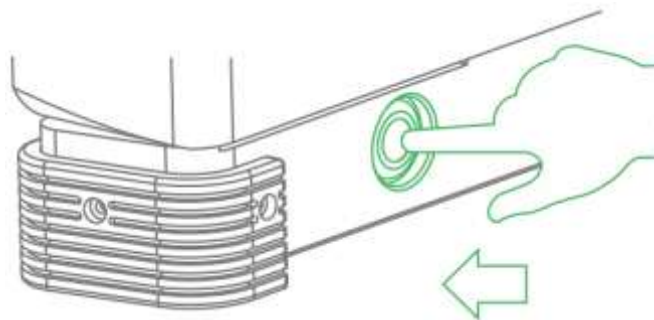

Figure 3-23

3.7 Prepare Remote Control

3.7.1 Install SD Card

Remote control owns about 3G memory space. Please choose and install SD card according to actual needs.



- The following chapter is optional for operation.
- SD card needs to be configured on your own.
- SD card supports max. 64G.

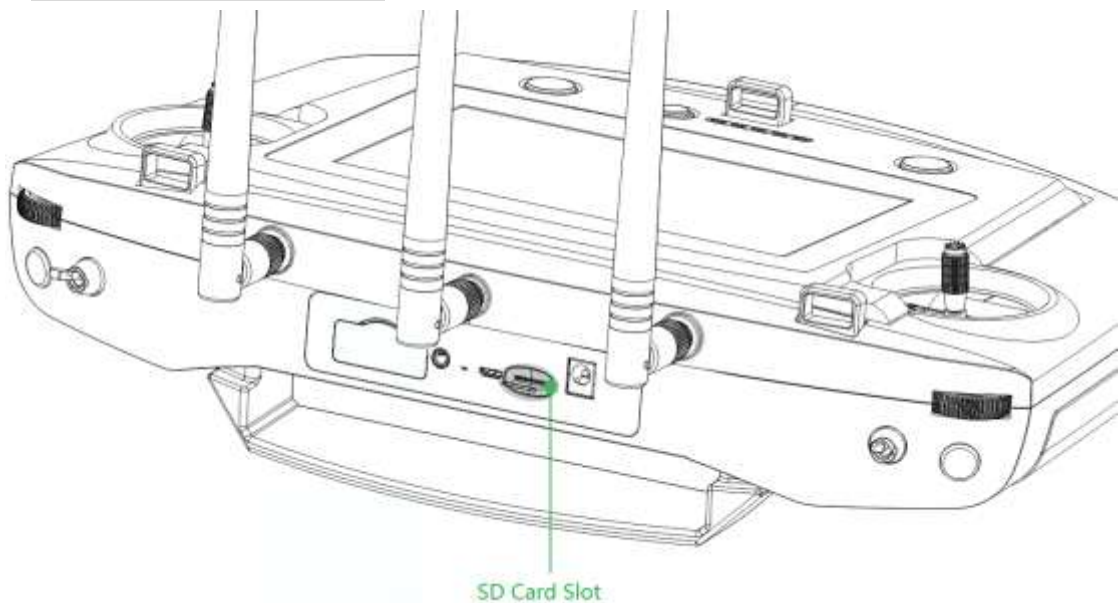

Figure 3-24

Install SD card: Make the metal surface of SD card face downward and insert it into the SD card slot of the remote control side panel horizontally.

3.7.2 Open Antenna

Open the antenna of remote control to proper location, as shown in Figure 3-25.

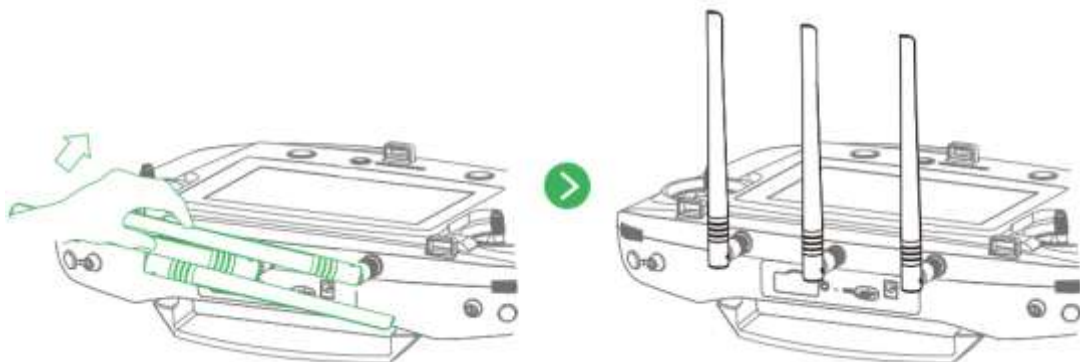

Figure 3-25

3.7.3 Enable Remote Control Power



Please skip the chapter if the power is not turned off after checking remaining battery.

Enable remote control power: move the power button of remote control to the arrow location, as shown in Figure 3-26.



Figure 3-26

3.7.4 Confirm Remote Control Mode

It is mode 2 by default. Please set in "Settings > RC Settings > Joystick Mode" to switch mode, as shown in Figure 3-27.

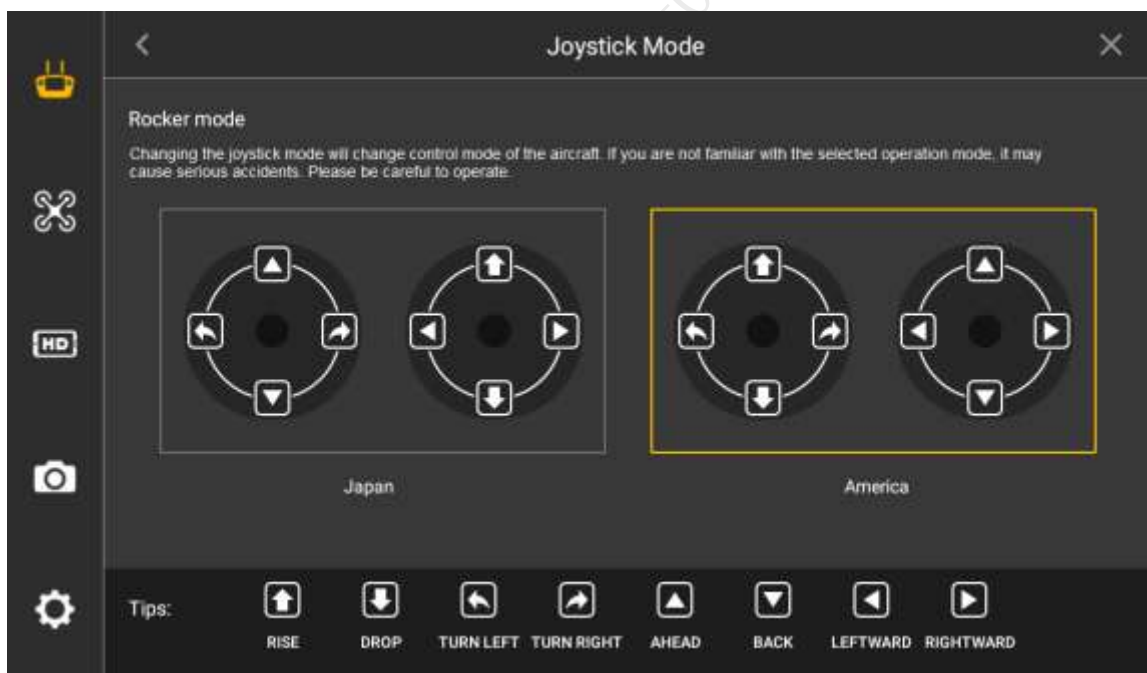

Figure 3-27

Please refer to "4.2.4 Manual Flight Control" for remote control mode and its corresponding relations.

3.8 Enable Aircraft Power

There is a power switch below the aircraft tail. First, short press it once and then long press it for 3 seconds. It means successful power-on when the power indicator light becomes green, as

shown in Figure 3-28.



After power on, when the ground station doesn't require other operations, please always keep the aircraft horizontal and static; otherwise, it may result in initialization failure.

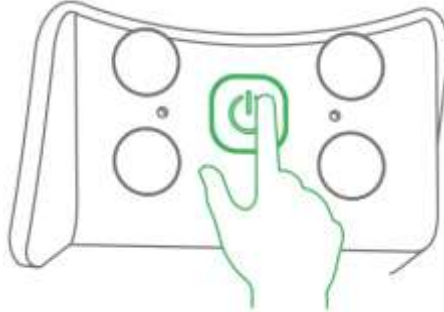

Figure 3-28

3.9 Check and Debugging



The subsequent steps can be implemented only after checking and debugging all the items listed in the chapter below. Besides, the remote control and ground station prompt that each status is normal and the aircraft indicator light flashes green.



It is recommended to set the display image of remote control and ground station as video preview mode before taking off.

Check operation condition. Please debug each component to make it operate normally when both the remote control and ground station prompt abnormality.

It is going to list common calibration items, abnormalities and its solutions in the following chapter.

3.9.1 Aircraft Diagnosis

Abnormities

There is no image transmission or data transmission display on the ground station.

Exact Operation

Step 1 Select "Aircraft Settings > Diagnosis" to enter diagnosis interface, as shown in Figure 3-29.

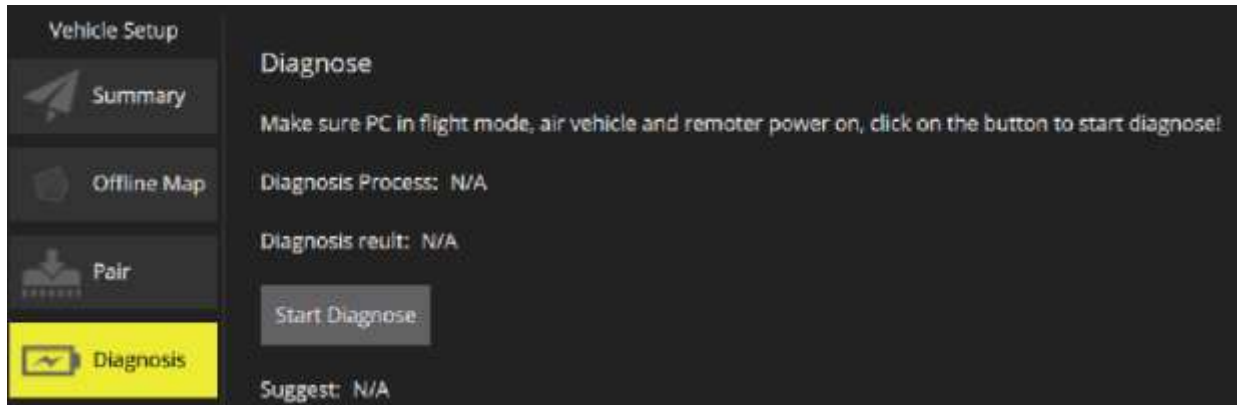

Figure 3-29

Step 2 Click "Start Diagnosis" and the system enters self-diagnosis.

Step 3 Display diagnosis suggestion after diagnosis is completed. "Start Diagnosis" button becomes yellow, as shown in Figure 3-30.

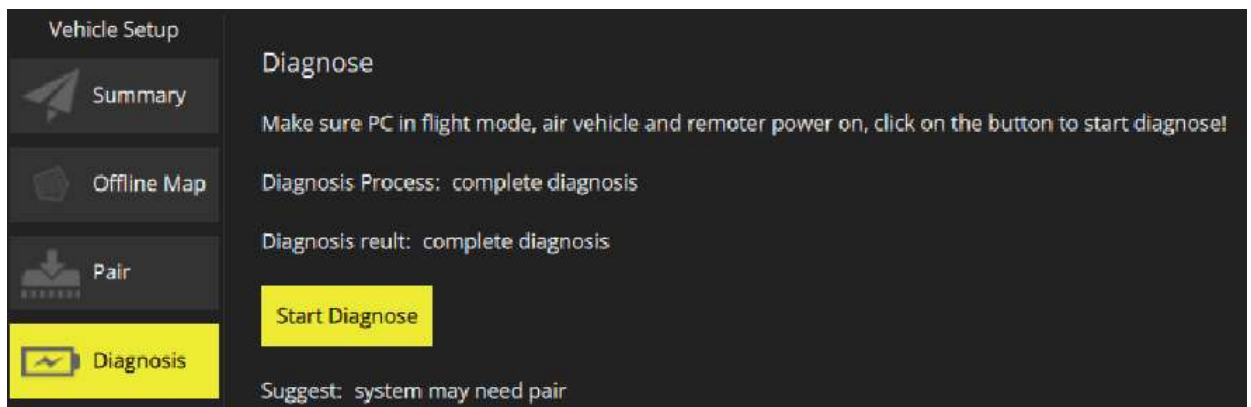

Figure 3-30

Step 4 Adjust the device according to the "Suggest" and make the ground station display image transmission or data transmission information.

3.9.2 Remote Control Calibration

Step 1 Select "Settings > Remote Control Settings> Remote Calibration" to enter the remote calibration interface, as shown in Figure 3-31.

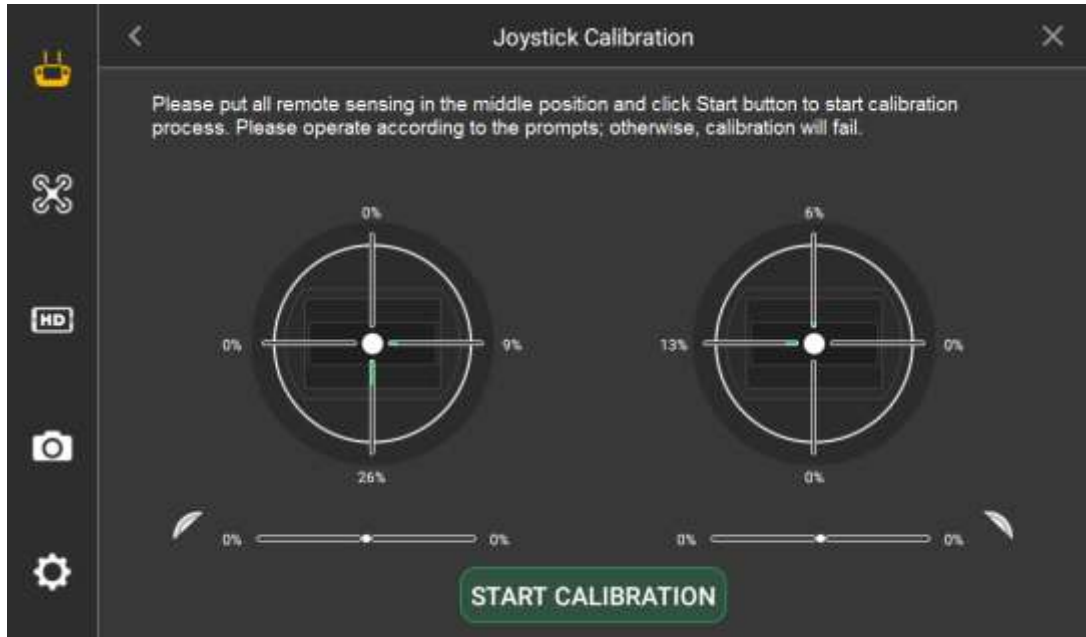

Figure 3-31

- Step 2 Move both the left and right sticks back to the middle.
- Step 3 Click "Start Calibration".
- Step 4 Turn two sticks and turn to the max end of each direction for several times.
- Step 5 Slide the rolling wheels on both sides, slide to the max end of two directions for several times.
- Step 6 Click "Complete Calibration" after turning the rolling wheels and sticks.

3.9.3 Accelerometer Calibration

Select "Settings > General > Other > Accelerometer Calibration" to enter the interface of accelerometer calibration, as shown in Figure 3-32.

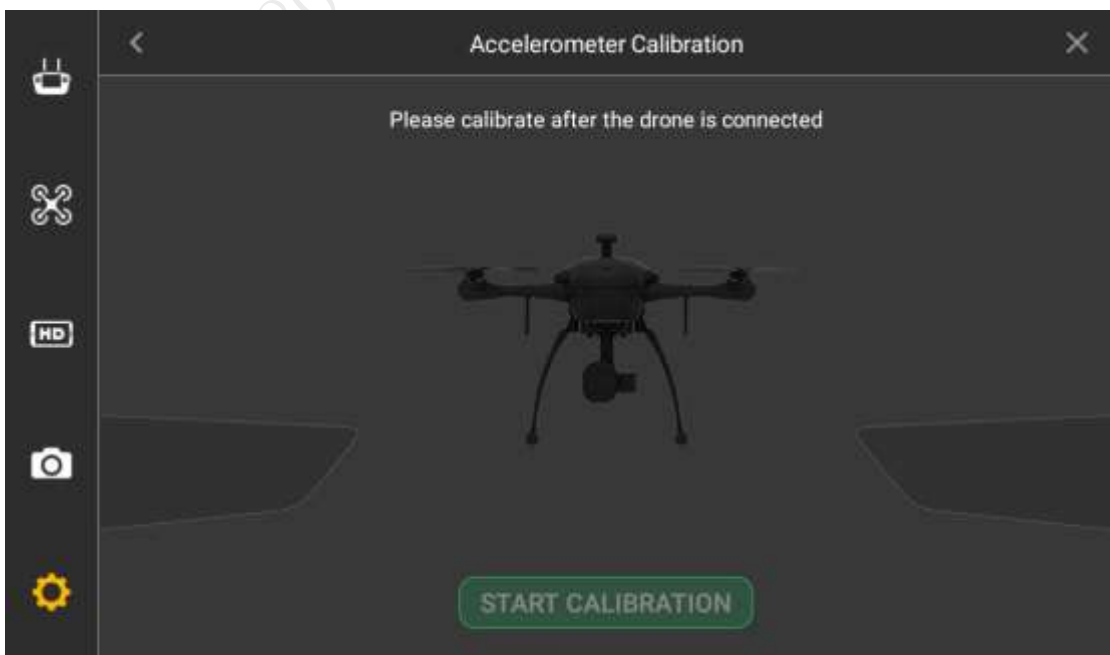

Figure 3-32

Place the aircraft on a flat surface, and click "Start Calibration".

- The remote control will prompt "Calibration Success" if it is successfully calibrated.

- The remote control will prompt "Calibration Failure" if it fails to calibrate. Click "Retry" till it is successfully calibrated.

3.9.4 Initialization Failure

Abnormity Prompt

Both remote control and ground station prompt "Initialization Failure".

Possible Reasons

After power on and before taking off, it may result in initialization failure if you move the aircraft.

Solutions

Power on the aircraft again after the power is cut off, and keep the aircraft horizontal and static during initialization. Please contact our company if initialization fails for several times.

3.9.5 Geomagnetic Abnormity

Abnormity Prompt

- Aircraft indicator ●●● flashes.
- Both remote control and ground station prompt "Geomagnetic Abnormity".

Possible Reasons

- The use position has changed a lot, which means the geographical location is quite far away from the last geographical location where the aircraft is used, causing big change to geomagnetic field.
- There is another intensive magnetic field in the environment, affecting geomagnetic field.

Solutions

Step 1 Select "Settings > General > Other > Geomagnetic Calibration" on the remote control and enter the interface of geomagnetic calibration, as shown in Figure 3-33.

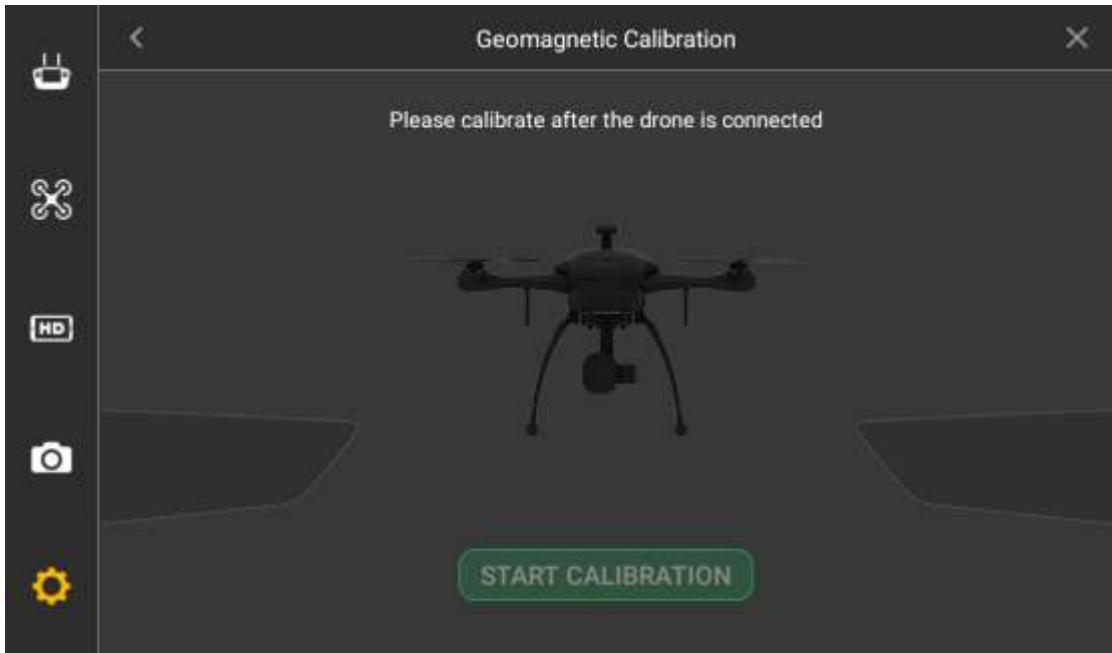

Figure 3-33

Step 2 Click "Start Calibration".

Step 3 Keep the aircraft horizontal and rotate it for one circle horizontally, as shown in Figure 3-34.

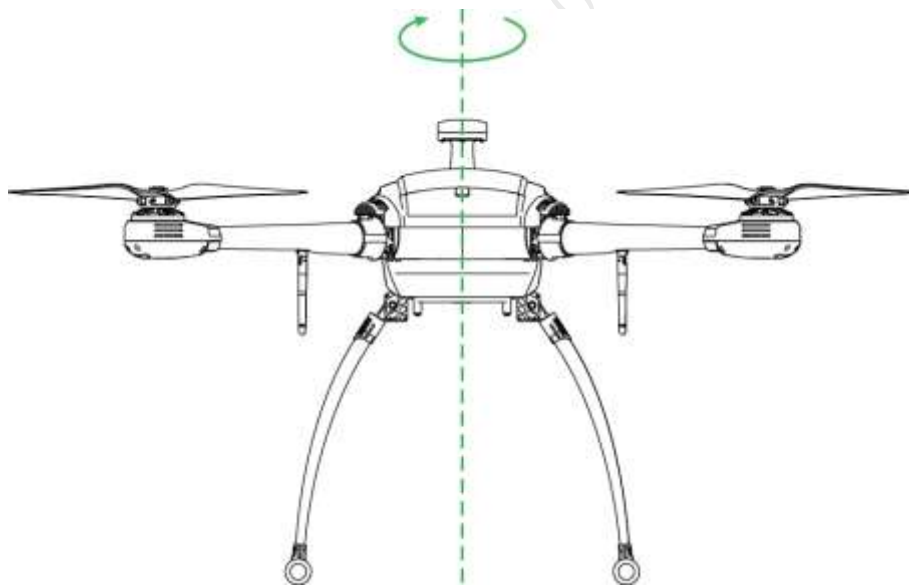

Figure 3-34

Step 4 Keep the aircraft vertical and rotate it for one circle vertically, as shown in Figure 3-35.

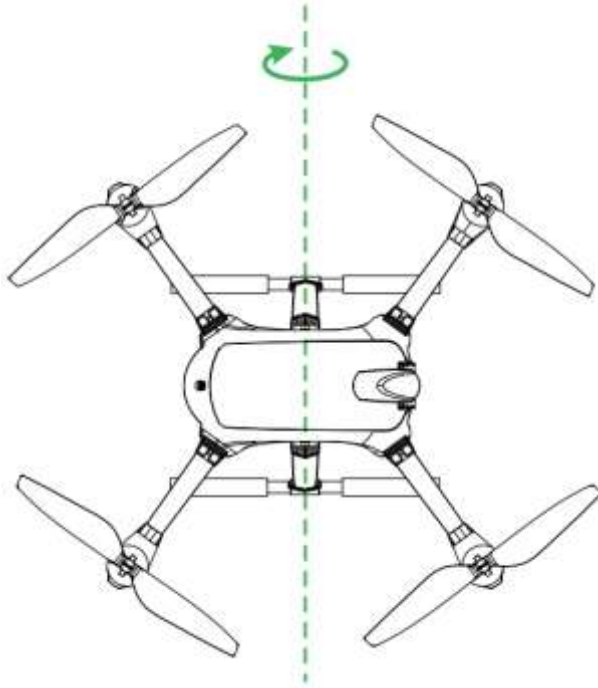

Figure 3-35

- It will prompt geomagnetic calibration success if it is successfully calibrated.
- It will prompt geomagnetic calibration failure if it fails to calibrate. Repeat Step 2, 3 and 4 to calibrate again.

3.9.6 GPS Satellites Insufficiency

Abnormity Prompt

Displayed number of satellites for remote control and ground station is less than 6.

Possible Reasons

- The flying environment is not wide open enough, which is severely blocked.
- There is some other interference around the surroundings.

Solutions

Move the aircraft to a wider area and wait for 30s.

3.10 Install Propellers

Step 1 Press the spring buckle on both sides of the propeller center, as shown in Figure 3-36.

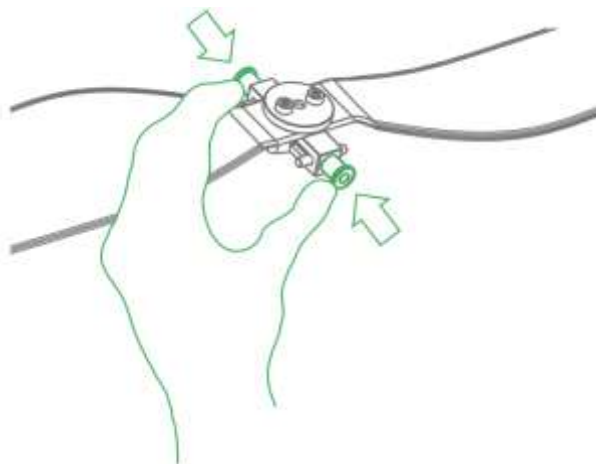

Figure 3-36

Step 2 Buckle the latch on the motor, as shown in Figure 3-37.



Note

The structures of two pairs of propellers are different. Adjust to the adjacent motor position to install if it fails to buckle.

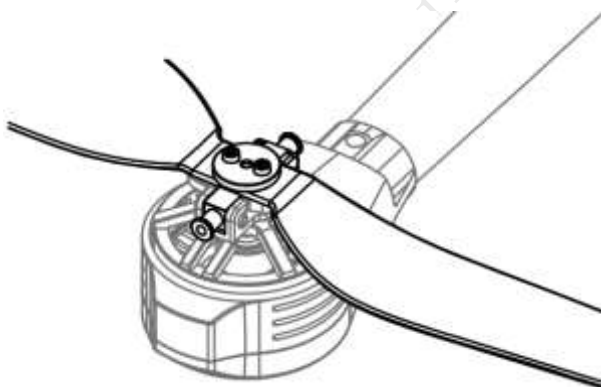

Figure 3-37

4. Enable Flight



This chapter will elaborate the complete flow of formal takeoff and landing of the aircraft.



Please stay away from the rotating propellers or motor, to avoid personal injury.



For your personal and property safety, please make sure to check the following items carefully before enabling flight.

- Flight preparations listed in Chapter 3 are all completed.
- All the components have been correctly and stably installed.
- Make sure that each spare part is in good condition. Please do not fly the aircraft if some parts are aged or damaged.
- Flight environment meets the requirements listed in important safeguards and warnings.



Please do not block the ventilation next to heat dissipation hole when the motor is operating.

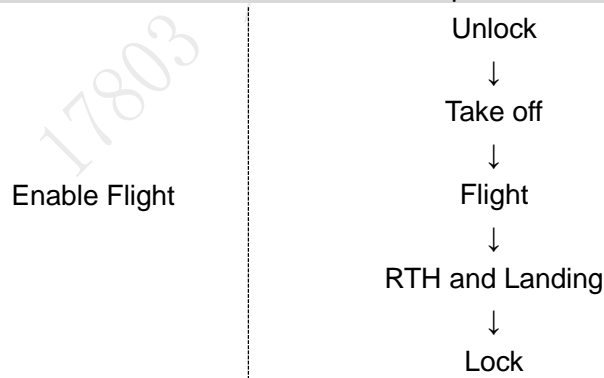

Figure 4-1

4.1 Flight Mode

Control flight mode via driving lever during flight phase, as shown in Figure 4-2.

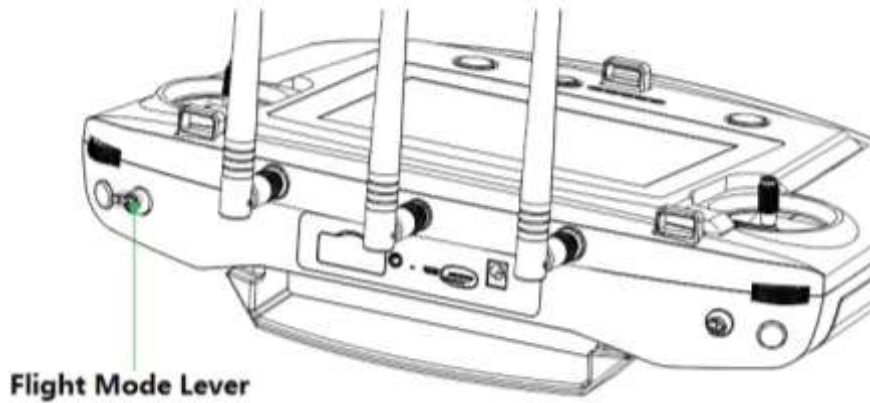

Figure 4-2

Three-level driving lever:

- Upper level: Intelligent flight mode. The aircraft will fly automatically according to the pre-set flight route.
- Medium level: It is the fixed height flight mode in manual flight mode. The aircraft will maintain the current flight height when the throttle stick is in the middle.
- Lower level: Fixed point flight mode in manual flight mode. The aircraft will maintain the current location when all sticks are located in the middle.

The chapter will introduce manual and intelligent flight mode respectively.

Switch between these two modes. For example, you can use one-key takeoff and landing buttons in the manual flight mode.

4.2 Manual Mode

4.2.1 Introduction to Manual Flight Flow

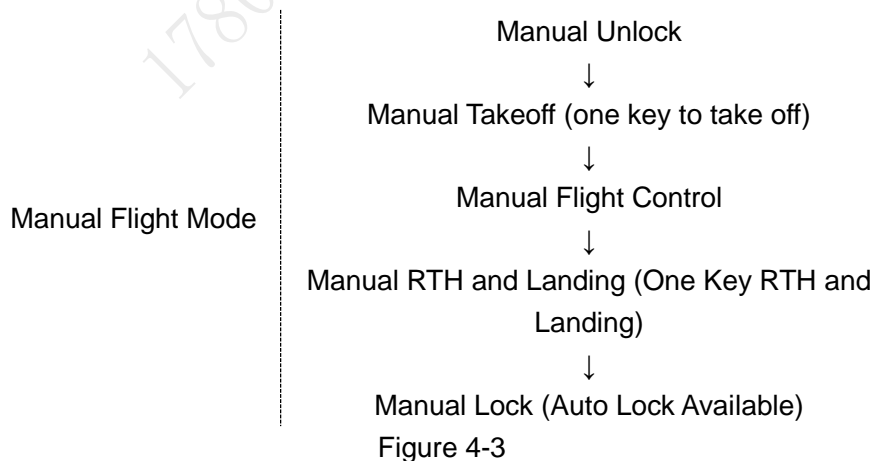

4.2.2 Unlock Flight Control

Move the left stick to lower left, meanwhile move the right stick to lower right (or move the left stick to lower right, meanwhile move the right stick to lower left), and keep the status for 2s. At this moment, the propellers are unlocked and start to rotate. Move all the sticks back to middle, as shown in Figure 4-4.

Mode 1

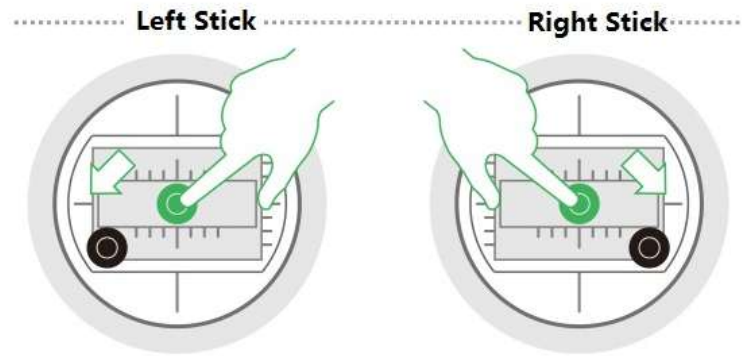

Mode 2

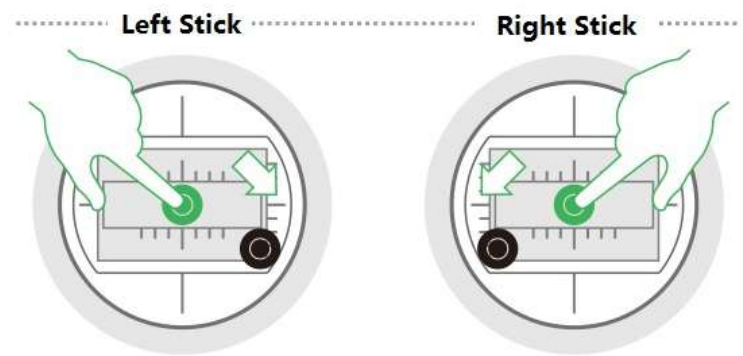

Figure 4-4



Caution

- If there is obvious difference about rotating speed of the propellers, move the left stick to lower left and meanwhile move the right stick to lower right (or move the left stick to lower right, and meanwhile move the right stick to lower left), and then keep the status till the propellers stop rotating. Turn off the aircraft and contact our company.
- The aircraft will be automatically locked if it stays on the ground and fails to take off within 10s after it is unlocked.

4.2.3 Manual Takeoff

Slightly push the throttle to mid-point or higher, as shown in Figure 4-5.



Figure 4-5

4.2.4 Manual Flight Control

Set remote control mode and control flight direction of the aircraft.

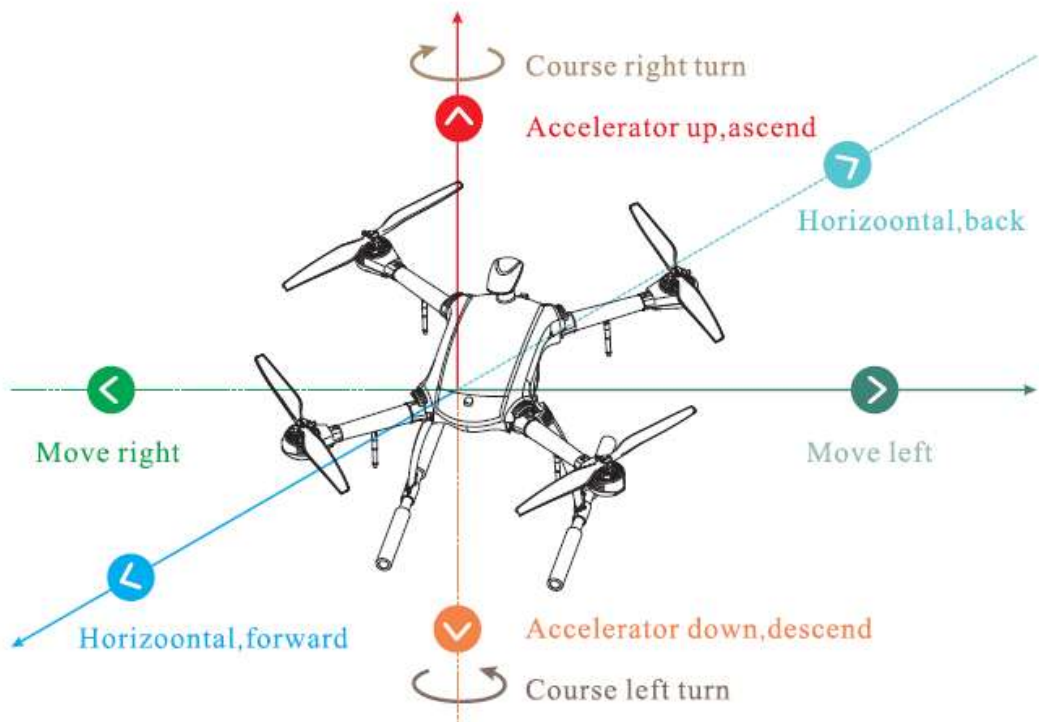

Figure 4-6

The stick presets two remote control modes.

It is mode 2 by default. Please modify in “Settings > Remote Control Settings > Stick Mode” to switch to mode 1.

- Mode 1:
 - ◇ Moving the left stick up and down (pitching stick) to control aircraft’s forward and backward horizontally.

- ◇ Moving the left stick left and right (course stick) to control aircraft's left and right turn horizontally.
- ◇ Moving the right stick up and down (throttle stick) to control aircraft's ascending and descending respectively.
- ◇ Moving the right stick left and right (rolling stick) to control aircraft's left and right movement horizontally.

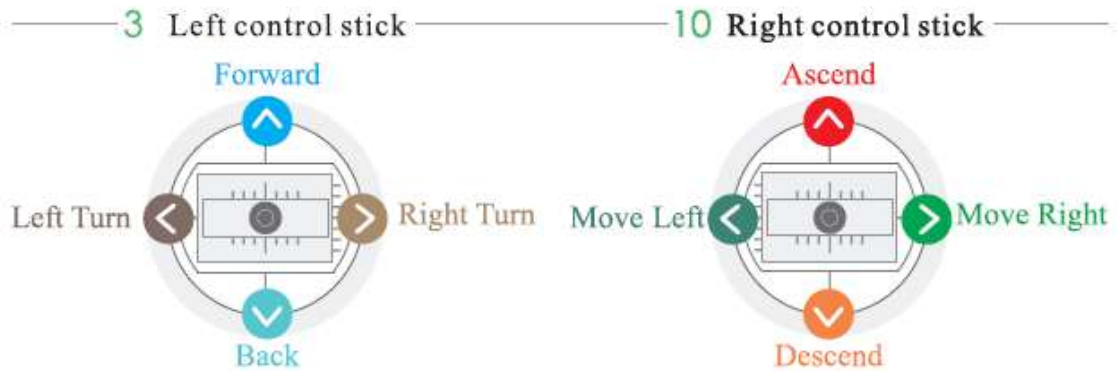

Figure 4-7

- Mode 2:
 - ◇ Moving the left stick up and down (throttle stick) to control aircraft's ascending and descending respectively.
 - ◇ Moving the left stick left and right (course stick) to control aircraft's left and right turn horizontally.
 - ◇ Moving the right stick up and down (pitching stick) to control aircraft's forward and backward movement horizontally.
 - ◇ Moving the right stick left and right (rolling stick) to control aircraft's left and right movement horizontally.

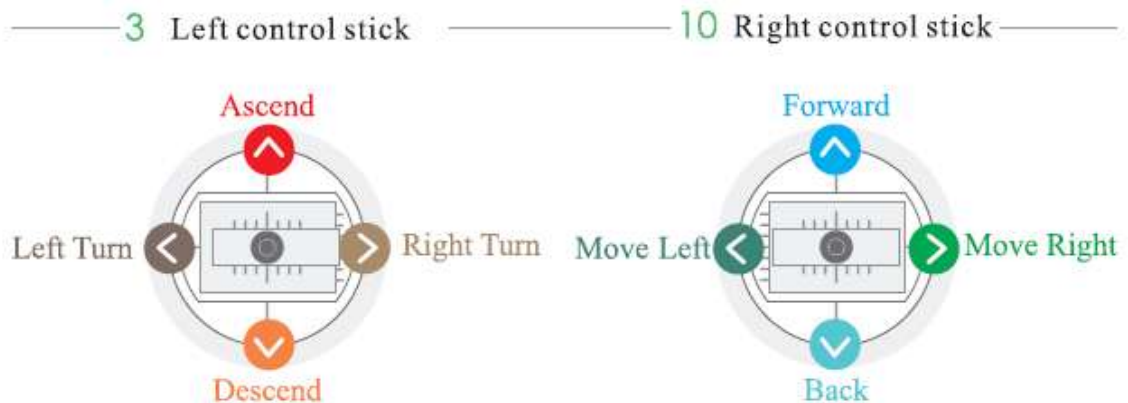

Figure 4-8

4.2.5 Manual RTH and Landing

- Step 1 Manual RTH: Control the aircraft to hover over a proper landing point.
- Step 2 Manual landing: Reduce the throttle to make the aircraft land slowly.

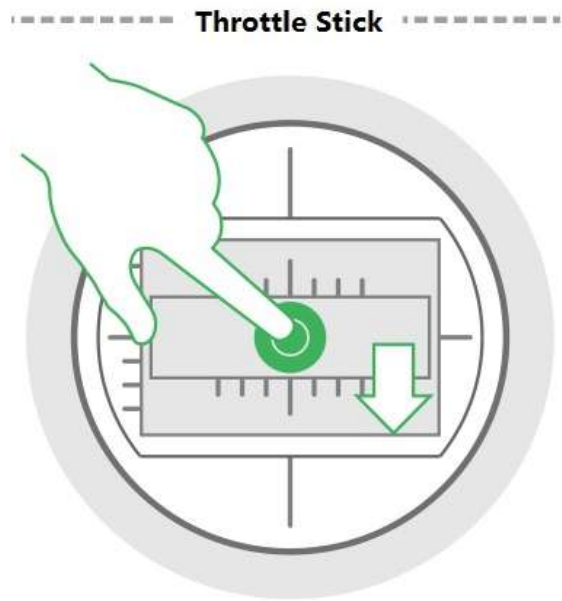
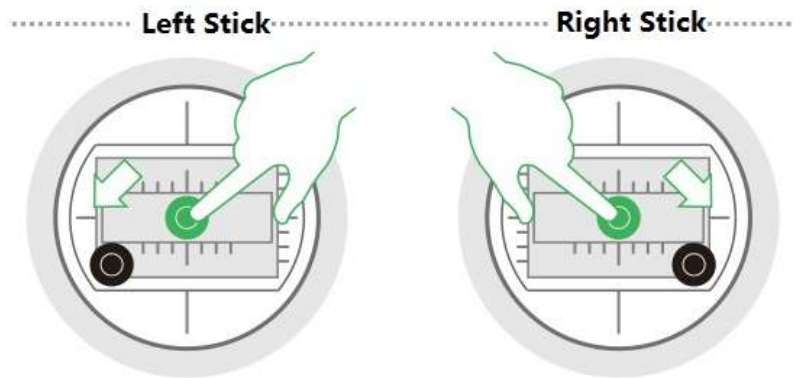

Figure 4-9

4.2.6 Manual Locking

Move the left stick to lower left and move the right stick to lower right at the same time (or move the left stick to lower right and move the right stick to lower left at the same time).

Mode 1



Mode 2

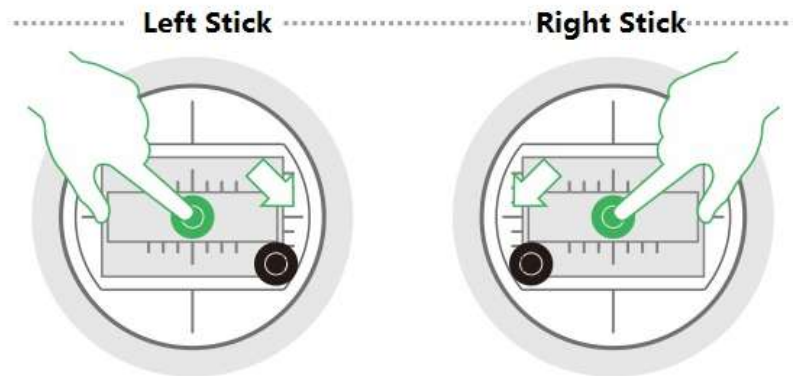

Figure 4-10

4.3 Intelligent Mode

4.3.1 Flight Route

4.3.1.1 Auto Takeoff

In fixed point mode, first unlock flight control, and then short press the takeoff and landing button on the front panel of the remote control. The aircraft will take off automatically and begin flight according to the pre-set route.

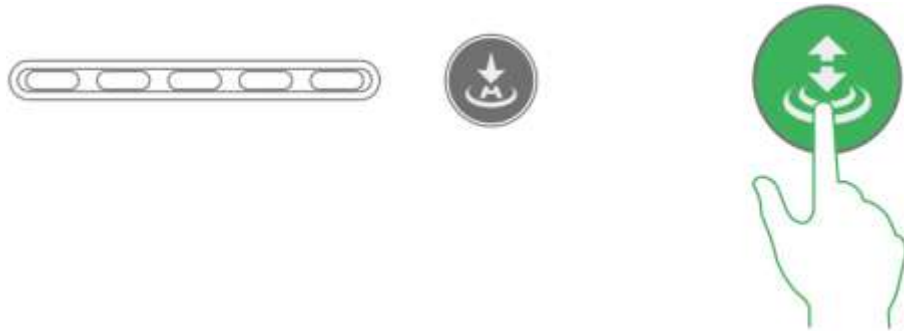

Figure 4-11

4.3.1.2 Auto RTH and Landing



The landing under the condition of low battery or in the uncontrollable situation has been introduced in other chapters; this chapter will only introduce the landing modes in other situations.

Auto RTH

- If the aircraft is right above Home point, press RTH button, and the aircraft will land no matter how high it is.
- If the aircraft is not right above Home point, press RTH button, and the aircraft will rise to 120m, go to right above Home point and then land.



Figure 4-12

Auto Landing

Press the takeoff and landing button during RTH, the aircraft will land at the current position.

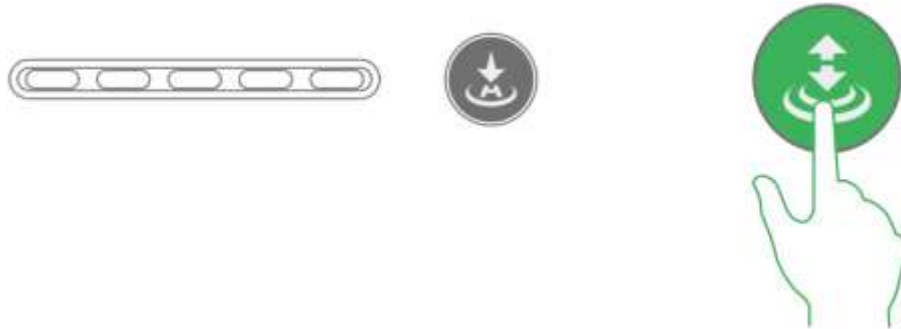

Figure 4-13

4.3.1.3 Auto Locking

Move the throttle stick to the lowest position and keep it for more than 2 seconds.

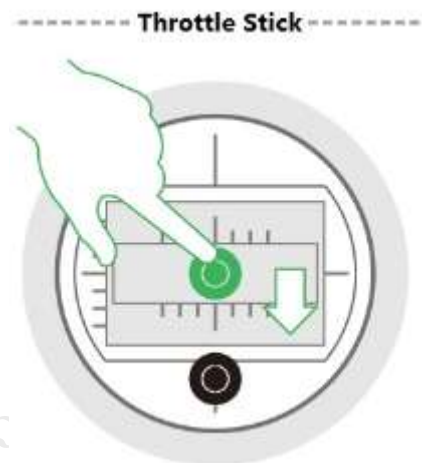

Figure 4-14

4.3.2 Intelligent Flight Mode

Intelligent flight mode includes waypoint and circle around point of interest.

- Waypoint flight: Set waypoint flight mission according to requirements. Move the flight mode stick to intelligent mode after the aircraft takes off, select proper flight mission and click "Start Mission".
- Circle (around point of interest) flight: Set circle flight mission according to requirements. Move the flight mode stick to intelligent mode after the aircraft takes off, select proper flight mission and click "Start Mission".

Note

- When the flight mode stick of remote control is moved to any mode (point, elevation or intelligent mode), you can set waypoint flight or point of interest flight and save flight mission.
- The aircraft is allowed to implement flight mission only when the flight mode stick of remote

control is moved to the intelligent mode (Mode F).

- It can realize waypoint flight or point of interest flight only after the aircraft takes off, and it can't be realized on the ground.

Click the  button on the main interface of the remote control, and enter the interface of intelligent mode, as shown in Figure 4-15.

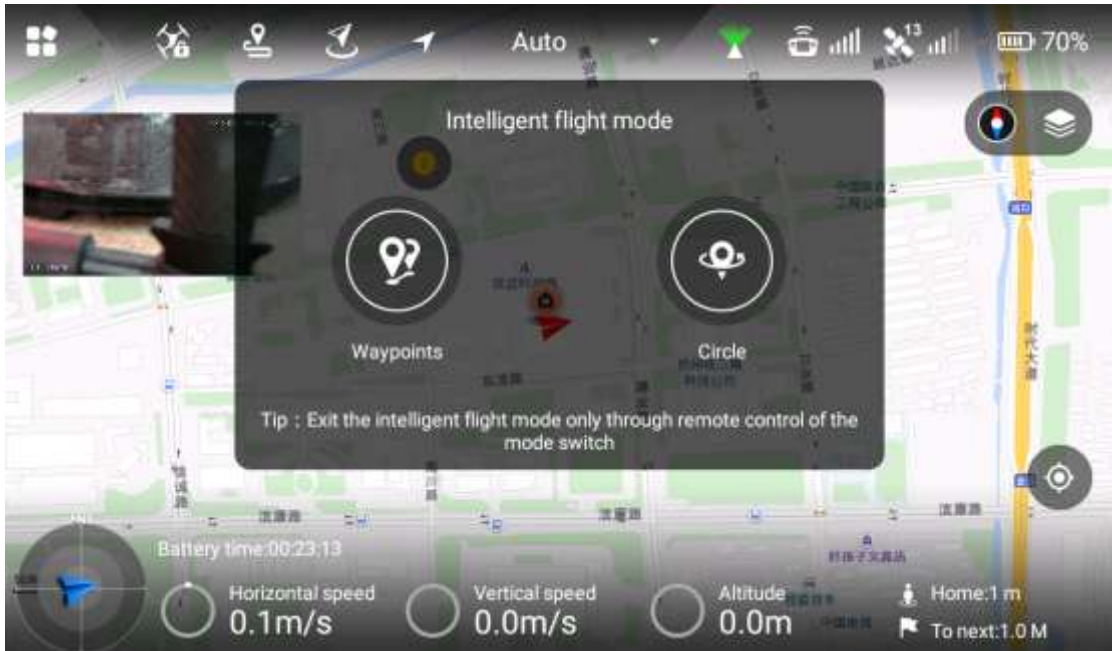

Figure 4-15

4.3.2.1 Waypoint Flight

Step 1 Select "Waypoints" and enter the interface of waypoint flight, as shown in Figure 4-16.



Note

Check total route length, estimated flight time and set "Cycle Flight" at the bottom of the interface.

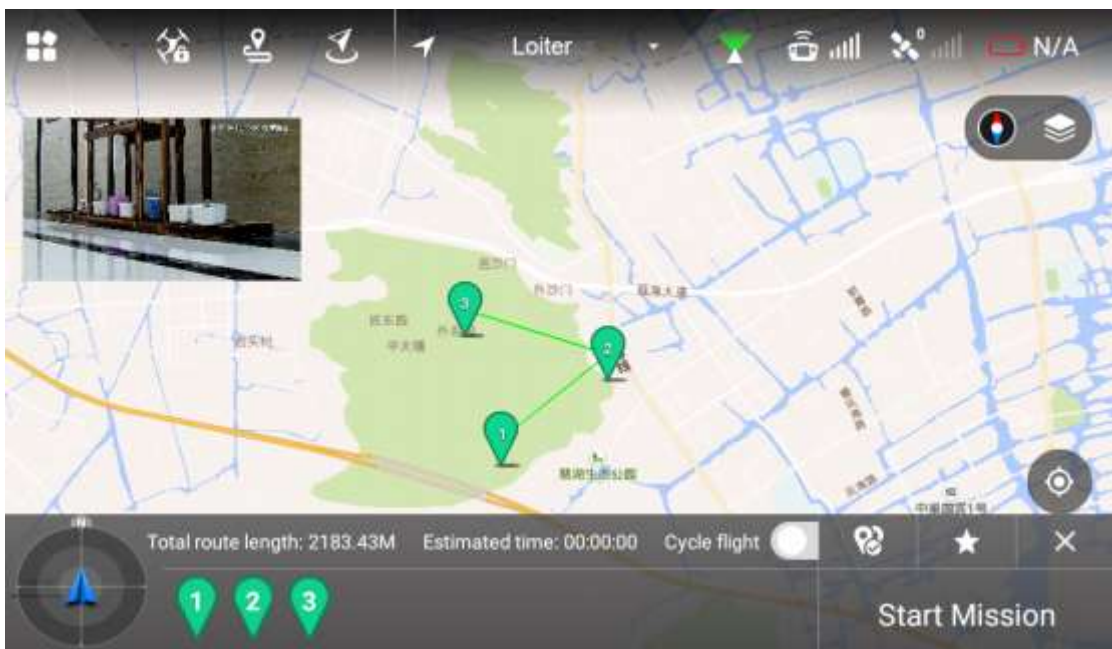

Figure 4-16

Step 2 Click the map and the position can be set as waypoint; several waypoints can be connected together and form a route.



Check total route length, estimated flight time and set "Cycle Flight" at the bottom of the interface.

Step 3 Click waypoint and it will become red. Waypoint setting interface will display on the right of the interface, as shown in Figure 4-17.

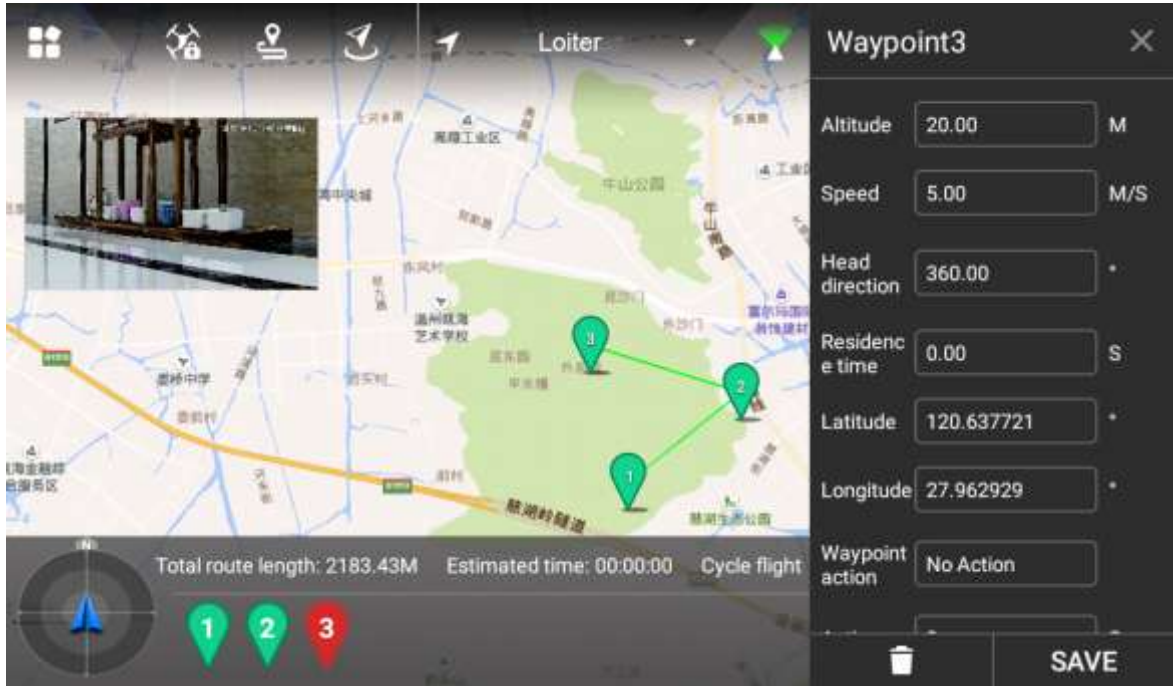

Figure 4-17

Step 4 Set waypoint parameters. Please refer to Table 4-1 for more details.

| Parameter | Note |
|------------------------|--|
| Altitude | Set flight altitude of waypoint. |
| Speed | Set flight speed of waypoint |
| Head direction | Set head direction of waypoint according to requirement during flight. |
| Residence time | Set hovering time after the aircraft reaches a waypoint. |
| Latitude and longitude | <ul style="list-style-type: none"> Automatically acquire latitude and longitude of the waypoint when adding the waypoint. Manually set waypoint latitude and longitude. Waypoint position will skip to manual setting point after setting is done. |
| Waypoint action | <ul style="list-style-type: none"> No action: it is not to set waypoint action. Shutter: it will take photos after the aircraft arrives at the waypoint. |
| Action cycle | <ul style="list-style-type: none"> Action cycle setting is invalid when the waypoint action selects "No Action". When waypoint action selects "Shutter", input time. The aircraft arrives at the waypoint and it will take a photo after a period of time. |
| | <p>Action cycle shall be less than or equal to residence time.</p> |

Table 4-1

Step 5 Click "Save" to make configuration valid.



Click  to set waypoint parameters in batches. Meanwhile, it can modify or delete several waypoints.

Step 6 Click  to input mission name, click "Save" and you can check saved flight missions in the list.



Click  to enter flight mission interface. There are three task operations:

- Add mission: Click the icon to enter setting interface of waypoint, set waypoint flight mission and save it according to actual requirements.
- Download mission: Click the icon to automatically download the currently saved flight route. You can modify the waypoint according to actual requirement and save it into the remote control.
- Select mission: Click the icon and select the mission on the interface, select one or more, delete mission.

4.3.2.2 Point of Interest

Step 1 Select "Point of Interest" and enter the setting interface, as shown in Figure 4-18.

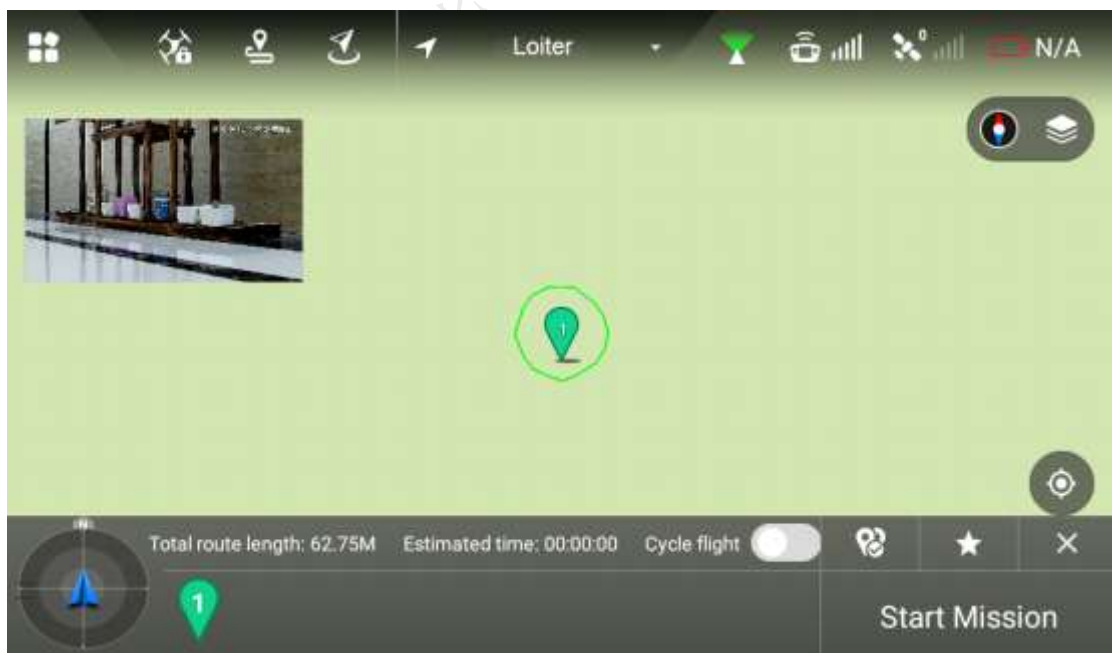

Figure 4-18

Step 2 Click the map and the position can be set as point of interest.

Step 3 Click point of interest, the point icon will become red. Settings interface of interest point will be displayed on the right of main interface, as shown in Figure 4-19.

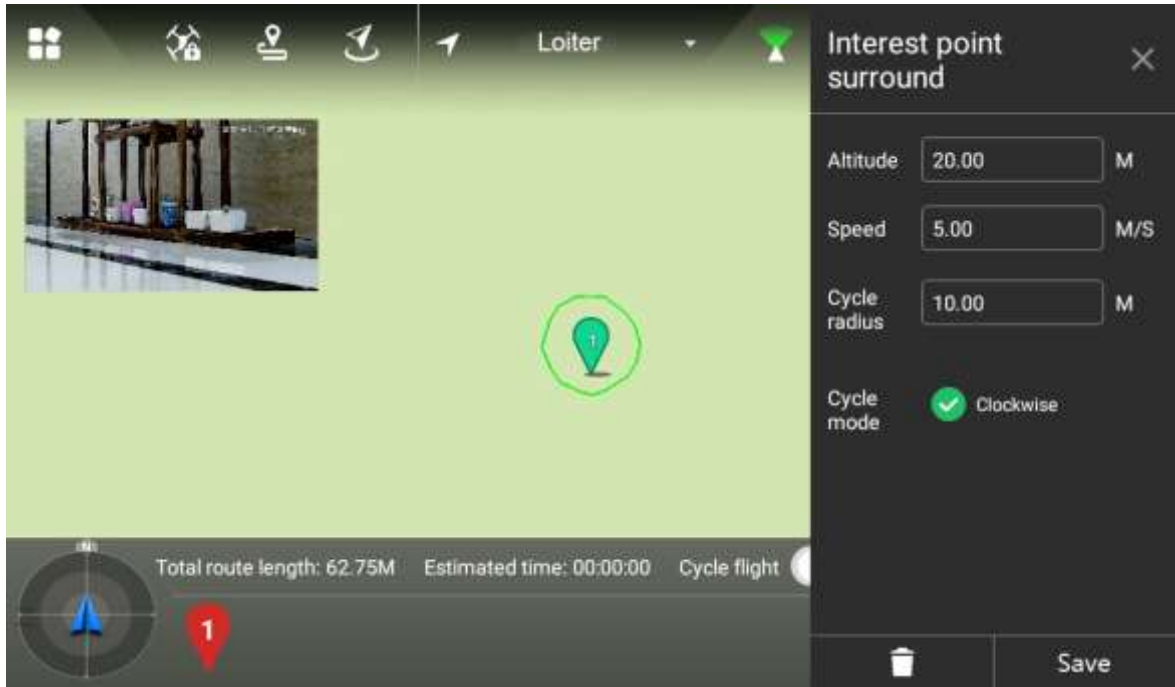

Figure 4-19

Step 4 Set the parameters of interest point. Please refer to Table 4-2 for more details.

| Parameter | Note |
|--------------|---|
| Altitude | Set flight altitude of interest point. |
| Speed | Set flight speed of interest point. |
| Cycle radius | Set flight radius of aircraft flying around interest point. |
| Cycle mode | Select the flight direction of aircraft flying around interest point, clockwise optional. |

Table 4-2

Step 5 Click "Save" to make configuration valid.



Note

Set one interest point only for each flight mission.

Step 6 Click  to input mission name, click "Save" to save flight mission.

4.3.3 Intelligent Locking Mode

Step 1 Click  and it will pop out a dialog box. Select locking mode of the aircraft.

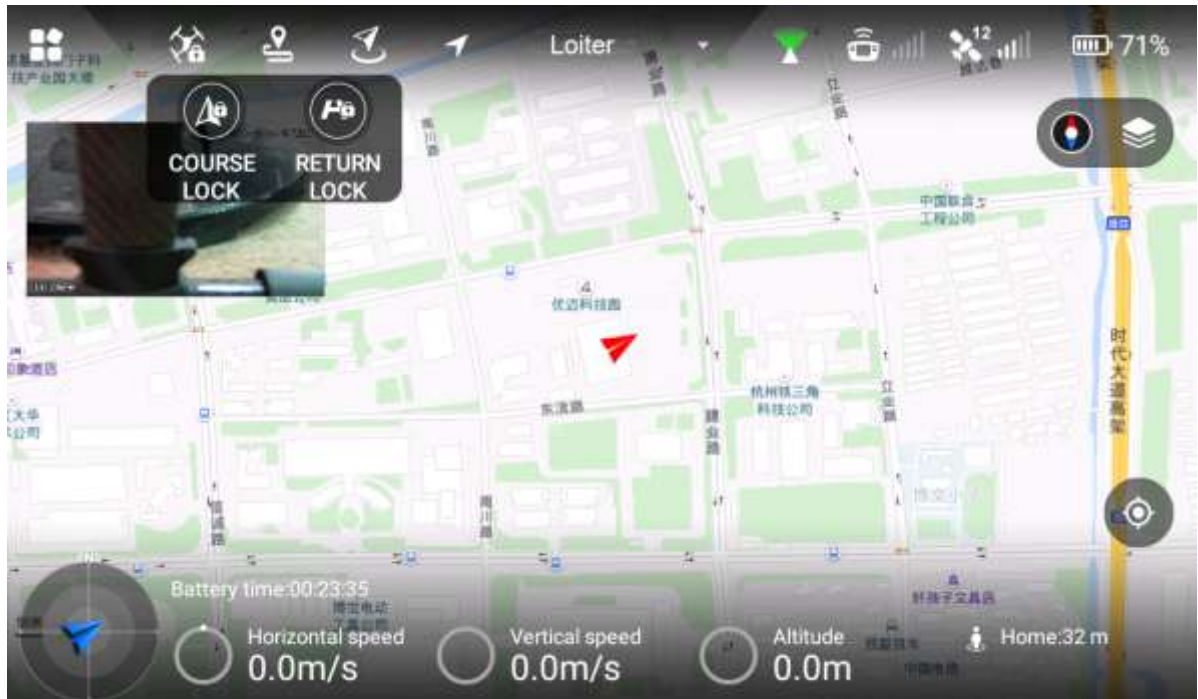

Figure 4-20

There are two types of intelligent locking modes, namely course lock and return lock.

- Course lock: Click it to lock the power-on head direction as its forward direction. During the following flight process, the aircraft course has nothing to do with the head direction; the aircraft will always move forward according to the locked head direction.
- Return lock: Click it and the aircraft course has nothing to do with the head direction. Always take the straight line direction far away from HOME point as forward direction and the straight line direction close to HOME point as backward direction.

If both modes are canceled: the aircraft head direction is forward direction.

Step 2 Click "Return Lock" and the icon becomes yellow, and it will prompt "Return Lock Enabled", as shown in Figure 4-21.

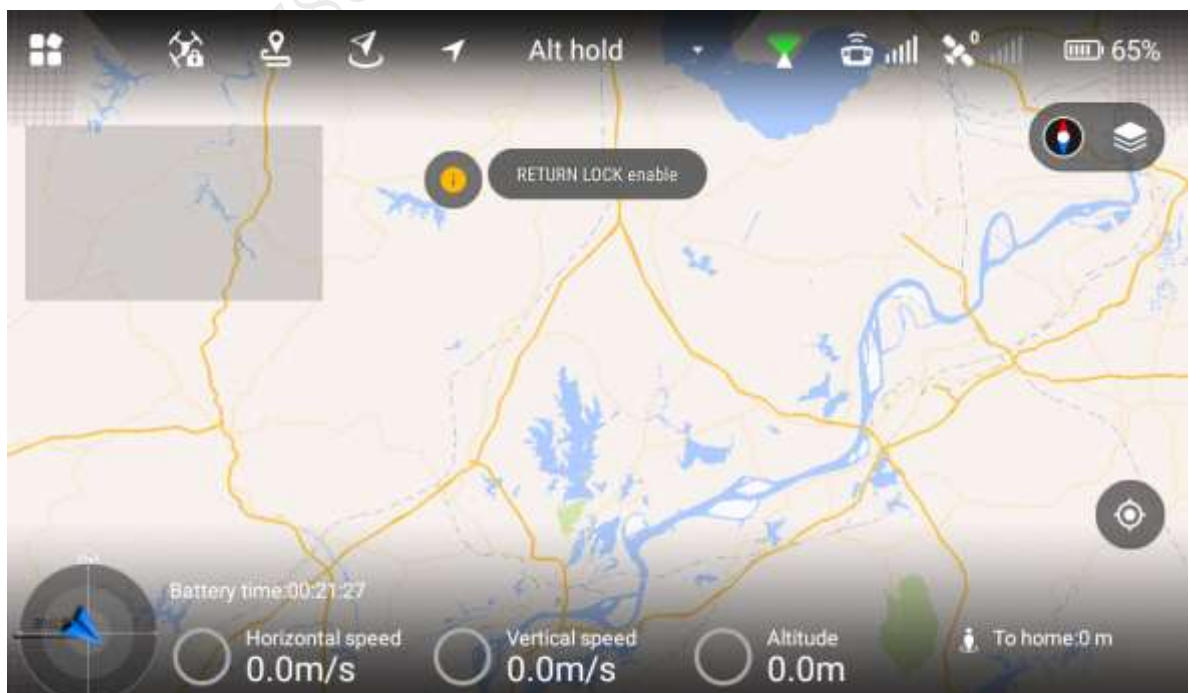

Figure 4-21

Click "Course Lock" and the icon becomes yellow, and it will prompt "Course Lock Enabled".

4.4 Intelligent Protection Mechanism

4.4.1 Low Battery

There are totally three prompts of aircraft low battery for the remote control, and each prompt is more serious than the previous one.

- Level-one low battery, remote control prompt message: "Low Voltage Alarm", along with alarm sound.
- Level-two low battery, remote control prompt message: "Serious low voltage home", along with alarm sound. First ascend to 120m, return to HOME point and then descend. At this time, it is OK to suspend low voltage home (cancel button appears on App, or suspend it by switching the mode of remote control).
- Level-three low battery, remote control prompt message: "Serious low voltage landing", along with alarm sound. Meanwhile, the aircraft triggers landing mode.



Note

After suspending low voltage home, level-three low battery alarm will be triggered if it continues to fly or fly in some harsh environment.

4.4.2 Out of Control

- The aircraft may run into the following uncontrollable situations:
 - ◇ The aircraft or remote control antenna is damaged, and it fails to receive and send signals.
 - ◇ Intensive magnetic field arises in ambient environment, which interferes the aircraft and remote control.
- Solutions:
 - Out of control auto return: ascend the aircraft to 120m first and then return to HOME point.

4.4.3 Electronic Fence

4.4.3.1 Fence Area Settings

Draw an area of electronic fence.

Step 1 Select "Settings > Flight Control Settings > Fence Settings". The system will display the interface of "Fence Settings", as shown in Figure 4-22.

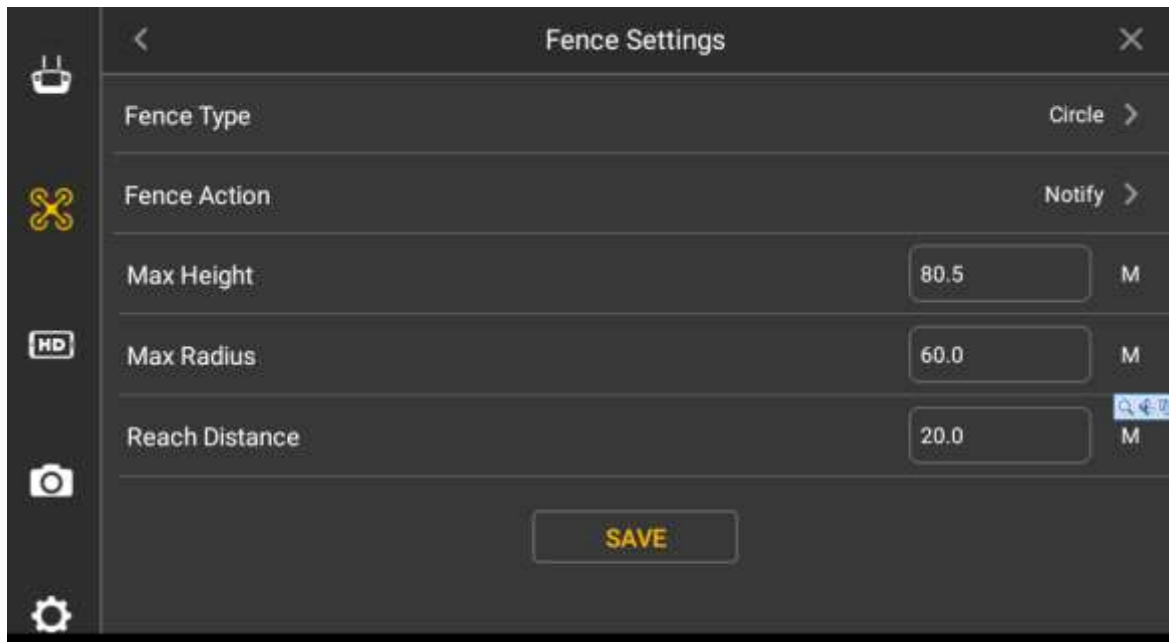

Figure 4-22

Step 2 Select "Fence Type".

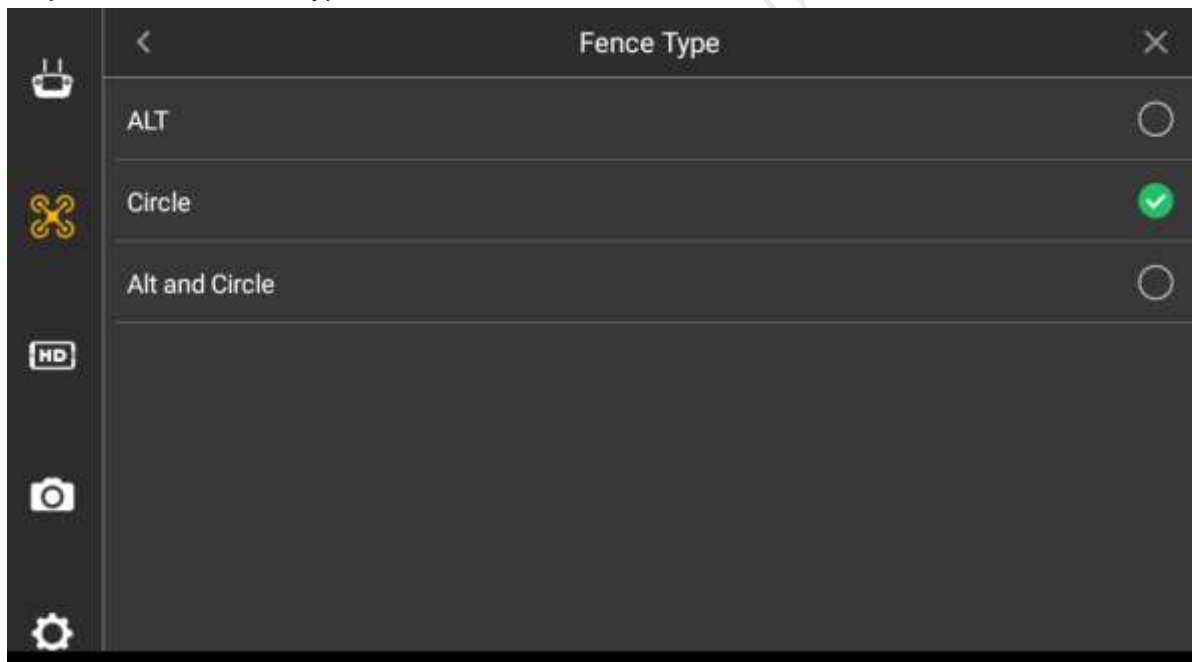

Figure 4-23

- ALT (Limited altitude): limit the max. flight altitude of the aircraft, but there is no limit to the flight distance.
- Circle: Take HOME point as circle center and the set value as radius. The aircraft is restricted to fly within the circle, and there is no limit to the altitude.
- ALT+ Circle: Take HOME point as circle center and set value as radius. The set height is considered as max. flight altitude, the aircraft is restricted to fly within the cylindrical area.

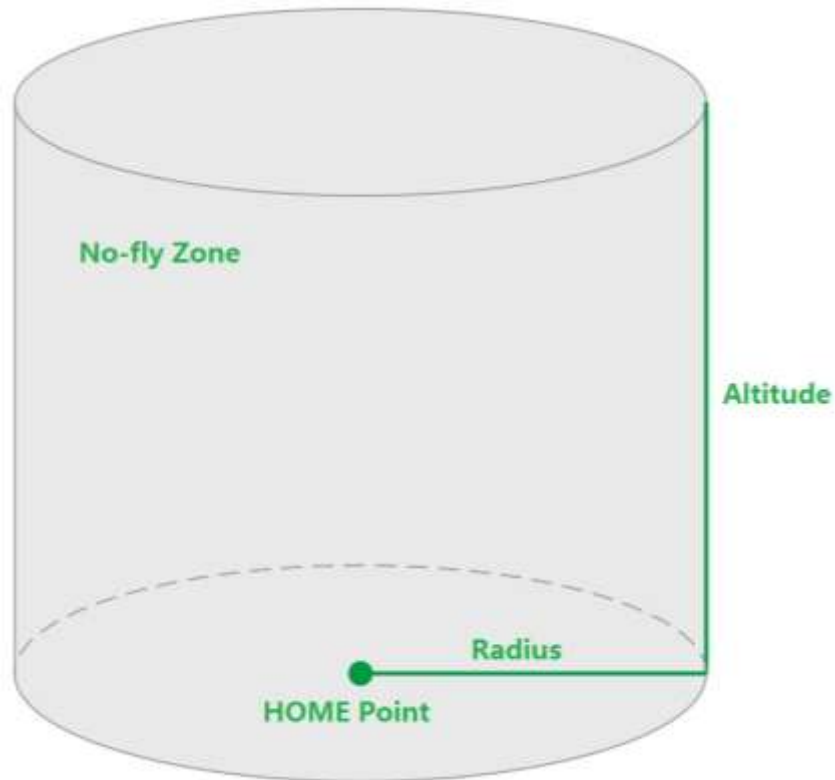

Figure 4-24

Step 3 Set fence action.



Figure 4-25

- Notify only: It only prompts on preview interface, but it doesn't trigger RTH.
- RTL: The aircraft will auto return after it exceeds the fence trigger distance.

Step 4 Set radius and altitude.

Step 5 Set trigger distance.

For example, when the fence type is set as radius + altitude, the radius is set as A meters and altitude is set as B meters, and if the trigger distance is set as C meters, then it will trigger RTH or landing when the aircraft is (A-C) meters away from the HOME point horizontally or flight altitude exceeds (B-C) meters; the aircraft will implement the action of RTH or landing.

4.4.3.2 Enable Electronic Fence

Enable electronic fence after setting fence area.

Select "Settings > Flight Control Settings", enable electronic fence on the right of the "Fence Enable".



Figure 4-26

4.5 Other Parameters

4.5.1 Remote Control Parameter Settings

4.5.1.1 Image Transmission Size

Set resolution, frame rate and max. bandwidth of preview image according to requirements.

Step 1 Select "Settings > Flight Control Settings > Preview Settings" and enter the preview setting interface, as shown in Figure 4-27.

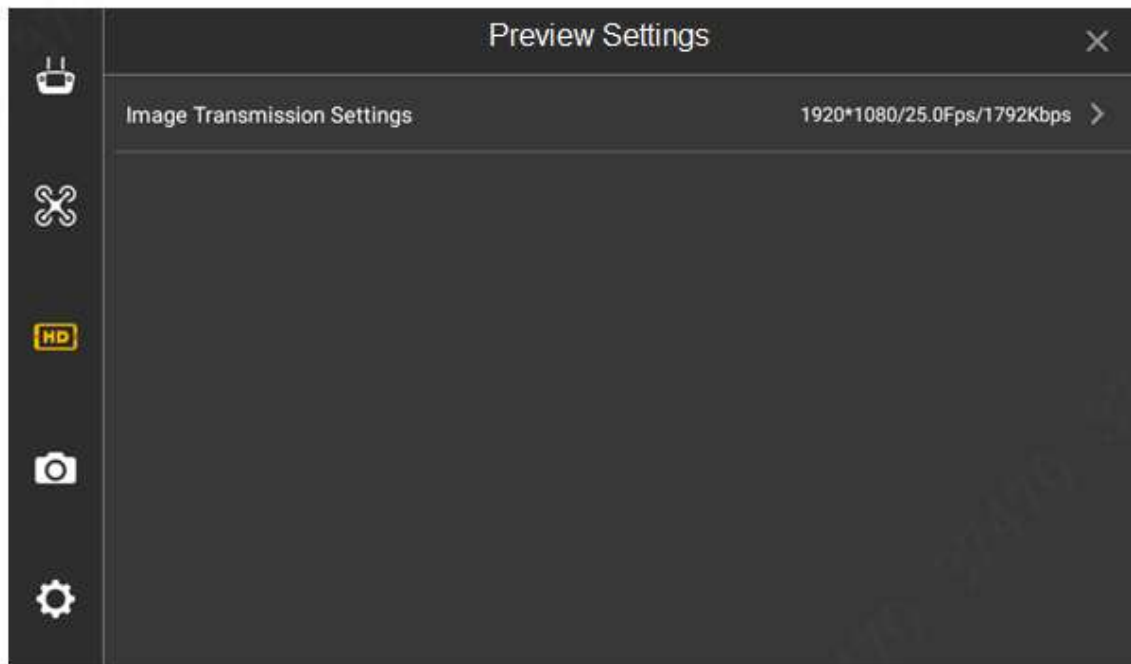

Figure 4-27

Step 2 Select "Image Transmission Settings", and the system will display the interface of "Image Transmission Settings", as shown in Figure 4-28.

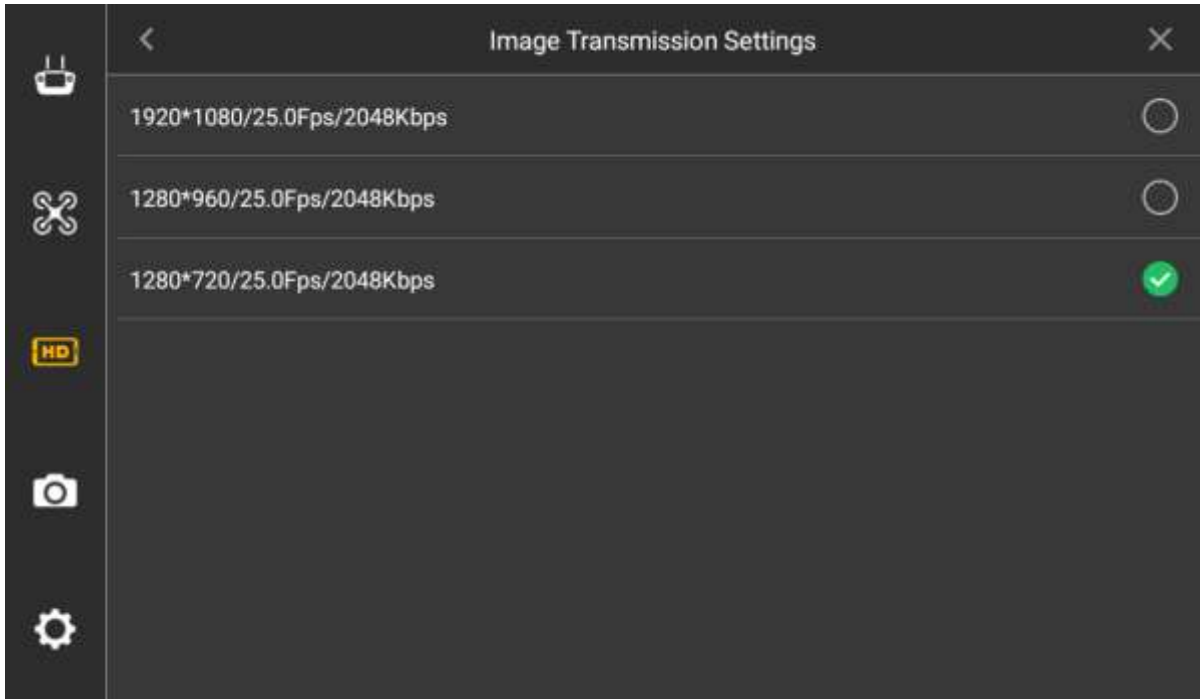

Figure 4-28

Step 3 Image transmission setting is default. Or the user can select according to needs. So far, image transmission setting has been completed.

4.5.1.2 Photo Settings

Set the resolution of the photos taken by PTZ camera according to requirements.

Step 1 Select "Settings > Camera Settings > Photo Settings", and the system will display the interface of "Photo Settings", as shown in Figure 4-29.

Step 2 Click a line, and icon at the end of the line becomes green and checked, which makes it valid immediately.

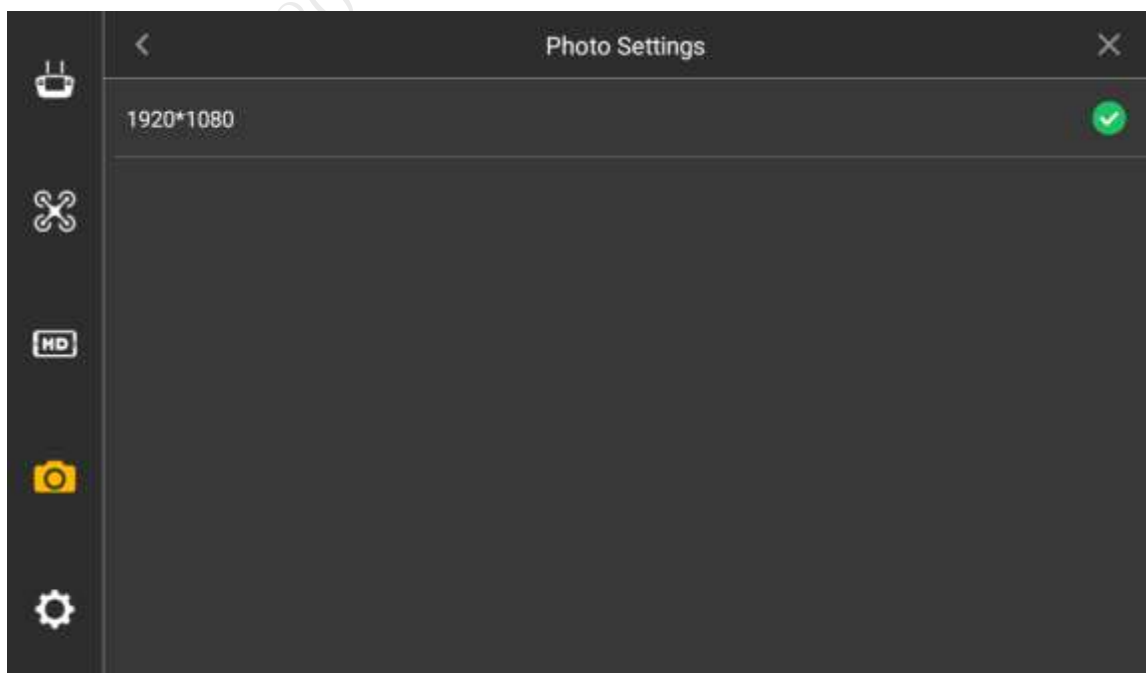

Figure 4-29

4.5.1.3 Video Settings

Set the resolution, frame rate and max. bandwidth of the video recorded by PTZ camera.

Step 1 Select "Settings > Camera Settings > Video Settings", and the system will display the interface of "Video Settings", as shown in Figure 4-30.

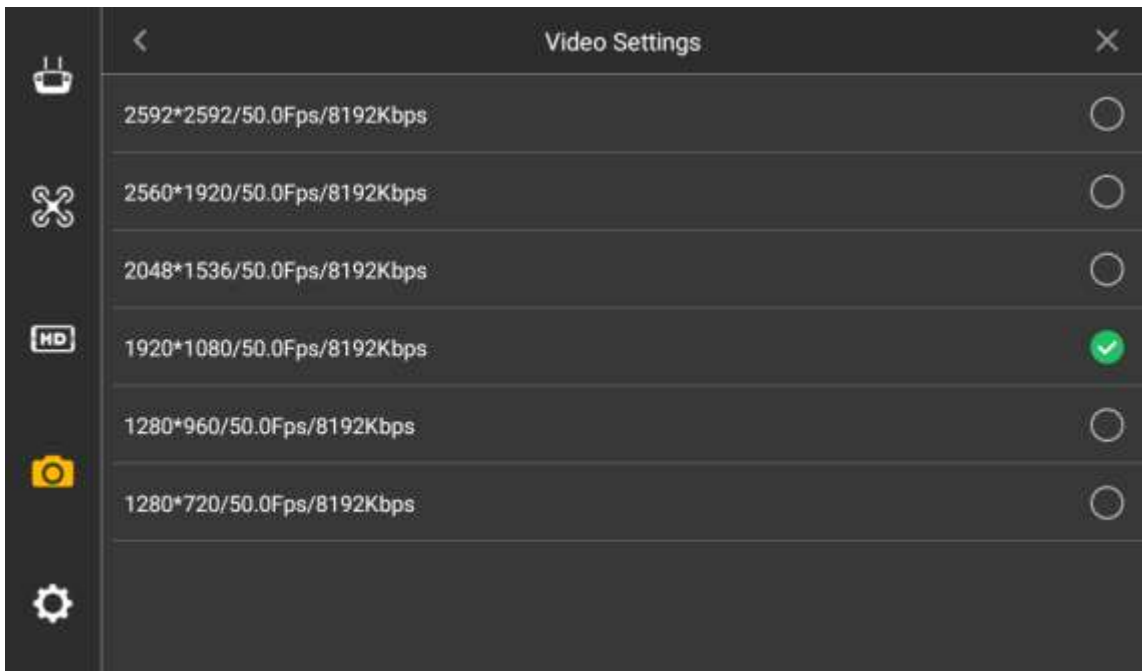

Figure 4-30

Step 2 Click a line, and icon at the end of selected parameter line becomes green and checked, which makes it valid immediately.

4.5.1.4 Image Settings

Set the brightness, contrast, saturation, sharpness and gamma value of the preview image of PTZ camera.

Step 1 Select "Settings > Camera Settings > Advanced Settings > Image Settings", and the system will display the interface of "Image Settings", as shown in Figure 4-31.

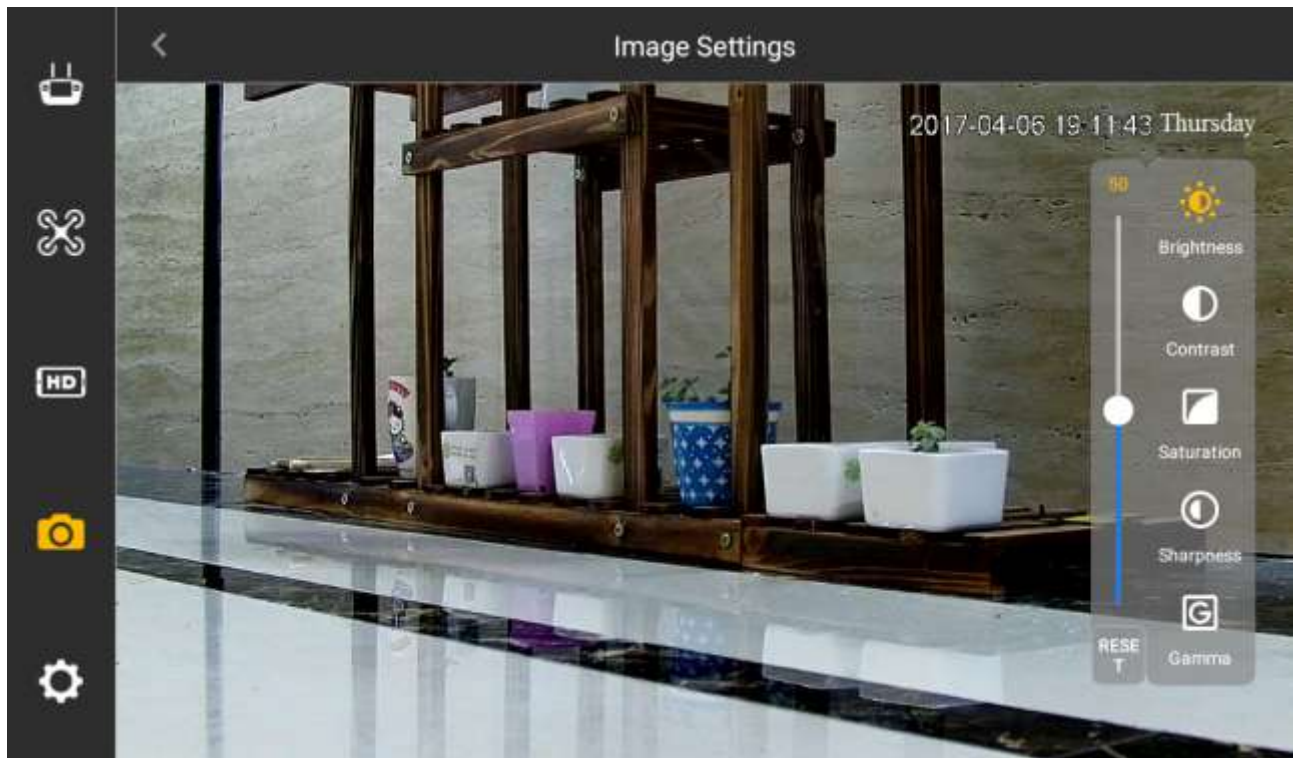

Figure 4-31

Step 2 Set the parameter items on the right of the interface.

- **Brightness:** Adjust the overall brightness of the image; adjust the value when the overall brightness of image is too bright or too dark.
- **Contrast:** Adjust the image contrast. Adjust the value when overall brightness is proper but the image contrast is not enough.
- **Saturation:** Adjust the bright degree of the color, which will not affect the overall brightness of the image.
- **Sharpness:** Adjust the image resolution and sharpness degree of image edge.
- **Gamma:** Optimize brightness and contrast, and adjust slight brightness and darkness layer of the image.

Set parameter value by sliding, and it is valid immediately.

4.5.1.5 Brightness Adjustment

Set the overall display brightness of the remote control touch screen.

Select “Settings > General Settings > Other > Brightness”, and the system will display the interface of “Panel Settings”, as shown in Figure 4-32.

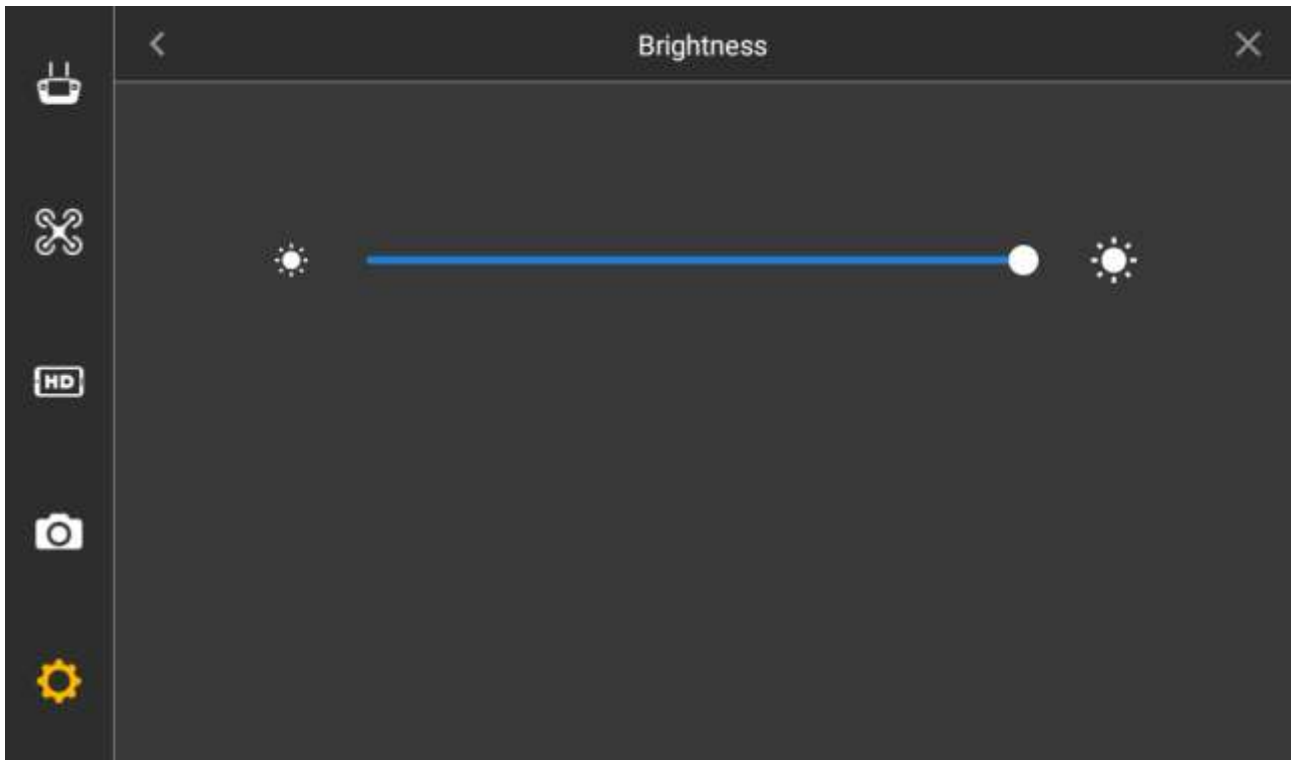

Figure 4-32

4.5.2 Ground Station Parameter Settings

4.5.2.1 UI Settings

Set font, style, work mode and language of operation interface of ground station.

Step 1 Select “Settings > Aircraft Settings > Settings > UI Config”, and the system will display the interface of “UI Config”, as shown in Figure 4-33.

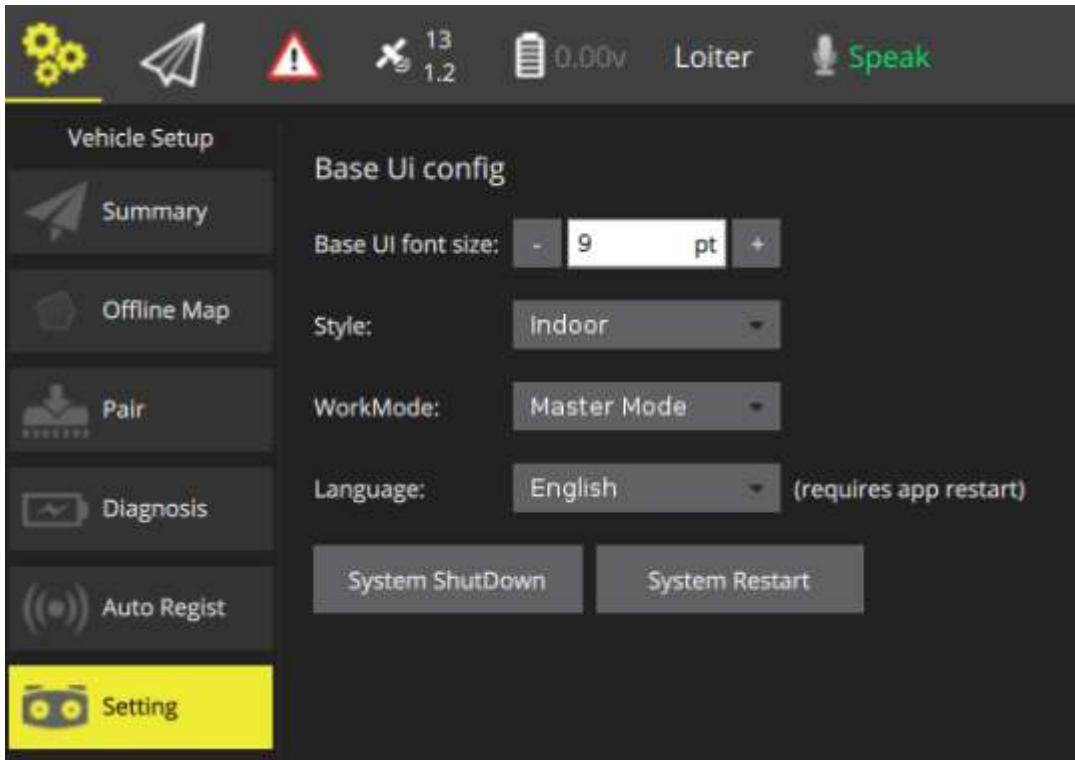

Figure 4-33

Step 2 Select “Font Size”, decrease and increase font size of ground station interface with



Step 3 Select “Style” to select from “Indoor” and “Outdoor” in the pull-down menu.

Step 4 Set work mode of ground station, including “Master Mode” and “Slave Mode”.

- Master mode: transmit the ground station data to remote control.
- Slave mode: transmit the remote control data to ground station.

In slave mode, there are no pair and diagnosis settings, as shown in Figure 4-34.

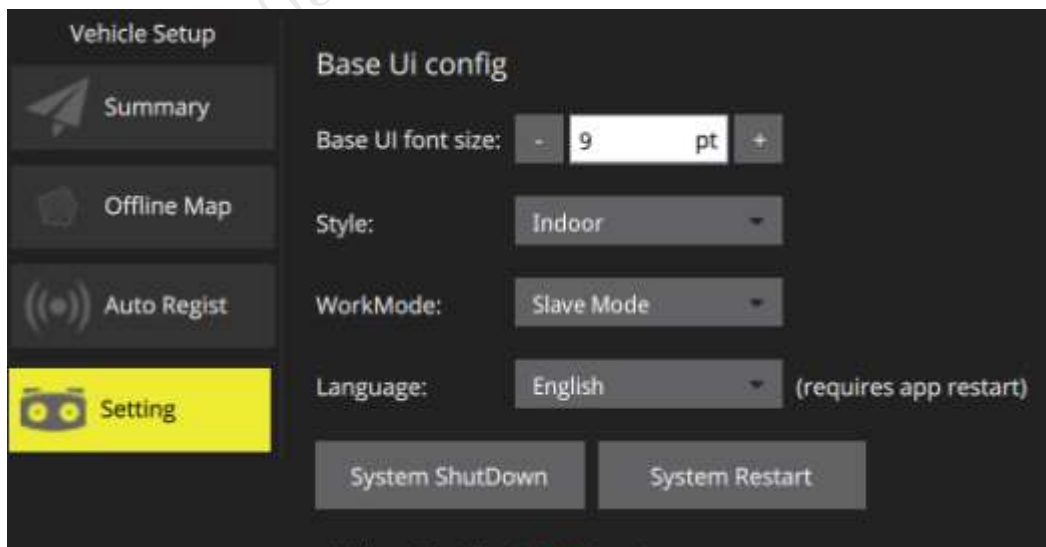

Figure 4-34

Step 5 Select “Language”, including “Chinese” and “English”.



The device shall reboot to make the language take effect.

4.5.2.2 Auto Registration

Connect the ground station with network cable. With auto registration, the ground station transmits the received video data to all platform surveillance systems in a real-time way.

Step 1 Select “Settings > Aircraft Settings > Auto Registration”, and the system will display the interface of “Auto Registration”, as shown in Figure 4-35.

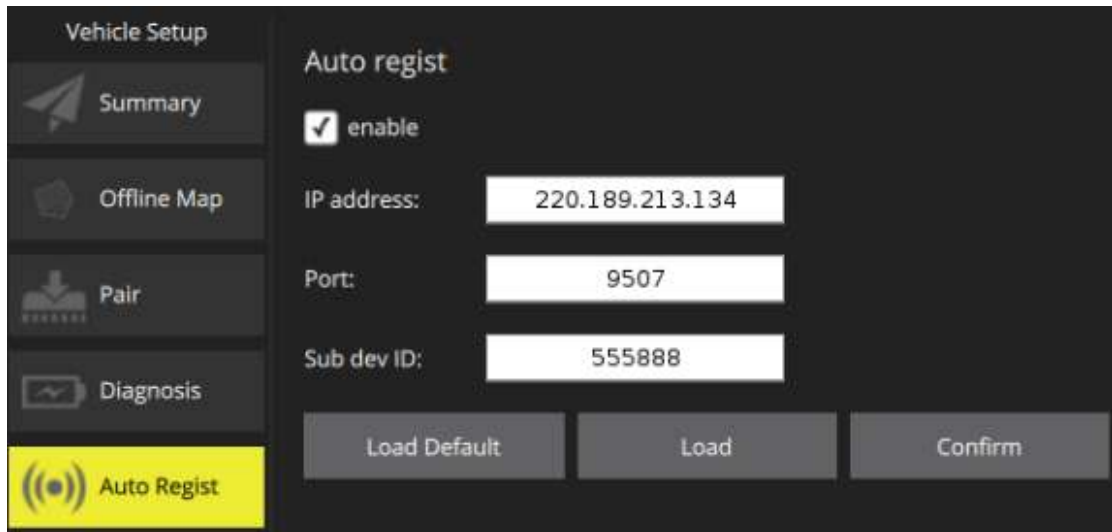

Figure 4-35

Step 2 Select “Enable” to input IP address, port number and device ID.

Step 3 Select “Confirm” to complete registration.



Note

- Click “Load Default”, and the device restores default configurations.
- Click “Load” to view the latest settings.

5. End Flight



Note

This chapter elaborates the operation steps after aircraft landing.

Please operate according to the following flows to make sure normal application for the next time. Some of the operations are unnecessary. Please select according to the actual situation.

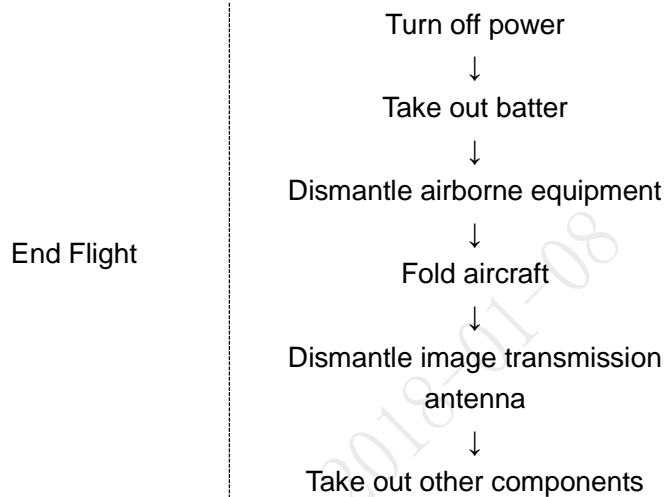

Figure 5-1

5.1 Turn off Power



Caution

It has to turn off the aircraft power first, and then turn off the power of remote control and ground station.

Step 1 Find the power switch below the aircraft empennage and short press it once, then long press it for 3 seconds. It means that the aircraft power has been turned off when the built-in indicator light of the switch is off.

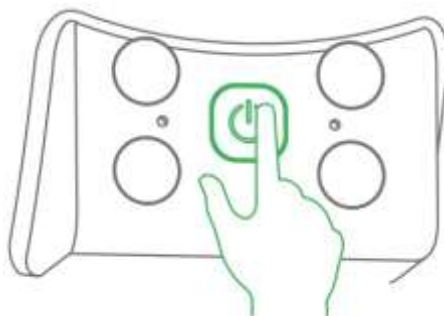

Figure 5-2

- Step 2 Move the power switch on the rear panel of the remote control to the other side. It means that remote control power has been turned off when the indicator light of remote control front panel is off.



Figure 5-3

- Step 3 Short press the image transmission switch of the ground station. It means that the image transmission of ground station is turned off when the built-in red indicator light is off.

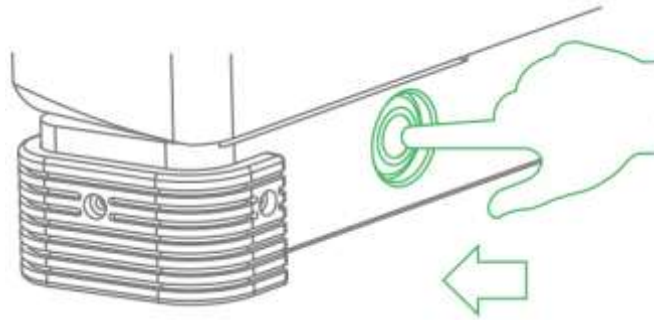

Figure 5-4

- Step 4 Turn off the operating system on the ground station. It means that the operating system is turned off when the ground station screen is off.

5.2 Remove Aircraft Battery

- Step 1 Move the buckle on the aircraft cover and open the cover, as shown in Figure 5-5.

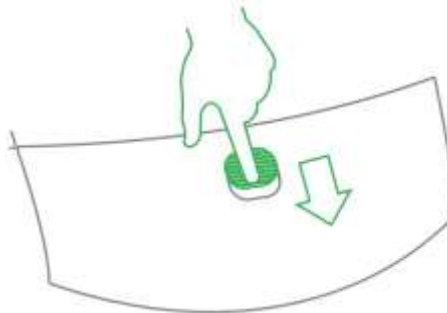

Figure 5-5

- Step 2 Unfasten the fixing band and take out the battery, as shown in Figure 5-6.

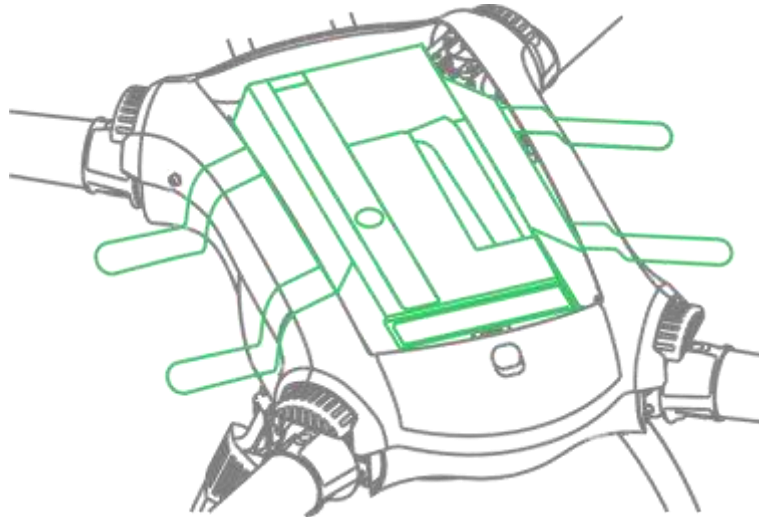

Figure 5-6

5.3 Dismantle Airborne Equipment

Step 1 Loosen 4 mounting screws, as shown in Figure 5-7.

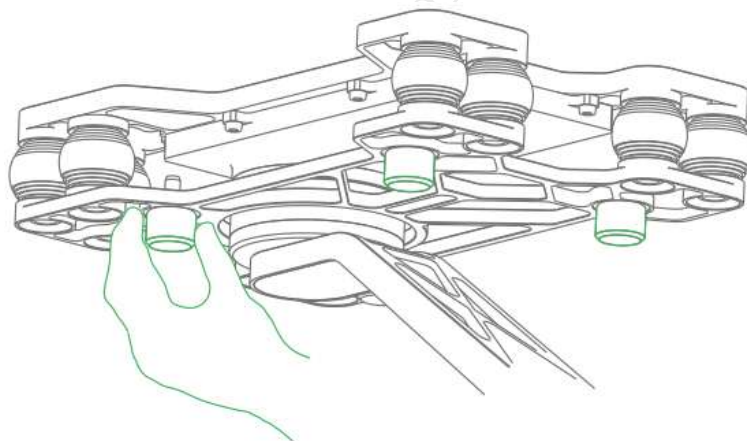

Figure 5-7

Step 2 Dismantle PTZ camera.

5.4 Fold Aircraft

Step 1 Press the spring fastener on both sides of the propeller center, and remove the propeller, as shown in Figure 5-8.

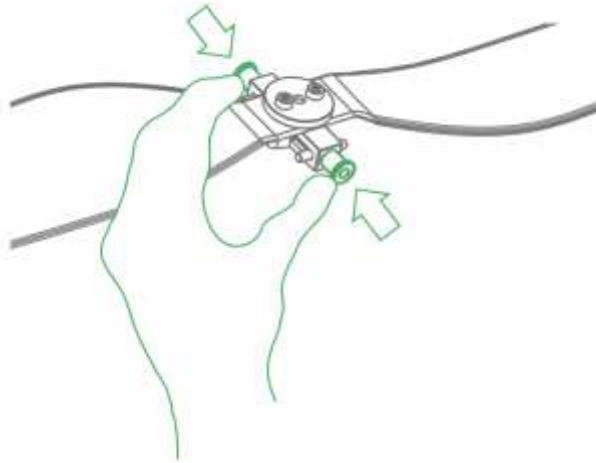

Figure 5-8

Step 2 Fold the antenna and make it close to the aircraft arm, as shown in Figure 5-9.

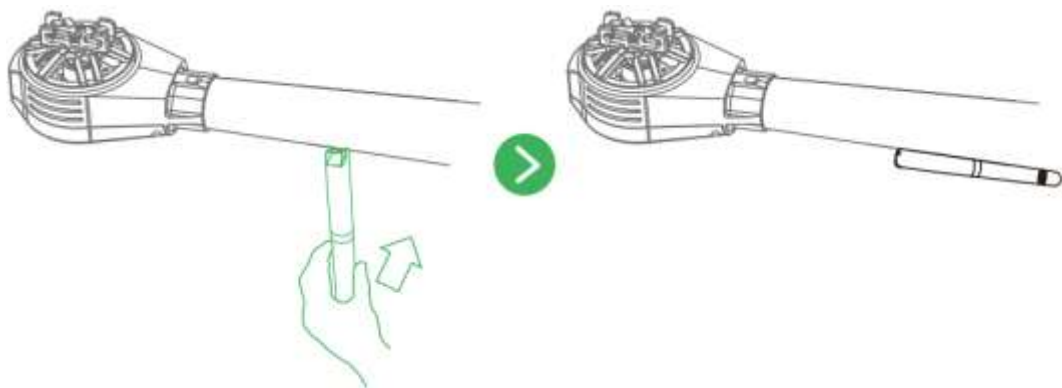

Figure 5-9

Step 3 Hold the aircraft arm with hands, press the button to fold the arm downward and make it close to the landing gear, as shown in Figure 5-10.

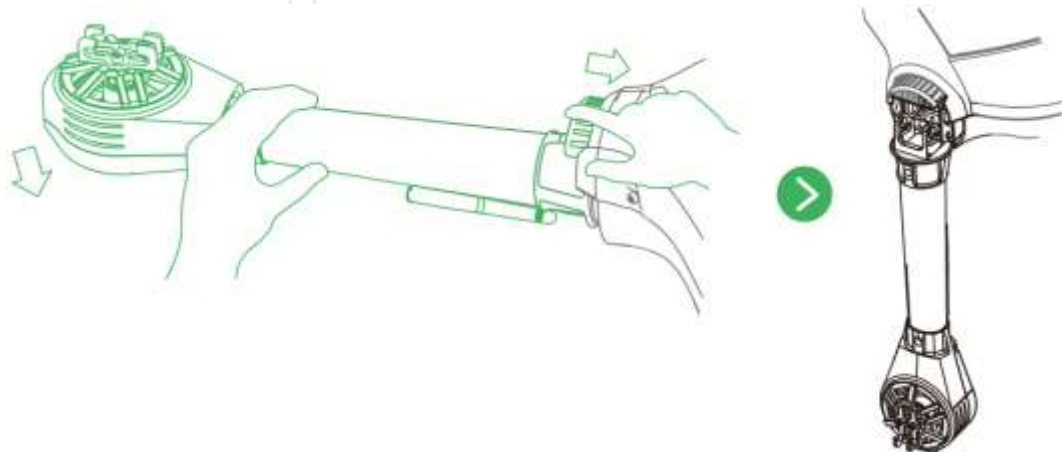

Figure 5-10

5.5 Dismantle Image Transmission Antenna

Step 1 Take down antenna feeder.

Step 2 Take out the image transmission antenna from the tripod and unfold it into two sections.

Step 3 Put away the tripod.

5.6 Copy Video of Camera SD Card

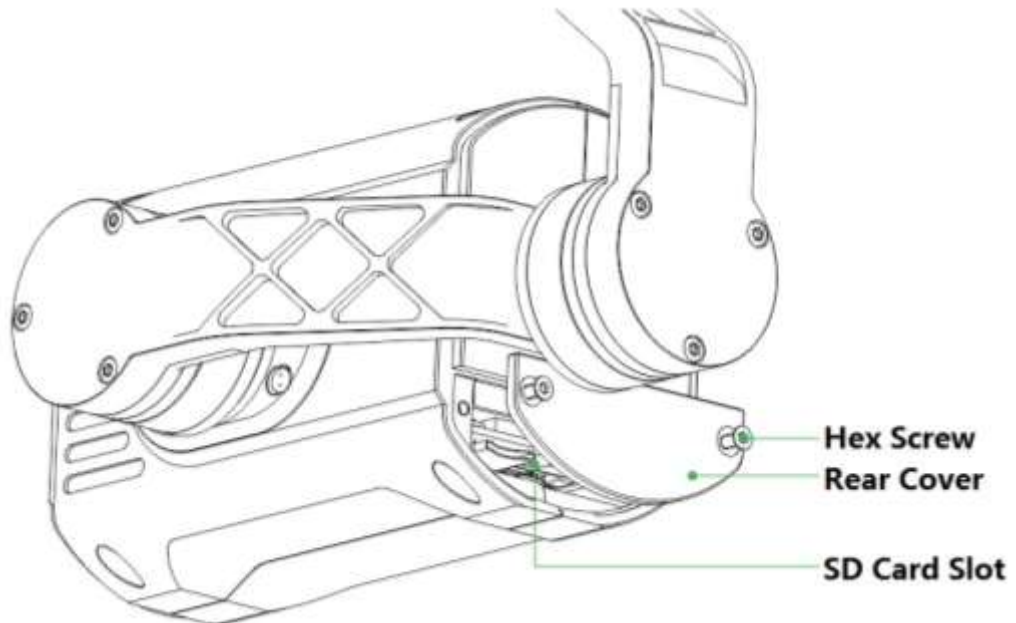

Figure 5-11

- Step 1 Take out T8 screwdriver, loosen 2 screws on the rear panel of the camera and take down the rear cover.
- Step 2 Slightly press SD card and it will pop out. Pull out the SD card.
- Step 3 Insert the SD card into the card reader, and connect the card reader to computer.
- Step 4 Copy the SD card video into the computer via card reader and save it.

5.7 Remove Other Components

Fold remote control antenna: Fold the antenna and make it close to the front panel of remote control.

6 Upgrade and Update

This chapter elaborates upgrade methods of the device.

6.1 Aircraft Firmware Update



- The aircraft firmware is updated with remote control.
- The aircraft, ground station and remote control have to be enabled and connected during firmware update, which is to make frequency matched.



Don't upgrade the firmware during flight!

- Step 1 Insert the SD card with firmware update package into the SD card slot of the remote control.
- Step 2 Select "Remote Control > Settings > General Settings". It will display the interface of "Firmware Update", as shown in Figure 6-1.



Figure 6-1

- Step 3 Select "Update Now" and it will automatically update and display update progress.



If SD card isn't inserted, it will display "The Latest Version" on the right of "Firmware Update".

6.2 Remote Control Update

6.2.1 APP Update

- Step 1 Insert the SD card with APP update package into the SD card slot of the remote control.
- Step 2 Select "Settings > General Settings". It will display the current APP version number or update software on the right of "APP Update", as shown in Figure 6-2.



Figure 6-2

It doesn't need to update when it displays the version number, and it means that the current APP is the latest version.

Update is available when it displays "Update Now".

Step 3 Select "Update Now" and it will automatically update and display update progress.

6.2.2 Download and Update Offline Map of Remote Control

Store in the SD card the offline map data package which needs to be downloaded, and transmit it to the remote control via SD card; then it will display update prompt on the corresponding interface.

Step 1 Select "Settings > General Settings > Other Settings > Offline Map". The system will display the interface of "Offline Map", as shown in Figure 6-3.

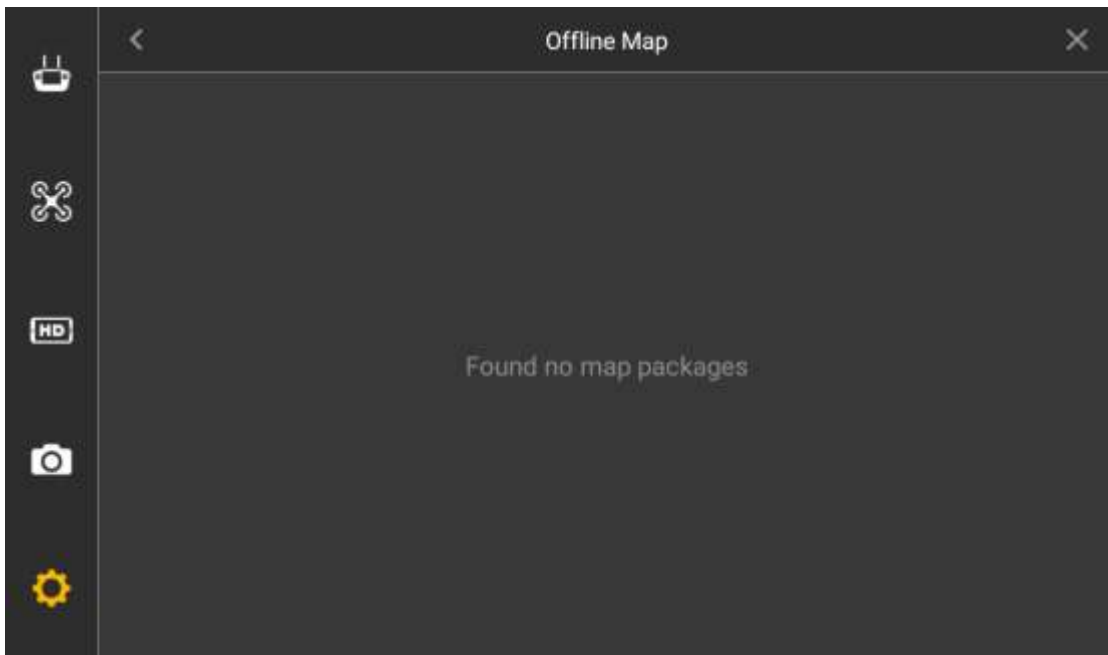

Figure 6-3

Step 2 Insert the SD card with offline map data package into the SD card slot of the remote control, so it will automatically update offline map interface and display the city list whose maps are stored in the SD card, as shown in Figure 6-4.

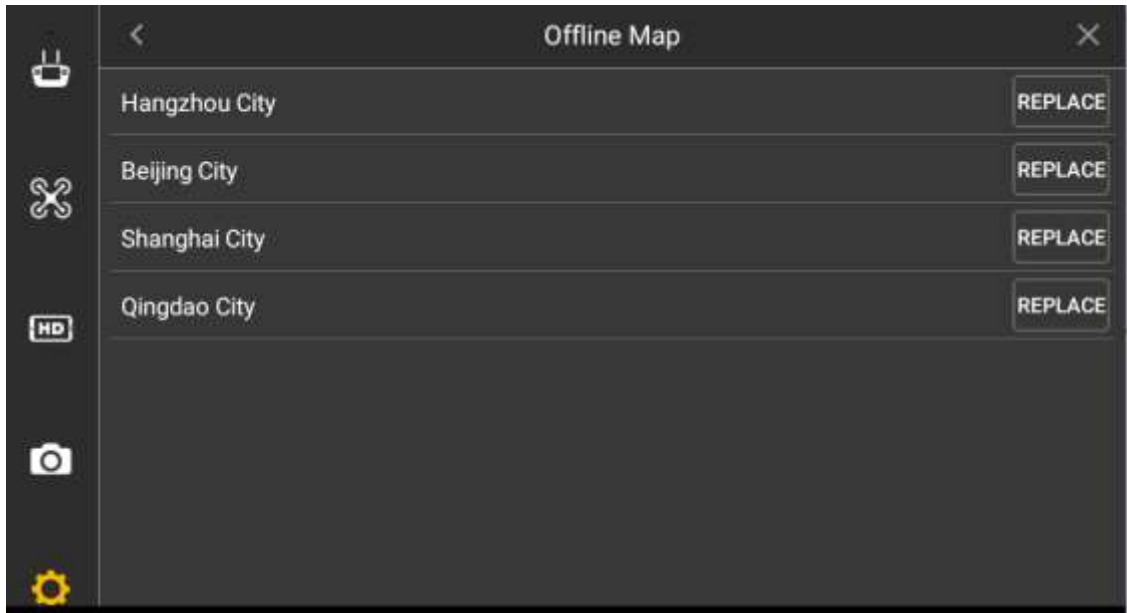

Figure 6-4

Step 3 Select the city which needs to be updated, click "Replace" button to update the city map immediately, as shown in Figure 6-5. After the update is completed, the interface displays “Beijing City map is imported successfully. Please reboot APP”.

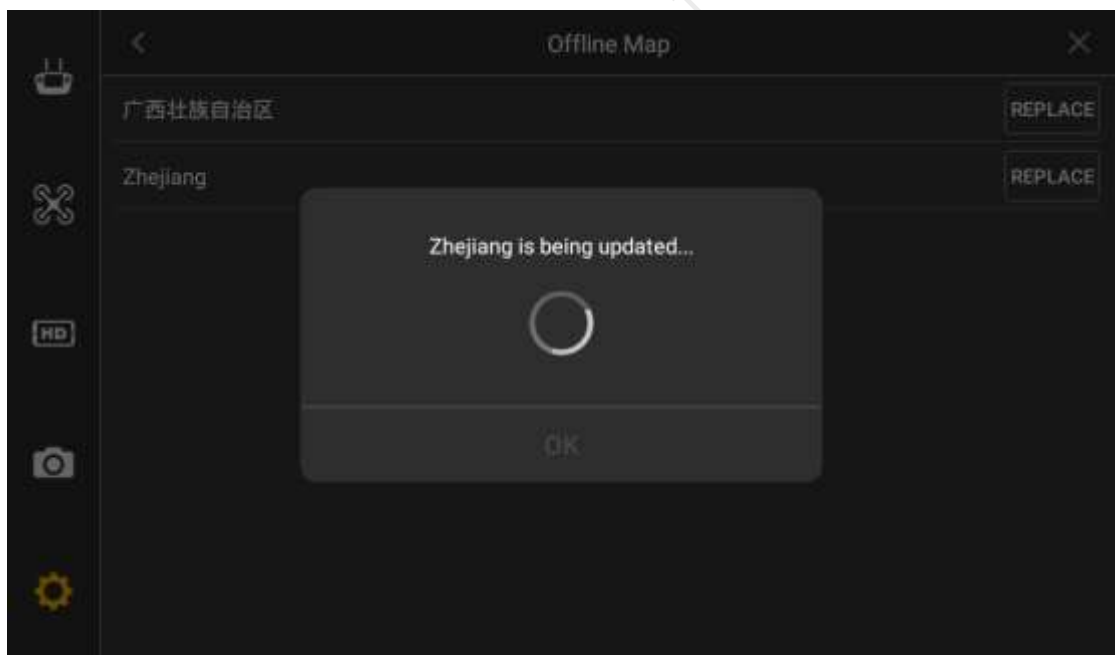

Figure 6-5

Step 4 Click "OK".

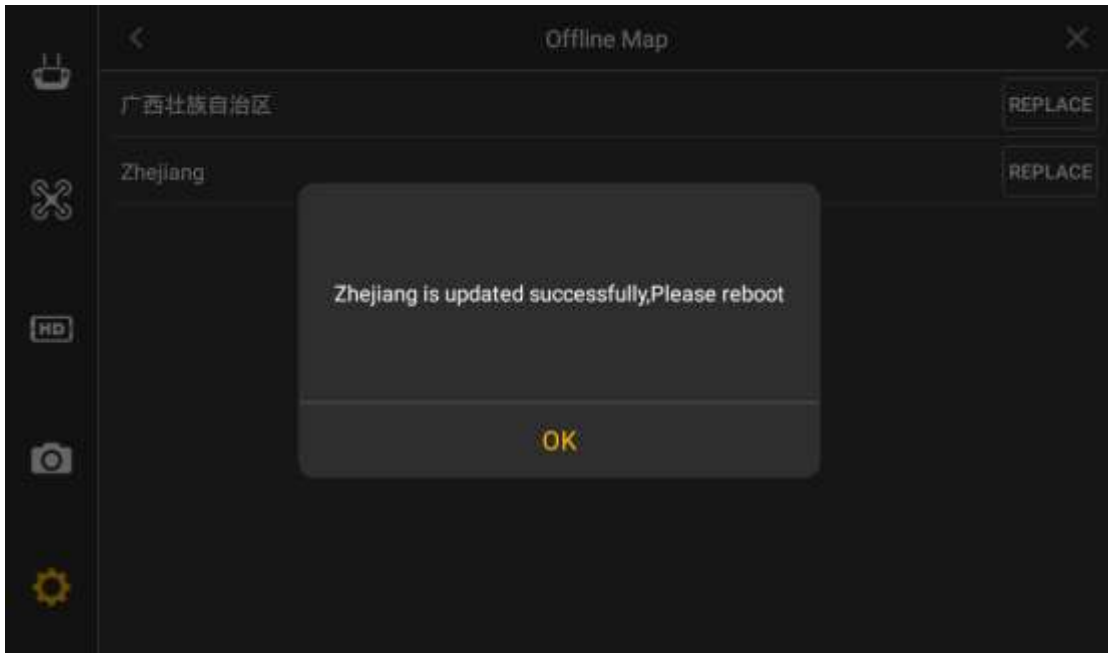

Figure 6-6

- Step 5 Select "Settings > General Settings", and click "Reboot" at the bottom of the interface. The preview interface of remote control map is Beijing City map after it is successfully rebooted.



Note

Every time, replace offline map of one city only.

6.3 Ground Station Update

6.3.1 Ground Station Software Update

- Step 1 Insert the USB flash disk with required software installation package into the USB interface of the ground station.
- Step 2 The system displays the software update prompt, as shown in Figure 6-7.

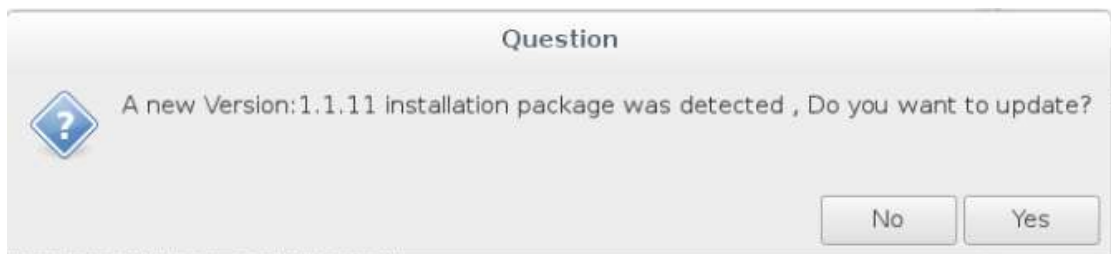

Figure 6-7

- Step 3 Select "Yes" and the ground station will enter auto update. Please select "No" if you don't want to update software.

6.3.2 Ground Station Map Update

- Step 1 Insert the USB flash disk with required map installation package into the USB interface of the ground station.
- Step 2 The system displays the map update prompt, as shown in Figure 6-8.



Figure 6-8

- Step 3 Select "Yes" and the ground station will enter auto update. Please select "No" if you don't want to update.

6.3.3 Ground Station Offline Map



The network has to be well connected when updating offline map.

6.3.3.1 Download Offline Map

Set scale range of the offline map which needs to be downloaded according to the requirement.

- Step 1 Select "Aircraft Settings > Offline Map > Add New Set". The system will display the interface of "Offline Map", as shown in Figure 6-9.

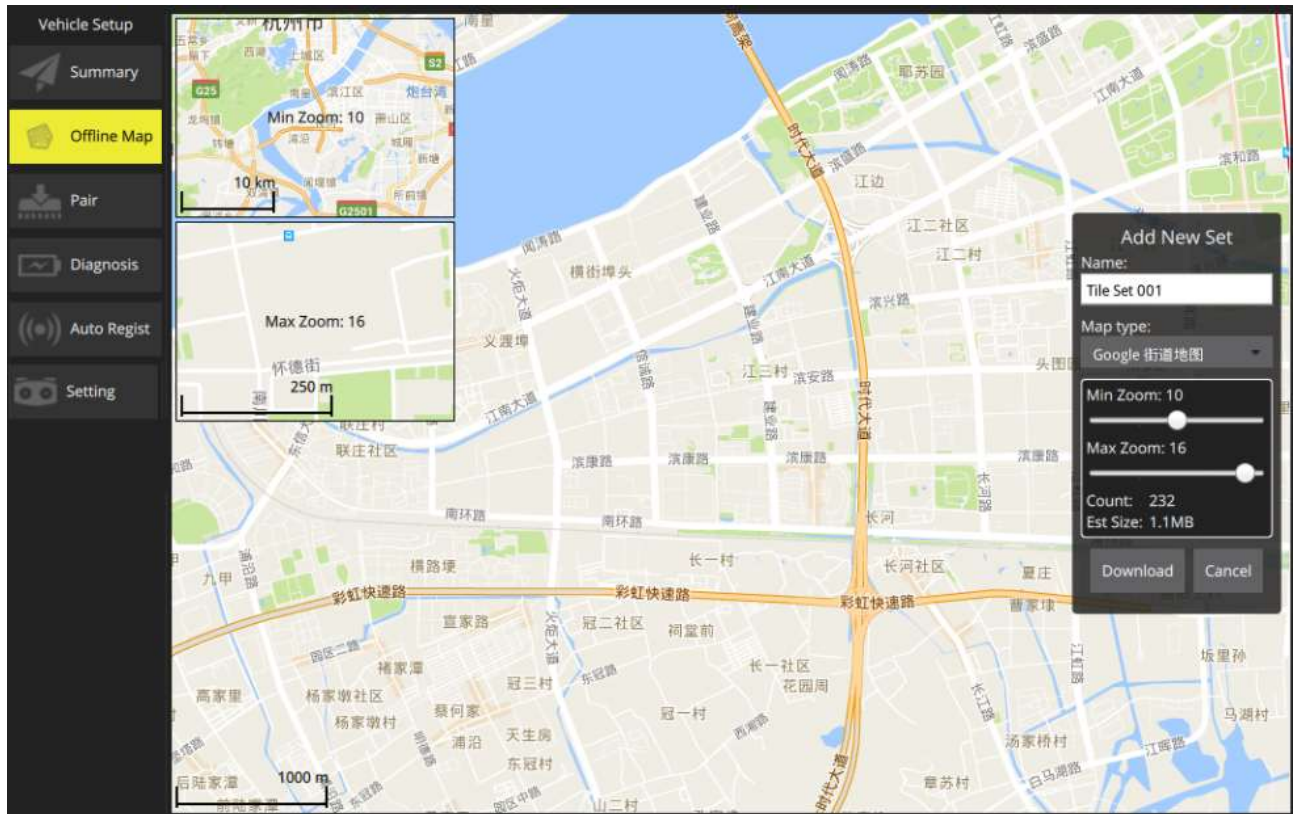

Figure 6-9

Step 2 Set parameters of offline map. Please refer to Table 6-1 for details.



| Parameter | Note |
|----------------|---|
| Name | Input mission name. |
| Map type | Select map type according to actual requirement. |
| Min. zoom | Minimum level value of offline map, ranging from 3 to 17.  Note <ul style="list-style-type: none"> The minimum level value shall not exceed maximum level value. Each level value is corresponding to different map scale. The higher the level value is, the bigger the map scale becomes. |
| Max. zoom | Maximum level value of offline map, ranging from 3 to 17. |
| Count | Set the interval value of max. and min. level; automatically calculate the quantity of pictures.  Note The offline map is the result of several mutually overlaying pictures. |
| Estimated size | Set the interval value of max. and min. level; automatically calculate the internal storage of the map. |

Table 6-1

Step 3 Click “Download” to download the configured offline map.



The size of downloaded offline map is the size displayed by the screen.

View the downloaded offline maps in the “Offline Map” tab.

6.3.3.2 Delete Offline Map

Select “Aircraft Settings > Offline Map”, and click “Offline Map” to enter the setting interface, as shown in Figure 6-10.



Caution

As default offline map of the system, “Default Tile Set” cannot be deleted.



Figure 6-10

| Parameter | Note |
|------------|--|
| Zoom level | Min. and max. level value set by offline map. |
| Total | Set the interval value of max. and min. level; automatically calculate the internal storage of map and quantity of pictures. |

Table 6-2

Click "Delete" to delete the displayed offline map.

6.3.3.3 Set Disk Cache of Offline Map

Set the disk cache of map which needs to be stored.

Step 1 Select “Aircraft Settings > Offline Map”. The system will display the interface of “Offline Map”.

Step 2 Select **Options** on the lower right corner of the page; enter the setting interface of disk cache, as shown in Figure 6-11. Refer to the settings below, and select "Save" to make settings valid.

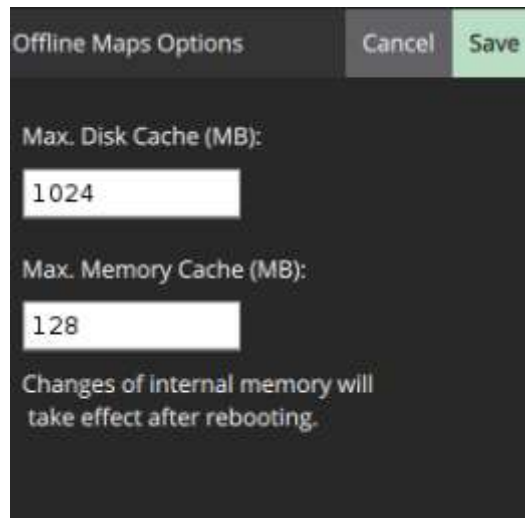

Figure 6-11

| Parameter | Note |
|-------------------|--|
| Max. Disk Cache | Set the max. disk cache, which is 1024 by default. |
| Max. Memory Cache | Set the max. memory cache, which is 1282 by default. |

Table 6-3

Please select "Cancel" to cancel settings.

17803 大華 2018-01-06

Appendix 1 Main Technical Parameters

| Parameter Item | | Parameter Value |
|--------------------------|--|---|
| Model | | Dahua Navigator X820 |
| System | Operating temperature | -20℃~60℃ |
| Environment Adaptability | Operating humidity | Operating humidity is 95%, non-condensation. |
| Aircraft | Wheel base | 940mm |
| | Aircraft type | 4 rotor wings |
| | Mechanical features of arm | Foldable |
| | Landing gear | Retractable and extendable via remote control |
| | Rack weight (except battery and load, only power system) | 3315g |
| | Takeoff weight | 6315g~10500g |
| | Satellite positioning module | GPS |
| | Max. flight altitude | No less than 5000m |
| | Battery | 6S LiPo 22000mAh intelligent battery |
| | Max hovering time | 35min (Mounted with PTZ camera) |
| Power System | Propeller wing material | Carbon fiber |
| | Propeller wing dimension | 18inch×6.5inch |
| | Mechanical features of propeller wing | Quick demount |
| Flight Control | Hovering accuracy (relative accuracy) | <ul style="list-style-type: none"> Horizontal: ±0.2m Vertical: ±0.5m (weaker than gentle breeze) |
| | Wind resistance capacity | 7 wind scale (moderate gale) |
| | Max. attitude angle velocity | <ul style="list-style-type: none"> Course: 150°/s Pitch: 250°/s |
| | Max. attitude angle | 35° |
| | Cruising speed | 10m/s |
| | Built-in function | <ul style="list-style-type: none"> Fixed elevation, fixed point, autonomous cruise and several other flight modes Auto takeoff and landing Low voltage protection LED and ground station APP prompt Auto RTH Preset no-fly zone Electronic fence |
| PTZ | Weight (including load) | 1.1kg |
| | Angle control accuracy | ±0.01° |
| | Max. controllable rotation | <ul style="list-style-type: none"> Course: ±130°/s |

| Parameter Item | | Parameter Value |
|--|---|--|
| Model | | Dahua Navigator X820 |
| | speed | <ul style="list-style-type: none"> ● Pitch: $\pm 130^\circ/s$ |
| | Controllable rotation range | <ul style="list-style-type: none"> ● Course: $\pm 168^\circ$ ● Pitch: -90° to $+45^\circ$ |
| | Installation mechanical feature | Quick mount and demount |
| | Built-in function | <ul style="list-style-type: none"> ● Two working modes: <ul style="list-style-type: none"> ◇ Course follow mode ◇ Attitude lock mode ● Built-in independent IMU module ● X820 exclusive servo drive module ● Ethernet video transmission and camera PTZ control |
| Visible Light Camera (6MP, 30x optical zoom) | Sensor | 1/1.8" 6Mp CMOS |
| | Max resolution | 2592 (H) x2592 (V) |
| | View angle | $61.2^\circ \sim 2.3^\circ$ |
| | WDR | $\geq 100dB$ |
| | Video compression standard | H.264/H.265/MJPEG |
| | Frame rate | 30fps@5M/3M, 60fps@1080p |
| | Iris | F1.5~F4.3 |
| | Focal length | 6mm~180mm (30x optical zoom) |
| | Digital NR | 3D |
| | SNR | $\geq 55dB$ (AGC Off, Weight ON) |
| | Min illuminance | <ul style="list-style-type: none"> ● Color: 0.005Lux@F1.5 ● Black and white: 0.0005Lux@F1.5 |
| | Backlight compensation mode | BLC/HLC |
| | Day/night switch | Auto/Manual |
| | WB | Auto/Manual/Tracking/Outdoors/Indoors/Outdoors Auto/Sodium Lamp Auto/Sodium Lamp |
| Electronic shutter | Support auto electronic shutter (1/3~1/30, 000s), manual electronic shutter (1/3~1/30, 000s). | |
| Storage | 128GB Micro SD | |
| Thermal camera (temperature measuring type) | Detector type | Uncooled vanadium oxide focal plane detector |
| | Detector pixel | 640x512 |
| | Video coding | H.264M/H.264H/M-JPEG, support 720P image output |
| | Pixel size | 17 μm |
| | Spectral range | 7.5 $\mu m \sim 13.5\mu m$ |
| | Thermal sensitivity | $\leq 40mK$ |
| | Lens focal length | 19mm |
| | Distance (human: 1.8m*0.5m, detection, recognition, identification) | 640m, 160m, 80m |

| Parameter Item | | Parameter Value |
|---|---|---|
| Model | | Dahua Navigator X820 |
| | Distance (vehicle: 2.3m*2.3m, detection, recognition, identification) | 2000m, 500m, 250m |
| | Temperature measuring range | Low temperature mode: -40°C to 160°C. High temperature mode: -40°C to 550°C |
| | Temperature measuring error | Max($\pm 2^{\circ}\text{C}$, $\pm 2\%$) |
| | Temperature measuring function | Support real-time multi-preset temperature measuring, temperature alarm, temperature correction, temperature measuring unit setting, temperature real-time analysis, historical temperature information query and so on. |
| | Storage | 128GB Micro SD |
| Integrated remote control | Features | Integrated design of remote control display |
| | Remote control distance | $\geq 5\text{km}$ |
| | Remote control dimension | 350mm \times 228mm \times 85mm |
| | Battery | 2S LiPo, 7800 mAh |
| | Output port | micro USB, headset port |
| | Operating screen and system | <ul style="list-style-type: none"> ● Screen size: 7" (Multi-point capacitance) ● Resolution: 1024*600 ● OS: Android 5.1 |
| | Network | WiFi IEEE802.11 b/g/n |
| | Storage | 16GB Micro SD |
| Ground Station | Image transmission distance | Max. 10km |
| | Data transmission distance | Max. 10km |
| | Protection level | IP65 waterproof and dustproof level, anti-seismic/impact resistance/wide temperature, waterproof keyboard. |
| | Display screen | 13.1 inch touch screen, resolution 1024*768, 1200cd/m ² |
| | Internal memory | 4GB |
| | Storage | 500 GB HDD (SATA) |
| | Protocol | Support GB/T 28181 |
| Integrated remote control & ground station software | Software function | <ul style="list-style-type: none"> ● Parameter setting ● Auto planning of cruising mission ● Import and export of flight path template ● Auto takeoff and landing ● Real-time switch of video map ● Intelligent flight mode: <ul style="list-style-type: none"> ◇ Flight course lock ◇ Home point lock |

| Parameter Item | | Parameter Value |
|----------------|--|---|
| Model | | Dahua Navigator X820 |
| | | <ul style="list-style-type: none"> ◇ Point of interest ◇ Waypoint ● Mission record ● Video playback ● 3D map |

Appendix Table 1-1

17803 大華 2018-01-08

Appendix 2 Aircraft Status Indicator

The aircraft status indicator over the power switch is turned on after the aircraft is enabled. Different colors and statuses mean differently. Please refer to the Appendix Table 1-2.

Please do understand the contents listed in the table below before flight, which is to help you quickly understand the aircraft status or positioning problem during flight. The actual operation methods will be specifically introduced in other chapters.

| Phase | Indicator color and status | Implication | Operation | |
|---------------------|----------------------------|--|---|---|
| Launch | ●●● ●●● ●●●..... | Self-check and preheating | Wait | |
| | ● Normally on | System self-check report error | - | |
| | ● ● ●..... | Aircraft in no-fly zone | Move the aircraft out of no-fly zone.  Note Please refer to "3.10 Check and Debugging" for the flight area. | |
| Compass calibration | ● Normally on | Horizontal calibration of compass | Wait | |
| | ● Normally on | Vertical calibration of compass | Wait | |
| | ●● ●● ●●..... | Calibration failure of compass | Manually calibrate compass | |
| Pairing | ● Normally on | Pairing success | - | |
| Flight | ● ● ●..... | Take off normally | - | |
| | ● Flash once | fixed point mode and satellite number ≥ 6 | - | |
| | ● Flash twice | fixed point mode and satellite number < 6 | - | |
| | ● Flash once | Intelligent mode and satellite number ≥ 6 | - | |
| | ● Flash twice | Intelligent mode and satellite number < 6 | - | |
| | ● Flash once | Fixed altitude mode | - | |
| | ●●● ●●● ●●●..... | - | Disconnected to remote control for more than 3s | - |
| | ●●● ●●● ●●●..... | - | Level 1 low battery warning | - |
| | ●●●● ●●●● ●●●●..... | - | Level 2 low battery | - |

| Phase | Indicator color and status | Implication | Operation | |
|---------------|----------------------------|--|------------------------------|-----------------------------------|
| | | warning | | |
| | | Disconnected to remote control for more than 3s | - | |
| | | Level 1 low battery warning | - | |
| | | Level 2 low battery warning | - | |
| | | Disconnected to remote control for more than 3s | - | |
| | | Level 1 low battery warning | - | |
| | | Level 2 low battery warning | - | |
| | | Image transmission disconnected | - | |
| | | Disconnected to remote control for more than 3s | - | |
| | | Level 1 low battery warning | - | |
| | | Level 2 low battery warning | - | |
| | | Disconnected to remote control for more than 3s | - | |
| | | Level 1 low battery warning | - | |
| | | Level 2 low battery warning | - | |
| | Firmware upgrade | | Firmware upgrade in progress | Wait |
| | | ● Normally on | Upgrade failed | Check upgrade step. Upgrade again |
| | ● Normally on | Upgrade succeeded | - | |
| Lose efficacy | ● Flash for three times | Any sensor loses efficacy and any abnormal forced landing events | - | |

Appendix Table 2-1

Appendix 3 System Pairing



Caution

The frequency of aircraft, remote control and ground station has been paired before factory delivery.

Abnormity

It needs to pair again when both the remote control and ground station fail to control the aircraft remotely.

Exact Operations

Step 1 Use pairing needle to press the pairing button (on the right of power switch) of aircraft for 3 seconds.

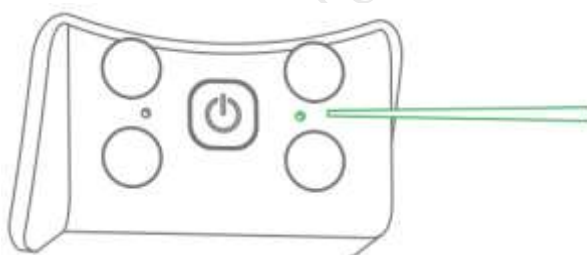

Appendix Figure 3-1

Step 2 Select "Aircraft Settings > Pair" on the ground station. The system will display the interface of "Pair", as shown in Appendix Figure 3-2.

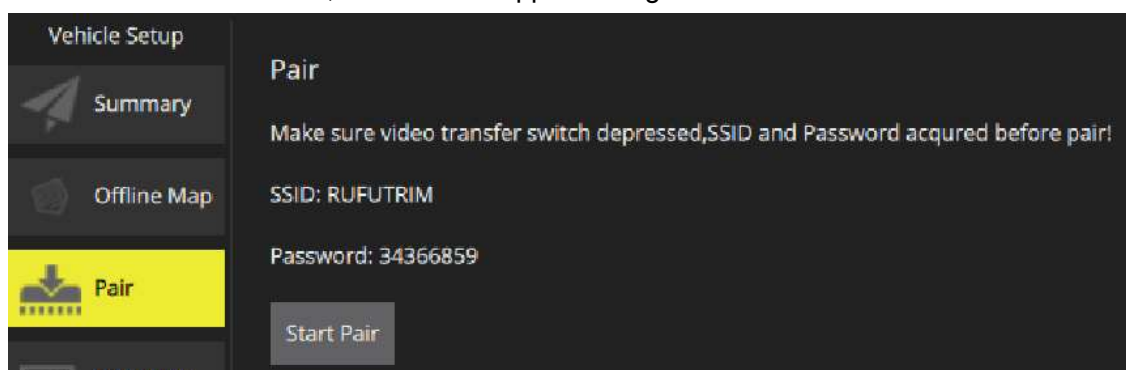

Appendix Figure 3-2

Step 3 Select "Settings > Remote Control Settings > Remote Pair" on the remote control. The system will display the interface of "Remote Pair", as shown in Appendix Figure 3-3.

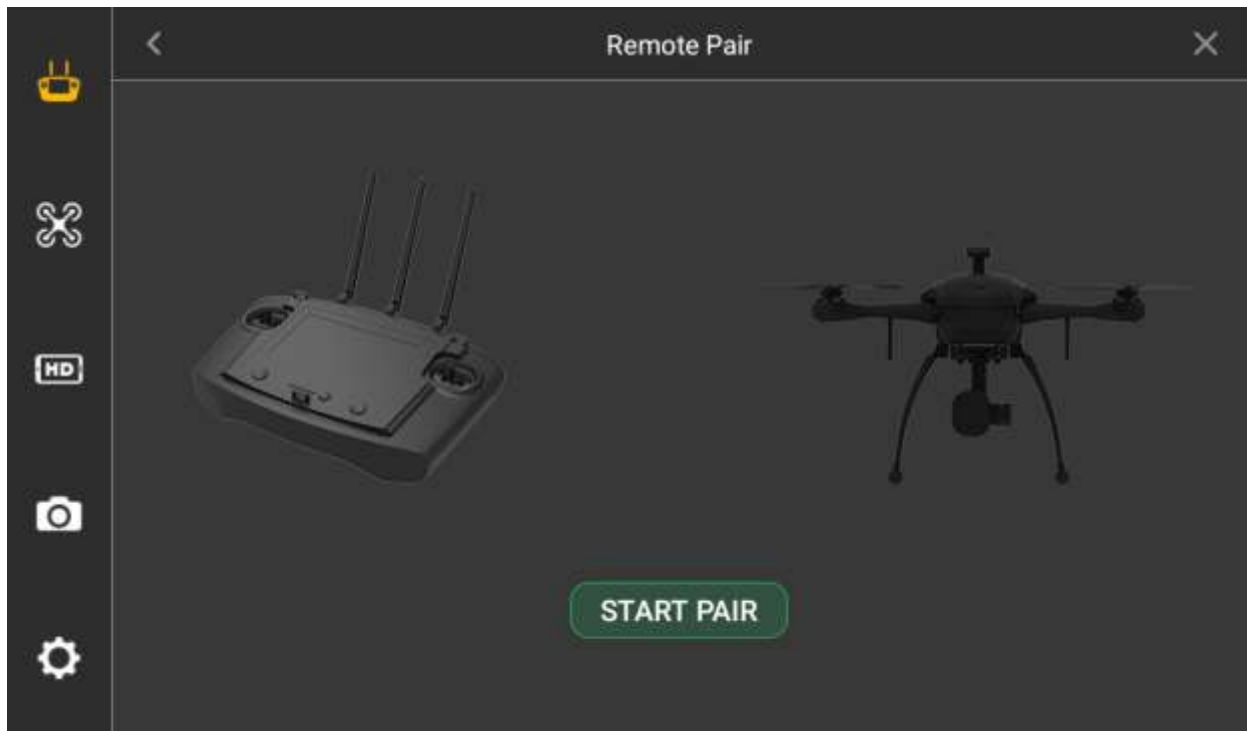

Appendix Figure 3-3

Step 4 The system will automatically implement pairing when clicking "Start Pair" on both the remote control and ground station.

It means pairing of system is successful when the ground station prompts "Pairing Success" and remote control prompts "Remote Control Pairing Success".

Appendix 4.1 FAQ and Solutions of Aircraft

Question: Images are subject to water ripple and jitter when the aircraft meets gale.

Solution: Prevent PTZ from facing the gale directly.

Appendix 4.2 FAQ and Solutions of Remote Control

Question 1: Response speed of remote control touch screen becomes slow and other abnormalities.

Solution 1: Select "Settings > General Settings > Power off" on the ground station, and it will pop out the dialog box of power off and restart, and long press to select restart, as shown in Appendix Figure 4-1.



Appendix Figure 4-1

Question 2: The remote control doesn't respond.

Solution 2: Long press the reset button of remote control for over 3 seconds, the touch screen will restart after shutdown, as shown in Appendix Figure 4-2.

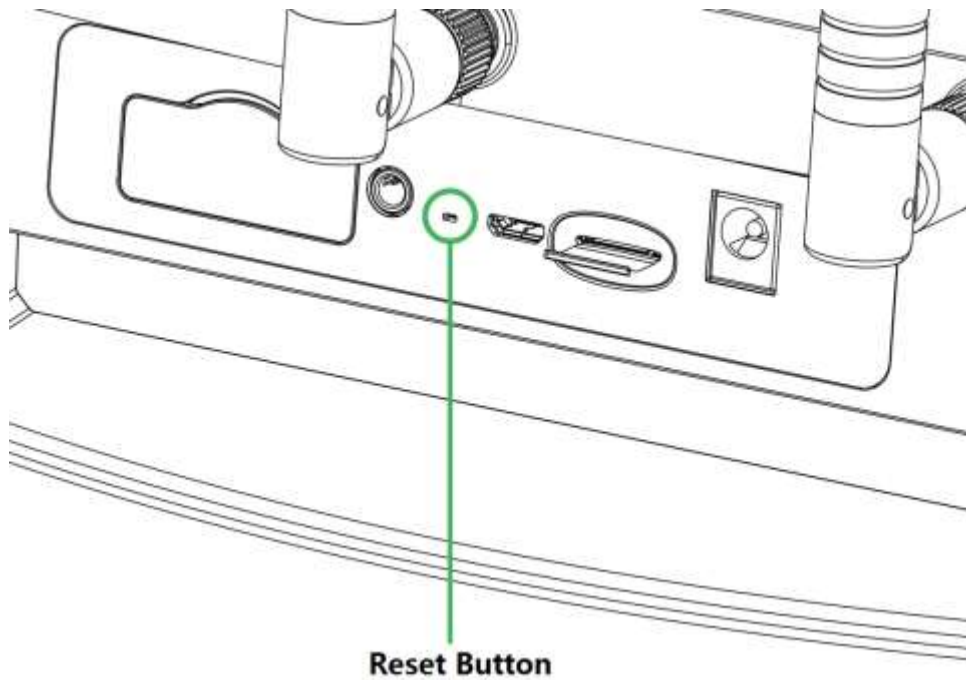

Appendix Figure 4-2

Appendix 4.3 FAQ and Solutions of Ground Station

Question: Image transmission becomes unsmooth when the aircraft is over the ground station.

Solution: Manually adjust relay antenna angle of the ground station, to solve this problem, as shown in Appendix Figure 4-3.

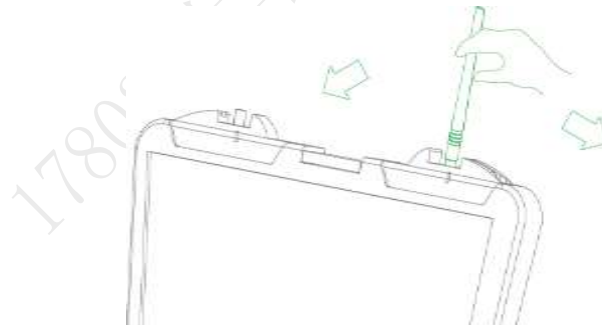

Appendix Figure 4-3

Appendix 4.4 FAQ and Solutions of Airborne Equipment

Question: Recorded video loss (including failure to copy data from SD card).

Solution: Check the aircraft version. Please contact the manufacturer if the version is too low.

Appendix 4.5 FAQ and Solutions of Charger

Question: Charger displays error prompts: ERR1 (Starting Connection Error), ERR2 (Current Abnormality Protection), ERR3 (Balance Port Fault), ERR4 (AC Input Fault) and ERR5 (Charging Connection Error).

Solution: Please inspect whether connection between AC power line and charger, or

connection between charger and battery is abnormal or not. Please contact the manufacturer if it fails to be solved.

 **ZHEJIANG DAHUA VISION TECHNOLOGY CO.,LTD.**

Address: No.1199, Bin'an Road, Binjiang District, Hangzhou, P.R. China

Postcode: 310053

Tel: +86-571-87688883

Fax: +86-571-87688815

Email:overseas@dahuatech.com

Website: www.dahuasecurity.com

17803 大华 2018-01-08