

Flashforge Guider II 3D Printer

User Guide

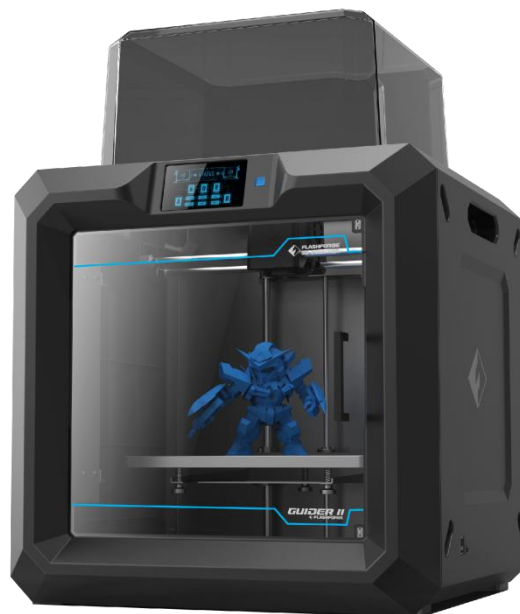

Content

Content.....	2
Preface.....	3
Introduction.....	4
Notice.....	5
Chapter 1: 3D Printing Technology.....	9
Chapter 2: About Guider II	11
2.1 About Your Guider II	11
Chapter 3: Unpacking.....	21
Chapter 4: Hardware Assembly.....	25
4.1 Filament Installation.....	25
4.2 Printer Start-up.....	26
4.3 Loading Filament.....	26
Chapter 5: Build Plate Leveling.....	30
Chapter 6: About Software.....	33
6.1 Software Installation.....	33
6.2 Exploring FlashPrint.....	33
Chapter 7: Basic Printing.....	58
7.1 Generate a Gcode.....	59
7.2 Print Methods.....	61
Chapter 8: Advanced Printing.....	65
8.1 Skills on Supports.....	73
8.2 Control over Printing Quality.....	79
Chapter 9: Supports and Service.....	84

Preface

Note: Each device must be tested before leaving factory. If there are some residues in extruder or some tiny scratches on the build tape, it is normal and won't affect the printing quality.

On the completion of this User Guide, thanks all Flashforge engineers and the Flashforge 3D printer users for their unremitting efforts and sincere assistance.

The Flashforge Guider II User Guide is designed for the Guider II users to start their printing journey with Flashforge Guider II. Even if you are familiar with earlier Flashforge machines or 3D printing technology, we still recommend that please read this guide, as there is lots of important information about the Guider II for you to get a better 3D experience.

For a better and more successful printing experience, you can refer to the following materials:

(1) Quick Start Guide

Users will find the Quick Start Guide together with the printer accessories. The Quick Start Guide will help you start your print journey as soon as possible.

(2) Official Flashforge Website: <http://www.flashforge.com>

The official Flashforge website contains the up-to-date information concerning Flashforge software, firmware, device maintenance and so on. Users are also able to get the contact information from there.

Introduction

Notes :

- Please read *Flashforge Guider II 3D Printer User Guide* carefully before use.
- The User Guide is written based on Windows 7 OS.
- The version of the Flashprint is latest.

The *Flashforge Guider II 3D Printer User Guide* contains the information needed for you to set up and use this device.

This User Guide including the following parts: Preface, Introduction and after-sale service.

The Preface section includes resource acquisition channel, the overall framework of the manual, and the problems that should be paid attention to while printing.

The introduction section contains the overview of 3D printing technology, equipment introduction, unpacking and installation of equipment, software installation and use.

After-sale section contains the user how to get the support and help.

Notice

Safety Notice

! Notices: Read all the instructions in the manual and familiarize yourself with the Flashforge Guider II User Guide before setting-up and using. Failure to comply with the warning and instructions may result in individual injury, fire, equipment damage or property damage.

PLEASE STRICTLY FOLLOW ALL THE SAFETY WARNINGS AND NOTICE BELOW ALL THE TIME.

• Work Environment Safety

- ① Keep your work place tidy.
- ② Do not operate Guider II in the presence of flammable liquids, gases or dust.
- ③ Keep Guider II out of children and untrained people' reach.

• Electrical Safety

- ① Always use the Guider II with a properly grounded outlet. Do not refit Guider II plug.
- ② Do not use Guider II in damp or wet locations. Do not expose Guider II to burning sun.
- ③ Do not abuse the cord.
- ④ Avoid using the device during an thunderstorm.
- ⑤ In case of uncertain accident, please unplug the device if you do not use it for long.

•Personal Safety

- ① Do not touch the nozzle and build plate during printing.

- ② Do not touch the nozzle after finishing printing.
- ③ Dress properly. Do not wear loose clothing or jewelry. Keep your hair, clothing and gloves away from moving parts.
- ④ Do not operate the device while you are tired or under the influence of drugs, alcohol or medication.

· **Cautions**

- ① Do not leave the device unattended for long.
- ② Do not make any modifications to the device.
- ③ To lower the build plate before loading/unloading filament. (The distance between the nozzle and build plate should be kept for at least 50mm)
- ④ Operate the device in a well-ventilated environment.
- ⑤ Never use the device for illegal activities.
- ⑥ Never use the device to make any food storage vessels.
- ⑦ Never use the device to make any electrical appliance.
- ⑧ Never put the model into your mouth.
- ⑨ Do not remove the models with force.

· **Environment Requirements**

Temperature: RT 15-30°C

Moisture: 20%-70%

· **Filament Requirements**

Do not abuse the filament. Please make sure you use the Flashforge filament or the filament from the brands accepted by Flashforge.

· **Filament Storage**

All polymers degrade with time. Do not unpack until filament is needed. Filament should be stored at clean and dry conditions.

Legal Notice

All the information in this document is subject to any amendment or change without the official authorization from Flashforge.

FLASHFORGE CORPORATION MAKES NO WARRANTY OF ANY KIND WITH REGARD TO THIS DOCUMENT, INCLUDING, BUT NOT LIMITED TO, THE IMPLIED WARRANTIES OF MERCHANTABILITY AND FITNESS FOR A PARTICULAR PURPOSE.

Flashforge shall not be liable for errors contained herein for incidental consequential damages in connection with furnishing, performance or use of this material

FCC STATEMENT :

This device complies with Part 15 of the FCC Rules. Operation is subject to the following two conditions:

- (1) This device may not cause harmful interference,
- (2) This device must accept any interference received, including interference that may cause undesired operation.

Warning: Changes or modifications not expressly approved by the party responsible for compliance could void the user's authority to operate the equipment.

NOTE: This equipment has been tested and found to comply with the limits for a Class B digital device, pursuant to Part 15 of the FCC Rules. These limits are designed to provide reasonable protection against harmful interference in a residential

installation. This equipment generates uses and can radiate radio frequency energy and, if not installed and used in accordance with the instructions, may cause harmful interference to radio communications. However, there is no guarantee that interference will not occur in a particular installation. If this equipment does cause harmful interference to radio or television reception, which can be determined by turning the equipment off and on, the user is encouraged to try to correct the interference by one or more of the following measures:

Reorient or relocate the receiving antenna.

Increase the separation between the equipment and receiver.

Connect the equipment into an outlet on a circuit different from that to which the receiver is connected.

Consult the dealer or an experienced radio/TV technician for help.

FCC Radiation Exposure Statement:

This equipment complies with FCC radiation exposure limits set forth for an uncontrolled environment .This equipment should be installed and operated withminimum distance 20cm between the radiator& your body.

This document contains proprietary information protected by copyright.

Copyright © 2016 Flashforge Corp. All Rights Reserved

Chapter 1: 3D Printing Technology

3D printing refers to transforming three-dimensional models into physical objects that you can hold and touch. It is also called additive manufacturing because the 3D model is created by “adding” layers upon layers of material until the object is fully formed.

Fused Filament Fabrication(FFF) is the most common method of 3D printing. It is also the method that the Guider II uses. It works by melting plastic material called filament onto a print surface in high temperature. The filament solidifies after it cools down, which happens instantaneously after it is extruded from the nozzle. 3D objects are formed with the filament laying down multiple layers.

1.1 Process

3D printing involves three steps:

- 1.) Make or download a 3D model
- 2.) Slice and export the 3D model
- 3.) Build the 3D model

1.1.1 Make a 3D Model:

Currently, there are three ways to creating a 3D model.

·**Designing From Scratch** You can use free CAD (computer-aided design) software such as 3DTADA, AutoCAD, SolidWorks, Pro-E, and our own software Happy 3D to design your own 3D model.

·**3D Scanners** An alternative method to creating a 3D model is to scan an object. 3D scanners work by digitizing a physical object, collecting its geometric data, and saving it to a file on your PC. There are also apps that can turn a mobile device

into a 3D scanner.

·**From the Cloud** The most popular way of obtaining a 3D model is to download it from websites that allow users to upload 3D models that they designed.

E.g. : www.thingiverse.com

1.1.2 Slice and Export the 3D Model:

Slice software is the software that prepares 3D models for printing and turns them into instructions for the 3D printers. FlashPrint is the slicing software used for the FlashForge Guider II .

Using FlashPrint, you can turn stl. files into g. or gx. files for printing. Then the files can be transferred to your Guider II via USB cable, USB stick or Wi-Fi.

1.1.3 Build the 3D Model:

Once the output file has been transferred to your Guider II , it will start to turn the 3D model into a physical object by laying down layers of filament.

Chapter 2: About Guider II

2.1 About Your Guider II

2.1.1 Views

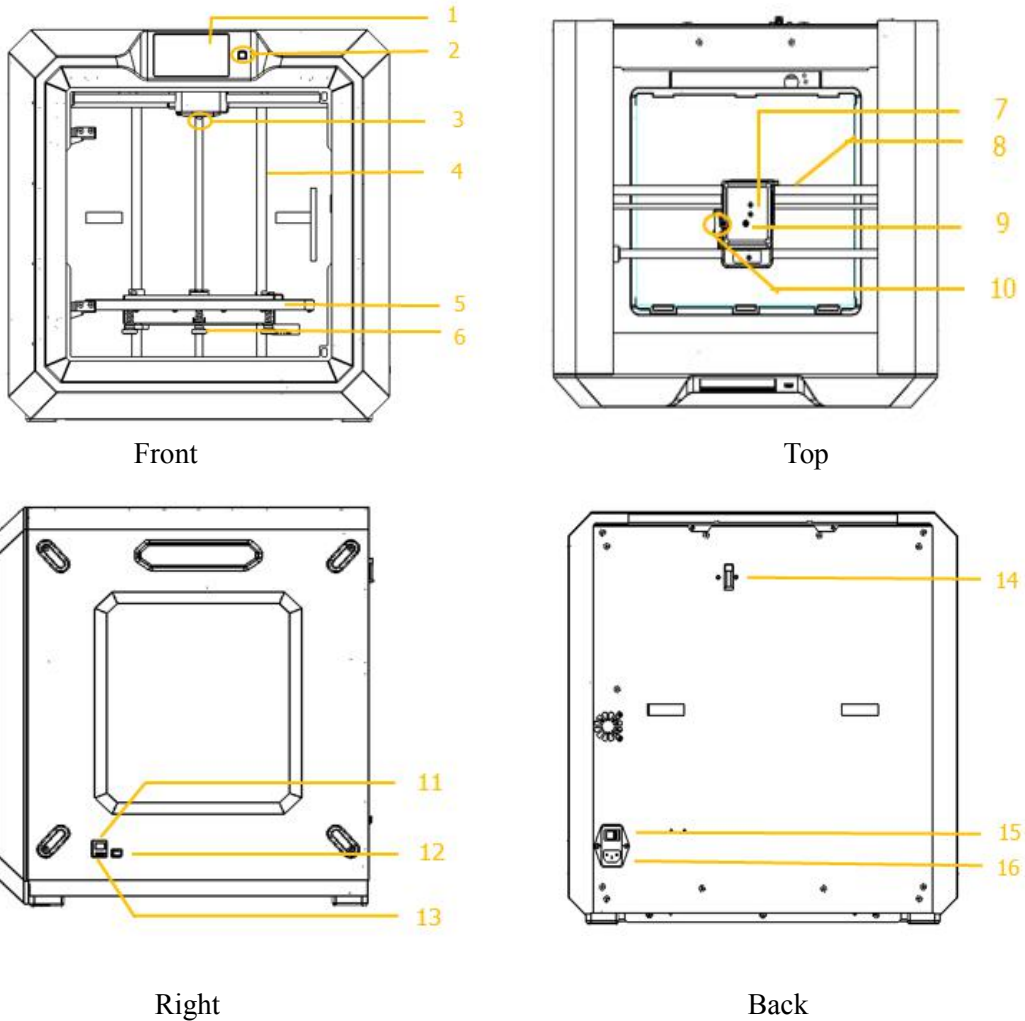

- | | | |
|---------------------|---------------------|------------------------|
| 1. Touch screen | 6. Leveling knob | 11. Ethernet input |
| 2. Power Switch | 7. Extruder | 12. USB cable input |
| 3. Nozzle | 8. X-axis guide rod | 13. USB stick input |
| 4. Z-axis guide rod | 9. Filament intake | 14. Filament cartridge |
| 5. Build plate | 10. Spring presser | 15. Power switch |
| | | 16. Power input |



2.1.2 Terms



Build Plate	The surface on which the Guider II builds an object.
Build Tape	The blue tape that covers Guider II's build plate so that the object can stick to the build plate well.
Build Volume	The three dimensional amount of space that an object will use once it is completed. The largest build volume of Guider II is 280*250*300 mm.
Leveling Knobs	Knobs under the build platform that are used for adjusting the distance between the nozzle and build plate.
Extruder	The device that draws the filament from the spool, melts it and pushes it through a nozzle into the build plate.
Nozzle	Also called "print head", which located at the bottom of the extruder where heated filament is squeezed out.
Extruder Fan	To cool the outer assembly of the extruder and gear motor
Filament Intake	An opening located at the top of the extruder .
Filament Guide Tube	A black plastic piece that guides the filament from the filament box to the filament intake
Filament Cartridge	A specific box for placing Flashforge filament
PVP Glue Stick	A solid adhesive used for making the model stick to the build plate firmly
Unclog Tool	A tool that used for cleaning the extruder
Stamping Wrench	A tool that used for seizing the nozzle's metal cube

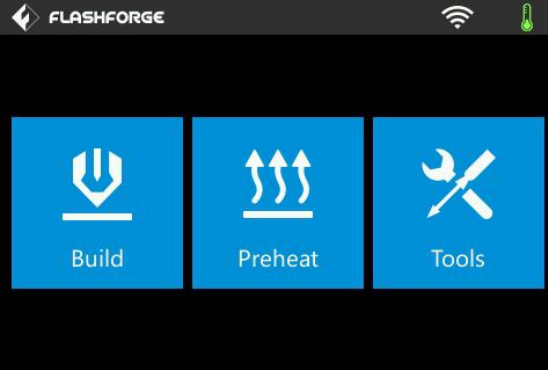
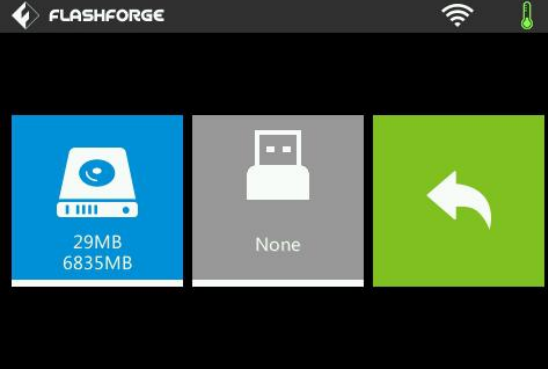
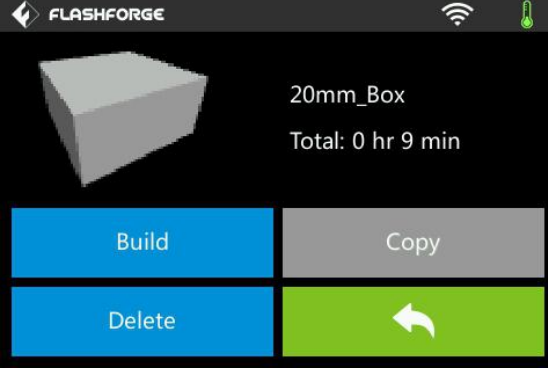

2.1.3 Reference

Name	Guider II
Number of Extruder	Single
Print Technology	Fused Filament Fabrication(FFF)
Screen Size	5.0" color IPS Touch Screen
Build Volume	280*250*300mm
Layer Resolution	0.05 - 0.4mm
Build Accuracy	±0.1mm
Positioning Accuracy	Z axis 0.0025mm; XY axis 0.011mm
Filament Diameter	1.75mm (±0.07)
Nozzle Diameter	0.4mm
Build Speed	30~150 mm/s
Software	FlashPrint
Support Formats	Input:3MF/ STL/OBJ/FPP/BMP/PNG/JPG/JPEG Output:GX/G
OS	Win xp/Vista/7/8/10、 Mac OS、 Linux
Product Dimensions	490*550*560mm
Net Weight	30Kg
AC Input	Input:100V-240VAC, 47-63Hz Power500W
Connectivity	USB cable, USB stick, WIFI,Ethernet

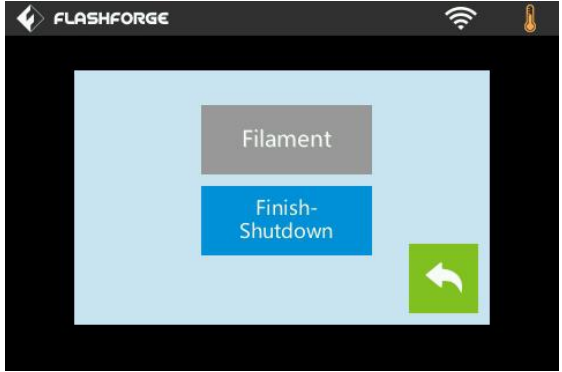
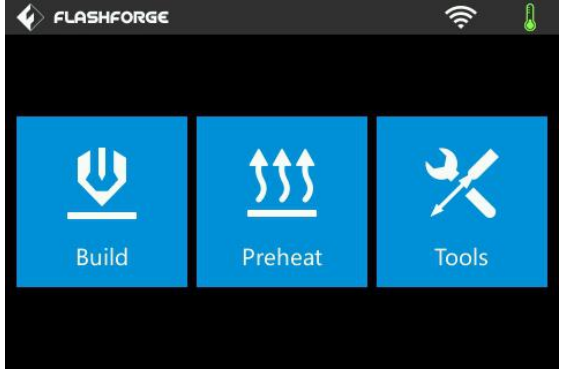
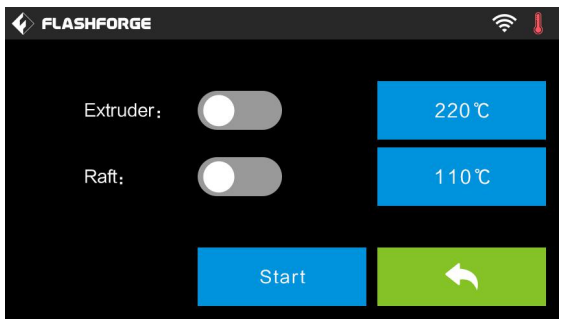
2.1.4 Interface Menus

	<p style="text-align: center;">Press Build</p>
	<p>Read the print file from</p> <ul style="list-style-type: none"> • The local memory card • The USB stick • Return arrow
	<p>Select the target print file among the list</p> <ul style="list-style-type: none"> • Build: To begin printing • Copy: To copy the files to the local memory card from the USB stick.(The button is not available while printing from local memory card) • Delete: To delete the print file
	<p>Print interface</p> <ul style="list-style-type: none"> • Abort: To abort the print job. • Pause/Resume: To suspend or resume the print job. • More: To change filament and set up auto shutdown during printing.

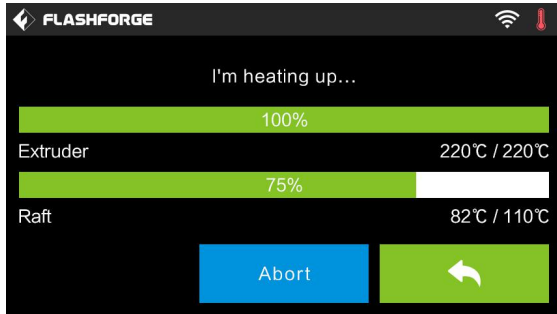
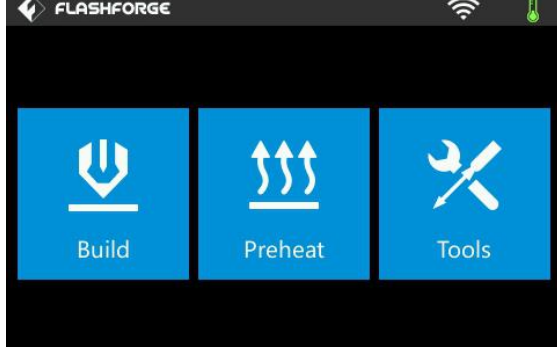
	<p>Tools in print interface</p> <ul style="list-style-type: none"> • Filament: To change filament during printing. (Note: You need to suspend the operation first) • Finish-Shutdown: To start auto shutdown • Cancel: To end the tool orders and return to the print interface.
	<p style="text-align: center;">Preheat</p>
	<p>Tap the [Preheat] button to enter the preheat interface. Tap the [Start] button to heat up to the setting temperature. The default temperature is 220°C. Tap the temperature display bar to set the temperature.</p>
	<p>To set the preheat temperature. Tap [Yes] to save the setting while tap [No] to cancel the setting.</p>

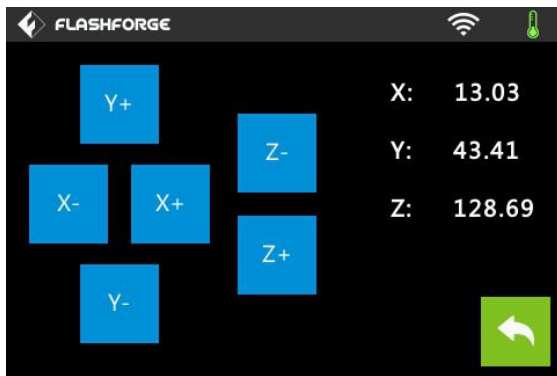
	<p>The picture displays the preheat interface. It shows the actual temperature and the target temperature. Tap the [Abort] button to abort the preheat job.</p>
	<h2 style="text-align: center;">Tools</h2>
	<p>Tap [Tools] to enter tool options.</p> <ul style="list-style-type: none"> • Filament: To load/unload the filament. • Level: To adjust the build plate. • Home: To make the X, Y and Z axes back to the zero point. • Manual: To manually adjust the positions of X, Y and Z axes. • Setting: To implement relevant function setups. • Status: To check the real-time status of the printer. • About: Information about the printer. • Return arrow
	<p>Manual adjustment</p> <ul style="list-style-type: none"> • Y+: The extruder moves to the zero point, that is, the back of the machine • Y-: The extruder moves to the direction opposite to the Y+. • X+: The extruder moves to the zero points, that is, to the right direction • X-: The extruder moves to the direction opposite to the X+. • Z+: The build plate elevates. • Z-: The build plate descends. • Return arrow

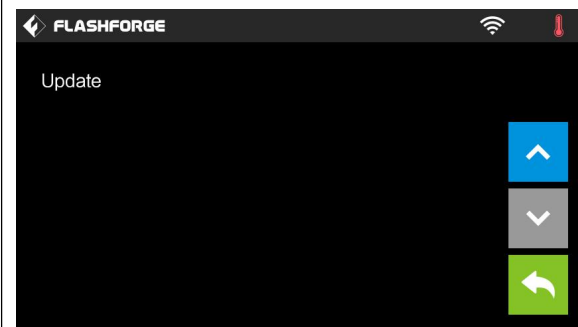
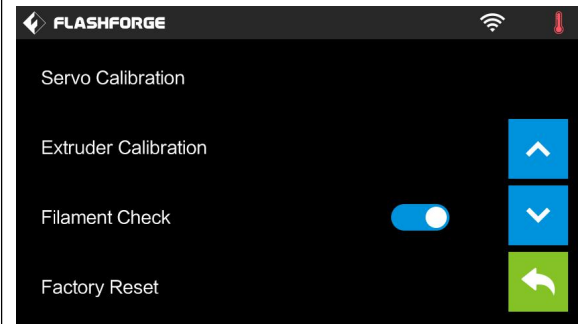
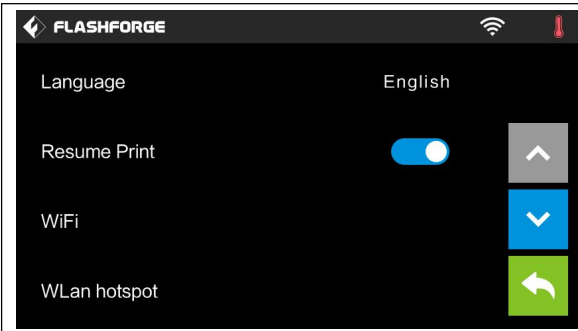

Tap [Setting] to enter the setting interface

- Language: To set the display language
- Resume Print: Resume print after restarting Guider II
- WLAN: To turn on/off the Wlan
- Wlan hotspot: To turn on/off the Wlan hotspot.
- Servo Calibration: To turn on/off the servo or adjust the servo.
- Extruder Calibration: To adjust the initial distance between the extruder and the build plate.
- Filament Check Off: To turn on/off the filament check
- Factory Reset : return to factory setting
- Update: To update the firmware version.
- Return arrow

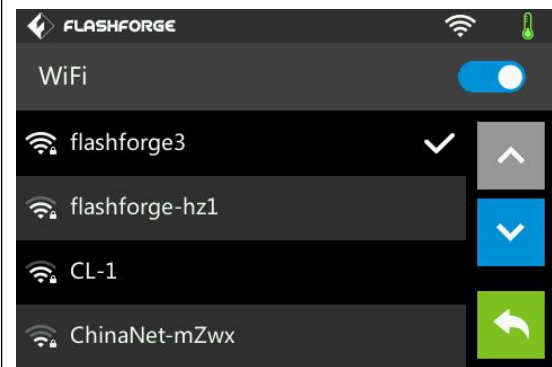
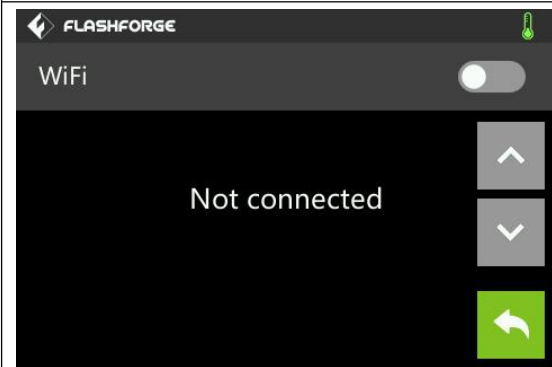

WIFI:

- Turn on WIFI: Turn on the WIFI, release the WIFI hotspot and set the WIFI on computer
- Return arrow

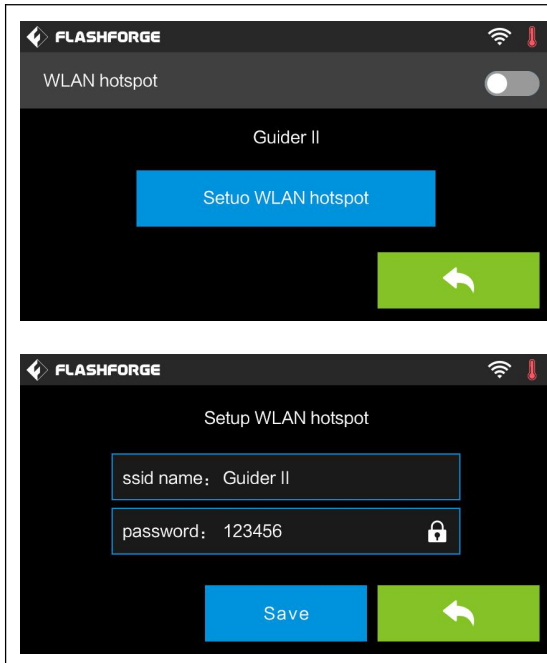

WLAN hotspot

- OFF/On: To turn on/off the Wlan hotspot.
- Setup Wlan hotspot: To set the SSID and password.
- SSID: The name of hotspot.
- Password: The password of hotspot.
- Save: To save the setting.
- Return arrow

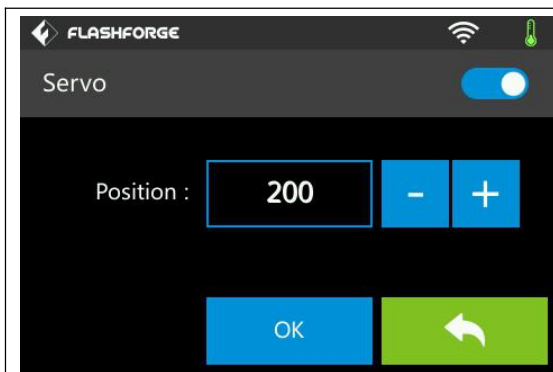

Servo On:

Actually, the present servo status is off. And the servo's swing arm withdraws. Tap '+' or '-' to adjust the status of swing arm. Tap '+', the arm swings down while tap '-', the arm swings up.

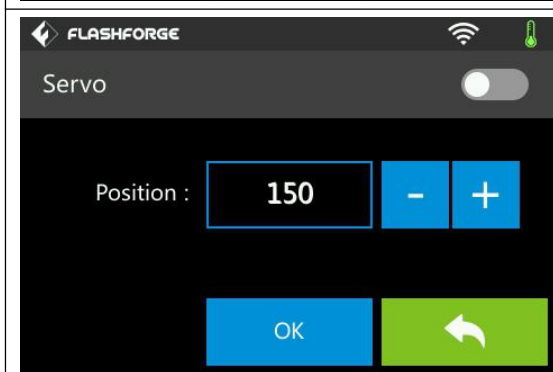

Servo OFF:

Actually, the present servo status is on. And the servo's swing arm withdraws. Tap '+' or '-' to adjust the status of swing arm. Tap '+', the arm swings down while tap '-', the arm swings up.

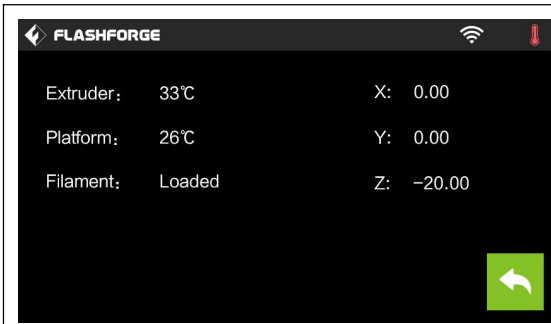

Status:
It displays the real-time status of the extruder temperature.

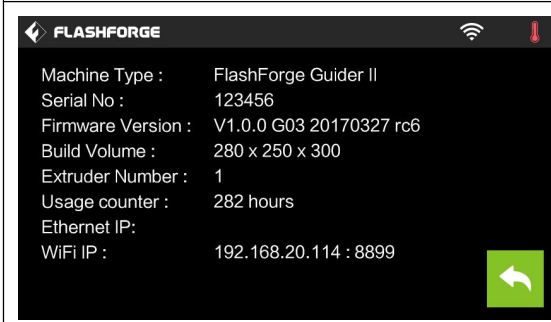

About:
It displays the basic information about the device.

2.2 Accessories



Filament*1

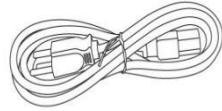

Power Cable



USB Cable



Filament Guide Tube

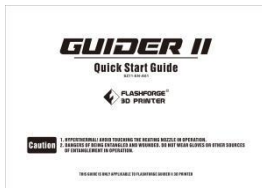

Quick Start Guide

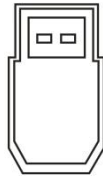

USB stick



Allen Wrench



(M2.0/2.5) Screwdriver



Glue Stick



Stamping Wrench

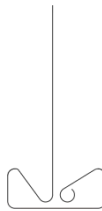

Unclog Tool



After-sales service card

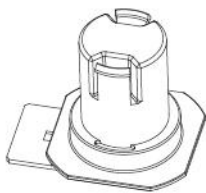

Filament holder

Chapter 3: Unpacking

(reference video: [Unpacking](#))

This chapter will present you the whole unpacking procedure of Guider II 3D printer. **(Note: Make sure you read the whole unpacking guide)**



3-1

(3-1) Place the packaging box on a clean work surface.



3-2

(3-2) Open the box, take out the two foams and then lift your Guider II out of the box.



3-3

(3-3) Your Guider II is wrapped by packaging materials, remove these materials step by step.



3-4

(3-4) In the bottom of the carton, you can see a piece of filament, a filament holder, Power Cable, an USB Cable, one Filament Guide Tube, a glue stick and a tool bag(USB stick*1, leveling knob*1, Allen wrenches*2, stamping wrench*1, unclog tool*1, and screwdriver*1).



3-5

(3-5) Remove the side protective foam sheets.



3-6

(3-6) Take out the top foam from the printer, on the top foam sheet, you can see one Quick Start Guide and a After-sales service card.



3-7

(3-7) Cut off four ribbons that used for fixing the guide rod. Then slide the extruder to make sure the extruder is in good condition.



3-8

(3-8) Take the top cover out of the printer.



3-9

Congratulations! You have unpacked your Guider II. Next, let's move on to hardware assembly of Guider II.

Chapter 4: Hardware Assembly

Your Guider II has been installed before leaving factory, you can start up the Guider II for printing after mounting the filament spool and completing leveling.

4.1 Filament Installation



4-1

(4-1) The filament cartridge is at the rear of Guider II . Lift the cartridge out of the Guider II .



Filament Detecting
Equipment in the black.

4-2

(4-2) Take out the filament and thread it through the filament detecting equipment.

(Note: The filament should feeds from the bottom of the spool towards the top)

4.2 Printer Start-up

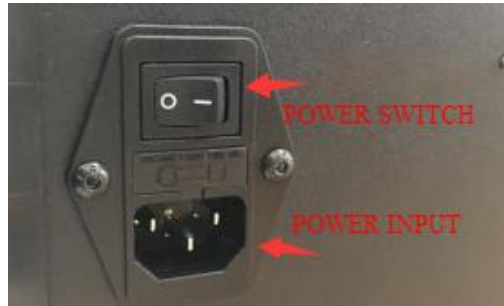

4-3

(4-3) Insert the power supply into the power input on the back of the Guider II and plug the power cord into an electrical outlet.

4.3 Loading Filament

For stable filament loading and proper device protection, you need to install the filament guide tube properly.

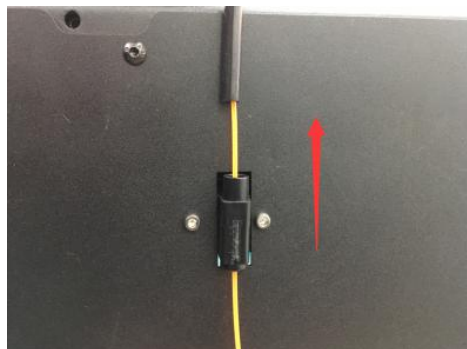

4-4

(4-4) Take out the filament guide tube, thread the filament from Filament Detecting Equipment.



4-6

(4-6) Insert the filament from the filament guide tube into the filament intake.

Next, we will load the Flashforge filament. **(Note: Please lower the build plate to increase the distance between the nozzle and build plate to 50mm at least for avoiding nozzle jam.)**

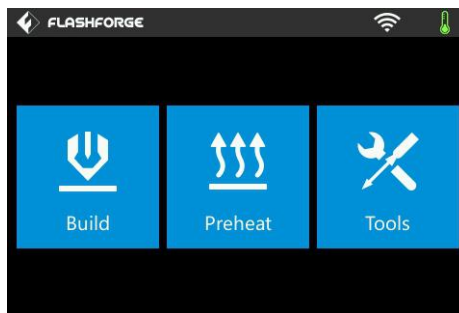

4-7

(4-7) Tap [Tool].

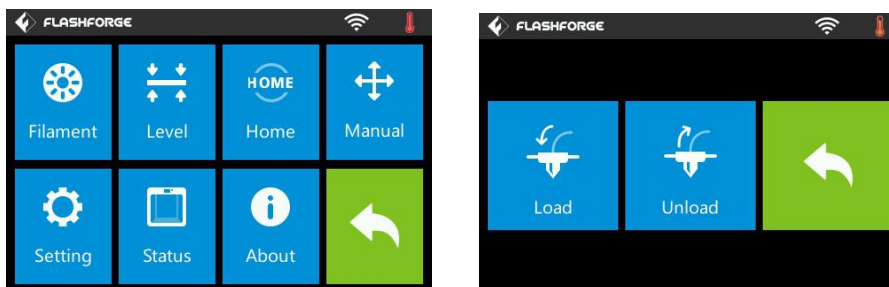

4-8

(4-8) Tap [Filament]--[Load]

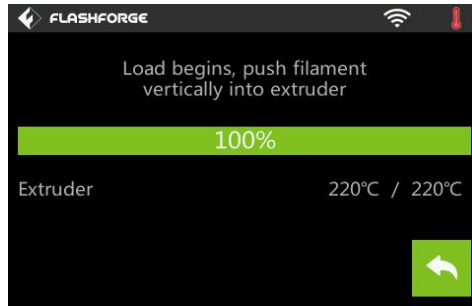

4-9

(4-9) After the extruder's temperature reaches 220°C, the printer will sound a beep to prompt you to load the filament into the extruder.



4-10

(4-10) Insert the filament into the extruder at an upright angle. Then the filament will be drawn through the extruder. Do not tap [Cancel] until the filament load the extruder steadily.

4.4 Unloading Filament



4-11

(4-11) Tap [Tool]-[Unload] and the extruder starts heating up.

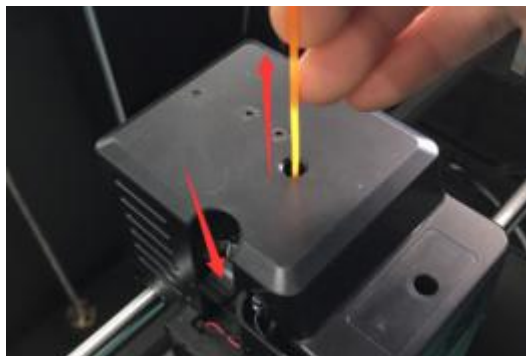
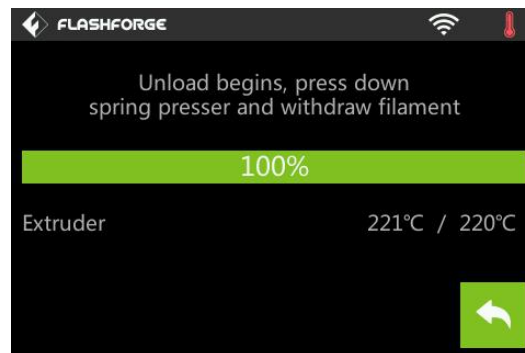

4-12

(4-12) After the extruder reaches 220°C, the printer will sound a beep to prompt you to unload the filament from the extruder. Press the spring presser, press down the filament for about three seconds and gently pull the filament out.

Note: Do not pull out the filament with force as it will damage the gears. If the melted filament has cooled down in the extruder, please repeat the steps above.

Chapter 5: Build Plate Leveling

Guider II creatively adopts three-point intelligent leveling system, which will give clear and comprehensive feedback to users. There are three spring-loaded knobs under the build platform. The distance between the plate and nozzle increases while tightening the knobs. On the contrary, the distance reduces.

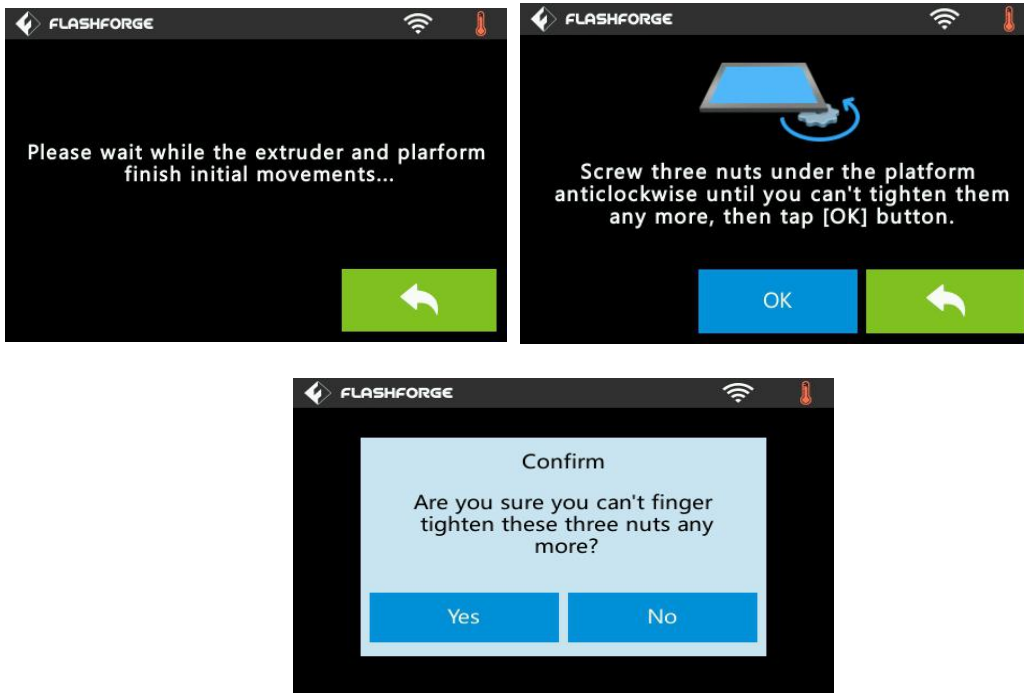

5-1

(5-1) Tap [Tools] - [Level] on your Guider II touch screen. Please wait while the extruder and platform finish initial movements. After that, operate according to the guide on the touch screen.



5-2

(5-2) After tapping [Yes], the extruder starts to move towards the first point and the

plate moves up and down to verify the distance between nozzle and plate.

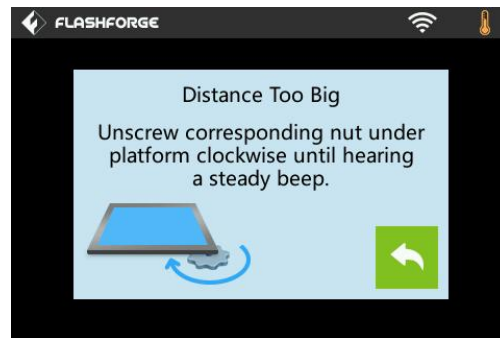

5-3

(5-3) When it shows that the distance is too big, please unscrew corresponding nut under platform clockwise until hearing a steady beep and the [Verify] button appears.

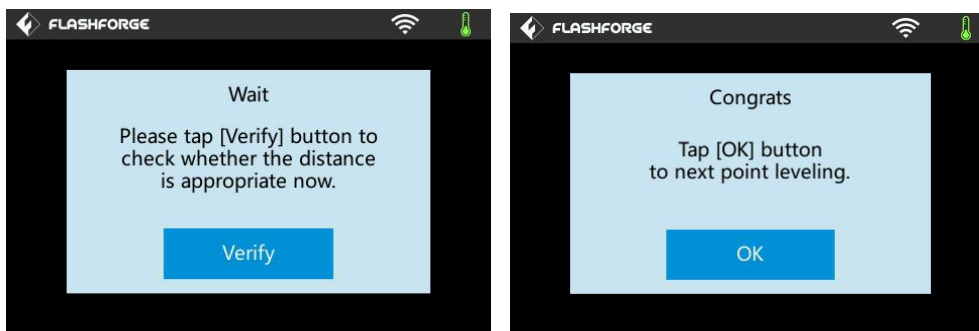

5-4

(5-4) If the distance is appropriate, tap [OK] to second point leveling. If still not, please follow the prompts to adjust again till you see [OK] button.

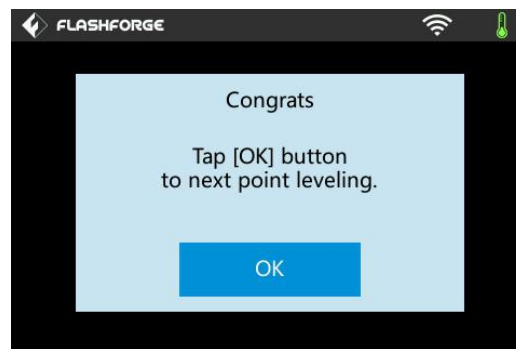

5-5

(5-5) Repeat steps 2 through 4 above to complete second and third points leveling and then Tap [Finish] to exit.

Leveling Emergency Plan:

Some leveling spare parts may be damaged after being used for a period of time.

Now users could adopt the emergency plan for leveling.



- (1) Insert the USB stick to the USB port.
- (2) Tighten each of the three knobs underneath the build platform until they go no further
- (3) Tap **[Build]** on the touch screen, tap the USB icon and then select **Leveling.g** file.
- (4) Tap **[Build]**, then the build plate and the extruder start moving.
- (5) After they stop moving, you can adjust the distance between the build plate and the nozzle manually. Move the extruder to the position right over the front-left knob, and adjust the knob individually. Use a A4 paper to check the distance. As you adjust the knob, make sure the paper just slides between the nozzle and build plate. There will be somewhat friction on the paper but still can easily pass the paper between the plate and the nozzle without tearing or damaging the paper.
- (6) Then move to the positions right over the right-front and rear knobs successively, and then adjust the distance according to the descriptions above.
- (7) Then move to the center of the build plate for a check. Confirm that the paper slides between the nozzle and build with a moderate amount friction.
- (8) Tap the **Abort**  button and finish leveling.

Chapter 6: About Software

6.1 Software Installation

6.1.1 Software Acquisition

Method 1: To get the installation package from the USB disk in the toolkit.

 FlashPrint_3.7.1_win64	2016/1/8 8:48	Windows Install...	41,637 KB
 FlashPrint_3.7.1_win32	2016/1/8 8:48	Windows Install...	37,995 KB
 FlashPrint_3.7.1_mac	2016/1/8 8:47	压缩(zipped)文件...	16,599 KB

Method 2: Open the link below to download the installation package:

<http://www.flashforge.com>

Steps:

Support---Downloads---Flashprint---chose the software version---download

6.1.2 Software Installation and Start-up

1. Decompress the zipped file or start the installation program, and then install the software according to the direction.
2. Start the software with the start menu shortcut or by clicking the software icon.(See 6-1)



6-1

6.2 Exploring FlashPrint

6. 2.1 Machine Type Selection

! After starting FlashPrint, you need to select the target machine type first.

When you start FlashPrint, a dialog box will pop up. Just select Flashforge Guider II in the machine type list and click **[OK]**. You can also change the machine type via clicking **[Print]**--**[Machine type]**. See graphic 6-2:

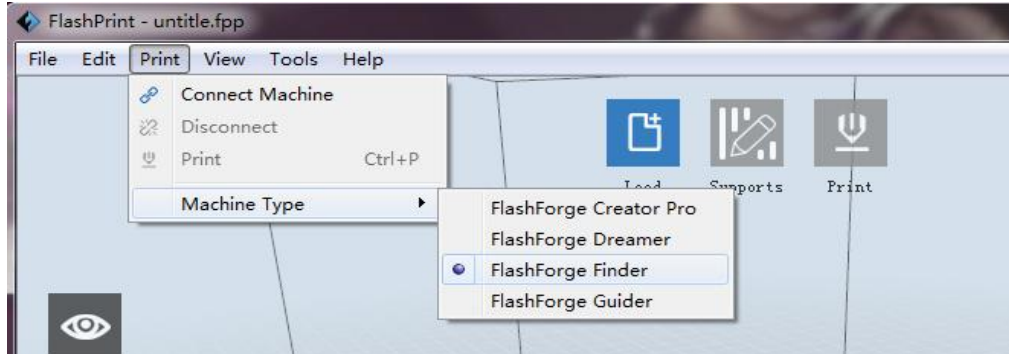





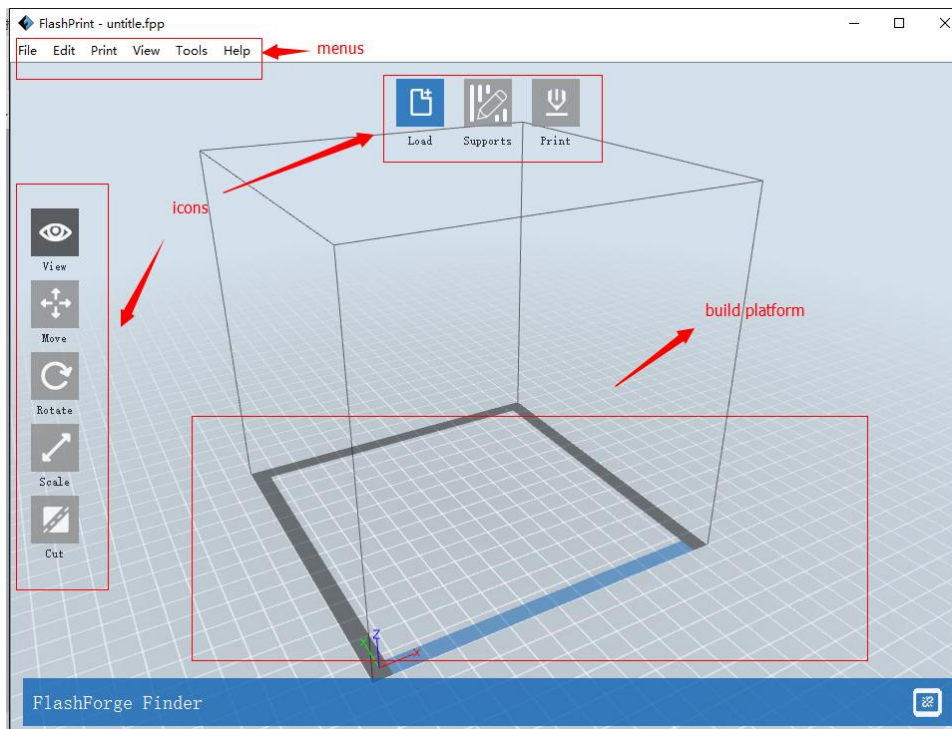



6-2

6.2.2 Software Introduction



6-3

	Load one or multiple files.
	Enter the support edit mode

	Print it directly with your Guider II or export to your USB Stick
	View FlashPrint home screen from one of six viewing angles
	Move model around on xy-plane; shift+click to move along z axis
	Turn and rotate your model
	Scale the size of your object
	Cut model into several parts

6.2.3 Loading

You can load a model file or Gcode file into your Flashprint by the following six methods:

Method 1: Click the **Load** icon  on the main interface. Then select the object file.

Method 2: Select the file for loading and drag the file to the main interface of the software.

Method 3: Click **[File]--[Load File]**. Then select the object file for loading.

Method 4: Click **[File]--[Examples]** to load the example files

Method 5: Click **[File]--[Recent Files]** to load the files opened recently.

Method 6: Select and drag the target file to the icon of Flashprint.

Note: **.STL, .OBJ, and .FPP**, ways to store 3D models, are supported by Flashprint for editing.

Generating Rilievo

Loading a png, jpg, jpeg, bmp picture file into the FlashPrint. And the following dialogue box(6-3) will pop up. The setting box includes settings for shape, mode, maximum thickness, base thickness, bottom thickness,width, height, top diameter and bottom diameter.

Shape: including plane, tube, canister and lamp.

Mode: including “darker is higher”and “lighter is higher”.

Maximum thickness: Z value of the model

Base thickness: The minimum raft thickness and the default value is 0.5mm

Width: X value of the model

Depth: Y value of the model

Bottom thickness: For tube, canister and lamp to set up bottom thickness

Top diameter: For tube, canister lamp and steal to set up the top diameter

Bottom diameter: For tube, canister, lamp and steal to set up the bottom diameter

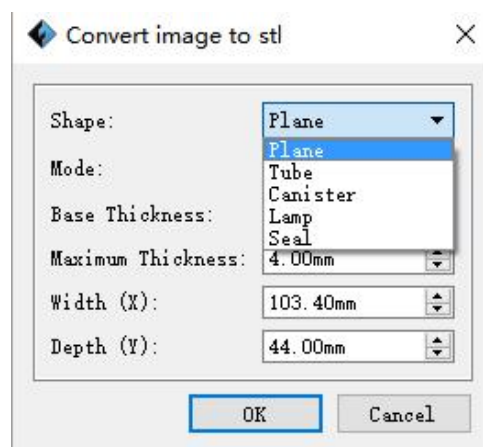

6-4

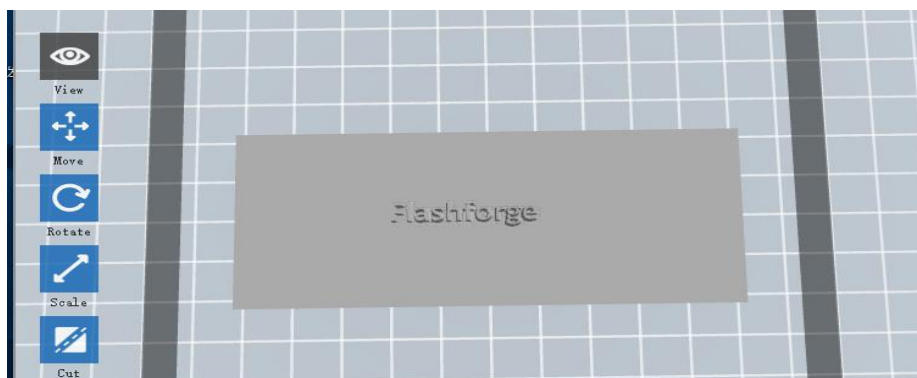

Plane(6-5)

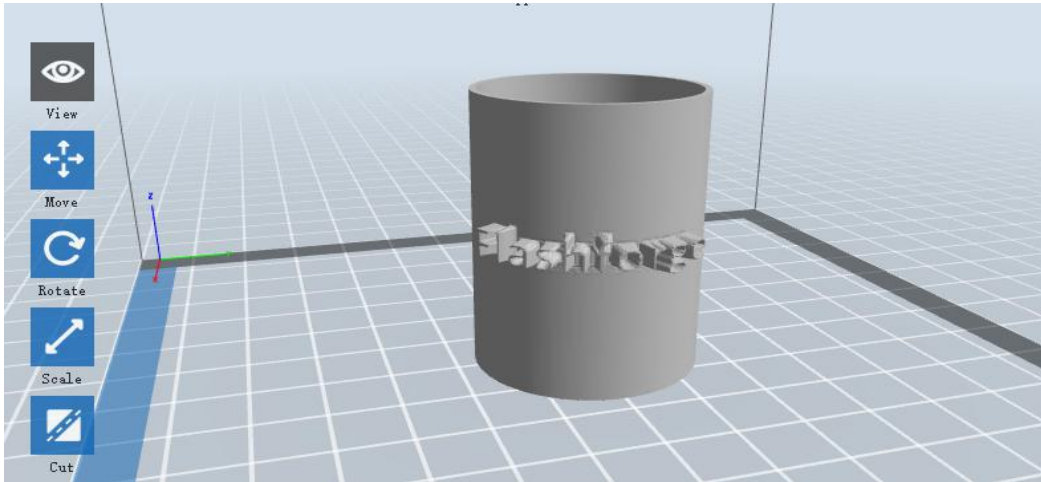

Tube (6-6)

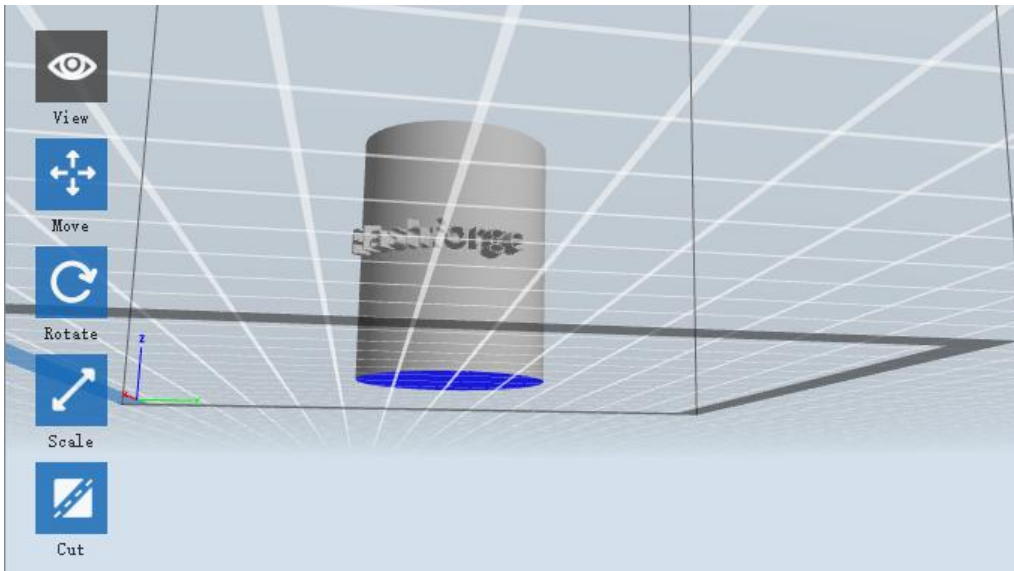

Cansiter(6-7)

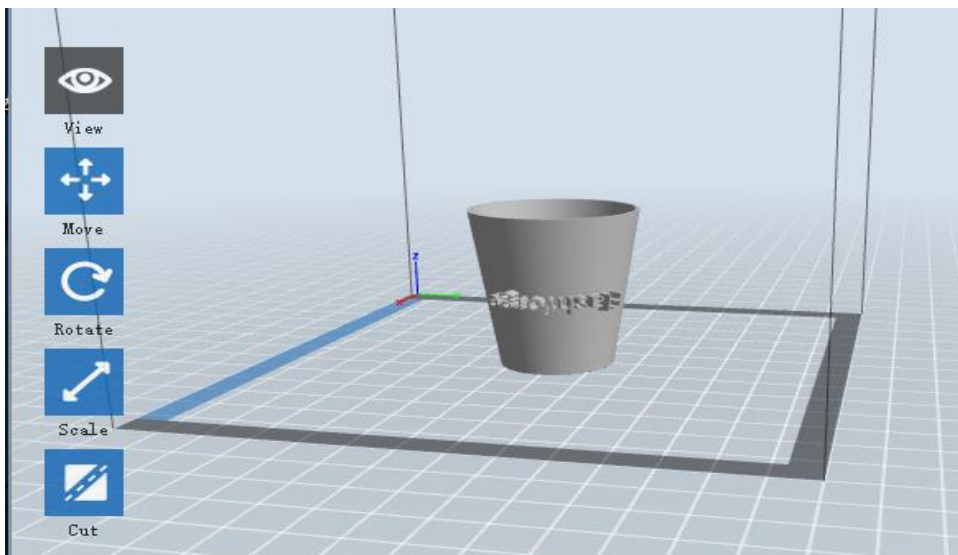

Lamp(6-8)

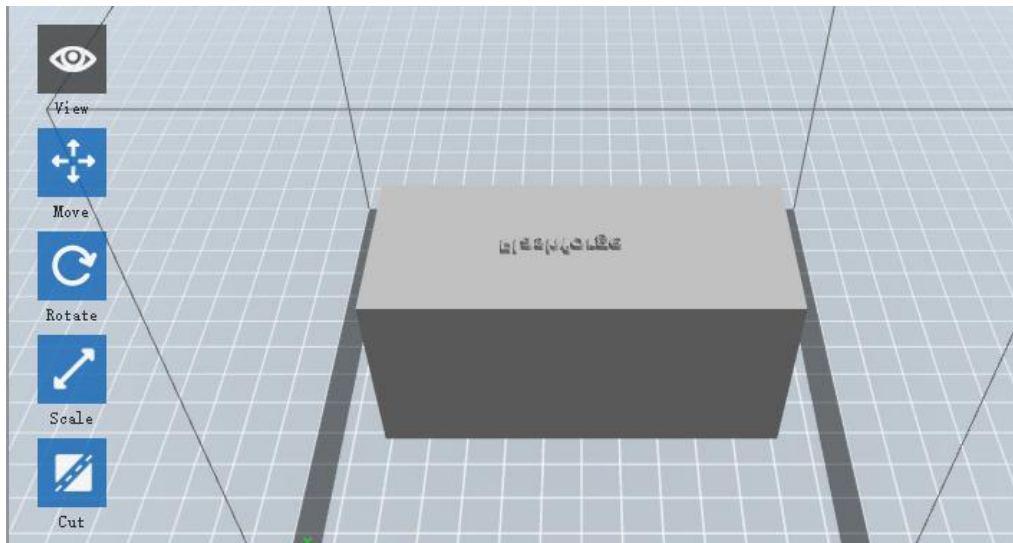

Seal(6-9)

6.2.4 Views

① Changing views

Change model views by moving, rotating, scaling.

• Drag

Click the **[View]** icon  and then you can move the object by the following three methods:

Method 1: Hold down the left mouse button and drag.

Method 2: Hold down the middle mouse button and drag.

Method 3: Hold down the **Shift** key, hold down the right mouse button and drag.

• Rotate

Click the **[View]** icon  and then you can rotate the object by the following two methods:

Method 1. Hold down the right mouse button and drag.

Method 2. Hold down the **Shift** key, hold down the left mouse button and drag.

• Scale

Rotate the mouse wheel to enlarge or shrink the build plate.

②Set View

Allows users to view the object on the build plate. Six views are under the view menu, that is, home view, bottom view, top view, front view, back view, left view and right view.

Method 1: Click the the **[View]** button, there are six views in the drop- down list

Method 2: Click the the **[Look]** icon  on the left, click it again and a submenu will appear with six views for selecting.

③Reset View

Allow users to reset views by the following two methods:

Method 1: Click the **[View]** menu and select **[Home View]**

Method 2: Click the **[View]** button on the left, click it again and you will see the viewing options, you can click **[Reset]**.

④Show Model Outline

Click **[View]--[Show Model Outline]**, it will highlight the yellow border of the object

⑤Show Steep Overhang

Click **[View]--[Show Steep Overhang]**. When the intersection angle between the model surface and horizontal line is within the overhang threshold value, the surface has steep overhang and it becomes red in the software. Overhang threshold value could be set as needed. The default value is 45 degree.

6.2.5 Move

Select the object and move the object by the following two methods:

Method 1: Click the **[Move]** icon on the left, hold down the left mouse button and drag to adjust the location of the model in XY direction. Hold down the **Shift** key, hold down the left mouse button and drag to adjust the location of the model in Z direction. The distance and the direction of the movement shall be displayed.

Method 2: Click the **[Move]** button on the left and then enter the distance value. Click **[Reset]** to reset distance values.

Note: Users shall click **[Center]** and **[On Platform]** after the location adjustment to ensure the model(s) be within the build area and on the build platform. If a specified position is needed, only to click **[On Platform]**.

6.2.6 Rotate

Select the target object and rotate the object by the following two methods:

Method 1: Click the **[Rotate]** icon on the left and three mutually perpendicular rings appear around the object. Click one ring and rotate on the present axis, you will see the rotation angle and direction in the center of circle. In this way, you could make the model rotate on X/Y/Z axis.

Method 2: Click the **[Rotate]** icon on the left, and then enter into rotating angel values in X/Y/Z axes positioning. Click **[Reset]** to reset rotating angel values.

6.2.7 Scale

Select the target object and scale the object by the following two methods:

Method 1: Click the **[Scale]** icon on the left, hold down the left mouse button and scale the model. The corresponding values will display near the object.

Method 2: Click the **[Scale]** icon on the left and then enter into scale values in X/Y/Z axes positioning. Click the **[Maximum]** button to get largest size possible for building. Click **[Reset]** to reset the size of model.

Note: If the **[Uniform Scaling]** radio button is clicked, it will scale the model in equal proportion when changing **value** in any positioning of the model. Otherwise it will only change the value of the corresponding positioning.

6.2.8 Cut

Left-click on the model to select it and double-click on the **Cut icon** to set the cut plane. The direction and position are available for setting.

① Draw with Mouse

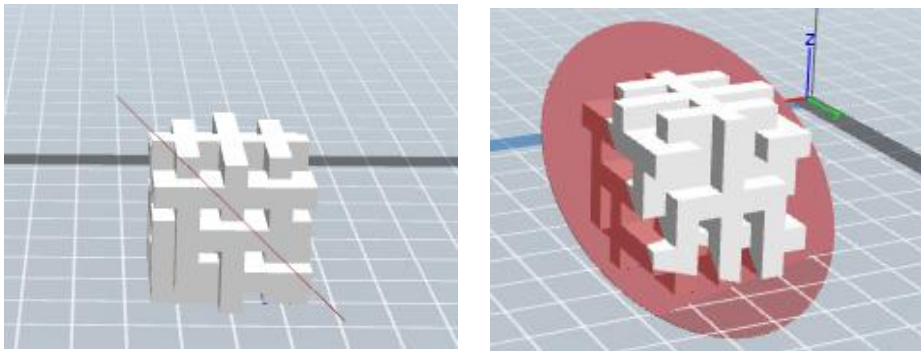

② X Plane

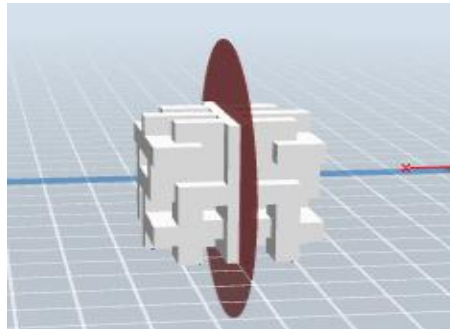

③ Y Plane

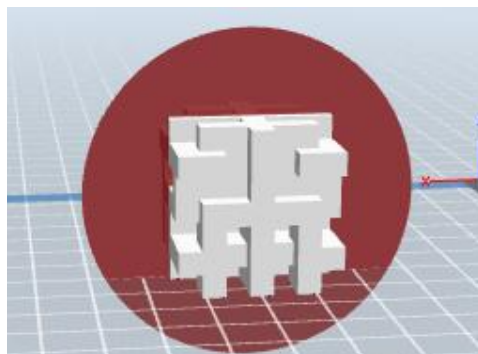

④Z Plane

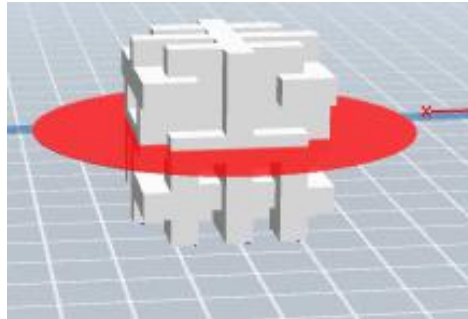

6.2.9 Supports

After loading the model, click **[Edit]--[Supports]** or click the **Supports** icon directly, then you will enter the support edit mode(as shown in the picture below). Click **[Back]** to exit when you finish editing.

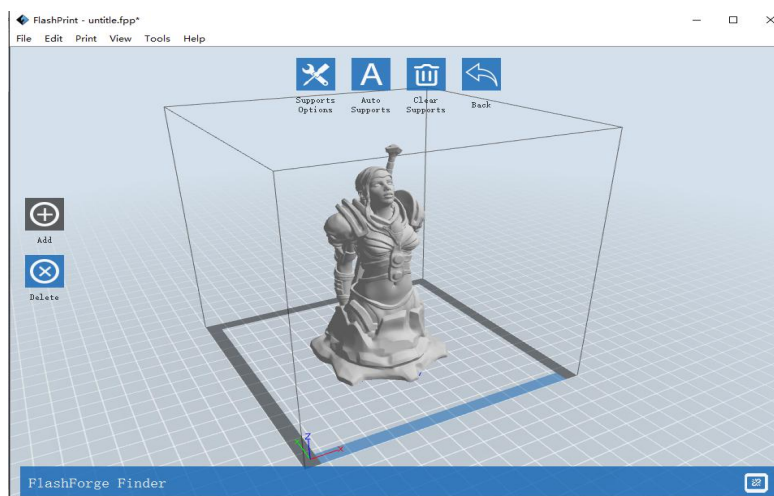

6-10

①Support Options

Click the Support Options, an option box will appear, supports options include “treelike”and “linear”, when choose “treelike”, click **[OK]**, then it will generate treelike structure; when choose “linear”, click **[OK]**, then it will generate linear structure; if it is a model with supports, when you choose one of the supports options, software will judge whether existing supports need to be deleted or not on the basis of

the type of existing support, and will pop up the corresponding prompt to let you make the choice.

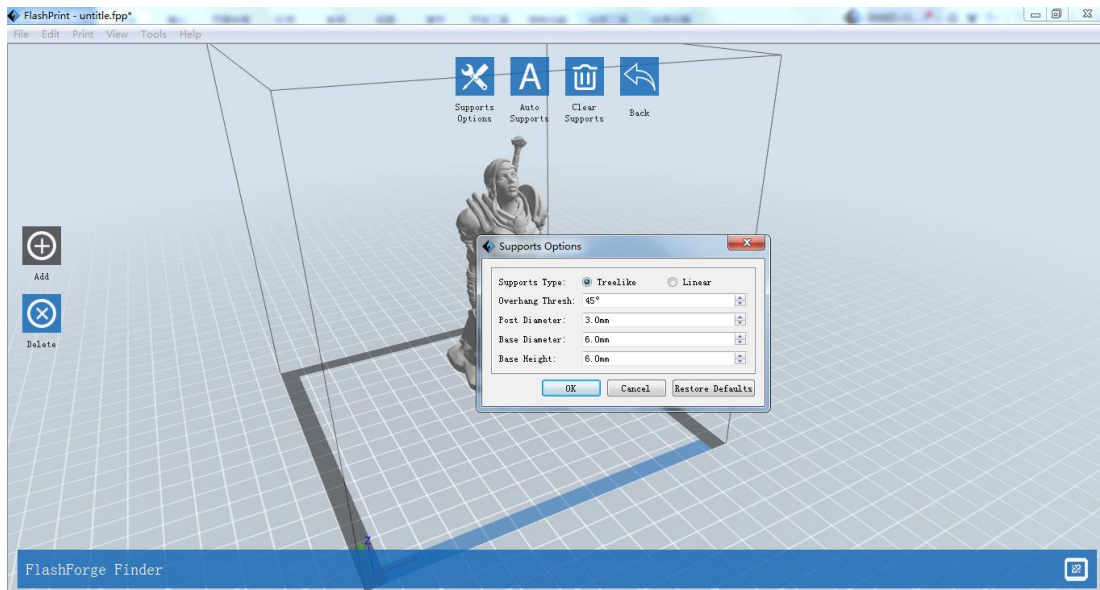

6-11

Click the **[Auto Supports]** button, the software will judge the position where supports are needed and generate corresponding treelike or linear supports. If it is a model with supports, the existing supports will be deleted and new supports will be generated.

③Add Supports

Supports will be added once clicking the **[Add]** button. Move the cursor to the position where supports needed, left-click to choose the starting point of supports, hold down the left mouse button and drag the mouse the supports preview will show up(if support surface doesn't need support or the support column angle is too large, will highlight the support review). Loosen the left mouse button, if support column doesn't meet with model, then support will be generated on origin and terminal point(the highlighted preview support won't generate support structure)

④ Clear Supports

Click [**Clear Supports**], all supports will be deleted. The operation can be repeated via clicking [**Undo**] or pressing the shortcut key **Ctrl+Z**.

⑤ Delete Supports

Supports will be deleted once clicking the [**Delete**] button. Move the cursor to the supports needed deleting, current supports and its subnode support will be highlighted, click the left mouse button to delete these highlighted support.

6.2.10 Print

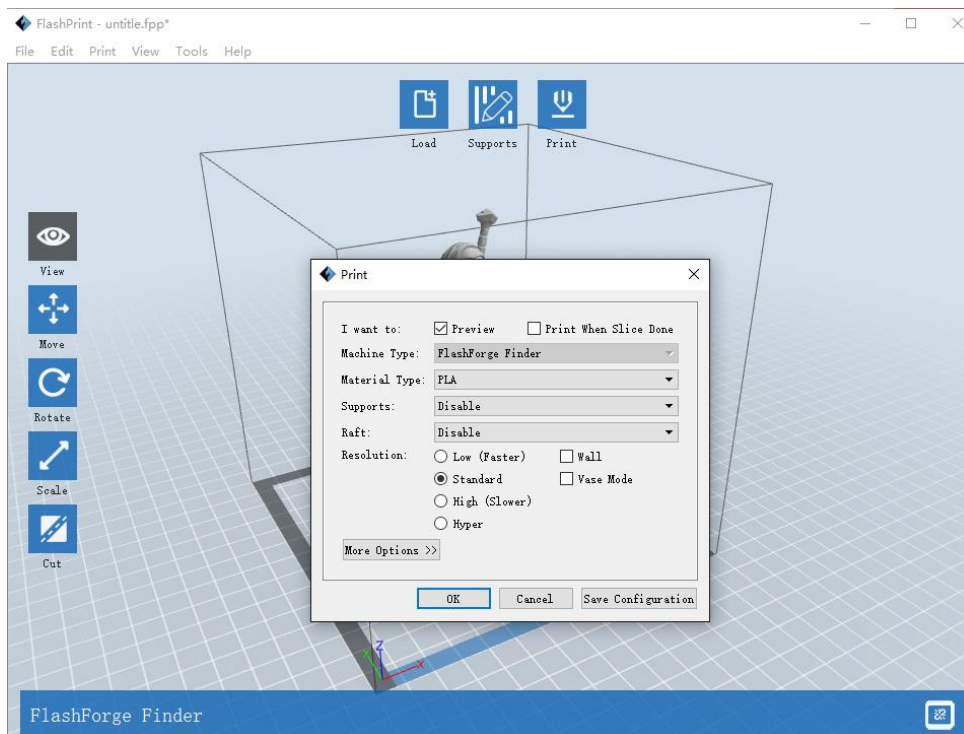

6-12

①**Preview:** Choose to enter preview interface or not

②**Print when slice done:** Print or not when slice done

③**Material type:** Choose according to the type of model

④**Supports:** When print suspended structure models, support is necessary. Click [\[supports\]](#) to create support part for the printing.

⑤**Raft:** This function will help the model to stick well on the platform.

⑥**Wall:** During dual color printing, this function will help to clear the leaking filament of another extruder.

⑦**Vase Mode:** No capping for the model

⑧**Resolution :** You have three resolution solution(with default setting)to choose from, high resolution is corresponding with slow printing speed, opposite for the low resolution. For PLA printing, an extra solution “Hyper” is available.

⑨**More options:** Click [\[More options\]](#) to set for layer, shell, infill, speed and temperature. Different resolution solution is corresponding to different defaults, click [\[Restore Defaults\]](#) to back to default setting.

- **Layer**

- a. **Layer:** Layer thickness of the printing model. With a small value, the surface of the model will be more smooth.

- b. **First Layer Height:** This is the first layer of the model, which will affect the sticking performance between the model and platform. Maximize is 0.4mm, usually the default is ok.

- c. **Shell:** Contains the outside shell value, capping layer value (under vase pattern, top solid layer setting is invalid.)

- **Primeter Shells:** Maximize is 10

- a. **Top Solid Layer:** Maximize is 10, minimum is 1.

- b. **Bottom Solid Layer:** Maximize is 10, minimum is 1.

- **Infill**

- a. **Fill Density** means fill rate.

b. Fill Pattern is the pattern of filling shape which effects printing duration.

c. Combine Infill: You can select the layers for combining according to the layer thickness. The combined thickness should not exceed 0.4mm. “Every N layers” is for all the infills while “Every N inner layers” is only for inner infills, which generally can save print time.

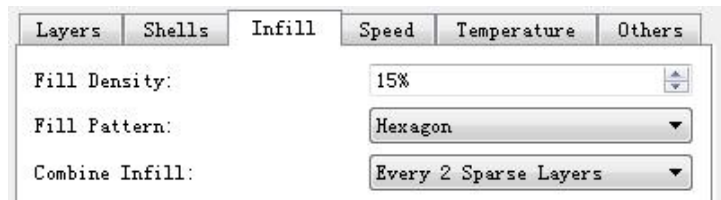

6-13

- **Speed**

a. **Print Speed** is the moving speed of the extruder. Generally, the lower speed is, the better print you will get. For PLA printing, 80 is recommended.

b. Support Print Speed is needed to set when choosing Slic3r as the slice engine which can control the moving speed of the extruder when printing the supports.

c. Travel Speed is to control the moving speed of the extruder under non-printing Status during work. For PLA printing, 100 is recommended.

Note: Modify parameters settings to get better prints as different models need different parameters.

- **Temperature**

Extruder Temperature: Recommended extruder temperature is 220°C.

Note: Different temperatures have subtle influences in prints. Please adjust the temperature according to the condition in order to get a good print.

- **Others**

Pause At Heights: Allows users to pre-set a height in which the print will suspend automatically. The function usually applied when you want to change the filament at a certain point.

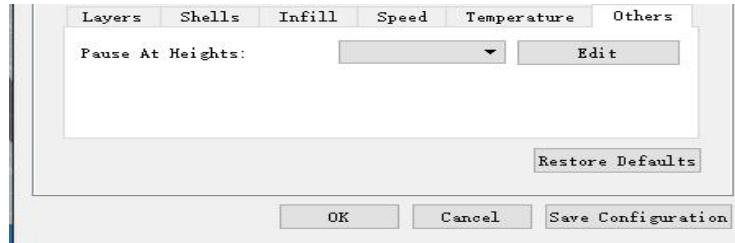

6-14

(6-14) Click[Edit], then you can add or remove a height.

6.2.11 File Menus

①New Project

Click **[File]--[New Project]** can build a blank project. If there is an unsaved modification on previous project, then it will inform you whether the modification needs to be saved or not. Click **[Yes]** will save the modification, click **[No]** will abandon it. If click **[Cancel]** or close tool tip, then will cancel the new project.

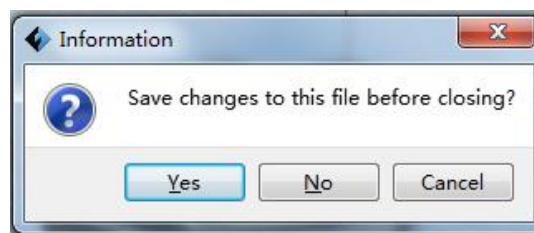

6-15

②Saving

After finishing the model edit and adjustment, there are two ways below to save all models in the scene.

Method 1:

Click **[File]--[Save Project]** in the menu bar to save the file as a project file with the “.fpp”suffix, all models in the scene (include support) are independent . After reloading the files, extruder configuration information and model position will be the same as the configuration during saving.

Method 2:

Click on **[File]--[Save as...]** to save the model as project file .fpp or .stl and .obj. For .stl and .obj, models are integrated as one(include support part). If load it again, only the position of the model was saved, not included the printing parameters.

③ Preferences

Click **[File]--[Preferences]**, you can choose language and if needs detecting update when start

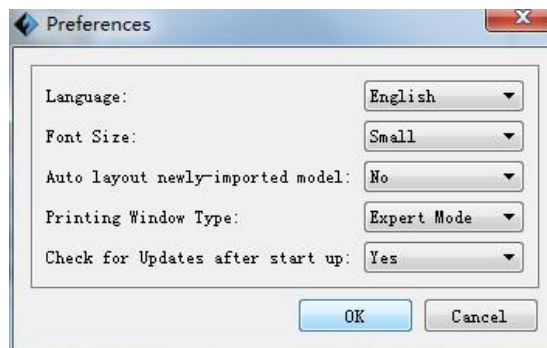

6-16

- **Language:** The software supports six languages, namely, Chinese(simplified Chinese and traditional Chinese), English, French, Korean, Japanese and Russian.
- **Printing Window Type:** Including Base Mode and Expert Mode
- **Check for Update after start up:** It is used to preset if it is necessary to activate the online automatic update function, if choose yes, every time when you open software, it can online detect if it is a new version software, once new version found, it will reminds users to download and install new version firmware.

6.2.12 Edit Menus

①Undo

Allows users to undo the recent edits by the following two methods:

Method 1: Click **[Edit]--[Undo]**.

Method 2: Press the shortcut **Ctrl+Z**.

② Redo

Allows users to redo the most recent edit you have undone to your model file by the following two methods

Method 1: Click **[Edit]--[Redo]**

Method 2: Press the shortcut **Ctrl+Y**.

③ Empty Undo-stack

To clean up the recorded operating steps so as to release the memory.

④ Select All

By the following two methods, you could select all models in the scene. (When models are too small to be seen or out of viewing scope, please click **[Center]** and **[Scale]** buttons to adjust the model.)

Method 1: Click **[Edit]--[Select All]**.

Method 2: Press the shortcut **Ctrl+A**.

⑤ Duplicate

Select the object and duplicate the object through the following two methods:

Method 1: Click **[Edit]--[Duplicate]**

Method 2: Press the shortcut **Ctrl+D**

⑥ Delete

Select the object and delete the object through the following two methods:

Method 1: Click **[Edit]--[Delete]**

Method 2: Press the shortcut **Delete**

⑦ Surface to Platform

After selecting the model, you can make the model surface to platform via the following operation.

Click **[Edit]**--**[Surface to Platform]** into surface to platform mode(As shown in the picture)

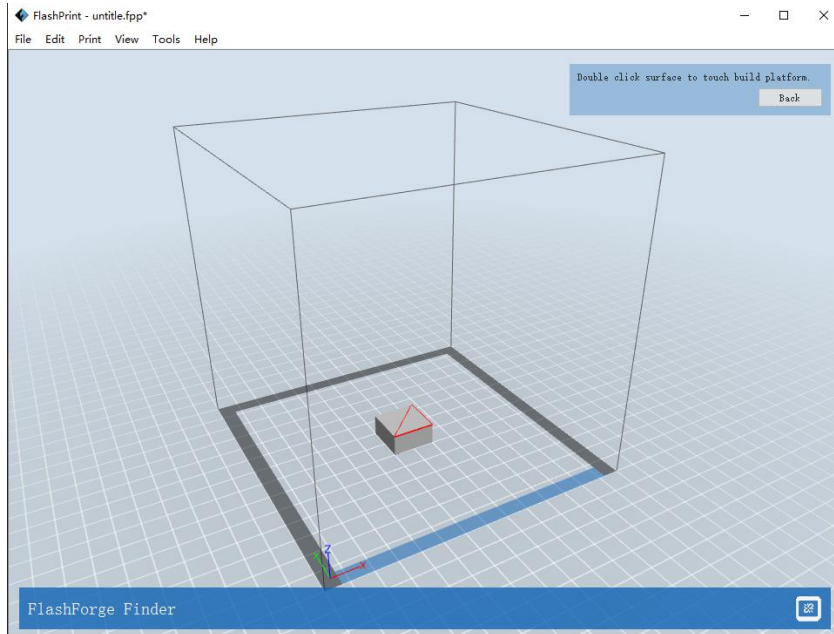

6-17

⑧ Auto Layout All

Click **[Edit]**--**[Auto Layout All]** after loading one or more than one models, all models will be placed automatically as automatic placement rule.

6.2.13 Print Menus

① Connect Machine

You can connect the Guider II with your PC via a USB cable or WIFI.

Note: The machine icon on the bottom right displays the connection status:

Connected



Disconnected



Method 1 : Connect Via USB Cable

- a. Connect your GuiderII with your PC via an USB cable.
- b. Turn on your GuiderII and start Flashprint.
- c. Click **[Print]--[Connect Machine]**, then select USB in the **[Connection Mode]** option and select machine you want to connect in **[Select Machine]** option. If you can not find your machine, click the **[Rescan]** button to scan your machine and select it. Finally click **[Connect]** button to connect to the printer. If you still can not find your machine after rescan, it means you haven't installed the driver in the software.

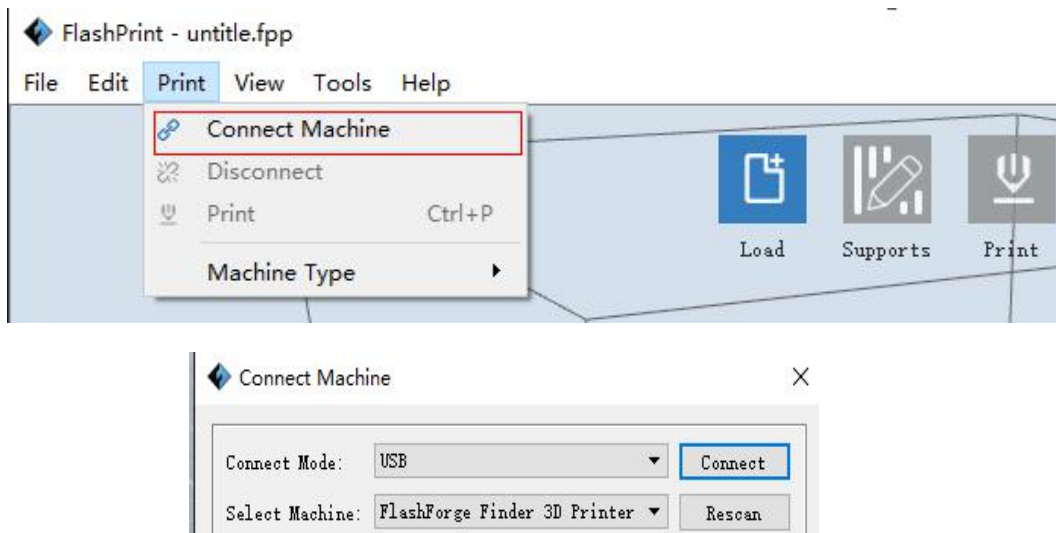

6-18

Method 2 : Connect Via WIFI

①Connect Guider II with your PC under AP mode

- a. Turn on your Guider II
- b. Tap **[Tools]--[Setting]--[WIFI]--[WIFI ON]**
- c. Click on the wireless network on the left bottom, and find the wireless signal-"Guider II". Click **[Connect]** to finish network connection.
- d. Click **[Print]--[Connect Machine]** on Flashprint. Then the following dialog box

pops up. You need to select “Wi-Fi” in Connect Mode. Enter into the IP Address shown on the interface and then click **[Connect]**.

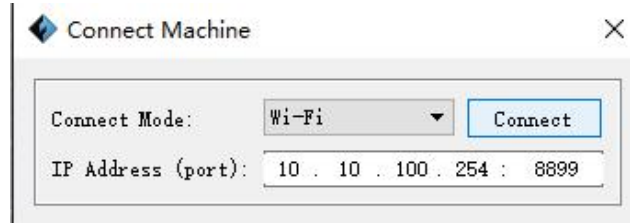

6-19

If successfully connected, you will see the following red mark.



②Connect Guider II with your PC under STA mode

a. Turn on the WIFI of Guider II and connect your PC with Guider II via the WIFI. Press **[Tools]**, **[Setting]**, **[WIFI]**, and **[WIFI ON]**.

b.“Guider II” continuous signal will be found available on the network list.

c. Once your PC is connected with your Guider II . Open the Internet browser and enter “**10.10.100.254**” and enter the default **user name(admin) and password(admin)**.

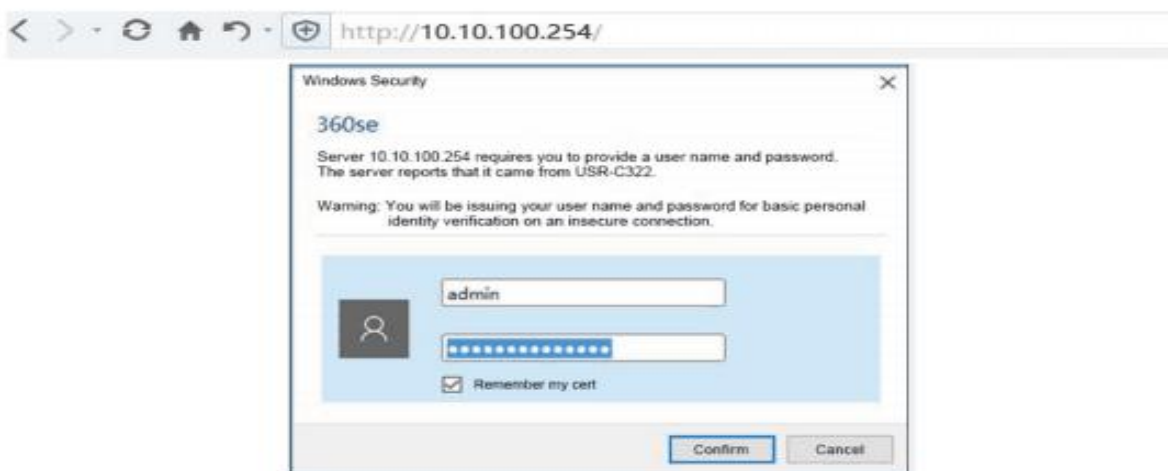

6-20

③ You will enter the WIFI setting panel, it displays as follows:

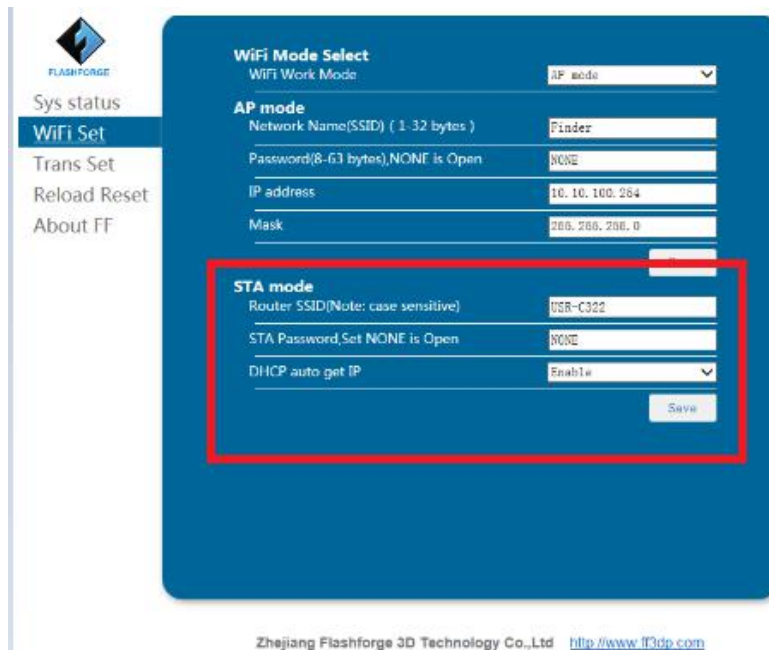

6-21

d. Select WIFI mode as STA mode, and then complete the corresponding setups, you can change the SSID(the WIFI's name) and the password, select **[Enable]** in DHCP auto get IP, then click **[Save]**. The following interface will appear.

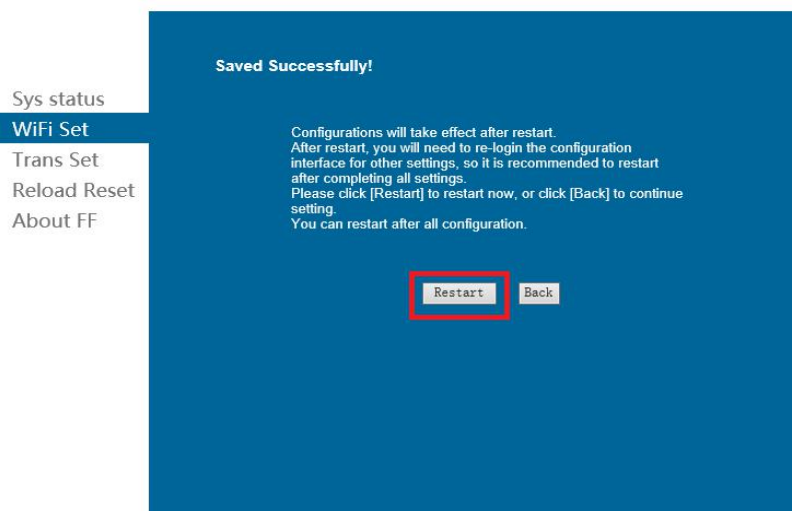

6-22

e. Click the **[Restart]** button. You need to restart your Guider II 's WIFI. And then

your Guider II will connect with your computer via the WIFI that you've set up.

② Disconnect Guider II

Click **[Print]--[Disconnect]** to disconnect your PC and Guider II.

6.2.14 Tool Menus

① Control Panel

After connecting PC with Guider II, click **[Tools]--[Control Panel]** to open the control panel.

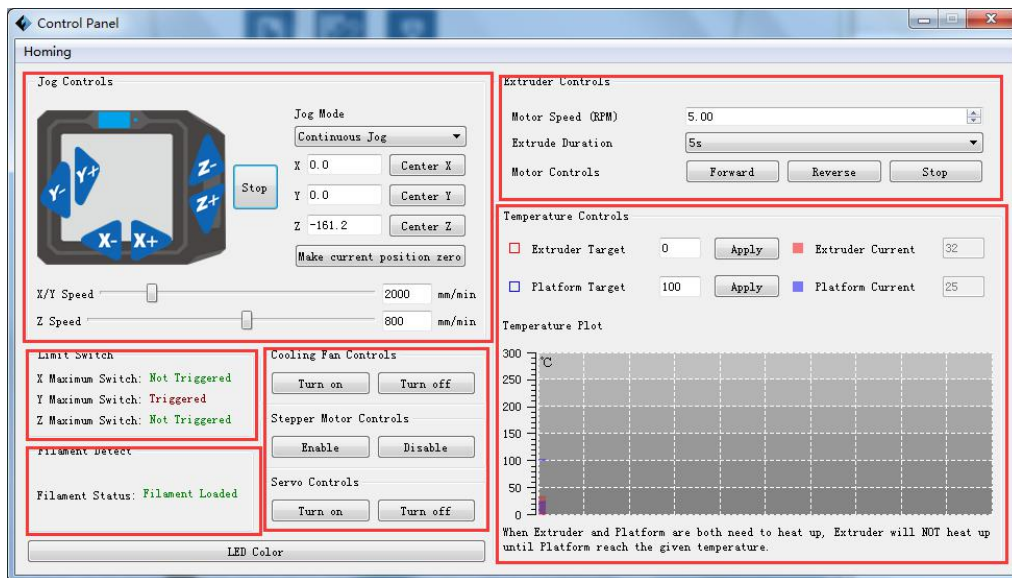

6-23

• Jog Controls

a. Jog Mode: Select the distance that extruder/ build plate move a single time (that is, the distance extruder/ build plate move upon your single click).

b. Six blue arrow direction button: Control the move along X/Y/Z axis. X/Y axis button control extruder move, Z axis button control build plate move. Click X-, extruder will move leftward a specified distance; Click X+, extruder will move a specified distance rightward. Click Y-, extruder will move forward a specified distance; Click Y+, extruder will move backward a specified distance. Click Z-, build plate will

move upward a specified distance; Click Z-, build plate will move downward a specified distance. (Specified distance refers to the move distance you set in Jog Mode.

c. Stop: Click the [\[stop\]](#) button to abort the current movement. **d. XYZ coordinate frame on the right side:** Show the current position of extruder/build plate.

e. Make Current Position Zero button: Set the current position of the extruder/build plate as (0, 0, 0). (**NOTE:** X, Y, and Z boxes are for display purposes. Changing the value in the boxes will not affect anything.

f. Center X/Y/Z button: Extruder and build platform will back to the zero (0, 0, 0) you set last time.

g. X/Y Speed and Z Speed: Set the move speed of extruder/ build platform.

- **Limit Switch:** In order to protect your Guider II, three limit switches are equipped to control the maximum position, and the three limit switches corresponding to X/Y/Z axis limit switch. It has two status:

a. Not Triggered: If the extruder/build plate don't move to its maximum, X/Y/Z axis limit switch is not triggered, and shows “**Not Triggered**”.

b. Triggered: If the extruder/build plate moves to its maximum, X/Y/Z axis limit switch is triggered, and shows “**Triggered**”.

- **Stepper Motor Controls:** Allows users to control to stepper motor. Click [\[Enable\]](#), and lock the motor so it does not allow any movement; click [\[Disable\]](#), and unlock the motor to be controlled manually.

- **LED Color:** Allows users to change the LED color of Guider II.

- **Extruder Controls:** You can set the value of “**Motor Speed(RPM)**”, which can control the rotation speed of filament feeding wheel. The motor rotation time can be controlled via setting the value of “**Extruder Duration**”. Generally we suggest the users choose option of continuous time 60 seconds. The filament must loaded in the

extruder before motor starts. **Therefore, do not start rotation operation until the extruder temperature reaches to the printing temperature of filament.** For PLA filament, the extruder temperature should reach 200°C, after reaching the extruder temperature, click the **[Forward]/[Reverse]** rotation button to control filament load and filament unload. Furthermore, if you want to stop filament load and unload, you can click **[Stop]**.

- **Temperature Control:** Input the temperature you want to get in the left frame, click **[Apply]**, the printer will automatically heat the corresponding part, the right side shows the current actual temperature of corresponding part. After starting heating, the below curve of temperature form will start to change, different color correspond different parts' temperatures

② Update Firmware

Every time when you start Flashprint, it will automatically detect and download the up-to-date firmware. If any update is available, a dialog box will pop up for reminding the users to update.

Step 1: Click **[Tools]--[Update firmware]**. It needs to cut off connection before updating firmware. If software and printer are already in connection, it reminds you cutting off the connection, choose **[Yes]** and go on to the next step.

Step 2: Choose corresponding printer type and firmware version and click **[OK]** in the firmware updating box. After confirming the printer is in free state, the software will automatically update the firmware

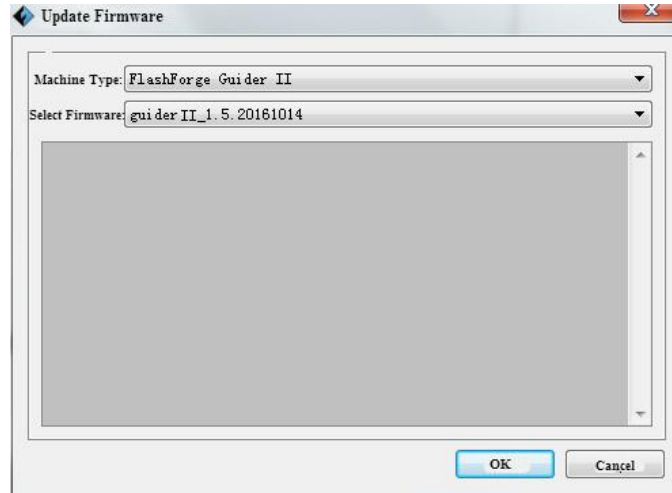

6-24

Step 3: Reboot you Guider II and wait for 4-5 seconds, then you can see the update process bar. When the update finishes, it will go back to the main interface.

Step 4: Tap[Tools]--[About] to check] to check whether the updated version is right.

③ On Board Preferences

When the computer and printer are in connection, click [Tools]--[On Board Preferences], you can check the printer name.

④ Machine information

When the computer and printer are in connection state, click [Tools]--[Machine information], you can check the machine type, machine name and firmware etc.

6.2.15 Help Menus

① **Help Contents:** Click [Help]--[Help Contents], you can read the help contents.

② **Check for Updates:** Click [Help]--[Check for Update] to detect the available updates online.

③ **About FlashPrint:** Click [Help]--[About Flashprint], the software information

box will pop up. The contents include the current software version and copyright information.



6-25

Chapter 7: Basic Printing

This chapter will provide a step-by-step guide on turning a 3D model into a physical reality. Before proceeding, it is recommended that you'd better go over prior chapters on loading/unloading filament, leveling the build platform, and the functions and capabilities of FlashPrint.

7.1 Generate a Gcode

(7-1) Double-click the icon of Flashprint to start the software.



7-1

(7-2) Click **[Print]**--**[Machine Type]** to select **Flashforge Guider II**

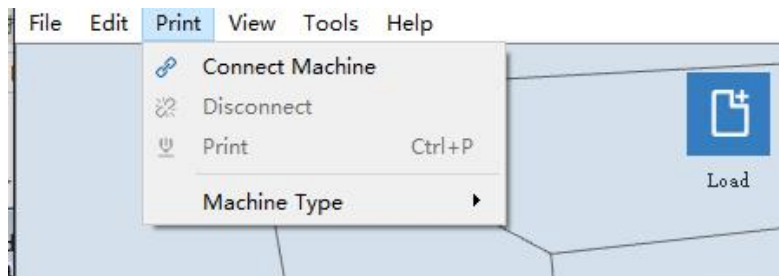

7-2

(7-3) Click the **[Load]** icon to load a .stl model file and the object will display on the build area.

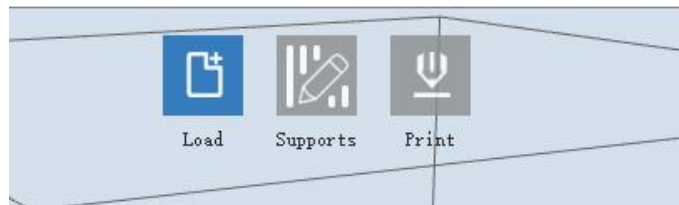

7-3

(7-4) Click **[Edit]**--**[Surface to Platform]** to make your model perfectly positioned

on the build area. Click **[Back]** and double-click the **Move** icon again, then click **[On the Platform]** and **[Center]** to ensure the model be on the platform.

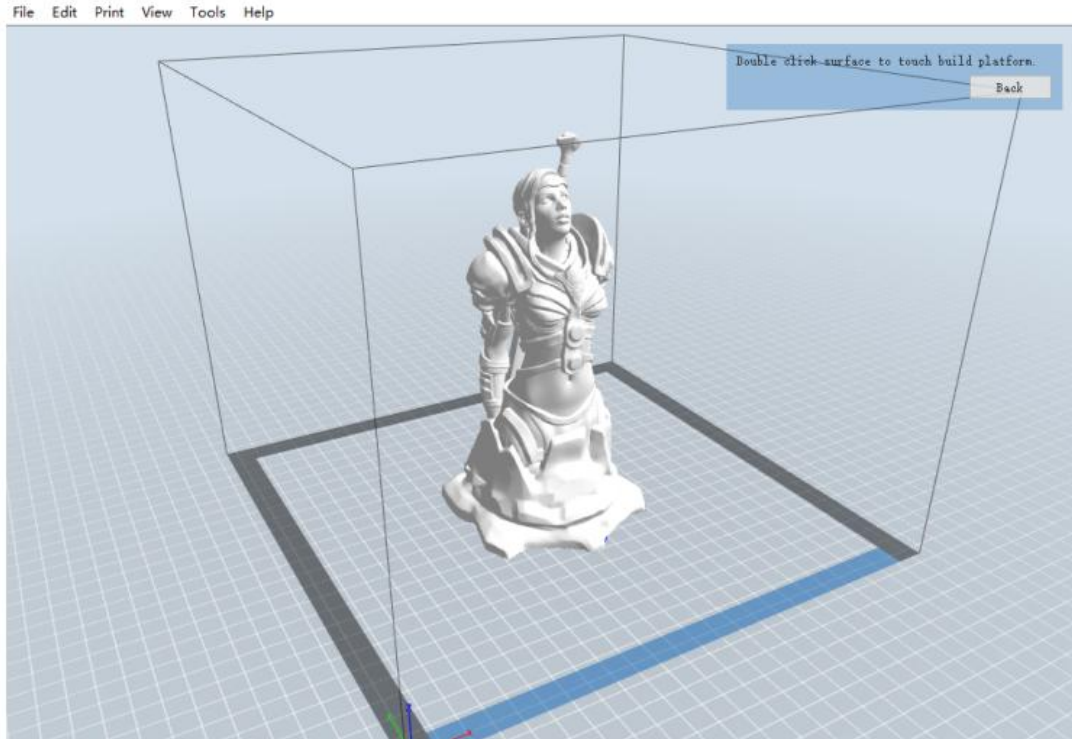

7-4

Note: If you've place your model in a right place, you can skip the step above.

(7-5) Click the **Print** icon on the top, you should make some setups for your print job.

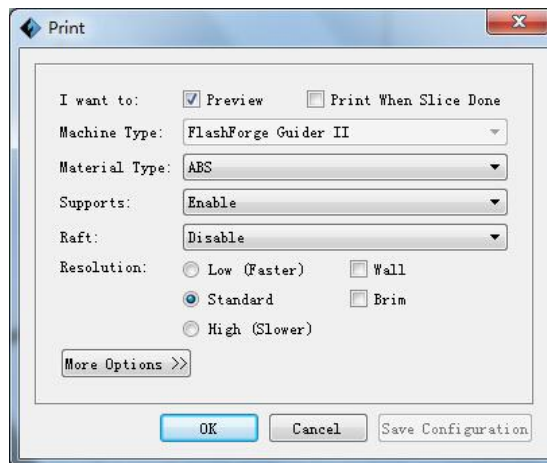

7-5

Preview: If you check the **[Preview]** box, you can preview your model after slicing is done.

Print When Slice Done: If you print via USB cable, you can check the box, while if you print via USB, you should not check the box.

Machine Type: Flashforge Guider II

Supports: If you print a model with supports, you should click the inverted triangle and select **[Enable]**.

Raft: You are suggested to select **[Enable]**.

Resolution: You are suggested to select **[Standard]**

More Options: You are suggested to keep them default.

Click **[OK]** to select the path to save the Gcode file. You can rename the file as you like and save it as a .g or .gx file, click **[Save]** to generate a Gcode file.

Note: .gx files are available for preview while the .g files are not. They are displaying as follows:

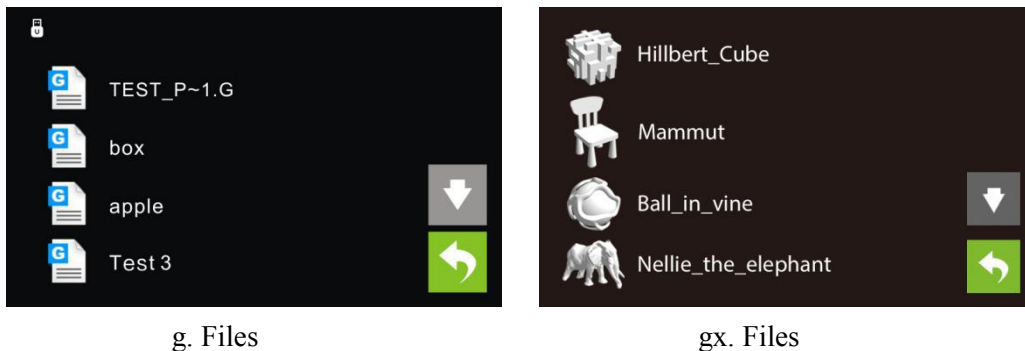

Next, we are going to print the model.

7.2 Print Methods

After generating the Gcode file, you can transfer it to your Guider II . You can transfer the file through USB cable and USB stick.

7.2.1 Print from Computer (USB connection)

- ① Connect your Guider II with your PC via a USB cable.
- ② Turn on your Guider II , level the build plate and load the filament.

③ Click **[Print]** and transfer your Gcode file to your Guider II . After completing transference, the printer will heat up automatically. And when heating finishes, the print will start to build the model.

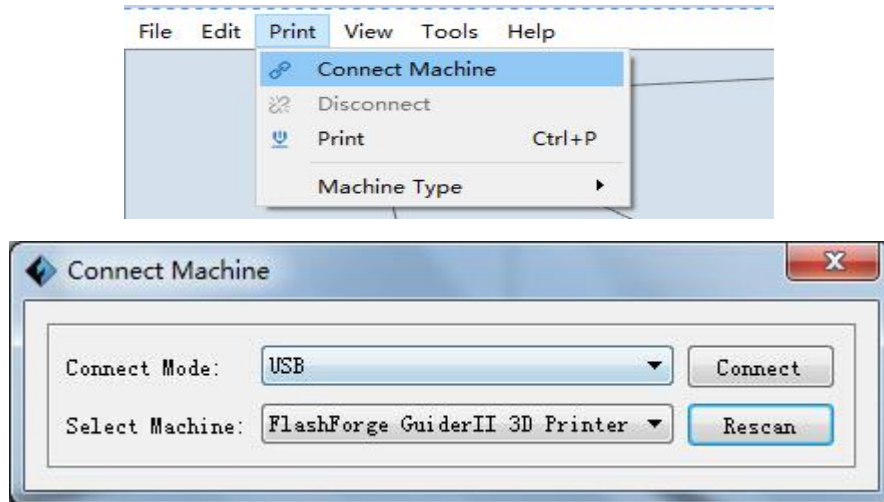

7-8

④ When your PC connects with FlashPrint successfully. The status box on the bottom right displays the real-time nozzle temperature. After finishing preheating, your Guider II starts the print job directly.

7.2.2 Print from Computer (WIFI connection)

- ① Connect your Guider II with your PC via WIFI.(Please refer to 6.1.13)
- ② Turn on your Guider II , level the build plate and load the filament.
- ③ Click **[Print]** and transfer your Gcode file to your Guider II . After completing transference, the printer will heat up automatically. And when heating finishes, the printer will start to build the model.

If you want to print a Gcode from a local folder, you just need to load the file into Flashprint at the status of USB connection or WIFI connection, then click the **[Print]** button on the top-right.

- Load the target Gcode file into FlashPrint.

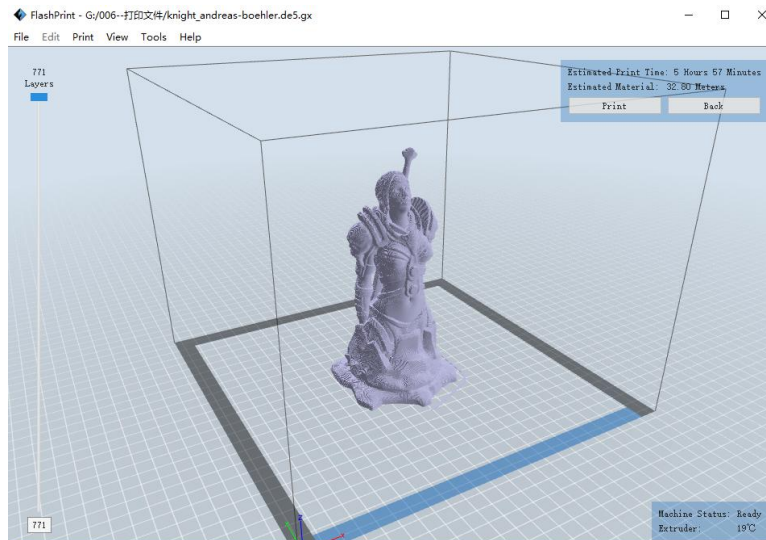

7-9

- Click the **[Print]** button, the PC will transfer the Gcode file to the printer.

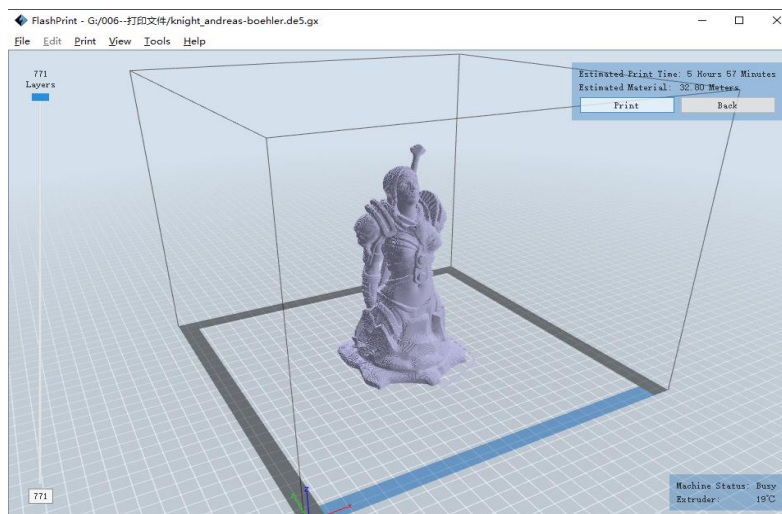

7-10

- After finishing transferring, the printer will heat up automatically. And when heating finishes, the print will start to build the model.

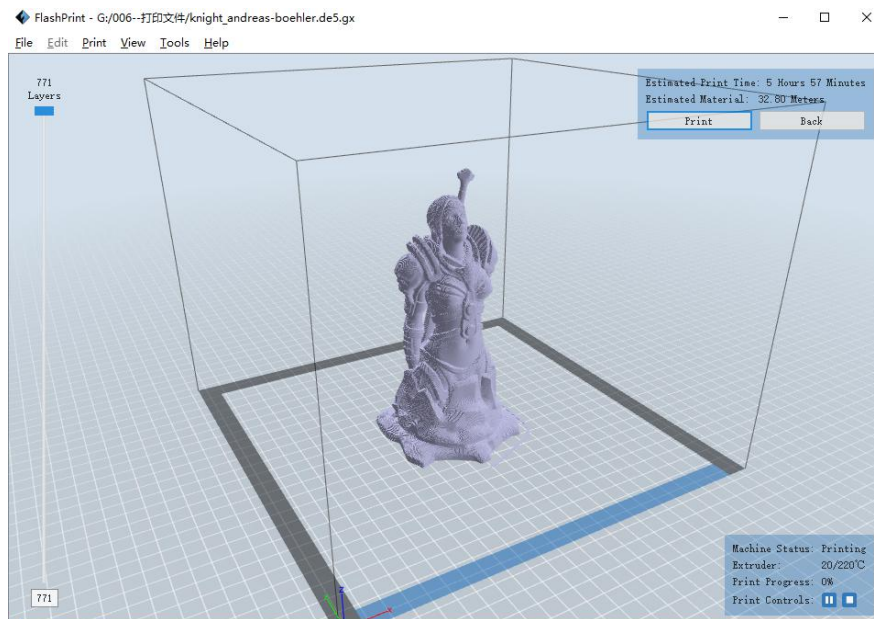

7-11

③ Tap **[Print]** and then tap the **SD Card** icon in the middle. The file(s) will be displayed on the screen. Select the file you want to print and tap **[Print]**. The file will be transferred to the printer.

⑥ And the printer will heat up the nozzle automatically and start to print after the nozzle reaches the aimed temperature.,

Abort: To stop heating and printing. Once you tap **[Abort]**, the process is irreversible.

Pause: To suspend the print job, you can tap it again to resume it. You can use this function when you want to change the filament halfway.

Chapter 8: Advanced Printing

When you get familiar with your Guider II , you will definitely want to accomplish some advanced prints. This chapter will take you to get to know the advanced printing skills.

Expert Mode grants the users more freedom of parameter edition. There are two modes are available for users, one is “Basic Mode” and the other is “Expert Mode”.

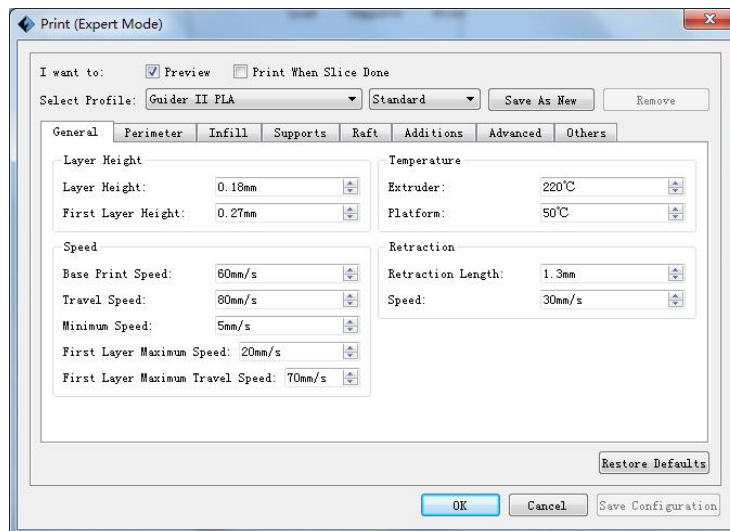

8-1

Select Profile: Allows users to select the required scheme. There are three options for users (low/standard/high/high) and the default is PLA standard. Different schemes correspond to different parameter settings. High-quality scheme produces high-resolution object but at a low speed. On the contrary, low-quality scheme produces low-resolution object but at a high speed. When printing with PLA, users will find a “hyper” option available.

General:

a. Layer Height

Thickness of each layer. The less thickness of layers, the more time will be used and the better model will be printed.

b. First Layer Height

When printed with thinner layers, comparative thicker bottom layer could improve adhesion and tolerance for non-perfect build plates.

2) Speed

a. Base Print Speed: The fiducial value of extruder's movement speed during printing(For subsequent speeds counting). With a lower speed, the printer can build an objects with higher resolution and more smoothness.

b. Speed at which extruder moves when not extruding filament.

c. Minimum Speed: The minimum extruder's movement speed during printing

d. First Layer Maximum Speed: The max printing speed for printing the first layer(Note: It's invalid to the model which has a raft)

e. First Layer Maximum Travel Speed: The max travel speed for printing the first layer(Note: It's invalid to the model which has a raft)

3) Temperature

It displays the temperature of "Extruder".

4) Retraction

a. Retraction Length: Amount of retraction. Retraction can help users reduce stringing or oozing during printing. (The default value shall be suggested.)

b. Speed: Speed at which the filament is retracted. The default value shall be suggested.

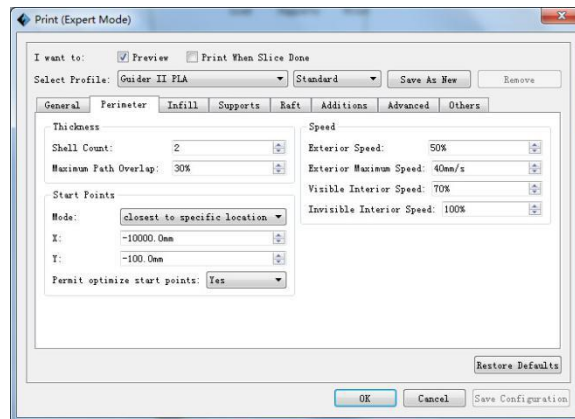

8 -2

Perimeter

1) Thickness

- a. Shell Count: Numbers of laps for each layer's shell. Maximum: 10; Minimum: 1.
- b. Maximum Path Overlap: Max amount of overlapping extrusion for some models, especially small models.

2) Speed:

- a. Exterior Speed: Speed at which the exterior shell is printed.
- b. Visible Interior Speed: Speed at which the visible interior shell is printed.
- c. Invisible Interior Speed: Speed at which the invisible interior shell is printed.

3) Start Points

- a. Mode: There are two options for Start Point mode. One is "closest to specific location", the other is "use random start points".
- b. X: The coordinate value of X
- c. Y: The coordinate value of Y

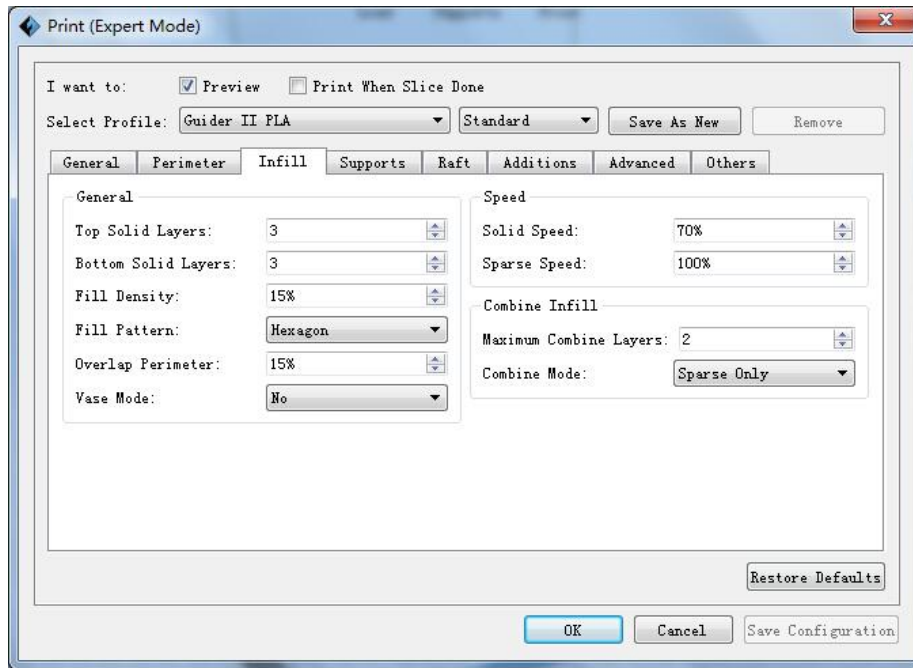

Infill

General

- a. Top Solid Layer: Number of solid layers on the upper surface of model.
- b. Bottom Solid Layer: Number of solid layers on the under surface of model.
- c. Fill Density: Determines the interior solidity of the model.
- d. Fill Pattern: Determines the infill pattern used for the interior of part, Hexagon infill has higher strength and Line infill take less print time.
- e. Start Angle: Angle of the infill's first layer
- f. Overlap Perimeter: The overlap width between the infill and the shell.
- g. Vase Mode: When enabled, the interior infill and top solid infill will not printed.(Using this option will force 0% infill with only a single perimeter)

2) Speed

- a. Solid Speed: Speed at which the top/bottom parts are printed.
- b. Sparse Speed: Speed at which the infill is printed.

3) Combine Infill

- a. Maximum Combine Layers: Select the layer amount according to the layer height.

The total height shall not be over 0.4mm.

b. Combine Mode: Including “Sparse and Solid” and “Sparse Only”. “Sparse Only” mode only applies for the inner infill layers.

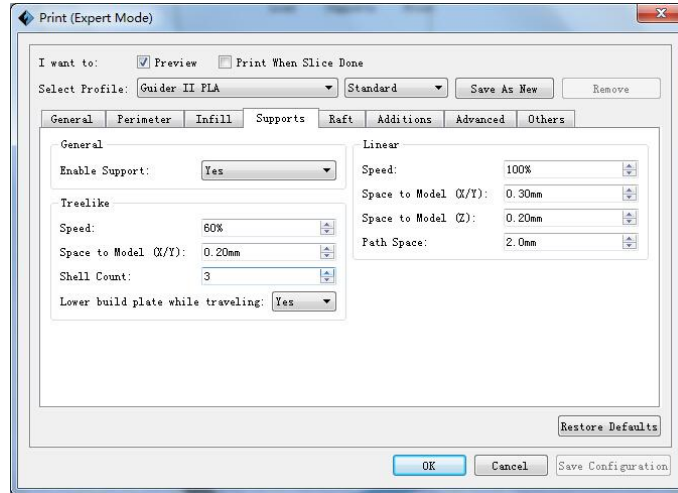

8-4

Support

1) General

a. Enable Support: Allows users to turn on/off the support option. Support structure can prevent the model from collapsing. If choosing “Yes”, then both treelike and linear supports are available for setting up. If choosing “No”, then both treelike and linear supports are unavailable for setting up.

2) Treelike

a. Speed: Speed at which the treelike supports are printed.

b. Space to Model(X/Y): The gap between the treelike supports and the model contact surface (in the X/Y directions).

c. Shell Count: To control the printing laps for support’s outer shell.

3) Linear

a. Speed: Speed at which the linear supports are printed.

b. Space to Model(X/Y): The gap between the treelike supports and the model contact surfaces (in the X/Y directions).

c. Space to Model(Z): The distance between the treelike supports and the model

contact surface (in the Z direction).

d. Path Space: The distance between the adjoining paths.

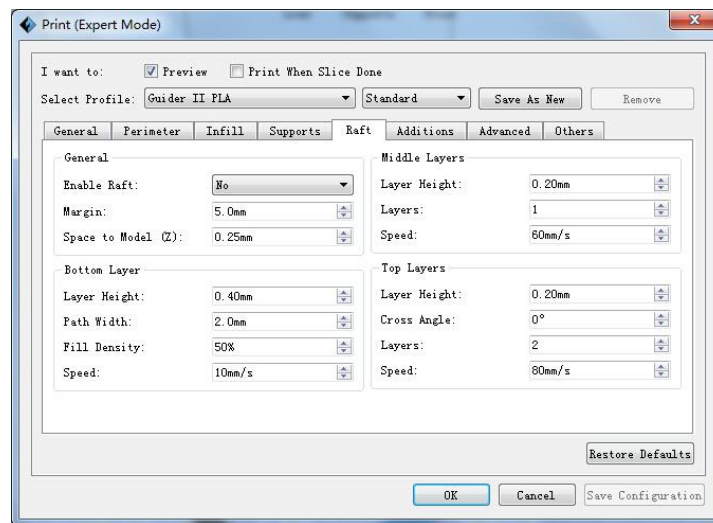

8-5

Additions

1) Raft

a. Enable Raft: Enable to print raft during printing. Raft could help the model stick to the build plate.

b. Margin: The distance between raft's outline and outline of model's first layer. If the raft is enabled, the extra raft area around the object is also enabled. Increasing the margin will create a stranger raft while using more materials and leaving less area for your object.

c. Space to Model(Z): The gap between the raft top and the model's first layer.

2) Pre-extrusion

a. Enable Pre-extrusion: Enable the extruder to pre-extrusion until .

b. Space to Model: The maximum distance between the pre-extruded filament and model's first layer.

C.Path Length: The filament length of pre-extrusion.

d. Speed: The printing speed of pre-extrusion.

3) Wall

- a. Enable Wall: Enable the extruder to print wall during printing. Enabling wall can prevent the object from stringing or oozing to some extent.
- b. Shell Count: To control the printing laps for support shell.
- c. Space to Model: The minimum distance between the wall and model.
- d. Speed: Speed at which the wall is printed.

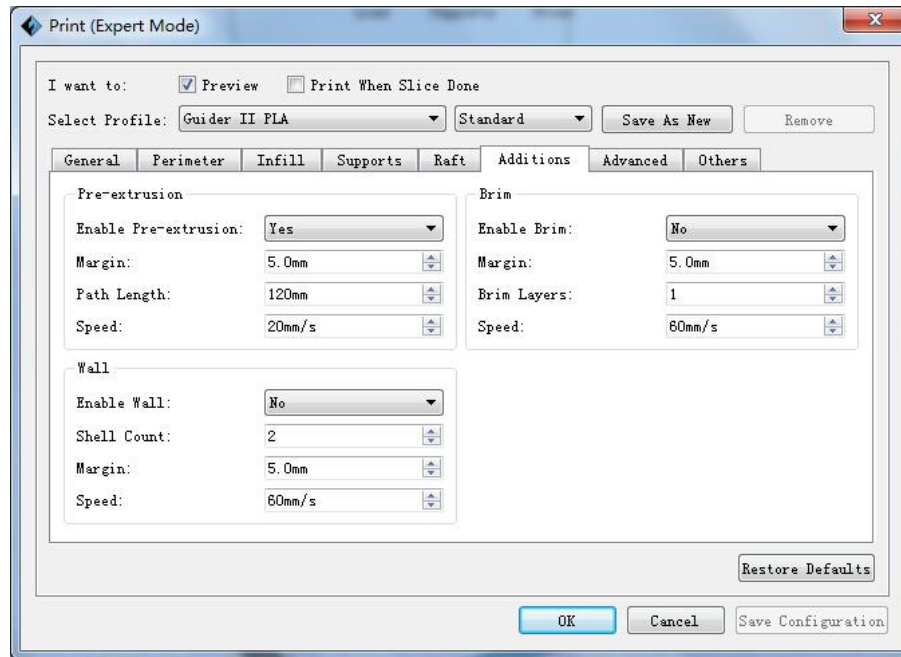

8-6

more heater will produce.

b. Y-Axis: Voltage parameter of Y-axis stepper motor. The bigger the value is, the more heater will produce.

c. Z-Axis: Voltage parameter of Z-axis stepper motor. The bigger the value is, the more heater will produce.

d. A-Axis: Voltage parameter of right-extruder stepper motor. The bigger the value is, the more heater will produce.

e. B-Axis: Voltage parameter of left-extruder stepper motor. The bigger the value is, the more heater will produce.

2) Others

a.Extrusion Ratio: The filament amount extruded by the extruder. Default: 109%

Max:125% (Usually the default ratio is suggested)

b. Path Width: The width of the path, the default value is 0.4mm. Keeping default is suggested.

c. Path Resolution: The default value is 0.1mm. The bigger the value is, the lower the extrusion resolution is. On the contrary, the extrusion resolution is much higher.

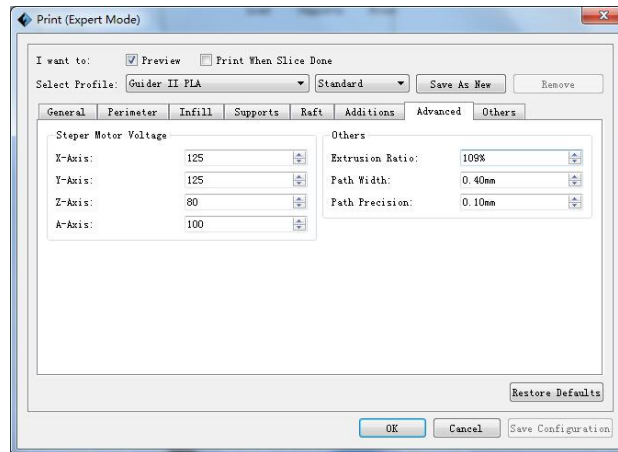

8-7

Others

Dimensional Adjustment

a. Enable Adjustments: Enable software to make compensation for errors.

b. External Compensation: Enable software to make compensation for the outer diameter error.

c. Internal Compensation: Enable software to make compensation for the inner diameter error.

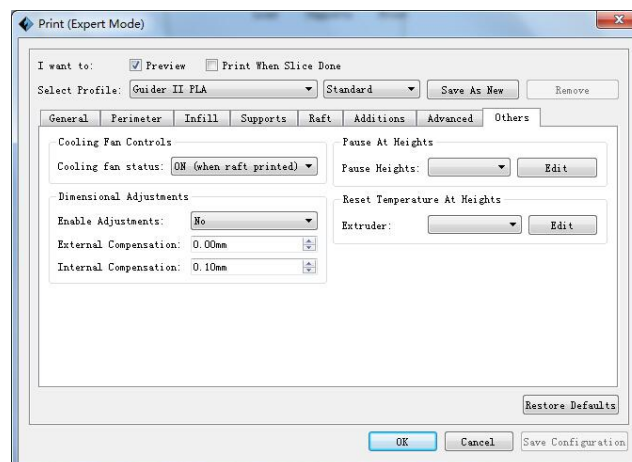

8-8

Save as new

Allows users to save the model as a new file after parameter modification.

How to do?

After getting all the required parameters modified, click [Save as new], then a dialogue box will pop up. Users need to enter the file name into the box, then click [OK]. Click the drop-down menu of [Select Profile], the new added scheme can be found in the list.

Remove

Allows the users to delete the added scheme(s). Select one of the added schemes, click [Remove] and a dialogue box will pop up for confirmation. Click [Yes] to remove it or click [No] to cancel the current operation.

Restore Default: Allows users to restore to the default settings.

Save Configuration: Allows users to save the present configuration.

8.1 Skills on Supports

(Reference Video: [Skills on Supports](#))

Support structures enable the printing of models with steep overhangs and cantilevered sections. The Guider II 3D printer utilizes Fused Filament Fabrication (FFF) technology, which works on the additive manufacturing principle of heating and laying down material layer by layer to create an object. Many sophisticated 3D print designs require materials to be deposited on a layer where there was not a previous layer, or the designs have steep angles which might cause undesired drooping during the print. In these cases, support structures are needed to ensure objects integrity and print quality.

① Principle of 45 Degrees

Generally speaking, if the 3D model has an overhang of more than 45 degrees, you

will need supports. This angle is determined by the material, layer height, extrusion width, and temperature. It is critical to adjust the support structures accordingly to ensure the best print result, especially for large 3D prints. The principle is raised by a stage designer and widely accepted among the 3D printing industry.

② Principle of Proportionality

As for the application of supports, users are suggested to comply with the principle of proportionality. Even though the supports algorithm has been developing, adding supports intelligently cannot be realized at present. Therefore, users are always oriented in adding the supports. As we all know, excessive supports will definitely result in difficulty in supports removal, while limited supports cannot ensure the stability of the model. Since FashPrint has the function of manual modification, users can add proper supports to their models according to the daily experience and the academic principles.

● Support Types

Linear Support Structure: Suitable for models with large-area overhang(s).

Features: Full coverage of supports improves the model stability. But the supports on the surface are difficult to be removed and will definitely reduce the print quality.

Treelike Support Structure: Suitable for models with small area overhang(s). (You are suggested printing a raft)

Features: Treelike support structure is proprietary to Flashforge Corporation. And this structure can save support material and can be easily removed. However, compared with the linear support structure, it's of less stability. So you are suggested to manually add more supports after auto-generating treelike supports.

Auto-supports

Eg : 1) Model with Large-area Overhang

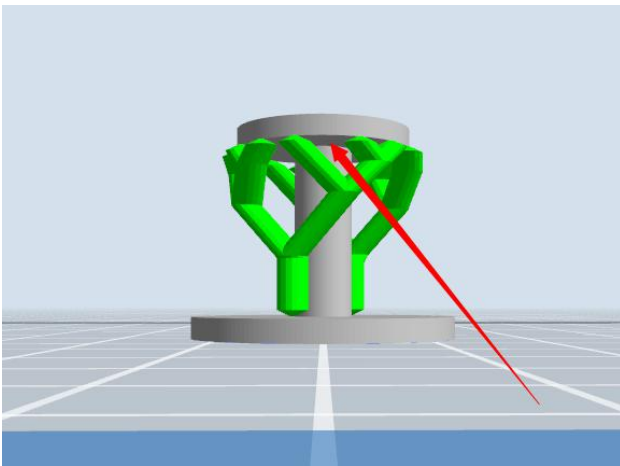
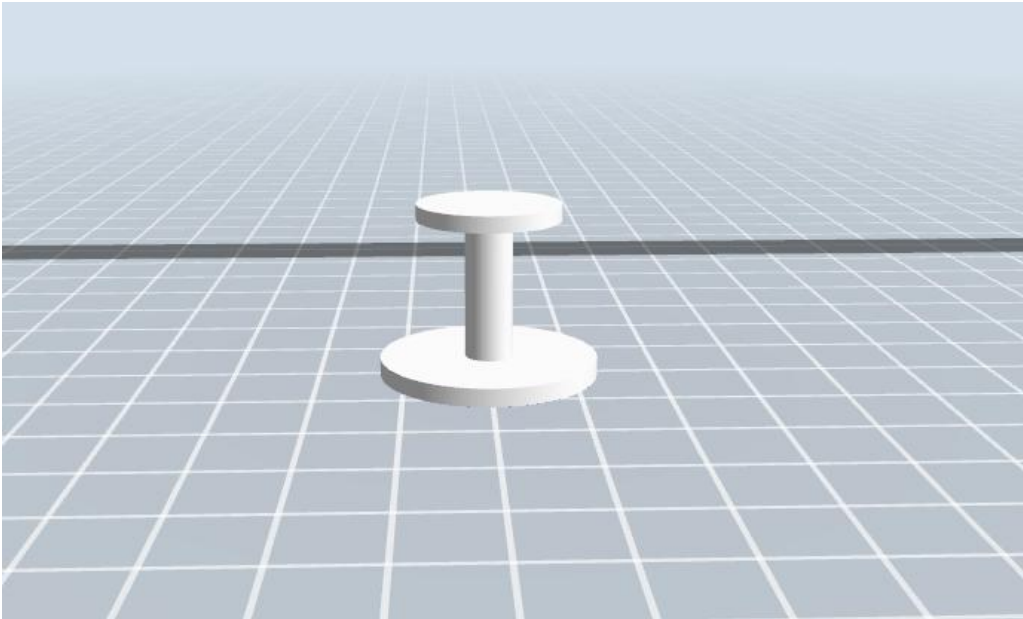

Right: Treelike support structure

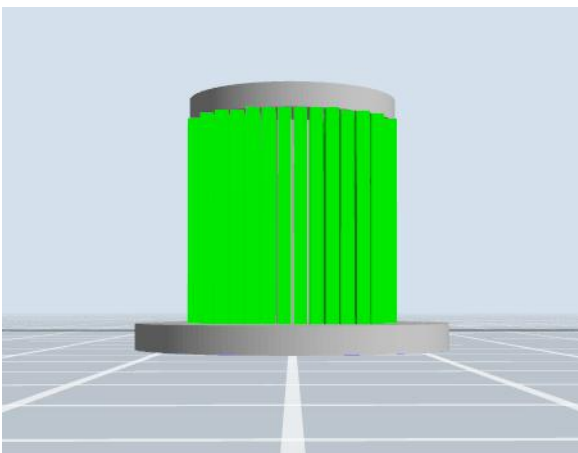

Wrong: Linear support structure

2) Model with Small-area Overhang

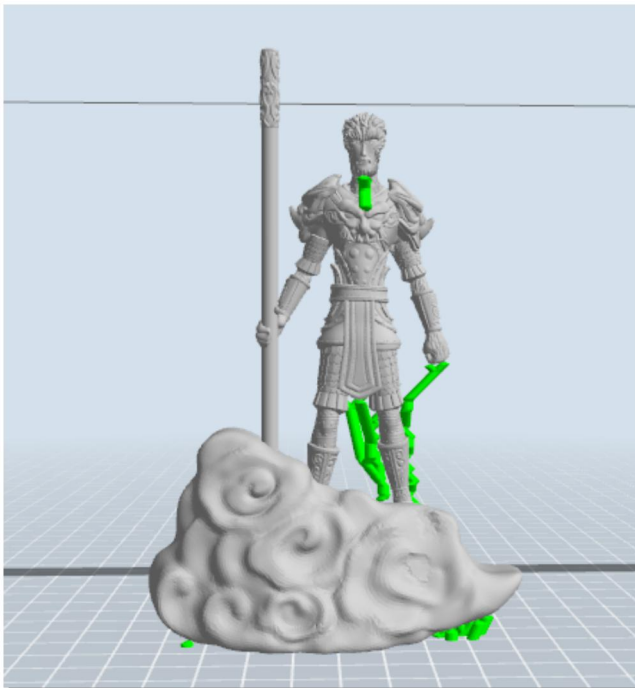
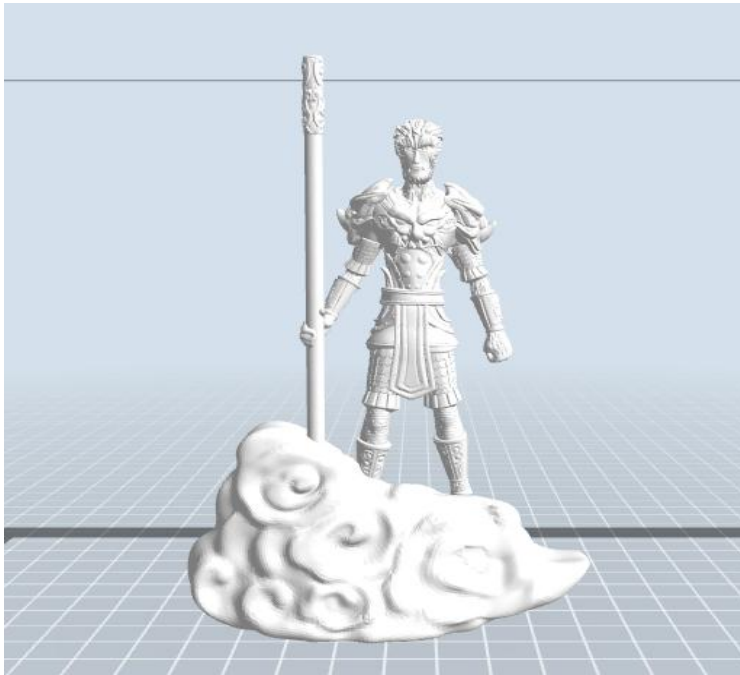

Right: Treelike support structure

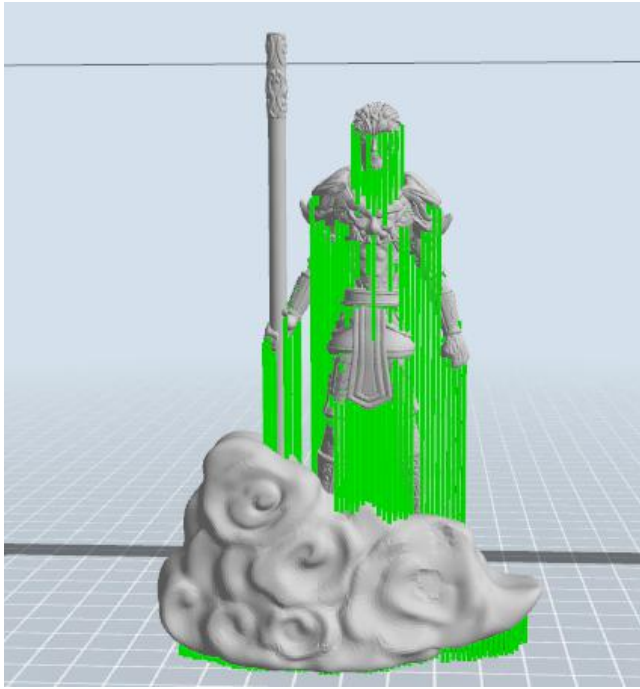

Wrong: Linear support structure

Manual Modification

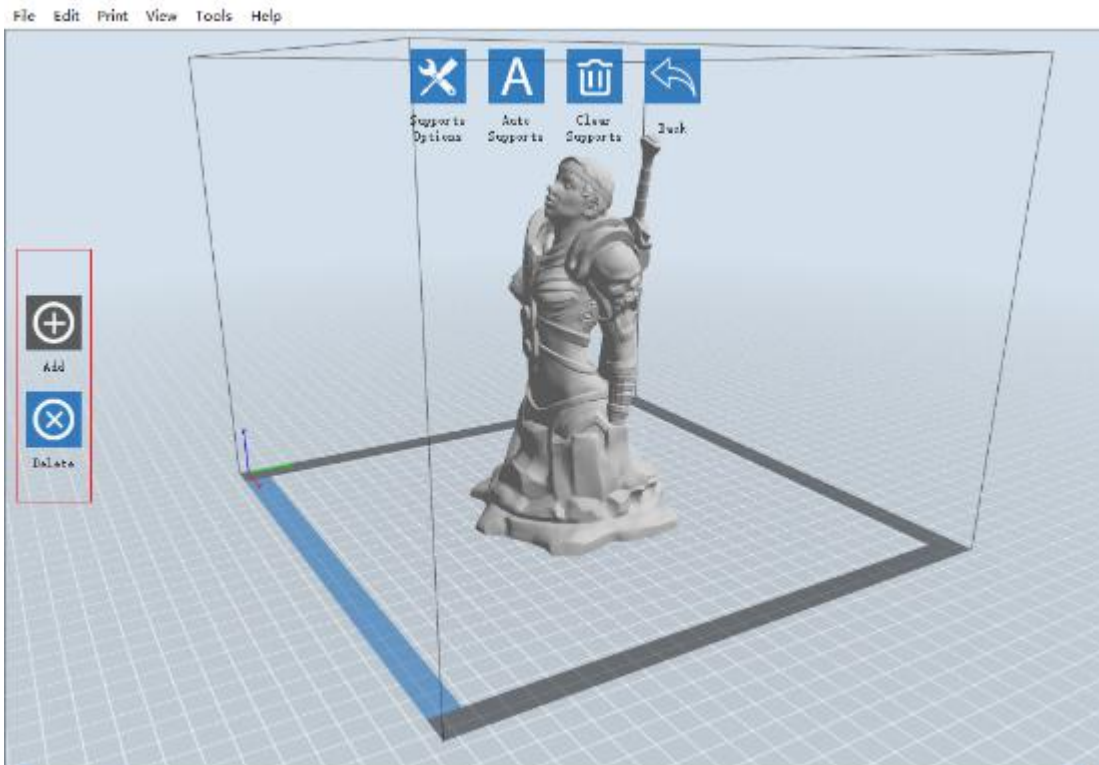

8-9

For the experienced 3D printer users, the [Add] and [Delete] buttons are suggested using for manually adding or deleting supports.

1) Manual Add

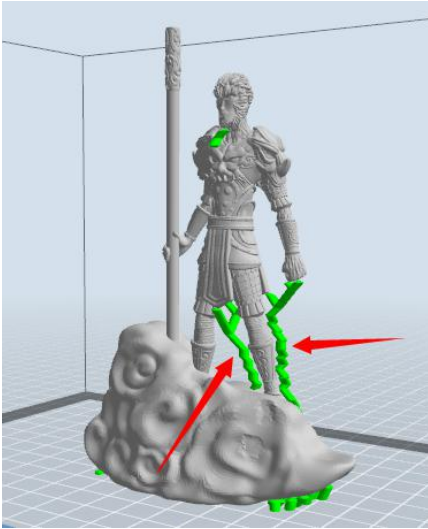

8-10

You can add the support structure manually to according to the actual shape of the model.

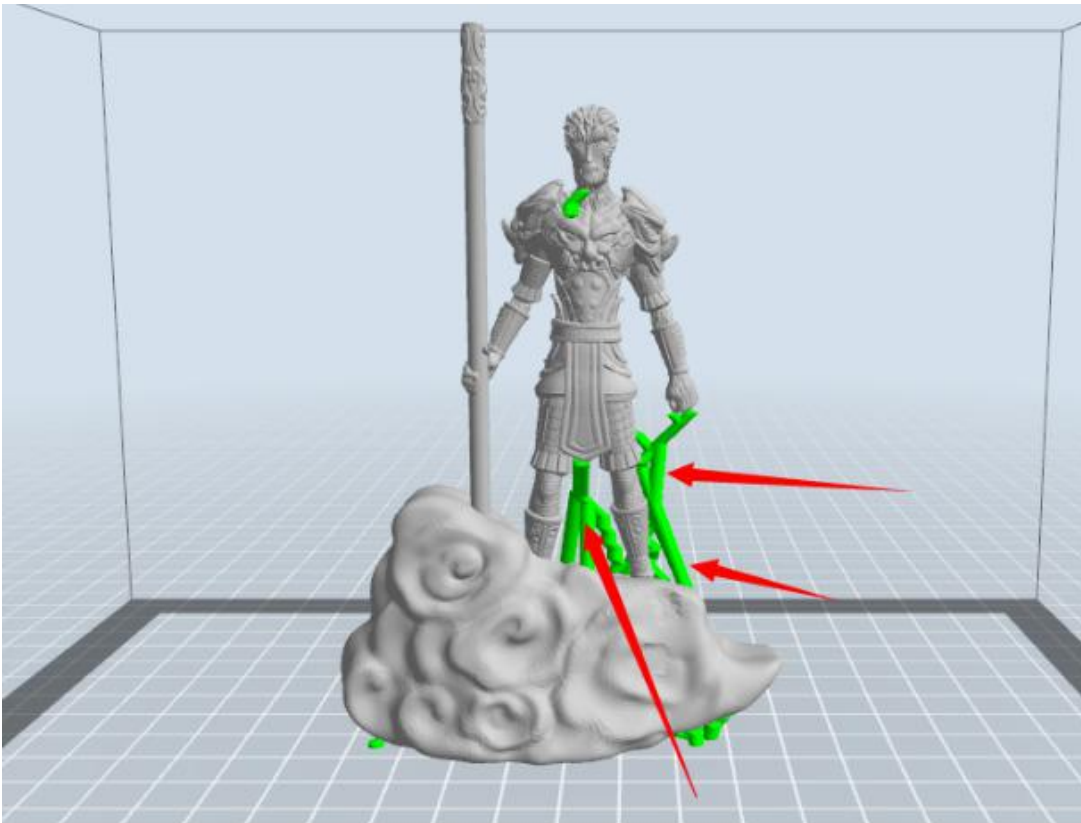

Left click [Add] on the left, and then click on the position when support structure is

needed. Press down the left mouse button and drag to generate the support.

2) Manual Delete

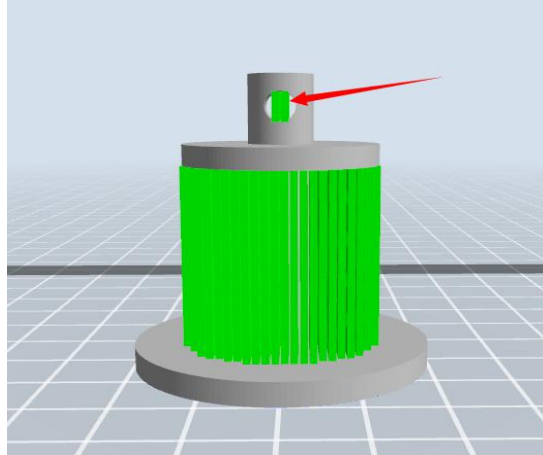

8-11

Like the picture above, a hole inside the model doesn't need any supports.

Left click the [Delete] button and then left click the supports needed deleting. And the support will be deleted.

8.2 Control over Printing Quality

① Enhance the build plate adhesiveness

- Leveling the build plate
- Keeping the build plate smooth and tidy
- Using the build tape or glue

② Adjusting the printing speed

- Low (Fast) (Print Speed 80mm/s Travel Speed 100mm/s)
- Standard (Print Speed 60mm/s Travel Speed 80mm/s)
- **High** (Slow) (Print Speed 50mm/s Travel Speed 70mm/s)
- **Hyper** (Print Speed 50mm/s Travel Speed 70mm/s)

8.3 Skills of Model Placement

Not all the models are in the right positions after being loaded. Therefore, you need to place it in an appropriate position for better print quality. Such as the models below, you need to put one of the surfaces onto the platform. (Please refer to 5.1.12-⑦ Surface to Platform)

①

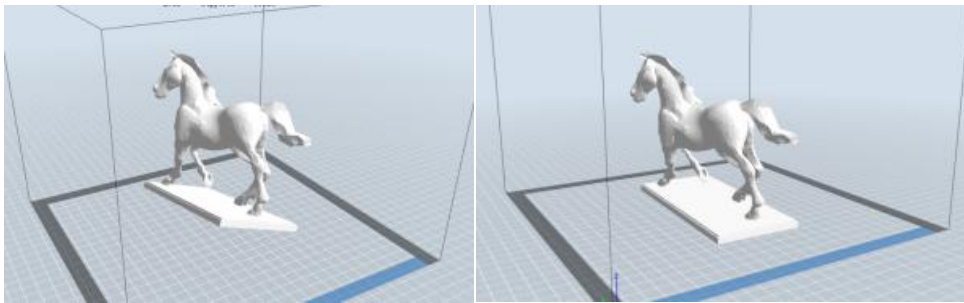

Improper

Proper

8-12

②

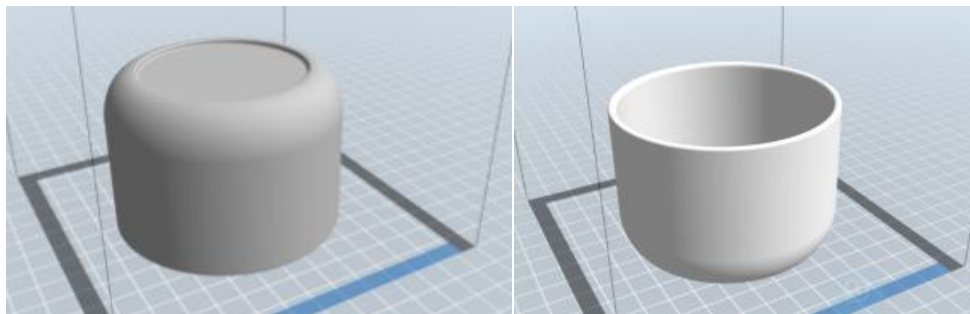

Improper

Proper

8-13

③

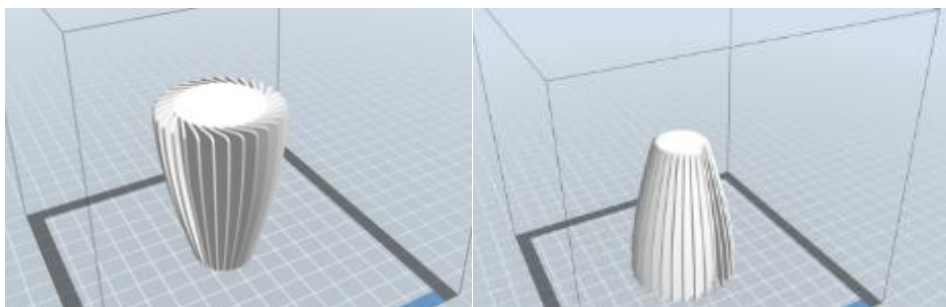

Improper

Proper

8-14

Further Reading: Cut Function

Left-click on the model to select it and double-click on the **Cut icon** to set the cut plane. The direction and position are available for setting.

E.g:

As for a big model or an irregular model, you need to cut it into several parts so as to reduce the printing limitation and to better the print quality. Look at the model below:

Picture 8-15 is the preview of the model's original placement and Picture 8-16 is the preview of the model with support structure.

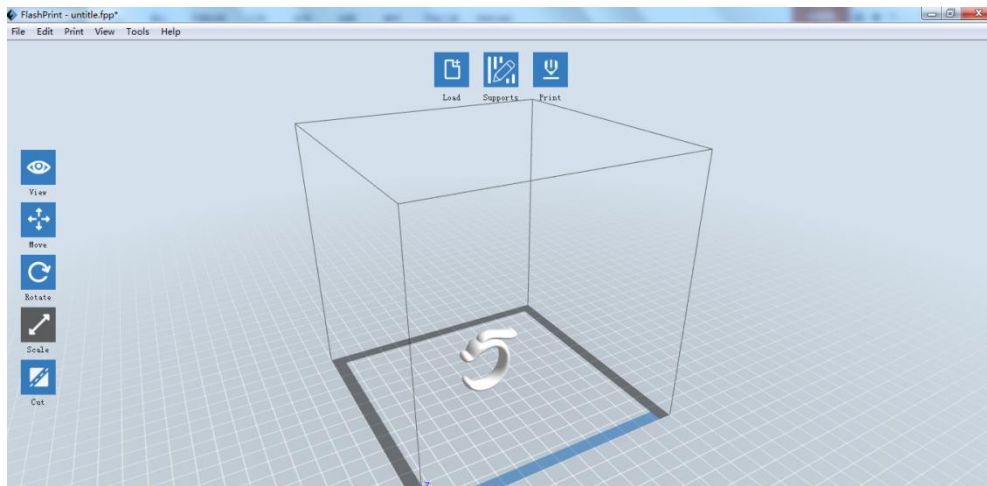

8-15

(8-16) Model with support structure

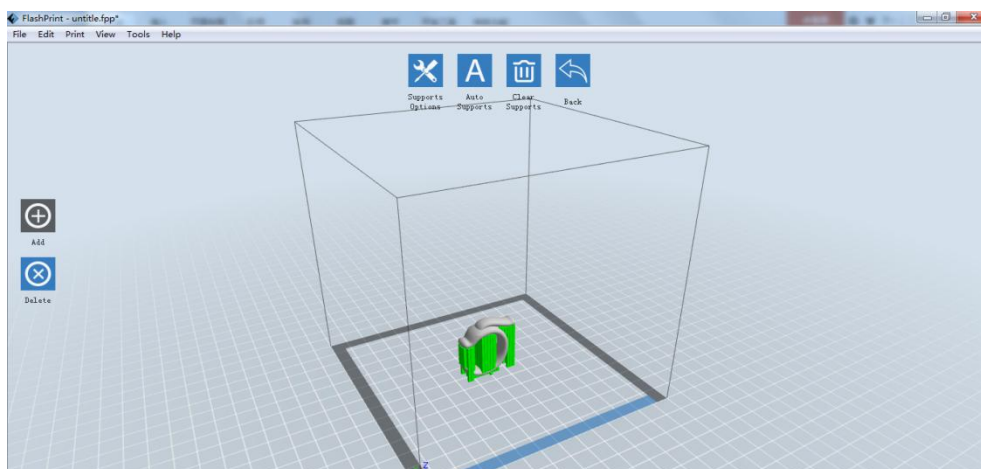

8-16

(8-17) Looking at the Picture 8-16, we will definitely find that the complex supports will influence the smoothness of the model. By analyzing the model's feature, cutting from the Y plane will be suitable.

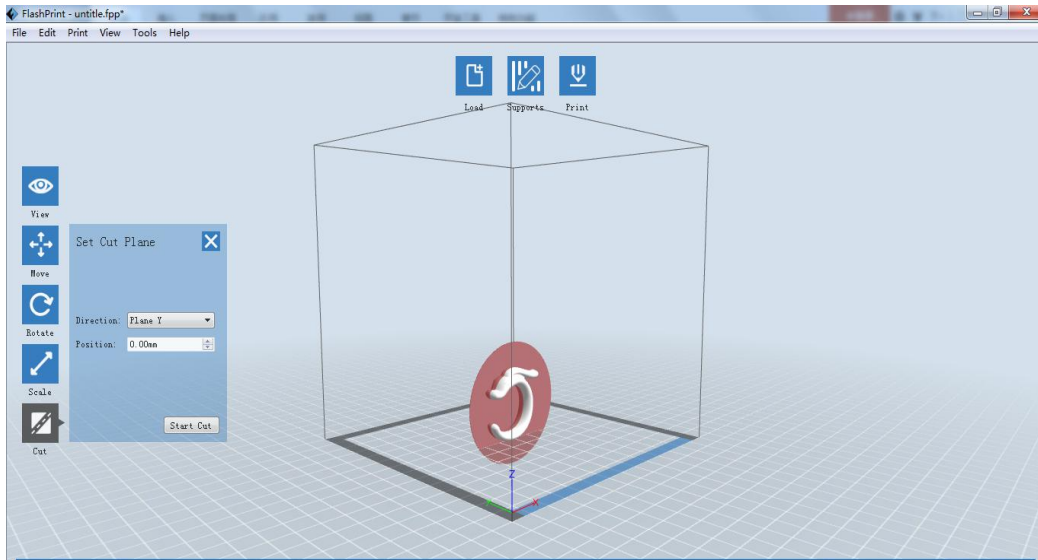

8-17

(8-18) The model preview after cutting.

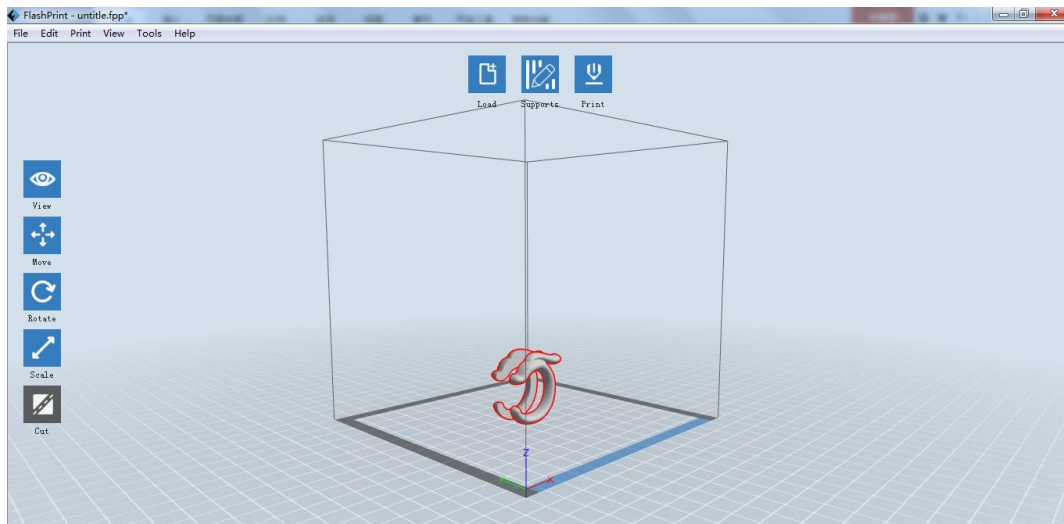

8-18

(8-19) Click **[Edit]**--**[Surface to Platform]** to put the flat surfaces onto the platform.

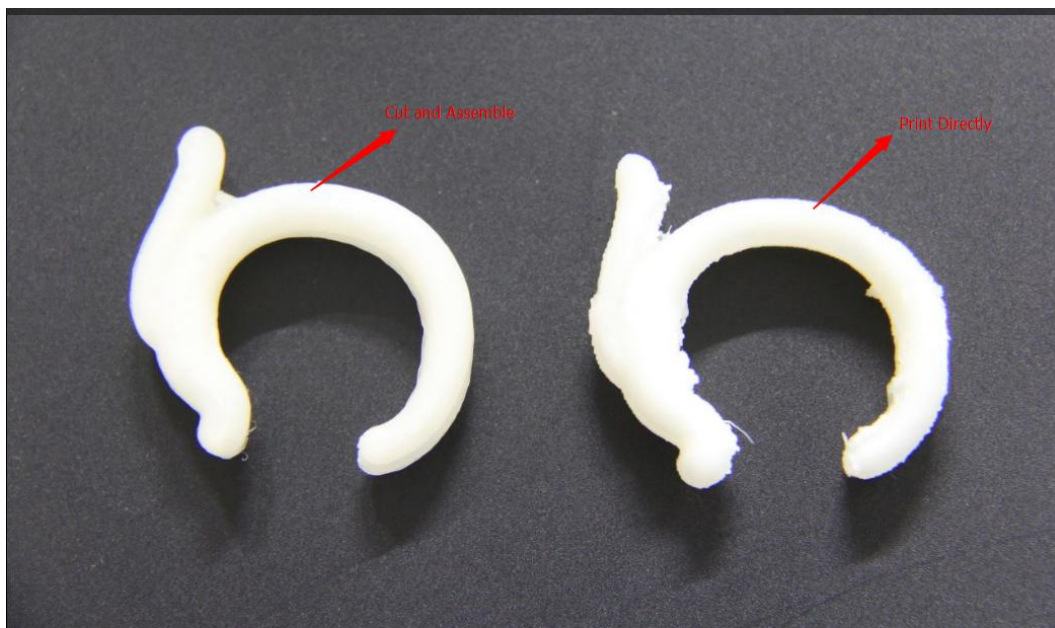
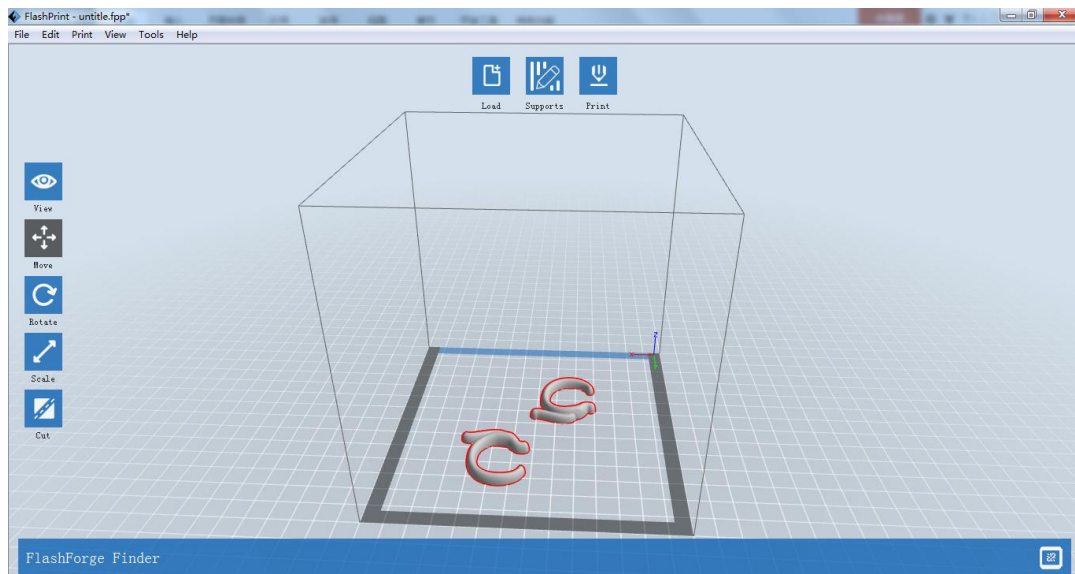

Chapter 9: Supports and Service

Flashforge team is on standby and ready to help you with any challenges you may have with your Guider II . If the issues or questions are not covered in this User Guide, you can seek for solutions on our official website or contact us via telephone.

There are solutions and instructions to common issues that can be found in our knowledge base. Have a look first as most basic questions are answered there.

<http://www.flashforge.com>

The Flashforge support team can be reached by e-mail or phone between the working hours of 8:00 a.m. to 5:00 p.m. PST Monday through Saturday. In case you contact us during after-hours, your inquiry will be answered the following business day.

Note: Because of changing different filament the extruder maybe blockaded. It's not owing to quality issue, and outside the scope of 400 hours life. If users encounter this problem, please contact our after-sale department and finish clean work according to their instruction.

Tel: [86-0579-89316036](tel:86-0579-89316036)

QQ: [2850862986](https://www.qq.com/number/2850862986) [2850863000](https://www.qq.com/number/2850863000) [2853382161](https://www.qq.com/number/2853382161)

ADD : No. 518, Xianyuan Road, Wucheng, Jinhua, Zhejiang

When contacting support, please have your serial number ready. The serial number is a bar code on the back of your Guider II.