

FlashForge Guider IIS 3D Printer User Guide



! NOTE Please read FlashForge Guide IIS 3D Printer User Guide carefully before use.
Please well keep this User Guide for future reference.

Content

Content.....	2
Preface.....	3
Introduction.....	4
Notice.....	5
Chapter 1: 3D Printing Technology.....	9
Chapter 2: About GuiderIIS.....	11
2.1 About Your GuiderIIS.....	11
Chapter 3: Unpacking.....	22
Chapter 4: Hardware Assembly.....	26
4.1 Filament Installation.....	26
4.2 Printer Start-up.....	27
4.3 Loading Filament.....	27
4.4 Unloading Filament.....	29
Chapter 5: Build Plate Leveling.....	31
Chapter 6: About Software.....	33
6.1 Software Installation.....	33
6.2 Exploring FlashPrint.....	34
Chapter 7: Basic Printing.....	57
7.1 Generate a Gcode.....	57
7.2 Print Methods.....	59
7.3 Camera.....	71
Chapter 8: Supports and Service.....	72
Chapter 9: Basic Questions and Answers.....	73

Preface

Note: Each device must be tested before leaving factory. If there are some residues in extruder or some tiny scratches on the build tape, it is normal and won't affect the printing quality.

On the completion of this User Guide, thanks all FlashForge engineers and the FlashForge 3D printer users for their unremitting efforts and sincere assistance.

The FlashForge GuiderIIS User Guide is designed for the GuiderIIS users to start their printing journey with FlashForge GuiderIIS. Even if you are familiar with earlier FlashForge machines or 3D printing technology, we still recommend that please read this guide, as there is lots of important information about the GuiderIIS for you to get a better 3D experience.

For a better and more successful printing experience, you can refer to the following materials:

(1) Quick Start Guide

Users will find the Quick Start Guide together with the printer accessories. The Quick Start Guide will help you start your print journey as soon as possible.

(2) Official FlashForge Website: <http://www.FlashForge.com>

The official FlashForge website contains the up-to-date information concerning FlashForge software, firmware, device maintenance and so on. Users are also able to get the contact information from there.

Introduction

Notes:

- Please read *FlashForge GuiderIIS 3D Printer User Guide* carefully before use.
- The User Guide is written based on Windows 7 OS.
- The version of the FlashPrint is latest.

The *FlashForge GuiderIIS 3D Printer User Guide* contains the information needed for you to set up and use this device.

This User Guide including the following parts: Preface, Introduction and After-sale service.

The Preface section includes resource acquisition channel, the overall framework of the manual, and the problems that should be paid attention to while printing.

The introduction section contains the overview of 3D printing technology, equipment introduction, unpacking and installation of equipment, software installation and use.

After-sale section contains the user how to get the support and help.

Notice

Safety Notice

! Notices: Read all the instructions in the manual and familiarize yourself with the FlashForge GuiderIIS User Guide before setting-up and using. Failure to comply with the warning and instructions may result in individual injury, fire, equipment damage or property damage.

PLEASE STRICTLY FOLLOW ALL THE SAFETY WARNINGS AND NOTICE BELOW ALL THE TIME.

· Work Environment Safety

- ① Keep your work place tidy.
- ② Do not operate GuiderIIS in the presence of flammable liquids, gases or dust.
- ③ Keep Guider II out of children and untrained people' reach.

· Electrical Safety

- ① Always use the Guider II with a properly grounded outlet. Do not refit Guider II plug.
- ② Do not use Guider II in damp or wet locations. Do not expose Guider II to burning sun.
- ③ In case of device damage, please use the power supply provided by FlashForge.
- ④ Avoid using the device during an thunderstorm.
- ⑤ In case of uncertain accident, please unplug the device if you do not use it for long.

·Personal Safety

- ① Do not touch the nozzle and build plate during printing.

- ② Do not touch the nozzle after finishing printing.
- ③ Dress properly. Do not wear loose clothing or jewelry. Keep your hair, clothing and gloves away from moving parts.
- ④ Do not operate the device while you are tired or under the influence of drugs, alcohol or medication.

· **Cautions**

- ① Do not leave the device unattended for long.
- ② Do not make any modifications to the device.
- ③ To lower the build plate before loading/unloading filament. (The distance between the nozzle and build plate should be kept for at least 50mm)
- ④ Operate the device in a well-ventilated environment.
- ⑤ Never use the device for illegal activities.
- ⑥ Never use the device to make any food storage vessels.
- ⑦ Never use the device to make any electrical appliance.
- ⑧ Never put the model into your mouth.
- ⑨ Do not remove the models with force.
- ⑩ Never connect the device with network cable longer than 3m.

· **Environment Requirements**

Temperature: RT 15-30°C

Moisture: 20%-70%

· **Place Requirements**

The device must be placed in a dry and ventilated environment. The distances of the left, right and back side space should be at least 20cm, and the distance of the front side space should be at least 35cm.

· **Filament Requirements**

Do not abuse the filament. Please make sure you use the FlashForge filament or the filament from the brands accepted by FlashForge.

· **Filament Storage**

All polymers degrade with time. Do not unpack until filament is needed. Filament should be stored at clean and dry conditions.

Legal Notice

All the information in this document is subject to any amendment or change without the official authorization from FlashForge.

FLASHFORGE CORPORATION MAKES NO WARRANTY OF ANY KIND WITH REGARD TO THIS DOCUMENT, INCLUDING, BUT NOT LIMITED TO, THE IMPLIED WARRANTIES OF MERCHANTABILITY AND FITNESS FOR A PARTICULAR PURPOSE.

FlashForge shall not be liable for errors contained herein for incidental consequential damages in connection with furnishing, performance or use of this material

FCC STATEMENT:

This device complies with Part 15 of the FCC Rules. Operation is subject to the following two conditions:

- (1) This device may not cause harmful interference,
- (2) This device must accept any interference received, including interference that may cause undesired operation.

Warning: Changes or modifications not expressly approved by the party responsible

for compliance could void the user's authority to operate the equipment.

This equipment has been tested and found to comply with the limits for a Class B digital device, pursuant to Part 15 of the FCC Rules. These limits are designed to provide reasonable protection against harmful interference in a residential installation. This equipment generates uses and can radiate radio frequency energy and, if not installed and used in accordance with the instructions, may cause harmful interference to radio communications. However, there is no guarantee that interference will not occur in a particular installation. If this equipment does cause harmful interference to radio or television reception, which can be determined by turning the equipment off and on, the user is encouraged to try to correct the interference by one or more of the following measures:

- Reorient or relocate the receiving antenna.

- Increase the separation between the equipment and receiver.

- Connect the equipment into an outlet on a circuit different from that to which the receiver is connected.

- Consult the dealer or an experienced radio/TV technician for help.

This document contains proprietary information protected by copyright.

Copyright © 2018 FlashForge Corp. All Rights Reserved

Chapter 1: 3D Printing Technology

3D printing refers to transforming three-dimensional models into physical objects that you can hold and touch. It is also called additive manufacturing because the 3D model is created by “adding” layers upon layers of material until the object is fully formed.

Fused Filament Fabrication (FFF) is the most common method of 3D printing. It is also the method that the GuiderIIS uses. It works by melting plastic material called filament onto a print surface in high temperature. The filament solidifies after it cools down, which happens instantaneously after it is extruded from the nozzle. 3D objects are formed with the filament laying down multiple layers.

1.1 Process

3D printing involves three steps:

- 1.) Make or download a 3D model
- 2.) Slice and export the 3D model
- 3.) Build the 3D model

1.1.1 Make a 3D Model:

Currently, there are three ways to creating a 3D model.

·**Designing From Scratch** You can use free CAD (computer-aided design) software such as 3DTADA, AutoCAD, SolidWorks, Pro-E, and our own software Happy 3D to design your own 3D model.

·**3D Scanners** An alternative method to creating a 3D model is to scan an object. 3D scanners work by digitizing a physical object, collecting its geometric data, and saving it to a file on your PC. There are also apps that can turn a mobile device into a 3D scanner.

·**From the Cloud** The most popular way of obtaining a 3D model is to download it from websites that allow users to upload 3D models that they designed.

E.g. : www.thingiverse.com

1.1.2 Slice and Export the 3D Model:

Slice software is the software that prepares 3D models for printing and turns them into instructions for the 3D printers. FlashPrint is the slicing software used for the FlashForge GuiderIIS.

Using FlashPrint, you can turn .stl files into .g or .gx files for printing. Then the files can be transferred to your GuiderIIS via USB cable, USB stick ,Wi-Fi or Ethernet cable.

GuiderIIS support Simplify3D software, software not developed by FlashForge may need register or charge extra fee, please choose to use(or not) according to your needs.

1.1.3 Build the 3D Model:

Once the output file has been transferred to your GuiderIIS, it will start to turn the 3D model into a physical object by laying down layers of filament.

1.1.4 Basic 3D Printing Process:

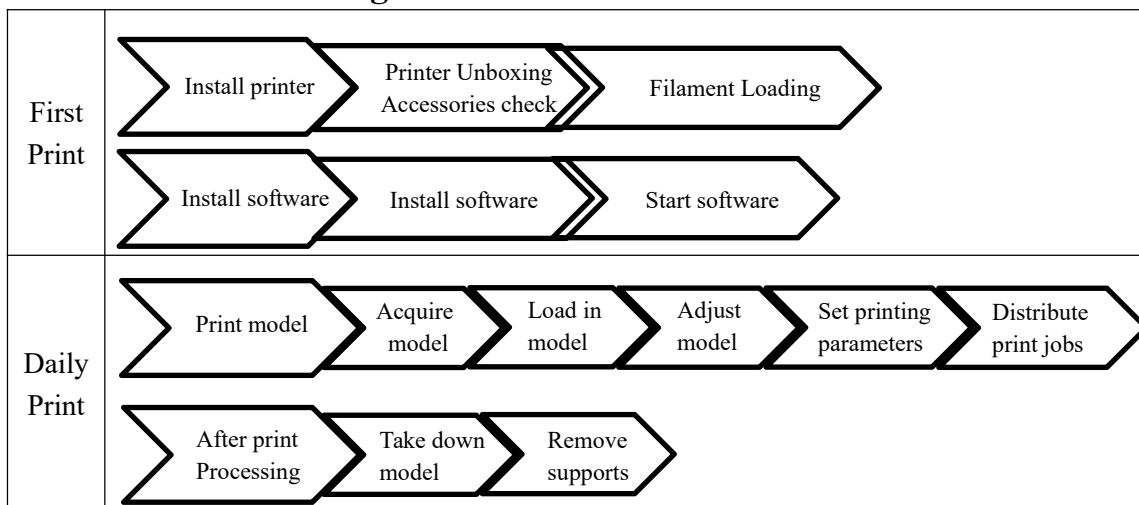

Chapter 2: About GuiderIIS

2.1 About Your GuiderIIS

2.1.1 Views

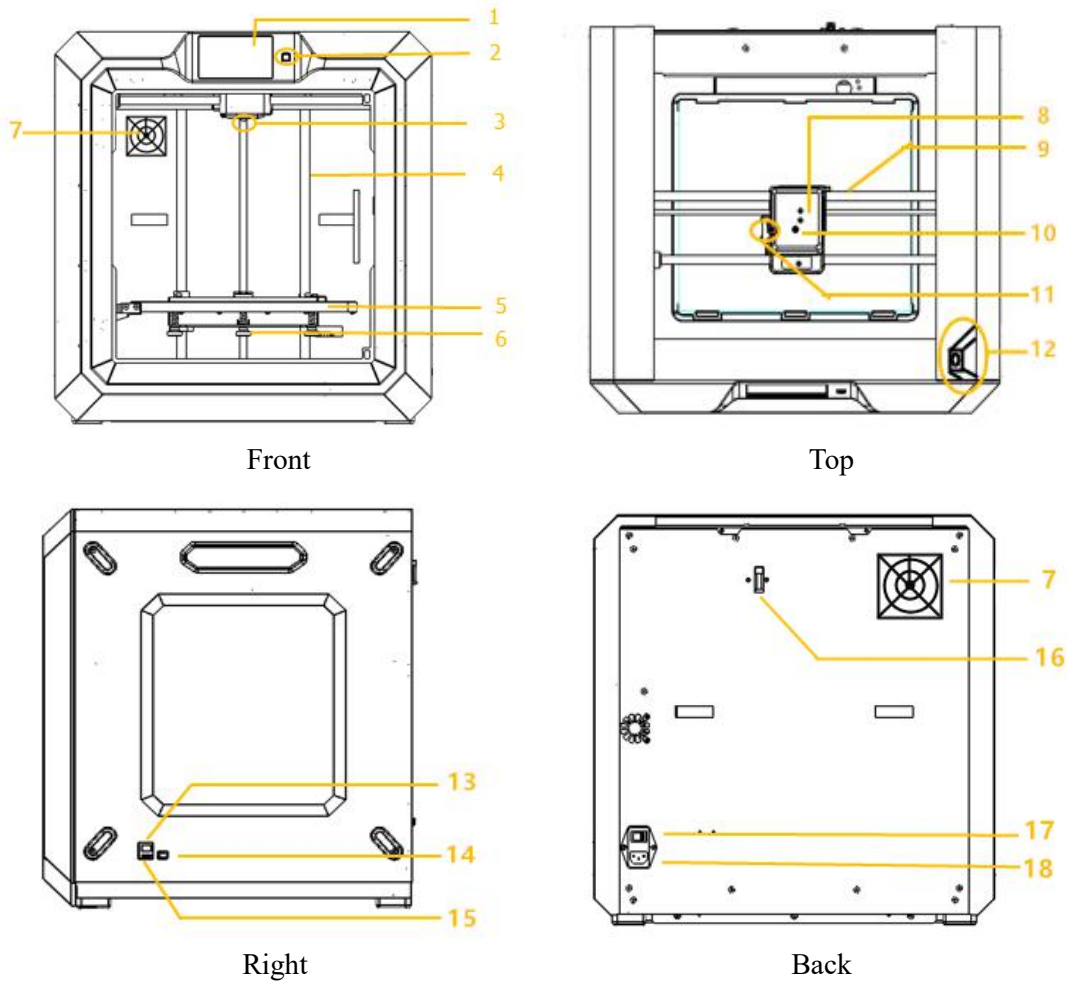

- | | | |
|------------------------|---------------------|-----------------------|
| 1. Touch screen | 7. Filter fan | 13. Ethernet input |
| 2. Touch screen button | 8. Extruder | 14. USB cable input |
| 3. Nozzle | 9. X-axis guide rod | 15. USB stick input |
| 4. Z-axis guide rod | 10. Filament intake | 16. Filament detector |
| 5. Build plate | 11. Spring presser | 17. Power switch |
| 6. Leveling knob | 12. Camera | 18. Power input |

2.1.2 Terms

Build Plate	The surface on which the Guider II builds an object.
Build Tape	The blue tape that covers Guider II's build plate so that the object can stick to the build plate well.
Build Volume	The three dimensional amount of space that an object will use once it is completed. The largest build volume of GuiderIIS is 280*250*300 mm.
Leveling Knobs	Knobs under the build platform that are used for adjusting the distance between the nozzle and build plate.
Extruder	The device that draws the filament from the spool, melts it and pushes it through a nozzle into the build plate.
Nozzle	Also called "print head", which located at the bottom of the extruder where heated filament is squeezed out.
Cooling Fan	To cool the outer assembly of the extruder and gear motor.
Filament Intake	An opening located at the top of the extruder.
Filament Guide Tube	A black plastic piece that guides the filament from the filament box to the filament intake.
Filament Cartridge	A specific box for placing FlashForge filament.
Solid Glue Stick	A solid adhesive used for making the model stick to the build plate firmly.
Unclogging Pin Tool	A tool that used for cleaning and unclogging the extruder.
Stamping Wrench	A tool that used for seizing the nozzle's metal cube.

2.1.3 Reference

Name	Guider II
Number of Extruder	1
Print Technology	Fused Filament Fabrication(FFF)
Screen Size	5.0" color IPS Touch Screen
Build Volume	280*250*300mm
Layer Resolution	0.05 - 0.4mm
Build Accuracy	±0.2mm
Positioning Accuracy	Z axis 0.0025mm; XY axis 0.011mm
Filament Diameter	1.75mm (±0.07)
Nozzle Diameter	0.4mm
Print Speed	10~200 mm/s
Software	FlashPrint、 Support Simplify3D
Support Formats	Input:3MF/ STL/OBJ/FPP/BMP/PNG/JPG/JPEG Output:GX/G
OS	Win xp/Vista/7/8/10、 Mac OS、 Linux
Device Size	490*550*560mm
Net Weight	30Kg
AC Input	Input: 100V-240VAC, 47-63Hz Power: 500W
Connectivity	USB cable, USB stick, WiFi, Ethernet, Polar Cloud
Camera	1, Inside the corner between front and right board
Filter Fan	1, On the backboard

2.1.4 Interface Menus

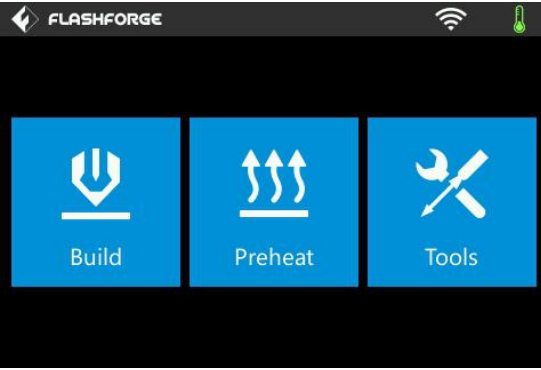
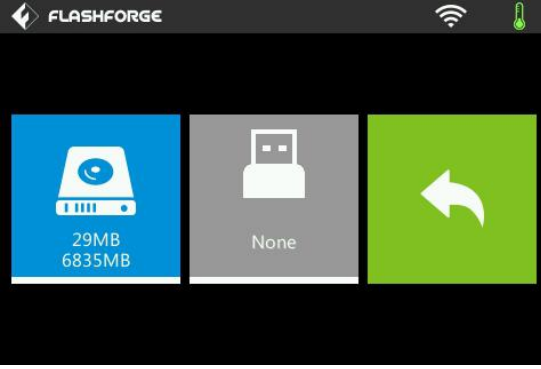
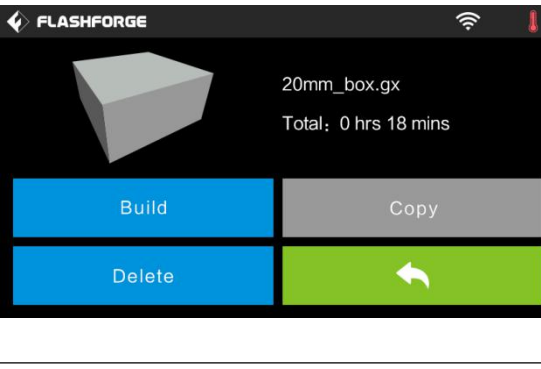
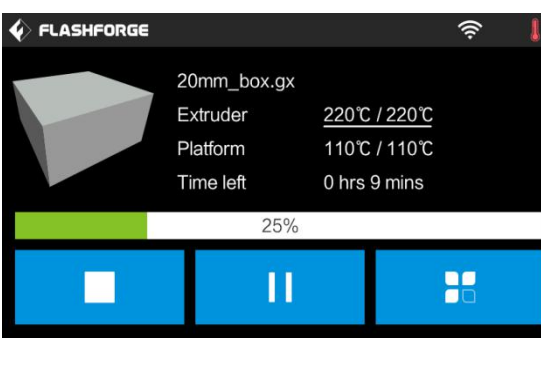
	<p>Build</p>
	<p>Read the print file from</p> <ul style="list-style-type: none"> ✘ The local memory card ✘ The USB stick ✘ Back
	<p>Select the target print file among the list</p> <ul style="list-style-type: none"> ✘ Build: To begin printing. ✘ Copy: To copy the files to the local memory card from the USB stick.(The button is not available while printing from local memory card) ✘ Delete: To delete the print file. ✘ Back
	<p>Print interface</p> <ul style="list-style-type: none"> ✘ Abort: To abort the print job. ✘ Pause/Resume: To suspend or resume the print job. ✘ Tools: To check status or modify settings during printing: build time, Z axis, filament used, printing speed, light status, change filament. ✘ Extruder temperature: Can be changed during printing.

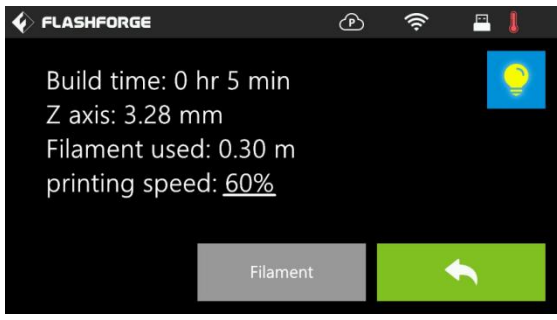
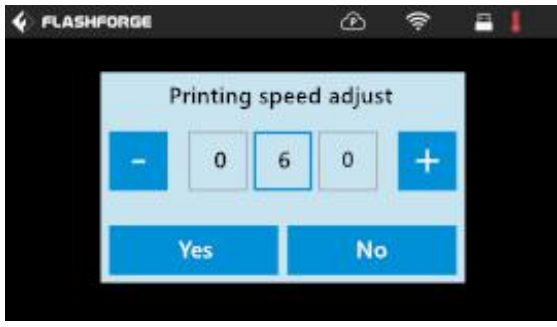
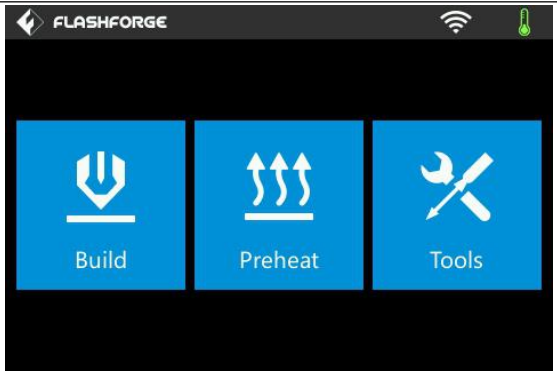
	<p>To set extruder temperature during printing: After extruder temperature has reached target temperature, temperature figure will be underlined in print interface, Tap [Yes] to save the setting while tap [No] to cancel the setting.</p>
	<p>Tools in print interface</p> <ul style="list-style-type: none"> ✎ Printing speed: To change printing speed during printing by tapping the underlined speed figure. ✎ Light bulb: To turn on/off the light. ✎ Filament: To change filament during printing. (Note: You need to suspend the printing operation first) ✎ Cancel: To end the tool orders and return to the print interface.
	<p>To set the printing speed during printing Tap [Yes] to save the setting while tap [No] to cancel the setting.</p>
	<p>Preheat</p>

	<p>Tap the [Preheat] button to enter the preheat interface. Tap the [Start] button to heat up to the setting temperature. The default temperature is 220°C. Tap the temperature display bar to set the temperature.</p>
	<p>To set the preheat temperature. Tap [Yes] to save the setting while tap [No] to cancel the setting.</p>
	<p>The picture displays the preheat interface. It shows the actual temperature and the target temperature. Tap the [Abort] button to abort the preheat job.</p>
	<p>Tools</p> <p>Tap [Tools] to enter tool options.</p> <ul style="list-style-type: none"> ✎ Filament: To load/unload the filament. ✎ Level: To adjust the build plate. ✎ Home: To make the X, Y and Z axes back to the zero point.
	<ul style="list-style-type: none"> ✎ Manual: To manually adjust the positions of X, Y and Z axes. ✎ Setting: To implement relevant function setups. ✎ Status: The check the real-time status of the printer. ✎ About: Information about the printer. ✎ Back

	<p>Manual adjustment</p> <ul style="list-style-type: none"> ✎ Y+: The extruder moves to the zero point, that is, the back of the machine ✎ Y-: The extruder moves to the direction opposite to the Y+. ✎ X+: The extruder moves to the zero points, that is, to the right direction ✎ X-: The extruder moves to the direction opposite to the X+. ✎ Z+: The build plate elevates. ✎ Z-: The build plate descends. ✎ Back
	<p>Tap [Setting] to enter the setting interface</p> <ul style="list-style-type: none"> ✎ Language: To set the display language ✎ Resume Print: Resume print after restarting Guider IIS ✎ WiFi: To turn on/off the WiFi ✎ Wlan hotspot: To turn on/off the Wlan hotspot. ✎ Polar Cloud Connection: To turn on/off the Polar Cloud Connection. ✎ Extruder Calibration: To adjust the initial distance between the extruder and the build plate. ✎ Startup Sound: To turn on/off the Startup Sound. ✎ Filament Check: To turn on/off the filament check ✎ Light Bar Control: To turn on/off the light bar control. ✎ Light Bar Brightness: To adjust the light bar brightness. ✎ Factory Reset: Return to factory setting ✎ Update: To update the firmware version. ✎ Back

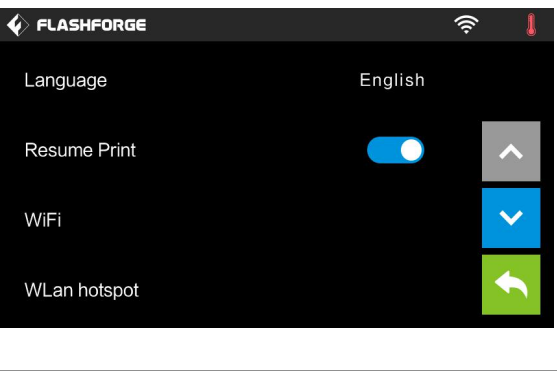
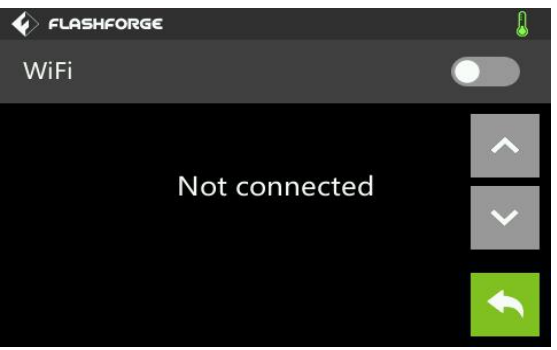
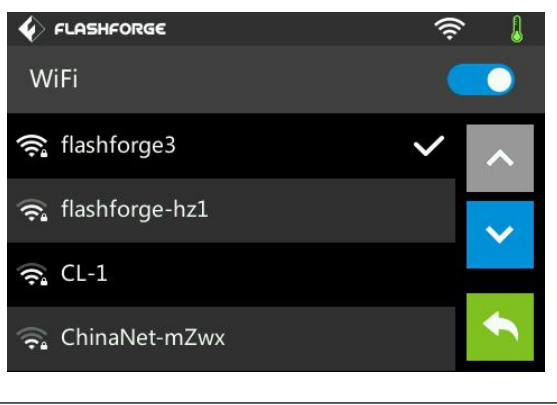
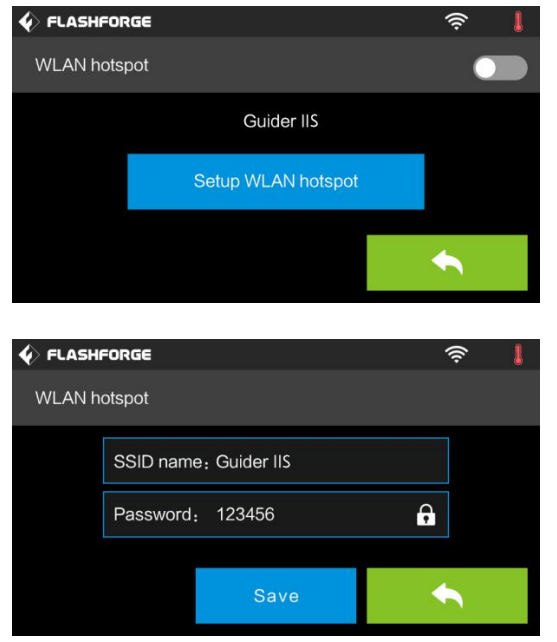
	<p>Turn on [Resume Print]</p> <p>Left picture showed is the [Resume Print] turned on status. If the printer is turned off when current print job has not finished yet, printer will continue and resume previous printing job after restarted.</p> <p>(Note: If [Resume Print] is turned off, this function will not apply.)</p>
	<p>WiFi:</p> <ul style="list-style-type: none"> ✎ Turn on WiFi: Turn on the WiFi, release the WiFi hotspot and set the WiFi on computer ✎ Back
	<p>WiFi:</p> <ul style="list-style-type: none"> ✎ Turn on WiFi: Turn on the WiFi, release the WiFi hotspot and set the WiFi on computer ✎ Back
	<p>Wlan hotspot</p> <ul style="list-style-type: none"> ✎ OFF/On: To turn on/off the Wlan hotspot. ✎ Setup Wlan hotspot: To set the SSID and password. ✎ SSID: The name of hotspot. ✎ Password: The password of hotspot. ✎ Save: To save the setting. ✎ Back

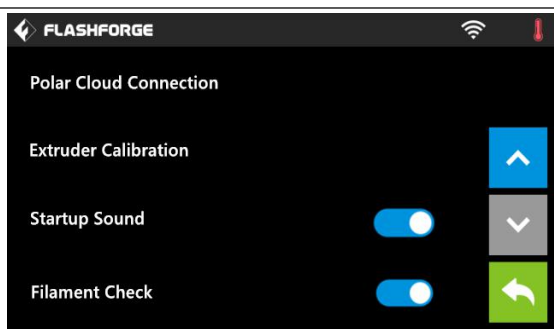
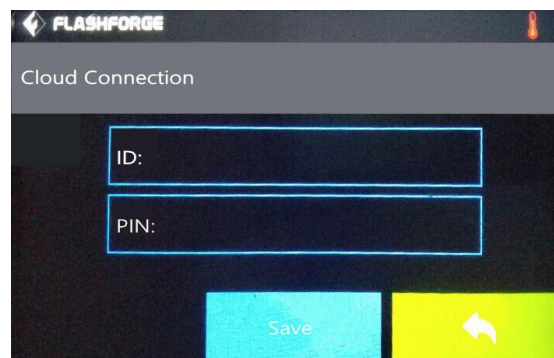
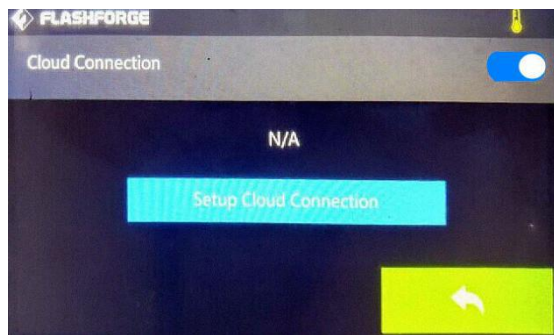
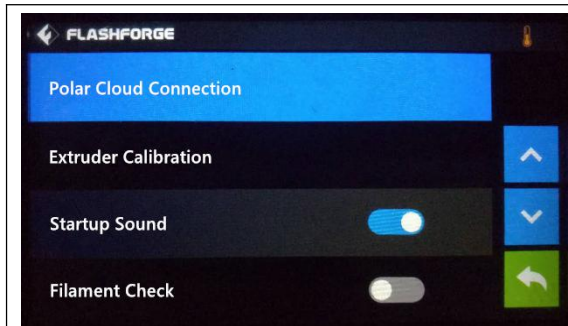

Polar Cloud Connection:

☞ Cloud Connection: To turn on/off the polar cloud connection.

☞ Setup Cloud Connection: To set cloud connection ID and PIN which have already been registered on: <https://polar3d.com>

☞ ID: The email address of your Cloud account.

☞ PIN: The PIN code of your Cloud account.

☞ Save: To save the setting.

☞ Back

(Note: To use polar cloud printing function, you need to connect the printer to internet with WiFi or Ethernet Cable first)

Extruder Calibration:

(not recommended for customers to operate)
To adjust the initial distance between the extruder and the build plate by tapping [-]and[+]. The proper distance may be one ordinary paper's thickness.

Turn on [Filament Check]:

Left picture showed is the **[Filament Check]** turned on status.

Filament abnormal status will be detected when filament is used up or suspended. **[Filament Check]** function should be used with filament in the filament cartridge. This function is invalid if using filament out of the cartridge.

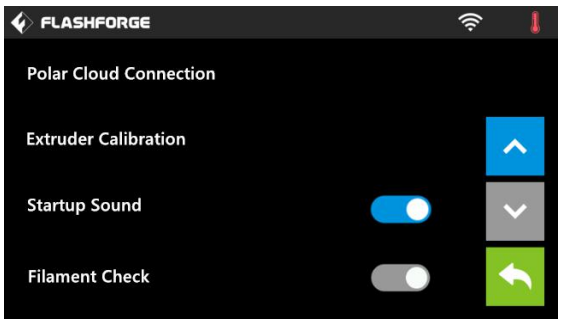
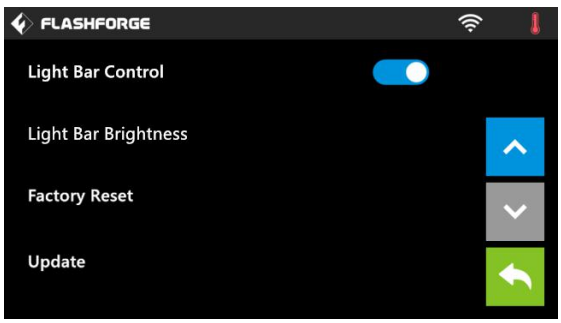
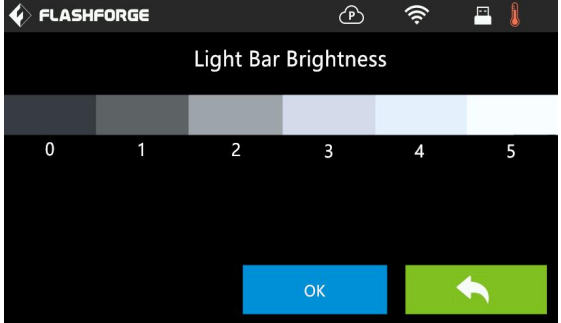
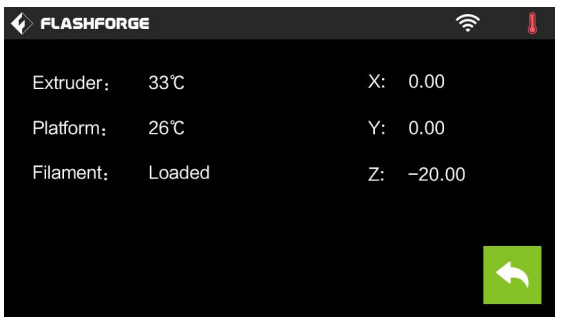
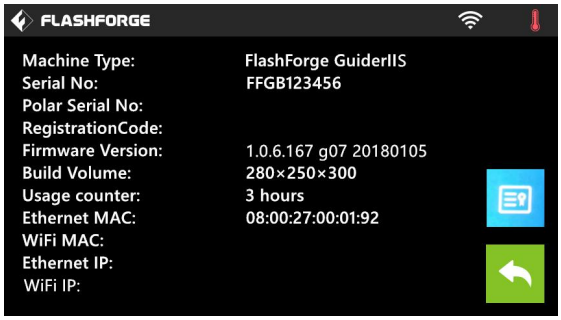
	<p>Turn off [Filament Check]: Left picture showed is the [Filament Check] turned off status. Filament abnormal status won't be detected when filament is used up or suspended.</p> <p>Turn on/off [Startup Sound]: ☞ Tap to turn on/off the sound when restart the printer.</p>
	<p>☞ Light Bar Control: To turn on/off the light bar control.</p> <p>☞ Light Bar Brightness: To click and select different light bar brightness.</p> <p>☞ Factory Reset: Return to factory setting</p> <p>☞ Update: To update the firmware version.</p> <p>☞ Back</p>
	<p>☞ Light Bar Brightness: To click and select different light bar brightness.</p>
	<p>Status: It displays the real-time status of the extruder temperature and other details.</p>
	<p>About: It displays the basic information about the device.</p>

2.2 Accessories



Filament*1

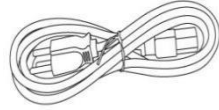

Power Cable



USB Cable



Filament Guide Tube



Quick Start Guide

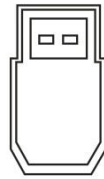

USB stick



Screwdriver



Allen Wrench (M2.0/2.5)



Solid Glue



Stamping Wrench



Unclogging Pin Tool



After-sales service card

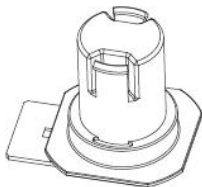

Spool holder

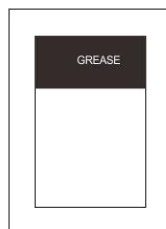

Grease

Chapter 3: Unpacking

(reference video: [Unpacking](#))

This chapter will present you the whole unpacking procedure of GuiderIIS 3D printer. **(Note: Make sure you read the whole unpacking guide)**



3-1

(3-1) Place the packaging box on a clean work surface.



3-2

(3-2) Open the box, take out the two foams and then lift your Guider IIS out of the box.



3-3

(3-3) Your Guider IIS is wrapped by packaging materials, remove these materials step by step.



3-4

(3-4) In the bottom of the carton , you can see a spool of filament, a spool holder, a Power Cable, a USB Cable, one Filament Guide Tube, a glue stick and a tool bag(USB stick*1, Allen wrenches*2, stamping wrench*1, unclogging pin tool*1, grease*1 and screwdriver*1).



Remove the side protective foam sheets.

(3-5) Remove the bag to unveil the Guider IIS

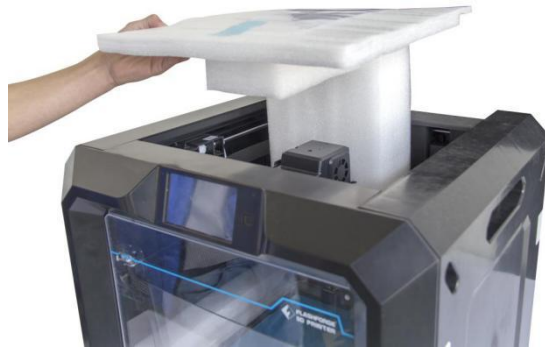

3-6

(3-6) Take out the top foam from the printer, on the top foam sheet, you can see one Quick Start Guide and a After-sales service card.



3-7

(3-7) Cut off four ribbons that used for fixing the guide rod. Then slide the extruder to make sure the extruder is in good condition.



(

3-8



3-9

Congratulations! You have unpacked your Guided IIS. Next, let's move on to hardware assembly of Guided IIS.

Chapter 4: Hardware Assembly

Your GuiderIIS has been installed before leaving factory, you can start up the GuiderIIS for printing after mounting the filament spool and completing leveling.

4.1 Filament Installation

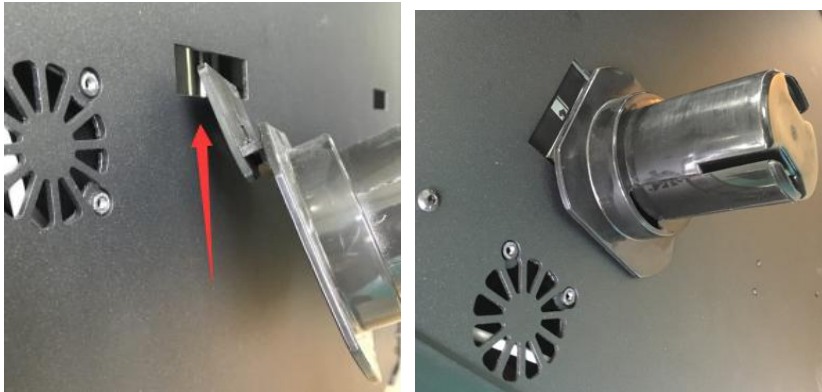

4-1

(4-1) The filament cartridge is at the rear of GuiderIIS. Lift the cartridge out of the Guider IIS.



Filament Detecting
Equipment in the black.

4-2

(4-2) Take out the filament and thread it through the filament detecting equipment.

(Note: The filament should feeds from the bottom of the spool towards the top)

4.2 Printer Start-up

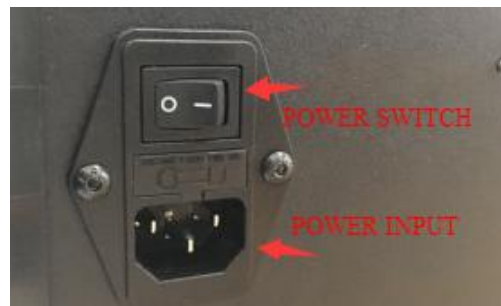

4-3

(4-3) Insert the power supply into the power input on the back of the GuiderIIS and plug the power cord into an electrical outlet.

4.3 Loading Filament

For stable filament loading and proper device protection, you need to install the filament guide tube properly.

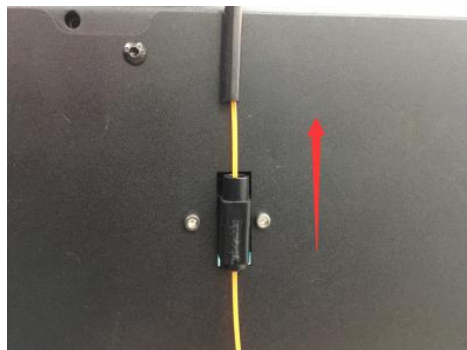

4-4

(4-4) Take out the filament guide tube, thread the filament from Filament Detecting Equipment



4-5

(4-5) Insert the filament from the filament guide tube into the filament intake.

Next, we will load the FlashForge filament. **(Note: Please lower the build plate to increase the distance between the nozzle and build plate to 50mm at least for avoiding nozzle jam.)**

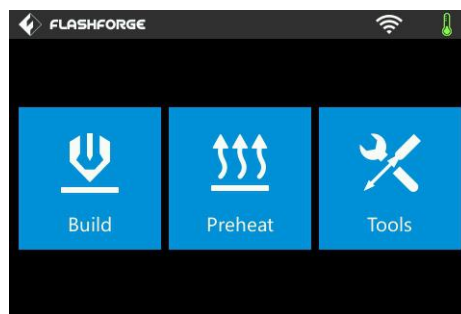

4-7

(4-7) Tap [Tool].

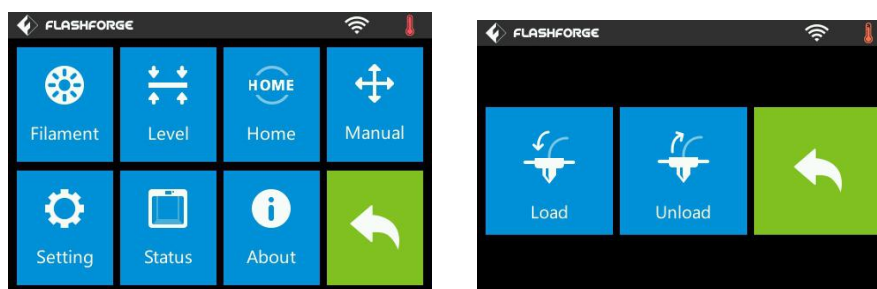

4-8

(4-8) Tap **[Filament]**--**[Load]**

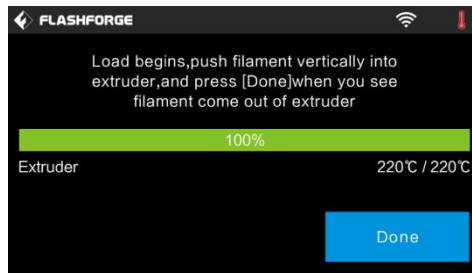

4-9

(4-9) After the extruder's temperature reaches 220°C, the printer will sound a beep to prompt you to load the filament into the extruder.



4-10

(4-10) Insert the filament into the extruder at an upright angle. Then the filament will be drawn through the extruder. Do not tap **[Cancel]** until the filament load the extruder steadily.

4.4 Unloading Filament



4-11

(4-11) Tap [Tool]-[Unload] and the extruder starts heating up.

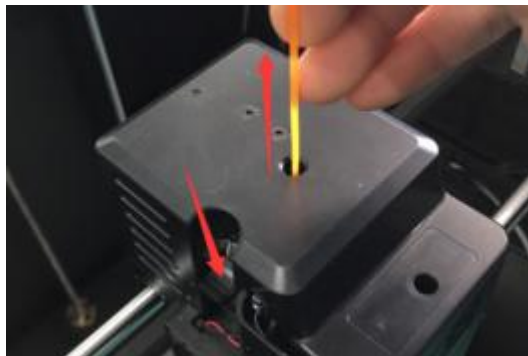
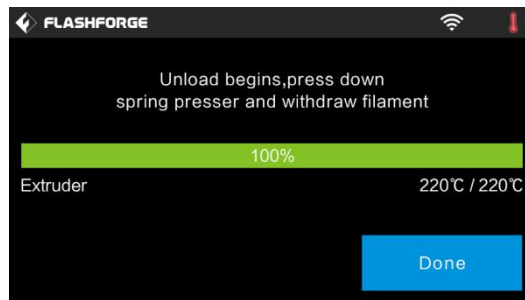

4-12

(4-12) After the extruder reaches 220°C, the printer will sound a beep to prompt you to unload the filament from the extruder. Press the spring presser, press down the filament for about three seconds and gently pull the filament out.

Note: Do not pull out the filament with force as it will damage the gears. If the melted filament has cooled down in the extruder, please repeat the steps above.

Chapter 5: Build Plate Leveling

GuiderIIS creatively adopts three-point intelligent leveling system, which will give clear and comprehensive feedback to users. There are three spring-loaded knobs under the build platform. The distance between the plate and nozzle increases while tightening the knobs. On the contrary, the distance reduces.

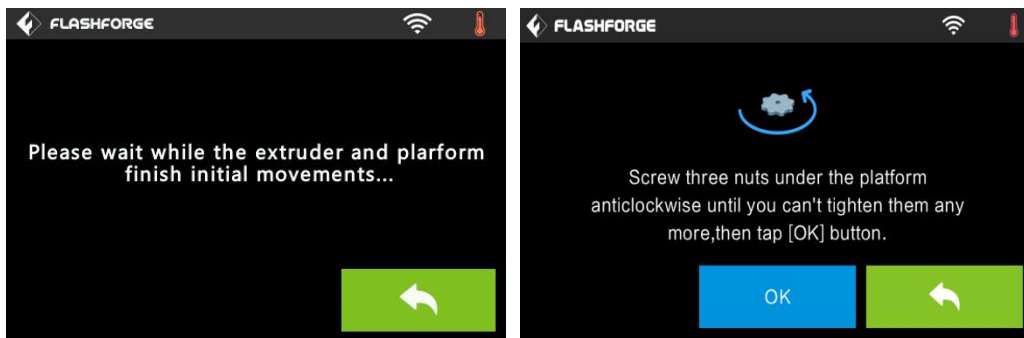

5-1

(5-1) Tap **[Tools]** - **[Level]** on your GuiderIIS touch screen. Please wait while the extruder and platform finish initial movements. After that, operate according to the guide on the touch screen.



5-2

(5-2) After tapping **[Yes]**, the extruder starts to move towards the first point and the plate moves up and down to verify the distance between nozzle and plate.

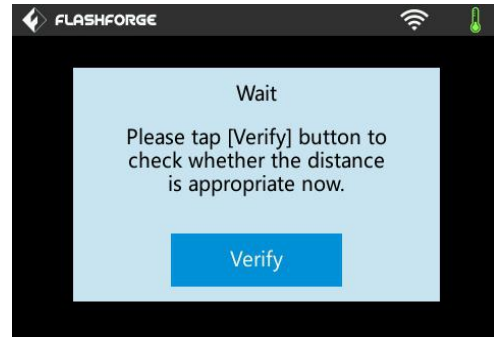
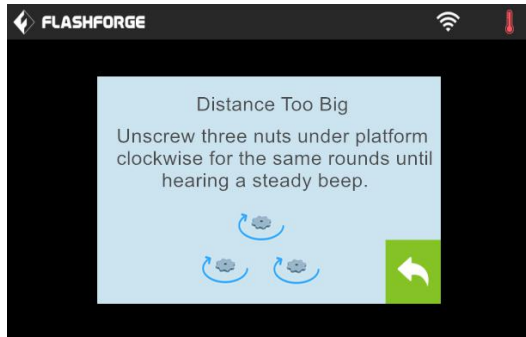

platform clockwise for the same rounds until hearing a steady beep and the **[Verify]** button appears.

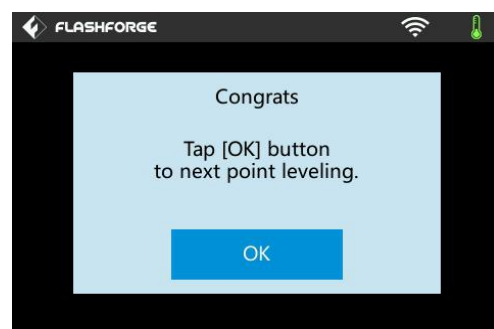
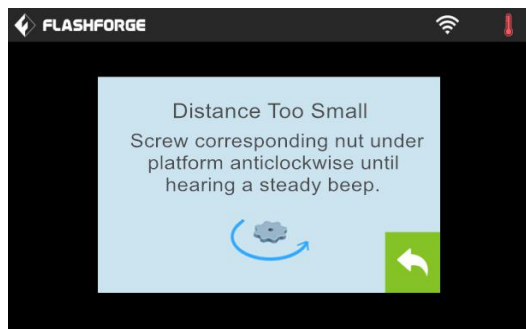

5-4

(5-4) If the distance is appropriate, tap **[OK]** to second point leveling. If still not, please follow the prompts to adjust the first point screw again till you see **[OK]** button.

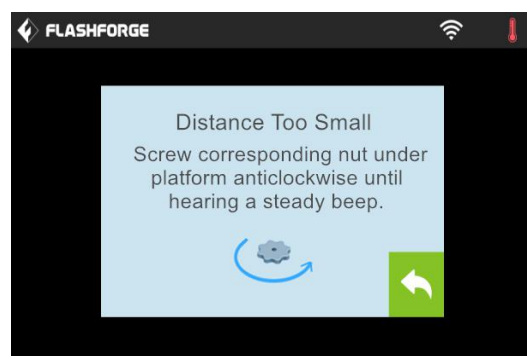
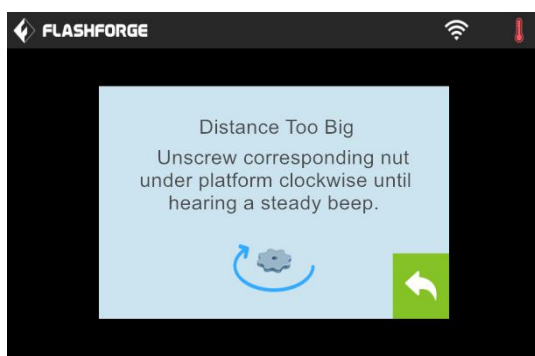

5-5

(5-5) Repeat steps according to the prompts on the touch screen to complete second and third points leveling and then finally Tap **[Finish]** to exit.

Leveling operating has completed !



Chapter 6: About Software

This chapter talks about the basic function of FlashPrint. For more information about advanced function, you can browse our website www.FlashForge.com.

6.1 Software Installation

6.1.1 Software Acquisition

Method 1: To get the installation package from the USB stick in the toolkit.

 FlashPrint_3.7.1_win64	2016/1/8 8:48	Windows Install...	41,637 KB
 FlashPrint_3.7.1_win32	2016/1/8 8:48	Windows Install...	37,995 KB
 FlashPrint_3.7.1_mac	2016/1/8 8:47	压缩(zip)文件...	16,599 KB

Method 2: Open the link below to download the installation package:

<http://www.FlashForge.com>

Steps:

Support---Downloads---FlashPrint---Choose the software version---Download

6.1.2 Software Installation and Start-up

1. Decompress the zipped file or start the installation program, and then install the software according to the direction.
2. Start the software with the start menu shortcut or by clicking the software icon.(See 6-1)



6-1

6.2 Exploring FlashPrint

6.2.1 Machine Type Selection

! After starting FlashPrint, you need to select the target machine type first.

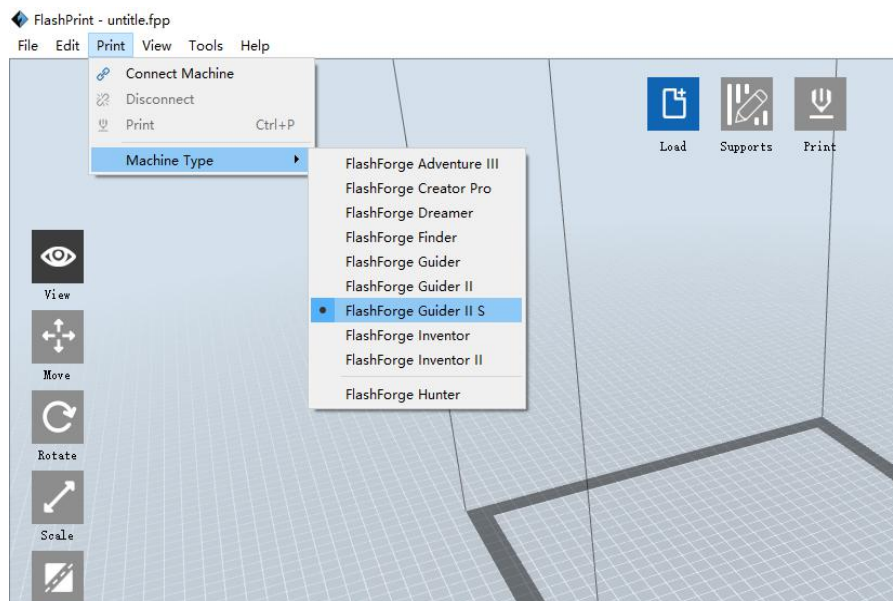

When you start FlashPrint, a dialog box will pop up. Just select FlashForge Guider IIS in the machine type list and click **[OK]**. You can also change the machine type via clicking **[Print]**--**[Machine type]**. See graphic 6-2:

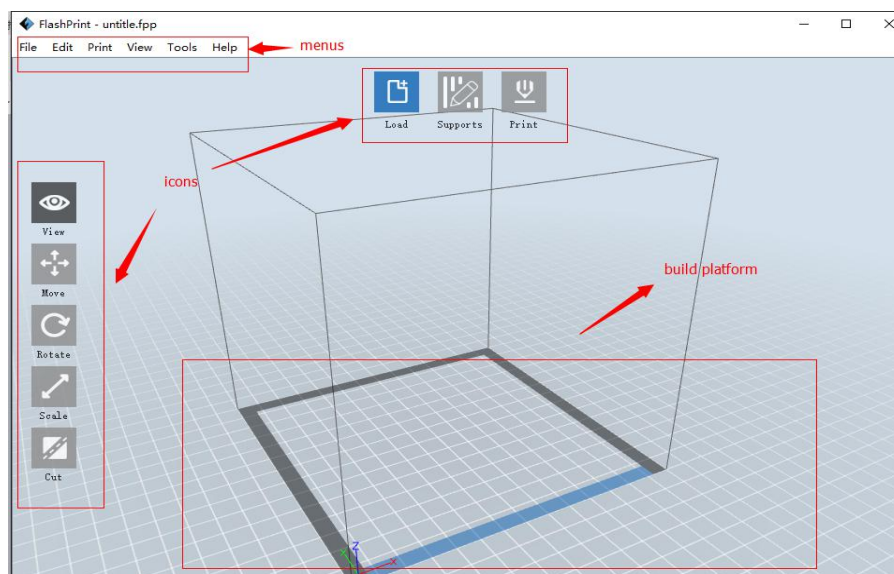

6-2

6.2.2 Software Introduction



	Load files.
	Enter the support edit mode
	Print it directly with your GuiderIIS or export to your USB Stick
	View FlashPrint home screen from one of six viewing angles
	Move model around on XY-plane; shift+click to move along Z axis
	Turn and rotate your model
	Scale the size of your object
	Cut model into several parts

6.2.3 Loading

You can load a model file or Gcode file into your FlashPrint by the following six methods:

Method 1: Click the **[Load]** icon  on the main interface. Then select the object file.

Method 2: Select the file for loading and drag the file to the main interface of the software.

Method 3: Click **[File]--[Load File]**. Then select the object file for loading.

Method 4: Click **[File]--[Examples]** to load the example files

Method 5: Click **[File]--[Recent Files]** to load the files opened recently.

Method 6: Select and drag the target file to the icon of FlashPrint.

Note: **.STL, .OBJ, and .FPP**, ways to store 3D models, are supported by FlashPrint for editing.

Generating Rilievo

Load a png, jpg, jpeg, bmp picture file into the FlashPrint. And the following dialogue box (6-3) will pop up. The setting box includes settings for shape, mode, maximum thickness, base thickness, bottom thickness, width, height, top diameter and bottom diameter.

Shape: including plane, tube, canister and lamp.

Mode: including “darker is higher” and “lighter is higher”.

Maximum thickness: Z value of the model

Base thickness: The minimum raft thickness and the default value is 0.5mm

Width: X value of the model

Depth: Y value of the model

Bottom thickness: For tube, canister and lamp to set up bottom thickness

Top diameter: For tube, canister lamp and seal to set up the top diameter

Bottom diameter: For tube, canister, lamp and seal to set up the bottom diameter

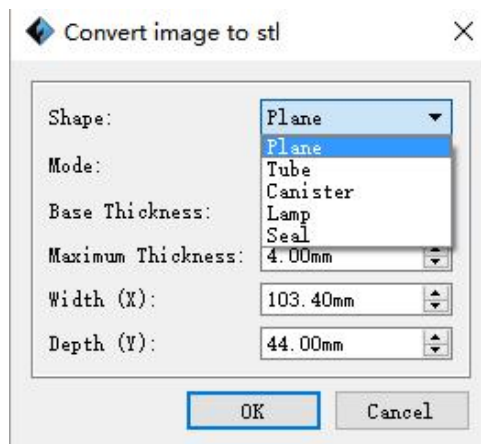

6-4



Plane (6-5)

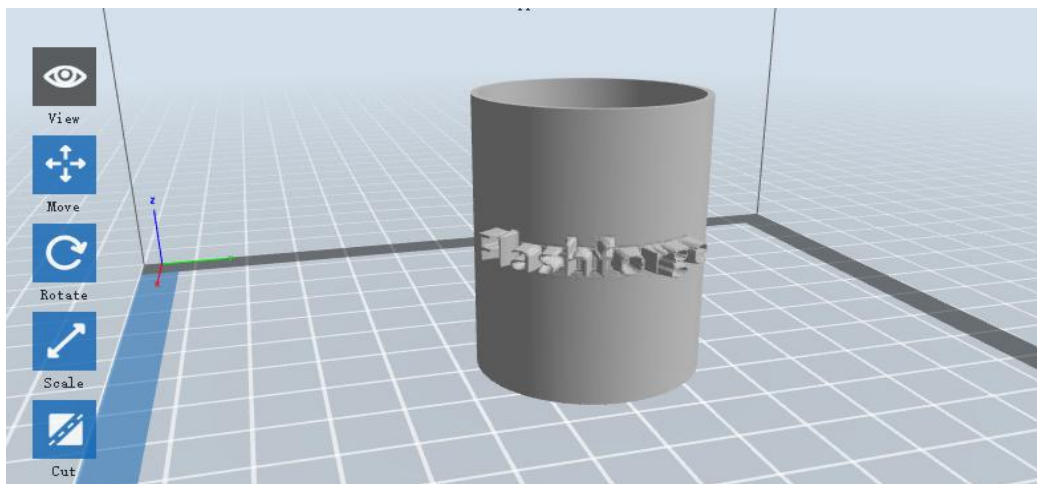

Tube (6-6)

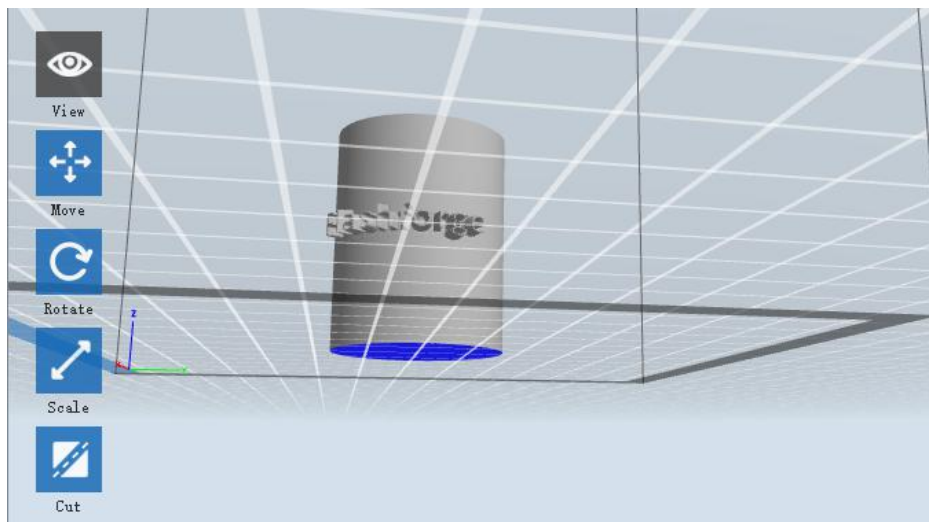

Canister (6-7)

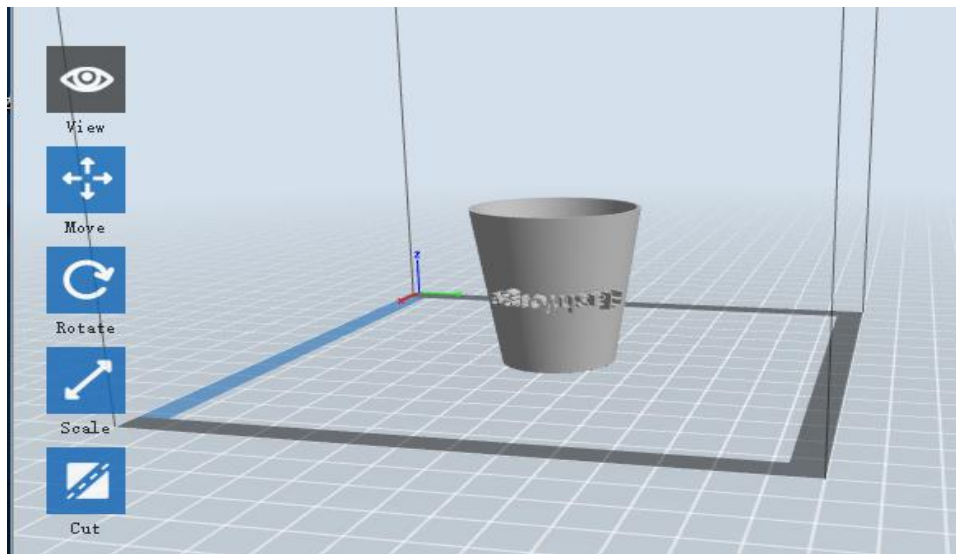

Lamp (6-8)

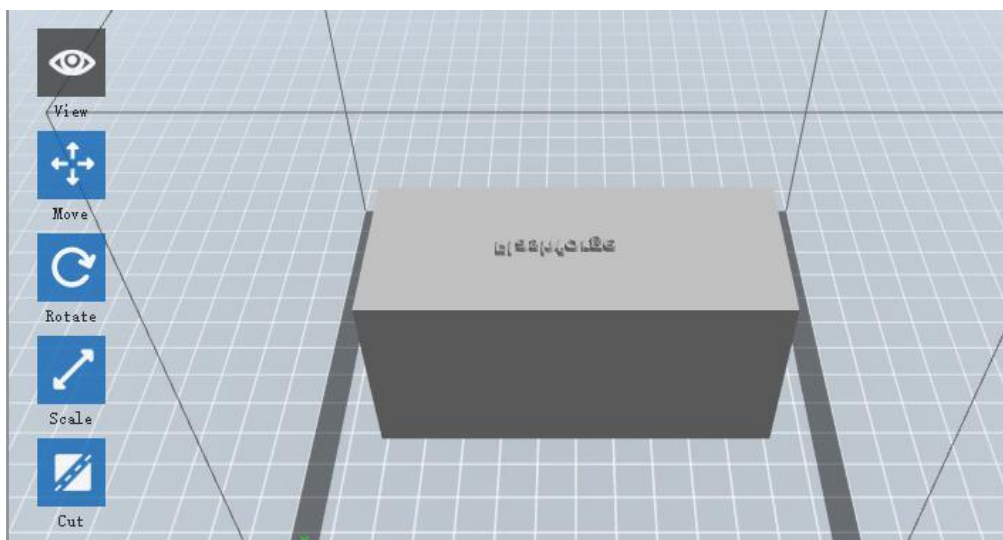

Seal (6-9)

6.2.4 Views

① Changing views

Change model views by moving, rotating, scaling.

• Drag

Click the **[View]** icon  and then you can move the object by the following three methods:

Method 1: Hold down the left mouse button and drag.

Method 2: Hold down the mouse wheel and scroll up and down.

Method 3: Hold down the **Shift** key, hold down the right mouse button and drag.

- **Rotate**

Click the **[View]** icon  and then you can rotate the object by the following two methods:

Method 1. Hold down the right mouse button and drag.

Method 2. Hold down the **Shift** key, hold down the left mouse button and drag.

- **Scale**

Rotate the mouse wheel to enlarge or shrink the build plate.

②Set View

Allow users to view the object on the build plate. Six views are under the view menu, that is, bottom view, top view, front view, back view, left view and right view.

Method 1: Click the the **[View]** button, there are six views in the drop- down list

Method 2: Click the the **[Look]** icon  on the left, click it again and a submenu will appear with six views for selecting.

③Reset View

Allow users to reset views by the following two methods:

Method 1: Click the **[View]** menu and select **[Home View]**

Method 2: Click the **[View]** button on the left, click it again and you will see the viewing options, you can click **[Reset]**.

④Show Model Outline

Click **[View]**--**[Show Model Outline]**, it will highlight the yellow border of the object

⑤ Show Steep Overhang

Click **[View]**--**[Show Steep Overhang]**. When the intersection angle between the model surface and horizontal line is within the overhang threshold value, the surface has steep overhang and it becomes red in the software. Overhang threshold value could be set as needed. The default value is 45 degree.

6.2.5 Move

Select the object and move the object by the following two methods:

Method 1: Click the **[Move]** icon on the left, hold down the left mouse button and drag to adjust the location of the model in XY direction. Hold down the **Shift** key, hold down the left mouse button and drag to adjust the location of the model in Z direction. The distance and the direction of the movement shall be displayed.

Method 2: Click the **[Move]** button on the left and then enter the distance value. Click **[Reset]** to reset distance values.

Note: Users shall click **[Center]** and **[On Platform]** after the location adjustment to ensure the model(s) be within the build area and on the build platform. If a specified position is needed, only click **[On Platform]**.

6.2.6 Rotate

Select the target object and rotate the object by the following two methods:

Method 1: Click the **[Rotate]** icon on the left and three mutually perpendicular rings appear around the object. Click one ring and rotate on the present axis, you will see the rotation angle and direction in the center of circle. In this way, you could make the model rotate on X/Y/Z axis.

Method 2: Click the **[Rotate]** icon on the left, and then enter into rotating angel values in X/Y/Z axes positioning. Click **[Reset]** to reset rotating angel values.

6.2.7 Scale

Select the target object and scale the object by the following two methods:

Method 1: Click the **[Scale]** icon on the left, hold down the left mouse button and scale the model. The corresponding values will display near the object.

Method 2: Click the **[Scale]** icon on the left and then enter into scale values in X/Y/Z axes positioning. Click the **[Maximum]** button to get largest size possible for building. Click **[Reset]** to reset the size of model.

Note: If the **[Uniform Scaling]** radio button is clicked, it will scale the model in equal proportion when changing **value** in any positioning of the model. Otherwise it will only change the value of the corresponding positioning.

6.2.8 Cut

Left-click on the model to select it and double-click on the **[Cut]** icon to set the cut plane. The direction and position are available for setting.

① Draw with Mouse

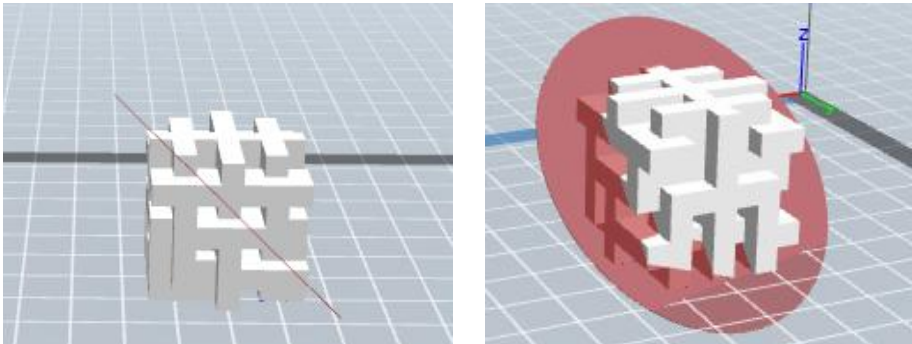

② X Plane

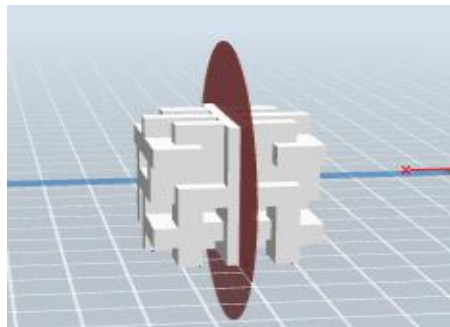

③ Y Plane

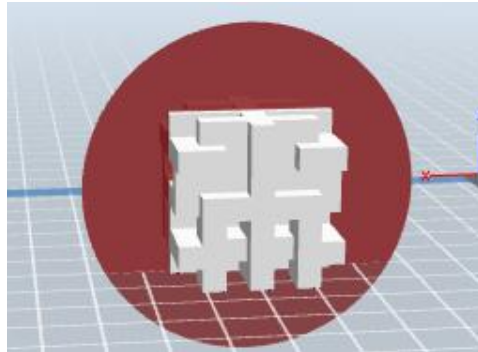

④ Z Plane

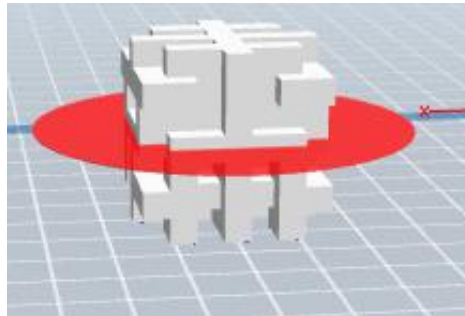

6.2.9 Supports

After loading the model, click **[Edit]--[Supports]** or click the **Supports** icon directly, then you will enter the support edit mode (as shown in the picture below). Click **[Back]** to exit when you finish editing.

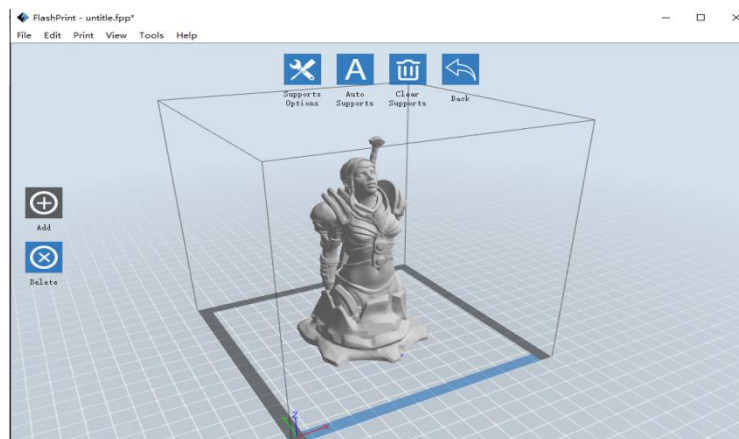

①Support Options

Click the Support Options, an option box will appear, supports options include “treelike” and “linear”, when choose “treelike”, click **[OK]**, then it will generate treelike structure; when choose “linear”, click **[OK]**, then it will generate linear structure; if it is a model with supports, when you choose one of the supports options, software will judge whether existing supports need to be deleted or not on the basis of the type of existing support, and will pop up the corresponding prompt to let you make the choice.

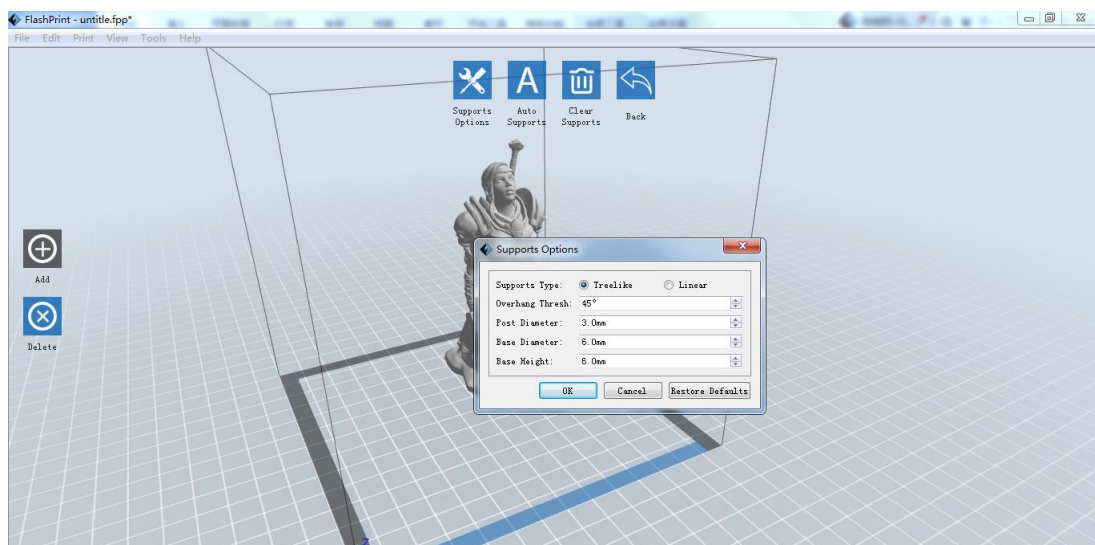

6-11

Click the **[Auto Supports]** button, the software will judge the position where supports are needed and generate corresponding treelike or linear supports. If it is a model with supports, the existing supports will be deleted and new supports will be generated.

③Add Supports

Supports will be added once clicking the **[Add]** button. Move the cursor to the position where supports needed, left-click to choose the starting point of supports, hold down the left mouse button and drag the mouse the supports preview will show up (if support surface doesn't need support or the support column angle is too large, will

highlight the support review). Loosen the left mouse button, if support column doesn't meet with model, then support will be generated on origin and terminal point (the highlighted preview support won't generate support structure)

④ Clear Supports

Click **[Clear Supports]**, all supports will be deleted. The operation can be repeated via clicking **[Undo]** or pressing the shortcut key **Ctrl+Z**.

⑤ Delete Supports

Supports will be deleted once clicking the **[Delete]** button. Move the cursor to the supports needed deleting, current supports and its subnode support will be highlighted, click the left mouse button to delete these highlighted support.

6.2.10 Print

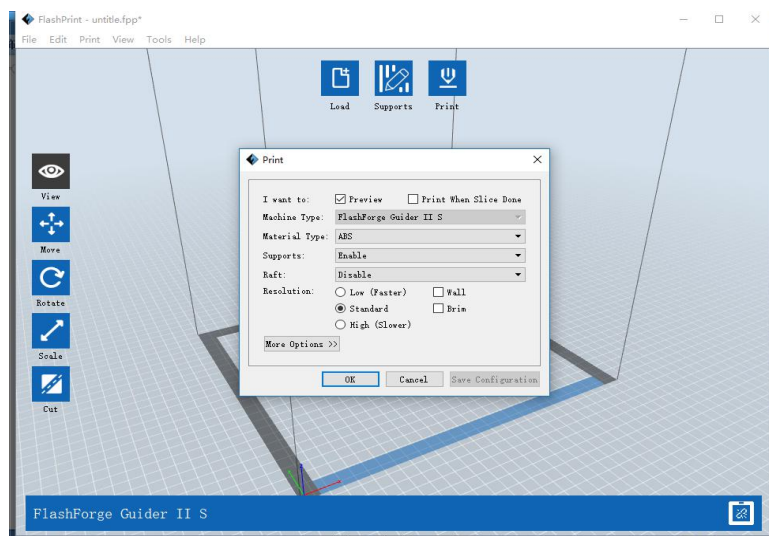

①**Preview:** Choose to enter preview interface or not

②**Print when slice done:** Print or not when slice done

③**Material type:** Choose according to the type of model

④ **Supports:** When print suspended structure models, support is necessary. Click **[supports]** to create support part for the printing.

- ⑤ **Raft:** This function will help the model to stick well on the platform.
- ⑥ **Wall:** During dual color printing, this function will help to clear the leaking filament of another extruder.
- ⑦ **Brim:** Expand the outline of model's bottom layers to a Brim which helps anchor the edges of the model to the plate to avoid warping.
- ⑧ **Resolution:** You have three resolution solutions (with default setting) to choose from, high resolution is corresponding with slow printing speed, opposite for the low resolution. For PLA printing, an extra solution "Hyper" is available.
- ⑨ **More options:** Click [\[More options\]](#) to set for layer, shell, infill, speed and temperature. Different resolution solution is corresponding to different defaults, click [\[Restore Defaults\]](#) to back to default setting.

- **Layer**

a. **Layer:** Layer thickness of the printing model. With a small value, the surface of the model will be smoother.

b. **First Layer Height:** This is the first layer of the model, which will affect the sticking performance between the model and platform. Maximum is 0.4mm, usually the default is OK.

c. **Shell:** Contains the outside shell value, capping layer value (under vase pattern, top solid layer setting is invalid.)

- **Perimeter Shells:** Maximum is 10

a. **Top Solid Layer:** Maximum is 30, minimum is 1.

b. **Bottom Solid Layer:** Maximum is 30, minimum is 1.

- **Infill**

a. **Fill Density** means fill rate.

b. **Fill Pattern** is the pattern of filling shape which effects printing duration.

c. **Combine Infill:** You can select the layers for combining according to the layer thickness. The combined thickness should not exceed 0.4mm. “Every N layers” is for all the infills while “Every N inner layers” is only for inner infills, which generally can save print time.

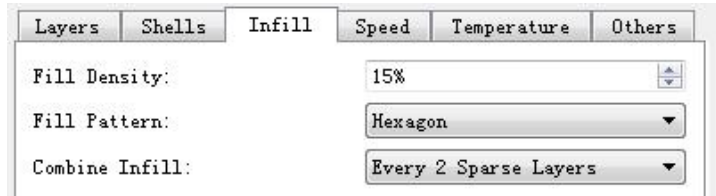

6-13

• Speed

a. **Print Speed** is the moving speed of the extruder. Generally, the lower speed is, the better print you will get. For PLA printing, 80 is recommended.

b. **Travel Speed** is to control the moving speed of the extruder under non-printing Status during work. For PLA printing, 100 is recommended.

Note: Modify parameters settings to get better prints as different models need different parameters.

• Temperature

Extruder Temperature: Recommended extruder temperature is 220°C.

Note: Different temperatures have subtle influences in prints. Please adjust the temperature according to the condition in order to get a good print.

Platform Temperature: To set the temperature of Platform.

• Others

Cooling Fan Control: Set up the time to turn on the cooling fan. You can pre-set the height and make the cooling fan begin to work at the point.

Pause At Heights: Allows users to pre-set a height in which the print will suspend automatically. The function usually applied when you want to change the filament at a certain point. (6-14) Click [Edit], then you can add or remove a height.

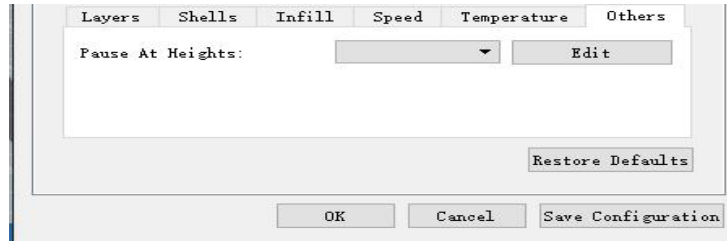

6-14

①New Project

Click **[File]--[New Project]** can build a blank project. If there is an unsaved modification on previous project, then it will inform you whether the modification needs to be saved or not. Click **[Yes]** will save the modification, while click **[No]** will abandon it. If click **[Cancel]** or close tool tip, then will cancel the new project.

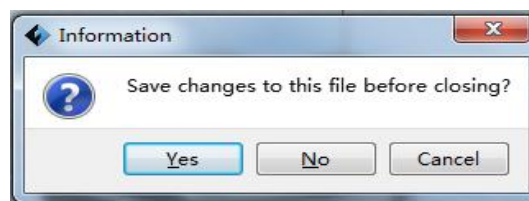

6-15

②Saving

After finishing the model edit and adjustment, there are two ways below to save all models in the scene.

Method 1:

Click **[File]--[Save Project]** in the menu bar to save the file as a project file with the “.fpp” suffix, all models in the scene (include support) are independent. After reloading the files, extruder configuration information and model position will be the same as the configuration during saving.

Method 2:

Click on **[File]--[Save as...]** to save the model as project file .fpp or .stl and .obj. For .stl and .obj, models are integrated as one(include support part). If load it again, only the position of the model was saved, not included the printing parameters.

③ Preferences

Click **[File]--[Preferences]**, you can choose language and if needs detecting update when start

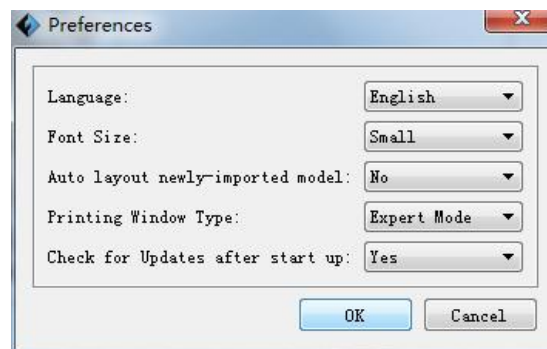

6-16

- **Printing Window Type:** Including Base Mode and Expert Mode
- **Check for Update after start up:** It is used to preset if it is necessary to activate the online automatic update function, if choose yes, every time when you open software, it can online detect if it is a new version software, once new version found, it will reminds users to download and install new version firmware.

6.2.12 Edit Menus

① Undo

Allows users to undo the recent edits by the following two methods:

Method 1: Click **[Edit]--[Undo]**.

Method 2: Press the shortcut **Ctrl+Z**.

② Redo

Allows users to redo the most recent edit you have undone to your model file by the following two methods

Method 1: Click [\[Edit\]--\[Redo\]](#)

Method 2: Press the shortcut [Ctrl+Y](#).

③ Empty Undo-stack

To clean up the recorded operating steps so as to release the memory.

④ Select All

By the following two methods, you could select all models in the scene. (When models are too small to be seen or out of viewing scope, please click [\[Center\]](#) and [\[Scale\]](#) buttons to adjust the model.)

Method 1: Click [\[Edit\]--\[Select All\]](#).

Method 2: Press the shortcut [Ctrl+A](#).

⑤ Duplicate

Select the object and duplicate the object through the following two methods:

Method 1: Click [\[Edit\]--\[Duplicate\]](#)

Method 2: Press the shortcut [Ctrl+D](#)

⑥ Delete

Select the object and delete the object through the following two methods:

Method 1: Click [\[Edit\]--\[Delete\]](#)

Method 2: Press the shortcut [Delete](#)

⑦ Auto Layout All

Click [\[Edit\]--\[Auto Layout All\]](#) after loading one or more than one models, all models will be placed automatically as automatic placement rule.

⑧ Repair Models

Click **[Edit]**--**[Repair Models]** to repair models.

⑨ Supports

Click **[Edit]**--**[Supports]** to enter supports setting interface.

6.2.13 Print Menus

① Connect Machine

You can connect the Guider IIS with your PC via USB cable or WiFi or Ethernet Cable.

Note: The machine icon on the bottom right displays the connection status:

Connected



Disconnected



Method 1: Connect Via USB Cable

- a. Connect your GuiderIIS with your PC via an USB cable.
- b. Turn on your GuiderIIS and start FlashPrint.
- c. Click **[Print]**--**[Connect Machine]**, then select USB in the **[Connection Mode]** option and select machine you want to connect in **[Select Machine]** option. If you can not find your machine, click the **[Rescan]** button to scan your machine and select it. Finally click **[Connect]** button to connect to the printer. If you still can not find your machine after rescan, it means you haven't installed the driver in the software.

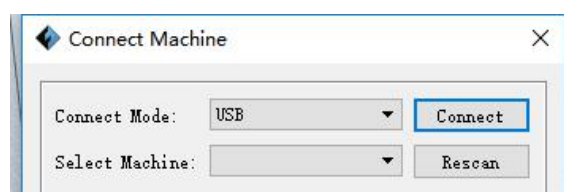
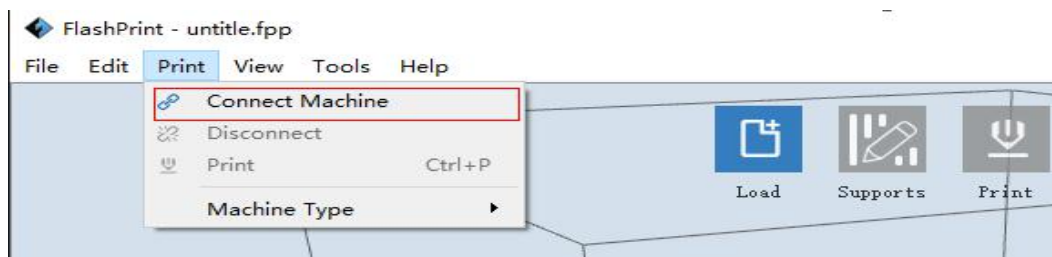

Method 2: Connect Via WiFi

① Connect Guider IIS with your PC under AP mode

- a. Turn on your Guider IIS
- b. Tap **[Tools]-[Setting]-[WLAN hotspot]-[WLAN hotspot ON]**.
- c. Click on the wireless network setting in your computer, and find the wireless signal-“**Guider IIS**”. Click **[Connect]** to connect your computer with Guider IIS via Wlan hotspot.
- d. Click **[Print]-[Connect Machine]** on FlashPrint. Then the following dialog box pops up. You need to select “Wi-Fi” in Connect Mode. Enter into the IP Address shown on the interface and then click **[Connect]**.

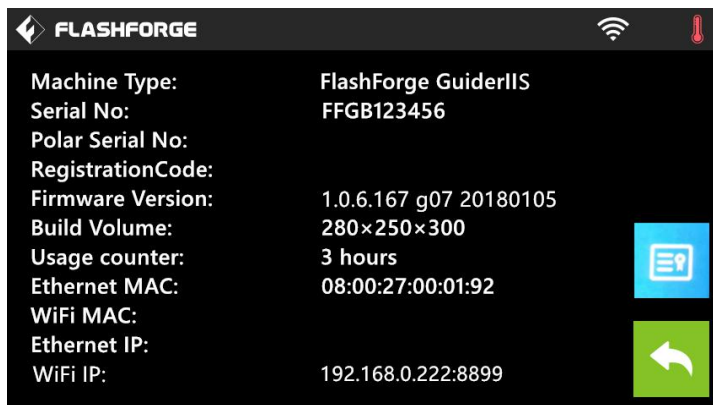
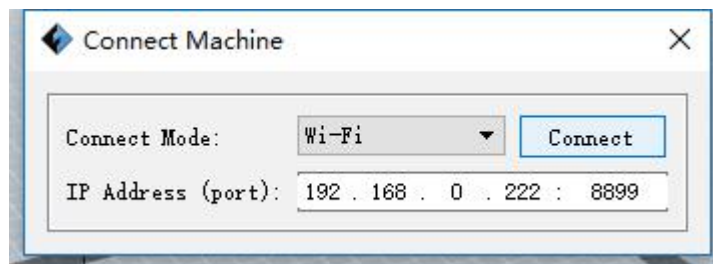

If successfully connected, you will see the following mark on the right corner.



② Connect Guider IIS with your PC under STA mode

- a. Tap **[Tools]-[Setting]-[WiFi]-[WiFi ON]** to turn on the WiFi of Guider IIS and

connect your computer and Guider IIS with the same WiFi signal.

b. Click **[Print]-[Connect Machine]** on FlashPrint. Then the following dialog box pops up. You need to select “Wi-Fi” in Connect Mode. Enter into the IP Address shown on the interface and then click **[Connect]**.

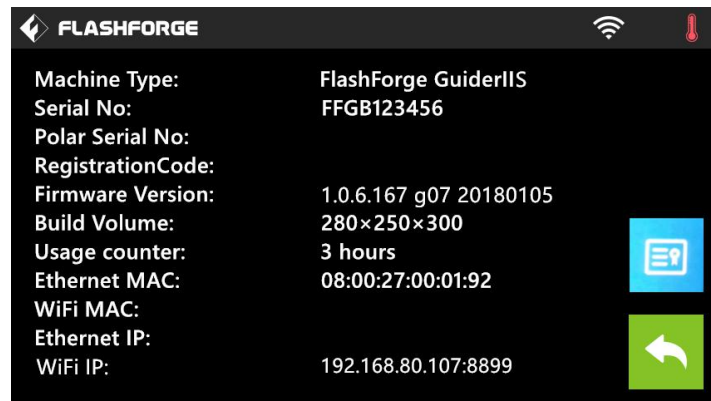
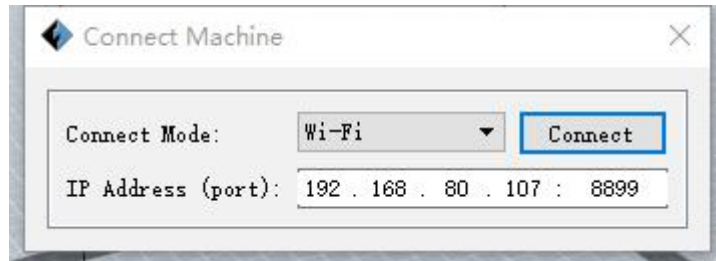

If successfully connected, you will see the following mark on the right corner.



Disconnect GuiderIIS

Click **[Print]-[Disconnect]** to disconnect your PC and GuiderIIS.

Method 3: Connect Via Ethernet

- a. Connect your GuiderIIS with your PC via an Ethernet cable.
- b. Turn on your GuiderIIS and start FlashPrint.

b. Click **[Print]-[Connect Machine]** on FlashPrint. Then the following dialog box pops up. You need to select “Ethernet” in Connect Mode. Enter into the IP Address shown on the interface and then click **[Connect]**.

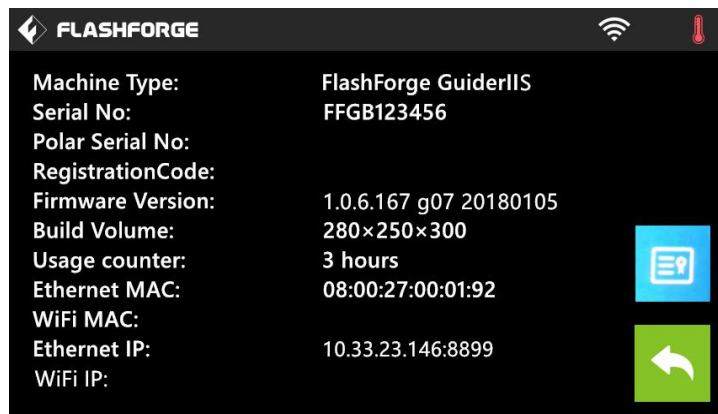
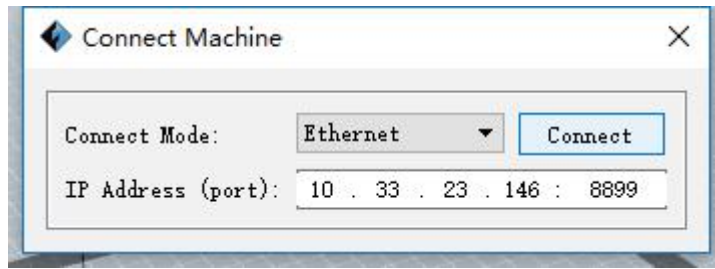

6.2.14 Tool Menus

① Control Panel

After connecting PC with GuiderIIS, click [\[Tools\]--\[Control Panel\]](#) to open the control panel.

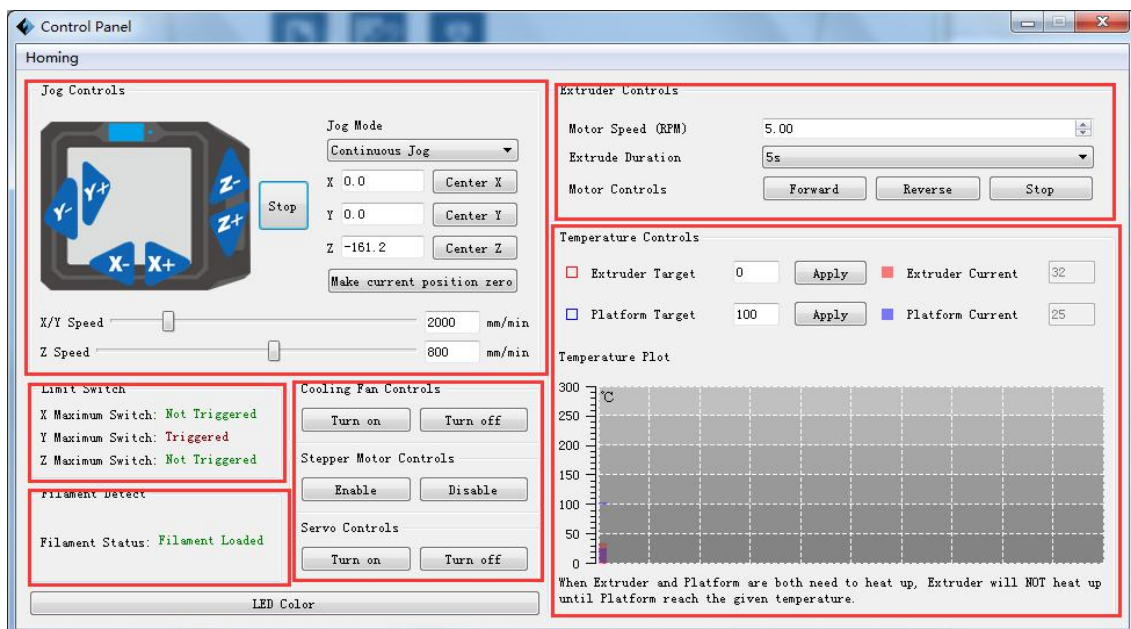

• Jog Controls

a. Jog Mode: Select the distance that extruder/ build plate move a single time (that is,

the distance extruder/ build plate move upon your single click).

b. Six blue arrow direction buttons: Control the move along X/Y/Z axis. X/Y axis button control extruder move, Z axis button control build plate move. Click X-, extruder will move leftward a specified distance; Click X+, extruder will move a specified distance rightward. Click Y-, extruder will move forward a specified distance; Click Y+, extruder will move backward a specified distance. Click Z+, build plate will move upward a specified distance; Click Z-, build plate will move downward a specified distance. (Specified distance refers to the move distance you set in Jog Mode.

c. Stop: Click the **[Stop]** button to abort the current movement.

d. XYZ coordinate frame on the right side: Show the current position of extruder/build plate.

e. Make Current Position Zero button: Set the current position of the extruder/build plate as (0, 0, 0). (**NOTE:** X, Y, and Z boxes are for display purposes. Changing the value in the boxes will not affect anything.

f. Center X/Y/Z button: Extruder and build platform will back to the zero (0, 0, 0) you set last time.

g. X/Y Speed and Z Speed: Set the move speed of extruder/ build platform.

- **Limit Switch:** In order to protect your GuiderIIS, three limit switches are equipped to control the maximum position, and the three limit switches corresponding to X/Y/Z axis limit switch. It has two statuses:

a. Not Triggered: If the extruder/build plate don't move to its maximum, X/Y/Z axis limit switch is not triggered, and shows “**Not Triggered**”.

b. Triggered: If the extruder/build plate moves to its maximum, X/Y/Z axis limit switch is triggered, and shows “**Triggered**”.

- **Stepper Motor Controls:** Allows users to control to stepper motor. Click **[Enable]**, and lock the motor so it does not allow any movement; click **[Disable]**, and unlock the

motor to be controlled manually.

- **LED Color:** Allow users to change the LED color of GuiderIIS.
- **Extruder Controls:** You can set the value of “**Motor Speed (RPM)**”, which can control the rotation speed of filament feeding wheel. The motor rotation time can be controlled via setting the value of “**Extruder Duration**”. Generally we suggest the users choose option of continuous time 60 seconds. The filament must be loaded in the extruder before motor starts. **Therefore, do not start rotation operation until the extruder temperature reaches to the printing temperature of filament.** For PLA filament, the extruder temperature should reach 200°C, after reaching the extruder temperature, click the **[Forward]/[Reverse]** rotation button to control filament load and filament unload. Furthermore, if you want to stop filament load and unload, you can click **[Stop]**.
- **Temperature Control:** Input the temperature you want to get in the left frame, click **[Apply]**, the printer will automatically heat the corresponding part, the right side shows the current actual temperature of corresponding part. After starting heating, the below curve of temperature form will start to change, different color correspond different parts’ temperatures

② Update Firmware

NOTE! Please update firmware under instructions of Flashforge engineer, Do not recommend updating on your own.

Every time when you start FlashPrint, it will automatically detect and download the up-to-date firmware. If any update is available, a dialog box will pop up for reminding the users to update.

Step 1: Click **[Tools]--[Update firmware]**. It needs to cut off connection before updating firmware. If software and printer are already in connection, it reminds you cutting off the connection, and then choose **[Yes]** and go on to the next step.

Step 2: Choose corresponding printer type and firmware version and click **[OK]** in the firmware updating box. After confirming the printer is in free state, the software will automatically update the firmware

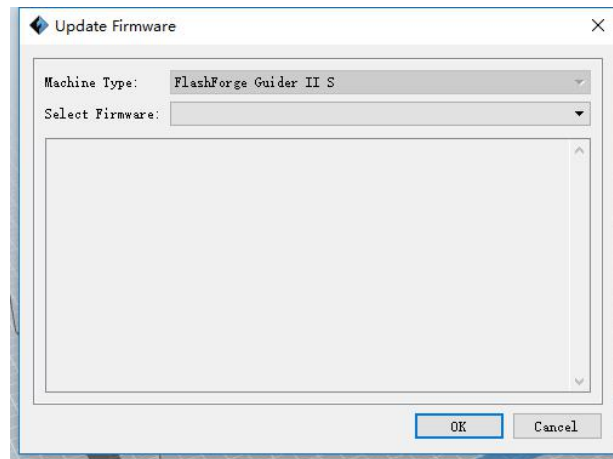

Step 3: Reboot you Guider II and wait for 4-5 seconds, then you can see the update process bar. When the update finishes, it will go back to the main interface.

Step 4: Tap **[Tools]--[About]** to check whether the updated version is right.

③ On Board Preferences

When the computer and printer are in connection, click **[Tools]--[On Board Preferences]**, you can check the printer name.

④ Machine information

When the computer and printer are in connection state, click **[Tools]--[Machine information]**, you can check the machine type, machine name and firmware etc.

6.2.15 Help Menus

① First Run Wizard

② **Help Contents:** Click **[Help]--[Help Contents]**, you can read the help contents.

③ **Check for Updates:** Click **[Help]--[Check for Update]** to detect the available updates online.

④ **About FlashPrint:** Click **[Help]--[About FlashPrint]**, the software information box will pop up. The contents include the current software version and copyright information.

Chapter 7: Basic Printing

This chapter will provide a step-by-step guide on turning a 3D model into a physical reality. Before proceeding, it is recommended that you'd better go over prior chapters on loading/unloading filament, leveling the build platform, and the functions and capabilities of FlashPrint.

7.1 Generate a Gcode

(7-1) Double-click the icon of FlashPrint to start the software.



7-1

(7-2) Click **[Print]**--**[Machine Type]** to select **FlashForge GuiderIIS**

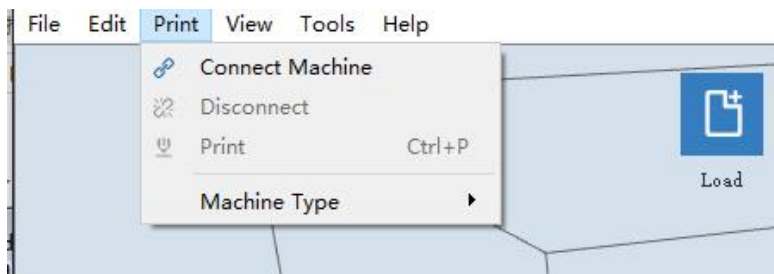

7-2

(7-3) Click the **[Load]** icon to load a .stl model file and the object will display on the build area.

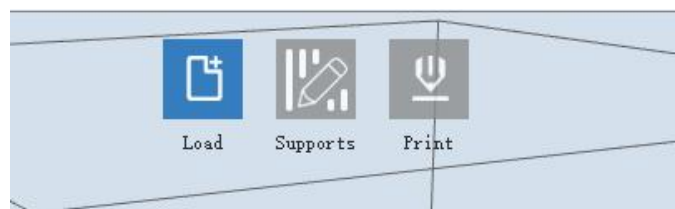

7-3

(7-4) Click **[Edit]**--**[Surface to Platform]** to make your model perfectly positioned

on the build area. Click **[Back]** and double-click the **Move** icon again, then click **[On the Platform]** and **[Center]** to ensure the model be on the platform.

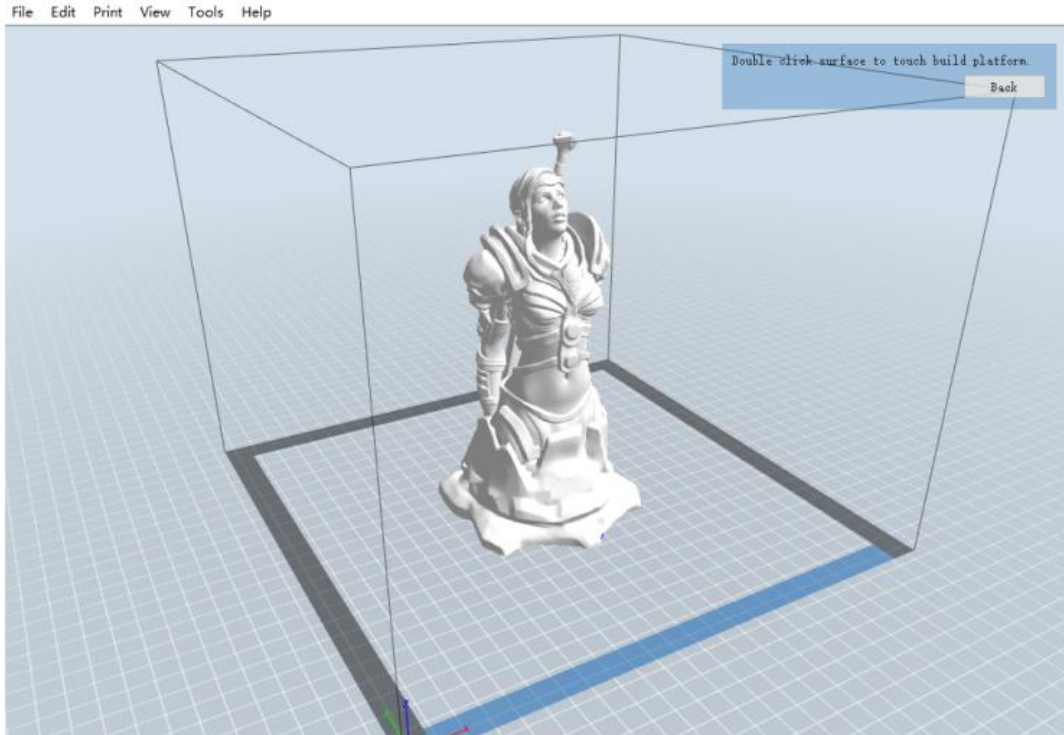

7-4

Note: If you've place your model in a right place, you can skip the step above.

(7-5) Click the **[Print]** icon on the top, you should make some setups for your print job.

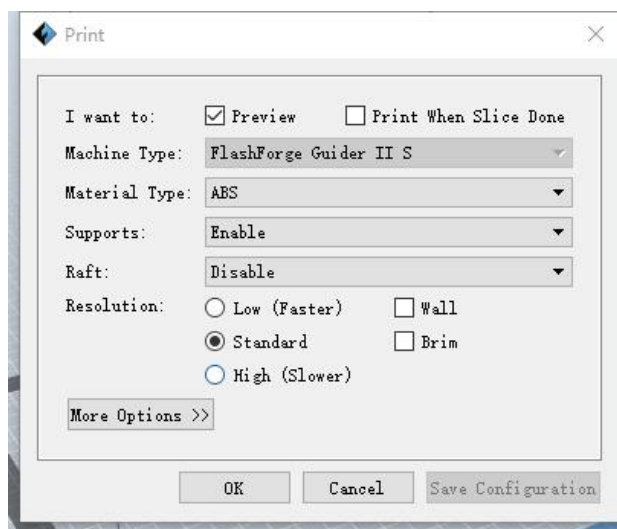

Preview: If you check the **[Preview]** box, you can preview your model after slicing is

done.

Print When Slice Done: If you print via USB cable, you can check the box, while if you print via USB, you should not check the box.

Machine Type: FlashForge Guider IIS

Supports: If you print a model with supports, you should click the inverted triangle and select **[Enable]**.

Raft: You are suggested to select **[Enable]**.

Resolution: You are suggested to select **[Standard]**

More Options: You are suggested to keep them default.

Click **[OK]** to select the path to save the Gcode file. You can rename the file as you like and save it as a .g or .gx file, click **[Save]** to generate a Gcode file.

Note: .gx files are available for preview while the .g files are not. They are displaying as follows:

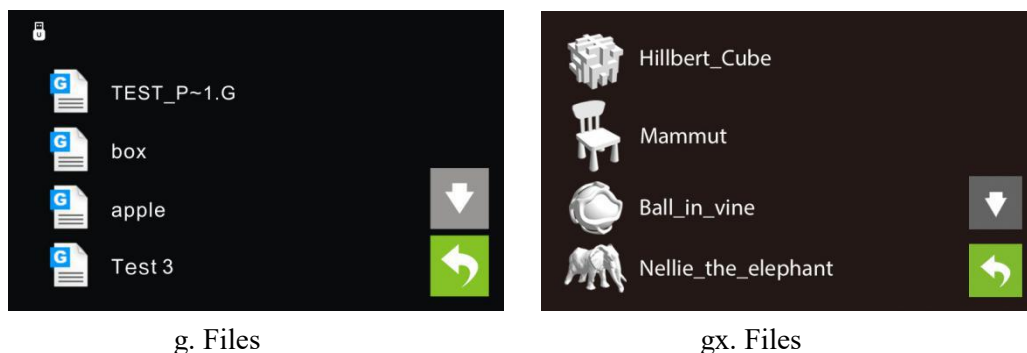

7-7

Next, we are going to print the model.

7.2 Print Methods

After generating the Gcode file, you can transfer it to your Guider IIS. You can transfer the file through USB cable ,USB stick,WiFi , and Ethernet cable.

7.2.1 Print from Computer (USB cable connection)

- ①Connect your GuiderIIS with your PC via a USB cable.(Please refer to **6.2.13**)
- ②Turn on your Guider IIS, level the build plate and load the filament.

③Click **[Print]** and transfer your Gcode file to your Guider IIS. After completing transference, the printer will heat up automatically. And when heating finishes, the print will start to build the model.

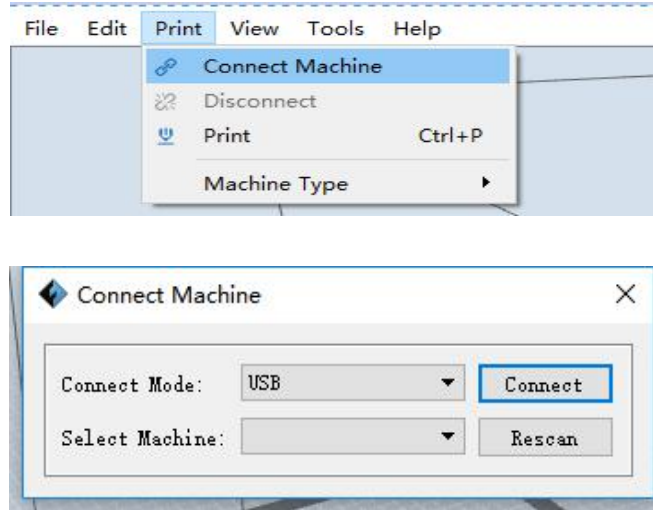

④ When your PC connects with FlashPrint successfully. The status box on the bottom right displays the real-time nozzle temperature. After finishing preheating, your Guider II starts the print job directly.

7.2.2 Print from Computer (WiFi connection)

①Connect your GuiderIIS with your PC via WiFi. (2 WiFi connection methods, Please refer to 6.2.13)

Enter into the IP Address shown on your GuiderIIS interface and then click **[Connect]**.

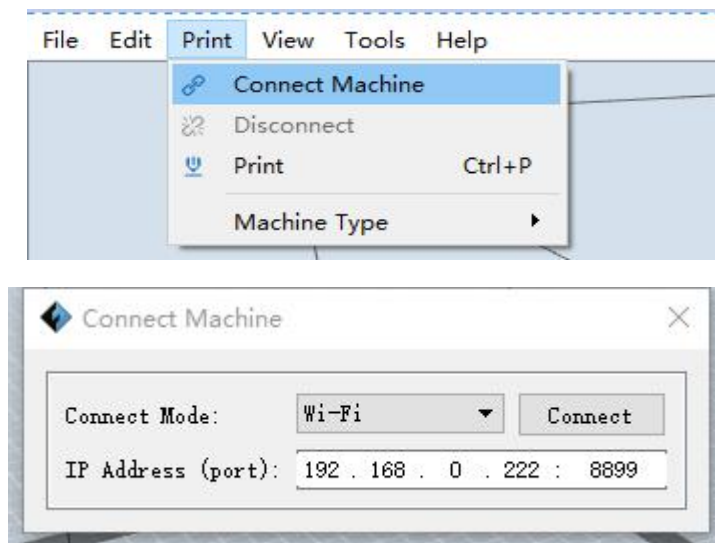

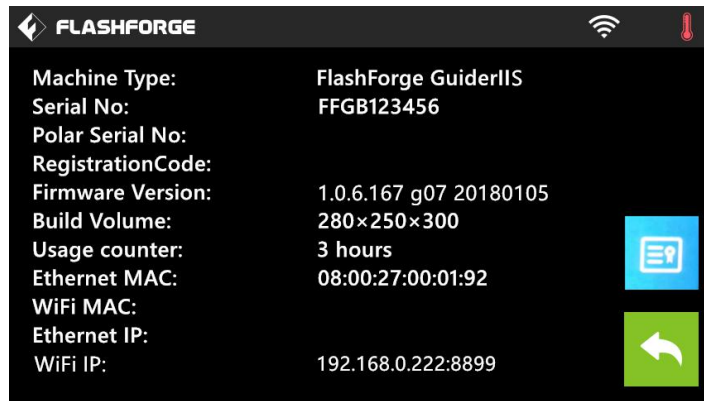

② Turn on your Guider IIS, level the build plate and load the filament.

③ Click **[Print]** and transfer your Gcode file to your Guider IIS. After completing transference, the printer will heat up automatically. And when heating finishes, the printer will start to build the model.

If you want to print a Gcode from a local folder, you just need to load the file into FlashPrint at the status of USB connection or WiFi connection or Ethernet connection, then click the **[Print]** button on the top-right.

- Load the target Gcode file into FlashPrint.

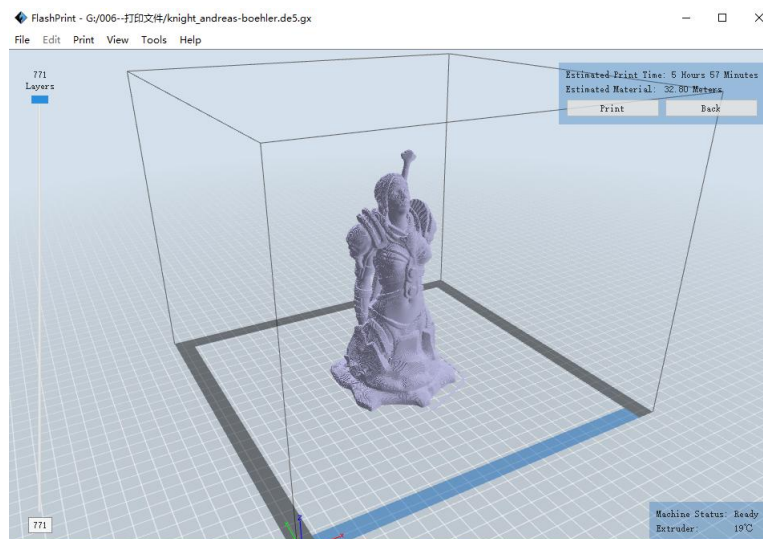

7-9

- Click the **[Print]** button, the PC will transfer the Gcode file to the printer.

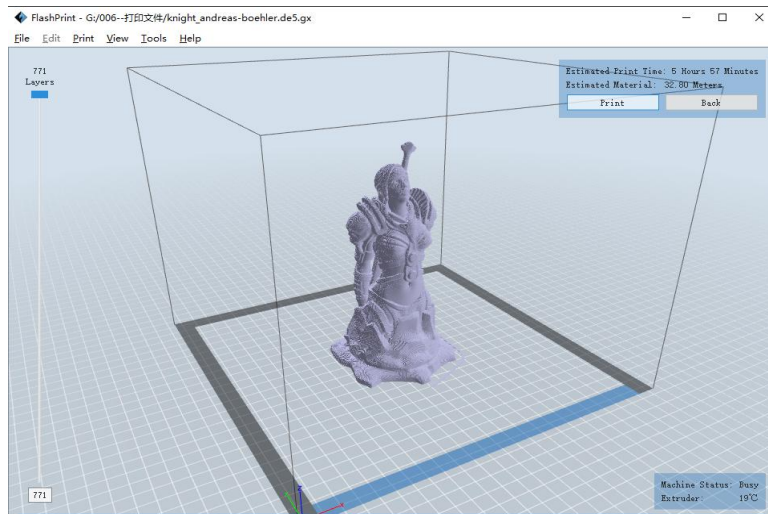

7-10

- After finishing transferring, the printer will heat up automatically. And when heating finishes, the print will start to build the model.

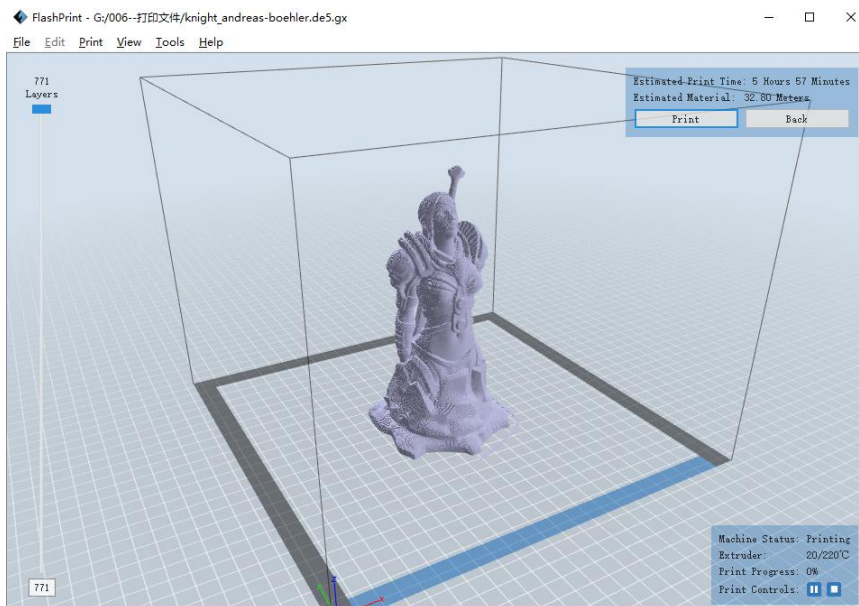

7-11

7.2.3 Print from USB Stick

- ① Insert your USB stick with target .g or .gx file to your Guider IIS .
- ② Turn on the Guider IIS. Make sure the build plate has been leveled and the filament

is loaded.

③ Tap **[Print]** and then tap the **USB Stick** icon in the middle. The file(s) will be displayed on the screen. Select the file you want to print and tap **[Print]**. The file will be transferred to the printer.

⑥ And the printer will heat up the nozzle automatically and start to print after the nozzle reaches the aimed temperature.,

Abort: To stop heating and printing. Once you tap **[Abort]**, the process is irreversible.

Pause: To suspend the print job, you can tap it again to resume it. You can use this function when you want to change the filament halfway.

7.2.4 Print from Computer (Ethernet Cable connection)

① Connect your GuiderIIS with your PC via an Ethernet cable.(Please refer to 6.2.13)

Enter the IP Address shown on your GuiderIIS interface and then click **[Connect]**.

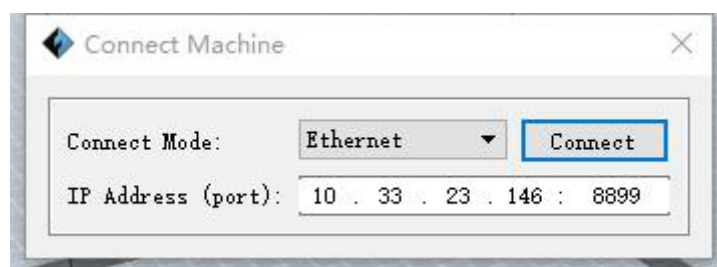
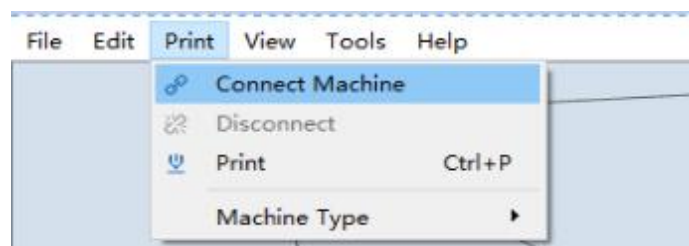

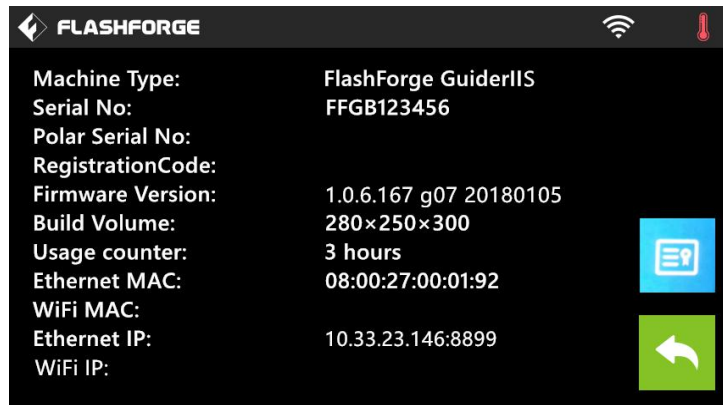

- ② Turn on your Guider IIS, level the build plate and load the filament.
- ③ Click **[Print]** and transfer your Gcode file to your Guider IIS. After completing transference, the printer will heat up automatically. And when heating finishes, the print will start to build the model.

7.2.5 Print from Polar Cloud connection

1) Register a Polar Cloud account with your computer, on website:

<https://polar3d.com/>

Register your account using one of the four following options, take the third microsoft live option as an example, create your new Polar Cloud account.

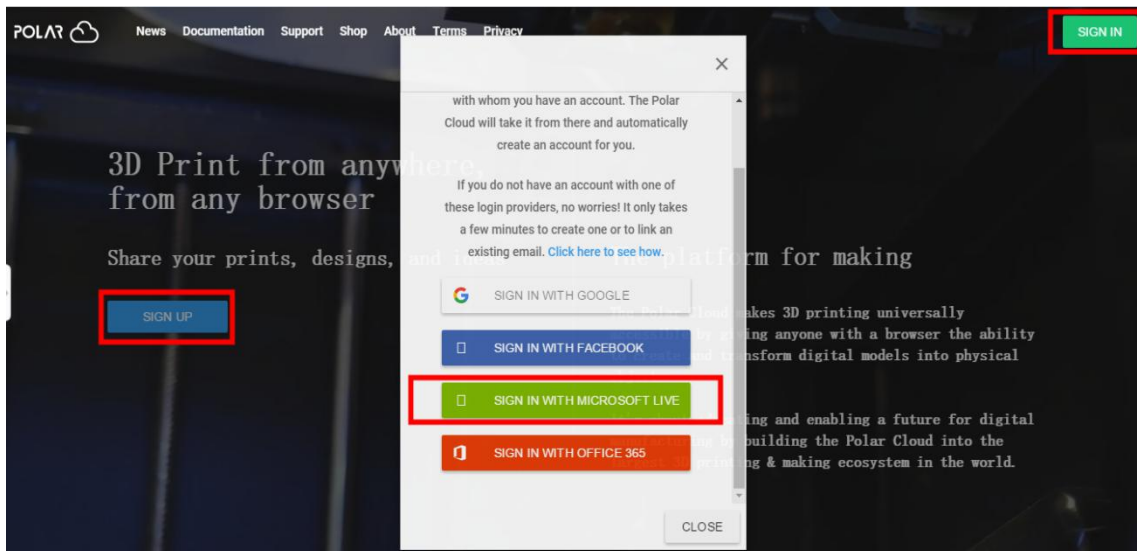



2) Enter the Polar Cloud homepage after you create your Polar Cloud account. Tap the red icon (on the right upper corner showed in the picture below), then Tap [settings], drag down the page to bottom, copy down your Email address and your PIN Code.

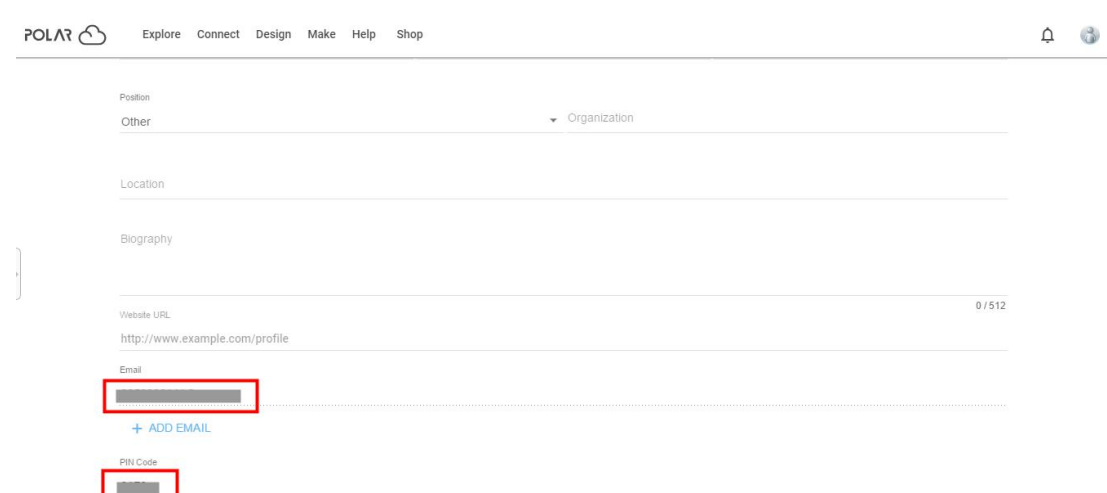
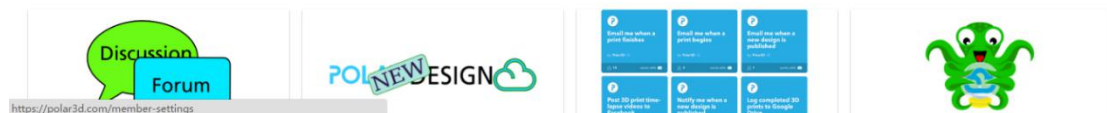

Connect the printer to internet with WiFi or Ethernet Cable;

Tap [Tools]-[Settings]-[Polar Cloud connection] on printer's touch screen;

Input your polar 3D cloud account's Email address(as ID) and PIN Code, Tap[save] .

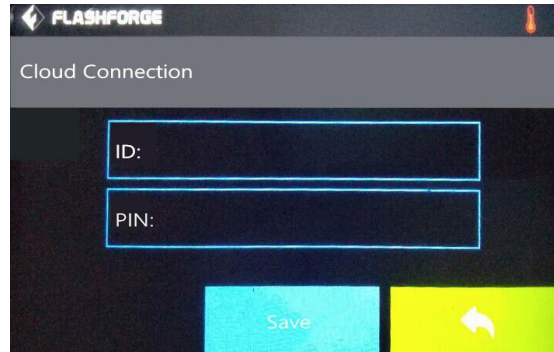

3) Enter the Polar Cloud homepage with your computer again. Tap [Explore] on the left upper corner showed in the picture below, then Tap [Objects]

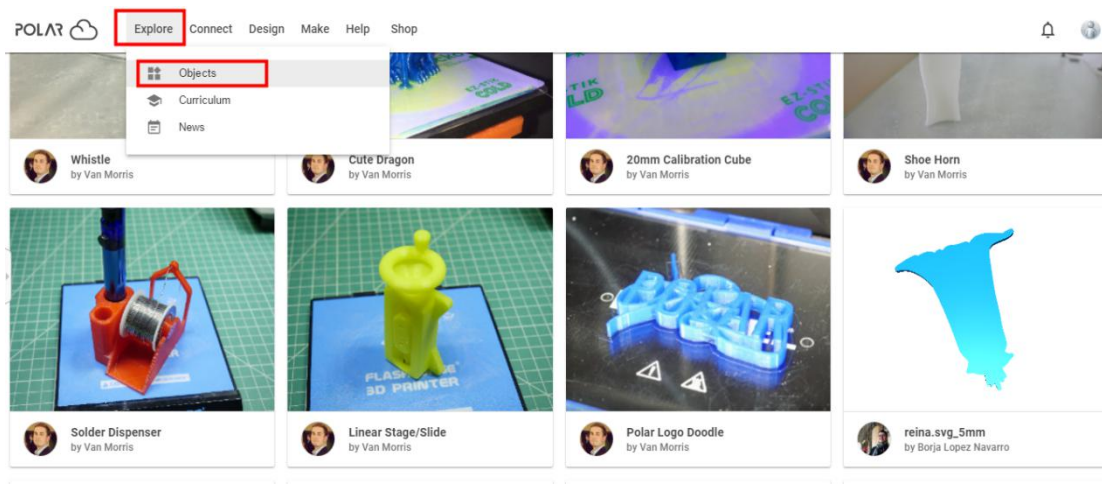

Enter the objects page, choose a model you are going to print.

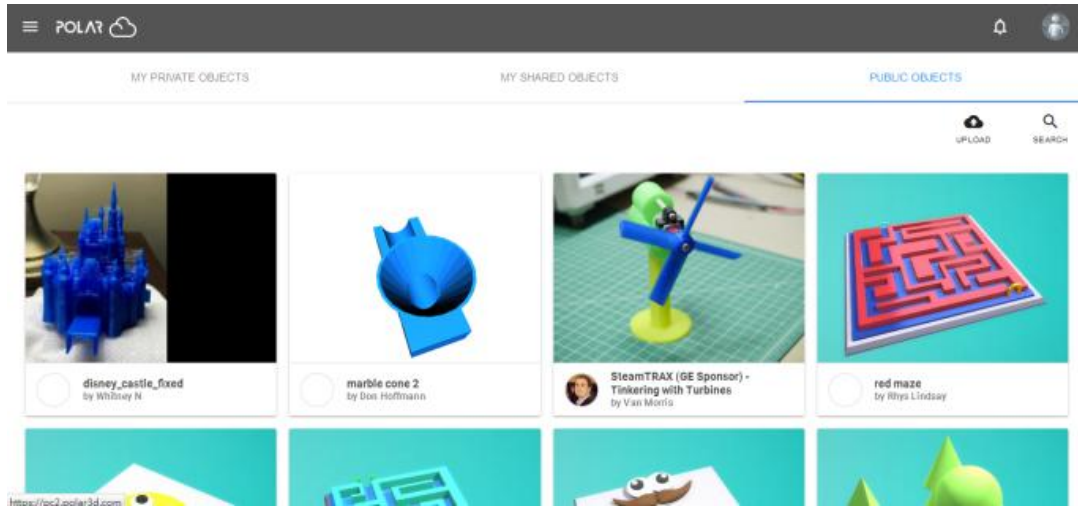

Tap **【3D PRINT】** button



Tap **【PRINT】** button

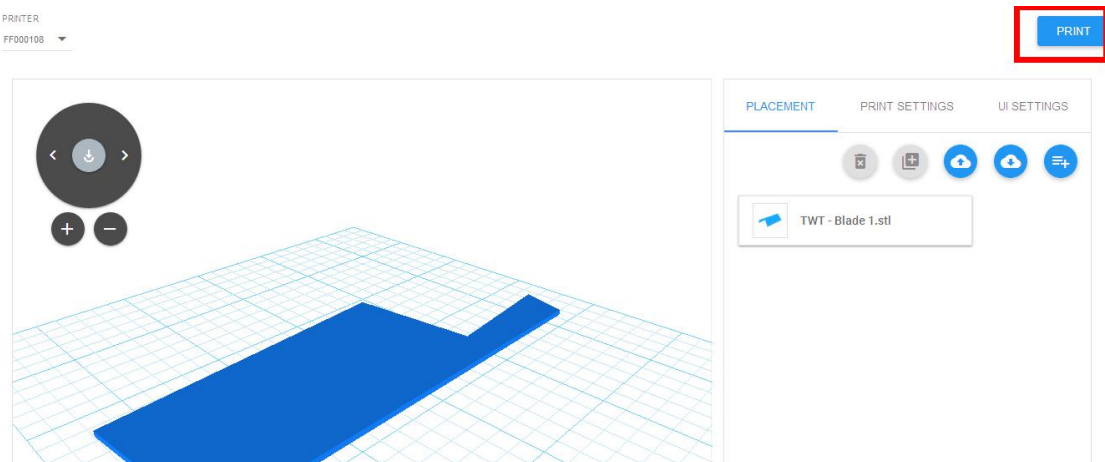

Tap **【START】** button, the printer starts downloading printing file automatically, after downloading completed, you can interactively operate the printer on your computer, including Change Filament, Pause, Stop etc.

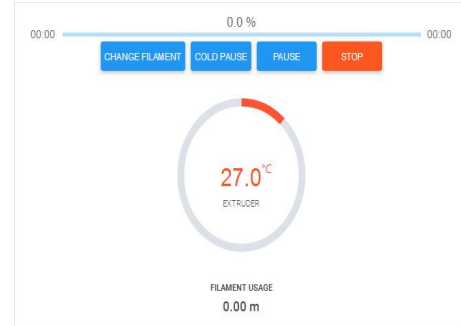
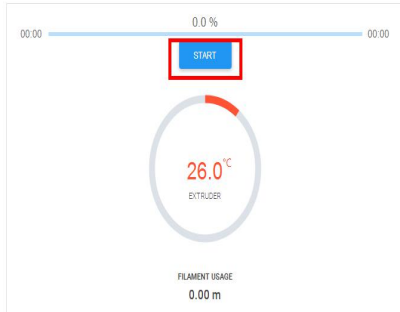

4) More than one of the Flashforge printers can be added to a Polar 3D Cloud account, Flashforge GuiderIIS/GuiderII, Finder, InventorIIS/InventorII, Adventurer3 printers all support Polar 3D Cloud connection. After added to Cloud account and connected successfully, GuiderIIS printer's camera can be used to monitor the real-time printing status, as showed in the picture below:

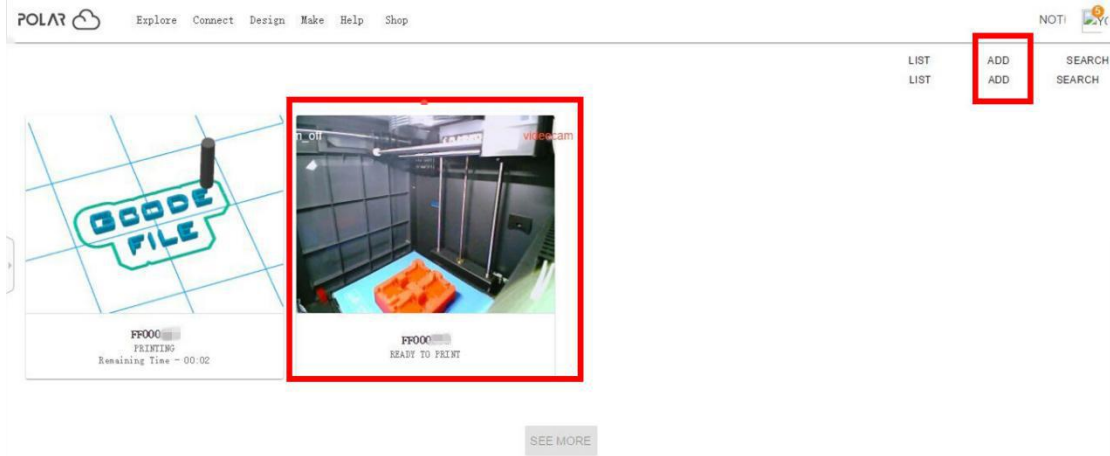

5) By using Polar3D Cloud platform, you can create G-CODE printing job by uploading your own sliced print files. Print files can be transferred to corresponding printer and printing will be started automatically.

You can also adjust the extruder temperature, or explore other cloud functions.

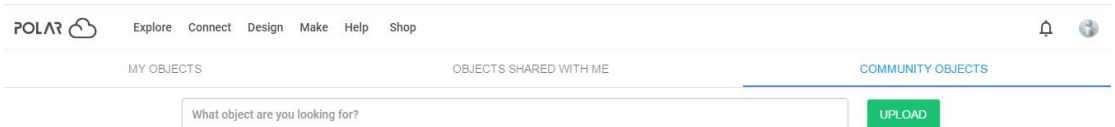
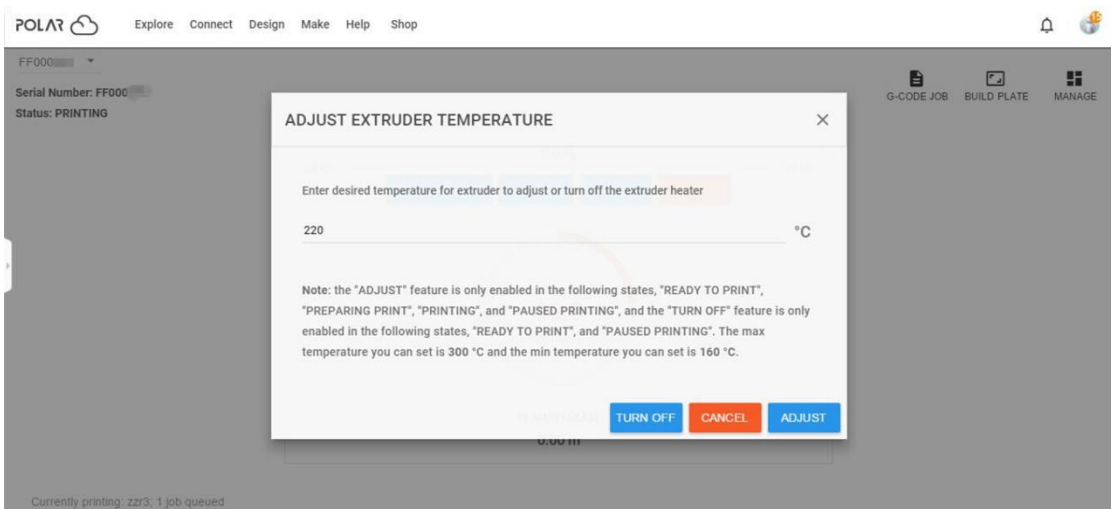
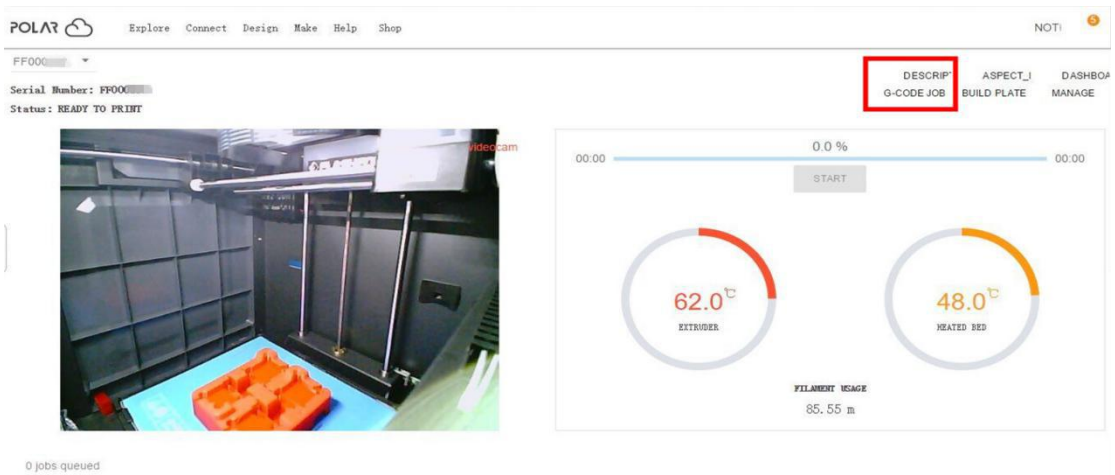

6) Delete a printer from a polar cloud account.(If someone else wants to use the same printer under another polar cloud account, please make sure you've delete the printer from your current-using polar cloud account, or others can not use the printer.)

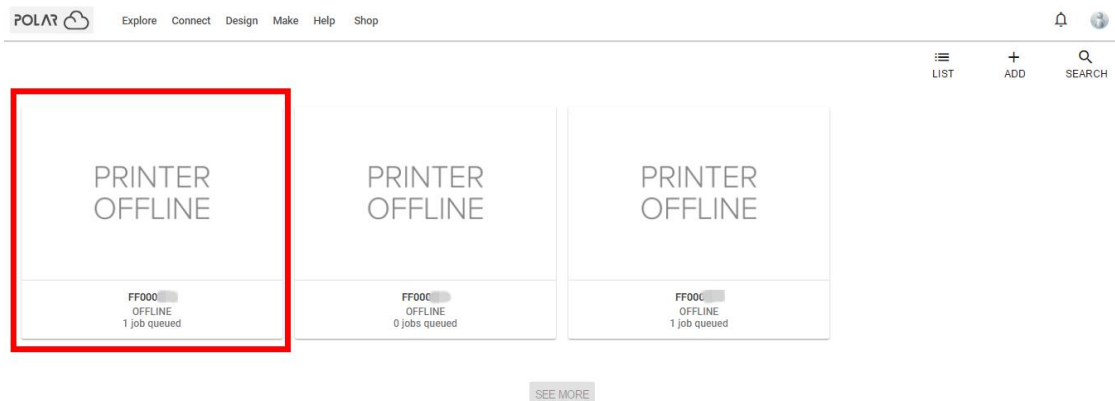

Click the printer you want to delete.

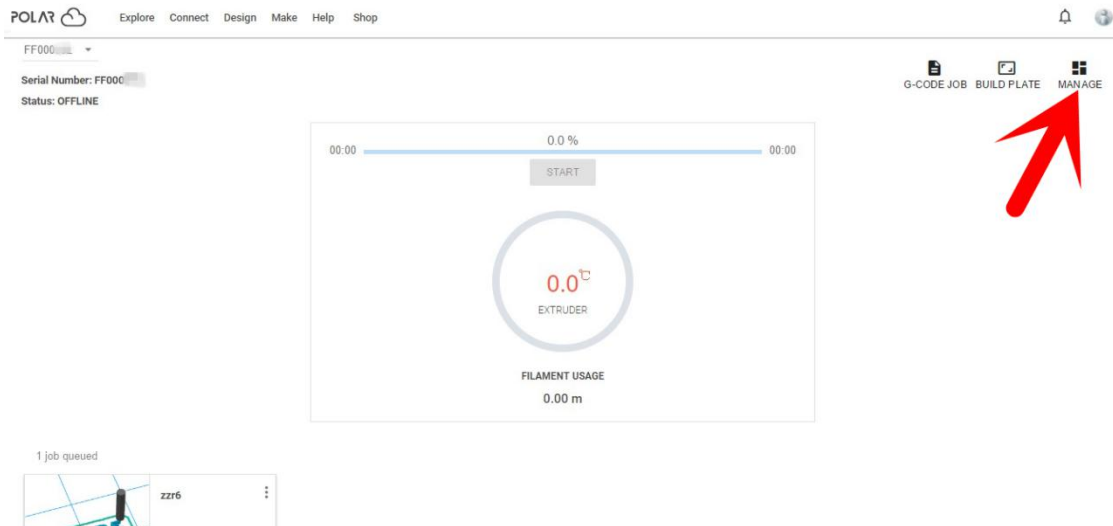

Click [MANAGE] button on the right upper position of this printer's details webpage.

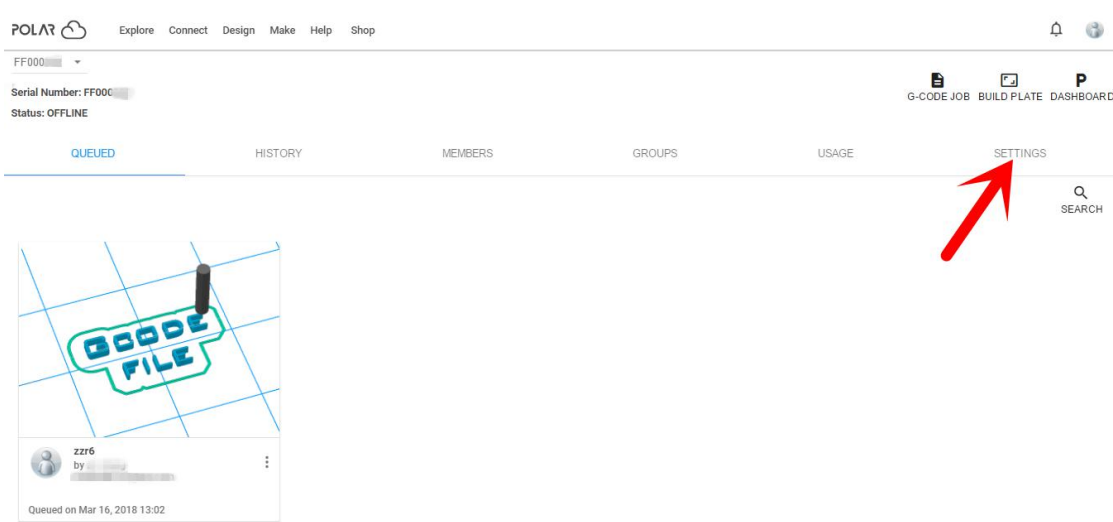

Then click [SETTINGS] button on the right upper position of the next webpage.

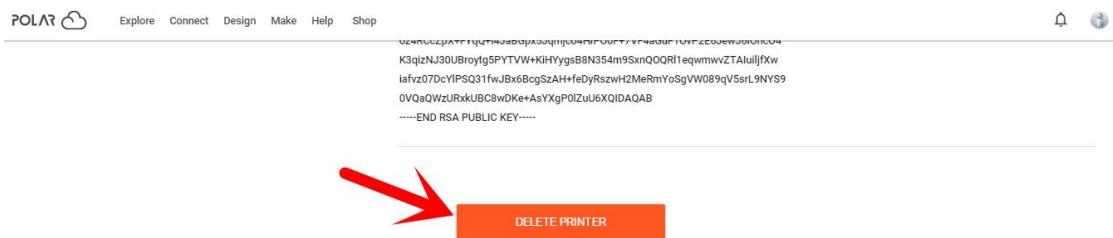

Finally, drag the next page to bottom down, click [DELETE PRINTER] button.

After you've completed the above delete steps, this printer can now be used by others under his own polar cloud account.

7.3 Camera

7.3.1 Connect from Polar Cloud

For detailed connection method, please refer to **7.2.5**

After GuiderIIS printer has added to Polar Cloud account and connected successfully(GuiderIIS printer and your computer should link to Internet by WiFi or Ethernet cable, printer and computer do not need to connect the same WiFi signal), Then GuiderIIS printer's camera can be used to monitor the real-time printing status.

7.3.2 Direct Connect from computer

- 1) Connect your GuiderIIS printer and your computer to a same WIFI signal.
- 2) Install and start up Firefox browser(software) on your computer, type in the following address as the format showed below, then you can monitor the real-time printing status by the camera.

<http://10.33.23.64:8080/?action=stream>

(10.33.23.64 is your printer's present IP address, this address must be edited according to your printer IP address showed on printer touch screen.)

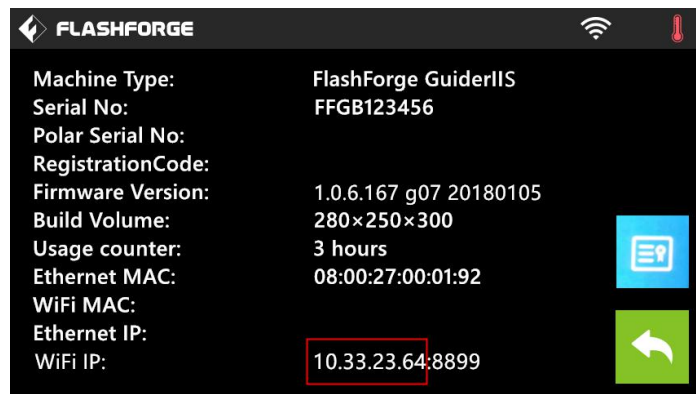

Chapter 8: Supports and Service

FlashForge team is on standby and ready to help you with any challenges you may have with your Guider IIS. If the issues or questions are not covered in this User Guide, you can seek for solutions on our official website or contact us via telephone.

There are solutions and instructions to common issues that can be found in our knowledge base. Have a look first as most basic questions are answered there.

<http://www.FlashForge.com>

The FlashForge support team can be reached by e-mail or phone between the working hours of 8:00 a.m. to 5:00 p.m. PST Monday through Saturday. In case you contact us during off-duty time, your inquiry will be answered the following business day.

Note: Because of changing different filament the extruder maybe blockaded. It's not owing to quality issue, and outside the scope of 400 hours life. If users encounter this problem, please contact our after-sale department and finish clean work according to their instruction.

Tel: [400-699-1063](tel:400-699-1063)

QQ: [2850862986](https://www.qq.com/number/2850862986) [2850863000](https://www.qq.com/number/2850863000) [2853382161](https://www.qq.com/number/2853382161)

Email: support@ff3dp.com

ADD: [No. 518, Xianyuan Road, Jinhua, Zhejiang](#)

When contacting support, please have your serial number ready. The serial number is a bar code on the back of your GuiderIIS.



Chapter 9: Basic Questions and Answers

Note! Do not disassemble the printer for maintenance on your own without authorization, or it may cause unnecessary loss! Please contact Flashforge after-sale engineers and use correct instruction and method to maintain.

9.1 Extruder shakes from left and right when printing.

Step 1. X-Axis motor cable has loose contact: Reconnect the X-Axis motor cable to check, if problem remains, replace with new X-Axis motor cable.

Step 2. If Step1 not solving, X-Axis driver board has problem: Replace with new X-Axis driver board.

9.2 “1025” extruder temperature showed on printer’s touch screen when heating or printing.

Step 1. Extruder thermocouple has loose contact or has problem: Reconnect the extruder thermocouple to check, if problem remains, replace with new extruder thermocouple.

9.3 Extruder temperature does not go up when preheating or loading filament.

Step 1. Heating pipe joint is disconnected with heating pipe: Reconnect these two parts back.

Step 2. If Step1 not solving, heating pipe joint is disconnected from the exchange board: Weld the heating pipe joint back if you are experienced in welding, or please replace with new exchange board.

9.4 Extruder is moving to the right side without stop when printing.

Step 1. X-Axis sensor wire has loose contact or has problem: Reconnect the X-Axis

sensor wire, if problem remains, replace with new X-Axis sensor wire.

Step 2. If Step1 not solving, trigger iron piece of the X-Axis sensor has dropped off or has problem: Replace with new X-Axis sensor.

9.5 Print result is ellipse when we set to print perfect roundness, and print result is rhombus when we set to print rectangle.

Step 1. X-Axis is not vertical to Y-Axis: Check the verticality between X-Axis and Y-Axis, adjust the X-Axis vertical to the Y-Axis.

9.6 Filament can not come out from extruder when printing the first layer and extruder is rubbing the platform.

Step 1. Distance between extruder and platform is too small: Re-do the build plate leveling according to **Chapter 5**.

9.7 Extruder is clogged, filament is jammed in the metal throat tube or teflon tube.

Step 1. Clear and unclog the extruder.

Referring operating video: FLASHFORGE GuiderIIS Unclogging Extruder

<https://www.youtube.com/watch?v=ePZgmtLxLZU&t=22s>

9.8(1) Extruder motor rotates normally but filament comes out from extruder not continuously(off and on).

(2)Extruder motor rotates normally but filament does not come out from extruder, and new filament can not be loaded into extruder or squeezed out.

1.Other brands filament is used in printer,inferior filament has impurities or bubbles inside: Please use Flashforge filament and make sure filament be stored at clean and

dry conditions.

2. Filament diameter is too large, causing filament jammed inside teflon tube: Make sure filament diameter is within 1.75 ± 0.1 mm. Replace with new filament if not fit.

3. Part of the filament is cracked inside the throat tube or teflon tube when plugging out the filament after print finished or change filament:

Disassemble the extruder, clear and unclog the whole parts including teflon tube, throat tube, extruder motor and nozzle.

4. False operation — directly insert the filament into extruder without cutting off the melted tip part when reload in filament: Clear out the jammed filament fragment by heating extruder and pushing the pin tool, replace the new filament, making sure filament tip is smooth, not deformed or twisted.

5. Teflon tube is totally out of shape or the nozzle is totally jammed, these parts can not be used any more: Replace with new teflon tube or new nozzle.

Referring operating video:

<https://www.youtube.com/watch?v=sPYaoRWAp2o&t=28s>

FlashForge-Guider IIS- Replacement of Nozzle and teflon Tube

9.9 Wave-like lines appear on the surface of models.

1. Apply some lubricate grease on the Z-Axis.

2. Z-Axis guide rods and Z-Axis bearings do not coordinate, or Z-Axis (motor axis) and the copper sleeve do not coordinate: Check these parts, disassemble and re-assemble these parts to check again, Replace corresponding problem parts with new parts.

3. Z-Axis driver board has problem: Replace the Z-Axis driver board with the normal X-Axis driver board or normal Y-Axis driver board (mind driver boards' directions), if the problem is solved, replace the new Z-Axis driver board, if the problem is not solved, replace the new Z-Axis motor.

9.10 (1) One of the axis motor is not working or rotating.

1. Check to see whether something is blocked or other problems in the direction of this moving axis: Clear out and fix these blocking problems.

2. Replace the malfunction motor's driver board with normal axis motor's driver board, if the problem is solved, replace the new axis driver board, if the problem is not solved, replace the new axis motor.

(2) Axis motor rotates only in one direction:

1. Refer to the steps in 9.10(1), but do not replace new axis motor.
2. Check the corresponding axis limit switch, plug out the joint of the limit switch.

9.11 Touch function on the touch screen does not work well.

Fastening screws behind the touch screen are too tightly screwed: Adjust the tightness of these fastening screws, if not solving, replace a new touch screen.

9.12 Files sliced by Flashprint and transferred by USB stick can not be identified by printer, or printer prompts: file is not matched.

1. Restart the printer and re-plug out and re-plug in the USB stick.
2. Check to see whether the correct printer type GuiderIIS is selected in Flashprint.
3. Check to see whether the model size has exceeded limit printing size of GuiderIIS in Flashprint.
4. USB stick has its own problems, copy the files to printer's internal memory and start print again, or use a new USB stick.

9.13 Print results shift along the direction of X-Axis.

1. X-Axis timing belt is loosened: Fasten the X-Axis timing belt.
2. X-Axis motor wire has loose contact or broken down: Reconnect the X-Axis motor wire, if not solving, replace the new motor wire.
3. X-Axis driver board is broken down(step1 and step2 is gradually shifting, step3 and step4 is whole-part shifting together with abnormal noise): Replace the new X-Axis driver board.
4. Printing speed is too fast: Lower the printing speed.(Recommended basic printing

speed:40—60mm/s, travel speed:60—80mm/s)

9.14 When doing build plate leveling, touch screen prompts “Please tighten knobs under the platform” when the knobs have already been mostly tightened: Re-do the printer’s extruder calibration and then do the build plate leveling again.

Referring operating video: Extruder calibration

<https://www.youtube.com/watch?v=VvjT3Y31IAw>

FCC STATEMENT :

This device complies with Part 15 of the FCC Rules. Operation is subject to the following two conditions:

(1) This device may not cause harmful interference, and (2) This device must accept any interference received, including interference that may cause undesired operation.

Warning: Changes or modifications not expressly approved by the party responsible for compliance could void the user's authority to operate the equipment.

NOTE: This equipment has been tested and found to comply with the limits for a Class B digital device, pursuant to Part 15 of the FCC Rules. These limits are designed to provide reasonable protection against harmful interference in a residential installation. This equipment generates uses and can radiate radio frequency energy and, if not installed and used in accordance with the instructions, may cause harmful interference to radio communications. However, there is no guarantee that interference will not occur in a particular installation. If this equipment does cause harmful interference to radio or television reception, which can be determined by turning the equipment off and on, the user is encouraged to try to correct the interference by one or more of the following measures:

- Reorient or relocate the receiving antenna.

- Increase the separation between the equipment and receiver.

- Connect the equipment into an outlet on a circuit different from that to which the receiver is connected.

- Consult the dealer or an experienced radio/TV technician for help.

FCC Radiation Exposure Statement:

This equipment complies with FCC radiation exposure limits set forth for an uncontrolled environment. This equipment should be installed and operated with minimum distance 20cm between the radiator & your body.