

Hisense

2.1 channel Soundbar with Built in subwoofer

Model: HS211

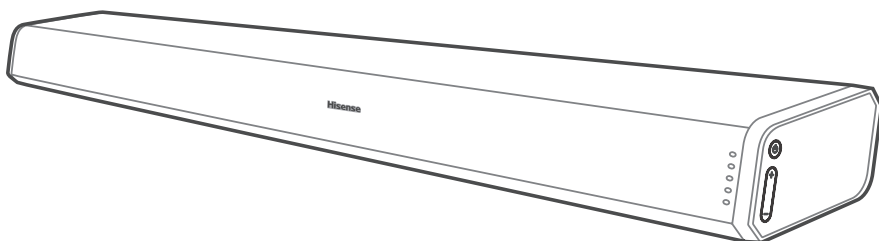

USER MANUAL



Before using the sound bar, please read this manual thoroughly and retain it for future reference.

Contents

Important Safety Instructions	3
Safety	3
Warning.....	4
What's in the Box	6
Identifying the Parts	7
Main Unit	7
Remote Control	8
Preparations	8
Prepare the Remote Control.....	8
Replace the Remote Control Battery	8
Placement and Mounting	9
Wall Mounting (option-B).....	9
Connections	10
Use the HDMI (ARC) Socket	10
Use the OPTICAL Socket	10
COAXIAL Socket	10
Use the AUX Socket	11
Connect Power	11
Basic Operation	12
Standby/ON.....	12
Select Modes.....	12
Adjust the Volume.....	12
Select a Preset Sound Effect	12
AUX / HDMI ARC / COAXIAL / OPTICAL Operation	12
USB Operation	13
Bluetooth Operation	13
Pair Bluetooth-enabled Devices.....	13
Listen to Music from Bluetooth Device	14
Troubleshooting	14
Specifications	15

Important Safety Instructions

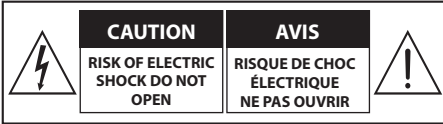



The lightning flash with arrowhead symbol, within an equilateral triangle, is intended to alert the user to the presence of uninsulated "dangerous voltage" within the product's enclosure that may be of sufficient magnitude as to constitute a risk of electric shock to persons.



The exclamation point within an equilateral triangle is intended to alert the user to the presence of important operating and maintenance (servicing) instructions in the literature accompanying the appliance.

Safety

- Read these instructions** – All the safety and operating instructions should be read before this product is operated.
- Keep these instructions** – The safety and operating instructions should be retained for future reference.
- Heed all warnings** – All warnings on the appliance and in the operating instructions should be adhered to.
- Follow all instructions** – All operating and usage instructions should be followed.
- Do not use this apparatus near water** – The appliance should not be used near water or moisture – for example, in a wet basement or near a swimming pool and the like.
- Clean only with a dry cloth.
- Do not block any ventilation openings. Install in accordance with the manufacturer's instructions.
- Do not install near any heat sources such as radiators, heaters, stoves, or other apparatus (including amplifiers) that produce heat.
- Do not defeat the safety purpose of the polarized or grounding plug. A polarized plug has two blades with one wider than the other. A grounding plug has two blades and a third grounding prong. The wide blade or the third prong is provided for your safety. If the provided plug does not fit into your outlet, consult an electrician for replacement of the obsolete outlet.
- Protect the power cord from being walked on or pinched particularly at plugs, convenience receptacles, and the point where they exit from the apparatus.
- Only use attachments/accessories specified by the manufacturer.
-  Use only with the cart, stand, tripod, bracket or table specified by the manufacturer, or sold with the apparatus. When a cart or rack is used, use caution when moving the cart/apparatus combination to avoid injury from tip-over.
- Unplug the apparatus during lightning storms or when unused for long periods of time.
- Refer all servicing to qualified personnel. Servicing is required when the apparatus has been damaged in any way, such as power supply cord or plug is damaged, liquid has been spilled or objects have fallen into the apparatus, the unit has been exposed to rain or moisture, does not operate normally, or has been dropped.
-  This equipment is a Class II or double insulated electrical appliance. It has been designed in such a way that it does not require a safety connection to electrical earth.
- The apparatus shall not be exposed to dripping or splashing. No objects filled with liquids, such as vases, shall be placed on the apparatus.
- Minimum distance around the apparatus for sufficient ventilation is 5cm.
- The ventilation should not be impeded by covering the ventilation openings with items, such as newspapers, table-cloths, curtains, etc...
- No naked flame sources, such as lighted candles, should be placed on the apparatus.
- Batteries should be recycled or disposed of as per state and local guidelines.
- The use of apparatus in moderate or tropical climates.

Caution:

- Use of controls or adjustments or performance of procedures other than those described herein, may result in hazardous radiation exposure or other unsafe operation.
- To reduce the risk of fire or electric shock, do not expose this apparatus to rain or moisture. The apparatus must not be exposed to dripping or splashing and objects filled with liquids, such as vases, must not be placed on apparatus.
- The mains plug/appliance coupler is used as the disconnect device, the disconnect device must remain readily operable.
- Danger of explosion if battery is incorrectly replaced. Replace only with the same or equivalent type.

Warning

- The battery (batteries or battery pack) shall not be exposed to excessive heat such as sunshine, fire or the like.
- Before operating this system, check the voltage of this system to see if it is identical to the voltage of your local power supply.
- Do not place this unit close to strong magnetic fields.
- Do not place this unit on the amplifier or receiver.
- Do not place this unit close to damp areas as the moisture will affect the life of the laser head.
- If any solid object or liquid falls into the system, unplug the system and have it checked by qualified personnel before operating it any further.
- Do not attempt to clean the unit with chemical solvents as this may damage the finish. Use a clean, dry or slightly damp cloth.
- When removing the power plug from the wall outlet, always pull directly on the plug, never yank on the cord.
- Changes or modifications to this unit not expressly approved by the party responsible for compliance will void the user's authority to operate the equipment.
- The rating label is pasted on the bottom or back of the equipment.

This equipment complies with FCC radiation exposure limits set forth for an uncontrolled environment. This equipment should be installed and operated with minimum distance 20cm between the radiator & your body.

DO NOT INGEST BATTERY, CHEMICAL BURN HAZARD

The remote control supplied with this product contains a coin/button cell battery. If the coin/button cell battery is swallowed, it can cause severe internal burns in just 2 hours and lead to death. Keep new and used batteries away from children. If the battery compartment does not close securely, stop using the product and keep it away from children. If you think batteries might have been swallowed or placed inside any part of the body, seek immediate medical attention.



Correct Disposal of this product. This marking indicates that this product should not be disposed with other household wastes throughout the EU.

To prevent possible harm to the environment or human health from uncontrolled waste disposal, recycle it responsibly to promote the sustainable reuse of material resources. To return your used device, please use the return and collection systems or contact the retailer where the product was purchased. They can take this product for environmental safe recycling.



We hereby declares that this product is in compliance with the essential requirements and other relevant provisions of Directive 2014/53/EU.



The Bluetooth® word mark and logos are registered trademarks owned by Bluetooth SIG, Inc. We are the licensee to use such marks. Other trademarks and trade names are those of their respective owners.



Manufactured under license from Dolby Laboratories. Dolby and the double-D symbol are trademarks of Dolby Laboratories.

For U.S. models

FCC Information

Warning:

Changes or modifications to this unit not expressly approved by the party responsible for compliance could void the user's authority to operate the equipment."

NOTE:

- This equipment has been tested and found to comply with the limits for a Class B digital device, pursuant to Part 15 of the FCC Rules. These limits are designed to provide reasonable protection against harmful interference in a residential installation. This equipment generates, uses and can radiate radio frequency energy and, if not installed and used in accordance with the instructions, may cause harmful interference to radio communications.
- However, there is no guarantee that interference will not occur in a particular installation. If this equipment does cause harmful interference to radio or television reception, which can be determined by turning the equipment off and on, the user is encouraged to try to correct the interference by one or more of the following measures:
 - Reorient or relocate the receiving antenna.
 - Increase the separation between the equipment and receiver.
 - Connect the equipment into an outlet on a circuit different from that to which the receiver is connected.
 - Consult the dealer or an experienced radio / TV technician for help.
- This device complies with Part 15 of the FCC Rules. Operation is subject to the following two conditions:
 - (1) this device may not cause harmful interference, and
 - (2) this device must accept any interference received, including interference that may cause undesired operation.
- Shielded cables must be used with this unit to ensure compliance with the Class B FCC limits.

IC Notice:

This device complies with Canada Industry licence-exempt RSS standard(s). Operation is subject to the following two conditions: (1) this device may not cause interference. and (2) this device must accept any interference. Including interference that may cause undesired operation of the device.

CAN ICES-3 (B) / NMB-3 (B)

Avis d'Industrie Canada

Le présent appareil est conforme aux CNR d'industrie Canada applicables aux appareils radio exem pts de licence L'exploitation est autorisée aux deux conditions suivantes:

(1) l'appareil ne doit pas produire de brouillage, et (2) l'utilisateur de l'appareil doit accepter brouillage radioélectrique subi même si le brouillage est susceptible d'encompromettre le fonctionnement. mauvais fonctionnement de l'appareil.

What's in the Box

EN



Main Unit



Remote Control

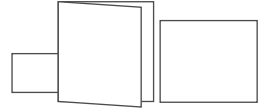

User Manual
Quick Start Guide
Pattern Paper

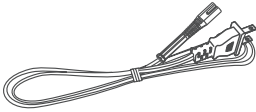

AC Power Cord

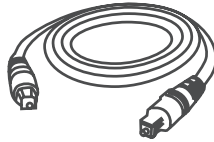

Optical Cable

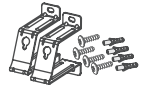

Wall Bracket
EVA Sponge

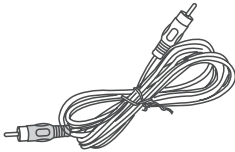

Coaxial Cable

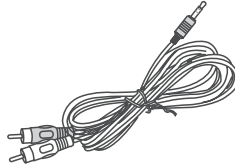

RCA to 3.5mm audio Cable



3.5mm to 3.5mm audio Cable

Identifying the Parts

Main Unit

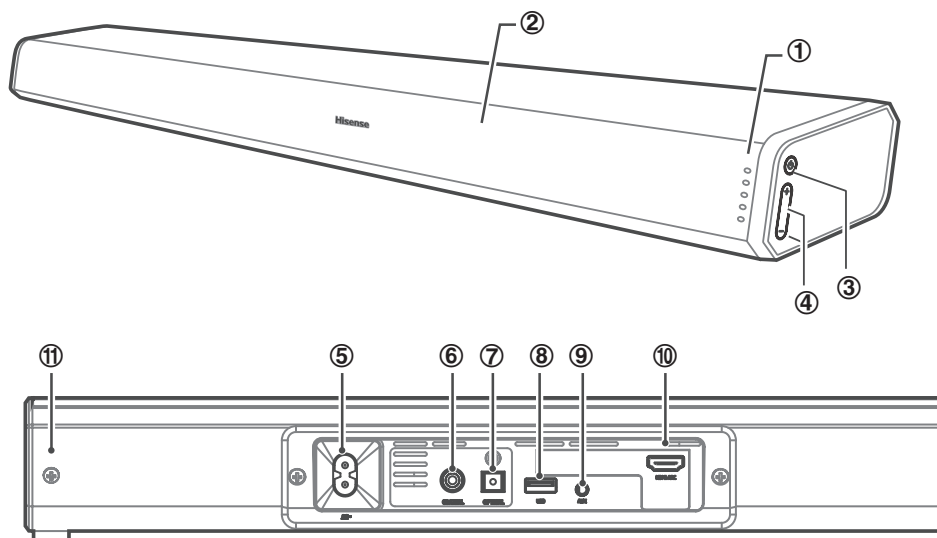

- ① **LED Indicators**
 - Red: In STANDBY mode.
 - Green: In AUX mode.
 - Blue: In Bluetooth mode.
 - Orange/flash: In Optical/Coaxial mode.
 - White/flash: In HDMI ARC/USB mode.
- ② **Remote Control Sensor**
- ③ **⏻ button**

Press to switch the unit on, press and hold to switch the unit standby
Repeatedly press to select the play function.
- ④ **+/- buttons**

Increase/decrease the volume level.
- ⑤ **AC~ Socket**

Connect a power cord.
- ⑥ **COAXIAL Socket**

Digital audio connection.
- ⑦ **OPTICAL Socket**







Digital audio connection.
- ⑧ **USB Socket**

Insert the USB device.
- ⑨ **AUX Socket**

Connect to an external audio device.
- ⑩ **HDMI ARC Socket**

Connect to a TV via HDMI cable.
- ⑪ **Wall bracket screws**

Remote Control

- ①  (ON/OFF) Switch the unit between ON and STANDBY mode.
- ② **VOL+ /VOL-** Increase/decrease the volume level.
- ③  (SOURCE) Select the play function.
- ④  (Bluetooth) Select the Bluetooth mode.
- ⑤ **HDMI ARC** Select the HDMI ARC mode.
- ⑥  (MUTE) Mute or resume the sound.
- ⑦  Skip to previous/next track in Bluetooth/USB mode.
- ⑧  **PAIR** Play/pause/resume playback in Bluetooth/USB mode. Press and hold to activate the pairing function in Bluetooth mode or disconnect the existing paired Bluetooth device.

⑨ **MOVIE / NEWS / MUSIC** Select a preset sound effect.

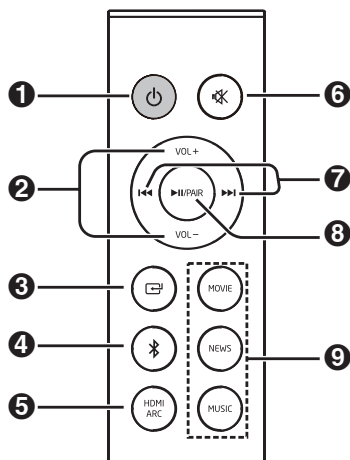

Preparations

Prepare the Remote Control

The provided Remote Control allows the unit to be operated from a distance.

- Even if the Remote Control is operated within the effective range 19.7 feet (6m), remote control operation may be impossible if there are any obstacles between the unit and the remote control.
- If the Remote Control is operated near other products which generate infrared rays, or if other remote control devices using infra-red rays are used near the unit, it may operate incorrectly. Conversely, the other products may operate incorrectly.

First-time use:

The unit has a pre-installed lithium CR2025 battery. Remove the protective tab to activate the remote control battery.

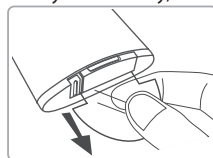

Replace the Remote Control Battery

- The remote control requires a CR2025, 3V Lithium battery.
1. Push the tab on the side of the battery tray towards the tray.
 2. Now slide the battery tray out of the remote control.
 3. Remove the old battery. Place a new CR2025 battery into the battery tray with the correct polarity (+/-) as indicated.
 4. Slide the battery tray back into the slot in the remote control.

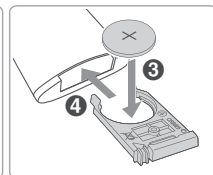
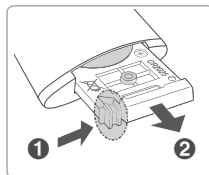

Precautions Concerning Batteries

- When the Remote Control is not to be used for a long time (more than a month), remove the battery from the Remote Control to prevent it from leaking.
- If the batteries leak, wipe away the leakage inside the battery compartment and replace the batteries with new ones.
- Do not use any batteries other than those specified.
- Do not heat or disassemble batteries.
- Never throw them in fire or water.
- Do not carry or store batteries with other metallic objects. Doing so could cause batteries to short circuit, leak or explode.
- Never recharge a battery unless it is confirmed to be a rechargeable type.

Placement and Mounting

Normal Placement (place Soundbar on leveled surface in front of TV)

Option - A



Option - B

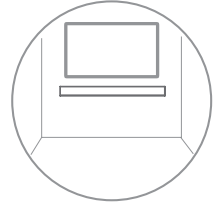

EN

Wall Mounting (option-B)

Note:

- Installation must be carried out by qualified personnel only. Incorrect assembly can result in severe personal injury and property damage (if you intend to install this product yourself, you must check for installations such as electrical wiring and plumbing that may be buried inside the wall). It is the installer's responsibility to verify that the wall will safely support the total load of the unit and wall brackets.
- Additional tools (not included) are required for the installation.
- Do not overtighten screws.
- Keep this instruction manual for future reference.
- Use an electronic stud finder to check the wall type before drilling and mounting.

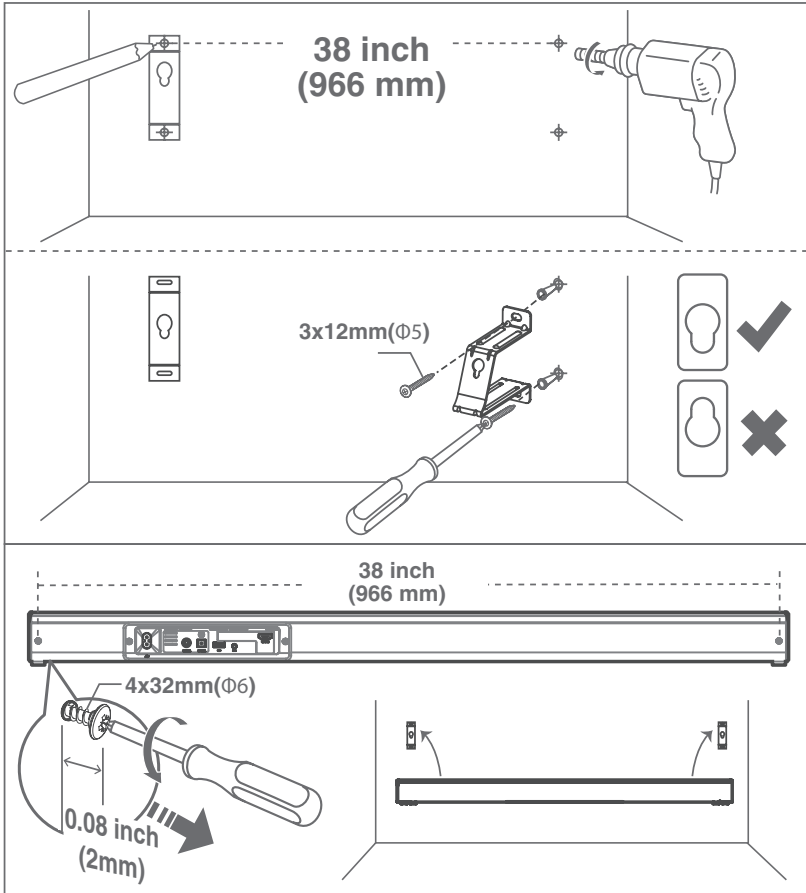

Connections

Use the HDMI (ARC) Socket

ARC (Audio Return Channel):

- With the ARC (Audio Return Channel) function, it allows you to send audio input from your ARC-compliant TV to ARC-compliant audio devices (e.g. soundbar) without the need to connect an audio cable.

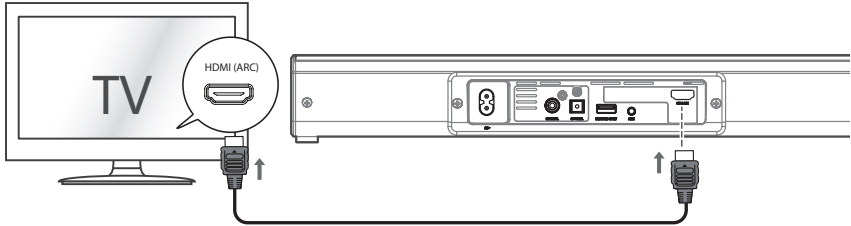

- To enjoy the ARC function, make sure main unit the HDMI (ARC) socket is connected by an **HDMI** cable (not included) to the HDMI (ARC) socket of your ARC-compliant TV. Then, just use your TV remote control to adjust the volume output (VOL +/- and MUTE) of the connected audio device.

NOTE

- Your TV must support the HDMI-CEC and ARC and the HDMI-CEC and ARC must be set to On.
- The setting method of HDMI-CEC and ARC may differ depending on the TV. For details about ARC function, please refer to the owner's manual.
- Ensure that you use an HDMI cables that can support the ARC function.
- HDMI-CEC will be called different names by different manufacturers – please refer to your owner's manual for details on setting up HDMI-CEC and ARC.

Use the OPTICAL Socket

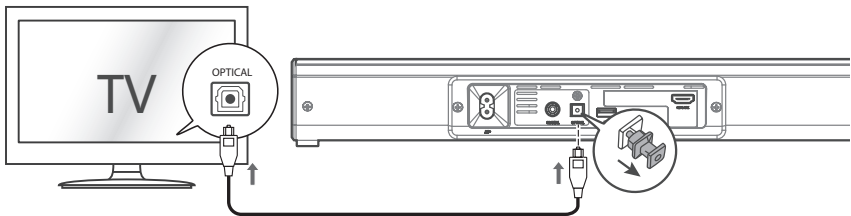

- Remove the protective cap of the OPTICAL socket, then connect an OPTICAL cable (included) to the TV's OPTICAL OUT socket and the OPTICAL socket on the unit.

COAXIAL Socket

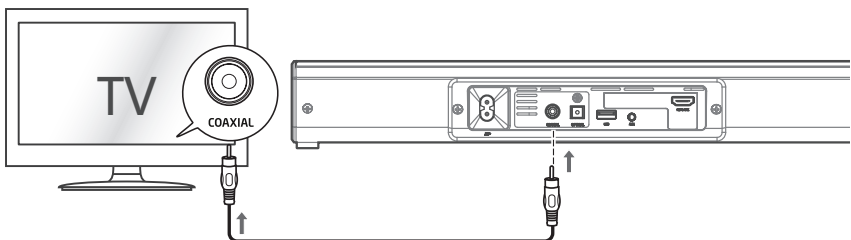

- You also can use the COAXIAL cable (included) to connect the TV's COAXIAL OUT socket and COAXIAL socket on the unit.

Tip: While in **HDMI ARC, COAXIAL, OPTICAL** mode, if there's no sound output from the unit and the status indicator flashes quickly, you may need to activate **PCM** or **Dolby Digital** Signal output on your source device (eg. TV, DVD or Blu-ray player).

Use the AUX Socket

- A. Use a RCA to 3.5mm audio cable (included) to connect the TV's audio output sockets to the **AUX** socket on the unit.

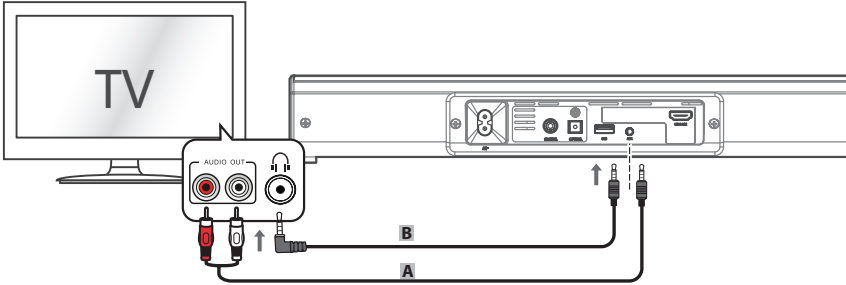

- B. Use a 3.5mm to 3.5mm audio cable (included) to connect the TV's or external audio device headphone socket to the **AUX** socket on the unit.

Connect Power

Risk of product damage!

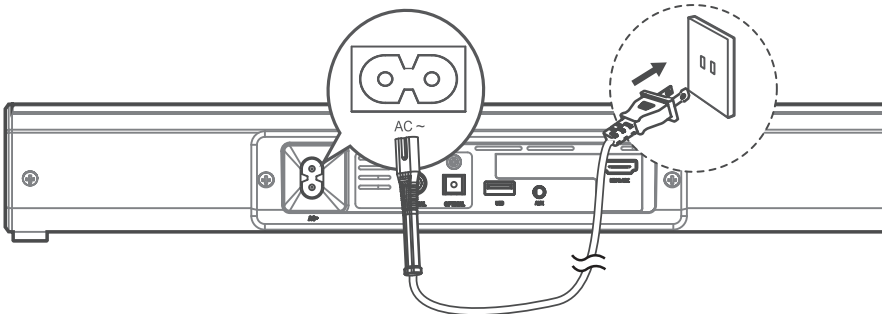

- Ensure that the power supply voltage corresponds to the voltage printed on the back or the underside of the unit.
- Before connecting the AC power cord, ensure you have completed all other connections.
- Connect the mains cable to the **AC~** Socket of main unit and then into a mains socket.



Basic Operation

Standby/ON

When you first connect the main unit to the mains socket, the main unit will be in Standby mode.

- Press the  button on the unit or on the remote control to switch the unit ON.
- Press and hold the  button on the unit or press  button on the remote control again to switch the unit back to STANDBY mode. The POWER indicator will light up red.
- Disconnect the mains plug from the mains socket if you want to switch the unit OFF completely.
- If the unit is idle for over 15 minutes, the unit will automatically switch to Standby mode.

Select Modes

Press the  button on the unit repeatedly or or the , , **HDMI ARC** buttons on the remote control to select the **AUX**, **OPTICAL**, **COAXIAL**, **HDMI ARC**, **USB** and **BT** (Bluetooth) mode.

- Red: In STANDBY mode.
- Green: In AUX mode.
- Blue: In Bluetooth mode.
- Orange/Orange flash: In Optical/Coaxial mode.
- White/White flash: In HDMI ARC/USB mode.



Adjust the Volume

- Press the **VOL+** / **VOL-** buttons on the unit or on the remote control to adjust the volume.
- If you wish to turn the sound off, press the  (**MUTE**) button on the remote control. Press the MUTE button again or press the **VOL+** / **VOL-** buttons on the unit or on the remote control to resume normal listening.
- While adjusting the volume, the status indicator flashes quickly.
- While the volume level reaches its maximum level, if you press the **VOL+** button again, the status indicator flashes once. While the volume level reaches its minimum level, if you press the **VOL-** button again, the status indicator flashes once.

Select a Preset Sound Effect





While playing, press the **NEWS** or **MOVIE** or **MUSIC** buttons on the remote control to select between preset equalizers: **Movie** (recommended for viewing movies), **Music** (recommended for listening to music), **NEWS** (recommended for listening to NEWS).

AUX / HDMI ARC / COAXIAL / OPTICAL Operation

- 1 Ensure that the unit is connected to the TV or audio device.
- 2 Press the  button on the unit repeatedly or the  / **HDMI ARC** buttons on the remote control to select the **HDMI ARC**, **COAXIAL**, **OPTICAL**, **AUX** mode.
- 3 Operate your audio device directly for playback features.
- 4 Press the **VOL +/-** button to adjust the volume to your desired level.

Tip: While in **HDMI ARC**, **COAXIAL**, **OPTICAL** mode, if there's no sound output from the unit and the status indicator flashes quickly, you may need to activate **PCM** or **Dolby Digital** Signal output on your source device (eg. TV, DVD or Blu-ray player).

USB Operation

- 1 Insert the USB device.
 - 2 Press the  button on the unit repeatedly or the  button on the remote control to select **USB** mode.
 - 3 Play starts automatically. If play does not start automatically, press  **PAIR** button.
- To skip to the previous/next track, press the   buttons on the remote control.

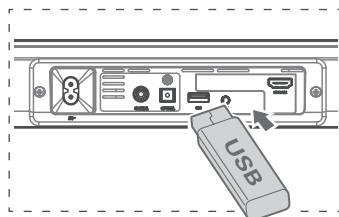

EN

Bluetooth Operation



Pair Bluetooth-enabled Devices

The first time you connect your bluetooth device to this player, you need to pair your device to this player.

Note:

- The operational range between this player and a Bluetooth device is approximately 8 meters (without any object between the Bluetooth device and the unit).
- Before you connect a Bluetooth device to this unit, ensure you know the device's capabilities.
- Compatibility with all Bluetooth devices is not guaranteed.
- Any obstacle between this unit and a Bluetooth device can reduce the operational range.
- If the signal strength is weak, your Bluetooth receiver may disconnect, but it will re-enter pairing mode automatically.

To connect your device to the unit via Bluetooth, follow the steps below:

- 1 During ON mode, press the  button on the unit repeatedly or the  button on the remote control to select Bluetooth mode. The **Bluetooth** indicator will light flash.
- 2 Activate your Bluetooth device and select the search mode. "HS211" will appear on your Bluetooth device list.
- If you cannot find the unit, press and hold the  **PAIR** button on the remote control to be searchable. The system has entered pairing mode. You will hear "Pairing" from the unit and the **Bluetooth** indicator will flash fast.
- 3 Select "HS211" in the pairing list. After the "Paired" voice prompt, the system is successfully connected and the **Bluetooth** indicator will light up solidly.
- 4 Play music from the connected Bluetooth device.

To disconnect the Bluetooth function, you can :

- Switch to another function on the unit.
- Disable the function from your Bluetooth device. The Bluetooth device will be disconnected from the soundbar after the "Disconnected" voice prompt.
- Press and hold the  **PAIR** button on the remote control.

Tips:

- Enter "0000" for the password if necessary.
- If no other Bluetooth device pairs with this player within two minutes, the player will recover its previous connection.
- The player will also be disconnected when your device is moved beyond the operational range.
- If you want to reconnect your device to this player, place it within the operational range.
- If the device is moved beyond the operational range, when it is brought back, please check if the device is still connected to the player.
- If the connection is lost, follow the instructions above to pair your device to the player again.

Listen to Music from Bluetooth Device

- If the connected Bluetooth device supports Advanced Audio Distribution Profile (A2DP), you can listen to the music stored on the device through the player.
- If the device also supports Audio Video Remote Control Profile (AVRCP), you can use the player's remote control to play music stored on the device.
 1. Pair your device with the player.
 2. Play music via your device (if it supports A2DP).
 3. Use supplied remote control to control play (if it supports AVRCP).
 - To pause/resume play, press the ►||/PAIR button on the remote control.
 - To skip to a track, press the ◀◀,▶▶ buttons on the remote control.

Troubleshooting

To keep the warranty valid, never try to repair the system yourself. If you encounter problems when using this unit, check the following points before requesting service.

No power

- Ensure that the AC cord of the apparatus is properly connected .
- Ensure that there is power at the AC outlet.
- Press standby button to turn the unit on.

Remote control does not work

- Before you press any playback control button, first select the correct source.
- Reduce the distance between the remote control and the unit.
- Insert the battery with its polarities (+/-) aligned as indicated.
- Replace the battery.
- Aim the remote control directly at the sensor on the front of the unit.

I can't find the Bluetooth name of this unit on my Bluetooth device for Bluetooth pairing

- Ensure the Bluetooth function is activated on your Bluetooth device.
- Ensure you have paired the unit with your Bluetooth device.

This is a 15 mins power off function, one of the ERPII standard requirement for saving power

- When the unit's external input signal level is too low, the unit will be turned off automatically in 15 minutes. Please increase the volume level of your external device.

Specifications

Model Name	HS211
-------------------	-------

General	
Bar Power Supply	AC100-240V~ 50/60Hz
USB	5V/0.5A
Main Unit Dimension (WxHxD)	1000 x 60 x 113 mm (39.3 x 2.3 x 4.4 inch)
Net weight	3.3 lbs (1.5kg)
Audio input sensitivity	500mV
Frequency Response	40Hz - 20KHz

Amplifier (RMS Outputpower)	
Total	60W
Main Unit	15 W x 2 + 30W (4 Ω x 2 + 8 Ω) at 1 KHz, 10%THD

Bluetooth	
Version	V 3.0
Maximum power transmitted	<20 dbm
Frequency bands	2402 MHz ~ 2480 MHz

Remote Control	
Distance/Angle	19.7 feet (6m) / 30°
Battery type	CR 2025

- Design and specifications are subject to change without notice.

Hisense

HS211

Model: 2.1 channel Soundbar with Built in subwoofer