

TY-WSP120

Toshiba Wireless Speaker Operation Manual

5016200

Thank you for purchasing this Portable Sound System.
To use this product safely, read and understand this operation manual thoroughly before using.
After reading this manual, keep it in a safe place so that it can be referred to when necessary.



Safety precautions

The information you need to prevent danger to the user and other people as well as property damage is described below. "Description of signs" shows different levels of danger or damage that may occur due to wrong handling.

Important notes

- This book is only a guide for user's operation, not a criterion for configuration.
- Only use attachments/accessories specified by the manufacturer.

	The lightning flash is intended to alert the user to the presence of dangerous voltage within the product's enclosure, and touching the internal components may result in a risk of electric shock to persons.
	The exclamation mark is intended to alert the user to the presence of important operating instructions.
	To reduce the risk of electric shock or fire, do not open the cover. Refer servicing to qualified service personnel.

Description of signs

WARNING Indicates that there is a risk of death or serious injury. **CAUTION** Indicates that there is a risk of minor injury or property damage.

What to do in the case of an abnormality

WARNING Stop using the device immediately in the case of an abnormality or failure.
Remove the power plug from the receptacle immediately when water or any foreign object enters the interior of the device.
It may cause a fire or electric shock. Remove the power plug immediately, and contact your dealer for a repair.

Power cord and power plug

WARNING To reduce the risk of fire, electric shock or product damage,
Do not disassemble, repair, or modify the device.
Do not insert any foreign object into the device.
In case of lightning, do not touch the power cord.
If the mains plug or an appliance coupler is used as a disconnecting device, the disconnecting device shall remain readily operable.
Do not insert or remove the power plug with a wet hand.
Observe the following when handling the power cord.
Do not damage it.
Do not pull it.
Do not bend it forcefully.
Do not modify it (e.g. extension).
Do not pinch it.
Do not heat it.
Do not twist it.
Do not bundle it.

CAUTION If the device will not be used for a long time, remove the power plug from the receptacle.
Do not use any power cord other than the one that comes with the device.
Do not use the power cord that comes with the device for any other product.

Usage

WARNING To reduce the risk of fire, electric shock or product damage,
Do not disassemble, repair, or modify the device.
Do not insert any foreign object into the device.
In case of lightning, do not touch the power cord.

CAUTION Before carrying the device, remove the power plug from the receptacle.
Do not place a heavy object on the device.
To prevent possible hearing damage, do not listen at high volume levels for long periods.

Installation

WARNING To reduce the risk of fire, electric shock or product damage,
Place the unit on a flat surface away from sources of direct sunlight or excessive heat.
Do not install the device in a confined or build-in space such as a book case or similar area, and keep it under a well-ventilated condition. The ventilation should not be impeded by covering the ventilation openings with items such as newspaper, table-cloths, curtains, etc.
Do not expose the device to rain, moisture, dripping, or splashing.
Do not place objects filled with liquids, such as vases, on the device.

Note If any color shift occurs on a nearby TV or the radio of the device picks up noise from the TV, keep the device away from the TV.

Important Safety Instructions

- Read these instructions - All the safety and operating instructions should be read before this product is operated.
- Keep these instructions - The safety and operating instructions should be retained for future reference.
- Heed all warnings - All warnings on the appliance and in the operating instructions should be adhered to.
- Follow all instructions - All operating and use instructions should be followed.
- Do not use this apparatus near water - The appliance should not be used near water or moisture - for example, in a wet basement or near a swimming pool and the like.
- Clean only with a dry cloth.
- Do not block any ventilation openings. Install in accordance with the manufacturer's instructions.
- Do not install near any heat sources such as radiators, heaters, stoves, or other apparatus (including amplifiers) that produce heat.
- Do not defeat the safety purpose of the polarized or grounding-type plug. A polarized plug has two blades with one wider than the other. A grounding type plug has two blades and a third grounding prong. The wide blade or the third prong is provided for your safety. If the provided plug does not fit into your outlet, consult an electrician for replacement of the obsolete outlet.
- Protect the power cord from being walked on or pinched, particularly at plugs, convenience receptacles and at the point where they exit from the apparatus.
- Only use attachments/accessories specified by the manufacturer.
- Use only with the cart, stand, tripod, bracket, or table specified by the manufacturer, or sold with the apparatus. When a cart or rack is used, use caution when moving the cart/apparatus combination to avoid injury from tip-over.
- Unplug the apparatus during lightning storms or when unused for long periods of time.
- Refer all servicing to qualified personnel. Servicing is required when the apparatus has been damaged in any way, such as power supply cord or plug is damaged, liquid has been spilled or objects have fallen into the apparatus, the unit has been exposed to rain or moisture, does not operate normally, or has been dropped.
- This equipment is a Class II or double insulated electrical appliance. It has been designed in such a way that it does not require a safety connection to electrical earth.

- The apparatus shall not be exposed to dripping or splashing. No objects filled with liquids, such as vases, shall be placed on the apparatus.
- Minimum distance around the apparatus for sufficient ventilation is 5cm.
- The ventilation should not be impeded by covering the ventilation openings with items, such as newspapers, table-cloths, curtains, etc...
- No naked flame sources, such as lighted candles, should be placed on the apparatus.

FCC Statement :
This device complies with Part 15 of the FCC Rules. Operation is subject to the following two conditions:
1) This device may not cause harmful interference, and 2) This device must accept any interference received, including interference that may cause undesired operation.
Note: This equipment has been tested and found to comply with the limits for a Class B digital device, pursuant to part 15 of the FCC Rules. These limits are designed to provide reasonable protection against harmful interference in a residential installation. This equipment generates, uses, and can radiate radio frequency energy and, if not installed and used in accordance with the instructions, may cause harmful interference to radio communication. However, there is no guarantee that interference will not occur in a particular installation. If this equipment does cause harmful interference to radio or television reception, which can be determined by turning the equipment off and on, the user is encouraged to try to correct the interference by one or more of the following measures:
• Reorient or relocate the receiving antenna.
• Increase the separation between the equipment and receiver.
• Connect the equipment into an outlet on a circuit different from that to which the receiver is connected.
• Consult the dealer or an experienced radio/TV technician for help.
Caution: Changes or modifications not expressly approved by the party responsible for compliance could void the user's authority to operate the equipment.

California Prop 65 Warning :
WARNING This product contains chemicals, including lead, known to the State of California to cause cancer and birth defects or other reproductive harm. *Wash hands after handling.*

Disclaimer
• Toshiba shall not be responsible for any damage caused by an earthquake, thunderstorm, flood damage, fire for which Toshiba is not responsible, acts of a third party, other accidents, or damages caused by the user's willful acts or negligence, misuse, or use in abnormal conditions.
• Toshiba shall not be responsible for any damage caused by failure to observe the information described in the operation manual.

Disposal
• When disposing of the device, observe the laws, or ordinances and rules of the local government.

About using Bluetooth®

This unit is designed for use with Bluetooth® wireless devices compatible with the A2DP and AVRCP streaming audio profiles. Refer to your Bluetooth® device's user manual or technical support to determine if your Bluetooth® device supports these profiles.

Frequency band used
This unit uses the 2.4 GHz frequency band. However other wireless devices may use 2.4 GHz frequency band as well and may cause interference with each other. To avoid interference, please refrain from the use of the unit at the same time with other wireless devices.

Certification of this device
This unit conforms to frequency restrictions and has received certification based on frequency laws, so a wireless permit is not necessary. However, the following action is punishable by law in some countries:
• Taking apart/modifying the unit.

Usage restrictions
• Wireless transmission and/or use with all Bluetooth® equipped devices is not guaranteed.
• A device featuring the Bluetooth® function is required to conform to the Bluetooth® standard specified by Bluetooth SIG, and be authenticated. Even if the connected device conforms to the above mentioned Bluetooth® standard, some devices may not be connected or work correctly, depending on the features or specifications of the device.

Range of use
Use this device within an unobstructed 8 m range. The range of use or perimeter may be shortened depending on any obstructions, devices causing interference, other people in the room, or the construction of the building. Please note that the range mentioned above is not guaranteed.

The Bluetooth® word mark and logos are owned by the Bluetooth SIG, Inc. and are used under license.

Part names

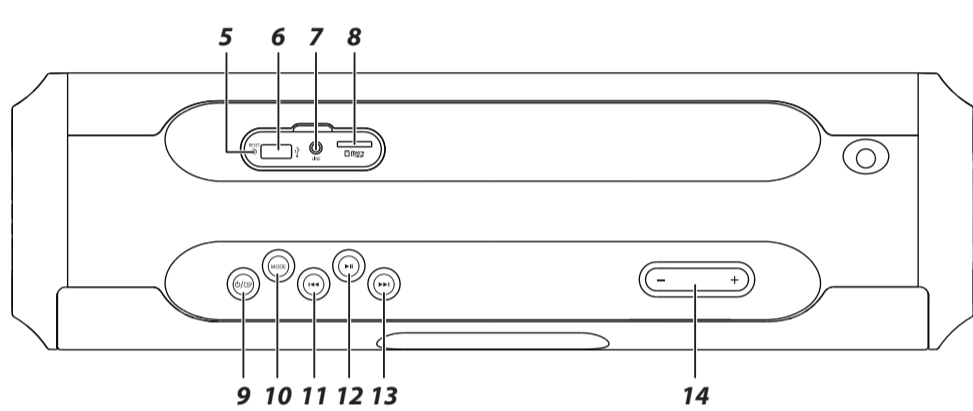
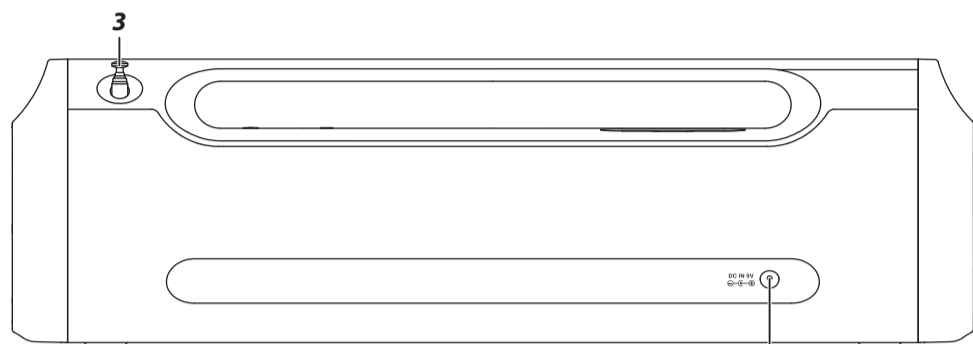
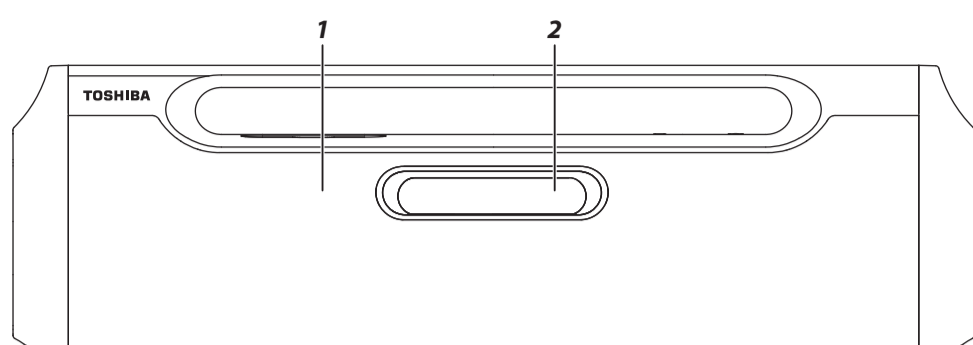

- | | |
|-------------------|-------------------------|
| 1 SPEAKER | 8 Micro SD card slot |
| 2 DISPLAY | 9 button |
| 3 FM ANTENNA | 10 MODE button |
| 4 AC POWER SOCKET | 11 (UP/+PRESET) button |
| 5 RESET button | 12 (UP/+PRESET) button |
| 6 USB port | 13 (UP/+PRESET) button |
| 7 LINE jack | 14 |

Charging the battery

When you use this unit for the first time or have not used it for a long period of time, charge the battery fully.

Caution
• Risk of product damage! Ensure that the power supply voltage corresponds to the voltage printed on the back or the underside of the unit.
• When the battery power is low, the icon flashes quickly on the display of the unit. Charge the battery.

- Connect the AC adapter to an AC POWER outlet.
- Connect the DC plug of the AC adapter to the AC power socket.

Note
• When there is no input signal (except fo FM mode) for over 30 minutes, the unit will automatically enter standby mode.

Basic functions

Turning the unit on
1 Press the button to turn the unit on.

Turning the unit off
1 Press and hold the button to turn the unit off.

Note
• When there is no input signal (except fo FM mode) for over 30 minutes, the unit will automatically enter standby mode.

Setting the function mode
1 To change the function mode, press the FUNC button on the unit to select the USB/CARD/AUX/ BT(Bluetooth®)/FM function.
The selected mode will show on the display.

Adjusting the volume
1 Press the + or - button to increase or decrease the music volume.

Setting the clock
1 Press the MODE button to display the selection menu.
2 Press or button repeatedly to select "CLK --:--", then press the button to confirm. The hour indicator will flash.
3 Press or button repeatedly to adjust the hour, then press the button to confirm. The minute indicator will flash.
4 Press or button repeatedly to adjust the minute, then press the button to confirm. The unit enter the CLOCK SYNC mode.
5 Press or button to select the CLOCK SYNC mode, then press the button to confirm.
RDS: Only synchronizes with the RDS radio station.
OFF: Turns off the clock synchronization function. Adjust the clock manually.

Note
• Press the MODE button to exit the menu.
• If there is no operation for 20 seconds, the unit will exit the menu automatically.

Setting the sleep timer
Use the sleep timer to turn the system off after a certain number of minutes in play mode.
1 Press the MODE button to display the selection menu.
2 Press or button repeatedly to select "SLEEP", then press the button to confirm.
3 Press or button repeatedly to select the number of minutes (90/60/30/15/00), then press the button to confirm. The minute indicator will flash.

Note
• Press the MODE button to exit the menu.
• If there is no operation for 20 seconds, the unit will exit the menu automatically.

Adjusting the brightness of display panel
1 Press the MODE button to display the selection menu.
2 Press or button repeatedly to select "DIMMER", then press the button to confirm. The hour indicator will flash.
3 Press or button repeatedly to select the level of brightness, then press the button to confirm.

Note
• Press the MODE button to exit the menu.
• If there is no operation for 20 seconds, the unit will exit the menu automatically.

Selecting a preset sound effect
1 Press the MODE button to display the selection menu.
2 Press or button repeatedly to select "EQ", then press the button to confirm.
3 Press or button repeatedly to select the sound effect (FLAT, POP, JAZZ, ROCK, CLASSIC), then press the button to confirm.

Note
• Press the MODE button to exit the menu.
• If there is no operation for 20 seconds, the unit will exit the menu automatically.

Turning the bass on/off
1 Press the MODE button to display the selection menu.
2 Press or button repeatedly to select "BASS", then press the button to confirm.
3 Press or button to turn the bass on or off, then press the button to confirm.

Note
• Press the MODE button to exit the menu.
• If there is no operation for 20 seconds, the unit will exit the menu automatically.

USB/SD operation

Listening to a USB device/micro SD card
This unit provides a USB port for music playback.
1 Press the FUNC button on the unit to select USB A/USB B/SD mode.
2 USB: Connect a USB memory stick to the USB port.
SD: Insert a micro SD memory card into the micro SD card slot.
The display will show the total number of playable tracks on the USB device/micro SD card.
To skip to the previous or next album, press the or button while the playback is stopped.

3 To start playback, press the button.
To pause/resume playback, press the button.
4 To select a desired track, press the or button while playing.
The unit will start playing automatically.
5 To search for a particular passage during playback, press and hold the or button to fast forward and fast backward until the desired point (passage) is reached, then release the button for normal playback.
Playback will start again from this point.

Repeat/Random replay
1 Press the MODE button to display the selection menu.
2 Press or button repeatedly to select "PLAY MOD", then press the button to confirm.
3 Press or button repeatedly to select repeat play mode, then press the button to confirm.
: Play all tracks repeatedly.
: Play the current track repeatedly.
 (flash): Repeat the tracks in the folder (if folder is displayed).
: Shuffle play all tracks.

Caution
• To prevent harmful interference, always connect USB devices/SD card directly to the unit. Do not use a USB/SD card extension cable to connect USB devices/SD card to the unit.

Bluetooth® operation

■ Pairing :

- 1 Press the  button repeatedly to select "BT(blueooth®)" mode.
The display will show "NO BT".
- 2 Following the instructions in your device's user manual, activate Bluetooth® on your device and search for the unit "TY-WSP120" and connect. Input the password "0000" if required.
The display will show "BT".
- 3 Play music from the connected Bluetooth device.

Notes

• Bluetooth® works best within 8 meters.

To disconnect the device

- Switch to another function.
- Press and hold the  button.

■ Listening to the music from a Bluetooth device:

If the device also supports Audio Video Remote Control Profile (AVRCP) , you can use the player's buttons to play music stored on the device.





- 1 Pair your device with the player.
- 2 Press the  button on the unit to start playback.
To pause/resume playback, press the  button.
- 3 To select a desired track, press the  or  buttons while playing.

LINE operation





- 1 Connect your audio device to the LINE jack with a 3.5mm audio cable.
- 2 Press the  button repeatedly to select "AUX" mode.
- 3 Control playback with your audio device.
- 4 Press + or – buttons to adjust the volume on the external device to increase or decrease the music volume as desired.

FM operation







■ Listening to FM radio

- 1 Press the  button repeatedly to select "FM" mode.
- 2 Press the  or  button to tune in to a station.
Press and hold the  or  button to perform automatic tuning. Tuning stops automatically when a station is received.
• Automatic tuning may stop due to reception noise. In such a case, perform the automatic tuning again.

■ Automatic tuning preset

- 1 Press the  button repeatedly to select "FM" mode.
- 2 Press the MODE button to display the selection menu.
- 3 Press the  or  button repeatedly to select "AUTOSCAN", then press the  button to confirm.
The display will show "AUTO" and start automatically programing.







■ Manual tuning preset

- 1 Select the desired station by manual tuning or auto stop tuning.
- 2 Press the MODE button to display the selection menu.
- 3 Press the  or  button repeatedly to select "MEMORY", then press the  button to confirm.
- 4 Press the  or  button repeatedly to select the preset number, then press the  button to store the station.

Note

- Press the MODE button to exit the menu.
- If there is no operation for 20 seconds, the unit will exit the menu automatically.

■ Showing information

- 1 Press the MODE button to display the selection menu.
- 2 Press the  or  button repeatedly to select "INFO", then press the  button to confirm.
- 3 Press the  or  button repeatedly to select the information (Station Text/Station Name/Pogram Type/Rds Clock), then press the  button to confirm.
The display will show the information.

Note

- Press the MODE button to exit the menu.
- If there is no operation for 20 seconds, the unit will exit the menu automatically.

Maintenance

■ Maintenance of the main unit

Wipe off stains lightly with a soft cloth. If a stain is severe, wipe it off with a cloth dampened with neutral detergent solution and wrung tightly, and dry it with a dry cloth.
• Do not use benzene or thinner, etc. Do not spray any volatile chemical such as insecticide on the cabinet.

When you suspect a failure

Phenomenon	Cause	Remedy
Common unit		
No sound is output.	• The battery is low. • The volume level is low. • The source is not switched properly.	• Charge the battery. • Adjust the volume level. • Switch the device to the proper source.
USB/CARD section		
Replay does not start.	• The MP3 file is not playable.	• Make sure the file is a playable MP3 file.
Device cannot be detected.	• The device is not connected properly.	• Connect the device properly.
Bluetooth® section		
Can not find the Bluetooth name of this unit on the Bluetooth device.	• The unit has a Bluetooth function that can receive a signal within 8 metres.	• Keep the distance between the unit and your Bluetooth device within 8 metres.
Radio unit		
A lot of noise	• The device is affected by power supply noise. • The device is affected by noise due to a motor, electric appliance such as fluorescent lights, or TV. • The radio wave is weak.	• Remove the power cord and insert it again. • Keep the device away from the noise source. Turn off the TV. • Adjust the antenna.

Notes

- The cabinet becomes slightly hot in some parts when the device has been used for a long period of time, it is not a malfunction.

Specifications

USB memory section	
Playback format	MP3
Memory	32 MB to 32 GB
Supported memory	USB1.1 or USB2.0
Playable USB memory	USB-IF certified product
Bluetooth® section	
Bluetooth® specification	Ver. 4.2
Wireless equipment classification	Class 2
Supported profile	A2DP, AVRCP
Frequency	2.402-2.480 GHz (2.4 GHz ISM segment)
Service distance	Up to 10 m
Terminal	
Input/Output	φ 3.5 mm AUX input jack
General	
Power supply	AC 100-240 V, 50/60 Hz
Power consumption	XX W
Max. output power	2 × 10 W
USB port DC output	5 V, 500 mA
Dimension	Approx. 424 (W) × 100 (D) × 127 (H) mm
Weight	Approx. XX.X kg
Accessories	AC adapter, Operation manual, 3.5 mm -3.5 mm audio cable

The specifications and appearance may be subject to modification without prior notice.