

RSR®

TB220L



USER MANUAL

Contents

Important Safety Instructions	2
Identifying the Parts	4
Main Unit	4
Remote Control	4
Preparations.....	5
Prepare the Remote Control	5
First-time use:.....	5
Replace the Remote Control Battery:.....	5
Precautions Concerning Batteries	5
Placement and Mounting	5
Placement.....	5
Wall Mounting (if using option-B)	6
Connections	6
Connect audio through a digital optical cable	6
Connect audio through analog audio cables.....	7
Connect Power	7
Basic Operation	7
Standby/ON	7
Select Modes	7
Adjust the Volume.....	8
AUX / OPTICAL Operation	8
Bluetooth Operation	8
Pair Bluetooth-enabled Devices.....	8
Listen to Music from Bluetooth Device.....	9
Troubleshooting	9
Specifications.....	10
Standard Accessories	10

Important Safety Instructions

	CAUTION RISK OF ELECTRIC SHOCK DO NOT OPEN	
CAUTION: TO REDUCE THE RISK OF ELECTRIC SHOCK, DO NOT REMOVE COVER (OR BACK). NO USER-SERVICEABLE PARTS INSIDE. REFER SERVICING TO QUALIFIED SERVICE PERSONNEL.		



The lightning flash with arrowhead symbol, within an equilateral triangle, is intended to alert the user to the presence of uninsulated "dangerous voltage" within the product's enclosure that may be of sufficient magnitude to constitute a risk of electric shock to persons.



The exclamation point within an equilateral triangle is intended to alert the user to the presence of important operating and maintenance (servicing) instructions in the literature accompanying the appliance.

Safety

- 1 Read these instructions – All the safety and operating instructions should be read before this product is operated.
- 2 Keep these instructions – The safety and operating instructions should be retained for future reference.
- 3 Heed all warnings – All warnings on the appliance and in the operating instructions should be adhered to.
- 4 Follow all instructions – All operating and use instructions should be followed.
- 5 Do not use this apparatus near water – The appliance should not be used near water or moisture – for example, in a wet basement or near a swimming pool, and the like.
- 6 Clean only with dry cloth.
- 7 Do not block any ventilation openings. Install in accordance with the manufacture's instructions.
- 8 Do not install near any heat sources such as radiators, heat registers, stoves, or other apparatus (including amplifiers) that produce heat.
- 9 Danger of explosion if battery is incorrectly replaced. Replace only with the same or equivalent type.
- 10 Do not defeat the safety purpose of the polarized or grounding plug. A polarized

plug has two blades with one wider than the other. A grounding plug has two blades and a third grounding prong. The wide blade or the third prong is provided for your safety. If the provided plug does not fit into your outlet, consult an electrician for replacement of the obsolete outlet.

- 11 Protect the power cord from being walked on or pinched particularly at the plugs, convenience receptacles, and at the point where they exit from the apparatus.
- 12 Only use attachments/accessories specified by the manufacturer.
- 13 Use only with the cart, stand, tripod, bracket, or table specified by the manufacturer, or sold with the apparatus. When a cart or rack is used, use caution when moving the cart/apparatus combination to avoid injury from tip-over.
- 14 Unplug the apparatus during lightning storms or when unused for long periods of time.
- 15 Refer all servicing to qualified personnel. Servicing is required when the apparatus has been damaged in any way, such as power supply cord or plug is damaged, liquid has been spilled or objects have fallen into the apparatus has been exposed to rain or moisture, does not operate normally, or has been dropped.
- 16  This equipment is a Class II or double insulated electrical appliance. It has been designed in such a way that it does not require a safety connection to electrical earth.
- 17 To reduce the risk of fire or electric shock, do not expose this apparatus to rain or moisture. The apparatus must not be exposed to dripping or splashing and objects filled with liquids, such as vases, must not be placed on apparatus.
- 18 The mains plug is used as the disconnect device, the disconnect device shall remain readily operable.

Warning

- The battery (batteries or battery pack) shall not be exposed to excessive heat such as sunshine, fire or the like.
- These servicing instructions are for use by qualified service personnel only. To reduce the risk of electric shock, do not perform

any servicing other than that contained in the operating instructions unless you are qualified to do so.

- Avoid foreign bodies and liquids entering the device.
- Do not place open e.g. lit candles, on or directly adjacent to the device.
- Do not use any corrosive or abrasive cleaning agents. These could damage the surface of the device.
- Please refer the information on exterior bottom or rear enclosure for electrical and safety information before installing or operating the apparatus.
- Minimum distance around the apparatus for sufficient ventilation is 5cm;
- The ventilation should not be impeded by covering the ventilation openings with items such as newspaper, table-cloths, curtains etc.
- No naked flame sources such as lighted candles should be placed on the apparatus;
- Batteries should be recycled or disposed of as per state and local guidelines;
- The use of apparatus in moderate climates.
- The marking label is pasted on the bottom or back of the equipment.

WARNING

DO NOT INGEST BATTERY, CHEMICAL BURN HAZARD

If you think batteries might have been swallowed or placed inside any part of the body, seek immediate medical attention. Keep new and used batteries away from children. If the battery compartment does not close securely, stop using the product and keep it away from children. The remote control supplied with this product contains a coin/button cell battery. If the coin/button cell battery is swallowed, it can cause severe internal burns in just 2 hours and lead to death.



Correct Disposal of this product. This marking indicates that this product should not be disposed with other household wastes throughout the EU.

To prevent possible harm to the environment or human health from uncontrolled waste disposal, recycle it responsibly to promote the sustainable reuse of material resources.

To return your used device, please use the return and collection systems or contact the retailer where the product was purchased. They can take this product for environmental safe recycling.



The Bluetooth® word mark and logos are registered trademarks owned by Bluetooth SIG, Inc. We are the licensee to use such marks. Other trademarks and trade names are those of their respective owners.

FCC INFORMATION (for US customers)

Warning:

Changes or modifications to this unit not expressly approved by the party responsible for compliance could void the user's authority to operate the equipment."

NOTE:

- This equipment has been tested and found to comply with the limits for a Class B digital device, pursuant to Part 15 of the FCC Rules. These limits are designed to provide reasonable protection against harmful interference in a residential installation. This equipment generates, uses and can radiate radio frequency energy and, if not installed and used in accordance with the instructions, may cause harmful interference to radio communications.
- However, there is no guarantee that interference will not occur in a particular installation. If this equipment does cause harmful interference to radio or television reception, which can be determined by turning the equipment off and on, the user is encouraged to try to correct the interference by one or more of the following measures:
 - Reorient or relocate the receiving antenna.
 - Increase the separation between the equipment and receiver.
 - Connect the equipment into an outlet on a circuit different from that to which the receiver is connected.
 - Consult the dealer or an experienced radio / TV technician for help.
- This device complies with Part 15 of the FCC Rules. Operation is subject to the following two conditions:
 - (1) this device may not cause harmful interference, and
 - (2) this device must accept any interference received, including interference that may cause undesired operation.
- Shielded cables must be used with this unit to ensure compliance with the Class B FCC limits.

FCC ID: Z8M-TB220L

Identifying the Parts

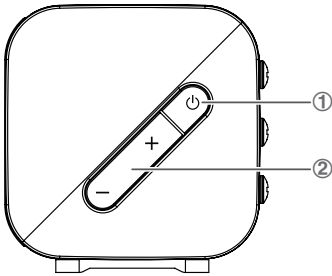

Main Unit

- 1 Turn on or turn off the unit.
Select the play function.
- 2 + / - Increase or decrease the volume level.

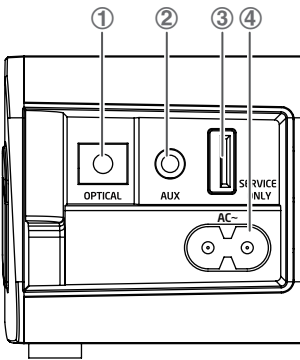

Rear View

- 1 **OPTICAL** Socket
Connect to an external audio device.
- 2 **AUX** Socket
Connect to an external audio device.
- 3 **SERVICE ONLY** Socket
The USB socket is for service only. It is not designed to charge smartphones, tablets or similar devices.
- 4 **AC~** Socket
Connect to power.

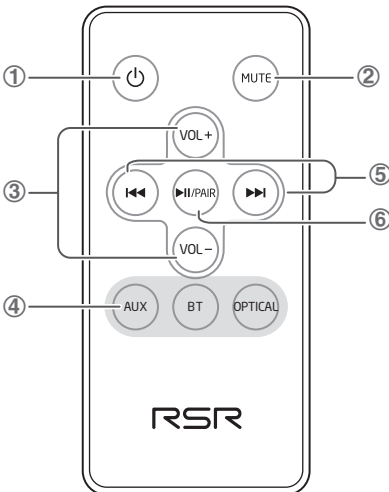

Remote Control

- 1 Turn on or turn off the unit.
- 2 **MUTE**
Mute or resume the sound.
- 3 **VOL+/VOL-**
Increase/decrease the volume level.
- 4 **Function buttons**
Select the play function.
RED: **Power off**
GREEN: **AUX**
BLUE: **Bluetooth**
WHITE: **OPTICAL**
- 5 Skip to previous/next track in Bluetooth mode.
- 6 Play/pause/resume playback in Bluetooth mode.
Press and hold to activate the pairing function in Bluetooth mode or disconnect the existing paired Bluetooth device.

Preparations

Prepare the Remote Control

The provided Remote Control allows the unit to be operated from a distance.

- Even if the Remote Control is operated within the effective range 19.7 feet (6m), remote control operation may be impossible if there are any obstacles between the unit and the remote control.
- If the Remote Control is operated near other products which generate infrared rays, or if other remote control devices using infrared rays are used near the unit, it may operate incorrectly. Conversely, the other products may operate incorrectly.

First-time use:

The unit has a pre-installed lithium CR2025 battery. Remove the protective tab to activate the remote control battery.

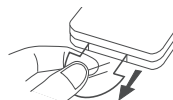

Replace the Remote Control Battery:

- 1 Pull out the battery tray and remove the old battery.
- 2 Place a new CR2025 battery into the battery tray with correct polarity (+/-) as indicated.
- 3 Insert the battery tray back into the slot.

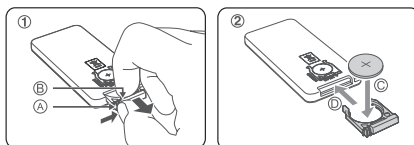

Precautions Concerning Batteries

- When the Remote Control is not to be used for a long time (more than a month), remove the battery from the Remote Control to prevent it from leaking.
- If the batteries leak, wipe away the leakage inside the battery compartment and replace the batteries with new ones.
- Do not use any batteries other than those specified.
- Do not heat or disassemble batteries. Never throw them in fire or water.
- Do not carry or store batteries with other metallic objects. Doing so could cause batteries to short circuit, leak or explode.
- Never recharge a battery unless it is confirmed to be a rechargeable type.

Placement and Mounting

Placement

- A If your TV is placed on a table, you can place the unit on the table directly in front of the TV stand, centered with the TV screen.
- B If your TV is attached to a wall, you can mount the unit on the wall directly below the TV screen.

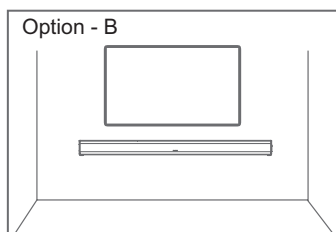
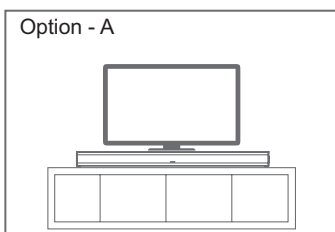

Wall Mounting (if using option-B)

Note:

- Installation must be carried out by qualified personnel only. Incorrect assembly can result in severe personal injury and property damage (if you intend to install this product yourself, you must check for installations such as electrical wiring and plumbing that may be buried inside the wall). It is the installer's responsibility to verify that the wall will safely support the total load of the unit and wall brackets.
- Additional tools (not included) are required for the installation.
- Do not overtighten screws.
- Keep this instruction manual for future reference.
- Use an electronic stud finder to check the wall type before drilling and mounting.

- ① Remove the backing paper from the rubber. Stick the rubber to the back of the soundbar.
NOTE: Ensure the surface is clean prior to sticking the rubber to the back of the soundbar.

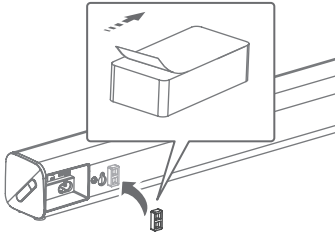

- ② Drill 2 parallel holes (Ø 3-8 mm each according to wall type) in the wall. The distance between the holes should be 2.33 feet (711 mm). Firmly fix 1 dowel into each hole in the wall if necessary.

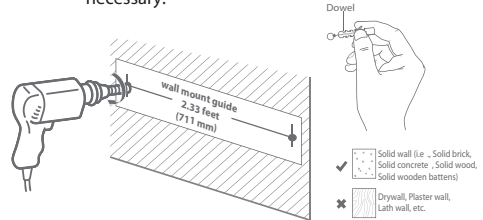

- ③ Leave a 0.4 inch (9 mm) gap between the wall and the screw's head. Lift the soundbar over the heads of the screws and slot into place.

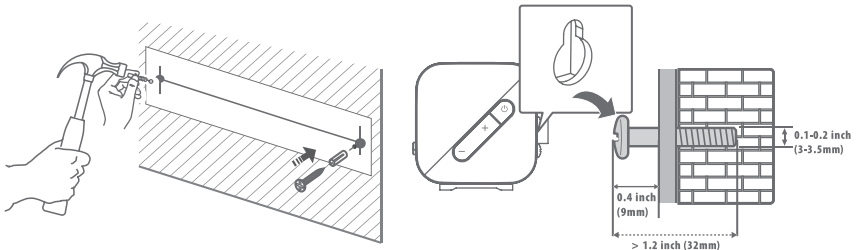

Connections

Connect audio through a digital optical cable

Remove the protective cap of the OPTICAL socket, then connect an OPTICAL cable (included) to the TV's OPTICAL OUT socket and the OPTICAL socket on the SoundBar.

- The digital optical connector might be labeled SPDIF or SPDIF OUT.

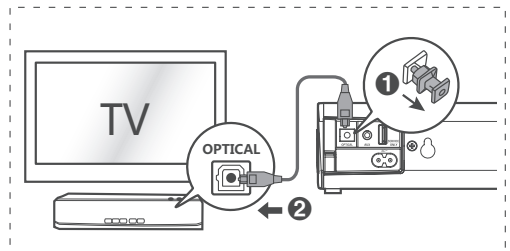

Connect audio through analog audio cables

- A. Use a 3.5mm to 3.5mm audio cable (included) to connect the TV's or external audio device headphone socket to the **AUX** socket on the unit.
- B. Use a RCA to 3.5mm audio cable (not included) to connect the TV's audio output sockets to the **AUX** socket on the unit.

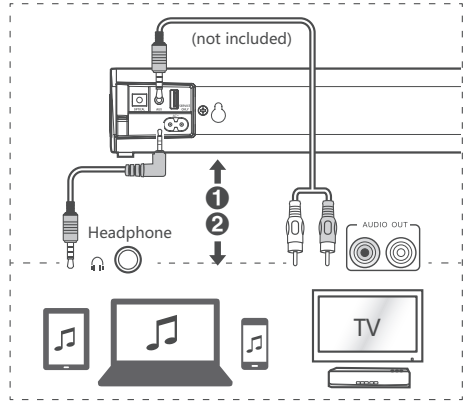

Connect Power

- **Risk of product damage!** Ensure that the power supply voltage corresponds to the voltage printed on the back or the underside of the unit.
- Before connecting the AC power cord, ensure you have completed all other connections.
- Connect the mains cable to the **AC~** Socket of soundbar and then into a mains socket.

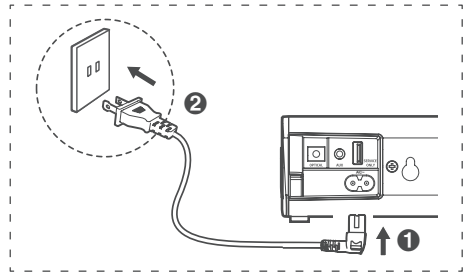

Basic Operation

Standby/ON

When you first connect the soundbar to the mains socket, the main unit will be in Standby mode.

- Press the **⏻** button on the soundbar or on the remote control to switch the unit ON.
- Press the **⏻** button again to switch the unit back to STANDBY mode. The indicator will light up red.
- Disconnect the mains plug from the mains socket if you want to switch the unit OFF completely.
- If a TV or an external device is connected, the unit will switch on automatically when the TV or the external device is switched on.
- When the unit no input signal (or weak input signal) for over 15 minutes, the soundbar will automatically switch to Standby mode.

Select Modes

Press the **⏻** button on the soundbar or press the **AUX, BT, OPTICAL** buttons on the remote control to select the desired mode. The selected mode will be shown on the function LED'S on the front of the soundbar.

RED: **Power off**
BLUE: **Bluetooth**

GREEN: **AUX**
WHITE: **OPTICAL**

Adjust the Volume

- Press the + / - buttons on the unit or **VOL+ / VOL-** buttons on the remote control to adjust the volume.
- If you wish to turn the sound off, press the **MUTE** button on the remote control. Press the **MUTE** button again or press the + / - buttons on the unit or **VOL+ / VOL-** buttons on the remote control to resume normal listening.
- While adjusting the volume, the status indicator flashes quickly.
- While the volume level reaches its maximum level, if you press the VOL+ button again, the status indicator flashes once. While the volume level reaches its minimum level, if you press the VOL- button again, the status indicator flashes once.

AUX / OPTICAL Operation

- 1 Ensure that the unit is connected to the TV or audio device.
- 2 Press the  button on the soundbar or press the **AUX or OPTICAL** buttons on the remote control to select the desired mode.
- 3 Operate your audio device directly for playback features.
- 4 Press the **VOL +/-** button to adjust the volume to your desired level.

Tip:

In OPTICAL mode, if there is no sound output, ensure the audio setting of the input source (e.g. TV, game console, DVD player, etc.) is set to PCM mode with optical input.

Bluetooth Operation

Pair Bluetooth-enabled Devices

The first time you connect your bluetooth device to this player, you need to pair your device to this player.

Note:

- The operational range between this player and a Bluetooth device is approximately 26.2 feet (8 m) (without any object between the Bluetooth device and the unit).
 - Before you connect a Bluetooth device to this unit, ensure you know the device's capabilities.
 - Compatibility with all Bluetooth devices is not guaranteed.
 - Any obstacle between this unit and a Bluetooth device can reduce the operational range.
 - If the signal strength is weak, your Bluetooth receiver may disconnect, but it will re-enter pairing mode automatically.
- 1 During ON mode, press the  button on the soundbar or press the **BT** button on the remote control to select Bluetooth mode. The Blue indicator will lights up.
 - 2 The system has entered pairing mode.
 - Or press and hold the "**▶ II/PAIR**" button on the remote control to be searchable. After the "**Pairing**" voice prompt and the Blue indicator will flash rapidly.
 - 3 Activate your Bluetooth device and select the search mode. "**RSR TB220L**" will appear on your Bluetooth device list.
 - 4 Select "**RSR TB220L**" in the pairing list. After the "**Paired**" voice prompt, the system is successfully connected and the Blue indicator will light up solidly.
 - 5 Play music from the connected Bluetooth device.

To disconnect the Bluetooth function, you can :

- Switch to another function on the unit.
- Disable the function from your Bluetooth device. The Bluetooth device will be disconnected from the unit after the **"Disconnected"** voice prompt.
- Press and hold the **"▶ II/PAIR"** button on the remote control.

Tips:

- Enter "0000" for the password if necessary.
- If no other Bluetooth device pairs with this player within two minutes, the player will recover its previous connection.
- The player will also be disconnected when your device is moved beyond the operational range.
- If you want to reconnect your device to this player, place it within the operational range.
- If the device is moved beyond the operational range, when it is brought back, please check if the device is still connected to the player.
- If the connection is lost, follow the instructions above to pair your device to the player again.

Listen to Music from Bluetooth Device

- If the connected Bluetooth device supports Advanced Audio Distribution Profile (A2DP), you can listen to the music stored on the device through the player.
 - If the device also supports Audio Video Remote Control Profile (AVRCP), you can use the player's remote control to play music stored on the device.
1. Pair your device with the player.
 2. Play music via your device (if it supports A2DP).
 3. Use supplied remote control to control play (if it supports AVRCP).
- To pause/resume play, press the **▶ II/PAIR** button on the remote control.
 - To skip to a track, press the **◀▶** buttons on the remote control.

Troubleshooting

To keep the warranty valid, never try to repair the system yourself. If you encounter problems when using this unit, check the following points before requesting service.

No power

- Ensure that the AC cord is properly connected .
- Ensure that there is power at the AC outlet.
- Press standby button on the remote control or soundbar to turn the soundbar on.

No sound

- Increase the volume. Press Volume Up on the remote control or on the right side of the soundbar.
- Press MUTE on the remote control to ensure the soundbar is not muted.
- Press source buttons to select a different input source.
- When using either of the Digital input, if there is no audio:
 - Try setting the TV output to PCM or
 - Connect directly to your Blu-ray/other source, some TVs do not pass through digital audio.
- Your TV may be set to variable audio output. Confirm that the audio output setting is set to FIXED or STANDARD, not VARIABLE. Consult your TV's user manual for more detailed information.
- If using Bluetooth, ensure that the volume on your source device is turned up and that the device is not muted.

Remote control does not work

- Before you press any playback control button, first select the correct source.

- Reduce the distance between the remote control and the unit.
- Insert the battery with its polarities (+/-) aligned as indicated.
- Replace the battery.
- Aim the remote control directly at the sensor on the front of the unit.

I hear buzzing or humming

- Ensure all cables and wires are securely connected.
- Connect a different source device (TV, Blu-ray player, etc) to see if the buzzing persists. If it does not, the problem may be with the original device.
- Connect your device to a different input on the soundbar.

I can't find the Bluetooth name of this unit on my Bluetooth device

- Ensure the Bluetooth function is activated on your Bluetooth device.
- Re-pair the unit with your Bluetooth device.

Specifications

General

Power Requirements.....	AC120V~ 60Hz
Power Consumption	10 W
Output Power	8W x 2
Total Harmonic Distortion.....	1%(1kHz, 1W)
Audio Input Sensitivity.....	500mV
Frequency Response.....	40Hz - 20kHz
Unit Dimension (W x H x D)	31.6 x 2.5 x 2.6 inch (802.3 x 63 x 66.8 mm)
Speaker Impedance.....	4Ω x 2

Remote Control

Distance	19.7 feet (6m)
Angle.....	30°
Battery Type.....	CR2025

Standard Accessories

Soundbar.....	x 1
Remote Control	x 1
3.5mm to 3.5mm audio Cable	x 1
Power Cable.....	x 1
Optical Cable.....	x 1
User Manual	x 1
Quick Start Guide	x 1
Wall Mount Guide	x 1
Rubber	x 2
Wall Screws.....	x 2

- Design and specifications are subject to change without notice.