

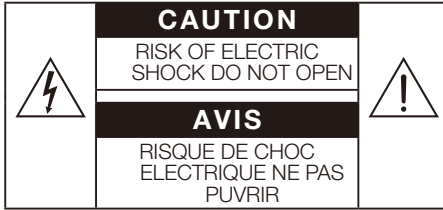

Contents

Important Safety Instructions	2
Safety	2
What's in the Box	5
Placement and Mounting	6
Placement.....	6
Stand Mounting (if using option-A).....	6
Horizontal Mounting.....	6
Installing the Rubber Feet (if using option-B).....	7
Wall Mounting (if using option-C).....	7
Identifying the Parts	8
Main Unit.....	8
Wireless Subwoofer.....	9
Remote Control	9
Preparations	10
Prepare the Remote Control.....	10
Replace the Remote Control Battery	10
Connections	11
HDMI socket.....	11
Use the OPTICAL Socket.....	11
Use the COAXIAL Socket	12
Use the AUX Socket.....	12
Connect to Power	12
Pairing the Wireless Subwoofer with the Main Unit.....	13
Automatic pairing.....	13
Manual pairing.....	13
General Operation	13
Standby/ON	13
Select Modes	14
Adjust the Volume.....	14
Select equaliser (EQ) effect	14
LINE IN/AUX/OPTICAL/COAXIAL/HDMI/ Operation.....	14
Bluetooth Operation.....	15
Pair Bluetooth-enabled Devices.....	15
NFC (Near Field Communication) Operation	15
Listen to Music from Bluetooth Device	16
Troubleshooting.....	16
Specifications	17

Important Safety Instructions



 The lightning flash with arrowhead symbol, within an equilateral triangle, is intended to alert the user to the presence of uninsulated "dangerous voltage" within the product's enclosure that may be of sufficient magnitude as to constitute a risk of electric shock to persons.

 The exclamation point within an equilateral triangle is intended to alert the user to the presence of important operating and maintenance (servicing) instructions in the literature accompanying the appliance.

Safety

- 1 Read these instructions** - All the safety and operating instructions should be read before this product is operated.
- 2 Keep these instructions**-The safety and operating instructions should be retained for future reference.
- 3 Heed all warnings** - All warnings on the appliance and in the operating instructions should be adhered to.
- 4 Follow all instructions** - All operating and use instructions should be followed.
- 5 Do not use this apparatus near water** - The appliance should not be used near water or moisture - for example, in a wet basement or near a swimming pool and the like.
- Clean only with a dry cloth.
- Do not block any ventilation openings. Install in accordance with the manufacturer's instructions.
- Do not install near any heat sources such as radiators, heaters, stoves, or other apparatus (including amplifiers) that produce heat.
- Do not defeat the safety purpose of the polarized or grounding-type plug. A polarized plug has two blades with one wider than the other. A grounding type plug has two blades and a third grounding prong. The wide blade or the third prong is provided for your safety. If the provided plug does not fit into your outlet, consult an electrician for replacement of the obsolete outlet.
- Protect the power cord from being walked on or pinched, particularly at plugs, convenience receptacles and at the point where they exit from the apparatus.
- Only use attachments/accessories specified by the manufacturer.
-  12 Use only with the cart, stand, tripod, bracket, or table specified by the manufacturer, or sold with the apparatus. When a cart or rack is used, use caution when moving the cart/apparatus combination to avoid injury from tip-over.
- Unplug the apparatus during lightning storms or when unused for long periods of time.
- Refer all servicing to qualified personnel. Servicing is required when the apparatus has been damaged in any way, such as power supply cord or plug is damaged, liquid has been spilled or objects have fallen into the apparatus, the unit has been exposed to rain or moisture, does not operate normally, or has been dropped.
- This equipment is a Class II or double insulated electrical appliance. It has been designed in such a way that it does not require a safety connection to electrical earth.
- The apparatus shall not be exposed to dripping or splashing. No objects filled with liquids, such as vases, shall be placed on the apparatus.
- Minimum distance around the apparatus for sufficient ventilation is 5cm.
- The ventilation should not be impeded by covering the ventilation openings with items, such as newspapers, table-cloths, curtains, etc...
- No naked flame sources, such as lighted candles, should be placed on the apparatus.

Caution:

- Use of controls or adjustments or performance of procedures other than those described herein, may result in hazardous radiation exposure or other unsafe operation.
- To reduce the risk of fire or electric shock, do not expose this apparatus to rain or moisture. The apparatus must not be exposed to dripping or splashing and objects filled with liquids, such as vases, must not be placed on apparatus.
- The mains plug/appliance coupler is used as the disconnect device, the disconnect device must remain readily operable.
- Danger of explosion if battery is incorrectly replaced. Replace only with the same or equivalent type.

Warning

- The battery (batteries or battery pack) shall not be exposed to excessive heat such as sunshine, fire or the like.
- Before operating this system, check the voltage of this system to see if it is identical to the voltage of your local power supply.
- Do not place this unit close to strong magnetic fields.
- Do not place this unit on the amplifier or receiver.
- Do not place this unit close to damp areas as the moisture will affect the life of the laser head.
- If any solid object or liquid falls into the system, unplug the system and have it checked by qualified personnel before operating it any further.
- Do not attempt to clean the unit with chemical solvents as this may damage the finish. Use a clean, dry or slightly damp cloth.
- When removing the power plug from the wall outlet, always pull directly on the plug, never yank on the cord.
- Changes or modifications to this unit not expressly approved by the party responsible for compliance will void the user's authority to operate the equipment.
- The rating label is pasted on the bottom or back of the equipment.

DO NOT INGEST BATTERY, CHEMICAL BURN HAZARD

If you think batteries might have been swallowed or placed inside any part of the body, seek immediate medical attention. Keep new and used batteries away from children. If the battery compartment does not close securely, stop using the product and keep it away from children. The remote control supplied with this product contains a coin/button cell battery. If the coin/button cell battery is swallowed, it can cause severe internal burns in just 2 hours and lead to death.

The appliance is not intended for use by young children or infirm persons without supervision.

Young children should be supervised to ensure that they do not play with the appliance.

Correct Disposal of this product. This marking  indicates that this product should not be disposed with other household wastes throughout the EU. To prevent possible harm to the environment or human health from uncontrolled waste disposal, recycle it responsibly to promote the sustainable reuse of material resources. To return your used device, please use the return and collection systems or contact the retailer where the product was purchased. They can take this product for environmental safe recycling.

- Batteries should be recycled or disposed of as per state and local guidelines.
- The use of apparatus in moderate climates.

FCC INFORMATION (for US customers)

Warning:

- Changes or modifications to this unit not expressly approved by the party responsible for compliance could void the user's authority to operate the equipment. "

NOTE: This equipment has been tested and found to comply with the limits for a Class B digital device, pursuant to Part 15 of the FCC Rules. These limits are designed to provide reasonable protection against harmful interference in a residential installation. This equipment generates, uses and can radiate radio frequency energy and, if not installed and used in accordance with the instructions, may cause harmful interference to radio communications.

However, there is no guarantee that interference will not occur in a particular installation. If this equipment does cause harmful interference to radio or television reception, which can be determined by turning the equipment off and on, the user is encouraged to try to correct the interference by one or more of the following measures:

- Reorient or relocate the receiving antenna.
- Increase the separation between the equipment and receiver.
- Connect the equipment into an outlet on a circuit different from that to which the receiver is connected.
- Consult the dealer or an experienced radio / TV technician for help.

This device complies with Part 15 of the FCC Rules. Operation is subject to the following two conditions:

- (1) this device may not cause harmful interference, and
- (2) this device must accept any interference received, including interference that may cause undesired operation.

IC Notice:

This device complies with Canada Industry licence-exempt RSS standard(s). Operation is subject to the following two conditions: (1) this device may not cause interference. and (2) this device must accept any interference. Including interference that may cause undesired operation of the device.

IC: 11096A-TB235CWW
CAN ICES-3 (B) / NMB-3 (B)

Avis d'Industrie Canada

Le présent appareil est conforme aux CNR d'industrie Canada applicables aux appareils radio exem pts de licence L'exploitation est autorisée aux deux conditions suivantes:

- (1) l'appareil ne doit pas produire de brouillage, et
- (2) l'utilisateur de l'appareil doit accepter brouillage radioélectrique subi meme si le brouillage est susceptible d'encompromettre le fonctionnement. mauvais fonctionnement de l'appareil.

What's in the Box



Main Unit (Left / Right)

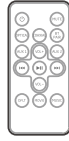

Remote Control

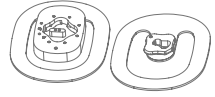

Stand (Left / Right)



Instruction Manual

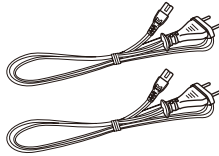

AC Power Cord

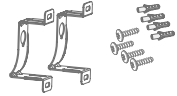

Wall Bracket

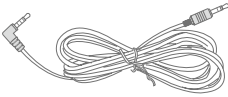

3.5mm to 3.5mm Audio Cable



3.5mm to RCA Audio Cable

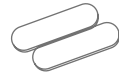

Rubber Feet



Optical Cable



Wireless Subwoofer

- Design and specifications are subject to change without notice.

Placement and Mounting

As the unit can be used either a single sound bar or a 2-piece Tube speakers.

Placement

- You are suggested putting the unit with below options:

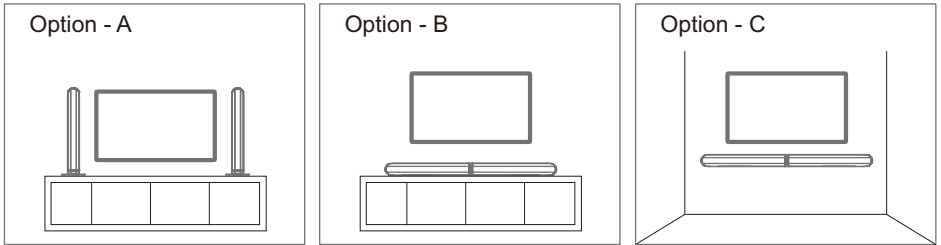

Stand Mounting (if using option-A)

Main Unit (Left)

Main Unit (Right)

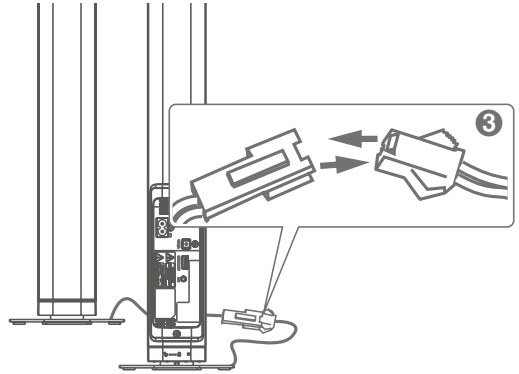
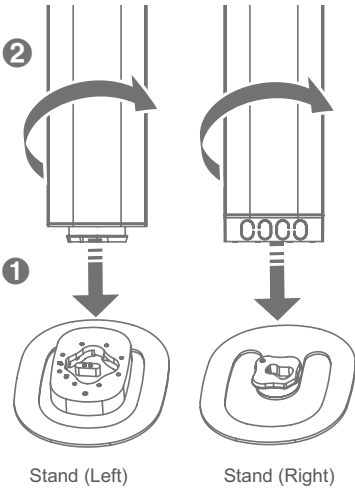

Horizontal Mounting

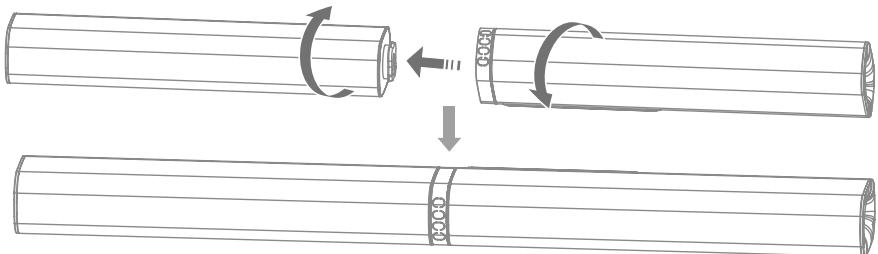

Installing the Rubber Feet (if using option-B)

You can extend the height of the unit.

Note:

Ensure the surface is clean prior to sticking the rubber foot to the bottom of the unit.

1. Turn the unit upside down.
2. Remove the backing paper from the rubber foot.
3. Stick the rubber foot to the bottom of the unit as shown in the illustration below.

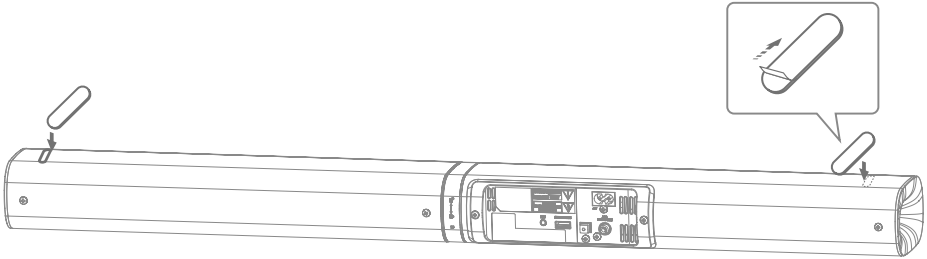

Wall Mounting (if using option-C)

Note:

- Installation must be carried out by qualified personnel only. Incorrect assembly can result in severe personal injury and property damage (if you intend to install this product yourself, you must check for installations such as electrical wiring and plumbing that may be buried inside the wall). It is the installer's responsibility to verify that the wall will safely support the total load of the unit and wall brackets.
 - Additional tools (not included) are required for the installation.
 - Do not overtighten screws.
 - Keep this instruction manual for future reference.
 - Use an electronic stud finder to check the wall type before drilling and mounting.
1. Drill 4 parallel holes (Ø 3-8 mm each according to wall type) in the wall. The distance between the holes should be 764 mm.
 - Firmly fix 1 dowel into each hole in the wall if necessary.
 2. Tighten the wall mount brackets on the wall with screws and screwdriver (not included). Make sure they are securely installed.
 3. Loosen the screws at the back of the unit for 3 mm. Lift the unit onto the wall mount brackets and slot into place.

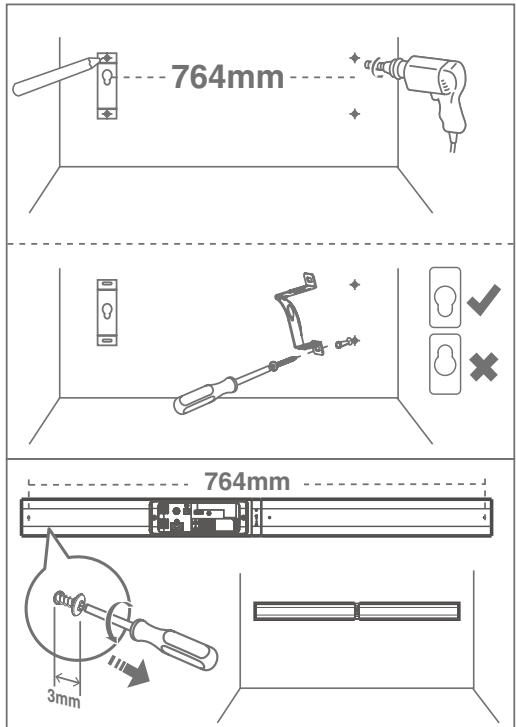

Identifying the Parts

Main Unit

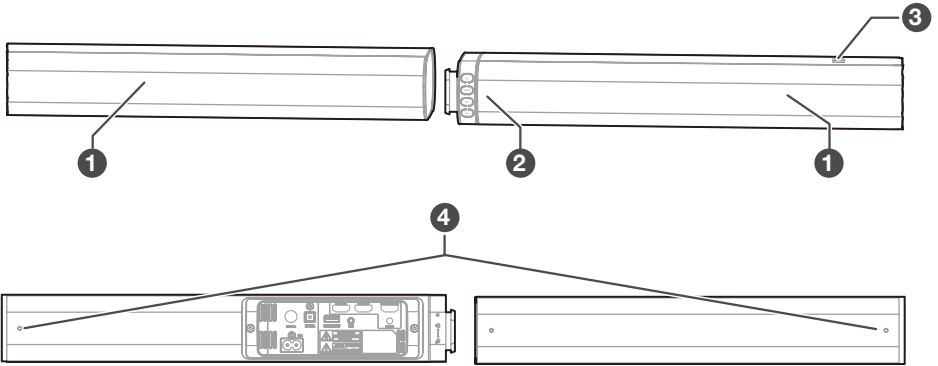

- 1 **Speakers**
- 2 **Remote Control Sensor**
- 3 **NFC Sensor area**
- 4 **Wall bracket screws**

5 **SOURCE** button

Select the play function.

In **AUX** mode, the lights up **Green**.

6 **⏻** button

Switch the unit between on and Standby mode.

In **Standby** mode, the lights up **Red**.

7 **VOL+** button

Increase the volume level.

In **Bluetooth** mode, the lights up **Blue**.

8 **VOL-** button

Decrease the volume level.

In **OPTICAL** mode, the lights up **Orange**.

9 **COAXIAL** Socket

10 **OPTICAL** Socket

11 **SERVICE ONLY** Socket

The USB socket is for service only. It is not designed to charge smartphones, tablets or similar devices.

12 **AUX** Socket

Connect to an external audio device.

13 **HDMI IN 1/2** Sockets

14 **HDMI OUT (ARC)** Socket

15 **AC~** Socket

16 **LINE IN** Socket

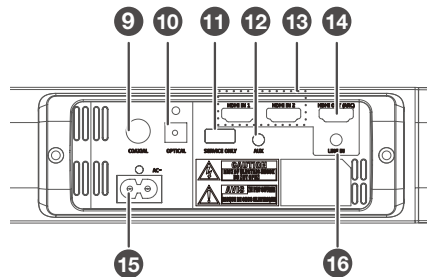
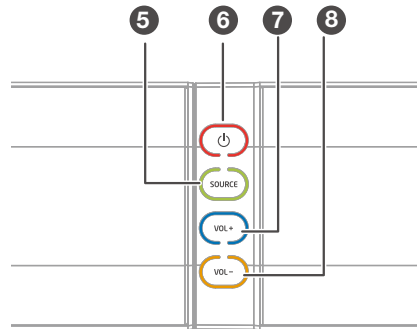

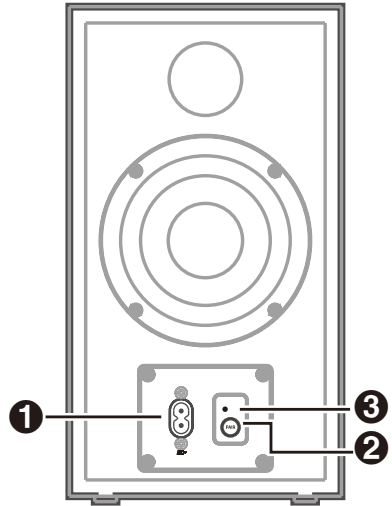

Wireless Subwoofer

- 1 AC~ Power Cord**
Connect to power.
- 2 PAIR Button**
Pair with the main unit.
- 3 PAIR Indicator**
Pair indicator lights up when the pairing succeeds



Remote Control

- 
Switch the unit between ON and STANDBY mode.
- MUTE**
Mute or resume the sound.
- SOURCE** buttons
Select the play function.
BT/PAIR
Press and hold to activate the pairing function in Bluetooth mode and disconnect the existing paired Bluetooth device.
- 
In Bluetooth mode, skip to previous/next track.

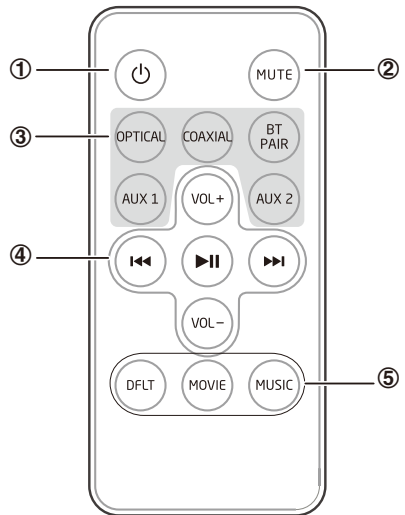
In Bluetooth mode, start or pause playback.
VOL+/VOL-
Increase/decrease the volume level.
- EQ** buttons
Select equaliser (EQ) effect.



Preparations

Prepare the Remote Control

The provided Remote Control allows the unit to be operated from a distance.

- Even if the Remote Control is operated within the effective range (6m), remote control operation may be impossible if there are any obstacles between the unit and the remote control.
- If the Remote Control is operated near other products which generate infrared rays, or if other remote control devices using infra-red rays are used near the unit, it may operate incorrectly. Conversely, the other products may operate incorrectly.

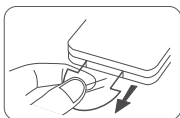
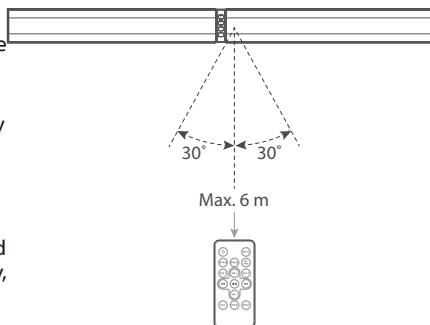

First-time use:

The unit has a pre-installed lithium CR2025 battery. Remove the protective tab to activate the remote control battery.

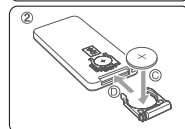
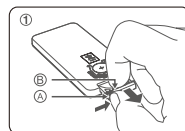

Replace the Remote Control Battery

1. Pull out the battery tray and remove the old battery.
2. Place a new CR2025 battery into the battery tray with correct polarity (+/-) as indicated.
3. Insert the battery tray back into the slot.

Precautions Concerning Batteries

- When the Remote Control is not to be used for a long time (more than a month), remove the battery from the Remote Control to prevent it from leaking.
- If the batteries leak, wipe away the leakage inside the battery compartment and replace the batteries with new ones.
- Do not use any batteries other than those specified.
- Do not heat or disassemble batteries.
Never throw them in fire or water.
- Do not carry or store batteries with other metallic objects. Doing so could cause batteries to short circuit, leak or explode.
- Never recharge a battery unless it is confirmed to be a rechargeable type.

Connections

HDMI socket

Using HDMI to connect the soundbar, AV equipment and TV:

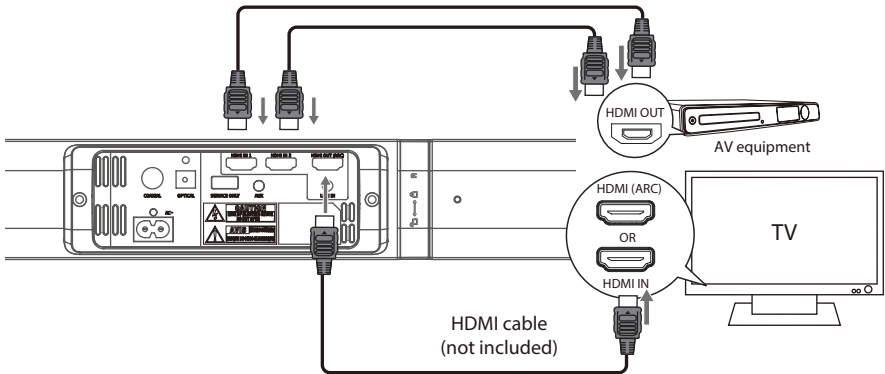

Method 1: ARC (Audio Return Channel)

- With the ARC (Audio Return Channel) function, it allows you to send audio from your ARC-compliant TV to ARC-compliant audio devices (e.g. soundbar) without the need to connect an HDMI cable.
- To enjoy the ARC function, make sure your soundbar's **HDMI OUT** socket is connected by an HDMI 1.4 cable to the **HDMI OUT TV (ARC)** socket of your ARC-compliant TV. Then, just use your TV remote control to adjust the volume output (VOL +/- and MUTE) of the connected audio device.

Tips:

- Your TV must support the HDMI-CEC and ARC function. HDMI-CEC and ARC must be set to On.
- The setting method of HDMI-CEC and ARC may differ depending on the TV. For details about ARC function, please refer to the owner's manual.
- Only HDMI 1.4 cables can support the ARC function.

Method 2: Standard HDMI

- If your TV is not HDMI ARC-compliant, connect your soundbar to the TV through a standard HDMI connection.
1. Use an HDMI cable (not included) to connect the soundbar's **HDMI OUT** socket to the TV's HDMI IN socket.
 2. Use an HDMI cable (not included) to connect the soundbar's **HDMI IN (1 or 2)** socket to your external devices (e.g. games consoles, DVD players and blu ray).

Use the OPTICAL Socket

- Remove the protective cap of the **OPTICAL** socket, then connect an OPTICAL cable (included) to the TV's OPTICAL OUT socket and the **OPTICAL** socket on the unit.

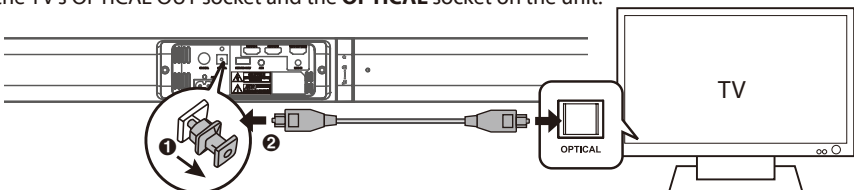

Use the COAXIAL Socket

- Use a coaxial cable (not included) to connect the TV's COAXIAL OUT socket to the COAXIAL socket on the unit.

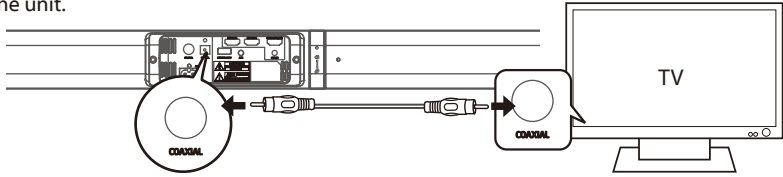

Use the AUX Socket

- Use a 3.5mm to 3.5mm audio cable (included) to connect the TV's headphone socket to the **AUX** or **LINE IN** socket on the unit.

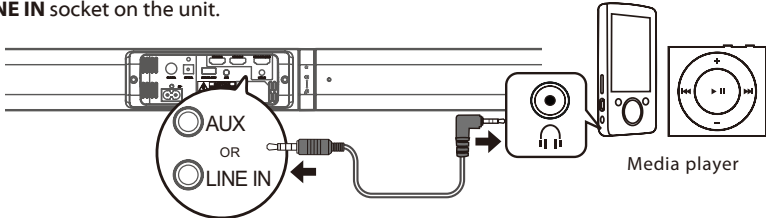

- Use a RCA to 3.5mm audio cable (included) to connect the TV's audio output sockets to the **AUX** or **LINE IN** socket on the unit.

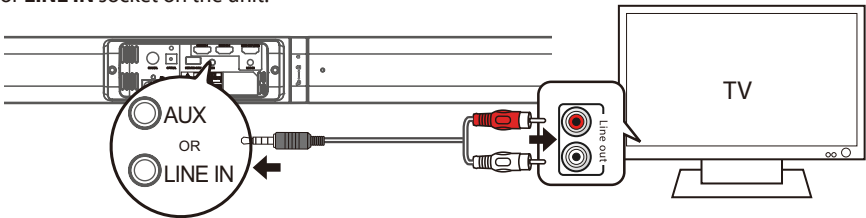

Connect to Power

- Before connecting the AC power cord, ensure you have completed all other connections.
- Risk of product damage! Ensure that the power supply voltage corresponds to the voltage printed on the back or the underside of the unit.

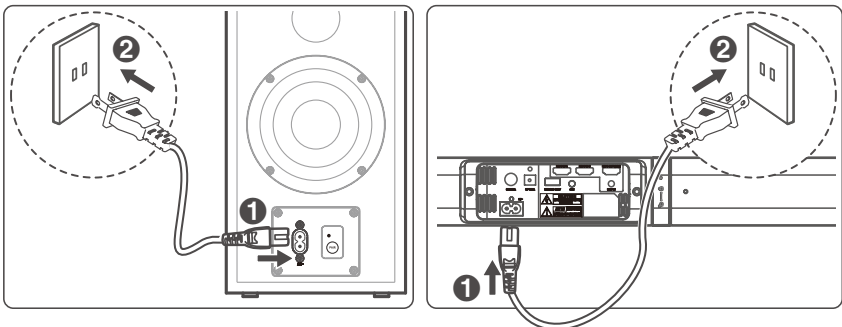

- Connect the mains cable to the **AC~** Socket of the unit and then into a mains socket.
- Connect the mains cable to the **AC~** Socket of subwoofer and then into a mains socket.

Pairing the Wireless Subwoofer with the Main Unit

Automatic pairing

The subwoofer and soundbar will automatically pair when both units are plugged into the mains sockets and turned on. No cable is needed for connecting the two units.

- When the subwoofer is pairing with the main unit, the Pair Indicator will flash fast.
- When the subwoofer is paired with the main unit, the Pair Indicator will light up.

NOTE:

- Do not press the **Pair** button on the rear of the subwoofer, except for manual pairing.
- If the automatic pairing fails, pair the subwoofer with the main unit manually.

Manual pairing

1. Ensure that all the cables are well connected and the main unit is in Standby mode.
2. Press and hold the **Pair** button on the rear of the subwoofer for a few seconds. The subwoofer will enter the pairing mode and the Pair Indicator will blink quickly.
3. Press the  button on the main unit or on the remote control to switch the main unit on.
4. After the wireless connection succeeded, the Pair Indicator will light up.
5. If the Pair indicator blinks, the wireless connection has failed. Unplug the cable of the subwoofer and then reconnect the main cable after 3 minutes. Repeat step 1 ~ 4.



NOTE:

- If the wireless connection fails again, check if there is conflict or strong interference (for example, interference from an electronic device) around your location. Remove these conflicts or strong interferences and repeat the above procedures.
- The subwoofer should be within 6m of the soundbar in an open area.
- If a TV or an external device is connected, the main unit only AUX model and the subwoofer will switch on automatically when the TV or the external device is switched on.
- If the main unit is not connected with the subwoofer and it is in On mode, the POWER Indicator will flash. Follow step 1 ~ 4 above to pair the subwoofer to the main unit.

General Operation

Standby/ON

When you first connect the main unit to the mains socket, the main unit will be in Standby mode.

- Press the  button on the unit or on the remote control to switch the unit ON.
- Press the  button again on the remote control or on the unit to switch the unit back to STANDBY mode. The POWER indicator will light up red.
- Disconnect the mains plug from the mains socket if you want to switch the unit OFF completely.
- When there is no input signal (or weak input signal) in AUX, OPTICAL and Bluetooth (Stop or Pause) for over 15 minutes, the unit will automatically switch to Standby mode.

Select Modes

Press the **SOURCE** button repeatedly on the unit or press the **AUX, LINE IN, OPTICAL, COAXIAL, BT** (Bluetooth) **HDMI 1, HDMI 2, ARC** buttons on the remote control to select the desired mode.

- In **AUX** mode: **Red** - flash fast
- In **LINE IN** mode: **Red** - flash slowly
- In **OPTICAL** mode: **Green**
- In **COAXIAL** mode: **Green** - flash slowly
- In **HDMI1** mode: **Orange**
- In **HDMI2** mode: **Orange** - flash fast
- In **ARC** mode: **Orange** - flash slowly
- In **Bluetooth** mode: **Blue**.

Adjust the Volume

- Press the **VOL+** / **VOL-** buttons on the unit or on the remote control to adjust the volume.
- If you wish to turn the sound off, press the **MUTE** button on the remote control. Press this button again or press the **VOL+** / **VOL-** buttons on the unit or on the remote control to resume normal listening.
- While adjusting the volume, the status indicator flashes quickly.
- While the volume level reaches its maximum level, if you press the **VOL+** button again, the status indicator flashes once. While the volume level reaches its minimum level, if you press the **VOL-** button again, the status indicator flashes once.

Select equaliser (EQ) effect

While playing, press the **VOICE, MOVIE** and **MUSIC** button on the remote control to select desired preset equalisers: **MOVIE** (recommended for viewing movies), **MUSIC** (recommended for listening to music), **DFLT** (EQ mode off).

- While select a preset sound effect, the status indicator flashes quickly.

LINE IN/AUX/OPTICAL/COAXIAL/HDMI/ Operation

- 1 Ensure that the unit is connected to the TV or audio device.
- 2 While in ON mode, press the **SOURCE** button repeatedly on the unit or press the **OPTICAL / COAXIAL / HDMI 1 / HDMI 2 / ARC / AUX / LINE IN** buttons on the remote control to select the desired mode.
- 3 Operate your audio device directly for playback features.
- 4 Press the **VOL +/-** button to adjust the volume to your desired level.

Tip:

- In **OPTICAL / COAXIAL / HDMI 1 / HDMI 2 / ARC** mode, if there is no sound output, ensure the audio setting of the input source (e.g. TV, game console, DVD player, etc.) is set to **PCM** mode.

Bluetooth Operation

You can listen to tracks from a media device if connected to the unit via Bluetooth.

Pair Bluetooth-enabled Devices

The first time you connect your bluetooth device to this player, you need to pair your device to this player.

Note:

- The operational range between this player and a Bluetooth device is approximately 8 meters (without any object between the Bluetooth device and the unit).
 - Before you connect a Bluetooth device to this unit, ensure you know the device's capabilities.
 - Compatibility with all Bluetooth devices is not guaranteed.
 - Any obstacle between this unit and a Bluetooth device can reduce the operational range.
 - If the signal strength is weak, your Bluetooth receiver may disconnect, but it will re-enter pairing mode automatically.
- 1 During ON mode, press the **SOURCE** button repeatedly on the unit or press the **BT** (Bluetooth) button on the remote control to select **Bluetooth** mode. The **Blue** indicator will flash slowly.
 - 2 The system has entered pairing mode.
 - Or press and hold the **BT/PAIR** button on the remote control to be searchable. The **Blue** indicator will flash fast and you will hear "**PAIRING**" from the unit .
 - 3 Activate your Bluetooth device and select the search mode. "**TB285CWW**" will appear on your Bluetooth device list.
 - 4 Select "**TB285CWW**" in the pairing list. After the "**Paired**" voice prompt, the system is successfully connected and the **Blue** indicator will light up solidly.
 - 5 Play music from the connected Bluetooth device.

To disconnect the Bluetooth function, you can :

- Switch to another function on the unit.
- Disable the function from your Bluetooth device. The Bluetooth device will be disconnected from the soundbar after the "**Disconnected**" voice prompt.
- Press and hold the "**BT/PAIR**" button on the remote control.

NFC (Near Field Communication) Operation

Pair your NFC-enabled mobile device directly with this unit by just a single tap.

1. Activate NFC on your mobile device and press the **SOURCE** button repeatedly on the unit or press the **BT** (Bluetooth) button on the remote control to select **Bluetooth** mode.
2. Tap and hold your mobile device on the NFC Sensing Area of the unit. Prompting you to pair the unit with your device. The unit will sound "**Paired**" and the **Blue** indicator will light up solidly while the pairing succeeds.
3. You can operate playback features via your mobile device.
4. To disconnect your mobile device, tap and hold again on the NFC Sensing Area of the unit. The unit will sound "**Disconnected**" and the **Blue** indicator will flash slowly.

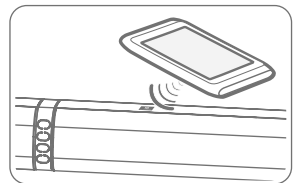

NOTE:

- The NFC function only works with mobile devices that support NFC technology.
- You may need to remove your mobile device case to connect using NFC.

Tips:

- Enter "0000" for the password if necessary.
- If no other Bluetooth device pairs with this player within two minutes, the player will recover its previous connection.
- The player will also be disconnected when your device is moved beyond the operational range.
- If you want to reconnect your device to this player, place it within the operational range.
- If the device is moved beyond the operational range, when it is brought back, please check if the device is still connected to the player.
- If the connection is lost, follow the instructions above to pair your device to the player again.

Listen to Music from Bluetooth Device

- If the connected Bluetooth device supports Advanced Audio Distribution Profile (A2DP), you can listen to the music stored on the device through the player.
- If the device also supports Audio Video Remote Control Profile (AVRCP), you can use the player's remote control to play music stored on the device.
 1. Pair your device with the player.
 2. Play music via your device (if it supports A2DP).
 3. Use supplied remote control to control play (if it supports AVRCP).
 - To pause/resume play, press the ►|| button on the remote control.
 - To skip to a track, press the ◀▶ buttons on the remote control.

Troubleshooting

To keep the warranty valid, never try to repair the system yourself. If you encounter problems when using this unit, check the following points before requesting service.

- **No power**

- Ensure that the AC cord of the apparatus is properly connected .
- Ensure that there is power at the AC outlet.
- Press standby button to turn the unit on.

- **Remote control does not work**

- Before you press any playback control button, first select the correct source.
- Reduce the distance between the remote control and the unit.
- Insert the battery with its polarities (+/-) aligned as indicated.
- Replace the battery.
- Aim the remote control directly at the sensor on the front of the unit.

- **No response from the unit**

- Disconnect and reconnect the AC power plug, then turn the unit on again.

- **I can't find the Bluetooth name of this unit on my Bluetooth device for Bluetooth pairing**

- Ensure the Bluetooth function is activated on your Bluetooth device.
- Ensure you have paired the unit with your Bluetooth device.

Specifications

Soundbar

Power Supply	AC120V~ 60Hz
Output Power	15 W x 2
Power Consumption	30 W
USB	5V= 500mA
Power consumption of standby mode	< 0.5W
The power consumption in networked standby if all wireless network ports are activated.....	2.812 W
Frequency Response	40Hz - 20KHz
Total harmonic distortion	1% (1kHz, 1W)
Audio input sensitivity.....	700mV
Unit Dimension:	
W x H x D (Horizontal)	883 x 92 X 65.5 mm
W x H x D (Stand).....	100 x 435 x 100 mm
Speakers Impedance	8 Ω x 2

Subwoofer

Power Supply.....	AC 120V~ 60Hz
Output Power.....	30 W
Power Consumption	30 W
Frequency Response	40Hz - 200Hz
Impedance.....	4 Ω
Dimension (W x H x D)	150 x 273 x 220 mm

Remote Control

Distance.....	6m
Angle	30°
Battery Type	CR2025