



# NK 12 SURROUND SOUND BAR

## Home Theatre System



## Important Safety Instructions

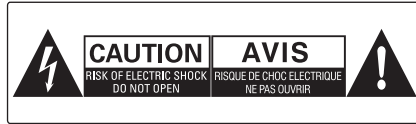

CAUTION: TO REDUCE THE RISK OF ELECTRIC SHOCK, DO NOT REMOVE COVER (OR BACK). NO USER-SERVICEABLE PARTS INSIDE. REFER SERVICING TO QUALIFIED SERVICE PERSONNEL.



The lightning flash with arrowhead symbol, within an equilateral triangle, is intended to alert the user to the presence of uninsulated "dangerous voltage" within the product's enclosure that may be of sufficient magnitude as to constitute a risk of electric shock to persons.



The exclamation point within an equilateral triangle is intended to alert the user to the presence of important operating and maintenance (servicing) instructions in the literature accompanying the appliance.

### Safety

- 1 Read these instructions - All the safety and operating instructions should be read before this product is operated.
- 2 Keep these instructions-The safety and operating instructions should be retained for future reference.
- 3 Heed all warnings - All warnings on the appliance and in the operating instructions should be adhered to.
- 4 Follow all instructions - All operating and use instructions should be followed.
- 5 Do not use this apparatus near water - The appliance should not be used near water or moisture - for example, in a wet basement or near a swimming pool and the like.
- 6 Clean only with a dry cloth.
- 7 Do not block any ventilation openings. Install in accordance with the manufacturer's instructions.
- 8 Do not install near any heat sources such as radiators, heaters, stoves, or other apparatus (including amplifiers) that produce heat.
- 9 Do not defeat the safety purpose of the polarized or grounding-type plug. A polarized plug has two blades with one wider than the other. A grounding type plug has two blades and a third grounding prong. The wide blade or the third prong are provided for your safety. If the provided plug does not fit into your outlet, consult an electrician for replacement of the obsolete outlet.
- 10 Only use attachments/accessories specified by the manufacturer.

- 11  Use only with the cart, stand, tripod, bracket, or table specified by the manufacturer, or sold with the apparatus. When a cart or rack is used, use caution when moving the cart/apparatus combination to avoid injury from tip-over.
- 12 Unplug the apparatus during lightning storms or when unused for long periods of time.
- 13 Refer all servicing to qualified personnel. Servicing is required when the apparatus has been damaged in any way, such as power supply cord or plug is damaged, liquid has been spilled or objects have fallen into the apparatus, the unit has been exposed to rain or moisture, does not operate normally, or has been dropped.
- 14  This equipment is a Class II or double insulated electrical appliance. It has been designed in such a way that it does not require a safety connection to electrical earth.

### Caution:

- Use of controls or adjustments or performance of procedures other than those described herein, may result in hazardous radiation exposure or other unsafe operation.
- To reduce the risk of fire or electric shock, do not expose this apparatus to rain or moisture. The apparatus must not be exposed to dripping or splashing and objects filled with liquids, such as vases, must not be placed on apparatus.
- The mains plug/appliance coupler is used as the disconnect device, the disconnect device must remain readily operable.

### Warning

- 1 The battery (battery or batteries or battery pack) must not be exposed to excessive heat such as sunshine, fire or the like.
- 2 Before operating this system, check the voltage of this system to see if it is identical to the voltage of your local power supply.
- 3 The ventilation should not be impeded by covering the ventilation openings with items such as newspaper, table-cloths, curtains etc. Make sure there is at least 20 cm of space above and at least 5cm of space on each side of the unit.
- 4 Do not place this unit close to strong magnetic fields.
- 5 Do not place the unit on the amplifier or receiver.
- 6 Do not place this unit close to damp areas as the moisture will affect the life of the laser head.

- 7 Should any solid object or liquid fall into the system, unplug the system and have it checked by qualified personnel before operating it any further.
  - 8 Do not attempt to clean the unit with chemical solvents as this might damage the finish. Use a clean, dry or slightly damp cloth.
  - 9 When removing the power plug from the wall outlet, always pull directly on the plug, never yank on the cord.
  - 10 No naked flame sources, such as lighted candles, should be placed on the apparatus.
  - 11 Changes or modifications to this unit not expressly approved by the party responsible for compliance will void the user's authority to operate the equipment.
- The marking label is pasted on the back or the underside of the equipment.
  - This device complies with Part 15 of the FCC Rules.  
Operation is subject to the following two conditions:
    - (1) this device may not cause harmful interference, and
    - (2) this device must accept any interference received,  
including interference that may cause undesired operation.

**FCC ID: Z8M-TB362**



**DO NOT INGEST BATTERY, CHEMICAL  
BURN HAZARD**

The remote control supplied with this product contains a coin/button cell battery. If the coin/button cell battery is swallowed, it can cause severe internal burns in just 2 hours and lead to death. Keep new and used batteries away from children. If the battery compartment does not close securely, stop using the product and keep it away from children. If you think batteries might have been swallowed or placed inside any part of the body, seek immediate medical attention.

# DESCRIPTIONS & FUNCTION

## ● SIDE PANEL

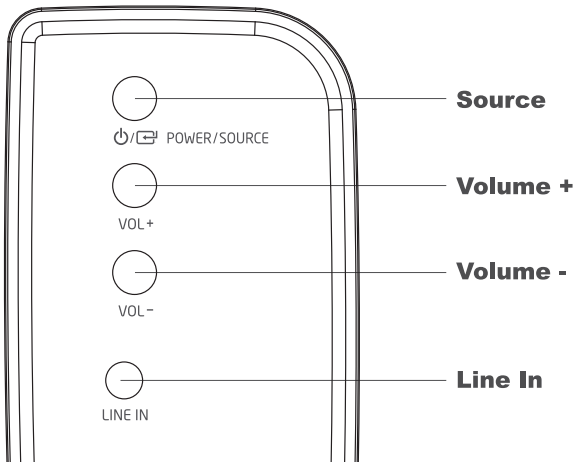

**Source:** Press the source input button until your connection type is displayed. (AUX or Optical, for example). Push repeatedly to cycle through input sources (HDMI in TV (ARC), Aux, Line-in, Optical and BT for example).

**Volume +:** Press to increase system volume.

**Volume -:** Press to decrease system volume.

**Line In:** Connect to the 3.5mm AUX-IN (Analog) output of an external device, e.g. TV, DVD or Blu-ray player.

**System Standby:** Press and hold the source button and puts the sound bar in standby mode.

## ● BACK PANEL

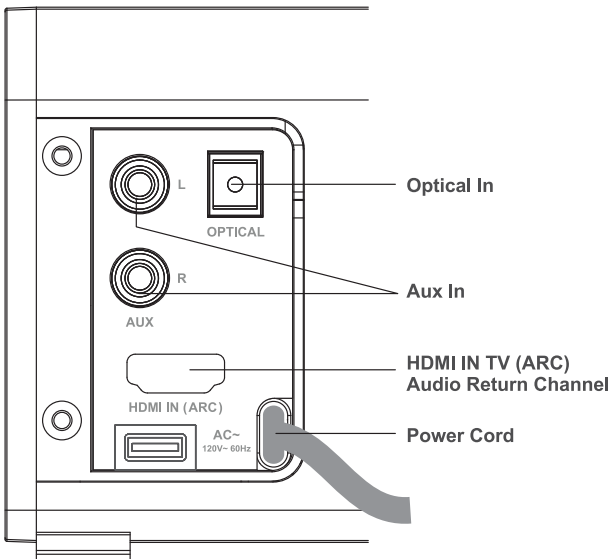

**Power Cord:** Connect the AC power plug to a wall outlet.

**Optical In:** Connect to the OPTICAL (Digital) output of an external device, e.g. TV, DVD or Blu-ray player.

**Aux In:** Connect to the RCA AUX-IN (Analog) output of an external device, e.g. TV, DVD or Blu-ray player.

**HDMI IN TV (ARC) Audio Return Channel:** Connect to the HDMI ARC (Digital) output to your ARC compliant TV. To enjoy the HDMI ARC function, please ensure your TV is both **HDMI-CEC** and **ARC compliant** and set up accordingly.

## ● BOTTOM PANEL OF WIRELESS SUBWOOFER

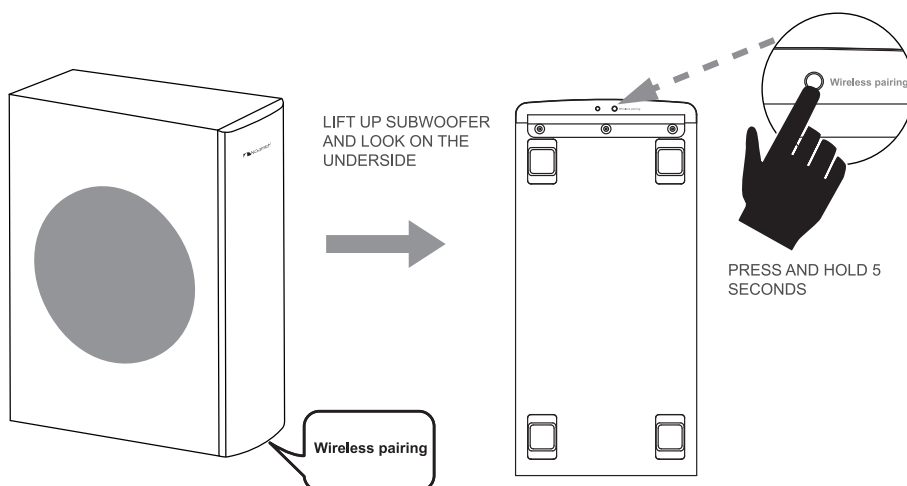

**SYNC:** Syncing the sound bar and wireless subwoofer

**The sound bar and wireless subwoofer come from the factory presets to work together.** If the subwoofer stops receiving an audio signal, follow these instructions to re-establish connection.

1. Unplug and plug-in the sub-woofer AC cable from the wall socket.
2. Press and hold the **Wireless Pairing** button on the underside of the subwoofer for five (5) seconds.
3. The LED indicator next to it will start blinking, indicating that the sound bar and subwoofer are connecting.
4. When the LED indicator stops blinking, the subwoofer and sound bar are connected and ready to use.

# REMOTE CONTROL

## USING THE REMOTE

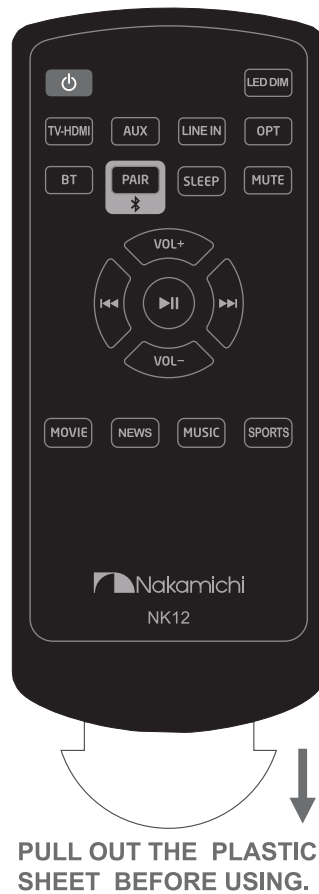

Tip: For best results, point the remote at the **right side** of the sound bar where the LED indicator is located. The sensor is located there.

If your remote stops responding, you may need to replace the battery. To replace the battery, open the battery compartment, and then replace the old battery with a new CR2025. Be sure that the + sign on the battery is facing up.

	Press to switch the sound bar ON and OFF.		In Bluetooth mode, Press to enter pairing or Bluetooth reset mode.		Volume Up. Press to increase overall system volume.
	Press to adjust the brightness of the LED display indicator.		Press to set a time to switch device off. (90 mins, 60 mins, 30 mins, 15 mins or OFF)		Volume Down. Press to decrease overall system volume.
	Press to select HDMI-IN TV (ARC) Digital input source.		Mute. Press to turn the sound on or off.		In Bluetooth mode, press to control music to PREVIOUS track.
	Press to select AUX-IN (RCA) Analog input source.		Select the MOVIE EQ effect.		
	Press to select AUX-IN (3.5mm) Analog input source.		Select the NEWS EQ effect.		In Bluetooth mode, press to control music PLAY or PAUSE.
	Press to select OPTICAL Digital input source.		Select the MUSIC EQ effect.		In Bluetooth mode, press to advance music to NEXT track.
	Press to select Bluetooth input source.		Select the SPORTS EQ effect.		

## LCD INDICATOR

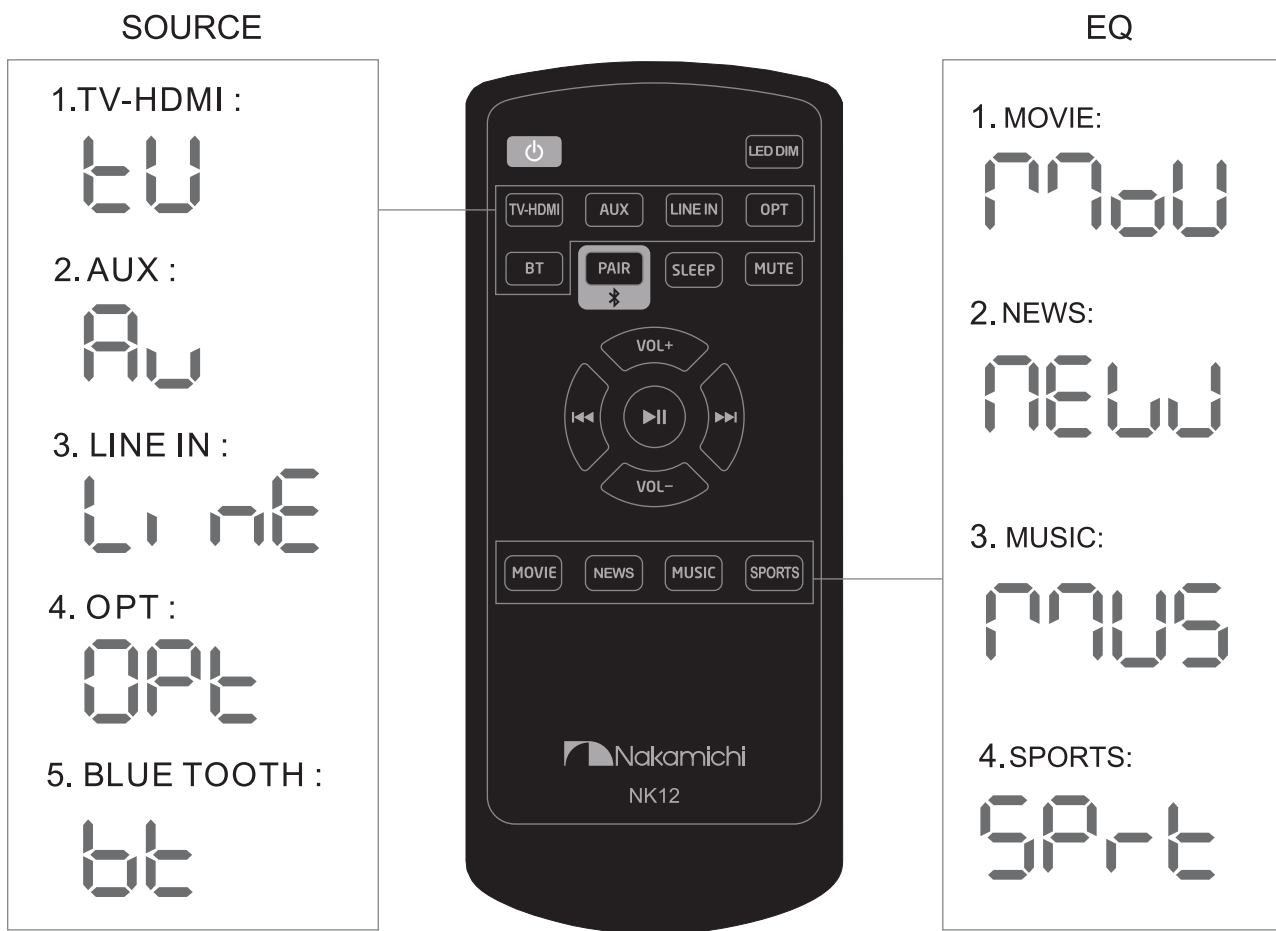

## SPECIFICATIONS

<b>Sound Bar:</b>	Two 2.25" Full-Range Drivers on each side
<b>Subwoofer:</b>	One 6.5" Driver
<b>Frequency Response (Sound Bar):</b>	150 Hz - 20 kHz
<b>Frequency Response (Subwoofer):</b>	40 Hz - 150 Hz
<b>Sound Pressure Level (SPL):</b>	90 dB
<b>Voltage (Sound Bar): Voltage:</b>	120V, 60 Hz
<b>Dimensions (Sound Bar):</b>	37.4" (W) x 3.5" (H) x 2" (D)
<b>Dimensions (Subwoofer):</b>	16.5" (W) x 12.3"(H) x 5.9" (D)
<b>Net Weight (Sound Bar):</b>	5 lbs.
<b>Net Weight (Subwoofer):</b>	11.9 lbs.

# WHERE TO LOCATE YOUR SOUND BAR FOR THE BEST SOUND

The sound bar comes with rubber feet already attached, so it will sit securely on any flat surface. Just center the bar under your TV screen. If your TV is housed in a media center, you can place the bar above the TV.

If your TV is wall mounted, the bar can mount right beneath it. The bar has built-in slots that make it easy.

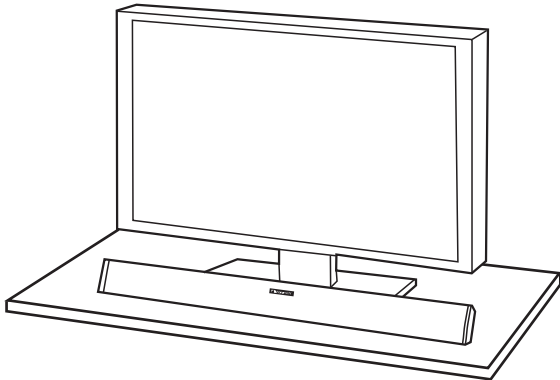

Shelf mounted sound bar sits in front of TV

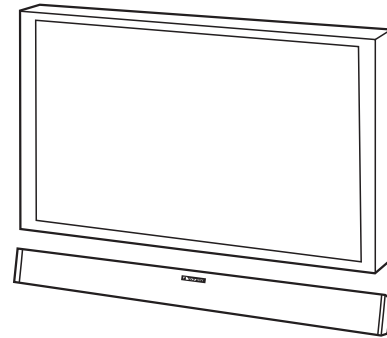

Wall mounted sound bar

## INSTALLING THE WALL MOUNT

Identify mounting location to the wall using supplied drywall screws and brackets. Attached one end first then pivot until it is level.

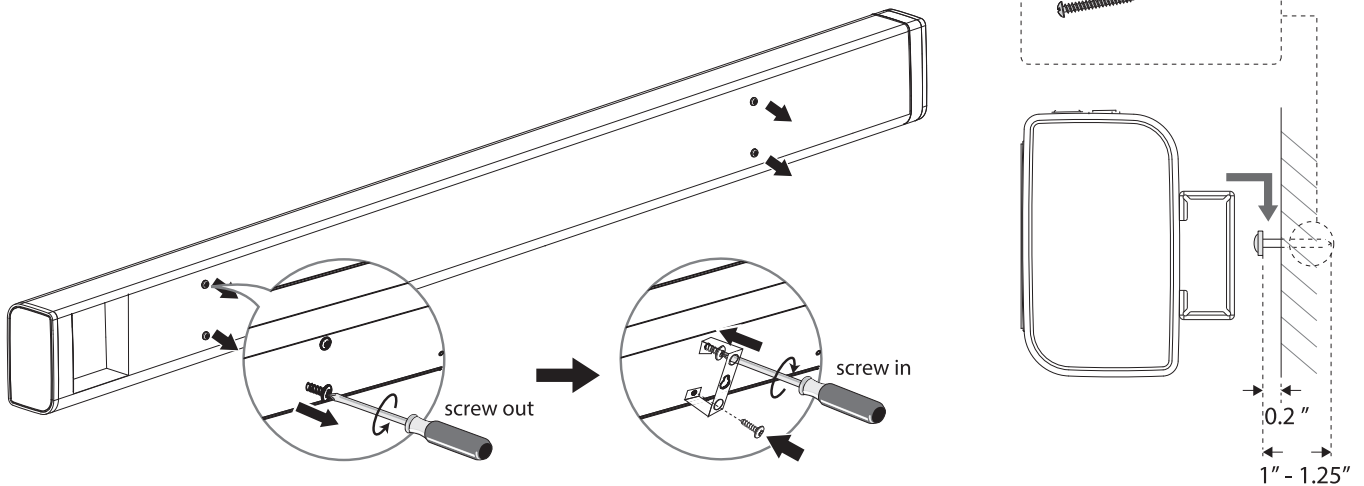

(\* Illustration may vary slightly from those shown.)

## INSTALLATION PRECAUTIONS

- Install on a vertical wall only.
- For the installation, avoid a location with high temperature or humidity, or a wall that cannot sustain the weight of the set.
- Check the strength of the wall. If the wall is not strong enough to support the unit, reinforce the wall or install the unit on different wall that can support the unit's weight.

- Purchase and use the fixing screws or molly appropriate for the kind of wall you have (plaster board, iron board, wood, etc.). If possible, fix the support screws into wall studs.
- Connect cables from the unit to external devices before you install it on the wall.
- Make sure the unit is turned off and unplugged before you install it. Otherwise, it may cause an electric shock.

# HOW TO CONNECT YOUR SOUND BAR

## RECOMMENDED HOOK UP: OPTICAL

**Optical Cable:** Remove the protective cap prior to inserting

Tip: If there is no sound come out from the sound bar, make sure the audio setting of your source player (e.g. TV, DVD, Blu-ray player or video game console) is set to PCM with OPTICAL input.

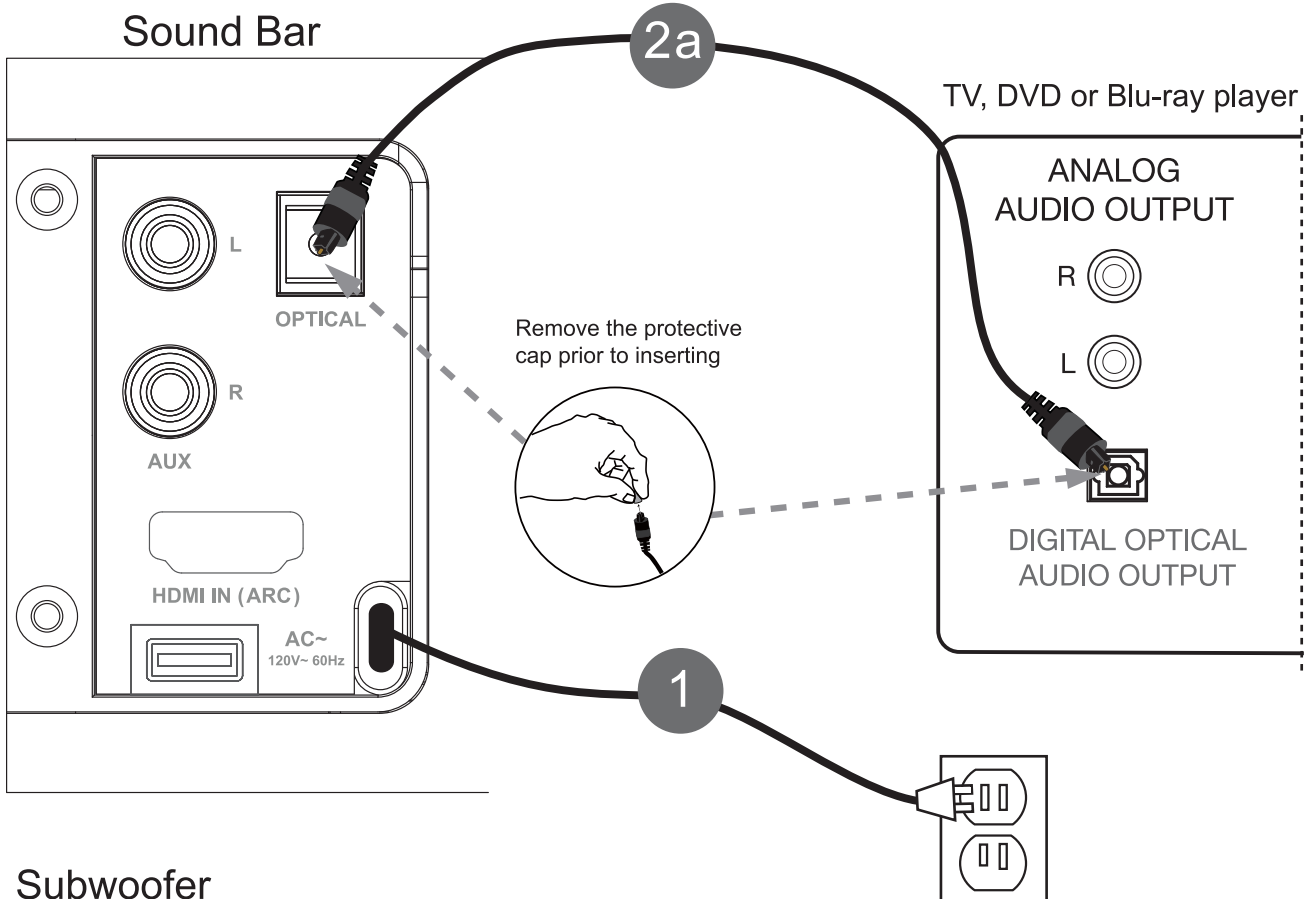
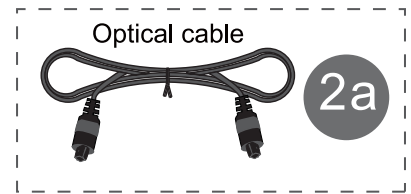

### Subwoofer

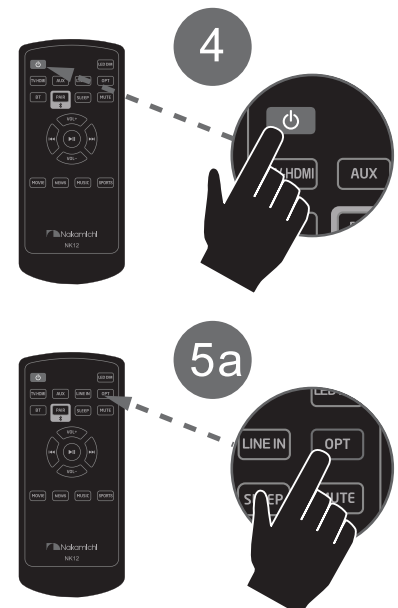
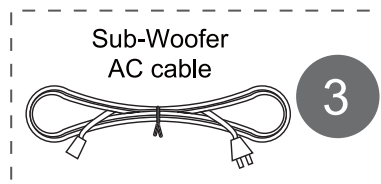
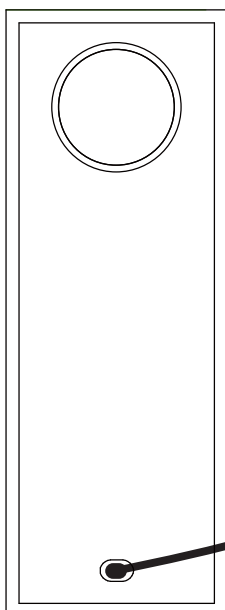



# HOW TO CONNECT YOUR SOUND BAR

## ALTERNATE HOOK UP: AUX-IN (RCA)

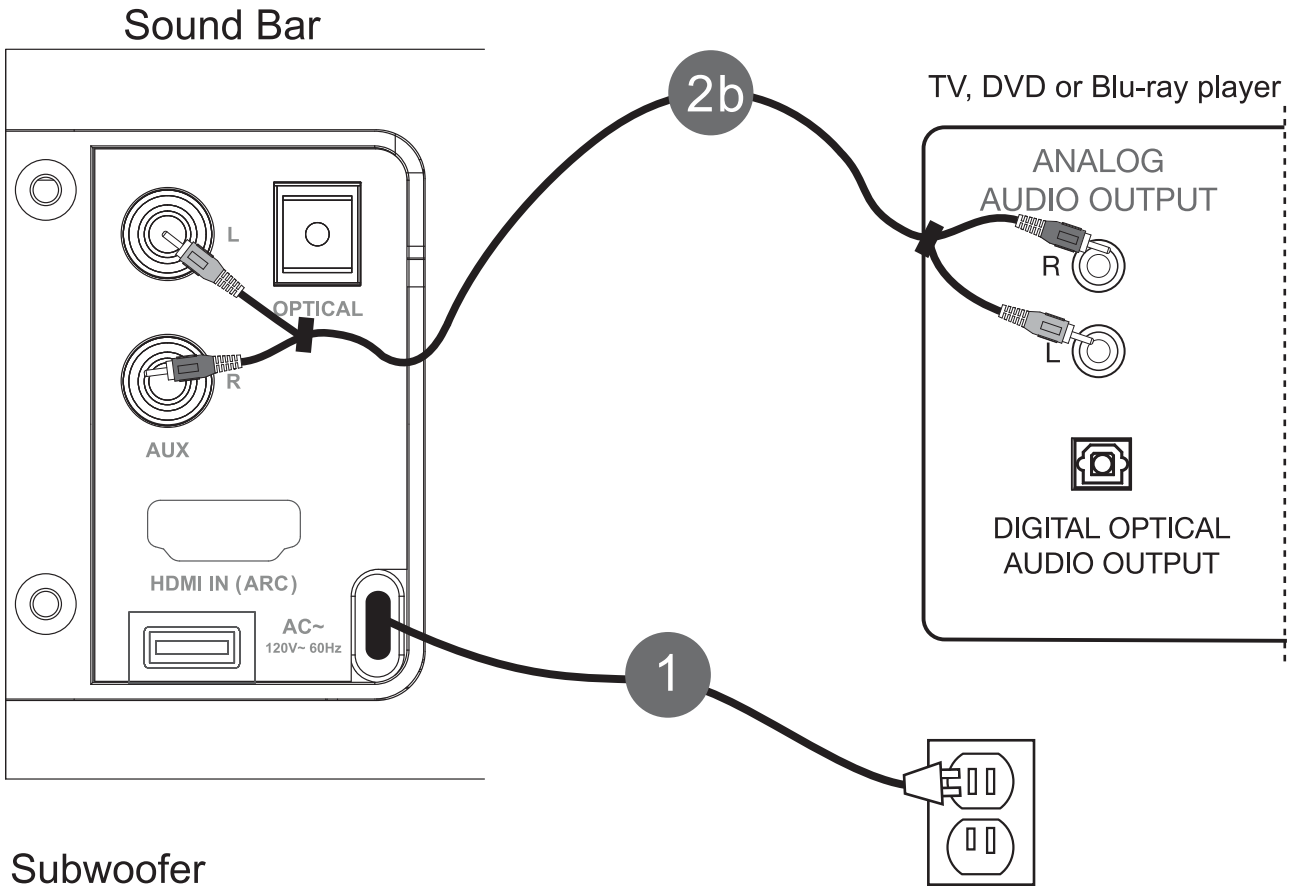
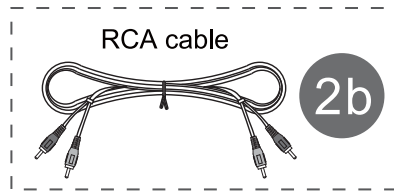

### Subwoofer

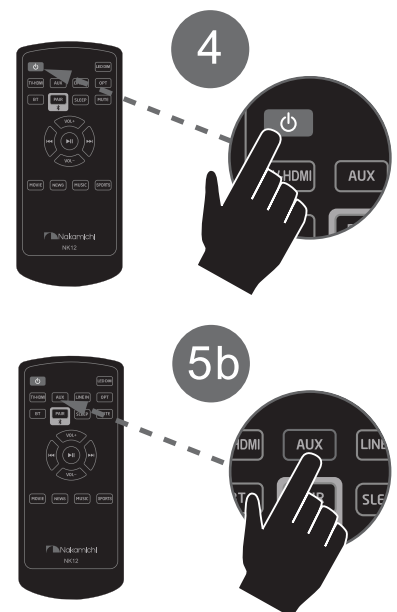
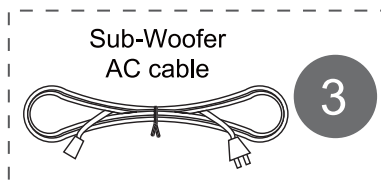
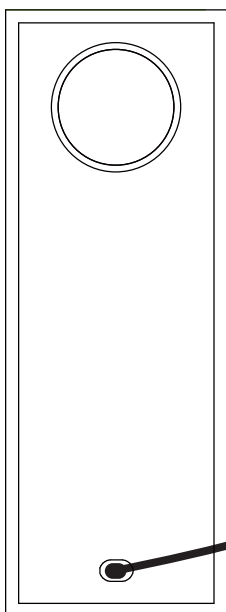

## HOW TO CONNECT YOUR SOUND BAR

### USE THE HDMI-IN TV (ARC) HOOK UP:

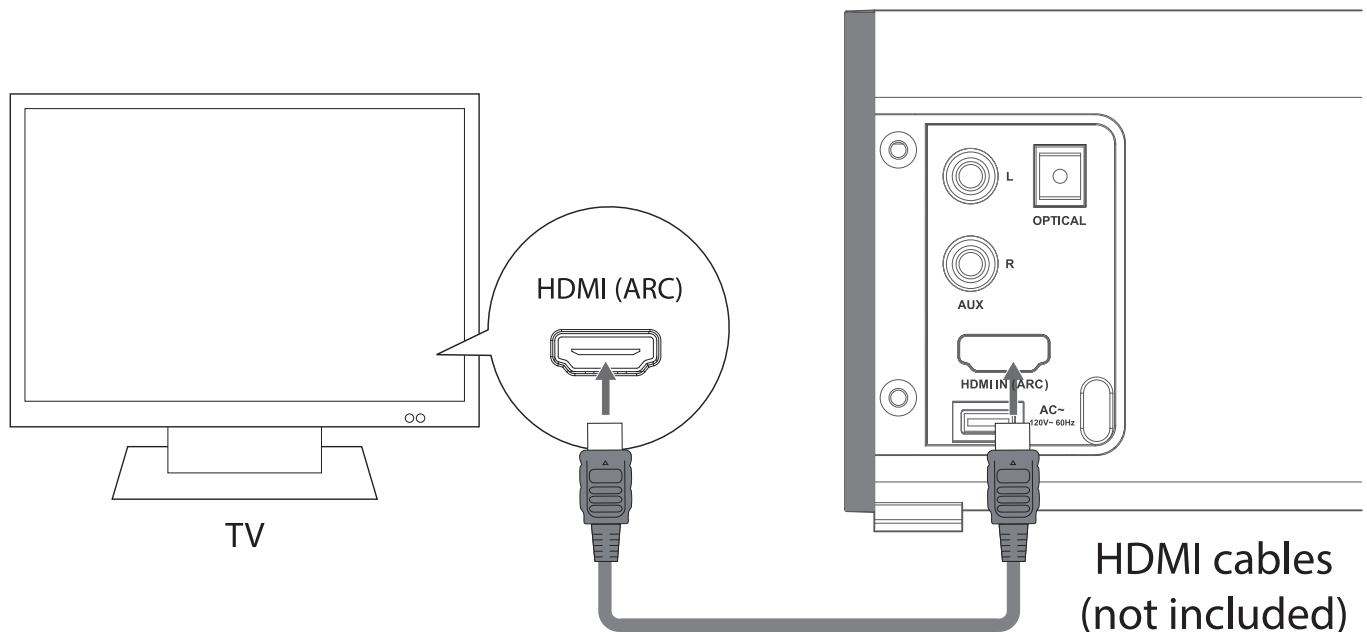

The ARC (Audio Return Channel) function allows you to send audio from your ARC- compliant TV to your sound bar through a single HDMI connection. To enjoy the ARC function, please ensure your **TV is both HDMI-CEC and ARC compliant** and set up accordingly. When correctly set up, you can use your TV remote control to adjust the volume output (VOL +/- and MUTE) of the sound bar.

**- Ensure to use an HDMI cables that can support the ARC function.**

( HDMI-CEC will be called different names by different manufacturers - please refer to your owner's manual for details on setting up HDMI-CEC and ARC.)

Connect the HDMI cable from your sound bar's HDMI In TV (ARC) socket to the HDMI (ARC) socket on your ARC- compliant TV. Then press the remote to select TV-HDMI.

## HOW TO CONNECT YOUR SUBWOOFER

Your subwoofer receives a wireless audio signal from the sound bar, so all you need to do is plug in the power cord and make sure the main power switch is ON.

### WHERE TO LOCATE YOUR SUBWOOFER FOR THE BEST SOUND

Your wireless subwoofer is really easy to place and can go just about anywhere in the room. Plus you don't have to worry about connecting wires, because the only wire you have to plug in is the power cord. And that's it.

**Here's a little trick:** If you place your subwoofer in a corner of your room, it will reinforce the subwoofer's output, making it sound louder.

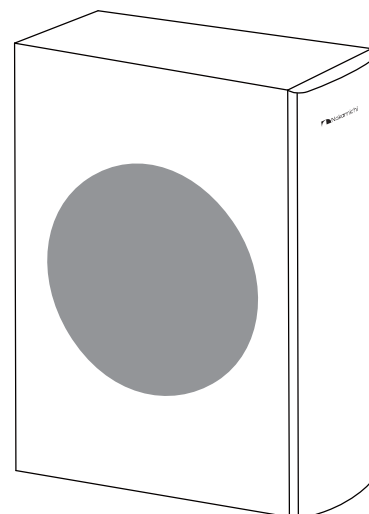

## CONNECTING THE WIRELESS SUBWOOFER

The sound bar and wireless subwoofer come from the factory presets to work together. If the subwoofer stops receiving an audio signal, follow these instructions to re-establish connection.

1. Unplug and plug-in the sound bar's AC cable from the wall socket.
2. Unplug and plug-in the sub-woofer's AC cable from the wall socket.
3. Press and hold the Wireless Pairing button on the underside of the subwoofer for five (5) seconds.
4. The LED indicator next to it will start blinking, indicating that the sound bar and subwoofer are connecting.
5. When the LED indicator stops blinking, the subwoofer and sound bar are connected and ready to use.

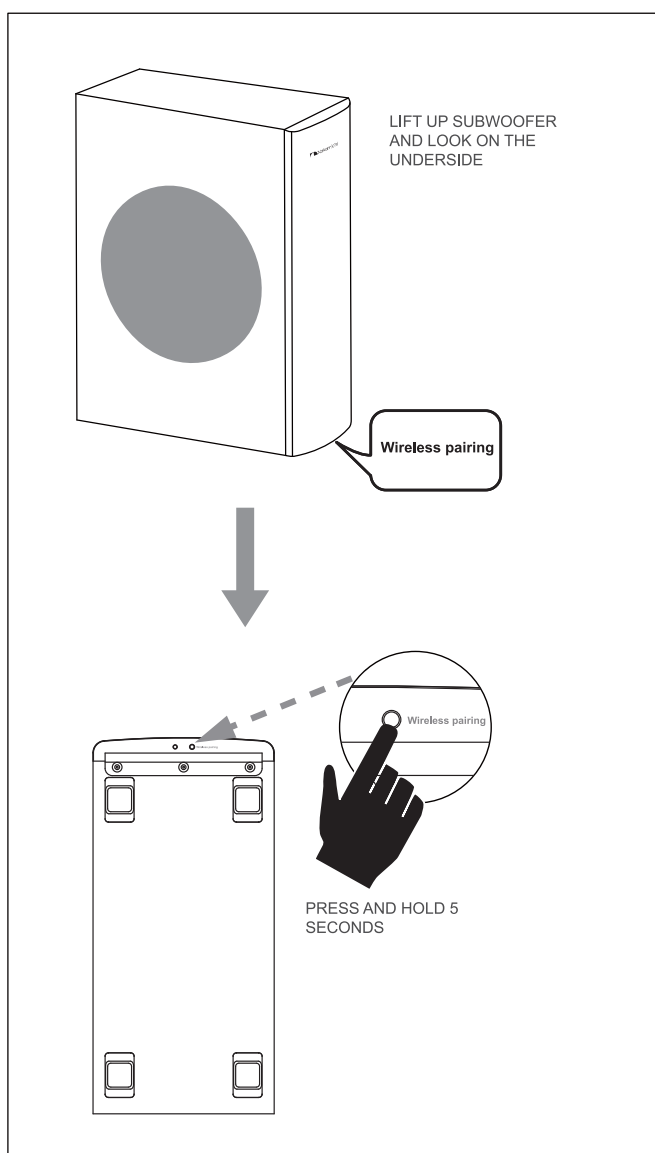

### Warning:

The wireless receiving antenna is built into the wireless subwoofer. Keep the unit away from water and moisture. The best range of wireless signal reception is within 23 ft. in a room with no wireless signal interference, such as microwave, WLAN hub, and/or other 2.4G wireless product nearby.

## LISTENING TO THE TV SOUND FROM THE SOUND BAR

Control the volume of TV by adjusting your sound bar.

1. Turn on the sound bar, or make sure TV is in standby mode.
2. Turn on the TV.
3. Adjust the volume of the sound bar.  
Control the volume of TV by adjusting the TV volume.

If the sound output jack of the TV can be set to "Variable", the volume of the sound bar can be changed by adjusting the TV volume. For TV settings, refer to the operating instruction of the TV.

1. Set the sound output jack of the TV to "Variable".
2. Adjust the volume of the unit according to the TV.
3. Adjust the volume of the sound bar.

## SELECTING THE SOUND FIELD

Press the EQ button on the remote control to select the EQ you want to use.

Four Audio Immersion Modes (MOVIE, NEWS, MUSIC and SPORTS) enable you to tailor the NK12 for maximum high performance audio for a more immersive, more thrilling listening experience.

## BLUETOOTH PAIRING PROCESS

### BLUETOOTH

You can use a Bluetooth device to enjoy music with high quality stereo sound, all without wires!

### What is Bluetooth?

Bluetooth is a technology that enables Bluetooth-compliant devices to interconnect easily with each other using a short wireless connection.

- A Bluetooth device may cause noise or malfunction, depending on usage, when:
    - A part of your body is in contact with the receiving/transmitting system of the Bluetooth device or the Nakamichi NK 12.
    - It is subject to electrical variation from obstructions caused by a wall, corner, or office partition.
    - It is exposed to electrical interference from same frequency-band devices including medical equipment, microwave ovens, and wireless LANs.
  - Pair the Nakamichi NK 12 with the Bluetooth device while they are close together.
  - The further the distance is between Nakamichi NK 12 and Bluetooth device, the worse the quality is.
- If the distance exceeds the **Bluetooth operational range of 33 feet**, the connection is lost.
- In poor reception-sensitivity areas, the Bluetooth connection may not work properly.
  - The Bluetooth connection only works when it is close to the set. The connection will be automatically cut off if the Bluetooth device is out of range. Even within range, the sound quality may be degraded by obstacles such as walls or doors.
  - This wireless device may cause electric interference during its operation.

**Check if the Bluetooth device supports the Bluetooth compliant stereo headset function.**

## Pairing Bluetooth from remote control

1. Press the BT button on the remote control to display the bt message on the sound bar.

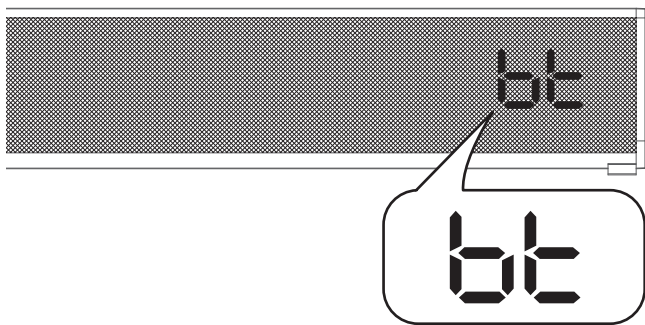

2. The orange bt indicator on LCD screen starts blinking to enter pairing mode.
3. Turn on your Bluetooth device to connect. Select the Bluetooth domain name: NK 12 to connect.
4. There is NO password required. After the "Paired" voice prompt, the system is successfully connected.
5. Play music from the connected device. You can listen to the music playing on your connected Bluetooth device over the Nakamichi NK 12.

## To disconnect the Bluetooth device or reset Bluetooth pairing from Nakamichi NK12.

You can disconnect the Bluetooth device or reset Bluetooth pairing from NK 12.

- Press the PAIR button from the remote, the Bluetooth device will be disconnected from the sound bar.
- When the NK 12 is disconnected from the Bluetooth device the NK 12 will display flashing "bt" symbol on the front LCD display with a "Disconnected" voice prompt.

To reconnect Bluetooth device to NK 12, repeat step: "Pairing Bluetooth from remote control."

## TROUBLESHOOTING

### The Sound bar does not power on.

- Ensure you have plugged the power supply into a live wall outlet.
- Ensure that all components of the power supply are connected properly.
- Ensure the power supply is properly connected to the sand bar power input.
- Press the POWER button on the remote control.

### The subwoofer does not power on.

- Ensure the subwoofer is plugged into a live wall outlet.

### No sound from the bar.

- Check that the TV, Blue-ray, DVD player or cable box is providing a signal.
- If necessary, check using an alternate source.
- Check that the sound bar is receiving power and is turned on.
- Turn up the volume of the sound bar.
- Check the input cables to make sure they are connected securely.
- Turn up the volume of your television or cable box.
- Check mute status: If so, press the MUTE button on the bar.

### No sound from the subwoofer.

- Is the subwoofer status indicator blinking? If so, the bar and subwoofer's wireless connection has been lost. Turn off both the bar and subwoofer. Then turn them back on to re-establish communication. If this does not fix the issue, refer to the section "CONNECTING THE WIRELESS SUBWOOFER".

### The sound coming from the bar is distorted.

- Try turning down the volume of your audio source, if possible.
- Audio processing (see FAQ's)—there may be audio processing occurring prior to reaching the sound bar. Disable this processing.

### The included remote control won't work.

- Ensure the battery's protective plastic tab has been removed.
- Replace the battery (CR2025).

### Bass output is not loud enough.

- Turn up the sound bar's volume using the remote control.
- Place the subwoofer closer to a corner of the room.
- Move subwoofer closer to viewing location within the room.
- Switch to a different EQ mode.

### The subwoofer's output is intermittent, or sounds weak or is distorted.

- The wireless subwoofer could be too far away from the bar to receive a sufficiently strong signal. Try moving the subwoofer closer.

## FAQ'S (FREQUENTLY ASKED QUESTIONS)

### My TV does not have an optical output. How do I connect my audio?

Use the RCA audio outputs (white/red pair) on your TV (if available) and connect directly to the Sound Bar NK12 using the supplied RCA cable.

### My audio sounds strange and distorted.

Your Nakamichi NK 12 requires a clean, unaltered stereo signal for proper audio performance. If the sound from your Nakamichi NK 12 is strange or distorted, then check the audio menus of whatever source(s) are connected to your Nakamichi NK 12 and make sure any audio processing is turned off.

To contact customer support:

Email: [support@nakamichi-usa.com](mailto:support@nakamichi-usa.com)

## A NOTE REGARDING WIRELESS PERFORMANCE

Like all wireless devices, your Nakamichi NK12 may be susceptible to RF interference from such sources as microwave ovens, Wi-Fi computer systems, video game systems, cordless telephones, blue tooth systems, baby monitors and other devices. In particular, any devices operating in the 2.4GHz band may cause intermittent wireless connections between the Nakamichi NK 12 sound bar and the subwoofer. It is also possible that your Nakamichi NK12 Home Theatre System may affect other wireless systems. For the most part, you can avoid wireless performance problems by physically separating these devices from your Nakamichi NK12 Home Theatre System. Maintaining a distance of several feet or more between your Nakamichi NK12 sound bar and any wireless device should prevent any mutual interference effects. If you do notice any subwoofer signal dropouts take care to identify the root cause (most commonly having other wireless devices too close) and resolve accordingly. Any interference effects from a microwave oven will cease once the oven stops operating and may be resolved on a long-term basis by increasing the physical distance between your Nakamichi NK12 Home Theatre System and the microwave oven.

## FCC warning.

Changes or modifications to this unit not expressly approved by the party responsible for compliance could void the user's authority to operate the equipment.

## FCC statement

**NOTE:** This equipment has been tested and found to comply with the limits for a Class B digital device, pursuant to Part 15 of the FCC Rules. These limits are designed to provide reasonable protection against harmful interference in a residential installation. This equipment generates, uses and can radiate radio frequency energy and, if not installed and used in accordance with the instructions, may cause harmful interference to radio communications.

However, there is no guarantee that interference will not occur in a particular installation. If this equipment does cause harmful interference to radio or television reception, which can be determined by turning the equipment off and on, the user is encouraged to try to correct the interference by one or more of the following measures:

- Reorient or relocate the receiving antenna.
- Increase the separation between the equipment and receiver.
- Connect the equipment into an outlet on a circuit different from that to which the receiver is connected.
- Consult the dealer or an experienced radio/TV technician for help.



## LIMITED WARRANTY (U.S.Only)

Nakamichi Corporation USA (“Nakamichi”) warrants to the original retail purchasers (the “Original Purchasers”) only. The Original Purchasers refer to the purchasers who purchase this Product from Nakamichi’s authorized retailers (“Nakamichi Retailers”). This warranty will terminate automatically prior to its stated expiration if the Original Purchaser sells or transfers this Product to any other party. Nakamichi warrants that the LOUDSPEAKER(S), PASSIVE CROSSOVER COMPONENT(S) and ENCLOSURE on this Product will be free from defects in materials and workmanship for a period of one (1) year from the date of original retail purchase from Nakamichi Retailer. Furthermore, Nakamichi warrants that any AMPLIFIER OR OTHER ELECTRONIC COMPONENT that may be included in this Product will be free from defects in materials and workmanship for a period of one (1) year from the date of original retail purchase from Nakamichi Retailer. Defective Products must be shipped, together with proof of purchase in the form of original sales receipts from Nakamichi or Nakamichi’s Retailer showing the Product Name and date of purchase, freight and insurance prepaid, to Nakamichi’s Support Centre at 2645 Brooklyn Queens Expressway W., Woodside, NY 12377. This Product must be shipped in either its original packaging or packaging of affording equal degree of protection; in any case the risk of loss or damage in transit is to be borne by you.

If upon examination at Nakamichi’s Support Centre it is determined that the unit was defective in materials or workmanship at anytime during this Warranty period, Nakamichi will, at its option, repair or replace this Product at no additional charge, except as set forth below. All replaced parts and Products become the property of Nakamichi. Products replaced or repaired under this warranty will be returned to you, within a reasonable time, freight prepaid. This warranty does not include service or parts to repair damage caused by accident, disaster, acts of GOD, misuse, abuse, negligence, inadequate packing or shipping procedures, commercial use, voltage inputs in excess of the rated maximum of the unit, cosmetic appearance of cabinetry not directly attributable to defect in materials or workmanship, or service, repair, or modification of the Product which has not been authorized or approved by Nakamichi. This warranty shall terminate if the serial number on the Product has been removed, tampered with or defaced.

There are no other express or implied warranties. Nakamichi’ liability is limited to repair or, at its sole option, replacement of this Product. Incidental, special and consequential damages are disclaimed where permitted by law. This Warranty applies only to Products purchased in the United States of America.

### CUSTOMER SUPPORT

Thank you for your purchase of this Product. If you have any question or comment, please visit our website at [www.nakamichi-usa.com/support](http://www.nakamichi-usa.com/support) or email them to [support@nakamichi-usa.com](mailto:support@nakamichi-usa.com).

Nakamichi Corporation USA  
2645 Brooklyn Queens Expressway W., Woodside, NY 12377

---

---

## Model: TB361, TB362

---

---

<b>Important Safety Instructions .....</b>	<b>2</b>
Safety.....	2
Warning.....	2
<b>Identifying the Parts .....</b>	<b>4</b>
Main Unit .....	4
Remote Control .....	5
<b>Preparations.....</b>	<b>6</b>
Prepare the Remote Control.....	6
Replace the Remote Control Battery .....	6
Wall Mounting .....	7
<b>Connections .....</b>	<b>8</b>
Use the HDMI Socket.....	8
Use the OPTICAL/COAXIAL Socket.....	8
Use the AUX Socket.....	8
Use the MP3 Link Socket .....	8
Connect Power .....	9
<b>Pairing the Wireless Subwoofer with the Main Unit .....</b>	<b>9</b>
1. Automatic Pairing .....	9
2. Manual Pairing.....	9
<b>Basic Operation .....</b>	<b>9</b>
Standby/ON.....	9
Select Modes.....	10
Adjust the Volume.....	10
Select a Preset Sound Effect.....	10
Adjust Brightness .....	10
<b>AUX/MP3 LINK/OPTICAL/COAXIAL/HDMI Operation .....</b>	<b>10</b>
<b>Play with Bluetooth Device.....</b>	<b>10</b>
Pair Bluetooth-enabled Devices .....	10
NFC (Near Field Communication) Operation.....	11
Listen to Music from Bluetooth Device.....	11
<b>Troubleshooting .....</b>	<b>12</b>
<b>Specifications.....</b>	<b>13</b>
<b>Standard Accessories .....</b>	<b>13</b>

## Important Safety Instructions

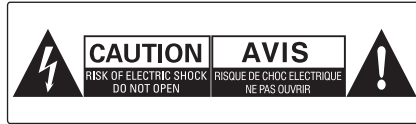

CAUTION: TO REDUCE THE RISK OF ELECTRIC SHOCK, DO NOT REMOVE COVER (OR BACK). NO USER-SERVICEABLE PARTS INSIDE. REFER SERVICING TO QUALIFIED SERVICE PERSONNEL.



The lightning flash with arrowhead symbol, within an equilateral triangle, is intended to alert the user to the presence of uninsulated "dangerous voltage" within the product's enclosure that may be of sufficient magnitude as to constitute a risk of electric shock to persons.



The exclamation point within an equilateral triangle is intended to alert the user to the presence of important operating and maintenance (servicing) instructions in the literature accompanying the appliance.

### Safety

- 1 Read these instructions - All the safety and operating instructions should be read before this product is operated.
- 2 Keep these instructions-The safety and operating instructions should be retained for future reference.
- 3 Heed all warnings - All warnings on the appliance and in the operating instructions should be adhered to.
- 4 Follow all instructions - All operating and use instructions should be followed.
- 5 Do not use this apparatus near water - The appliance should not be used near water or moisture - for example, in a wet basement or near a swimming pool and the like.
- 6 Clean only with a dry cloth.
- 7 Do not block any ventilation openings. Install in accordance with the manufacturer's instructions.
- 8 Do not install near any heat sources such as radiators, heaters, stoves, or other apparatus (including amplifiers) that produce heat.
- 9 Do not defeat the safety purpose of the polarized or grounding-type plug. A polarized plug has two blades with one wider than the other. A grounding type plug has two blades and a third grounding prong. The wide blade or the third prong are provided for your safety. If the provided plug does not fit into your outlet, consult an electrician for replacement of the obsolete outlet.
- 10 Only use attachments/accessories specified by the manufacturer.

- 11  Use only with the cart, stand, tripod, bracket, or table specified by the manufacturer, or sold with the apparatus. When a cart or rack is used, use caution when moving the cart/apparatus combination to avoid injury from tip-over.
- 12 Unplug the apparatus during lightning storms or when unused for long periods of time.
- 13 Refer all servicing to qualified personnel. Servicing is required when the apparatus has been damaged in any way, such as power supply cord or plug is damaged, liquid has been spilled or objects have fallen into the apparatus, the unit has been exposed to rain or moisture, does not operate normally, or has been dropped.
- 14  This equipment is a Class II or double insulated electrical appliance. It has been designed in such a way that it does not require a safety connection to electrical earth.

### Caution:

- Use of controls or adjustments or performance of procedures other than those described herein, may result in hazardous radiation exposure or other unsafe operation.
- To reduce the risk of fire or electric shock, do not expose this apparatus to rain or moisture. The apparatus must not be exposed to dripping or splashing and objects filled with liquids, such as vases, must not be placed on apparatus.
- The mains plug/appliance coupler is used as the disconnect device, the disconnect device must remain readily operable.

### Warning

- 1 The battery (battery or batteries or battery pack) must not be exposed to excessive heat such as sunshine, fire or the like.
- 2 Before operating this system, check the voltage of this system to see if it is identical to the voltage of your local power supply.
- 3 The ventilation should not be impeded by covering the ventilation openings with items such as newspaper, table-cloths, curtains etc. Make sure there is at least 20 cm of space above and at least 5cm of space on each side of the unit.
- 4 Do not place this unit close to strong magnetic fields.
- 5 Do not place the unit on the amplifier or receiver.
- 6 Do not place this unit close to damp areas as the moisture will affect the life of the laser head.



- 7 Should any solid object or liquid fall into the system, unplug the system and have it checked by qualified personnel before operating it any further.
- 8 Do not attempt to clean the unit with chemical solvents as this might damage the finish. Use a clean, dry or slightly damp cloth.
- 9 When removing the power plug from the wall outlet, always pull directly on the plug, never yank on the cord.
- 10 No naked flame sources, such as lighted candles, should be placed on the apparatus.
- 11 Changes or modifications to this unit not expressly approved by the party responsible for compliance will void the user's authority to operate the equipment.

- The marking label is pasted on the back or the underside of the equipment.
- This device complies with Part 15 of the FCC Rules.

Operation is subject to the following two conditions:

- (1) this device may not cause harmful interference, and
- (2) this device must accept any interference received, including interference that may cause undesired operation.

**FCC ID: Z8M-TB362**

 **DO NOT INGEST BATTERY, CHEMICAL BURN HAZARD**

The remote control supplied with this product contains a coin/button cell battery. If the coin/button cell battery is swallowed, it can cause severe internal burns in just 2 hours and lead to death. Keep new and used batteries away from children. If the battery compartment does not close securely, stop using the product and keep it away from children. If you think batteries might have been swallowed or placed inside any part of the body, seek immediate medical attention.

## Identifying the Parts

### Main Unit

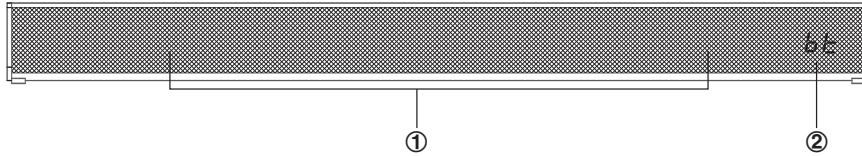

#### 1 Speakers

#### 2 Display Window / Remote Control Sensor

Show the current status.

Receive signal from the remote control.

#### 3

Press this button to switch the unit on or press and hold to switch to Standby mode.

Select the play function.

#### 4 VOL+/VOL-

Increase/decrease the volume level.

#### 5 MP3 LINK Socket

Connect to an external audio device.

#### 6

NFC (Near Field Communication) sensor.

#### 7 USB Socket

#### 8 OPTICAL Socket

Connect to an external audio device.

#### 9 AUX (L/R) Socket

Connect to an external audio device.

#### 10 HDMI (ARC) Socket

#### 11 Power Cord

#### 12 FM ANTENNA

#### 13 COXIAL Socket

Connect to an external audio device.

### Side View

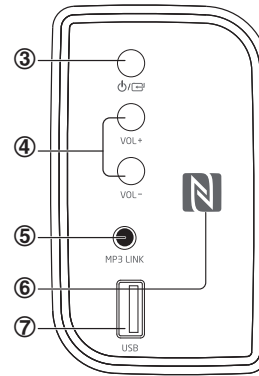

### Rear View

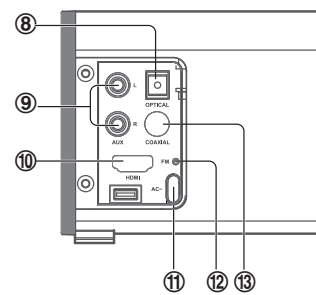

## Remote Control

- 1**   
Switch the unit between ON and STANDBY mode.
- 2** **SOURCE**  
Select the play function.
- 3** **VOL+/VOL-**  
Increase/decrease the volume level.
- 4** **⏮/⏭**  
In Bluetooth mode, skip to previous/next audio file.
- 5** **▶ || / PAIR**  
In Bluetooth mode, start or pause playback.  
Activate the pairing function in Bluetooth mode and disconnect the existing paired Bluetooth device.
- 6** **DIMMER**  
Adjust display brightness.
- 7** **MUTE**  
Mute or resume the sound.
- 8** **EQ**  
Select a preset sound effect.

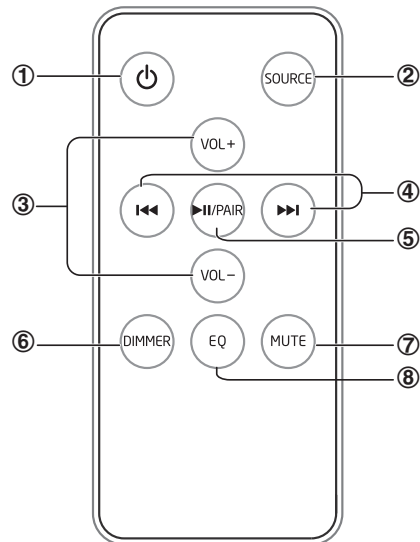

## Preparations

---

### Prepare the Remote Control

The provided Remote Control allows the unit to be operated from a distance.

- Even if the Remote Control is operated within the effective range (6m), remote control operation may be impossible if there are any obstacles between the unit and the remote control.
- If the Remote Control is operated near other products which generate infrared rays, or if other remote control devices using infra-red rays are used near the unit, it may operate incorrectly. Conversely, the other products may operate incorrectly.

### First-time use:

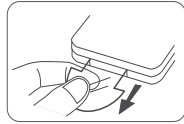

The unit has a pre-installed lithium CR2025 battery. Remove the protective tab to activate the remote control battery.

### Replace the Remote Control Battery

- 1 Pull out the battery tray and remove the old battery.
- 2 Place a new CR2025 battery into the battery tray with correct polarity (+/-) as indicated.
- 3 Insert the battery tray back into the slot.

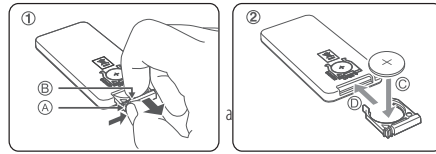

### Precautions Concerning Batteries

- 1 When the Remote Control is not to be used for long time (more than a month), remove the battery from the Remote Control to prevent it from leaking.
- 2 If the batteries leak, wipe away the leakage inside the battery compartment and replace the batteries with new ones.
- 3 Do not use any batteries other than those specified.
- 4 Do not heat or disassemble batteries.  
Never throw them in fire or water.
- 5 Do not carry or store batteries with other metallic objects. Doing so could cause batteries to short circuit, leak or explode.
- 6 Never recharge a battery unless it is confirmed to be a rechargeable type.

## Wall Mounting



- Installation must be carried out by qualified personnel only. Incorrect assembly can result in severe personal injury and property damage (if you intend to install this product yourself, you must check for installations such as electrical wiring and plumbing that may be buried inside the wall). It is the installer's responsibility to verify that the wall will safely support the total load of the Soundbar and wall brackets.
- Additional tools (not included) are required for the installation.
- Do not overtighten screws.
- Keep this instruction manual for future reference.
- Use an electronic stud finder to check the wall type before drilling and mounting.

- 2** Drill 2 parallel holes ( $\varnothing$  3-8 mm each according to wall type) in the wall. The distance between the holes should be 580 mm.

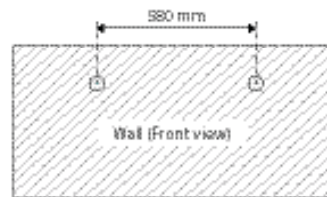

- 1** Remove the screws from the main unit. Attach the wall brackets to the main unit with the screws removed from the main unit.

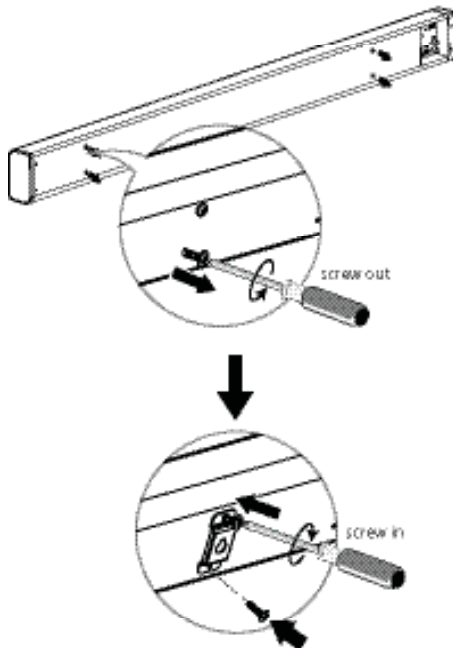

- 3** Firmly fix 1 dowel into each hole in the wall if necessary.

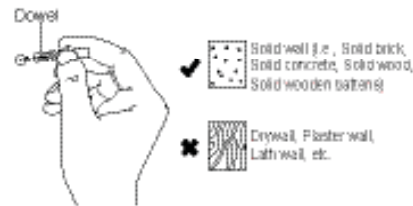

- 4** Insert 1 screw into each hole or dowel. Leave a 5 mm gap between the wall and the screw's head. Lift the unit with the attached wall brackets over the heads of the screws and slot into place.

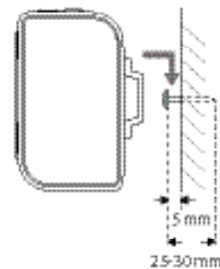

## Connections

### Use the HDMI Socket

The ARC (Audio Return Channel) function allows you to send audio from your ARC-compliant TV to your main unit through a single HDMI connection. To enjoy the ARC function, please ensure your TV is both HDMI-CEC and ARC compliant and set up accordingly. When correctly set up, you can use your TV remote control to adjust the volume output (VOL +/- and MUTE) of the main unit.

- Ensure to use an HDMI cables that can support the ARC function.
- HDMI-CEC will be called different names by different manufacturers – please refer to your owner’s manual for details on setting up HDMI-CEC and ARC.

Connect an HDMI cable from your main unit’s HDMI OUT TV (ARC) socket to the HDMI (ARC) socket on your ARC-compliant TV. You can then connect your external (e.g. games consoles, DVD players) to the main unit’s HDMI IN sockets. Then press the SOURCE button to select HDMI OUT (TV ARC) or HDMI IN mode.

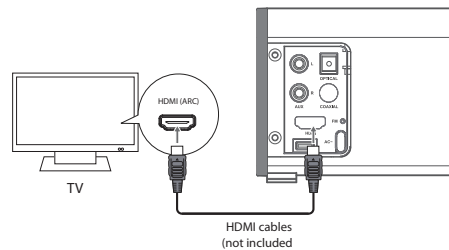

### Use the OPTICAL/COAXIAL Socket

- Remove the protective cap of the OPTICAL socket, then connect an OPTICAL cable (not included) to the TV’s OPTICAL OUT socket and the OPTICAL socket on the unit.
- Connect a COAXIAL cable (not included) to the TV’s COAXIAL OUT socket and the COAXIAL socket on the unit.

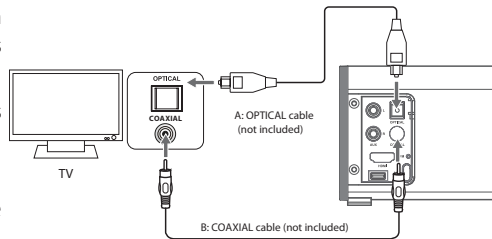

#### Tip:

If there is no sound come out of the soundbar . Make sure the audio setting of your source player (e.g. DVD player, game player, TV) is setted to PCM with OPTICAL or COAXIAL input.

### Use the AUX Socket

- Use a RCA to RCA audio cable (included) to connect the TV’s audio output sockets to the AUX (R/L) socket on the unit.
- Use a RCA to 3.5mm audio cable (not included) to connect the TV’s headphone socket to the AUX (R/L) socket on the unit.

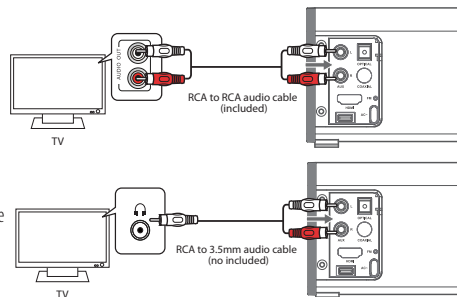

### Use the MP3 Link Socket

- Use a 3.5mm to 3.5mm audio cable (no included) to connect the external audio device headphone socket to the MP3 LINK socket on the unit.

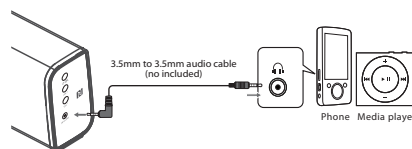

## Connect Power

### Risk of product damage!

- Ensure that the power supply voltage corresponds to the voltage printed on the back or the underside of the unit.
- Before connecting the AC power cord, ensure you have completed all other connections.
- Connect the mains plug of the main unit to a mains socket.
- Connect the mains plug of subwoofer to the wireless subwoofer and to a mains socket.

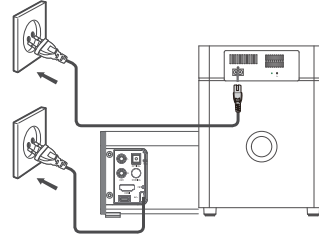

## Pairing the Wireless Subwoofer with the Main Unit

### 1. Automatic Pairing

Plug the main unit and the subwoofer into the mains sockets and then press STANDBY button on the unit or on the remote control to switch the unit to ON mode. Then the subwoofer and main unit will automatically pair within 30 seconds.

- When the subwoofer is pairing with the main unit, the Pair Indicator will flash rapidly.
- When the subwoofer is paired with the main unit, the Pair Indicator will light up.
- During Standby mode, the subwoofer Pair indicator will off and flash slowly. Press STANDBY button to switch the unit ON.

Note: Do not press Pair on the rear of the subwoofer, except for manual pairing.

### 2. Manual Pairing

Note: It is very abnormal that the connection would fail, you should not attempt manual pairing in normal usage.

If the automatic pairing fails and the word "CHECK SUBWOOFER" showed on the display, ensure that all the cables are well connected, the main unit is switched to ON mode and the Pair indicator is flashing. If it still doesn't work, pair the subwoofer with the main unit manually.

1. Unplug both units from the mains sockets again, then plug them in again after 3 minutes.
2. Press and hold the Pair button on the rear of the subwoofer for a few seconds, and then press STANDBY button on the main unit or on the remote control to switch the unit ON. The Pair indicator on the subwoofer will rapidly blink when pairing and will become solid when successful.





Note:

- After connecting the power, you must press PAIR on the subwoofer within 20 seconds to be effective.
- The subwoofer should be within 4 m of the main unit in an open area (the closer the better).
- Remove any objects between the subwoofer and the main unit.
- If the wireless connection fails again, check if there is conflict or strong interference (e.g. interference from an electronic device) around the location. Remove these conflicts or strong interferences and repeat the above procedures.

## Basic Operation

### Standby/ON

When you first connect the main unit to the mains socket, the main unit will be in Standby mode.

- Press the  button on the main unit or the  button on the remote control to switch the main unit on.
- Press and hold the  button on the main unit or press the  button on the remote control to switch the main unit back to Standby mode.
- Disconnect the mains plug from the mains socket if you want to switch the unit off completely.
- When the unit volume is close to mute or is idle for approximately 15 minutes, it will automatically switch to Standby mode.

### Select Modes

Press the  button on the main unit or the **SOURCE** button on the remote control repeatedly to switch between **AUX, MP3 LINK, OPTICAL** and **BLUETOOTH** mode. The selected mode will show on the display.

### Adjust the Volume

- Press the **VOL +/-** button to adjust the volume.
- If you wish to turn the sound off, press the **MUTE** button on the remote control. Press the **MUTE** button again or press the **VOL +/-** button to resume normal listening.

### Select a Preset Sound Effect

While playing, press the **EQ** button on the remote control to select between preset equalisers: **FLAT, POP, ROCK**.

### Adjust Brightness

Press the **DIMMER** button on the remote repeatedly to select brightness level.

## AUX/MP3 LINK/OPTICAL/COAXIAL/HDMI Operation

- 1 Ensure that the unit is connected to the TV or audio device.
- 2 While in ON mode, press the  button repeatedly on the main unit or the **SOURCE** button on the remote control to select **AUX, MP3 LINK, COAXIAL, OPTICAL** or **HDMI** mode.
- 3 Operate your audio device directly for playback features.
- 4 Press the **VOL +/-** button to adjust the volume to your desired level.

## Play with Bluetooth Device

You can listen to tracks from a media device if connected to the unit via Bluetooth.

### Pair Bluetooth-enabled Devices

The first time you connect your bluetooth device to this player, you need to pair your device to this player.

#### Note:

- The operational range between this player and a Bluetooth device is approximately 8 meters (without any object between the Bluetooth device and the unit).
  - Before you connect a Bluetooth device to this unit, ensure you know the device's capabilities.
  - Compatibility with all Bluetooth devices is not guaranteed.
  - Any obstacle between this unit and a Bluetooth device can reduce the operational range.
  - If the signal strength is weak, your Bluetooth receiver may disconnect, but it will re-enter pairing mode automatically.
- 1 During ON mode, press the  button repeatedly on the unit or the **SOURCE** button on the remote control to select **Bluetooth** mode. "**NO BT**" will show on the display if the unit is not paired to any Bluetooth device.
  - 2 The system has entered pairing mode.
    - Or press and hold the **▶ II/PAIR** button on the remote control to be searchable.
  - 3 Activate your Bluetooth device and select the search mode. "**TB362**" will appear on your Bluetooth device list.
  - 4 Select "**TB362**" in the pairing list. Display panel shows "**BT**" while the pairing succeeds.
  - 5 To disconnect the Bluetooth function, switch to another function on the unit or disable the function from your Bluetooth device.



Tips:

- 1 Enter 0000 for the password if necessary.
- 2 If there is an existing connection, press and hold the ► ||/PAIR button on the remote control to re-activate the pairing mode, the connection will be interrupted.
- 3 If no other Bluetooth device pairs with this player within two minutes, the player will recover its previous connection.
- 4 The player will also be disconnected when your device is moved beyond the operational range.
- 5 If you want to reconnect your device to this player, place it within the operational range.
- 6 If the device is moved beyond the operational range, when it is brought back, please check if the device is still connected to the player.
- 7 If the connection is lost, follow the instructions above to pair your device to the player again.

### NFC (Near Field Communication) Operation

Pair your NFC-enabled mobile device directly with this unit by just a single tap.

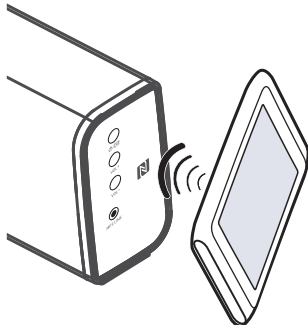

1. Activate NFC on your mobile device.
2. Tap the mobile device on the "N" icon of the unit.
3. Operate your mobile device directly for playback features.
4. To disconnect, tap the mobile device on the "N" icon of the unit to disconnect or disable NFC from your mobile device.

**Note:** This NFC function only works with mobile devices that support NFC technology.

**Tips:** Some NFC-enabled mobile devices cannot pair directly with the unit via NFC, please try either one of the solutions below:

- Please download the App "Tap-and-Pair" from Google Play Store (<https://play.google.com>) and install.
- Pair with the unit manually first, then touch again on the NFC sensing area.

### Listen to Music from Bluetooth Device

- If the connected Bluetooth device supports Advanced Audio Distribution Profile (A2DP), you can listen to the music stored on the device through the player.
  - If the device also supports Audio Video Remote Control Profile (AVRCP), you can use the player's remote control to play music stored on the device.
1. Pair your device with the player.
  2. Play music via your device (if it supports A2DP).
  3. Use supplied remote control to control play (if it supports AVRCP).
    - To pause/resume play, press the ► || button.
    - To skip to a track, press the ◀▶ buttons.

## **Troubleshooting**

---

To keep the warranty valid, never try to repair the system yourself. If you encounter problems when using this unit, check the following points before requesting service.

### **No power**

- Ensure that the AC cord of the apparatus is properly connected .
- Ensure that there is power at the AC outlet.
- Press standby button to turn the unit on.

### **Remote control does not work**

- Before you press any SOURCE button, first select the correct source.
- Reduce the distance between the remote control and the unit.
- Insert the battery with its polarities (+/-) aligned as indicated.
- Replace the battery.
- Aim the remote control directly at the sensor on the front of the unit.

### **No response from the unit**

- Disconnect and reconnect the AC power plug, then turn the unit on again.

### **I can't find the Bluetooth name of this unit on my Bluetooth device for Bluetooth pairing**

- Ensure the Bluetooth function is activated on your Bluetooth device.
- Ensure you have paired the unit with your Bluetooth device.

## Specifications

---

### General

Power requirements.....	AC 120V~ 60Hz
Power consumption.....	30W
Output power RMS.....	15W x 2
Total harmonic distortion.....	1%(1kHz, 1W)
Audio input sensitivity.....	700mV
Frequency response.....	200Hz - 20KHz
Main unit(W x H x D).....	950 x 93.5 x 51 mm

### Speakers

Total impedance.....	4Ω x 2
----------------------	--------

### Wireless Subwoofer

Power Supply.....	AC 120V~ 60Hz
Power Consumption.....	30 W
Output Power.....	60 W
Frequency Response.....	40Hz - 200Hz
Impedance.....	4 Ω
Dimension (W x H x D).....	240 x 315 x 240 mm

### Remote Control

Distance.....	6m
Angle.....	30°

## Standard Accessories

---

Remote Control.....	x 1
Instruction Manual.....	x 1
RCA - RCA audio Cable.....	x 1
Wall Bracket.....	x 2

- Design and specifications are subject to change without notice.

**FCC Warning:** Changes or modifications to this unit not expressly approved by the party responsible for compliance could void the user's authority to operate the equipment.

**FCC NOTE:** This equipment has been tested and found to comply with the limits for a Class B digital device, pursuant to Part 15 of the FCC Rules. These limits are designed to provide reasonable protection against harmful interference in a residential installation. This equipment generates, uses and can radiate radio frequency energy and, if not installed and used in accordance with the instructions, may cause harmful interference to radio communications.

However, there is no guarantee that interference will not occur in a particular installation. If this equipment does cause harmful interference to radio or television reception, which can be determined by turning the equipment off and on, the user is encouraged to try to correct the interference by one or more of the following measures:

- 
- Reorient or relocate the receiving antenna.
- Increase the separation between the equipment and receiver.
- Connect the equipment into an outlet on a circuit different from that to which the receiver is connected.
- Consult the dealer or an experienced radio/TV technician for help.