

# User Manual

---

## Bluetooth car kit with detachable headset

### Model BH6100D

## Contents

Introduction.....	
Car kit parts.....	
Mounting on sun visor.....	
Keys and function.....	
Charging the headset.....	
Charging the car kit.....	
Switching on/off the headset.....	
Pairing the headset with Bluetooth mobile phone.....	
Wearing the headset.....	
Make call with the headset.....	
LCD indicator of the headset.....	
Mounting Bluetooth car kit.....	
Switching on/off the car kit.....	
Make call with the car kit.....	
The indication of the car kit.....	
Care and maintenances.....	
FAQs.....	

Welcome to use this Bluetooth car kit (BH6100) . Before using it , please read this User Manual carefully .

## **Introduction**

### **Bluetooth wireless communication technology**

Bluetooth is a standard of close range radio-communication technology which was drawn up by Ericsson, IBM, Intel, Nokia, Toshiba on May,1998. Through Bluetooth technology, we can achieve the highest transmission rate among mobile phone, computer, printer, PDA and other devices ,and the transmission range of Class2 is 10 meters, the max. radio-communication range of Class1 can reach up to 100 meters.

### **BH6100D**

This product includes Bluetooth headset and car kit, you can only use the Bluetooth headset and you can make hands free call when the headset was plugged into the car kit.

#### **1. Bluetooth headset**

Bluetooth wireless headset of BH6100 can feel free to connect with any Bluetooth devices that support Bluetooth HFP. The outlook design of this Bluetooth headset is very compact and compliant with wearing on both ears; On the conformance, it's sound quality is perfect ,it can make call clearly in noisy environment; it's effect is low ,Taking time can achieve 4 hours at the most , and the standby time can achieve 70hrs at the most; you can enjoy the following functions through it :

- A. Answer, end and reject incoming call on the headset
- B. Dial last call
- C. Microphone mute
- D. Voice dial ( it needs your mobile phone to support.)
- E. Adjust volume
- F. Switch conversation between the mobile phone and the headset

#### **2. Hands free car kit**

Hands free car kit is designed specially for the above Bluetooth headset. The car kit is compliant with all kinds of environment ,such as home, office, car and so on. After plugging the headset into the car kit, you can enjoy the following functions:

- A. Answer, end and reject incoming call on the car kit
- B. Redial
- C. Adjust volume
- D. Switch conversation between the headset and the car kit

- E. Charge the headset automatically when the battery capacity of car kit is enough
- F. When charging the car kit, can charge the headset simultaneously

## Parts

This car kit includes 3 parts.

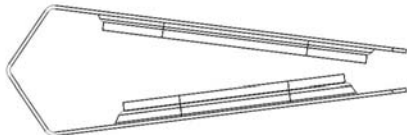
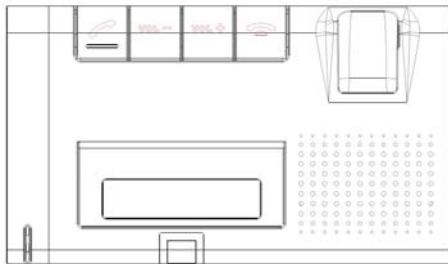

## Mounting the car kit on sun visor

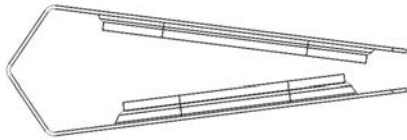
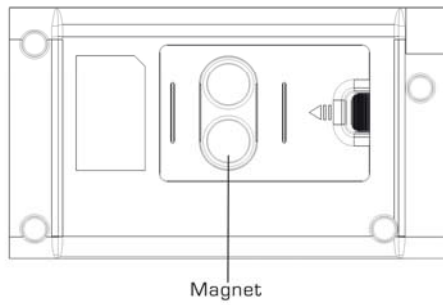

## Keys and functions

### 1. Key function (front side)

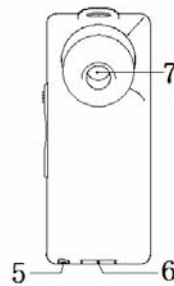
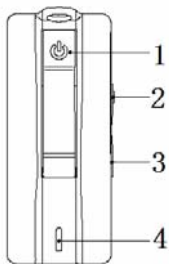

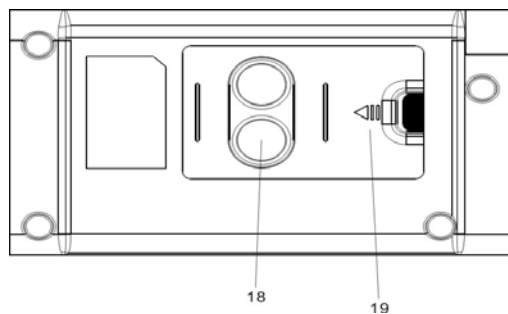
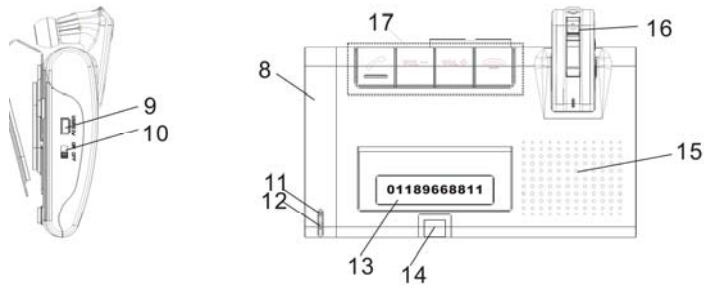

1. Multi-function button : switch on/off ,pair, answer, end a call, [Dial last number](#)
2. Volume +/reject call/conversation switch/ [Voice dial](#)
3. Volume \_/microphone mute
4. LED indicator of the headset
5. Microphone of the headset
6. USB charging port of the headset
7. Loudspeaker of the headset
8. Rotating arm
9. Charging port of car kit
10. Power on/off button
11. Status indicator of car kit
12. Microphone of car kit
13. LCD display
14. LCD pop switch
15. Speaker of car kit
16. Bluetooth headset
17. Area of button and background light of button
18. Magnet
19. Battery cover

button	function
	Answer/ <a href="#">redial</a>

	End a call
<b>Vol +</b>	Volume +
<b>Vol -</b>	Volume -

## 1. Top view



 POWER On/Off  
 Charging socket

## 2 Back side view

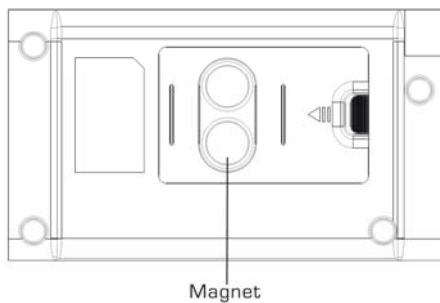

## Charging the headset

The headset should be used built-in chargeable battery. At the first time to use the headset, please charge the battery full, Besides, you will hear the indication tone every 11 seconds, and than the red LED will flash, at this time, you have to charge the headset again.

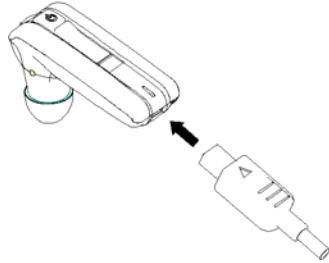

- 1) Plug charger into standard power socket
- 2) Insert Mini USB plug into USB charging port on the bottom of the headset  
When red LED is on, it is charging.  
When red LED is off, it has charged fully
- 3) It will take about 1.5hrs to charge the headset full.

### Charging the car kit

It is powered by 3\*777 batteries,. when its power is low, the symbol of low power will flash on the LCD. At this time, you have to replace new batteries or recharge the car kit.

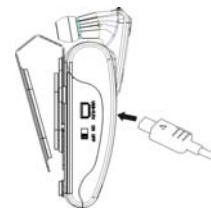

1. Plug charger into standard power socket
2. Insert MINI USB plug into USB charging port on the side of the car kit  
During charging, the battery denotation displayed on the LCD will roll, When fully charged, the denotation will stop rolling.  
It will take about 2.5-3 hours to charge the car kit full, The charging time varies with different brands of batteries.

**Remark** : when plug the headset into the cat kit , the car kit can charge the headset simultaneously.

### Switching on/off the headset

Function	operation	LED indicator	Indication tone
----------	-----------	---------------	-----------------

Switch headset on	Press multi-function button for 3-5 seconds, and release until the Blue LED is on	The Blue LED flashes	A tone of "DU"
Switch headset off	Press multi-function button for 2-3 seconds, and release until the red LED is on.	The red LED flashes 3 times	A tone of "DI" and "DU"

Note: If disconnect to any device in 5 minutes, the headset will turn off automatically to save the power.

### Pairing the headset with Bluetooth mobile phone

Before you firstly use the Bluetooth headset, you have to pair the headset with Bluetooth mobile phone ,ensure your mobile phone supports Bluetooth function and the Bluetooth function can be used. The pairing steps maybe vary with different mobile phones, so please read particularly the pairing indication of Bluetooth device of your mobile phone User Manual. The general steps as follows:

1. Keep your headset and mobile phone within one meter.
2. Ensure your headset is off (All LED indicators are off)
3. Press multifunction button for about 7~8 seconds, and then release the button after you hear the second indication tone (The first one is a tone of "DI", the second one is "DU,DU",)or see red LED and Blue LED flash alternately, the headset will enter into pairing mode.
4. Activate Bluetooth function of the headset to search the Bluetooth devices. Select "BH6100D" in the device list when completely searching..
5. According to indication, enter into password or PIN Nos: "1234", and press "Yes" or "confirm" to confirm
6. After successful connecting, select "BH6100D" in the Bluetooth device of mobile phone and connect. After successful connecting, the Blue LED of the headset will flashes twice every 4 seconds..

### Remark :

- The pairing mode will last for 2 minutes. The headset will switch to standby mode automatically if it can't pair with any devices after exceeding 2 minutes. If need to pair again, please firstly switch off the headset ,and then refer to the above 1-6 steps to pair again.
- After successful connecting, Bluetooth headset and Bluetooth mobile phone will remember each other . Otherwise pairing information was deleted owing to new pairing , no need to pair again next time.



- Under the status of standby and disconnect with any devices, press multifunction button of the headset once, After hearing a tone of “ Du”, the headset will send a connecting requirement to device paired nearby.
- After turning on the headset each time , it will connect with device paired nearby. If you need to pair with other devices, please turn off Bluetooth function of device paired with headset , and then pair with new device according to the above steps 1-6 .

## **Wearing the headset**

The headset adapts the design of entering into ear mode. It is compliant with left or right ear. After wearing headset well , turn the headset to make the microphone point to the user’s mouth to achieve better communication effect. If there is no barricade between the headset and mobile phone , the communication performance will be better.

## **Making call with the headset**

<b>Function</b>	<b>Status of device</b>		<b>Process of operation</b>
	Status of the mobile phone	Status of the headset	Headset operation
Voice dial	Standby mode	Switching on	Press volume down button for about 2 seconds, and release after hearing the indication tone
Dial last call	Standby mode	Switching on	Short press multifunction button
Adjust volume	Conversation mode	Conversation mode	Press volume up or down button to adjust volume,
End a call	Conversation mode	Conversation mode	Short press multifunction button
Answer a call	Ringing	Switching on	Short press multifunction button
Reject a call	Ringing	Switching on	Press multifunction button for about 2 seconds, and release after hearing the indication tone
Conversation switch to mobile phone	Conversation mode	Switching on	Press volume up button for about 2 seconds, and release after hearing a long tone of “DI”
Conversation switch to headset	Conversation mode	Switching on	Press volume up button for 2 seconds

Microphone mute	Conversation mode	Switching on	Press volume up button for 2 seconds, and release after hearing a short tone of “DU”. When microphone mute, the headset will sound a indication tone every 5 <b>seconds</b>
Cancel mute	Conversation mode	Switching on	Press volume down button for 2 seconds, and release after hearing a short tone of “DU”
Reset the headset	Standby mode	Abnormal	When the headset is working abnormally, please press MFB and volume up simultaneously to reset the headset

**Warning: Excessive pressure form earphones and headphones can cause hearing loss.**

Remark :

- Certain mobile phones don't support parts of functions of the list. Please refer to your mobile phone User Manual.
- When the volume is adjusted to max. or min. you will hear a tone of “ Ding Dong”.
- For parts of mobile phones, the conversation will be turned to mobile phone when answering incoming call. At this time, you can switch the conversation to headset from mobile phone via using the switching function of headset or operating on the mobile phone.

## LED indicator of headset

### 1. When it is charging

LED Indicator	Status of headset
The red LED is on	charging
The red LED is off	Finish charging

### 2. Connecting with Bluetooth device (mobile phone)

LED indicator	Status of headset
Blue LED flashes once every 2 seconds	Standby mode and disconnect with Bluetooth device ( mobile phone)
Blue LED flashes twice every 4 seconds	Standby mode and connected with Bluetooth device ( mobile phone )
Blue LED flashes once every 2 seconds	Conversation mode
Red and Blue LEDs flash alternately	Pairing mode
Red LED flashes slowly	low power

## Mounting Bluetooth car kit

The car kit is compliant with all kinds of environment , such as home, office, car and so on

### 1 Using in the car

When the car is driving, mount the car kit on the sun visor..

- 1) Mount fixed clip in the card slot of bottom of car kit.
- 2) Make the magnet of bottom of the car kit point to the rut of fixed clip to mount fixed clip on the sun visor.
- 3) Adjust the degree of the rotating arm and make the microphone point to user's mouth.
- 4) The position of car kit can change with the position of sun visor. The rotating arm can adjust from 0°C to 90°C, please adjust according to actual situation. When necessary, press the LCD pop switch to pop LCD to gain the perfect displayed angle.

### 2 Using at home/ office

When using in office , please take fixed clip off the car kit, and then put the car kit on the flat solid desk to ensure conversation effect .







## Switching on / off the car kit

Function	operation	LED indicator
Switch on power of the car kit	Snap ON/OFF to ON	Display "BH6100D"
Switch off power of the car kit	Snap ON/OFF to OFF	The LCD is off
Switch on Bluetooth headset	If the car kit is on, the headset will switch on automatically after is plugged into car kit	
Switch off Bluetooth headset	1、 Please pick up the headset from the carkit at first 2、 Refer to "Switching off the headset" to switch off the headset	
Enter into pairing mode	If the headset have been plugging into the carkit but disconnect to any device , long press the MFB until the headset 's Red and	

	Blue LEDes flash alternately	
--	------------------------------	--

## making call with Bluetooth car kit

**Remark:** First you have to pair and connect Bluetooth headset with mobile phone, and then plug the headset into the car kit if you want to make call with the car kit.





Function	Status of device		Process of operation
	mobile phone	car kit	
Redial	Standby mode	Switch on	1、 Short press button  on the car kit, the car kit will display recent received or missed number 2、 Press VOL+ or VOL- to select next or previous record. 3、 Re-press button  to redial displayed number or press  to EXIT.
Answer a call	Ringing	Switch on	Short press button  on the car kit
Adjust volume	Conversation mode	Conversation mode	Short press volume up or down button to adjust volume
End a call	Conversation mode	Conversation mode	Short press button  on the car kit or multifunction button of the headset.
reject a call	Ringing	Switch on	Short press button  on the car kit
Conversation is switched to headset	Conversation mode	Conversation mode	Take the headset off the car kit, and the conversation will be switched to the headset automatically

### Remark :

- 1、 If the volume is still low after adjusting the Volume up button, please press the volume up button to adjust the volume to max.
- 2、 The carkit will remember 10 recent received or missed calls in the memory.

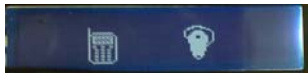
## The indication of the car kit

Status	The indication of	LCD indicator
--------	-------------------	---------------

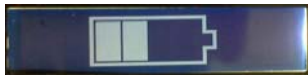
	<b>display</b>	
Standby and disconnect with device(mobile phone) or the headset didn't plug into car kit		Noting
The headset has been plugged into the carkit. and connect with device (mobile phone) and		Nothing
Ringing	Display incoming call number, for example: 	The LCD indicator of Car kit and background light is on
Conversation mode		The LCD indicator of Car kit and background light is on
The car kit is low power	Low denotation flashes continuously 	Noting
When it is charging	The battery denotation is rolling continuously 	Noting
When it has charged fully	The denotation stop rolling ,and the carkit return to standby mode	Noting

## Specification

Bluetooth version	Bluetooth 2.0
Bluetooth profile	Headset, Hands free
Range	10 Meters
working time	Headset : Up to 4hrs Car kit: Up to 9 hrs
standby time	Headset:70hrs
Charging input voltage	DC+5.5V±0.25VA
charging time	Headset : 1.5-2hrs Car kit : 2.5-3hrs

Operating temperature	-10~45°C
Storage temperature	-20~60°C
Dimension	Headset: 38.5*16*9.3mm Car kit: 121*70*22mm
weight	Headset: 6.5g Car kit: 92g(not included the headset and batteries) Fixed clip: 14.5g

## Care and maintenance

When using it , please read following the suggestions to help you fulfill any warranty obligations and to enjoy this product for many years .

1. Keep the product dry , and don't put it in the wet place, in case of effected the interior circuit of product.
  2. Don't put the product under the sunlight or place hot areas, High temperature will short the life of electronic device, destroy the battery, and wrap or metal certain plastic.
  3. Don't put the product in cold areas, which may damage the internal circuit board .
  4. Don't try to take part the product, it may damage the product if you are not professional
  5. .Don't fall off on the floor, shake intensify, or knock the hard substance , it may damage interior circuit .
  6. Don't use intensify chemical or detergent to clean the earphone
  7. Don't scrap the surface with sharp things , in case of influent the outlook .
- If the produce can't work normally, please sent it to the qualified asserted store , the staff will help you to solve the problem warmly.

## FAQ

1. **Why is the speaker no sound when making call with car kit?**
  - a) Please make sure the car kit is switched on.
  - b) Please make sure the headset connect well with the car kit.
  - c) Please make sure the volume has already been adjusted to the proper position.
  - d) Please adjust the volume to max. via pressing the volume up button of the headset or mobile phone.
2. **Why can not my mobile phone search and find the headset**  
If the mobile phone is not in paring mode, the mobile phone can't find the headset. Please make sure the headset is in pairing mode and in the

effective working range, the mobile phone can pair with the headset.

**3. Why the conversation is not clear?**

- a) Make sure the mobile phone is in the strong signal areas
- b) Make sure the headset is in the effective working range.

**4. How many is the effective range between the headset and the mobile phone?**

According to the Bluetooth standard, the max. controllable range of Class 2 headset is 10 meters. But it varies with different environment and paired mobile phone.

**Note**

**This device complies with Part 15 of the FCC Rules. Operation is subject to the following two conditions: (1) this device may not cause harmful interference, and (2) this device must accept any interference received, including interference that may cause undesired operation.**

**Changes or modifications not expressly approved by the party responsible for compliance could void the user's authority to operate the equipment.**