

BTC005B

Bluetooth handsfree kit

■ Brief introduction	1
1. Bluetooth wireless communication technology.....	1
2. About BTC005B.....	1
■ Before using	1
1. Overview.....	1
2. Charging the handsfree kit.....	2
■ Using the handsfree kit	3
1. Switching on/off the handsfree kit.....	3
2. Pairing the handsfree kit with Bluetooth mobile phone.....	3
3. Installing the handsfree kit	4
4. Making call with the handsfree kit.....	4
5. Bluetooth Music Receiver.....	5
6. Re-connecting with Bluetooth device.....	5
7. Automatic switching off.....	6
8. LED indicators and indication tone.....	6
■ Care and maintenance	7
■ FAQ	7
■ Specification	8

Welcome to use this Bluetooth handsfree kit, BTC005B. Please read this user manual carefully before using it.

■ Brief introduction

1. Bluetooth wireless communication technology

Bluetooth is a standard of close range radio-communication technology that was drawn up by Ericsson, IBM, Intel, Nokia and Toshiba. Through Bluetooth technology, we can achieve the highest transmission rate among mobile phone, computer, printer, PDA and other devices. The max transmit range of class 2 is 10 meters while the max transmit range of class 1 can reach up to 100 meters.

2. About BTC005B

BTC005B is a portable Bluetooth handsfree kit. It adopts echo cancellation technology and provides high-level sound quality. At the same time, it has simple handsfree operation. It can be used with Bluetooth mobile phone and PDA which support Headset Profile, Handsfree Profile, or (and) A2DP profile. It has the following features:



- 1) Pairing with the Bluetooth mobile phone and PDA which support HFP.
 - ✧ Answer, end and reject call from the handsfree kit
 - ✧ Redial last call
 - ✧ Voice dial(it needs your mobile phone to support.)
 - ✧ Adjust volume
 - ✧ Mute the Microphone while in call.
 - ✧ Voice announces the status of hands free kit or the phone number of the incoming caller.

- 2) Pairing with Bluetooth music devices and Bluetooth transmitter which support A2DP
 - ✧ Enjoy music wirelessly
 - ✧ Adjust volume
 - ✧ Remote control the function of pause/revert to play
 - ✧ Remote control last/next song

■ Before using

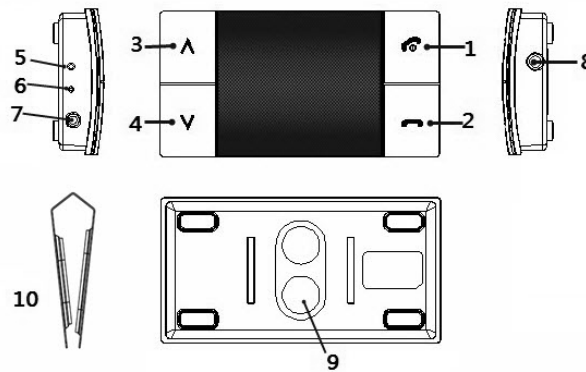
1. Overview



- | | |
|----|---|
| 1 |  button—switch on/off, pairing, answer, voice dial, redial last call and microphone mute |
| 2 |  button—End and reject call, pause song, resume song |
| 3 | ▲ button—Volume up, skip backward |
| 4 | ▼ button—Volume down, skip forward |
| 5 | First microphone |
| 6 | Second microphone |
| 7 | Charging port |
| 8 | Stereo Audio Line Out |
| 9 | Magnet |
| 10 | Metal fixed clip |

2. Charging the handsfree kit

First using—You must charge the battery fully before first using.

Low power—When you hear tones of “Dong Dong Dong” every 10 seconds or see the red LED to flash twice every 10 seconds, it means that the battery is low power and need to be charged.

The charging steps are as follows:

Step1: Connect the charging cable to USB port;

Step2: Connect the end of the charging cable to charging port of the side of the handsfree kit.

When the red LED is on, it is charging.

When the red LED is off, it has charged fully.

It will take about 2.5 hours to charge the handsfree kit fully.



Remarks:



1. The battery will dry up if you don't use the handsfree kit for a long time, at this time, you have to charge the handsfree kit for about 30 minutes, the LED indicator will be on.
2. Please don't attempt to take out the battery from the handsfree kit, so as not to damaging the handsfree kit.

**Warning:**

1. The battery is recycled.
2. Do not dispose of the battery in fire, as it may cause explosion.

■ Using handsfree kit

1. Switching on/off handsfree kit

Function	Operation	LED indicator	Indication voice
Switch on	Press  button for about 3~5 seconds, and release it till blue light flashes	Blue LED flashes 3 time	Headset Ready
Swith off	Press  button for about 2~3 seconds, and release it till red light flashes	RED LED flashes 3 time	Powering Down
Enter into pairing mode	Make sure the hands free kit is off, press  button for about 7~8 seconds, and release it till blue LED and red LED flashes alternately	blue LED and red LED flashes alternately	<i>Please pair Bluetooth phone now</i>

Remark: The pairing mode will last 2 minutes, it will switch to standby mode if exceeding 2 minites. When you have to repair it, please switch off the handsfree kit firstly, and then make it enter into pairing mode again.

2. Pairing the handsfree kit with Bluetooth mobile phone

Please make sure your mobile phone has bluetooth function that is available. Specific pairing steps may vary with different mobile phones. Please refer to your mobile phone user manual for further information. The steps are as follows:

- 1)、Keep the handsfree kit and Bluetooth mobile phone within 1 meter when

pairing.

- 2)、 Make the handsfree kit enter into pairing mode (refer to “Switch on/off the handsfree kit)., you will hear a voice ‘*Please pair Bluetooth phone now ,enter pin code ‘0000’*”
- 3)、 Switch on Bluetooth function of mobile phone and search the Bluetooth device. After searched, select “BTC005B” in the Bluetooth device list.
- 4)、 According to indication, enter password or PIN No:”0000”, and press the key of ” Yes” or “confirm”.
- 5)、 After successful pairing, select “BTC005B” in the Bluetooth device list, and press “connect”.
- 6)、 After successful connecting, you may hear a voice ‘*Connected to Bluetooth phone。 ’*.

Remark:

- ◆ If the pairing is not successful, please switch off handsfree kit firstly, and then re-pair according to the step 1-6 mentioned above.
- ◆ After successful pairing, the handsfree kit and mobile phone will remember each other, the handsfree kit will not need to re-pair with Bluetooth device when use next time unless the pairing information is deleted because of new pairing.
- ◆ When you switch on the handsfree kit every time, it will connect with last connected devices automatically. If you want to pair it with other devices, please switch off Bluetooth function of current Bluetooth device paired with the handsfree kit firstly, and then pair the handsfree kit with new device according to steps 1~6 mentioned above.

3. Installing the hands free kit

The hands free kit is suitable to use in family, office or car and so on.

1)、 Using in the car











First clip the metal fixed clip on the sun visor, then let magnet of back of handsfree kit adsorb groove of metal fixed clip. At last, adjust the degree of handsfree kit to make the microphone towards to user’s mouth to get the best conversation effect.



2)、 Using at home/in office

When you use the handsfree kit at home or in office, please take apart the handsfree kit with metal fixed clip firstly, and then put the handsfree kit on the flat and solid desk to get best conversation effect.

4. Making call with the handsfree kit

Function	The status of the hands free kit	Operation
Cancel calling	Calling	Short press  button 1 time
Answer a call	Ringing	When the is a incoming call, you will hear a notice 'Call from xxxxxxx' , at this time short press  button 1 time to answer the call.
Reject a call	Ringing	Short press  button 1 time
End a call	Conversation mode	Short press  button 1 time
Volume up	Conversation mode	Short press  button
Volume down	Conversation mode	Short press  button
Microphone mute	Conversation mode	Continuous short press  button 2 times, The handsfree kit sounds 2 indication tone every 5 seconds when the microphone is mute
Cancel mute	Conversation mode (microhone mute)	Short press  button 2 times
Redial last call	Standby mode (connected with Bluetooth device)	Short press  button 2 times
Voice dial	Standby mode (connected with Bluetooth device)	Short press  button 1 time

Warning: Excessive pressure from earphones and headphones can cause hearing loss.

Remarks:

- ◆ Not all the mobile phones support all the functions listed above. Please refer to your mobile phone user manual.
- ◆ When the volume is adjusted to max or min, you will hear a indication tone.



- ◆ For some mobile phones, when you press the answer button on the phone, the conversation will be sent to the mobile phone. At this time, you may switch the call to the handsfree kit through operating on your mobile phone. Please refer to your mobile phone user manual for further information.

6. Bluetooth Music Receiver

When the hands free kit connects with the mobile phone or Bluetooth transmitter which supports A2DP, you can enjoy music wirelessly.

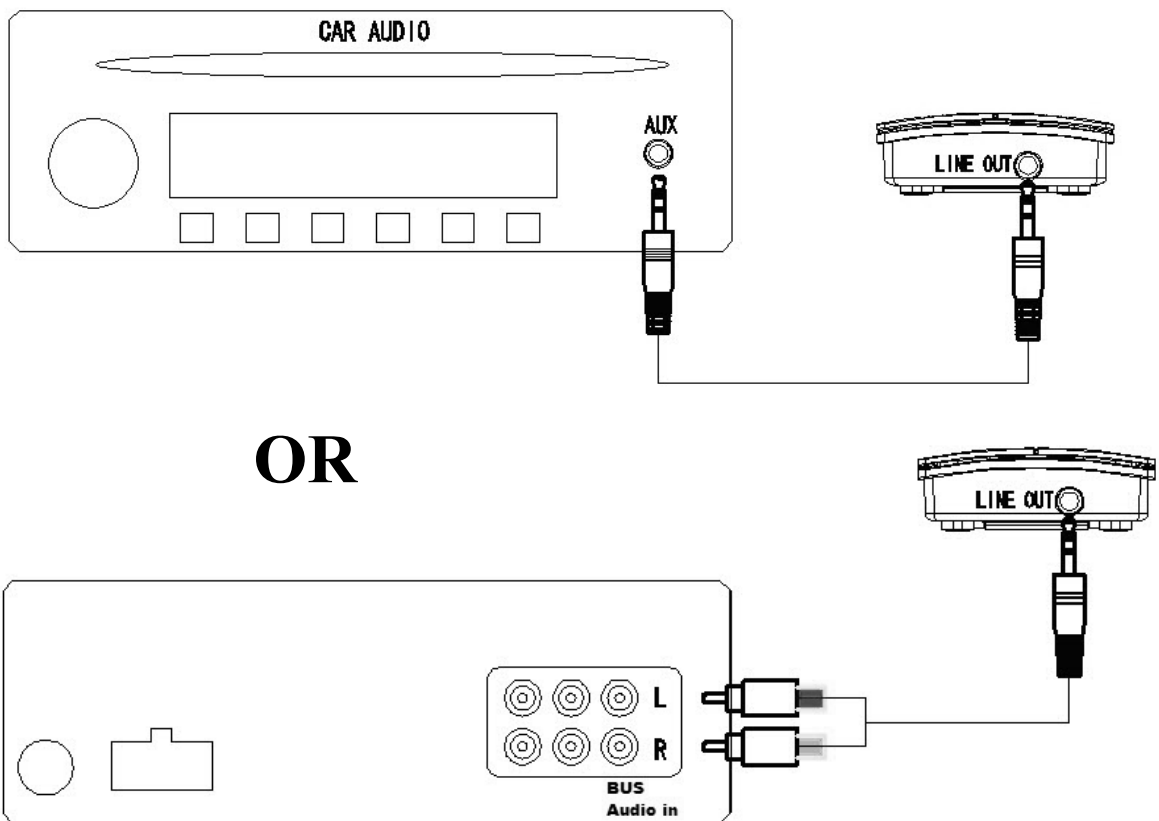
Before enjoy music , the hands free kit need to connect to your car stereo system or home stereo system.



Function	Status of headset	Operation	
Volume up	Playing music	Short press \wedge key	
Volume down	Playing music	Short press \vee key	
Pause	Playing music	Short press the 	
Revert	Pause	Short press the 	
Last song	Playing music	Long press \wedge key 2 seconds	
Next song	Playing music	Long press \vee key 2 seconds	

Remark:

- ✧ For some of mobile phones, when they are playing music, the music will transmit to the speaker of mobile phone, you have to choose “transmit the sound through Bluetooth” in the “setting” of music play interface, and then choose “SBT02” in the device list, the music will be transmitted to the headset. Please refer to the instruction of your mobile phone for further information.
- ✧ Remote control the function of last song/next song/pause/revert, it needs your mobile phone or Bluetooth transmitter supports AVRCP. Please refer to the instruction of your mobile phone or Bluetooth transmitter. for further information.

7.Re-connecting with Bluetooth device

1) Automatic connecting

The handsfree kit will connect with last connected device automatically when turn on it every time.

2) Connecting manually

When the handsfree kit disconnect with Bluetooth device, press  button 1 time, the handsfree kit will connect with last connected device.

Remarks:

- ◆ The handsfree kit only try to connect with last connected device that supports HFP.
- ◆ Before connecting with Bluetooth device, please switch on Bluetooth function of your Bluetooth device.
- ◆ For some Bluetooth devices, take some Nokia mobile phones for example, you have to set up on mobile phone to allow automatic connecting.

8.Automatic switching off

The handsfree kit will switch off automatically in order to save power, if it doesn't connect with any devices after 10 minutes.

9.LED indicators and indication tone

The status of the handsfree kit	LED indicators	Indication tone
Charging	Red LED is on	
Finish charging	Red LED is off	
Pairing mode	Blue and red LED flashes alternately	
Standby mode (not connected with Bluetooth device)	Blue LED flashes 1 time every 2 seconds	
Standby mode (connected with Bluetooth de	Blue LED flashes 2 times every 4 seconds	
Ringing	Blue LED flashes quickly	
Conversation mode	Blue LED is on steady	
Low power	Red LED flashes twice every 10 seconds	2 tones every 5 seconds

■ Care and maintenance

Please read the following suggestions carefully, that will help you to fulfill any warranty obligations and enjoy this product for many years.

- ◆ Keep dry and don't put it in the dump place, so as not to affecting the interior circuit of product.
- ◆ Don't put the product under the sunlight or place in the hot areas. High temperature will shorten the life of electronic device, destroy the battery, or distort certain plastic.
- ◆ Don't expose the product in the cold areas. It may damage the internal circuit board.
- ◆ Don't try to take apart the product. It may damage the product if you are not professional.
- ◆ Don't fall off on the floor or knock the hard substance. It may damage interior circuit.
- ◆ Don't use intensify chemical or detergent to clean the product.
- ◆ Don't scrap the surface with sharp things.

If the product can't work normally, please send it to the regularly asserted store. The staff will help you to solve the problem warmly.

■ FAQ

1. Why is there no sound when making call with the handsfree kit?

- a) Please make sure the handsfree kit connect well with Bluetooth mobile phone;
- b) Please make sure the volume has already been adjusted to the proper position.

2. Why can not my mobile phone search and find the handsfree kit?

If the handsfree kit is not in pairing mode, the mobile phone can't find the handsfree kit. Please make sure the hand free kit is in pairing mode and in the effective working range, the mobile phone can pair with the handsfree kit.

3. Why is the conversation not clear?

- a) Make sure the mobile phone is in the strong signal areas;
- b) Make sure the handsfree kit is in the effective working range.

4. How many is the effective range between the handsfree kit and the mobile phone?

According to the Bluetooth standard, the max. controllable range of Class 2 handsfree kit is 10 meters. But it varies with different environment and paired mobile phone.

■ Specification

Bluetooth version	Bluetooth V2.1
Bluetooth profiles	Headset, Handsfree
Effective range	10m
Working time	Talk Up to 10 hours Music Up to 17 hours
Standby time	Up to 500 hours
Charging input	DC 5V --- 500mA
Charging time	Approx. 2.5 hours
Working temperature	-10 ~ 45°C
Storage temperature	-20~60°C
Dimension	90*47*17mm
Weight	55g

Note

This device complies with Part 15 of the FCC Rules. Operation is subject to the following two conditions: (1) this device may not cause harmful interference, and (2) this device must accept any interference received, including interference that may cause undesired operation.

Changes or modifications not expressly approved by the party responsible for compliance could void the user's authority to operate the equipment.