

**BTC019**  
**Bluetooth FM transmitter**  
**User's manual**



## Contents

■ Before use.....	1
1. About BTC019.....	1
2. Overview.....	2
3. Prepare before use.....	3
■ Getting use.....	4
1. Pairing and connecting with Bluetooth cell phone.....	4
2. Adjusting FM frequency.....	4
3. Playing music.....	5
4. Making call.....	5
5. The operation of BTC019.....	6
6. Line out.....	7
7. Line in.....	8
8. Charging for portable device.....	8
9. Factory Reset.....	8
10. LED Indicator.....	8
■ Care and maintenance.....	9
■ FAQs.....	9
■ Specifications.....	10

Welcome to use this Bluetooth FM transmitter BTC019. Please read this user manual carefully before using it.

■ **Before use**

**1. About BTC019**

BTC019 is a Bluetooth hands-free car kit with a Bluetooth stereo receiver and FM transmitter. It also has a DC 5V USB Charging output jack. With BTC019 you can make calls freely and listen to your music. BTC019 has the following features:

**i. Bluetooth hands-free car kit—Pair with a Bluetooth cell phone or PDA supporting HFP:**

- ◆ Answer call, end call and reject call
- ◆ Redial last number
- ◆ Voice dial

**ii. Bluetooth stereo receiver—Pair with a Bluetooth cell phone or Bluetooth transmitter supporting A2DP:**

- ◆ Enjoy music wirelessly
- ◆ Adjust volume
- ◆ Remote control pause/play
- ◆ Remote control previous/next song
- ◆ Remote control fast forward/fast rewind

**iii. FM transmitter—Transmit calls or music to the car's FM radio:**

- ◆ Transmit calls or music to the car's FM radio
- ◆ Adjust FM frequency

**iv. Line in and Line out**

- ◆ Line in—Transmit stereo music to BTC019 from a music player with 3.5mm audio cable
- ◆ Line out—Transmit calls or stereo music from BTC019 to the car's stereo system with 3.5mm audio cable

**v. USB charging jack**

BTC019 has a USB charging jack which provides DC 5V voltage for powering and charging other devices.

## 2. Overview

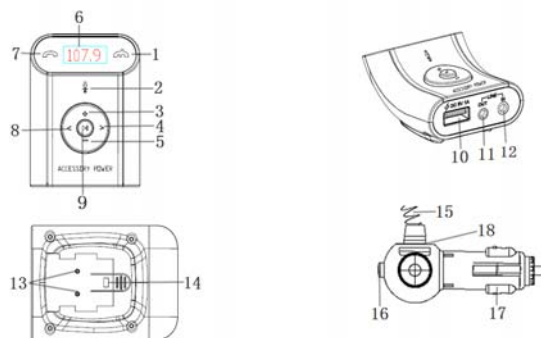

1	button(Red LED)	10	USB jack
2	Microphone	11	Line out
3	Volume up	12	Line in
4	> button	13	Power point
5	Volume down	14	Connecting slot
6	LED display	15	Flexible gooseneck
7	button(Blue LED)	16	⏻ power button
8	< button	17	Cigarette adaptor
9	button	18	LED indicator

**3. Prepare before use**

- i. Connect the flexible gooseneck cigarette adaptor with the main body of BTC019.

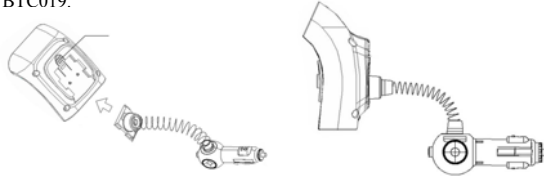

- ii. As the following pictures show: put the cigarette lighter plug into the car cigarette socket.

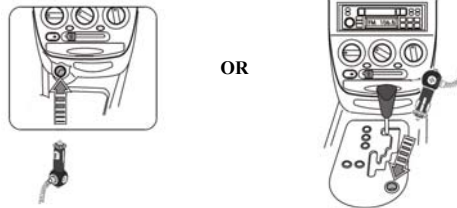

- iii. Press the power switch on cigarette adaptor to activate BTC019, and the indicator light will on.

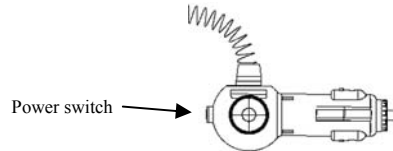

- iv. Blend the gooseneck and make it face to the user.

## ■ Getting use

### 1. Pairing and connecting with Bluetooth cell phone

Before use, you should pair BTC019 with your cell phone. Please make sure your cell phone is Bluetooth-enabled. Specific pairing steps may vary with different models of cell phones. Please refer to your cell phone's user's manual for further information.

#### The general pairing steps are as follows:

- a) Keep BTC019 and your Bluetooth cell phone within 1 meter when pairing;
- b) Long press BTC019  about 5 seconds till red and blue light flash alternately;
- c) Activate your cell phone's Bluetooth function and search for Bluetooth devices. After the search is completed, select "BTC019" from the Bluetooth device list;
- d) According to the indication, enter password or PIN No:"0000", and press "Yes" or "confirm";
- e) After successful pairing select "BTC019" from the Bluetooth device list and press "connect". After successful connecting, red and blue LED will on.

#### Remarks:

- ◆ Pairing mode will last 2 minutes. If no devices can be connected over 2 minutes, BTC019 will back to standby mode. If you want to repair, please turn off BTC019 first and then enter pairing mode again.
- ◆ After successful pairing, BTC019 and the Bluetooth cell phone will remember each other, BTC019 will not need to re-pair with the Bluetooth cell phone next time unless the pairing information is deleted because of a new pairing.
- ◆ Every time BTC019 is turned on, it will connect to last connected devices automatically.
- ◆ Under the status of standby mode, and non-connected with devices, short press  once, BTC019 will connect with last connected device.

### 2. Adjusting FM frequency

1) Long press volume up "+" or volume down "-" button once, BTC019 enter frequency adjustable mode and the display will flash. Please short press volume up or down button to choose previous or next frequency until the frequency of BTC019 is same as car radio.

2) Auto-search function: Long press  button about 3 seconds. BTC019 will auto-search an empty station.

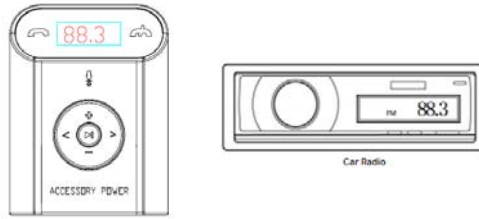

**Remark:**

BTC019 will remember and show last used frequency automatically after turn on.



**3. Playing music**



After setting up follow the above steps, you can play music from phone to car radio via BTC019.

Function	Status of BTC019	Operation
Adjust volume	Playing music	Short press volume up “+” or volume down “-” button
Last song	Playing music	Short press < button once
Next song	Playing music	Short press > button once
Fast rewind	Playing music	Long press < button
Fast forward	Playing music	Long press > button
Pause music	Playing music	Short press  button once
Play music	Pause music	Short press  button once



**4. Making call**

Please make sure BTC019 has already connected with cell phone. For the best effect on making call, please make sure the microphone of BTC019 is face to user.





Function	Status of BTC019	Operation
Answer call	Incoming call	Short press  once

Reject call	Incoming call	Short press  once
End call	During a call	Short press  once
Adjust volume	During a call	Short press volume up “+” or volume down “-” button

#### 5. The operation of BTC019

Adjust FM frequency		
Function	Current status of BTC019	Operation
Adjust frequency	Turn on	1) Long press volume up or volume down button (the frequency will up or down 0.1MHz ), and release it until it in a suitable frequency 2) Long press volume up or down button about 3 seconds, the frequency will flash, and then short press volume up or down button, you can adjust the frequency now
Search empty station	Turn on	Long press  button about 3 seconds, BTC019 will search an empty station automatically
Music		
Function	Current status of BTC019	Operation
Last song	Playing music	Short press < button once
Next song	Playing music	Short press > button once
Fast forward	Playing music	Long press > button
Fast rewind	Playing music	Long press < button
Pause music	Playing music	Short press  button once
Play music	Pause	Short press  button once
Adjust volume	Playing music	Short press volume up “+” or volume down “-” button



Make call		
Function		Operation
Answer call	Incoming ring	Short press  once
Reject call	Incoming ring	Short press  once
Adjust volume	During a call	Short press volume up “+” or volume down “-” button
End call	During a call	Short press  once
Redial last number	Connected with Bluetooth cell phone	Short press  twice continuously
Voice dial	Connected with Bluetooth cell phone	Short press  once

**Remarks:**

- ◆ Only BTC019 has already connected with device, you can adjust volume when it playing music.
- ◆ Only your cell phone support AVRCP profile, you can use Remote control function (last/next song, fast forward/rewind, pause/play).
- ◆ Not all cell phones support all functions listed above. Please refer to your cell phone’s user’s manual for further information

**6. Line out**

This product has Line out function. You can transmit the audio (music/call) to car stereo system via Line out. When you use Line out, BTC019 will turn off FM transmit automatically.

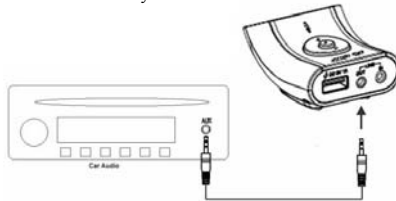

### 7. Line in

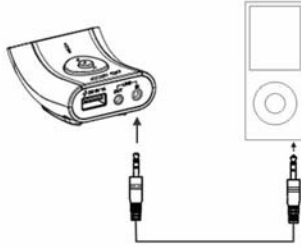

This product has Line in function. If your player has Line out jack, you can transmit music from player to car radio.







### 8. Charging for portable device

This product has charge output jack (DC5V/1A). You can charge for portable device.

### 9. Factory Reset

In the status of turned on and not connect with Bluetooth device, long press  and  button about 5 seconds simultaneously, and release it until red LED on 1 second. BTC019 will delete all paired list and restore factory setting. Turn off BTC019, and turn it on again, it will enter Bluetooth pairing mode automatically.

### 10. LED Indicator

Operation or status	LED indicator
Pairing mode	Blue LED of  and red LED of  will flash alternately
Connected with Bluetooth device	Blue LED of  flash once every 2 seconds
Non-connected with Bluetooth device	Blue LED of  and red LED of  on

#### ■ Care and maintenance

Read the following recommendations before using BTC019. Following these you will be able to enjoy our product for many years.

- ◆ Keep it dry and don't take it to damp places to avoid the product's internal circuit being affected.
- ◆ Keep the product away from direct sunlight or hot places. High temperatures will shorten the life of electronic devices. Don't expose the product to cold areas. It may damage the internal circuit board.
- ◆ Don't try to disassemble the product as it may get damaged if you are not professional.
- ◆ Don't let it fall down onto the floor or other hard surfaces. The internal circuit might get damaged.
- ◆ Don't use intensive chemical products or detergent to clean the product.
- ◆ Don't scratch the surface with sharp things.

In case the product doesn't function properly, send it to the store you bought it. The staff will help you to solve the problem.

#### ■ FAQs

##### 1. Why the sound coming from my car's FM radio is noisy?

- a) Please make sure both BTC019 and your car's FM radio at the same frequency
- b) Please make sure BTC019 is in the effective working range
- c) Please make sure your car's FM radio has been set to an unused frequency

##### 2. Why can't BTC019 be paired with a Bluetooth device?

- a) Please make sure BTC019 is in pairing mode
- b) Ensure BTC019 is in the effective working range

##### 3. Why can't music be played when connected to a Bluetooth cell phone?

- a) Please make sure your Bluetooth cell phone supports A2DP

**4. Why can't pause, play, previous song and next song be controlled from BTC019 during playing music?**

- a) This function need the paired device support AVRCP (Audio/Video Remote Control Profile)
- b) When you use Line in, BTC019 can not remote control.

**5. Why can't adjust volume?**

- a) You can adjust volume only the BTC019 has already connected with Bluetooth device and it is playing music or making call.
- b) When you use Line in, BTC019 can not adjust volume.

■ **Specifications**

<b>Bluetooth version</b>	Bluetooth V2.1+EDR
<b>Bluetooth profiles</b>	HSP, HFP, A2DP and AVRCP
<b>FM frequency range</b>	88.1-107.9MHz
<b>Bluetooth range</b>	Up to 10M
<b>Power supply</b>	DC 12~24V --- 600mA
<b>USB output</b>	DC 5.0V --- 1A
<b>Working temperature</b>	0~40°C
<b>Storage temperature</b>	-20~60°C
<b>Dimensions</b>	Main body:66.7x50x34mm Cigarette adaptor:186x93x30mm
<b>Weight</b>	115.2g

**FCC Statement**

This device complies with Part 15 of the FCC Rules. Operation is subject to the following two conditions:

- (1) This device may not cause harmful interference, and
- (2) This device must accept any interference received, including interference that may cause undesired operation.

Any Changes or modifications not expressly approved by party responsible for compliance could void the user's authority to operate the equipment.

**Note:**

This equipment has been tested and found to comply with the limits for a Class B digital device, pursuant to part 15 of the FCC Rules. These limits are designed to provide reasonable protection against harmful interference in a residential installation. This equipment generates, uses and can radiate radio frequency energy and, if not installed and used in accordance with the instructions, may cause harmful interference to radio communications. However, there is no guarantee that interference will not occur in a particular installation. If this equipment does cause harmful interference to radio or television reception, which can be determined by turning the equipment off and on, the user is encouraged to try to correct the interference by one or more of the following measures:

- Reorient or relocate the receiving antenna.
- Increase the separation between the equipment and receiver.
- Connect the equipment into an outlet on a circuit different from that to which the receiver is connected.
- Consult the dealer or an experienced radio/TV technician for help.

**Radiation Exposure Statement**

This equipment complies with FCC radiation exposure limits set forth for an uncontrolled environment. This equipment should be installed and operated with minimum distance 20 cm between the radiator & your body. This transmitter must not be co-located or operating in conjunction with any other antenna or transmitter.