

BTH106-63
Bluetooth stereo headset
User's manual



Contents

■ Brief introduction	1
■ Before use	1
1. Overview.....	1
2. Charging for headset.....	2
■ Getting started	3
1. Turning on/off the headset.....	3
2. Wearing the headset.....	3
3. Pairing/connecting.....	4
1) Pairing headset with Bluetooth cell phone via Bluetooth.....	4
2) Pairing headset with a Bluetooth transmitter via Bluetooth.....	5
3) Pairing headset with multi devices via Bluetooth.....	5
4. Battery display.....	6
5. Making a call with the headset.....	6
6. Playing music.....	9
7. LED indicator.....	9
8. Factory Reset.....	9
■ Care and maintenance	10
■ FAQs	10
■ Specification	11

Welcome to use this Bluetooth stereo headset, BTH106-63. Please read this user's manual carefully before use.

■ **Brief introduction**

BTH106-63 is an In-ear Bluetooth stereo headset. Mini and portable design for easy taking. The control line adopts water-assistant design for sport. You can use it to enjoy wireless music and make a call at the same time.

■ **Before use**

1. Overview

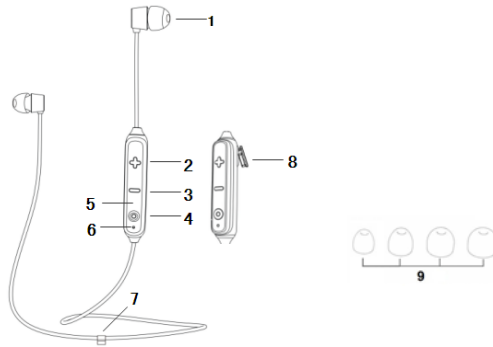

1	Ear tips	6	Microphone
2	+ :Volume up/last track	7	Management clip
3	- :volume down/next track	8	Charging jack
4	⊙:Multi-functions button	9	Four different size eartips
5	LED indicator		

2. Charging for headset

When the headset is low power, the headset emits "Battery low" once every 1 minutes and the red Led flashes instead blue LED. Please recharge the battery of the headset.

The way of charging as following:

Using USB cable

1. Turn on the cover of charging jack, and plug the USB charging cable
2. Plug another side of cable to the USB port of PC
Red light on: Charging
Red light off: Finish charging
3. It will takes about 1.5 hours to finish charging

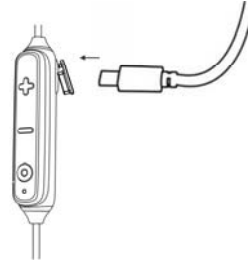



Remarks:

- 1) The battery is recyclable.
- 2) Batteries (battery pack or batteries installed) shall not be exposed to excessive heat place, such as sunshine, fire or the like.

■ Getting started

1. Turning on/off the headset

Functions	Operation	Prompt tone
Turning on	Press and hold  button about 3 seconds until blue LED flashes	Power on
Turning off	Press and hold  button about 5 seconds until red LED flashes	Power off

Remark: In order to save power, the headset will turn off automatically if no devices can be connected after 5 minutes.

2. Wearing the headset

a. Choose the suitable size eartips according to your ear and wear as following shown:



b. The headset also equipped with a clip, which can buckle the cable together for fixed better.



c. If the headset is free, you can use the clip to fix the headset as a necklace. It is convenient and beautiful.



3. Pairing/connecting

1) Pairing headset with Bluetooth cell phone via Bluetooth

Prior to using the headset for the first time, you have to pair it with a Bluetooth-enabled cell phone. The pairing procedures are subject to different models of cell phones. Please refer to your cell phone user's manual for further information.

The general pairing procedures are as follows:

- 1) Keep your headset turned off and within 1 meter of phone ;
- 2) Press and hold **●** about 6 seconds until the red and blue LED flash alternately, the headset enter into pairing mode and emits "pairing"
- 3) Activate your cell phone's Bluetooth function and search for Bluetooth devices within range, select "BTH106-63" from the list of devices shown
- 4) After successful connecting, blue LED of headset flashes twice every 5 seconds and emits "connected"

Remarks:

- ◆ Pairing mode will last 2 minutes, the headset will back to standby mode if the pairing failure.
- ◆ If the pairing is not successful, turn off the headset and repeat the steps as above.
- ◆ When the headset is in standby mode and not connect with device, short press **●** button of headset, it will try to connect to last connected device.

- ◆ When the headset is out of effective range and not connected with device, it will automatically connected after back to effective arrange in 5 minutes. If overtime, the headset will turned off.

2) Pairing the headset with a Bluetooth transmitter via Bluetooth

You can connect the headset to a Bluetooth transmitter to enjoy music wirelessly. Hereby take BTT005 (Bluetooth transmitter, not included in accessories) for example.

The pairing steps are as follows:

- 1) Keep your headset and transmitter within 1 meter when pairing;
- 2) Make the headset enter pairing mode (Please refer to “How to enter pairing mode”);
- 3) Turn on the Bluetooth transmitter and make it enter pairing mode. It will search for Bluetooth devices automatically and send a pairing request;
- 4) When the headset requests to enter a PIN No., the transmitter will response “0000” automatically;
- 5) After successful pairing and connecting, blue LED of the headset flashes twice every 5 seconds and emits “connected”



Remarks:

- ◆ The pairing password of BTH106-63 is “0000”. So, the headset can only pair with a Bluetooth transmitter whose pairing password is “0000”.
- ◆ If pairing still fails after several tries, please refer to the Bluetooth transmitter’s user’s manual for further information.

3) Pairing headset with multi devices via Bluetooth



The headset can connect with two Bluetooth cell phones at the same time.



The general pairing procedures are as follows:

- 1) Pairing the headset with device one
- 2) Turn on the headset and make it enter pairing mode again, and pairing it with device two
- 3) Operate device one to connect with headset. The headset has already connected with two devices in this moment . Restart the headset, it will also connected with two devices automatically.

Remarks:

- The multi-pair function is off in factory set, please turn on this function as following:

Turn off: long press  and  button under standby mode (not connected device), and release it until you hear “Disable multipoint” tone.

Turn on: long press  and  button under standby mode (not connected device), and release it until you hear “Enable multipoint” tone.

- To improve the stabilization of headset, we suggest you turn off the multi-pair function when you only connect with one cell phone.

4. Battery display

When the headset connected with IOS device, it will display the battery of the headset on the device. When the headset is in low battery, power symbol show red, it emits you to charge for your headset.















5. Making a call with the headset

1) Basic operation

Functions	Status of headset	Operation	Prompt tone
Cancel a call	Calling	Short press 	Call terminated

6

Answer a call	Incoming call	Short press 	Answer
---------------	---------------	---	--------





	ringing	once	
Reject a call	Incoming call ringing	Long press  about 2 seconds and release it until listen a tone	Reject
End a call	During a call	Short press  once	Call terminated
Volume up	During a call	Short press  button	No prompt tone
Volume down	During a call	Short press  button	No prompt tone
Transfer conversation to mobile phone	During a call	Long press  about 2 seconds	Transfer audio
Transfer conversation to headset	During a call	Long press  about 2 seconds	Transfer audio
Microphone mute	During a call	Long press  about 2 seconds	Mute on
Cancel mute	During a call (microphone mute)	Long press  about 2 seconds	Mute off
Voice dial	Standby mode (connected device)	Short press  and  button simultaneously	Voice dial
Redial the last number	Standby mode (connected device)	Double click  button	Last number redial

Warning: Excessive pressure from earphones and headphones can cause hearing loss.





Note:

- ◆ To get the best calling effect make your microphone closer to your mouth.
- ◆ When the volume is adjusted to max, you will hear one prompt tone. When the volume is adjusted to min, no prompt tone you will hear.
- ◆ When pressing the answer button on some mobile phones, the call will be transferred to the mobile phone. You can switch the call to the headset by using the conversation switch button or through operating on the mobile phone. Please refer to your mobile phone user manual for further information.

2) Three-ways call operation

Functions	Status of headsets	Operation
Answer new call and end current call	There are second incoming call	Short press 
Answer new call and retain current call	There are second incoming call	Double click button 
Switch calls	Keep conversation	Double click button 
End current call and switch retain call	Keep conversation	Short press 

3) Connect with two cell phones

Functions	Status of headset	Operation
End phone call #1 and answer phone call #2	During phone call #1, phone 2 has incoming call	Short press 
Retain phone call #1 and answer phone call #2	During phone call #1, phone 2 has incoming call	Double click button 
Switch call	During call, one of phone call is retained	Double click button 
End current call, back to retain phone call	During call, one of phone call is retained	Short press 

Functions	Status of the headset	Operation
Volume up	Playing music	Short press + button
Volume down	Playing music	Short press - button
Last song	Playing music	Long press + button about 2 seconds
Next song	Playing music	Long press - button about 2 seconds
Pause	Playing music	Short press ⏸ once
play	Pausing	Short press ⏸ once

Notes:

- ◆ When the volume is adjusted to max, you will hear “maximum volume”. When the volume is adjusted to min, no prompt tone you will hear.
- ◆ If you want to remote control last/next song, pause/play, it needs your Bluetooth mobile phone or Bluetooth transmitter paired with the headset to support AVRCP profile, please refer to the user’s manual of your mobile phone or Bluetooth transmitter for further information.

7. LED indicator

LED indicator	Status of headset
Red and blue LED flashes alternately	Pairing mode
Blue LED flashes once every 2 seconds	Not connected to device
Blue LED flashes twice every 5seconds	Connected to device
Red LED flashes instead of blue LED	Low battery
Blue LED flashes slowly	During a call

8. Factory Reset

In the status of turned off, long press **⏸** and **+** button about 3 seconds and release it until the red and blue LED flashes simultaneously, you will hear “reset paired device list”

Remarks:

After factory reset, the paired list of headset will be deleted. After turn it on again, the headset will enter pairing mode automatically, and you need to re-pair and connect with Bluetooth devices.

■ Care and maintenance

Read the following recommendations carefully before using BTH106-63. Following these you will be able to enjoy this product for many years.

- ◆ Please note that the cord management clips are optional accessory for better wearing.
- ◆ Keep it dry and don't put it in the damp place to avoid the product's internal circuit being affected.
- ◆ Keep the product away from direct sunlight or hot places. High temperatures will shorten the life of electronic devices, destroy the battery or distort certain plastic parts.
- ◆ Don't expose the product to cold areas. It may damage the internal circuit board.
- ◆ Don't try to disassemble the product as it may get damaged if you are not professional.
- ◆ Don't let it fall down onto the floor or other hard surfaces. The internal circuit might get damaged.
- ◆ Don't use intensive chemical products or detergent to clean the product.
- ◆ Don't scratch the surface with sharp things.
- ◆ Don't use this product during strenuous exercise. It may get damaged by sweat.

In case the product doesn't function properly, send it to the store you bought it. The staff will help you to solve the problem

■ FAQs

1. What does it mean when red LED flashes instead of blue LED?

Battery is low power, need to be recharged.

2. Why is the red LED off when charging?

- a) Please make sure the charging device connect with headset well;
- b) The battery may dry up. Please charge the battery for 30 minutes, and then the red LED will be ON.

3. Why can't I hear the sound on the headset?

- c) Make sure the headset has been switched on;
- d) Make sure the volume is not too low or muted;
- e) Make sure the headset connects with the mobile phone correctly;
- f) Make sure the distance between the headset and the cell phone is in the available Bluetooth range.

4. Why can't I hear the sound clearly on the headset?

- a) Make sure the mobile phone is in the strong signal area;
- b) Make sure the headset is in the available range of this product.

5. Why the pause/play, last/next song not function when playing music?

Make sure your Bluetooth device supports AVRCP (Audio/Video Remote Control profile)

■ Specifications

Bluetooth version	Bluetooth V4.2
Bluetooth profiles	HFP, A2DP and AVRCP
Operating distance	10 meters
Headset music time	Up to 4 hours
Headset talk time	UP to 4.5 hours
Standby time	About 150 hours
Headset charging time	About 1.5 hours
Charging input	DC 5.0V /500mA
Weight	About 10.5 g

NOTE: This equipment has been tested and found to comply with the limits for a Class B digital device, pursuant to part 15 of the FCC Rules. These limits are designed to provide reasonable protection against harmful interference in a residential installation. This equipment generates uses and can radiate radio frequency energy and, if not installed and used in accordance with the instructions, may cause harmful interference to radio communications. However, there is no guarantee that interference will not occur in a particular installation. If this equipment does cause harmful interference to radio or television reception, which can be determined by turning the equipment off and on, the user is encouraged to try to correct the interference by one or more of the following measures:

- Reorient or relocate the receiving antenna.
- Increase the separation between the equipment and receiver.
- Connect the equipment into an outlet on a circuit different from that to which the receiver is connected.
- Consult the dealer or an experienced radio/TV technician for help

Changes or modifications not expressly approved by the party responsible for compliance could void the user's authority to operate the equipment. This device complies with Part 15 of the FCC Rules. Operation is subject to the following two conditions:

- (1) this device may not cause harmful interference, and
- (2) this device must accept any interference received, including interference that may cause undesired operation.

FCC Radiation Exposure Statement

The device has been evaluated to meet general RF exposure requirement. The device can be used in portable exposure condition without restriction.