

BTH109
True Wireless Bluetooth Headset
User's manual



Contents

■ Brief introduction	1
■ Before use	1
1. Overview	1
2. Charging for headset	2
■ Getting started	3
1. Wearing headset	3
2. Use one piece earbuds	3
3. Use two earbuds	4
4. Earbuds pairing/connecting	5
5. Function operation-one earbuds connecting with cellphone	6
6. Function operation-two earbuds connecting with cellphone	8
7. Battery display	8
8. LED indicator	9
9. Factory Reset	9
■ Care and maintenance	10
■ FAQs	10
■ Specification	11

Welcome to use this True Wireless Bluetooth headset, BTH109. Please read this user's manual carefully before use.

■ Brief introduction

BTH109 is a True Wireless Bluetooth Headset without any wire, each piece comes with one Mic that can be used individually or be used together for stereo sound. The headset support music and calling function.

■ Before use

1. Overview

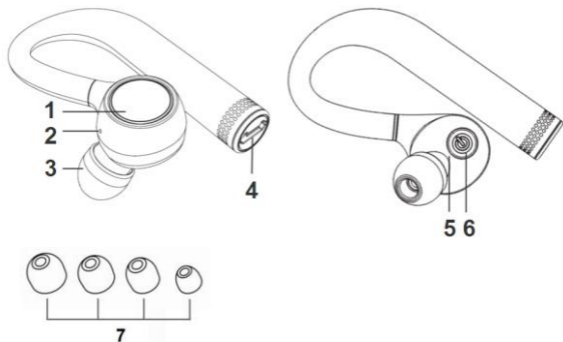

1	MFB touch-button	5	LED indicator
2	Microphone	6	Power on/off button
3	Ear tips	7	Four different size ear tips
4	Charging jack		

2. Charging for headset

When the headset is low power, the headset emits warning sound every 30s and the red LED flashes instead of blue LED Please recharge the battery of the headset.

The way of charging as following:

Using USB cable

1. Plug the USB charging cable to headset charging jack
2. Plug another side of cable to the USB port of PC

Red light on: Charging

Red light off: Finish charging

3. It will takes about 2 hours to finish charging

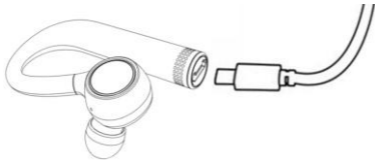

Remarks:

- 1) The battery is recyclable.
- 2) Batteries (battery pack or batteries installed) shall not be exposed to excessive heat place, such as sunshine, fire or the like.

■ Getting started

1. Wearing headset

- Choose the suitable size ear tips
- Wear the headset of L and R channel accordingly, adjust each earbuds for your ear to get best experience

2. Use one piece earbuds

In this mode one earbuds of headset connecting with device.

1. Power on: Press power key about 2s and release it till blue LED on, and earbuds prompt "Power on".

2. Pairing:

a. Power off mode: Press power key about 5s and release it till red LED and blue LED flash alternately, and earbuds prompt "Pairing"

b. Standby mode without connecting: Press power key about 2s and release it till red LED and blue LED flash alternately, and earbuds prompt "Pairing".

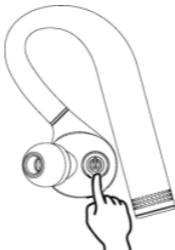

3. Connecting

Make sure the earbuds in pairing mode, find the Bluetooth name from search list and click it.

Bluetooth name : BTH109L is left earbuds, BTH109R is right earbuds

4. Power off: Press power key about 3s and release it till red LED on, and earbuds prompt "Power off".

Remark::

- ◆ The earbuds will automatically connecting with the latest Bluetooth device when power on
- ◆ The earbuds will automatically switch to standby mode if disconnect with device, and will power off automatically after 5 minutes to save power.
- ◆ The function operation are same for each earbuds.

3. Use two earbuds

In this mode use two earbuds at same to enjoy stereo sound. There are two ways for both earbuds to connect.

The first way as below:

1. Power on both earbuds, then they will connecting with each other automatically.

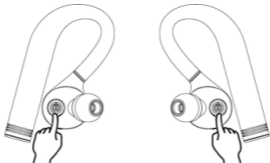

2. Press power key about 2s in one of earbuds to make it into pairing mode.
3. Active Bluetooth function in cellphone and connect headset name "BTH109L"/(BTH109R) in the list.

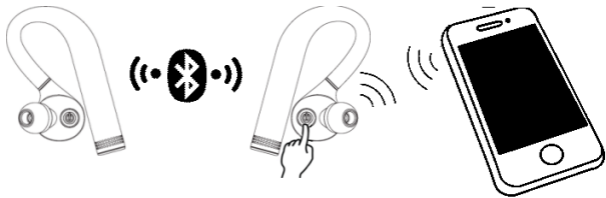

The second way as below:

Operate one of earbuds to connecting with cellphone, power on the other earbuds, then the two earbuds will connecting with each other automatically.

Remarks:

- ◆ Pairing mode keeps 2 minutes, the headset will switch to standby mode if no device connected in limited time, and they will power off automatically after 3 minutes.
- ◆ The headset will connecting with the latest device automatically when power on.
- ◆ The headset can reconnecting with devices automatically if return back to effective range within 5 minutes.

4. Earbuds pairing/connecting

1. Operate two earbuds to make them power on and enter pairing mode, red LED and blue LED flash alternately.
2. Press power key about 2s in one of earbud to enter search mode, red LED and blue LED slow flash.
3. Two earbuds will pairing and connecting.

Remarks:

- ◆ In normally the two earbuds will connecting automatically once power on,which set in factory.
- ◆ User can connect the two earbuds according above operation if they failed connecting.

5.Function operation-one earbuds connecting with cellphone.**a.Answer**

When calling(blue LED quick flash),click touch button once will answer the call,click touch button second will hang up the call.

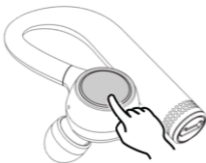
**b.Reject calling**

When calling(blue LED quick flash),long press touch button and release it till hear prompt tone"DUDU".

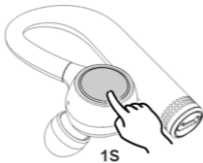

c. Voice assistant

After connect with cellphone(blue LED flash twice every 5s),then press touch button about 2s can active voice assistant like Siri.

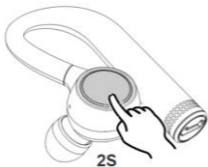
**d. Playing/Pause**

Connecting with cellphone,double click touch button will play music,double click again will pause playing.

**Double click****e. Next song**

Press touch button about 3s when in playing music.In this process will hear prompt tone of voice assistant,do not leave till it switch to next song.

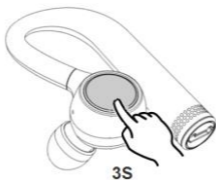

6. Function operation-two earbuds connecting with cellphone

- If two earbuds connect with cellphone, one of earbuds power off, the other one will be turned off also.
- If two earbuds connect with cellphone, operate any one earbud can control playing/pause/next song/voice assistant.

Remarks:

- ◆ The function of operation are same for one earbud or two earbuds.
- ◆ If headset in calling mode, only the earbuds connecting with cellphone can communicate and operate function.

7. Battery display

When the earbuds connected with IOS device, it will display the battery of earbuds on the device. When the earbuds is in low battery, power symbol show red. It emits you to charge for your headset

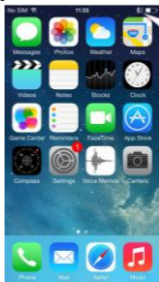
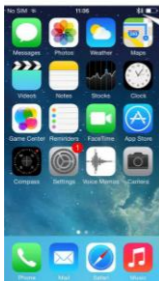

Full charge

Low battery

7. LED indicator

LED indicator	Status of headset
Emits warning tone every 30s	Low battery
Emits "DUDU" once every 15s	Headset out of range with cellphone(within 5 minutes)
Emits "DUDU" once every 10s	Out of range with the other earbuds(within 1 minutes)
Emits "DUDU" once every 5s	Searching
One "DU" tone	Max volume

8. Factory Reset

In the status of charging, long press power key about 5 seconds and release it until the red and blue LED flashes simultaneously, emits "DUDU" tone.

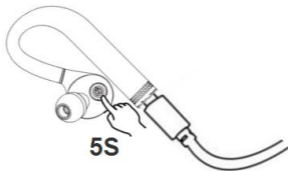
**Remarks:**

After factory reset, the paired list of earbuds will be deleted. After turn it on again, the earbuds will enter pairing mode automatically, and you need to re-pair and connect with Bluetooth devices.

But factory reset wont affect connecting with the other earbuds.

■ Care and maintenance

Read the following recommendations carefully before using BTH109. Following these you will be able to enjoy this product for many years.

- ◆ Keep it dry and don't put it in the damp place to avoid the product's internal circuit being affected. Don't wear the headset when in strong exercise to avoid sweat enter.
- ◆ Keep the product away from direct sunlight or hot places. High temperatures will shorten the life of electronic devices, destroy the battery or distort certain plastic parts.
- ◆ Don't expose the product to cold areas. It may damage the internal circuit board.
- ◆ Don't try to disassemble the product as it may get damaged if you are not professional.
- ◆ Don't let it fall down onto the floor or other hard surfaces. The internal circuit might get damaged.
- ◆ Don't use intensive chemical products or detergent to clean the product.
- ◆ Don't scratch the surface with sharp things.
- ◆ Don't use this product during strenuous exercise. It may get damaged by sweat.

In case the product doesn't function properly, send it to the store you bought it. The staff will help you to solve the problem

■ FAQs

1. What does it mean when red LED flashes instead of blue LED?

Battery is low power, need to be recharged.

2. Why is the red LED off when charging?

- a) Please make sure the charging device connect with headset well;
- b) The battery may dry up. Please charge the battery for 30 minutes, and then the red LED will be on.

3. Why can't I hear the sound on the headset?

- a) Make sure the volume is not too low or muted;
- b) Make sure the headset connects with the mobile phone correctly;
- c) Make sure the distance between the headset and the cell phone is in the available Bluetooth range.

4. Why can't I hear the sound clearly on the headset?

- a) Make sure the mobile phone is in the strong signal area;
- b) Make sure the headset is in the available range. and no other block.

5. Why the pause/play, last/next song not function when playing music?

Make sure your Bluetooth device supports AVRCP (Audio/Video Remote Control profile)

■ Specifications

Bluetooth version	Bluetooth V4.2
Bluetooth profiles	HFP, HSP, A2DP and AVRCP
Operating distance	10 meters
Music time	One earbuds: Up to 5 hours
	Two earbuds: Up to 4.5 hours
Talk time	UP to 5 hours
Standby time	About 80 hours
Charging time	About 2 hours
Charging input	DC 5.0V /500mA
Weight (one earbuds)	About 9.4 g
Measure	5.5*3.5*2.3cm

NOTE: This equipment has been tested and found to comply with the limits for a Class B digital device, pursuant to part 15 of the FCC Rules. These limits are designed to provide reasonable protection against harmful interference in a residential installation. This equipment generates uses and can radiate radio frequency energy and, if not installed and used in accordance with the instructions, may cause harmful interference to radio communications. However, there is no guarantee that interference will not occur in a particular installation. If this equipment does cause harmful interference to radio or television reception, which can be determined by turning the equipment off and on, the user is encouraged to try to correct the interference by one or more of the following measures:

- Reorient or relocate the receiving antenna.
- Increase the separation between the equipment and receiver.
- Connect the equipment into an outlet on a circuit different from that to which the receiver is connected.
- Consult the dealer or an experienced radio/TV technician for help

Changes or modifications not expressly approved by the party responsible for compliance could void the user's authority to operate the equipment. This device complies with Part 15 of the FCC Rules. Operation is subject to the following two conditions:

- (1) this device may not cause harmful interference, and
- (2) this device must accept any interference received, including interference that may cause undesired operation.