

User Guide

PANTUM

WWW.PANTUM.COM

Pantum P2200/P2500 Series Pantum P2600 Series Monochrome Laser Printer



It is recommended to carefully read this Guide before using the printer

Preface

Welcome to the Pantum series products!

We heartily appreciate your using of Pantum series products!

To protect your vital interests, please carefully read the following statements.

Legal Notice

Trademark

Pantum and Pantum 奔图 are registered trademarks of Zhuhai Pantum Electronics Co.,Ltd. in the mainland of China.

Microsoft[®], Windows[®], Windows Server[®] and Windows Vista[®] are trademarks registered by Microsoft Corporation in the United States or other countries/regions.

Wi-Fi[®] and Wi-Fi Protected Setup[™] are registered trademarks of the Wi-Fi Alliance.

The ownership to the names of the software in this User Guide belongs to their respective owned companies in accordance with corresponding license agreement, and they are referred for instructions only.

All other product and brand names herein may be the registered trademarks, trademarks or service marks of their respective owners, and they are referred for instructions only.

Copyright

The copyright of this User Guide is owned by Zhuhai Pantum Electronics Co.,Ltd.

It is prohibited to copy, translate, modify and transmit this User Guide by any means or forms without the prior written consent of Zhuhai Pantum Electronics Co.,Ltd.

Version: V1.1 EN

Disclaimer

For a better user experience, Zhuhai Pantum Electronics Co.,Ltd. reserves the right to make changes to the User Guide. The information contained herein is subject to change without notice.

Users are responsible for any damages arising from failing to follow this User Guide. Meanwhile, except the express warranty made in the product maintenance manual or service commitment, Zhuhai Pantum Electronics Co.,Ltd. does not make any express or implied warranty or guarantee to this User Guide (including composing or words).

Using this product to copy, print, scan certain documents or images or make other forms of operations may be prohibited by the local laws. If you are uncertain about the legality of using this product for certain documents or images, you should consult your legal advisor in advance.

Safety Precautions

Laser Safety

The laser radiation is harmful to the human body. Since laser components are completely sealed in the printer, laser radiation will not leak. To avoid laser radiation, please do not randomly disassemble the printer!









The printer follows the provisions of Class 1 laser products under CFR standard. The printer has a Class III B laser diode, which has no laser radiation leakage among laser components.

The following label is attached to the laser components inside the printer:

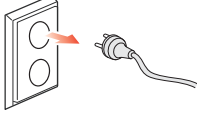

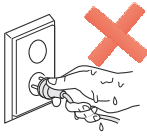
Safety Warning

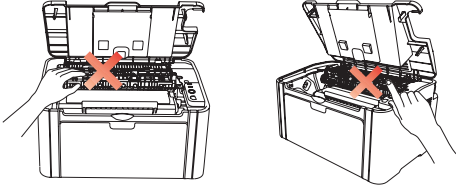
Please note the following safety warnings before using the printer:

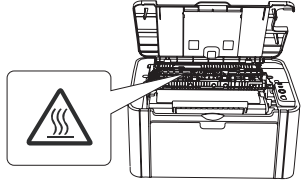
 Warning	
 <p>There is high-voltage electrode inside the printer. Before cleaning the printer, make sure the power is turned off!</p>	
 <p>Plugging and unplugging the power cord plug with a wet hand can result in an electric shock.</p>	
 <p>The fuser unit is hot when and after printing. Touching the fuser unit (the shaded area as shown) may cause burns!</p>	
 <p>The fuser unit is attached with a high temperature warning label. Please do not remove or damage this label.</p>	

Precautions

Precautions before Using the Printer:

1. Read and understand all instructions;
2. Familiarize yourself with the basic principles associated with operating electrical appliances;
3. Comply with all warnings and instructions marked on the equipment or specified in the manual supplied with the equipment;
4. If the operating instructions conflict with the safety information, please refer back to the safety information, as you may have misunderstood the operating instructions. If you cannot resolve the conflicts, please call the Customer Service Hotline or contact a service representative for help;
5. Before cleaning the equipment, remove the power cord from the AC power supply outlet. Do not use liquid or aerosol cleaners;
6. Please make sure that the equipment is put on a stable desktop surface to avoid serious damage caused by the falling of the equipment;
7. Do not put the equipment near a radiator, an air conditioner, or a ventilation pipe;
8. Do not place any articles on top of the power cord. Do not put the equipment in a place where its power cord will be stepped on by people;
9. Outlets and extension cords must not be overloaded. This may reduce performance and could result in fire or electric shock;
10. Do not allow pets to chew on the AC power cord or the computer interface cable;
11. Do not allow sharp objects piercing equipment slot, so as to avoid contact with the high-voltage device, which otherwise may result in fire or electric shock. Take care not to spill liquids onto the equipment;
12. Do not disassemble the equipment so as to avoid the risk of electric shock. Necessary repairs may only be carried out by professional maintenance personnel. Opening or removing the cover could result in an electric shock or other potential hazards. Incorrect disassembly and assembly could also result in an electric shock during future use;
13. If any one of the following occurs, disconnect the equipment from the computer and pull out the power cord from the AC wall socket and contact a qualified member of the service personnel for maintenance:
 - Liquid has been spilled into the equipment.
 - The equipment has been exposed to rain or water.
 - The equipment falls, or the cover is damaged.
 - Significant changes in the equipment's performance.
14. Only adjust the control mentioned in the instructions. Incorrect adjustment of other controls may result in damage and mean that professional maintenance personnel need to spend more time fixing it;
15. Do not use the equipment in a thunderstorm so as to avoid the risk of an electric shock. If possible, pull out the AC power cord during a thunderstorm;
16. If you continuously print multiple pages, the surface of the tray will become very hot. Take care not to touch this surface, and keep children away from this surface;
17. The signal wire of the device connected with the printer can not be connected to the outdoors;
18. Please ensure timely ventilation in case of a prolonged use or printing huge amounts of documents in a poorly ventilated room;
19. In standby status, the product will automatically enter into the power saving (sleep) mode if it does not receive any job order for a while (such as 1 minute); and it can realize zero power consumption only if it has not been connected with any external input power supply;
20. As the Class 1 equipment, the product must be connected to the power supply outlet with protective grounding line when using;
21. This product should be placed according to the shipping marks on the product package box during delivery;
22. This product is a kind of low-voltage equipment. When using this product below the specified voltage range, please refer to the product precautions or call Pantum Aftersales Service Centre, if the toner comes off the printed contents, or the equipment starts slowly;
23. This product is sold as a complete machine. The consumers can go to Pantum Aftersales Service Centre to purchase parts they need. If the product sold is inconsistent with the package list, please go to the specified Aftersales Service Centre to solve the problem;
24. Install this product in a place with the temperature between 10°C to 32.5°C, and the relative humidity between 20% to 80%;
25. For security and other reasons the printer may switch to intermittent printing after a certain amount of continuous printing.
26. This device complies with Industry Canada licence-exempt RSS standard(s). Operation is subject to the following two conditions:

-
- (1) this device may not cause interference, and
 - (2) this device must accept any interference, including interference that may cause undesired operation of the device.

27. IC Radiation Exposure Statement:

This equipment complies with Canada and FCC radiation exposure limits set forth for uncontrolled environments. This equipment should be installed and operated with a minimum distance of 20cm between the radiator and your body.

This transmitter must not be co-located or operating in conjunction with any other antenna or transmitter.

28. This equipment has been tested and found to comply with the limits for a Class B digital device, pursuant to Part 15 of the FCC Rules. These limits are designed to provide reasonable protection against harmful interference in a residential installation. This equipment generates, uses and can radiate radio frequency energy and, if not installed and used in accordance with the instructions, may cause harmful interference to radio communications. However, there is no guarantee that interference will not occur in a particular installation.

If this equipment does cause harmful interference to radio or television reception, which can be determined by turning the equipment off and on, the user is encouraged to try to correct the interference by one or more of the following measures:

- Reorient or relocate the receiving antenna.
- Increase the separation between the equipment and receiver.
- Connect the equipment into an outlet on a circuit different from that to which the receiver is connected.
- Consult the dealer or an experienced radio/TV technician for help.

29. Changes or modifications not expressly approved by the party responsible for compliance could void the user's authority to operate the equipment.

30. The power consumption of the product is 0.92W in networked standby if all wired network ports are connected and all wireless network ports are activated;

31. Please keep this User Guide properly.

Regulatory Information



This symbol indicates that, at the end of your product's life, it must not be discarded as domestic waste. Instead, you should dispose of your used equipment at a designated collection point for the recycling of waste electrical and electronic equipment. Ref: EU Directive 2002/96/EC on Waste Electrical and Electronic Equipment (WEEE). Please contact your distributor / supplier for further information.



This product is suitable for indoor use only.



European Community (EC) directives conformity

This product complies with the protection requirements of EC directives 2004/108/EC and 2006/95/EC on the approximation and harmonization of the laws of the Member States relating to electromagnetic compatibility and safety of electrical equipment designed for use within certain voltage limits.

The manufacturer of this product is: Zhuhai Pantum Electronics Co.,Ltd., Area A,3rd floor,Building No.1,No.3883,Zhuhai Avenue,Zhuhai,Guangdong,China

A declaration of conformity to the requirements of the Directives is available upon request from the Authorized Representative.

This product satisfies the Class B limits of EN 55022 and safety requirements of EN 60950.

CE1177



This printer is fully compliant with the ROHS Directive 2009/95/EC and the requirements of the revised Directive 2011/65/EU for managing toxic and hazardous substances.

Table of Contents

1. Before Using the Printer	1-2
1.1. Packing List	1-2
1.2. Components of the Printer	1-3
1.3. Laser Toner Cartridge	1-4
2. Paper and Print Media	2-2
2.1. Paper Specification	2-2
2.2. Special Paper	2-3
2.3. Loading Paper	2-4
2.3.1. Loading into the Automatic Feeder Tray	2-4
2.3.2. Loading into the Manual Feeder Tray	2-5
2.4. Nonprinting Area	2-7
2.5. Guidelines for Paper Use	2-7
3. Installation and Uninstallation of the Driver Software	3-2
3.1. Windows-based Driver	3-2
3.1.1. Driver Installation	3-2
3.1.2. Uninstallation	3-8
3.2. Installation of the Driver Software on a Mac System	3-10
4. Wired Network Settings (For wired network printer models)	4-2
4.1. Set IP Address	4-2
4.2. Install the Printer to Network	4-3
4.3. Setting Network Products	4-4
4.3.1. View or Change Network Settings	4-4
4.3.2. Set or Change Web Server Login Password	4-4
4.3.3. Restore to Factory Settings	4-4
5. Wireless settings (for models with Wi-Fi printing)	5-2
5.1. Wireless Network Type	5-2
5.1.1. Configuration with infrastructure mode	5-2
5.1.2. Configuration with Soft-AP	5-8
5.2. Turn off the Wireless Device	5-8
6. Pantum Mobile Print	6-2
6.1. What's Pantum Mobile Print	6-2
6.2. Download Pantum Mobile Print	6-2
6.3. Supported Mobile Operating System	6-2
6.4. How to use mobile devices for the mobile printing	6-2
6.4.1. Mobile Printing via Printer Hotspot	6-2
6.4.2. Mobile Printing via Wi-Fi Access Points (for All Mobile Devices)	6-6
7. Print	7-2
7.1. Print Function	7-2
7.2. Opening Help Document	7-3
7.3. Manual Duplex	7-4
7.4. Cancel Print Job	7-7
8. Control Panel	8-2
8.1. Control Panel Overview	8-2
8.1.1. Functions of Buttons on the Control Panel	8-2
8.1.2. Function of LED Indicators on the Control Panel	8-3
9. Routine Maintenance	9-2
9.1. Cleaning the Printer	9-2
9.2. Maintenance of Laser Toner Cartridge	9-4

9.2.1. Use and Maintenance of Laser Toner Cartridge	9-4
9.2.2. Service Life of Laser Toner Cartridge.	9-4
9.2.3. Replace Laser Toner Cartridge	9-5
10. Troubleshooting	10-2
10.1. Clearing Jammed Paper	10-2
10.1.1. Paper Jam in the Feed Port	10-3
10.2. Common Troubleshooting.	10-6
10.2.1. Common Trouble	10-6
10.2.2. Image Defects	10-8
11. Product Specification	11-2
11.1. P2200/P2500 Series Specification.	11-2
11.1.1. Specification Overview	11-2
11.1.2. Printing Specification.	11-3
11.2. P2600 Series Specification	11-4
11.2.1. Specification Overview	11-4
11.2.2. Printing Specification.	11-5

Before Using the Printer

1







Chapter

1. Before Using the Printer	2
1.1. Packing List	2
1.2. Components of the Printer.....	3
1.3. Laser Toner Cartridge	4

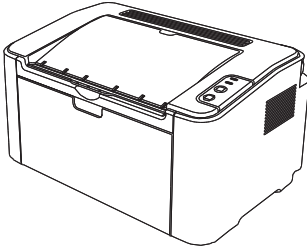
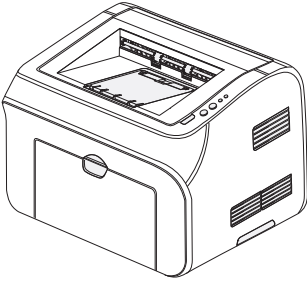
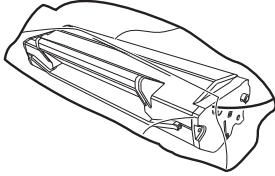
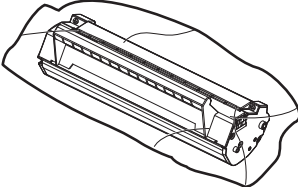
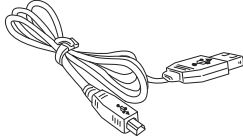
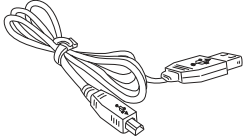
1. Before Using the Printer

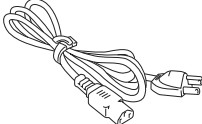
1.1. Packing List

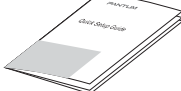
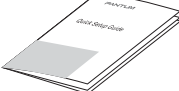
When you open the package, make sure that the following parts are included in the carton:

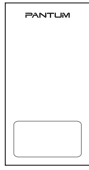
P2200/P2500 Series	P2600 Series	Name	Quantity
		Printer	1
		Laser Toner Cartridge	1
		USB Interface Cable	1
		Power Cord	1
		CD-ROM	1
		Quick Setup Guide	1
		Pantum Warranty	1



Note: • The Pantum Warranty may not be attached in some regions.

1.2. Components of the Printer

| Front View

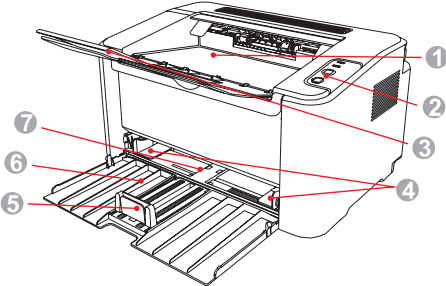
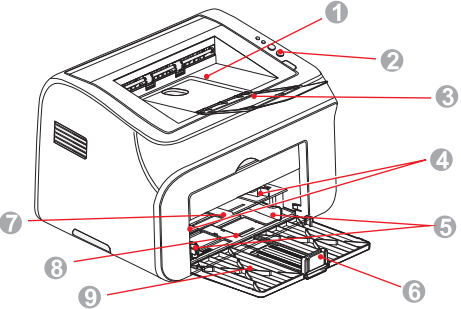
Serial No.	P2200/P2500 Series	P2600 Series
		
1	Output Bin	Output Bin
2	Control Panel	Control Panel
3	Output Tray	Output Tray
4	Automatic Feed Guide	Manual Feed Guide
5	Paper Stop	Automatic Feed Guide
6	Feeder Tray	Paper Stop
7	Automatic Feeder Tray	Manual Feeder Tray
8		Automatic Feeder Tray
9		Feeder Tray

| Rear View

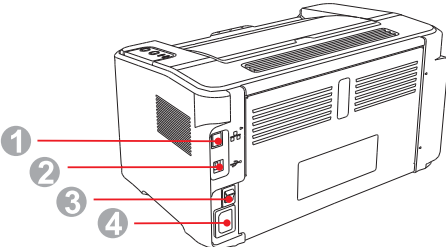
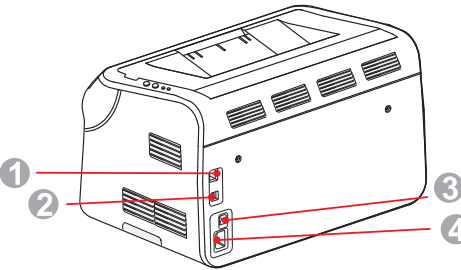

Note: • The rear view of the printer may vary depending on the models and functions.

Serial No.	P2200/P2500 Series	P2600 Series
		
1	Network Interface	Network Interface
2	USB Interface	USB Interface
3	Power Switch	Power Switch
4	Power Interface	Power Interface

1.3. Laser Toner Cartridge

| Service Life of the Laser Toner Cartridge

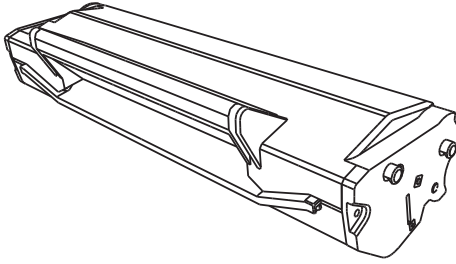
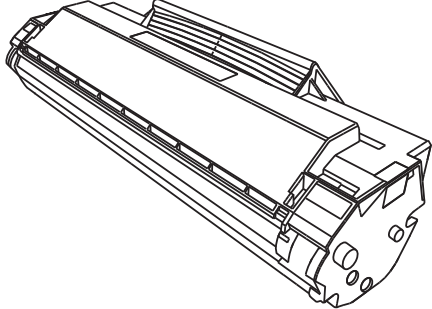
Series Name	P2200/P2500 Series	P2600 Series
Diagram		
Type	Average Print Volume	
Laser Toner Cartridge with Standard Capacity	About 1600 Pages (The above data is based on ISO/IEC 19752 standard)	About 1500 Pages (The above data is based on ISO/IEC 19752 standard)
Laser Toner Cartridge with High Capacity	N/A	About 2300 Pages (The above data is based on ISO/IEC 19752 standard)



Note: • The model is subject to increase without notice.

- Consumables capacity may vary depending on the types used.
- The Company does not recommend using consumables other than that of the original Pantum consumables.
- Any damages caused by using non-Pantum original consumables are not covered by the Warranty.

Paper and Print Media

2

Chapter

2. Paper and Print Media.....	2
2.1. Paper Specification.....	2
2.2. Special Paper	3
2.3. Loading Paper	4
2.3.1. Loading into the Automatic Feeder Tray	4
2.3.2. Loading into the Manual Feeder Tray	5
2.4. Nonprinting Area	7
2.5. Guidelines for Paper Use.....	7

2. Paper and Print Media

2.1. Paper Specification

P2200/P2500 Series P2600 Series	Automatic Feeder Tray	Media Type	Plain, thin, special paper (transparency, cardstock, label, envelope, thick, etc.).
		Media Size	A4, A5, JIS B5, ISO B5, A6, Letter, Legal, Executive, Folio, Oficio, Statement, Japanese Postcard, Monarch Env, DL Env, C5 Env, C6, Env, No.10 Env, ZL, Big 16K, Big 32K, 16K, 32K, B6, Yougata4, Postcard, Younaga3, Nagagata3, Yougata2, custom, etc.
		Media Weight	60~163g/m ²
		Maximum Capacity of the Tray	150 pages 80g/m ²
P2600 Series	Manual Feeder Tray	Media Type	Plain, thin, special paper (transparency, cardstock, label, envelope, thick, etc.).
		Media Weight	60~163g/m ²
		Maximum Capacity of the Tray	1 page



Note: • It is recommended to use the standard paper for the printer.

- Extensive use of special paper may affect the service life of the printer.
- The print media that does not meet the guidelines set out in this User Guide may result in poor print quality, increased paper jam and excessive wear of the printer.
- Properties such as weight, composition, texture and humidity are important factors affecting the printer performance and output quality.
- Please note the following matters when selecting the print media:
 1. Desired print effect: The print media selected should meet the requirement of the print tasks.
 2. Surface smoothness: The smoothness of the print media may affect the sharpness of the print outcome.
 3. Some print media may meet all the use guidelines contained herein, but they still can not bring satisfactory effect. This may be due to incorrect operation, inappropriate temperature and humidity, or other factors beyond the control of Pantum. Before purchasing large quantities of print media, make sure that the print media meets the specifications specified in this User Guide.
 4. Using print media that does not meet these specifications may cause damage to the printer.

2.2. Special Paper

This printer supports using the special paper for printing. Special paper includes: label, envelope, transparency, thick, cardstock, etc.



-
- Note:** • When using special paper or print media, be sure to select matched print type and size in the print settings so as to get the best print effect.
- When using special media to print, it is recommended to load one piece of paper at one time. For P2200/P2500 series, load one piece of special paper into the automatic feeder tray at one time. For P2600 series, load one piece of special paper into the manual feeder tray at one time.
-

| Please observe the following standards:

Types of Print Media	Correct Practices	Incorrect Practices
Label	Use labels with no exposed lining paper only. Labels shall be put flat when using. Use labels of full sheet only. There is no guarantee that all the labels in the market can meet corresponding requirements.	Use wrinkled, blistering or damaged labels.
Envelope	Envelopes should be loaded evenly.	Use wrinkled, nicked, stuck or damaged envelopes. Use envelopes with clips, snaps, windows, or coated linings. Use envelopes with self-adhesive stickers or other synthetic materials.
Transparency	Use only transparencies approved for use in laser printers.	Use transparent print media that is not suitable for laser printers.
Thick, Cardstock	Use only heavy paper that is approved for use in laser printers and meets the weight specifications of this printer.	Use paper whose weight exceeds the recommended media specifications of this printer.

2.3. Loading Paper

2.3.1. Loading into the Automatic Feeder Tray

a) Open the feeder tray.

P2500 Series

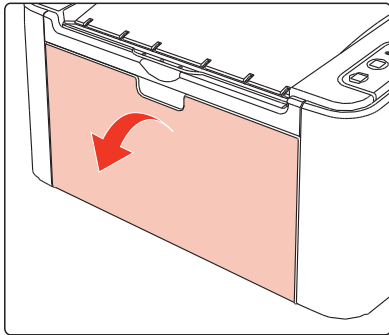

P2600 Series

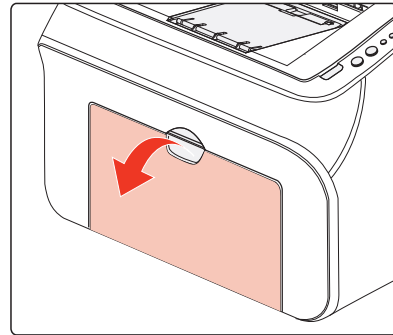

b) Slide the automatic feed guides to match both sides of the paper.

P2500 Series

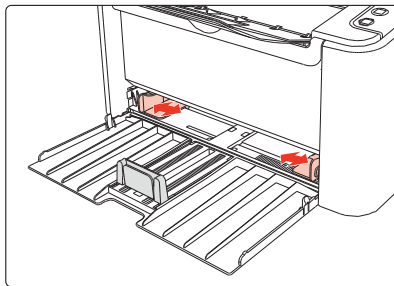

P2600 Series

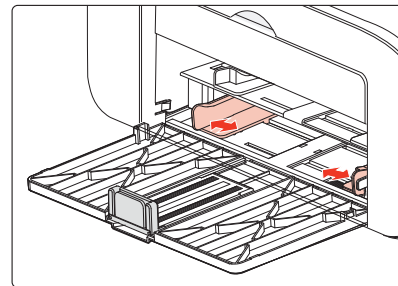

c) Raise the output tray to avoid the paper from slipping and falling.

P2500 Series

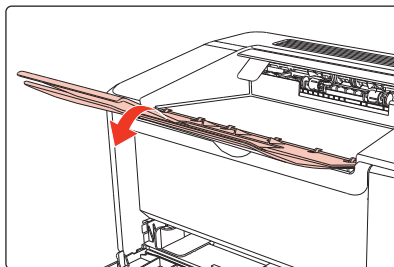

P2600 Series

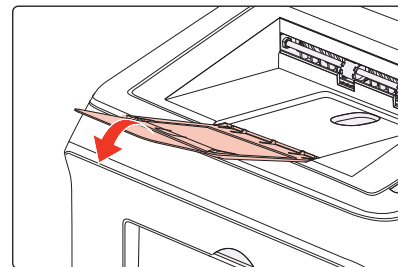

d) Load the paper into the automatic feeder tray with the print-side up.

P2200/P2500 Series

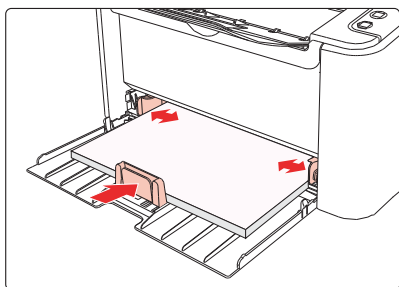

P2600 Series

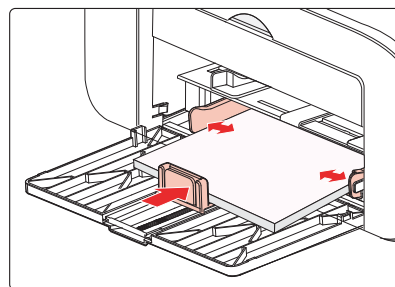

e) Adjust the paper stop to match the paper size.

P2200/P2500 Series

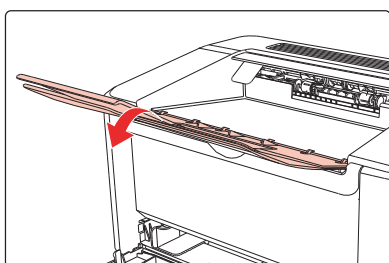

P2600 Series

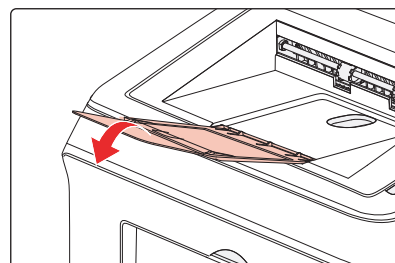

- Note:**
- If the paper loaded into the automatic feeder tray at one time exceeds 150 pages, paper will jam or cannot be fed in.
 - When using the printed paper, please make the side to be printed (the blank side) up.
 - When printing on A5 paper, it is recommended that the paper is fed in landscape orientation, which can extend the service life of the laser toner cartridge.

2.3.2. Loading into the Manual Feeder Tray



- Note:** • Only P2600 series products support manual feeding.

a) Open the feeder tray.

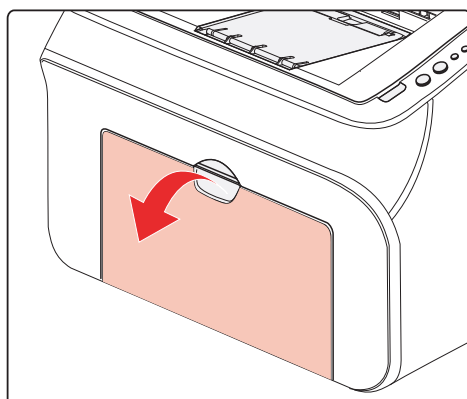



d) Load the paper into the automatic feeder tray with the print-side up.

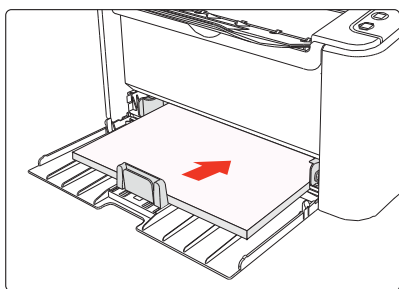

P2500 Series

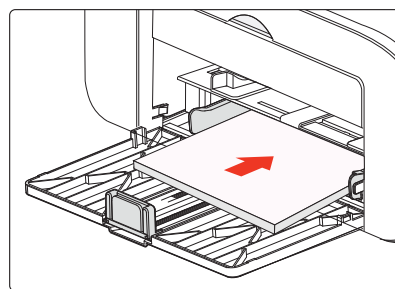

P2600 Series



 **Note:** • Before loading paper, please unfold the stacked paper to avoid a paper jam or feed error, and then load the paper into the tray print-side up.

e) Adjust the paper stop to keep the paper in position. To ensure normal paper feeding, adjust the bottom paper stop  into the slot to keep it from slipping out, and then adjust the blue stop  to match the paper size.

P2500 Series

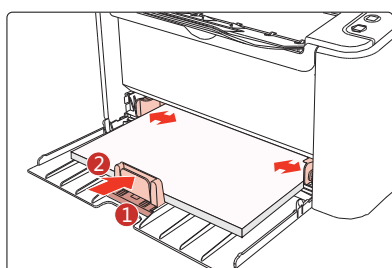

P2600 Series

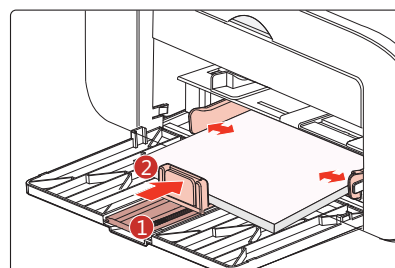

 **Note:** • If the paper loaded into the automatic feeder tray at one time exceeds 150 pages, paper will jam or cannot be fed in.

- When using the printed paper, please make the side to be printed (the blank side) up.
- When printing on A5 paper, it is recommended that the paper is fed in landscape orientation, which can extend the service life of the laser toner cartridge.

2.3.2. Loading into the Manual Feeder Tray

 **Note:** • Only P2600 series products support manual feeding.

a) Open the feeder tray.

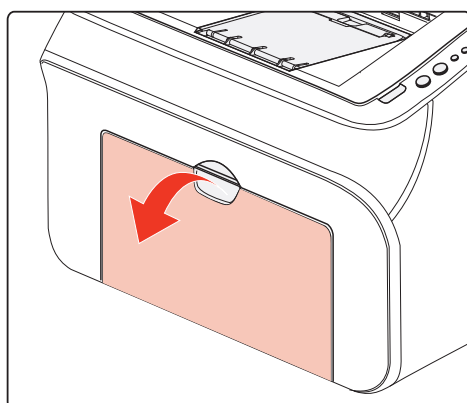

b) Slide the manual feed guides to match both sides of the paper.

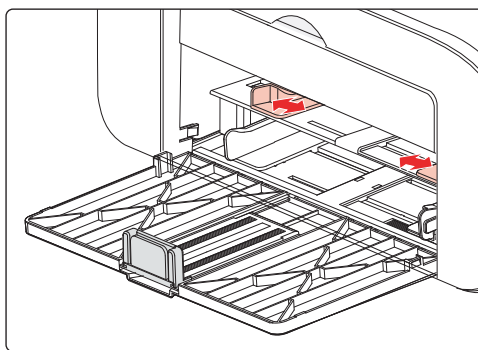

c) Raise the output tray to avoid the paper from slipping and falling.

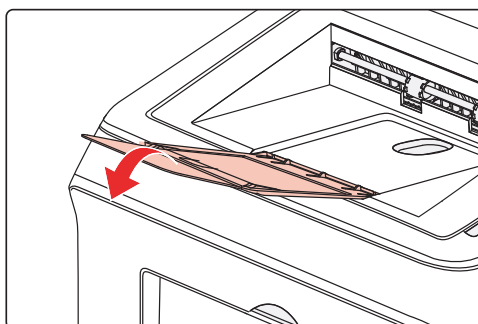

d) Put the print media like an envelope or transparency into the manual feeder tray with two hands until the front end of the envelope or transparency contacts the correction roller.

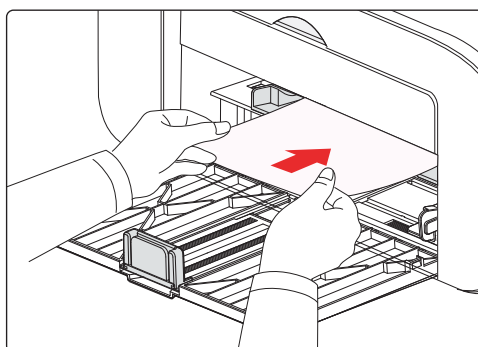

Note: • When loading paper into the manual feeder tray, the printer will automatically enable the manual feed mode.

- Load the paper into the manual feeder tray with the print-side up. When loading, the top of the paper first enters into the manual feeder tray.
- Ensure that the paper, envelope or transparency is loaded straightly and in the correct position of the manual feeder tray. Otherwise, it will result in a skewed printout or a paper jam.

e) After the printed page is output from the printer, load another paper according to the above steps to continue printing.

Warning



After printing, please immediately remove the paper, envelopes and transparencies. Stacking paper or envelopes may cause a paper jam or the paper curling.

2.4. Nonprinting Area

The shaded section indicates the nonprinting area.

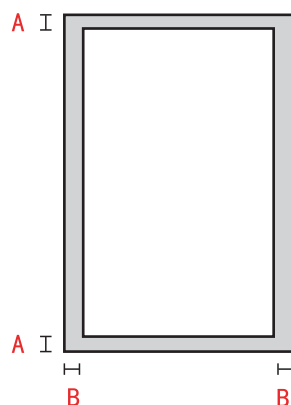

Usage	Paper Size	Top and Bottom Margins (A)	Left and Right Margins (B)
Printing	A4	5 mm (0.197 inch)	5 mm (0.197 inch)
	Letter	5 mm (0.197 inch)	5 mm (0.197 inch)

2.5. Guidelines for Paper Use

- Paper or manuscript with rough texture, concave and convex, oil stain and good smoothness has poor printing performance.
- Please make sure that there is no dust, fluff, etc. on the paper.
- Paper shall be put on a flat surface and stored under a cool and dry environment.

Installation and Uninstallation of the Driver Software

3

Chapter

3. Installation and Uninstallation of the Driver Software	2
3.1. Windows-based Driver.....	2
3.1.1. Driver Installation	2
3.1.2. Uninstallation	8
3.2. Installation of the Driver Software on a Mac System	10

3. Installation and Uninstallation of the Driver Software

3.1. Windows-based Driver

3.1.1. Driver Installation

1. Introduction

Driver software helps users to run the installer and uninstaller through the installation and uninstallation wizards, which provides the following modules and key functions:

- Autorun completes the autoruning of the installation CD.
- Installation: Provides users with the installation wizard of the printer driver.
- Uninstallation: Provides users with the uninstallation wizard of the printer driver.



Note: • For users of Windows XP and Windows Server 2003, when connecting the printer device for the first time, New Hardware Wizard Found window will pop up. You should close this window. If this window is not closed, the printer may not be detected, resulting in failure of installation.

2. Installation Steps

1) Running Interface

After inserting the installation CD, the Pantum interface will pop up and the installation CD will run automatically. See the figure below:



User authentication will be performed before the program runs. If the user is an administrator, this interface will be displayed. If the user is not an administrator, the prompt "Insufficient privileges. Please install the Pantum P2200-P2500-P2600 Series Printer with administrator privileges." will pop up.

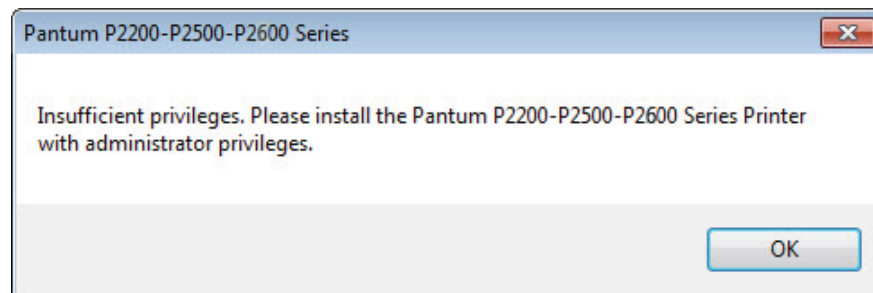

2) Language Interface (One-click Installation)

When the Autorun completes, the language interface appears for the connected P2200/P2500/P2600 model, where you can choose the different languages as you like. Click Install to go to the Installation Process interface.



Note: • you can click to see the user guide and the content of the License Agreement.

3) Configuration Interface (Standard Installation)

a) Installation Configuration

If no printer is connected when the Autorun completes, the Configuration Interface appears where you can choose the different language, model and installation mode as you like. Then click Next.

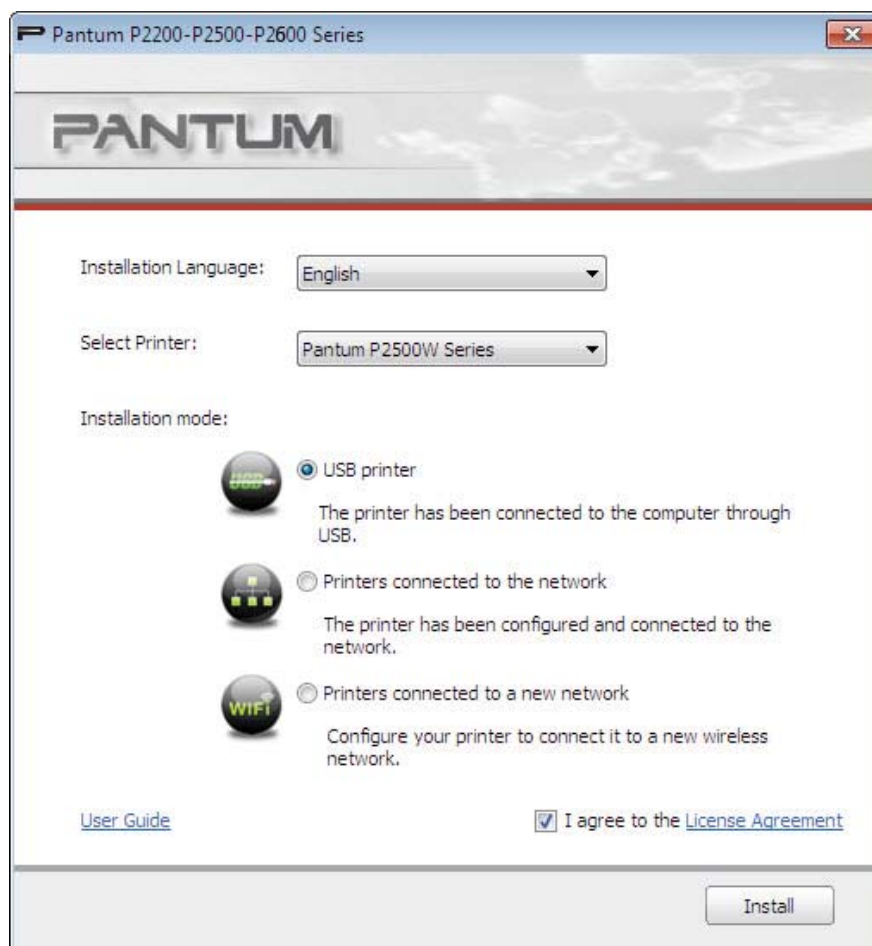

Note: This interface adjusts the installation mode depending on the different printer models selected here. You only need to check the available options of installation mode. The interface flow is shown below.

- For USB-enabled models or models with the installation mode of USB printer: Configuration interface — Installation Process interface — Installation Complete interface
- For network models with the installation mode of network printer: Configuration interface — Search for Printers interface — Printer List interface — Installation Process interface — Installation Complete interface

If the USB printer is selected: In this interface, click Next to enter the Installation Process interface.

If the printer connected to a network is selected: In this interface, click Next to enter the Search for Printers interface.

If the printer connected to a new network is selected: When you click Next, the WIFI Configuration Tool will be automatically invoked.

b) WIFI Configuration Tool Interface (For wireless models only):

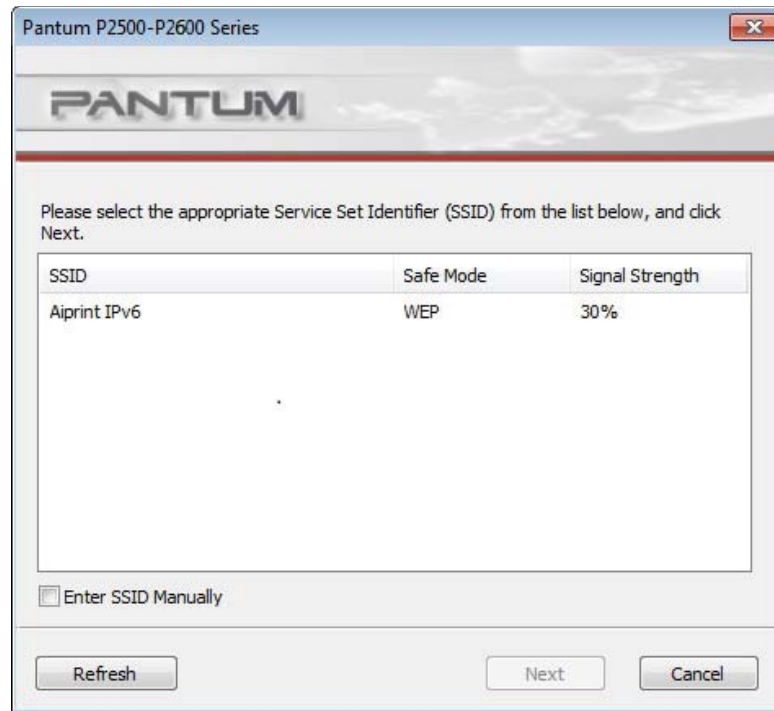

Follow the instructions in each step of the WIFI Configuration Tool to configure the printer and connect to a wireless network. For the detailed steps, please refer to Chapter 5.1.1.1.

c) Search for Printers

After entering Search for Printers interface, the program will automatically search for the appropriate connected printer on the network.

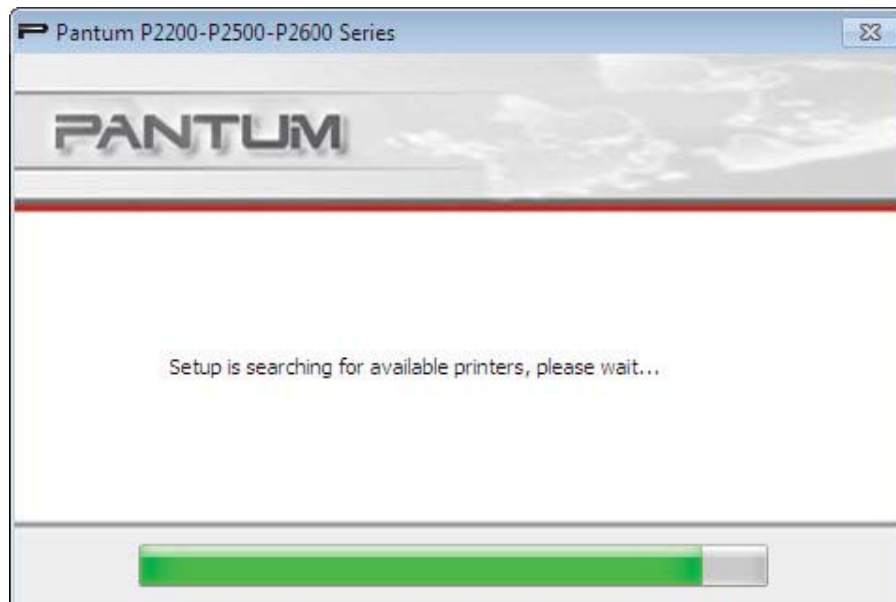

d) Printer List

When the searching completes, the Printer List interface appears where you can choose one or more network printer(s) you want to install.



4) Installation Process

This interface is mainly used for the installation of driver softwares.

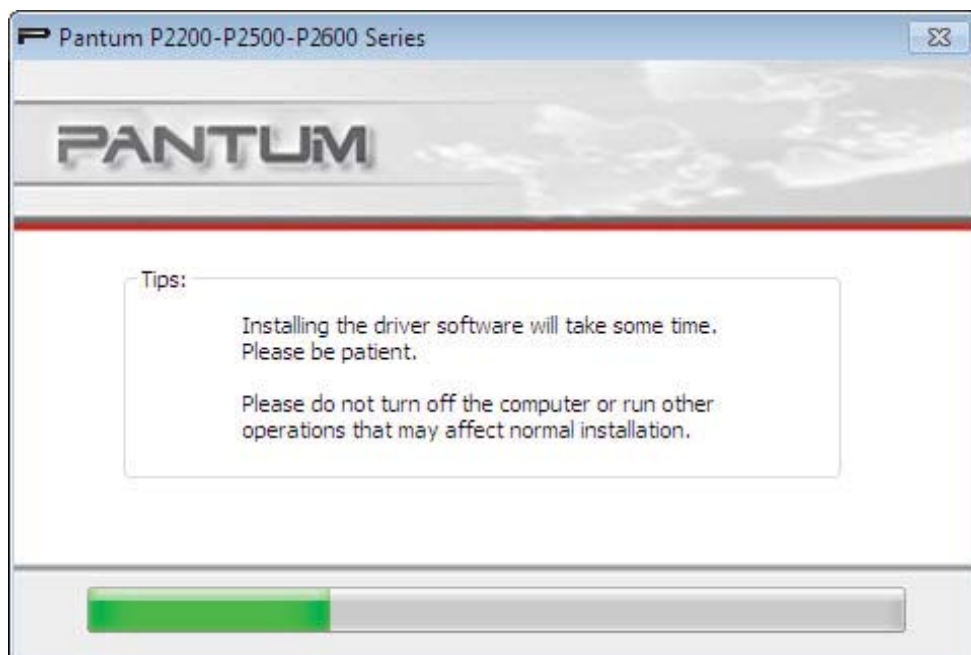

5) Installation Complete Interface

This interface shows you the driver installation is completed and quits automatically after a few seconds.



3.1.2. Uninstallation

1) Select Uninstallation Mode.

In the Start menu, select Pantum uninstallation icon to enter the uninstallation interface, or find Add/Remove in the Control Panel, find relevant Pantum options, and click Change and Delete. The uninstaller will pop up.



2) Uninstallation Privilege Verification

Uninstallation requires administrator privileges. If a non-administrator runs the uninstaller, this prompt will pop up: "Insufficient privileges. Please uninstall the printer with administrator privileges. "

If any jobs remain in the print queue, a warning will pop up, saying "The Pantum P2200-P2500-P2600 Series Laser Printer is in use. Please uninstall the driver after the printing is completed."

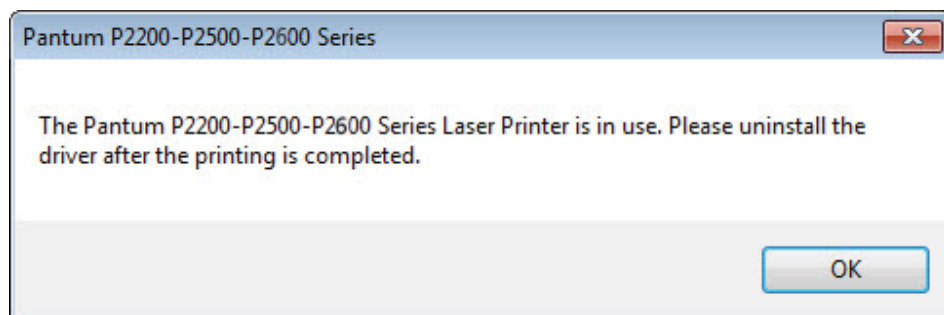

3) Uninstallation Interface

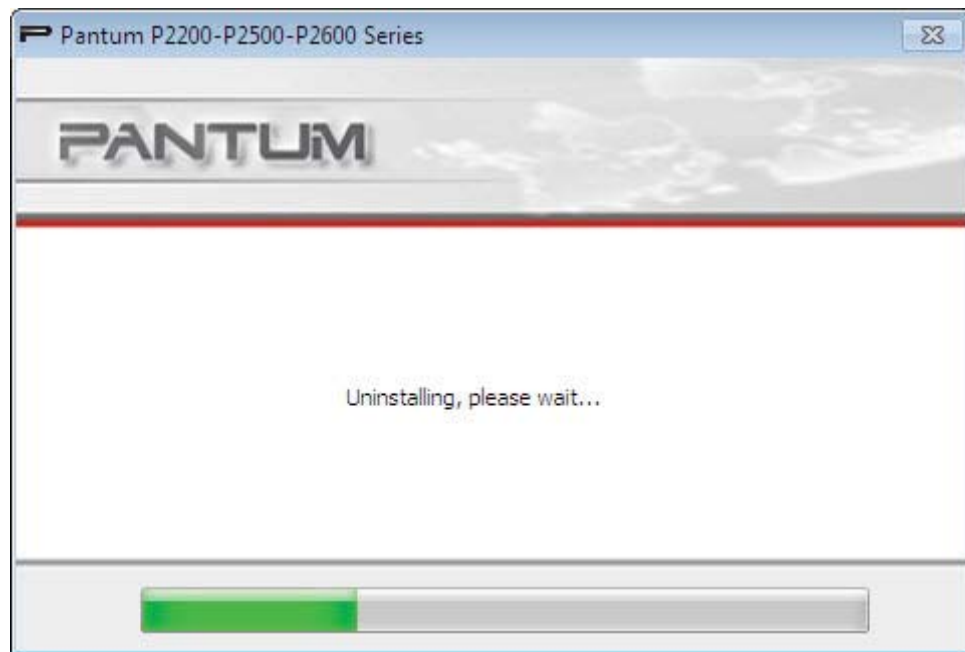

4) Complete Interface

After the uninstallation progress bar completes, the program will automatically switch to Uninstall Complete interface. Click Done to complete the uninstallation successfully.

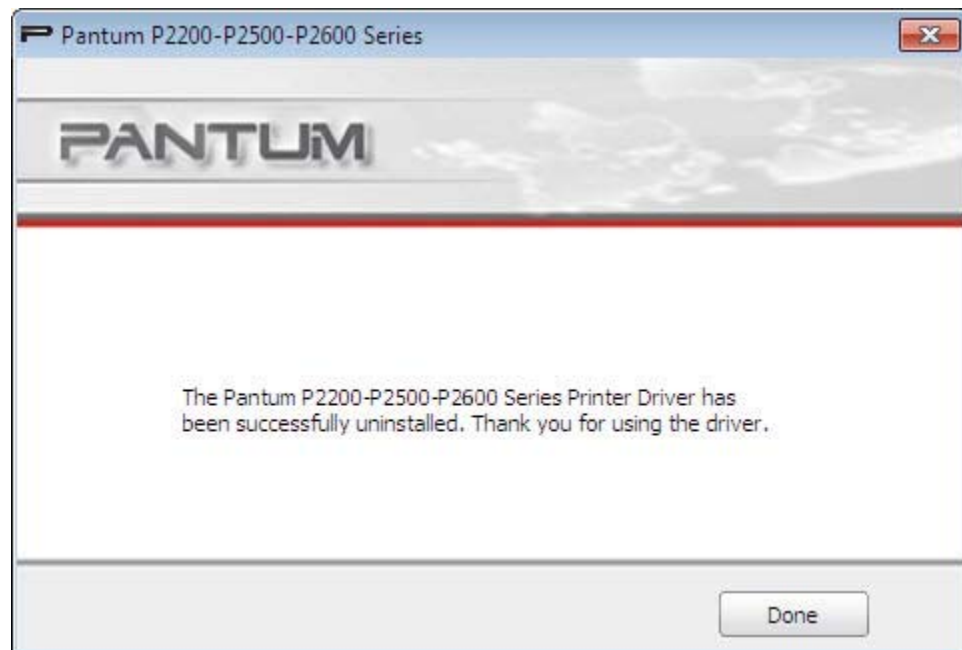

3.2. Installation of the Driver Software on a Mac System

Mac driver installer is created by using the Package Maker software that comes with the Mac system. The installation procedure is basically consistent with the installation of any ordinary software under Mac. The installation consists of the following steps: introduction, license, destination volume, installation type, installation, summary.

1) Introduction

Display the content of License Agreement.

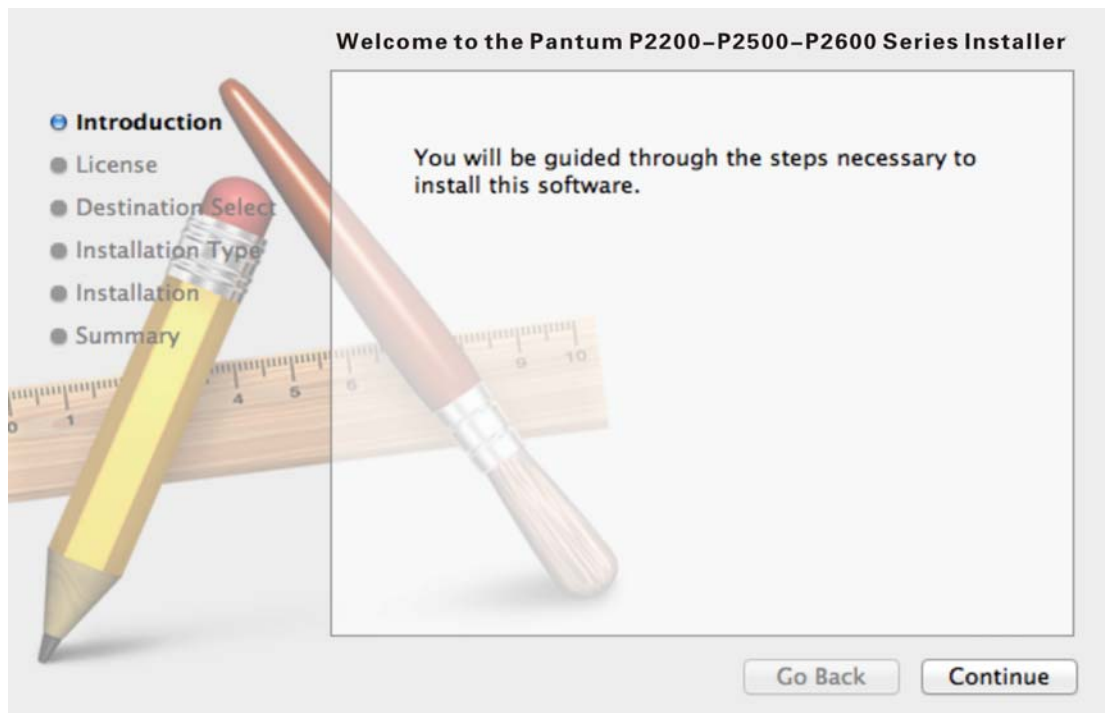

2) License

The content of License Agreement, as shown below.

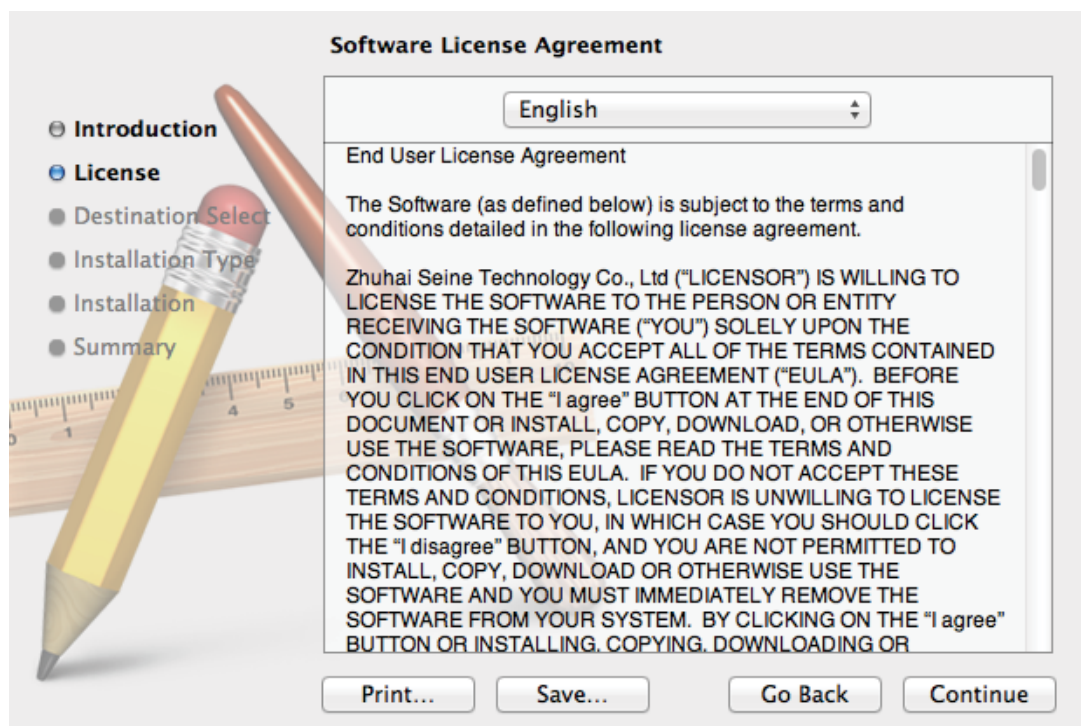

Click Continue. "To continue installing the software you must agree to the terms of the Software License Agreement. " dialog box will pop up.

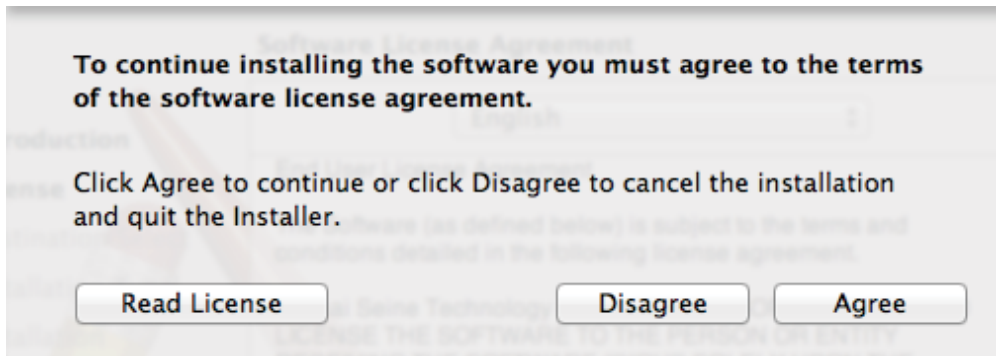

Click Agree to accept the License Agreement and continue the installation.

3) Installation Type

Display the installation-related information, as shown below.

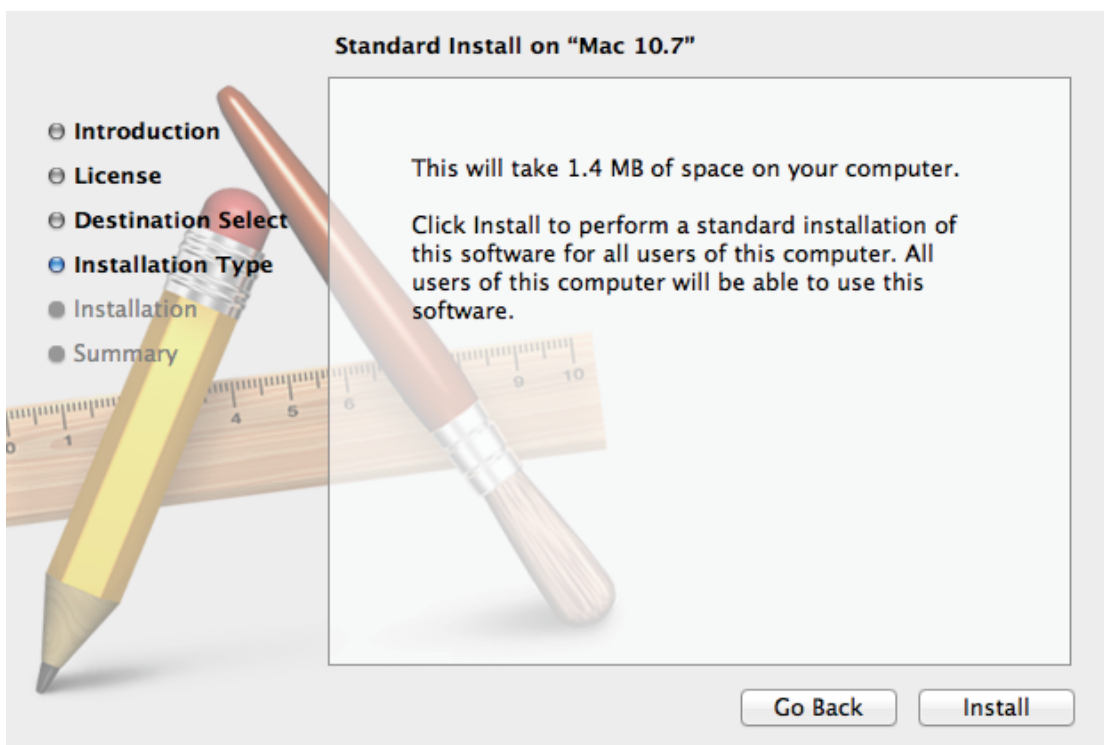

Click Install, the following prompt box will pop up. After logging in as an administrator and getting permission, you can continue with the installation.

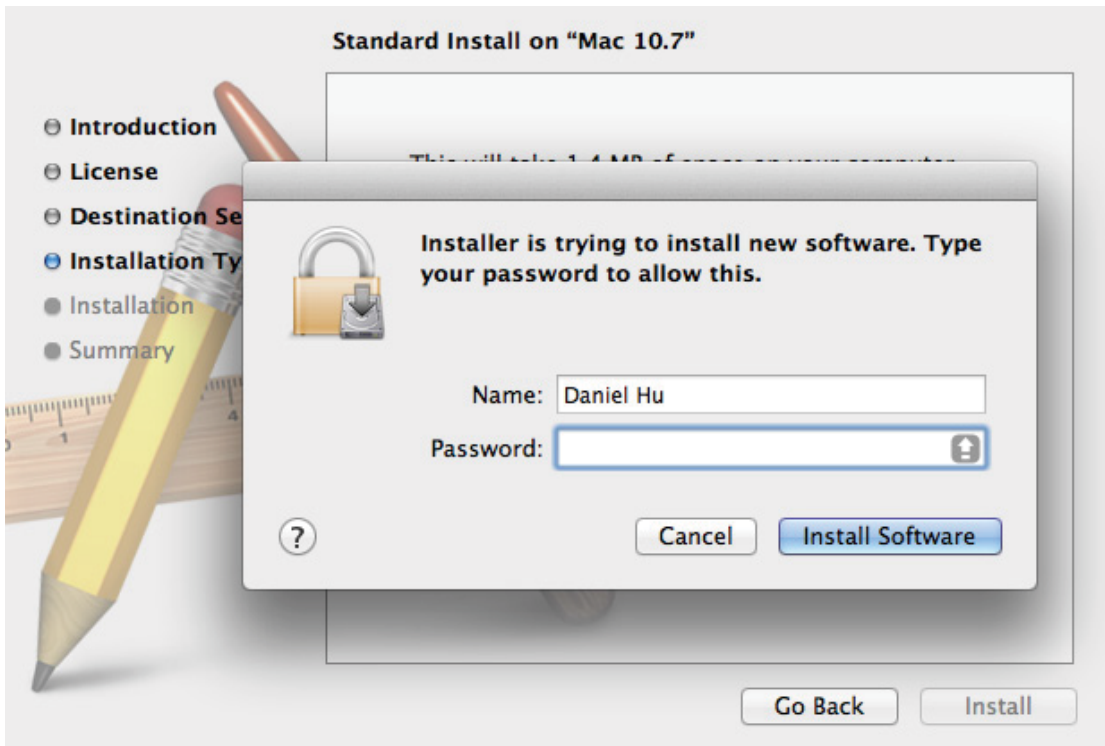

4) Installation

The installation progress, as shown below.

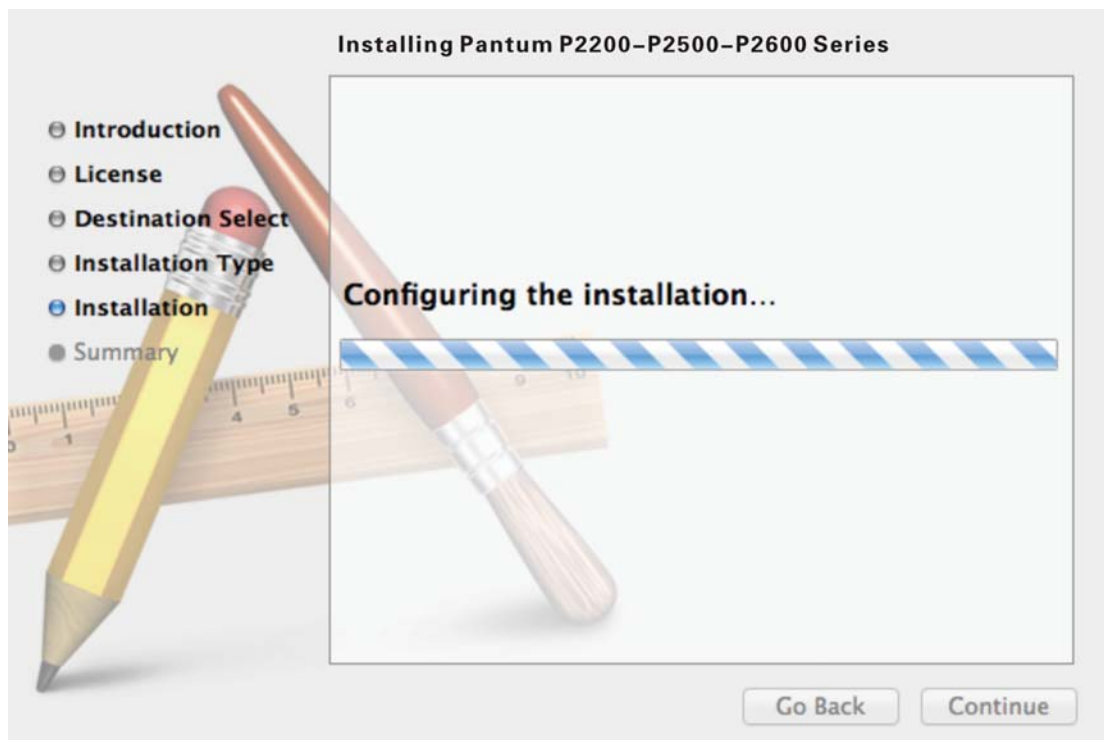

5) Summary

The installation completes, as shown below.

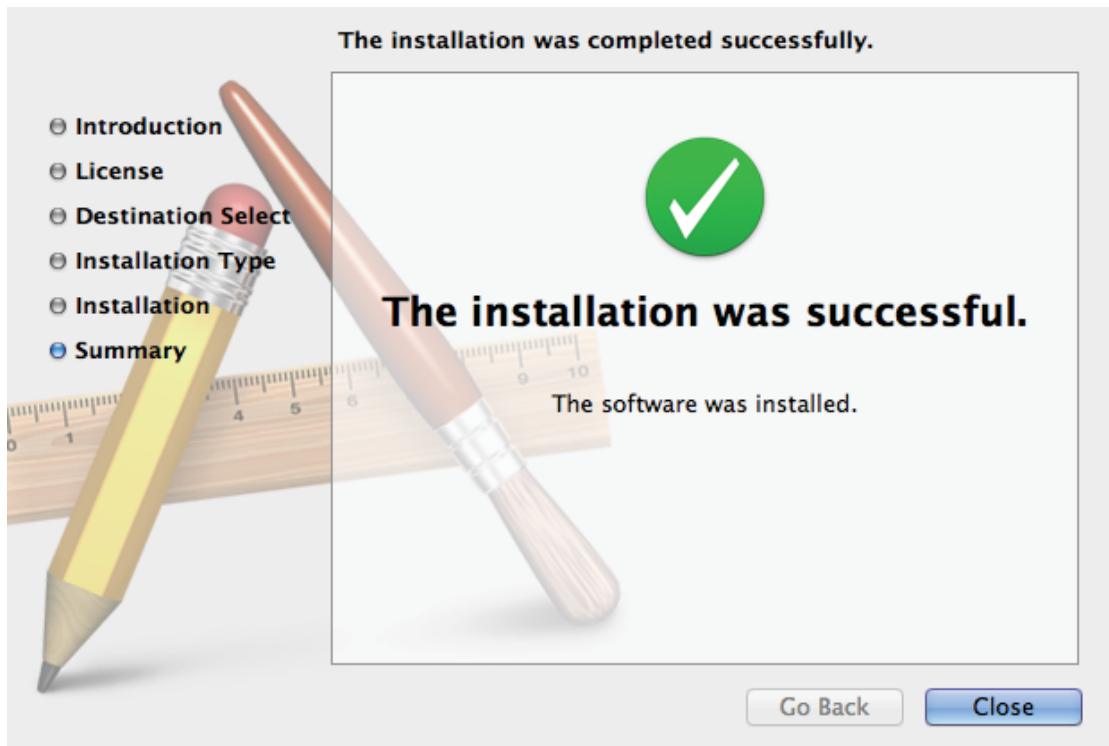

Note: • There is no need for uninstallation on Mac. You can install the new version directly even when a previous version exists on the computer.

Wired Network Settings (For wired network printer models)

4

Chapter

4. Wired Network Settings (For wired network printer models).....	2
4.1. Set IP Address	2
4.2. Install the Printer to Network.....	3
4.3. Setting Network Products	4
4.3.1. View or Change Network Settings	4
4.3.2. Set or Change Web Server Login Password	4
4.3.3. Restore to Factory Settings	4

4. Wired Network Settings (For wired network printer models)

You may need to set some network parameters on the printer. These parameters can be set from the embedded Web server.

4.1. Set IP Address

The IP address of the printer may be automatically obtained through DHCP function or set manually.

| Automatic Setting

DHCP automatic setting function is enabled by default on the printer.

1. Connect the printer to the network through a network cable and complete the startup preparation work.
2. The printer will automatically obtain the IP address assigned by the server. The IP address obtained automatically can be used after a few minutes.



Note: • If DHCP cannot automatically obtain the IP address, the printer will automatically use the default IP address: 169.254.xx.xx.

- Due to the features of DHCP, the IP address of the printer automatically assigned by the network may vary if the printer has not been used for a long time or the network access point changes, which could result in unsuccessful connection to the printer. It is recommended that the IP address automatically assigned by the network is bound to the MAC address of the printer while the DHCP function is enabled.

| Manual Setting

Type the IP address in the Web browser's address bar to open the embedded Web server.

1. Click Settings in the navigation bar to open the Settings page;
2. Select Network Settings - IPV4 Settings;
3. Set IP Address Assignment Mode (Manual), IP Address and Subnet Mask. Other items are optional;
4. Click Apply to save the settings.



Note: • You can use the embedded Web server to change the IP Address Assignment Mode into Automatic or Manual.

4.2. Install the Printer to Network

In this setting, the printer is directly connected to the network and can be set to allow all computers on the network to print directly on the printer.

1. Before starting the printer, first connect the network cable to the network port of the printer to establish direct connection to the network.
2. Start the printer and wait until the status indicator on the control panel displays Ready status, as shown below.

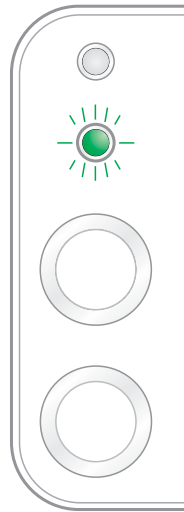

3. Insert the printer CD into the computer. If the software installer does not start, browse to the "setup.exe" file on the CD, and double-click to run the file.
4. Follow the operation instructions of the installer.
5. Continue to complete the installation.



Note: • When the installer prompts you to select a printer, you can select the appropriate printer name from the Detected Printer;

- If the printer name does not appear in the Detected Printer, please click Refresh and search for printers on the network;
- If you know the IP address of the printer to be connected, you can select Specify an IP Address for Installation to enter the IP address for installation.

4.3. Setting Network Products

4.3.1. View or Change Network Settings

You can use the embedded Web server to view or change IP settings.

1. Long press the "Cancel/Continue" button on the control panel to print DEMO information page, and view the IP address of the printer. DEMO page can be printed by long pressing the button on the control panel (as shown in the figure below) in the idle status.
2. Type the IP address in the Web browser's address bar to access the embedded Web server.
3. Click Settings tab to obtain network information. Change the settings as needed.

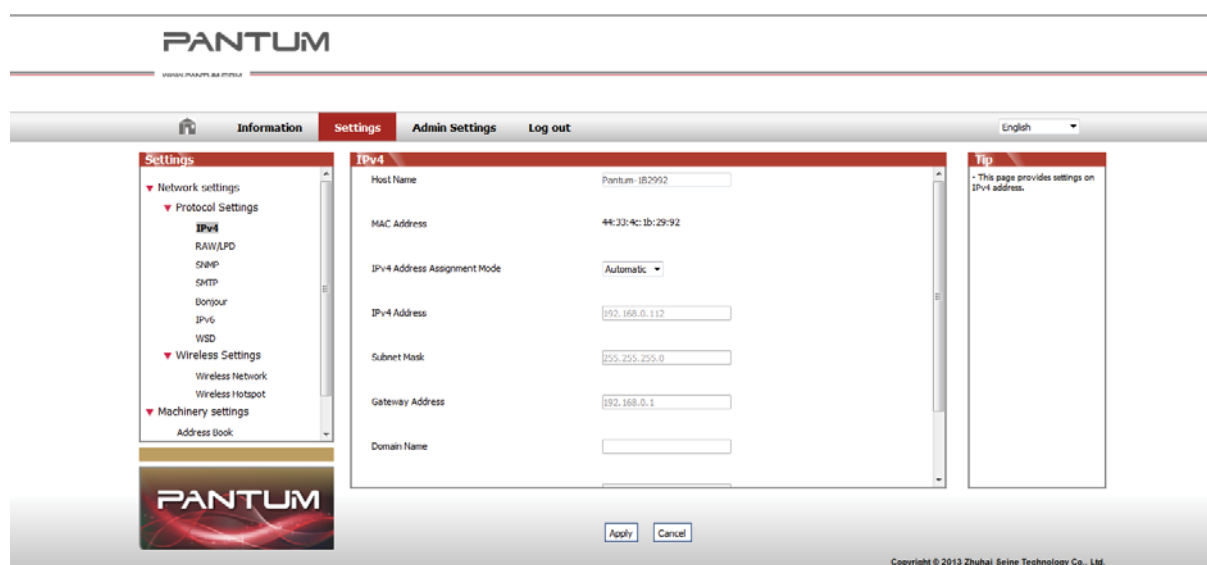

4.3.2. Set or Change Web Server Login Password

Use the embedded Web server to set a network password or change the existing password.



Note: • The default username is "admin", and the initial password is "000000".

1. To open the embedded Web server, please log in first.
2. Click Administrator Settings tab.
3. Type the new password in the Password box and Confirm Password box.
4. At the bottom of the window, click Apply button to save the settings.

4.3.3. Restore to Factory Settings

If you want to reset all parameter settings of the printer, you can restore to the factory settings by long pressing "Cancel/Continue" button when the printer is powered off to power on it and holding for 10 seconds until the printer enters Ready status to finish the resetting work.

Wireless settings (for models with Wi-Fi printing)

5

Chapter

5. Wireless settings (for models with Wi-Fi printing)	2
5.1. Wireless Network Type	2
5.1.1. Configuration with infrastructure mode	2
5.1.2. Configuration with Soft-AP	8
5.2. Turn off the Wireless Device	8

5. Wireless settings (for models with Wi-Fi printing)

5.1. Wireless Network Type

Based on models, the ones with Wi-Fi printing support two types of wireless connection, Infrastructure Mode and Soft-AP. Generally, only one type of connection can be used between the computer and the printer each time.

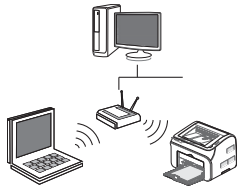

Infrastructure Mode

The printer communicates with the wireless device via the access point.

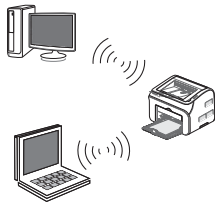

Soft-AP

The wireless computer is directly connected to the wireless device.

5.1.1. Configuration with infrastructure mode

If the printer and the access point (or the wireless router) supports WPS (Wi-Fi Protected Setup™), wireless network settings can be easily configured via the Wi-Fi button on the control panel, without using the computer.

Configure with the Button: press and hold the Wi-Fi button on the control panel of the printer; press the WPS (PBC) button on the access point (or the wireless router) within 2 minutes once WPS is started; the printer is connected to the wireless network.



Note: • The access point (or the wireless router) must support Wi-Fi Protected Setup™ (WPS)

- WPS must be configured with the network cable unplugged
-

5.1.1.1. Connect and configure wireless network via the USB cable

Use USB cable to connect the printer with the computer, and launch the wireless network configuration tool on your computer. The printer will try to get connection when it receives the wireless configuration information from the USB port.

5.1.1.1.1. Wi-Fi configuration Tool

1. Function Description

The Wi-Fi configuration tool is used to configure the printer with the SSID, the encryption method and the password provided by the user to connect the printer to the wireless network.



- Note:**
- If the PC has a wireless network card, you can select an SSID from the wireless network list detected by the PC.
 - If the PC has no wireless network card, you can choose to enter the SSID manually.
 - You can also get the SSID list by printing the wireless network information page, and then enter the SSID manually.

2. Steps

1) Detect the wireless network card

The Wi-Fi configuration tool uses the wireless network card on computer to search for the wireless network. When the computer does not have a wireless network card, the option of Manually enter the SSID will be automatically checked on the Wireless Network List page. Please skip to Step 3 in this case.

2) Wireless Network List

After launching the configuration tool, the screen of Network List detected by the wireless network configuration program appears, where you can select the wireless network.

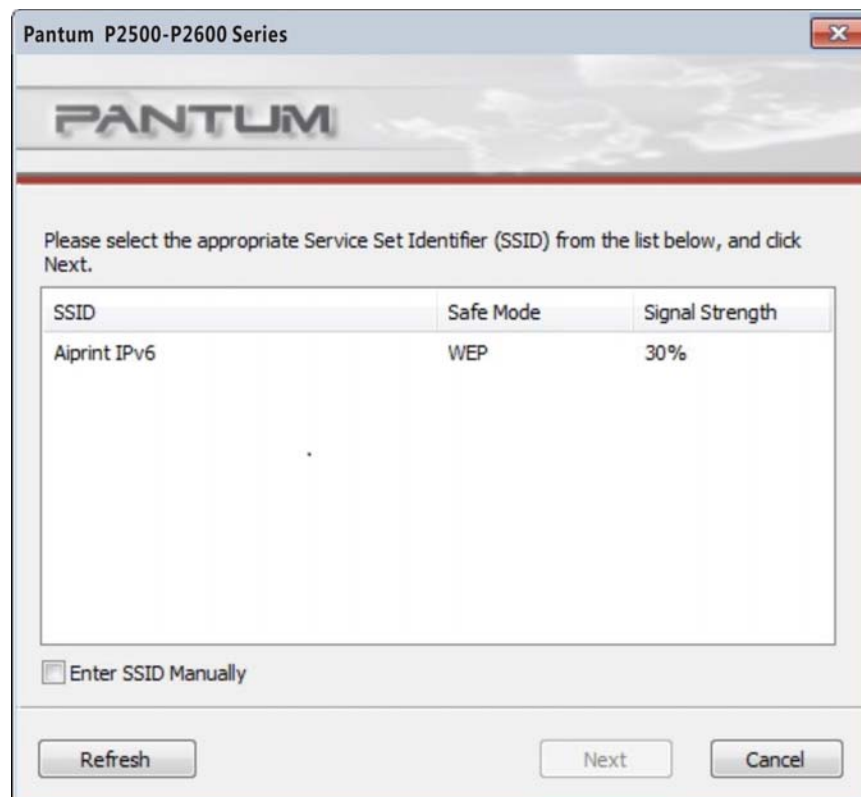

- The network list shows the information found by the program, e.g., SSID, which is sorted by SSID. Users can select an item in the list, and then click on Next to enter the Information Input interface.
- Manually enter the SSID: click to switch to the screen of Manually Enter the SSID.

3) Screen of Manually Enter the SSID

This screen appears when the user check the option of Manually Enter the SSID.

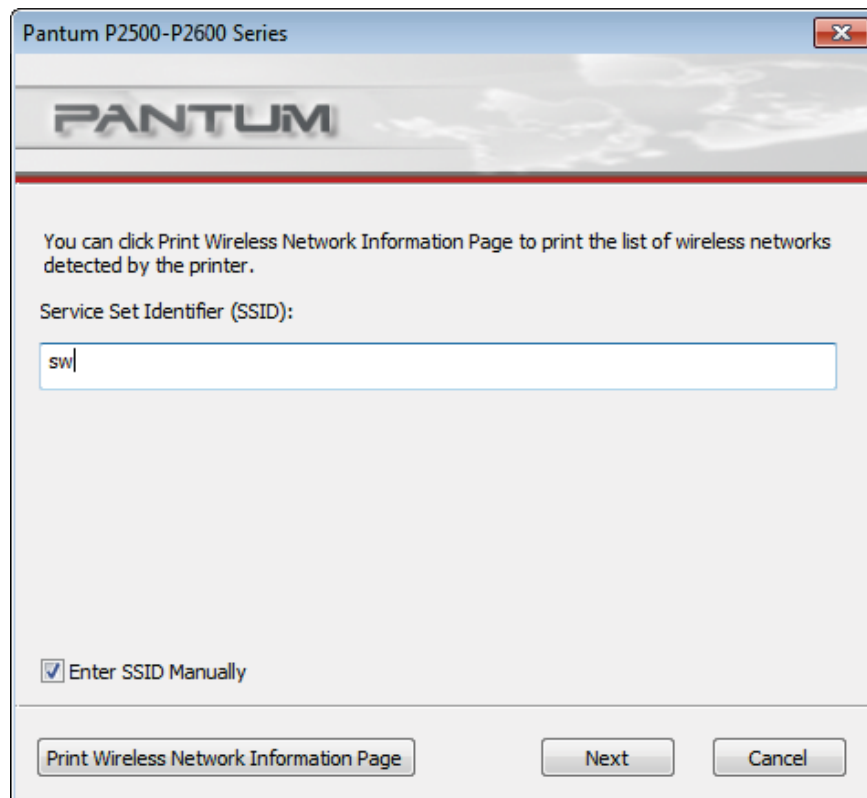

SSID: enter the service set identifier of the network that you want to connect during printing, with the maximum length of 32 characters.

Print the wireless network information page: allows you to print the wireless network list found by the printer.

4) Screen of Information Entry

Screen of Information Entry: allows you to enter the wireless network.

Pantum P2500-P2600 Series

PANTUM

Verify the wireless credential and click Next.

Service Set Identifier (SSID):

SW

Safe Mode:

WPA/WPA2

Password:

••••••••••

Show Password

Previous Next Cancel

Safe Mode: three types are available currently, namely None, WEP, and WPA/WPA2. When it is None, the password entry field will be hidden, which means no password is needed while connecting the SSID provided. The range for WEP entry is 1~26 characters, and that of WPA/WPA2 is 8~64 characters.

Show Password: it is unchecked by default; when it is checked, the password entered will be displayed as it is instead of asterisks.

5) Configuration Screen

Screen of Network Configuration: provides the wireless network configuration results for the printer. The screen displays the progress of PC sending configuration message to the printer to set up wireless connection.

The following message will appear if the printer is not connected to the PC:

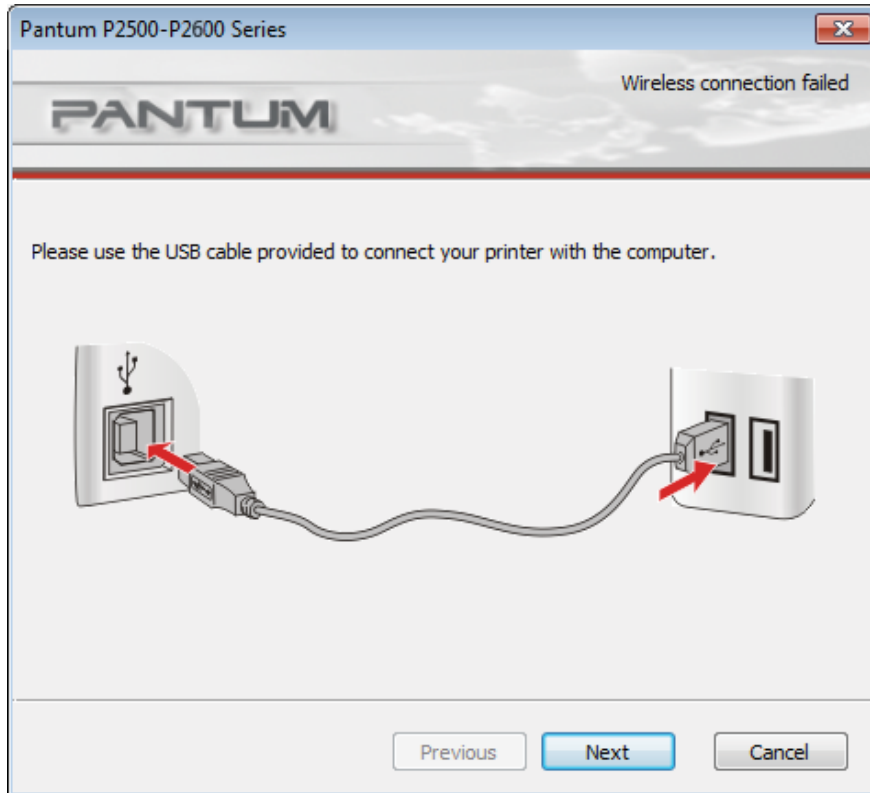

The following message will appear if the printer fails to apply the configuration by using the wireless network provided:

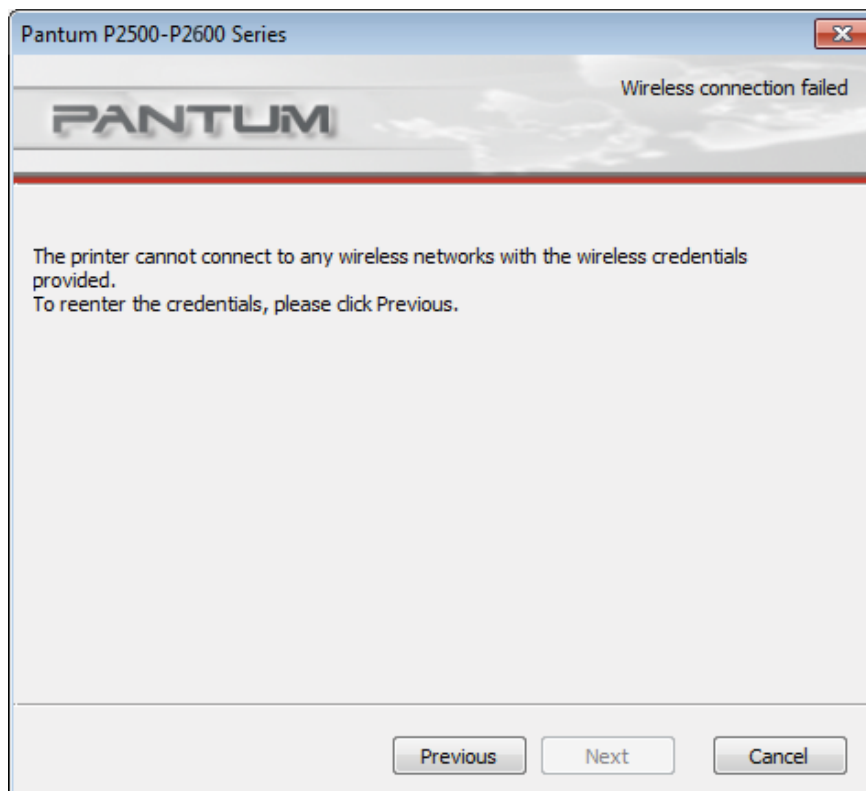

The following message will appear if the printer can apply the configuration by using the wireless network provided, but the PC does not support the wireless network:

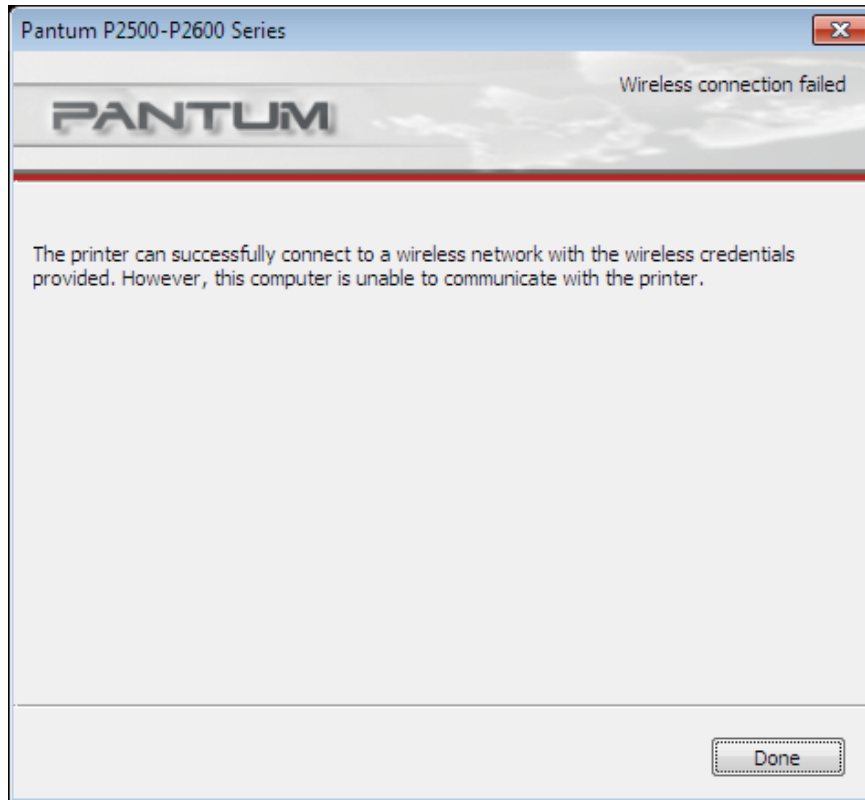

The following message will appear for successful wireless connection when the printer can apply the configuration by using the wireless network provided and the PC supports the wireless network:



5.1.2. Configuration with Soft-AP

When Wi-Fi Hotspot is active, terminal (Station) users can find and connect the printer's Wi-Fi Hotspot by searching for it. The Wi-Fi Hotspot is enabled by default. It can be connected without a password and coexist with Station or wired network.

Feature	Description	Comment
1 IP Address	192.168.223.1 by default	
2 Subnet Mask	255.255.255.0 by default	
3 DHCP service	Enabled by default	
4 DHCP service starting address	192.168.223.100 by default	
5 DHCP service ending address	192,168,223,199 by default	
6 Product Name	It is P2500W Series-XXXXX by default	Can be modified in WebPage
7 Connection Password for the Product	It is 12345678 by default	Can be modified in WebPage

5.2. Turn off the Wireless Device

If you want to disconnect the printer with the wireless network, you can turn off the wireless device within the printer.

1. You can disconnect the wireless network by pressing the Wi-Fi button on the printer's control panel for over 2 seconds.
2. To verify whether the wireless device is turned off, press and hold the Cancel/Continue button to print a copy of the configuration page. The wireless network is disconnected successfully if the printer's IP address on the configuration page is 0.0.0.0.

Pantum Mobile Print

6

Chapter

6. Pantum Mobile Print	2
6.1. What's Pantum Mobile Print	2
6.2. Download Pantum Mobile Print	2
6.3. Supported Mobile Operating System	2
6.4. How to use mobile devices for the mobile printing	2