

User Guide

PANTUM

WWW.PANTUM.COM

Pantum P3500 Series PCL Monochrome Single Function Laser Printer



It is recommended to carefully read this Guide before using the printer

Preface

Welcome to the Pantum series products!

We heartily appreciate your using of Pantum series products!

To protect your vital interests, please carefully read the following statements.

Legal Notice

Trademark

Pantum and Pantum logos are registered trademarks of Zhuhai Pantum Electronics Co.,Ltd.

Microsoft[®], Windows[®], Windows Server[®] and Windows Vista[®] are trademarks registered by Microsoft Corporation in the United States or other countries/regions.

The ownership to the names of the software in this User Guide belongs to their respective companies in accordance with corresponding license agreement, and they are referred for instructions only.

All other product and brand names herein may be the registered trademarks, trademarks or service marks of their respective owners, and they are referred for instructions only.

Copyright

The copyright of this User Guide is owned by Zhuhai Pantum Electronics Co.,Ltd.

It is prohibited to copy, translate, modify and transmit this User Guide by any means or in any form without the prior written consent of Zhuhai Pantum Electronics Co.,Ltd.

Version: V1.0

Disclaimer

For a better user experience, Zhuhai Pantum Electronics Co.,Ltd. reserves the right to make changes to the User Guide. The information contained herein is subject to change without notice.

Users are responsible for any damages arising from failing to follow this User Guide. Meanwhile, except the express warranty made in the product maintenance manual or service commitment, Zhuhai Pantum Electronics Co.,Ltd. does not make any express or implied warranty or guarantee to this User Guide (including composing or words).

Using this product to copy, print, scan certain documents or images or make other forms of operations may be prohibited by the local laws. If you are uncertain about the legality of using this product for certain documents or images, you should consult your legal advisor in advance.

The product can only be used safely in the non-tropical areas at an altitude no higher than 2000 meters.

Safety Precautions

Laser Safety

The laser radiation is harmful to the human body. Since laser components are completely sealed in the printer, laser radiation will not leak. To avoid laser radiation, please do not randomly disassemble the printer!

The printer follows the provisions of Class 1 laser products under CFR standard. The printer has a Class III b laser diode, which has no laser radiation leakage among laser components.

The laser components shall comply with the requirements of: U.S. Code of Federal Regulations, 21 CFR 1040, IEC 60825-1

The following label is attached to the laser components inside the printer:



Reclamation and recycling

To protect the environment, our corporation has already established the system of reclamation and recycling for waste products. Please refer to the Pantum official website for product recovery at www.pantum.com.

Safety Warning

Please note the following safety warnings before using the printer:

Warning	
There is high-voltage electrode inside the printer. Before cleaning the printer, make sure the power is turned off!	
Plugging and unplugging the power cord plug with a wet hand can result in an electric shock.	
The fuser unit is hot when and after printing. Touching the fuser unit (the shaded area as shown) may cause burns!	
The fuser unit is attached with a high temperature warning label. Please do not remove or damage this label.	

Precautions

Precautions before Using the Printer:

1. Read and understand all instructions;
2. Familiarize yourself with the basic principles associated with operating electrical appliances;
3. Comply with all warnings and instructions marked on the equipment or specified in the manual supplied with the equipment;
4. If the operating instructions conflict with the safety information, please refer back to the safety information, as you may have misunderstood the operating instructions. If you cannot resolve the conflicts, please call the Customer Service Hotline or contact a service representative for help;
5. Before cleaning the equipment, remove the power cord from the AC power supply outlet. Do not use liquid or aerosol cleaners;
6. Please make sure that the equipment is put on a stable desktop surface to avoid serious damage caused by the falling of the equipment;
7. Do not put the equipment near a radiator, an air conditioner, or a ventilation pipe;
8. Do not put any articles on the power cord. Do not put the equipment at the place where its power cord could be stepped on by people;
9. Outlets and extension cords must not be overloaded. This may reduce performance and could result in fire or electric shock;
10. Do not allow pets to chew on the AC power cord or the computer interface cable;
11. Do not allow sharp objects piercing equipment slot, so as to avoid contact with the high-voltage device, which otherwise may result in fire or electric shock. Take care not to spill liquids onto the equipment;
12. Do not disassemble the equipment so as to avoid the risk of electric shock. Necessary repairs may only be carried out by professional maintenance personnel. Opening or removing the cover could result in an electric shock or other potential hazards. Incorrect disassembly and assembly could also result in an electric shock during future use;
13. If any one of the following occurs, disconnect the equipment from the computer and pull out the power cord from the AC wall socket and contact a qualified member of the service personnel for maintenance:
 - Liquid has been spilled into the equipment.
 - The equipment has been exposed to rain or water.
 - The equipment falls, or the cover is damaged.
 - Significant changes in the equipment's performance.
14. Only adjust the control mentioned in the instructions. Incorrect adjustment of other controls may result in damage and mean that professional maintenance personnel need to spend more time fixing it;
15. Do not use the equipment in a thunderstorm so as to avoid the risk of an electric shock. If possible, pull out the AC power cord during a thunderstorm;
16. If you continuously print multiple pages, the surface of the tray will become very hot. Take care not to touch this surface, and keep children away from this surface;
17. The signal wire of the device connected with the printer can not be connected to the outdoors;
18. Please ensure timely ventilation in case of a prolonged use or printing huge amounts of documents in a poorly ventilated room;
19. In standby status, the product will automatically enter into the power saving (sleep) mode if it does not receive any job order for a while (such as 1 minute); and it can realize zero power consumption only if it has not been connected with any external input power supply;
20. As the Class 1 equipment, the product must be connected to the power supply outlet with protective grounding line when using;
21. This product should be placed according to the shipping marks on the product package box during delivery;
22. This product is a kind of low-voltage equipment. When using this product below the specified voltage range, please refer to the product precautions or call Pantum Aftersales Service Centre, if the toner comes off the printed contents, or the equipment starts slowly;

-
23. This product is sold as a complete machine. The consumers can go to Pantum Aftersales Service Centre to purchase parts they need. If the product sold is inconsistent with the package list, please go to the specified Aftersales Service Centre to solve the problem;
 24. Install this product in a place with the temperature between 10°C and 32.5°C and the relative humidity between 20% and 80%;
 25. For security and other reasons the printer may switch to intermittent printing after a certain amount of continuous printing.
 26. This device complies with Industry Canada licence-exempt RSS standard(s). Operation is subject to the following two conditions:
 - (1) this device may not cause interference, and
 - (2) this device must accept any interference, including interference that may cause undesired operation of the device.
 27. IC Radiation Exposure Statement:

This equipment complies with Canada and FCC radiation exposure limits set forth for uncontrolled environments. This equipment should be installed and operated with a minimum distance of 20cm between the radiator and your body.

This transmitter must not be co-located or operating in conjunction with any other antenna or transmitter.
 28. This equipment has been tested and found to comply with the limits for a Class B digital device, pursuant to Part 15 of the FCC Rules. These limits are designed to provide reasonable protection against harmful interference in a residential installation. This equipment generates, uses and can radiate radio frequency energy and, if not installed and used in accordance with the instructions, may cause harmful interference to radio communications. However, there is no guarantee that interference will not occur in a particular installation.
 - If this equipment does cause harmful interference to radio or television reception, which can be determined by turning the equipment off and on, the user is encouraged to try to correct the interference by one or more of the following measures:
 - Reorient or relocate the receiving antenna.
 - Increase the separation between the equipment and receiver.
 - Connect the equipment into an outlet on a circuit different from that to which the receiver is connected.
 - Consult the dealer or an experienced radio/TV technician for help.
 29. Changes or modification not expressly approved by the party responsible for compliance could void the user's authority to operate the equipment.
 30. The power consumption of the product is XXX W in networked standby if all wired network ports are connected and all wireless network ports are activated;
 31. Shielded cables must be used with this unit to ensure compliance with the Class B FCC limits.
 32. The product's Power Consumption in Off mode is less than 0W, in Networked standby mode is less than 0W.
 33. Please keep this User Guide properly.

Legal Information



This symbol indicates that, at the end of your product's life, it must not be discarded as domestic waste. Instead, you should dispose of your used equipment at a designated collection point for the recycling of waste electrical and electronic equipment. Ref: EU Directive 2002/96/EC on Waste Electrical and Electronic Equipment (WEEE). Please contact your distributor / supplier for further information.



This product is suitable for indoor use only.



European Community (EC) directives conformity

This product complies with the protection requirements of EC directives 2004/108/EC and 2006/95/EC on the approximation and harmonization of the laws of the Member States relating to electromagnetic compatibility and safety of electrical equipment designed for use within certain voltage limits.

The manufacturer of this product is: Zhuhai Pantum Electronics Co.,Ltd., No.3883, Zhuhai Avenue, Zhuhai, Guangdong, China 519060.

A declaration of conformity to the requirements of the Directives is available upon request from the Authorized Representative.

This product satisfies the Class B limits of EN 55022 and safety requirements of EN 60950.



This printer is fully compliant with the ROHS Directive 2009/95/EC and the requirements of the revised Directive 2011/65/EU for managing toxic and hazardous substances.

Table of Contents

1. Before Using the Printer	1-2
1.1. Packing List	1-2
1.2. Product View	1-3
1.3. Laser Toner Cartridge	1-5
1.4. Control Panel	1-6
1.5. Print the Product Report	1-7
2. Paper and Print Media	2-2
2.1. Paper Specification	2-2
2.2. Loading Paper	2-4
2.2.1. Loading into Standard Input Tray	2-4
2.2.2. Loading into Multipurpose Input Tray	2-6
2.2.3. Loading into Optional Tray	2-7
2.3. Non-printing Area	2-8
3. Installation and Uninstallation of the Driver Software	3-2
3.1. Windows-based Driver	3-2
3.1.1. Introduction	3-2
3.1.2. Installation Steps	3-2
3.1.3. Driver Uninstallation	3-11
3.2. Installation of the Driver Software based on Mac System	3-13
4. Network Configuration (For printer models that support wired/wireless network features)	4-2
4.1. Wired Network Configuration (For printer models that support wired network features)	4-2
4.2. Wireless Network Configuration (For printer models that support wireless network features)	4-2
4.2.1. WiFi Protected Setup	4-2
4.2.2. Setting up through WiFi Configuration Tool	4-3
4.2.3. Setting up through Web Server	4-15
4.2.4. Turn on/off Wireless Device	4-16
4.3. Set Network Printer	4-17
4.3.1. Web Server Settings	4-17
4.3.2. Control Panel Settings	4-20
5. Mobile Print	5-2
5.1. WiFi Hotspot Connection Method	5-2
5.2. WiFi Printing Operations	5-2
5.2.1. For Android Devices	5-2
5.2.2. For Apple IOS Devices	5-2
6. System Settings	6-2
6.1. Language Setting	6-2
6.2. Sleep Time Setting	6-2
6.3. Toner Save Setting	6-3
6.4. Restore Factory Settings	6-5
7. Print	7-2
7.1. Print Function	7-2
7.2. Tray Setup	7-3
7.2.1. Tray Dial Settings	7-3
7.2.2. Tray Settings through Control Panel	7-4
7.3. Open Help Document	7-5
7.4. Printing Mode	7-5
7.4.1. Printing with Standard Input Tray	7-6
7.4.2. Printing with Multipurpose Input Tray	7-6
7.4.3. Printing with Optional Tray	7-7
7.5. Automatic Duplex Print	7-9

8. Routine Maintenance.....	8-2
8.1. Cleaning the Printer	8-2
8.2. Maintenance of Laser Toner Cartridge	8-3
8.2.1. About Laser Toner Cartridge	8-3
8.2.2. Replace Laser Toner Cartridge	8-4
9. Troubleshooting	9-2
9.1. Clearing Jammed Paper	9-2
9.1.1. Paper Jam in the Tray.....	9-2
9.1.2. Paper Jam in the Manual Input Tray	9-3
9.1.3. Paper Jam in the Optional Tray	9-4
9.1.4. Internal Paper Jam.....	9-5
9.1.5. Paper Jam in the Fuser Unit	9-6
9.1.6. Duplex Unit Jam.....	9-7
9.2. Software Failure	9-8
9.3. Common Trouble Shooting	9-8
9.3.1. Common Trouble	9-8
9.3.2. Image Defects	9-10

Before Using the Printer

1





Chapter

1. Before Using the Printer	1-2
1.1. Packing List	1-2
1.2. Product View	1-3
1.3. Laser Toner Cartridge	1-5
1.4. Control Panel	1-6
1.5. Print the Product Report	1-7

1. Before Using the Printer

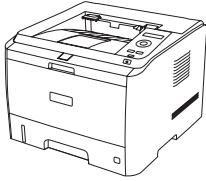
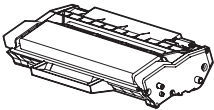
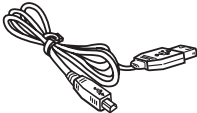
1.1. Packing List

When you open the package, make sure that the following parts are included in the carton:

Parts	Name	Quantity
	Printer	1
	Laser Toner Cartridge	1
	USB Interface Cable	1
	Power Cord	1
	CD-ROM	1
	Quick Setup Guide	1
	Pantum Warranty	1



Note: • The Pantum Warranty may not be attached in some regions.

1.2. Product View

Side view

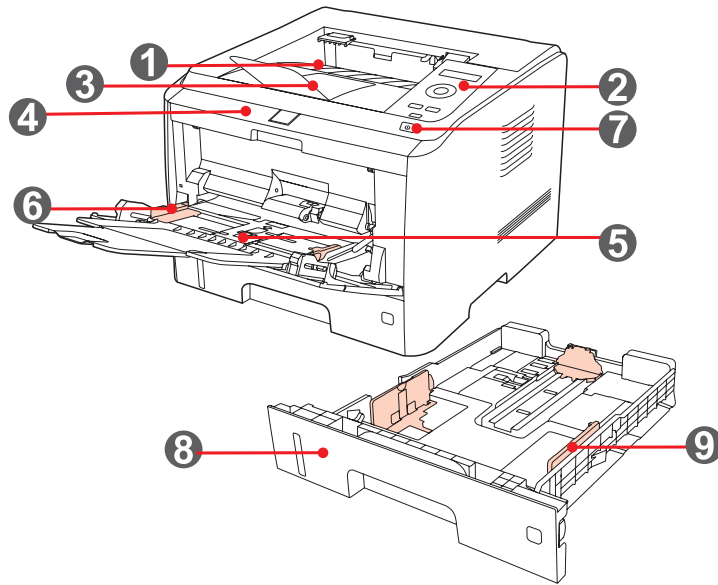

1	Output Bin	For storing the printed paper
2	Control Panel	To indicate the printer status and conduct the print settings operation
3	Output Tray	To prevent the printed paper from falling
4	Front Cover	To open the front cover to take out the laser toner cartridge
5	Multipurpose Input Tray	To open the front cover of the multipurpose input tray, and put in the print media
6	Multipurpose Input Tray Guide	To adjust the width of the both sides of the paper
7	Main Power Switch	To turn on or turn off the power supply
8	Standard Input Tray	To hold the print paper
9	Paper-width Guide	To adjust the width of the paper inside the standard input tray

Rear view

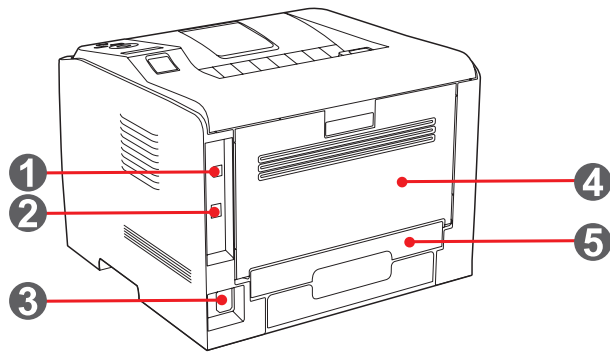

1	USB Interface	For directly connecting with the computer
2	Network Interface	For connecting the printer to the network
3	Power Interface	For connecting the power cord
4	Rear Cover	To be opened for checking the jammed paper
5	Duplex Printing Unit	For releasing jammed paper at the rear during duplex printing



Note: • The illustration may vary with different models and features, please prevail in kind.

1.3. Laser Toner Cartridge

Service Life of the Laser Toner Cartridge

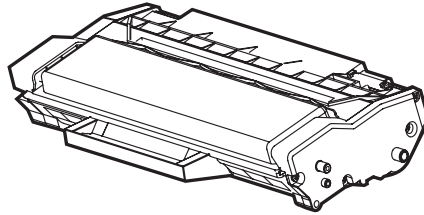

Type	Average Print Volume
Laser Toner Cartridge with Standard Capacity	About 3,000 pages (The volume is based on ISO/IEC 19752 standard)
Laser Toner Cartridge with High Capacity	About 6,000 pages (The volume is based on ISO/IEC 19752 standard)
Laser Toner Cartridge with Ultra-high Capacity	About 10,000 pages (The volume is based on ISO/IEC 19752 standard)



- Note:**
- The model is subject to volume increase without prior notice.
 - Consumables capacity may vary depending on the different types used.
 - We do not recommend using consumables other than that of the original Pantum consumables.
 - Any damages caused by using non-Pantum original consumables are not covered by the Warranty.
 - The appearances of laser toner cartridges will vary with different types, illustrations are for reference only.

1.4. Control Panel

1. Layout and Functions of Control Panel

The layout of the printer control panel is shown below:

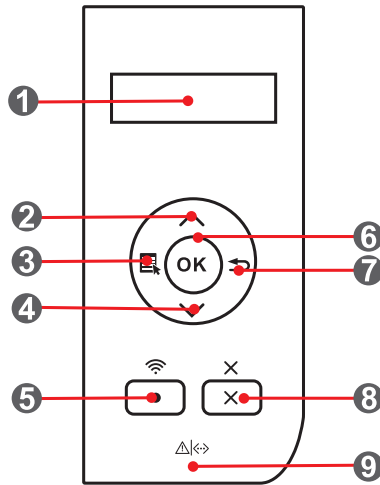

No.	Name	Functions
1	LCD Display	The display provides information about the printer and can be used for setting up the Product Settings.
2	UP	Press this button to browse through each menu and its options. For menu items need to input, change the numeric value by cycle accumulating.
3	Menu	Open the main menu of the control panel to conduct the menu setting.
4	Down	Press this button to browse through each menu and its options. For menu items need to input, move the position of the cursor, e.g., IP address input.
5	WiFi/Configuration Report	This button can enable the WiFi feature and indicate the WiFi connection status (only applicable to WiFi model). For non-WiFi model, this button will be used to print the "Printer Information Page" and the "Network Configuration Report".
6	OK	<ul style="list-style-type: none"> Press this button to save the settings. Open the submenu on the display of the control panel. Select the menu item.
7	Back	Back Arrow Button: use this button to perform the following operations: <ul style="list-style-type: none"> Exit the control panel menu. Scroll back to the previous menu in the list in the submenu. Return to the previous menu; if already at the top menu, return to the Ready interface.
8	Cancel	Press this button to cancel the operation. Cancel the current printing operation if there is any.
9	Status Indicator	This light indicates the ready, alarm and other statuses of the printer. Green light: Normal. Orange light: Alarm or cartridge toner level is low. Red light: Error.

2. Status Indicator

The multi-colored LED indicator will display red, orange and green with the specific meanings as follows:



Red indicates the emergence of a serious error, such as the laser toner cartridge is not installed, the laser toner cartridge does not match the printer, or the paper tray is out of paper; and in such a case, it will keep the red light on. For specific error, see [Chapter 9 Troubleshooting](#).



The display provides information about the printer and can be used for setting up the Product Settings.



Press this button to browse through each menu and its options. For menu items need to input, change the numeric value by cycle accumulating.

1.5. Print the Product Report

Users can print the product report by manipulating the control panel. These pages can help you understand the product information, diagnose and resolve product failures.

- 1) Press "Menu" to enter the Menu Settings interface.
- 2) Press direction key "▲" or "▼" to select the "6.Prt Info Rept" option.

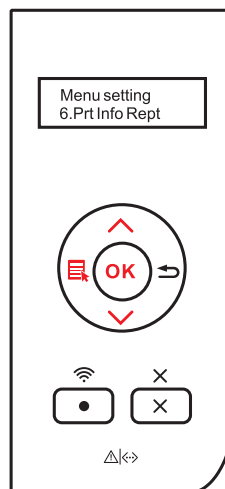

- 3) Press "OK" to enter the Print Information Report interface, and users can print the product report according to their needs.



Note: • In case of non-WiFi model, users can also print the network configuration report of the printer directly through the shortcut button of "Network Configuration Report" on the control panel.

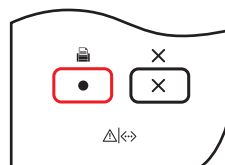

Paper and Print Media

2

Chapter

2. Paper and Print Media.....	2-2
2.1. Paper Specification.....	2-2
2.2. Loading Paper	2-4
2.2.1. Loading into Standard Input Tray.....	2-4
2.2.2. Loading into Multipurpose Input Tray.....	2-6
2.2.3. Loading into Optional Tray	2-7
2.3. Non-printing Area.....	2-8

2. Paper and Print Media

2.1. Paper Specification

		Media type	Plain, thin paper
	Standard Input Tray	Media size	Auto*, A4, A5 Short Edge, A5 Long Edge, A6, JIS B5, IS0 B5, B6, Letter, Legal, Executive, Folio, Oficio, Statement, 16K, Big 16K, 32K, Big 32K.
		Media weight	60~105 g/m ²
		Maximum capacity of the tray	250 pages
		Media type	Plain paper, thick paper, thin paper, transparent film paper, carton paper, label paper, envelope paper
	Multipurpose Feeder	Media size	Auto*, A4, A5 Short Edge, A5 Long Edge, A6, JIS B5, IS0 B5, B6, Letter, Legal, Executive, Folio, Oficio, Statement, 16K, Big 16K, 32K, Big 32K, No.10 Env., Monarch Env, DL Env, C5 Env, C6 Env, ZL, Japanese Postcard, Long Paper (Maximum 1.2m), Custom, Yougata4, Postcard, Younaga3, Nagaga3, Yougata2
P3500 Series		Media weight	60~200 g/m ²
		Maximum capacity of the tray	60 pages
		Media type	Plain, thin paper
	Optional Tray	Media size	Auto*, A4, A5 Short Edge, JIS B5, IS0 B5, Letter, Legal, Executive, Folio, Oficio, Statement, 16K, Big 16K.
		Media weight	60~105 g/m ²
		Maximum capacity of the tray	550 pages (single optional tray)
	Output Tray Capacity		150 pages



-
- Note:**
- It is recommended to use the standard paper and recycled paper for the printer.
 - It is not recommended to use special paper extensively, which may affect the service life of the printer.
 - The print media that does not meet the guidelines listed in this User Guide may result in poor print quality, increased paper jam and excessive wear of the printer.
 - Properties such as weight, composition, texture and humidity are important factors affecting the printer performance and output quality.
 - Please note the following matters when selecting the print media:
 1. Desired print result: The selected print media should meet the requirement of the print tasks.
 2. Surface smoothness: The smoothness of the print media may affect the sharpness of the print outcome.
 3. Some print media may meet all the use guidelines contained herein, but they still cannot bring satisfactory effect. This may be due to incorrect operation, inappropriate temperature and humidity, or other factors beyond the control of Pantum. Before purchasing large quantities of print media, make sure that the print media meets the specifications specified in this User Guide.
 4. Using print media that does not meet these specifications may cause damage to the printer.
-

Paper and Manuscript Use Principles

- Papers or manuscripts with rough texture, concave and convex, oil stain and good smoothness have poor printing performance.
- Please make sure no dust and fluff on the paper.
- Paper shall be put on a flat surface and stored under a cool and dry environment.

Special Paper Description

This printer supports using special paper for printing. Special paper includes: label, envelope, transparency, thick paper, etc. Special paper should be loaded into the multipurpose input tray for printing.



-
- Note:**
- When using special paper or print media, be sure to select the matched print type and size in the print settings so as to get the best print result.
 - A maximum of 60 pages can be loaded into the multipurpose input tray when a special media is used for printing.
-

Please observe the following standards:

Types of Print Media	Correct Practices	Incorrect Practices
Label	Use labels with no exposed lining paper only. Labels shall be put flat when using. Use labels of full sheet only. There is no guarantee that all the labels in the market can meet corresponding requirements.	Use wrinkled, blistering or damaged labels.
Envelope	Envelopes should be loaded evenly.	Use wrinkled, nicked, stuck or damaged envelopes. Use envelopes with clips, snaps, windows, or coated linings. Use envelopes with self-adhesive stickers or other synthetic materials.
Transparency	Use only transparencies approved for use in laser printers.	Use transparent print media that is not suitable for laser printers.
Thick	Use only heavy paper that is approved for use in laser printers and meets the weight specifications of this printer.	Use the paper whose weight is more than the specification of the media recommended for this printer, unless the paper is approved for use in this printer.

2.2. Loading Paper

2.2.1. Loading into Standard Input Tray

1. Completely draw out the standard input tray from the printer.

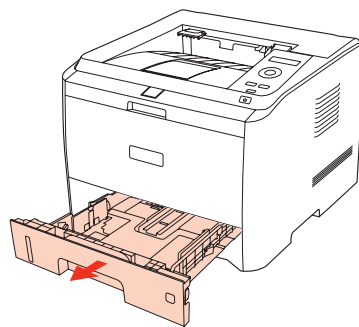

2. Slide the paper-length guide and paper-width guide of the standard input tray to the desired paper size slot, so as to match with the length and width of the paper.

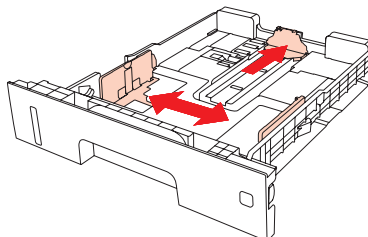

Note: • Do not overly squeeze the "paper-length guide" and "paper-width guide", otherwise it will easily lead to deformation of paper.

3. Unfold the stacked paper before loading to avoid paper jam or paper feed error, and then load the paper into the tray with the print-side down; the standard input tray can be loaded with 250 pages (80 g/m²) at maximum.



Note: • The printer tray is designed with the "paper type dial" for commonly used paper size, which can be adjusted as required. When the paper type used for printing is different from that the dial sets, the LCD display of the printer will show "PaprSize Mismatch." indicating an error, then it is necessary to reset the dial to eliminate the error.

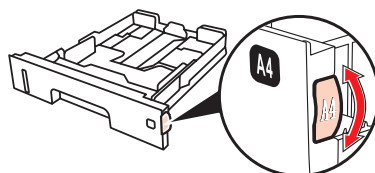

• For those paper types that are not shown on the dial, please set up the paper size through the control panel.

4. Raise the output tray to avoid the printed paper from slipping and falling.

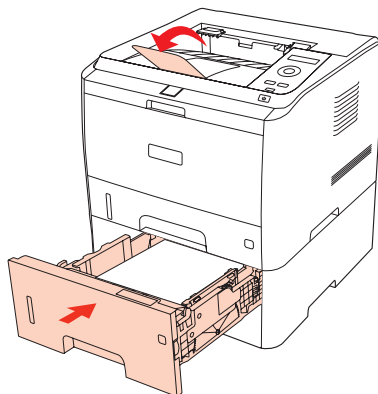

Note: • If the paper loaded into the standard tray at one time exceed 250 pages (80 g/m²), paper will jam or cannot be fed in.
• If printing only the single side, please make the side to be printed (the blank side) down.

2.2.2. Loading into Multipurpose Input Tray

1. Raise the output tray to avoid the printed paper from slipping and falling, or immediately remove the printed document after the printing is completed.

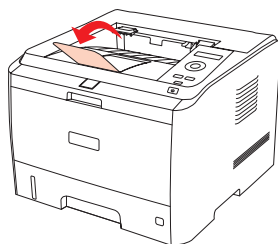

2. Open the Multipurpose Input Tray

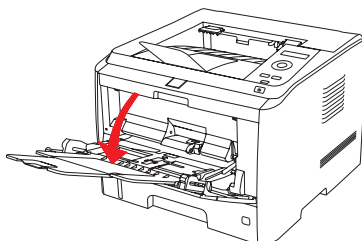

3. Slide the paper guides of the multipurpose input tray to match both sides of the paper. Do not exert too much force, otherwise it will cause paper jam or paper skew.

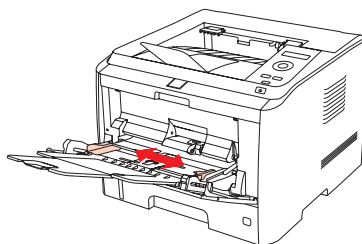

4. Put the print media (such as an envelope or transparency) into the multipurpose input tray with two hands until the front end of the envelope or transparency contacts the correction roller.

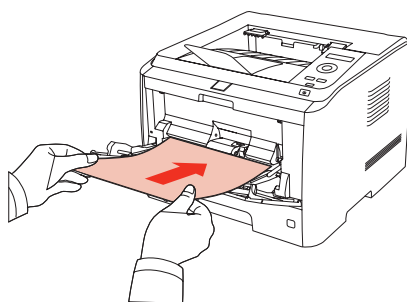

- Note:**
- When loading paper into the multipurpose input tray, and the paper source is set up as Auto-select or Multipurpose Input Tray as specified, the printing will be performed with the paper from the Multipurpose Input Tray as priority.
 - 60 pieces of print media can be loaded into the multipurpose input tray each time at maximum.
 - Load the print media into the multipurpose input tray with the print-side up. When loading, the top of the paper first enters into the multipurpose input tray.
 - When using printed paper, please make the side to be printed (the blank side) up.
 - After printing, please immediately remove the paper, envelopes and transparencies. Stacking paper or envelopes may cause a paper jam or the paper curling.

2.2.3. Loading into Optional Tray

The optional trays can be overlaid for this printer, with each tray loaded with 550 pages (80 g/m²) at maximum. If you need the optional trays, please contact the local distributor from whom you bought the printer.



Note: • For installation of the optional tray, please refer to [Chapter 7](#).

1. Completely draw out the optional input tray from the printer.

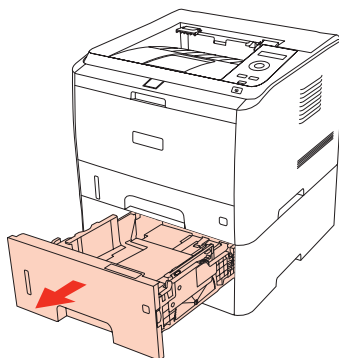

2. Slide the paper-length guide and paper-width guide of the tray to the desired paper size slot, so as to match with the length and width of the paper.

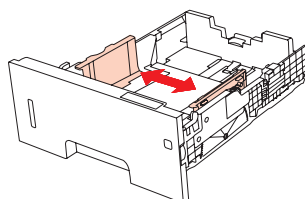

Note: • Do not overly squeeze the "paper-length guide" and "paper-width guide", otherwise it will easily lead to deformation of paper.
• To load the Legal size paper, press the release button on the rear of the tray to draw out the rear, so as to lengthen the tray.

3. Unfold the stacked paper before loading to avoid paper jam or paper feed error, and then load the paper into the tray with the print-side down; the optional input tray can be loaded with 550 pages (80 g/m²) at maximum.

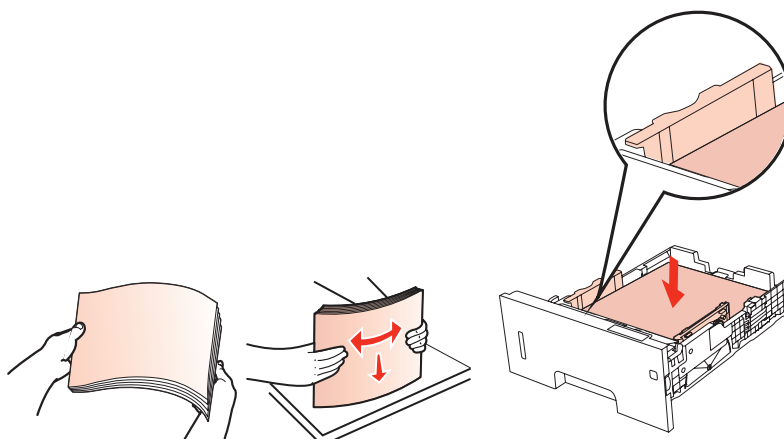



Note: • The printer tray is designed with the "paper type dial" for commonly used paper size, which can be adjusted as required. When the paper type used for printing is different from that the dial sets, the LCD display of the printer will show "Optl tray I, PaprSize Mismat." indicating an error, then it is necessary to reset the dial to eliminate the error.

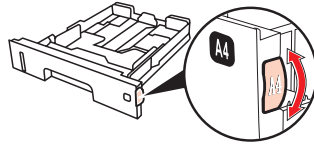

• For those paper types that are not shown on the dial, please set up the paper size through the control panel.

4. Raise the output tray to avoid the printed paper from slipping and falling.

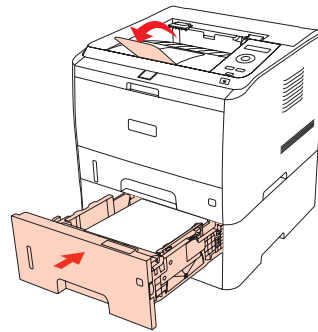

Note: • If the paper loaded into the optional tray at one time exceed 550 pages (80 g/m²), paper will jam or cannot be fed in.
• If printing only the single side, please make the side to be printed (the blank side) down.
• For installation of the optional tray, please refer to the Installation Guide attached with the optional tray.

2.3. Non-printing Area

The shaded section indicates the non-printing area.

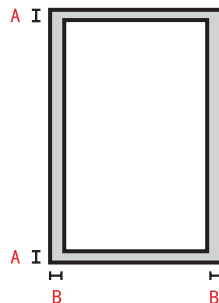

Usage	Paper Size	Top and Bottom Margins (A)	Left and Right Margins (B)
Print	A4	5 mm (0.197 in)	5 mm (0.197 in)
	Letter	5 mm (0.197 in)	5 mm (0.197 in)

Installation and Uninstallation of the Driver Software

3

Chapter

3. Installation and Uninstallation of the Driver Software	3-2
3.1. Windows-based Driver.....	3-2
3.1.1. Introduction	3-2
3.1.2. Installation Steps.....	3-2
3.1.3. Driver Uninstallation.....	3-11
3.2. Installation of the Driver Software based on Mac System	3-13

3. Installation and Uninstallation of the Driver Software

3.1. Windows-based Driver

3.1.1. Introduction

Driver software helps users to run the installer and uninstaller through the installation and uninstallation wizards, which provides the following modules and main functions:

- Autorun completes the automatic running of the installation CD.
- Installation: Provides users with the installation wizard of the printer driver.
- Uninstallation: Provides users with the uninstallation wizard of the printer driver.



Note:

- For users of Windows XP and Windows Server 2003, when connecting the equipment for the first time, the system will pop up the window of Found New Hardware Wizard. Please close this window. If this window is not closed, the printer may not be detected, resulting in failure of installation.
- User authentication will be performed before the program runs. If the user is an administrator, this interface will display. If the user is not an administrator, the prompt "Insufficient privileges. Please install the Pantum xxxx Series printer with administrator privileges" will pop up.

3.1.2. Installation Steps

3.1.2.1 USB Model Installation

1) Autorun Interface

After running the installation CD, the program will run automatically and display the following interface:



2) Installation Interface

After the running of Autorun completes, the following installation interface appears:



Note: • The information shown on the interface may vary with different printer models.

Description of Options:

- **Installation Language:** it is the language corresponding to the operating system by default, and users can select different languages according to their different needs.
- **Select Printer:** it shows the printer model, and users can select the corresponding model based on the printer to be installed.
- **Installation Mode:** the "USB printer" is checked by default.
- **User Guide:** click to view the User Guide documents.
- **License Agreement:** "I agree to the License Agreement" is checked by default. Click the agreement to open the corresponding window, as shown in the following figure:

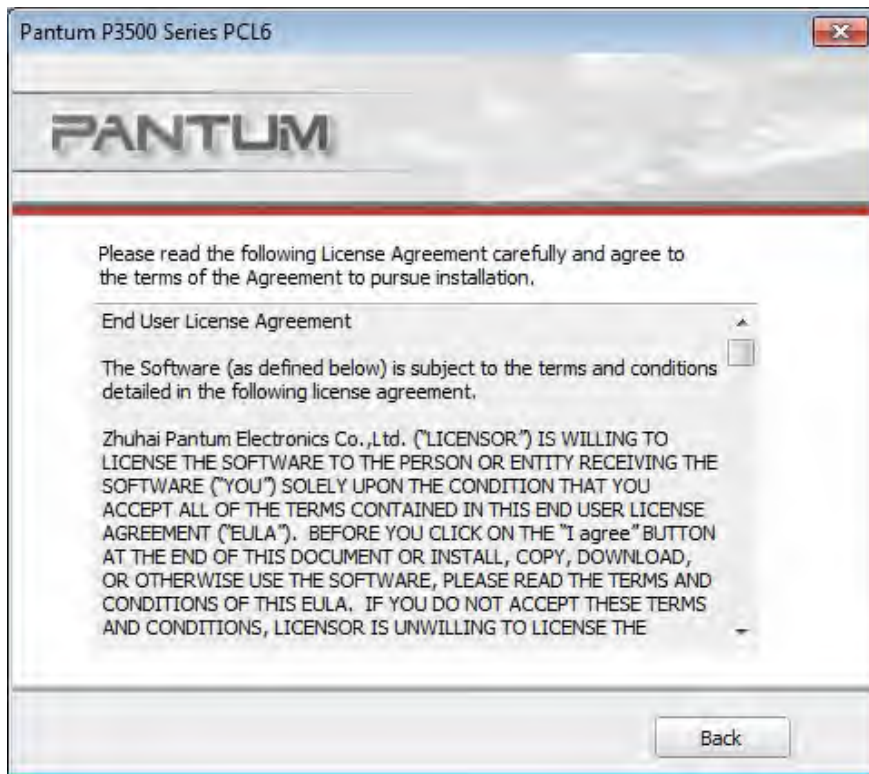

Click "Back" to return to the original interface.

3) Installation Process Interface

Select Install to enter the Driver Installation Process interface.

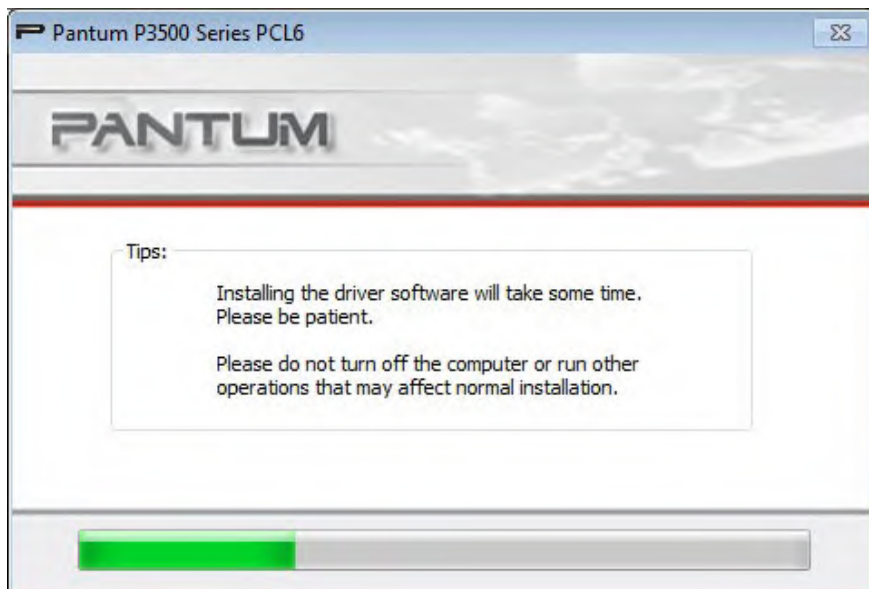

If Windows cannot verify the publisher of this driver software during the driver installation process, you will be prompted whether to still proceed with the installation. Then, you need to click Continue Anyway or Install this Driver Software Anyway, otherwise it will cause an unsuccessful installation (Different operating systems may pop up slightly different warning display interface).

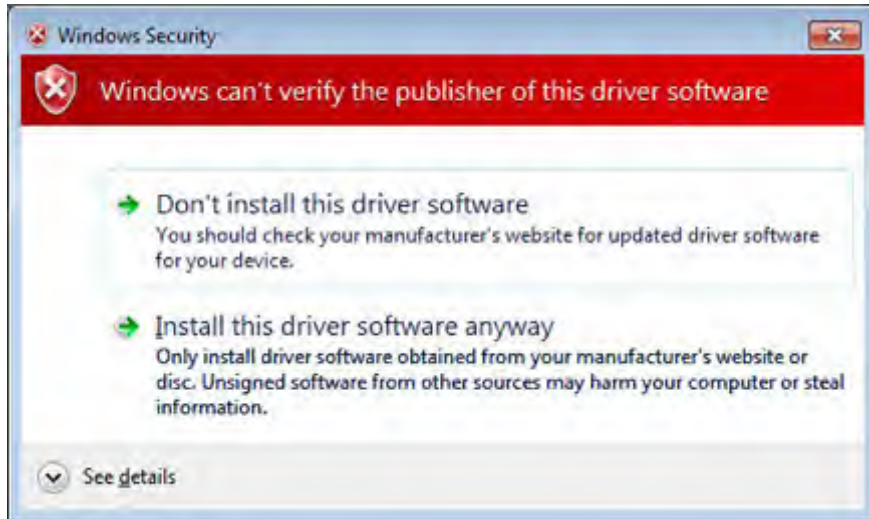

4) Installation Complete

The program will automatically enter this interface after the driver installation is completed. It will automatically exit in 3 seconds and set the printer as default.

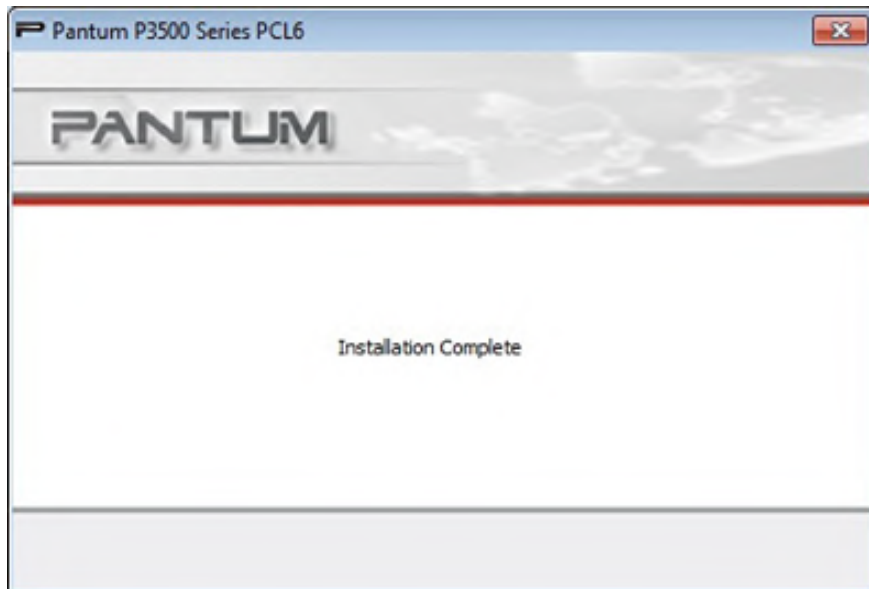

3.1.2.2. NET Model (Wired and Wireless)

1) Running Interface

After inserting the CD, the main interface pops up and the program runs automatically.



2) Installation Configuration

After the running interface, it will enter the Installation Configuration interface. Users can select the corresponding series name, language and installation method according to the printer model to be installed.



Installation Instruction:

USB Printer: applicable to the local installation of all models.

Printers connected to the network: applicable to NET Model Network Installation; or reinstallation when the WiFi Model has connected to the Internet.

Printers connected to a new network: only applicable to the configuration of WiFi for models with WiFi function.

1. Wired NET Model Installation

1) The following interface will display, if users install the Wired NET Model:



Users select the corresponding wired NET Model through "Select Printer", and the corresponding installation options are available through Installation mode.

2) Search for Printers interface

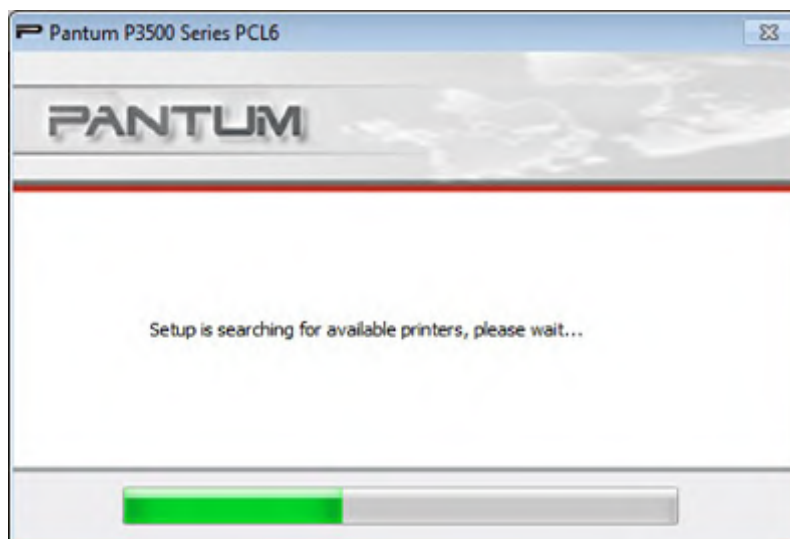

After entering the Search for Printers interface, the program will automatically search for any appropriate printer devices connected to the computer.

3) Printer List

After searching for printers, the program will automatically enter the "Select Printer" interface. Users can select the found printer or add printer by manually adding IP or Host Name.

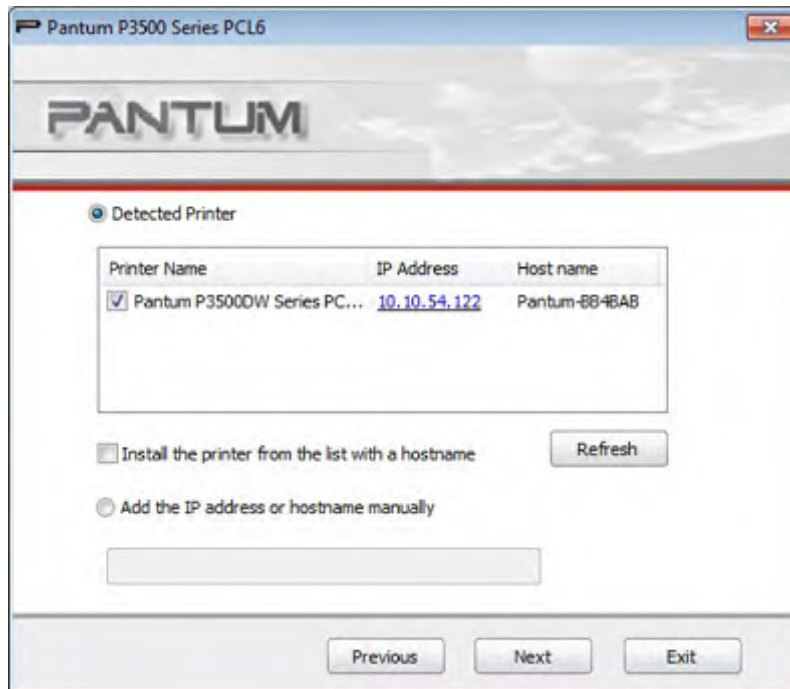

- Note:**
- When the installer prompts you to select a printer, you can select the appropriate printer name from the Detected Printer;
 - If the printer name does not appear in the Detected Printer, please click Refresh and search for printers on the network;
 - If you know the IP address of the printer to be connected, you can select Specify an IP Address for Installation to enter the printer's IP address for connection.

4) Printer Installation Interface

Click on "Next" in the "Printer List" interface, the program will enter the "Printer Installation" interface. After the installation is completed, it will enter the "Installation Complete" interface, and exit in 3 seconds and set the printer as default.

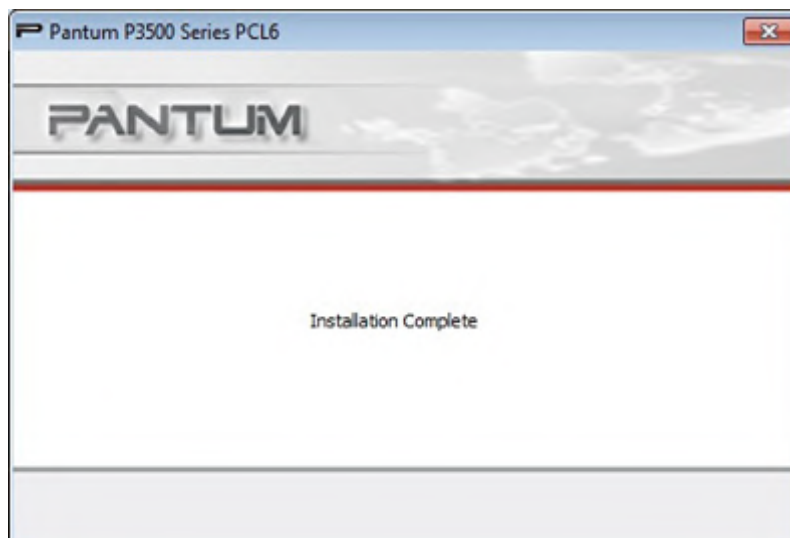

2. WiFi Model Installation

1) If users install the WiFi Model, the following interface will display:



Users select the corresponding WiFi Model through "Select Printer", and the corresponding installation options are available through Installation mode. Generally, users select the third installation method at the first-time installation.

2) WiFi Configuration Interface

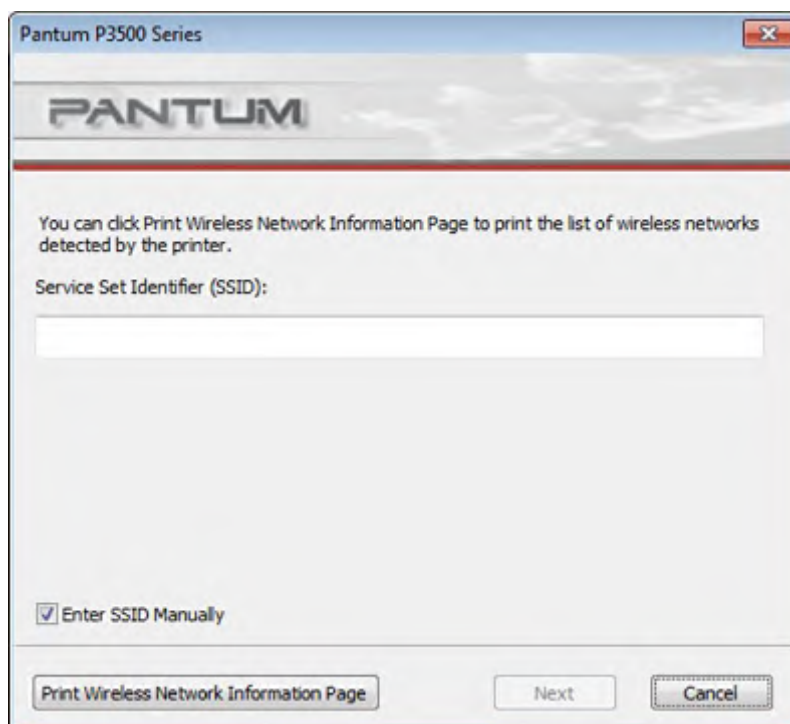



Note: • At the first installation, user can also install WiFi Model through WiFi Configuration interface and connect the printer to WiFi. Please refer to [Chapter 4](#) for the specific setting steps of the WiFi configuration tools.

During the driver installation, if "Windows cannot verify the publisher of this driver software" pops up to ask users whether to continue installation or not, users should click on "Install this driver software anyway". System warning interface may differ slightly in different operating systems.



3) Installation Complete Interface

This interface indicates that the installation is completed. It will automatically exit in 3 seconds and set the printer as default.

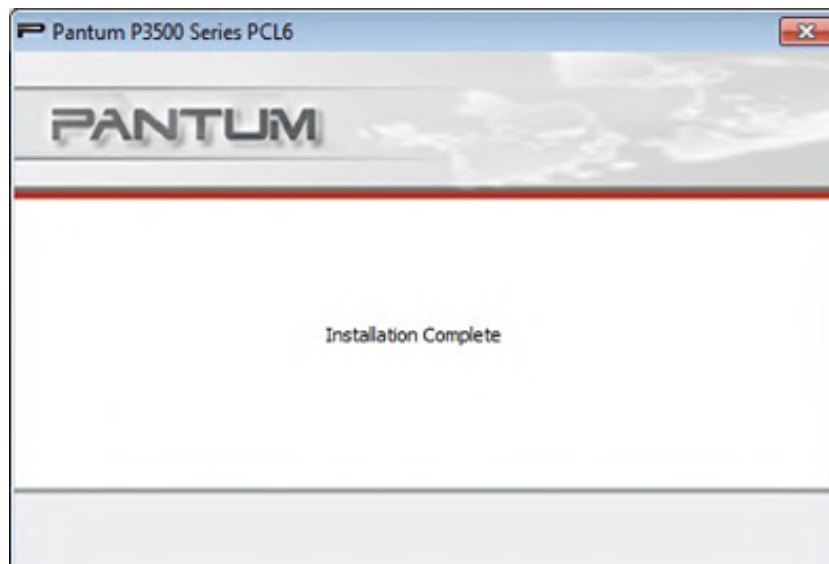

3.1.3. Driver Uninstallation

1) Select Uninstallation Mode.

Click Start > All Programs to find the "Pantum" folder, and then click the name of the product to be uninstalled to enter the uninstallation interface. Or click Start > Control Panel, and then click Uninstall Programs to find the product to be uninstalled, with the uninstallation interface shown as follows.

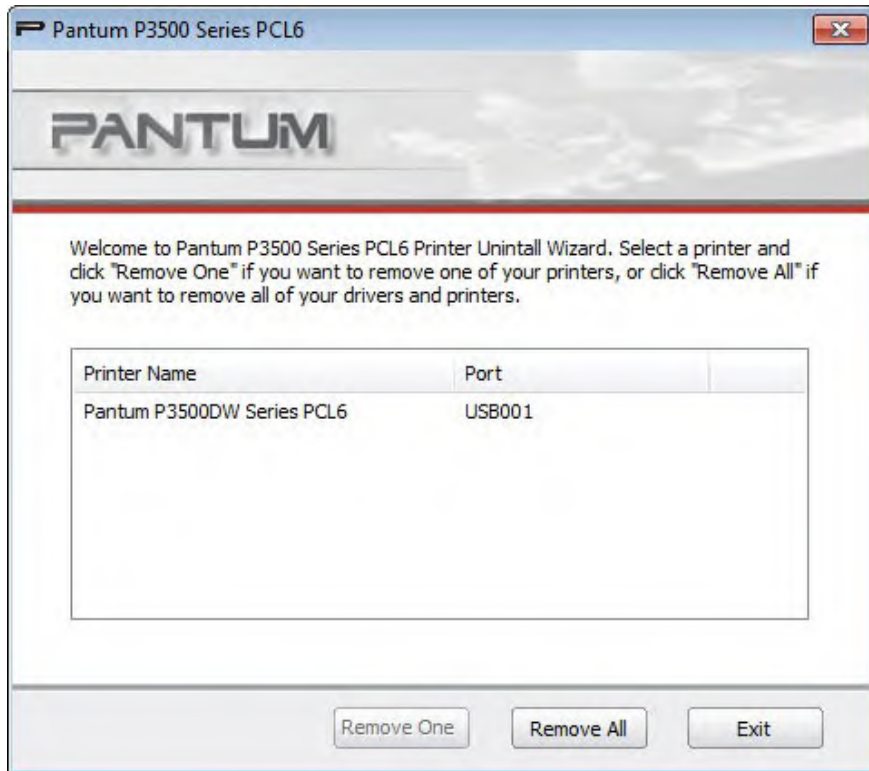

2) Select the name of the printer to be deleted, and click "Remove One" or directly click "Remove All" to enter the uninstallation progress interface.

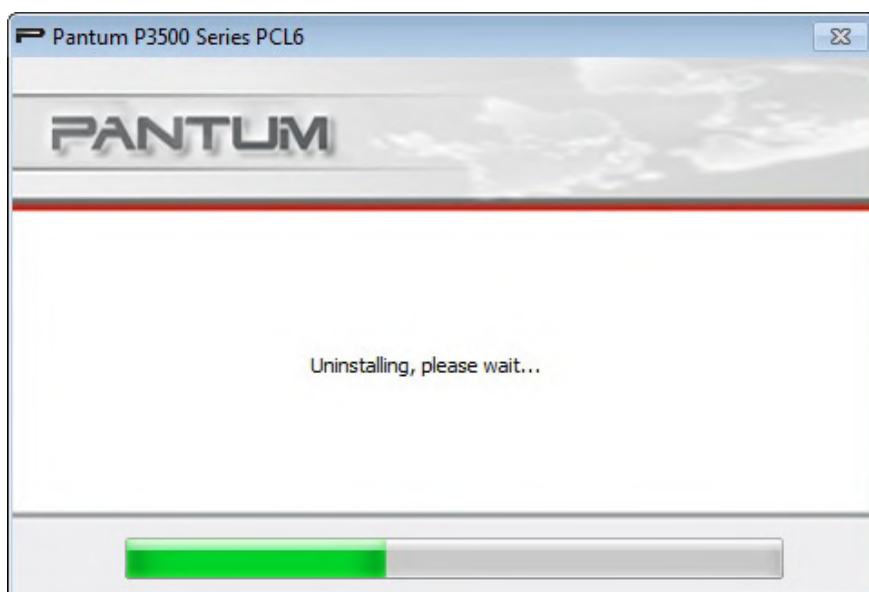

3) Uninstallation privilege verification prompt.

Uninstallation requires administrator privileges. If a non-administrator runs the uninstaller, a message box with the words "Insufficient privileges. Please uninstall Pantum P3500 printer with administrator privileges." will pop up, and the main interface of the uninstaller will not be displayed. Click OK in the message box, the message box interface will disappear.

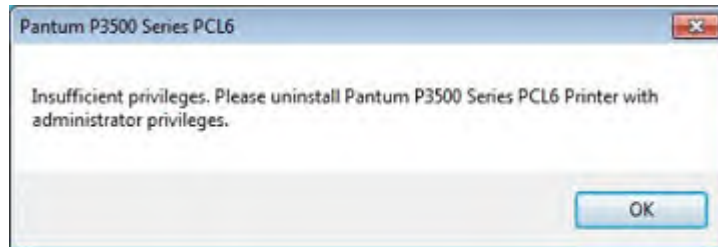

If any task remains in the print queue, a warning will pop up, saying "The Pantum P3500 Series Laser Printer is in use. Please uninstall the driver after the printing is completed." See the figure below:

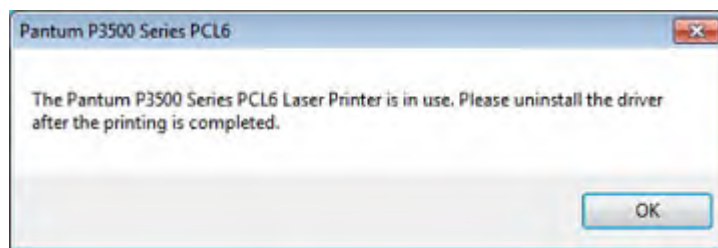

4) Complete Interface.

After the progress bar advancing is completed, it will enter the Complete Interface.

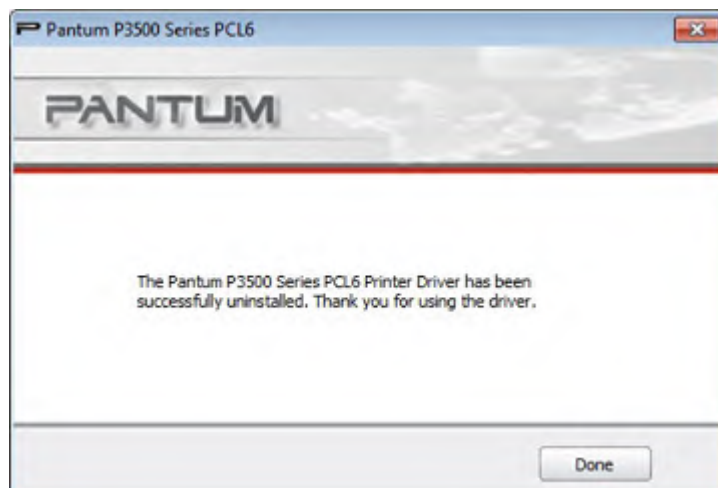

Click the "Done" button, the following window will pop up prompting you to restart the computer. Click "OK" to exit the uninstaller and restart the computer; click "Cancel" to exit the uninstaller.



3.2. Installation of the Driver Software based on Mac System

Introduction

Mac driver installer is made by using the PackageMaker software that comes with the Mac System. The installation style is basically consistent with the installation of the ordinary software under Mac.

The installation is divided into the following steps: introduction, license, destination volume, installation type, installation, and summary.

Installation Steps:

1. Introduction

Insert the CD-ROM into the CD-ROM driver, run the CD-ROM and click the Mac system installation package, then the following interface will display:

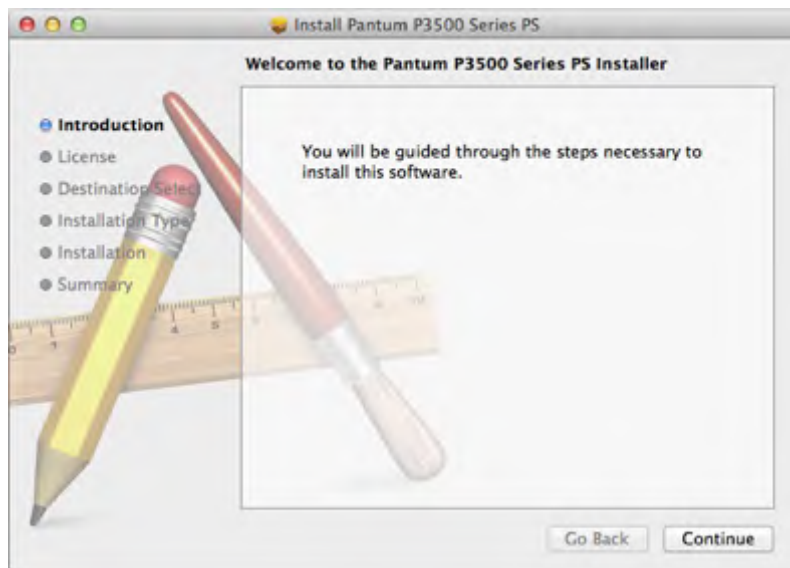

2. License

Click Continue on the above figure to display the contents of the License Agreement, as shown below:



3. Click Continue, it will pop up the "To continue installing the software, you must agree to the terms of the software license agreement." dialog box.



Click Agree to accept the License Agreement and continue the installation.

4. Installation Type

Display the installation-related information, as shown below.

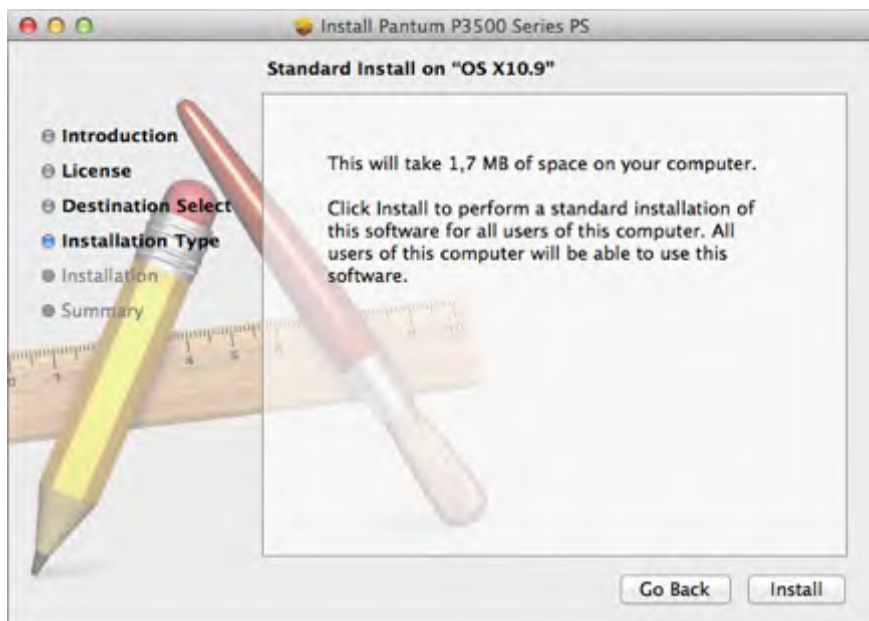

Click Install, the following prompt box will pop up. Logging in as an administrator and getting permission, you can continue with the installation.



5. Installation

The installation progress is shown below:

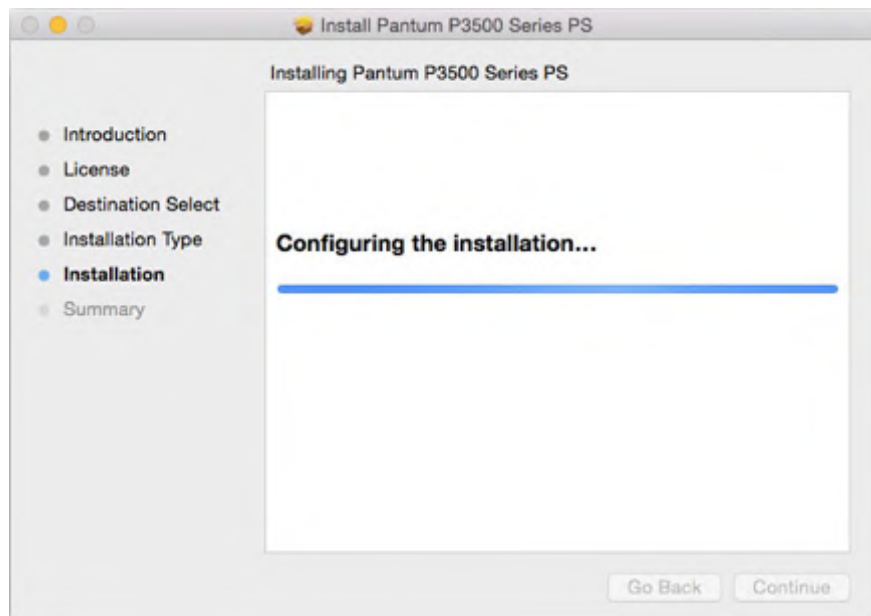

6. Summary

Installation completes, as shown below:

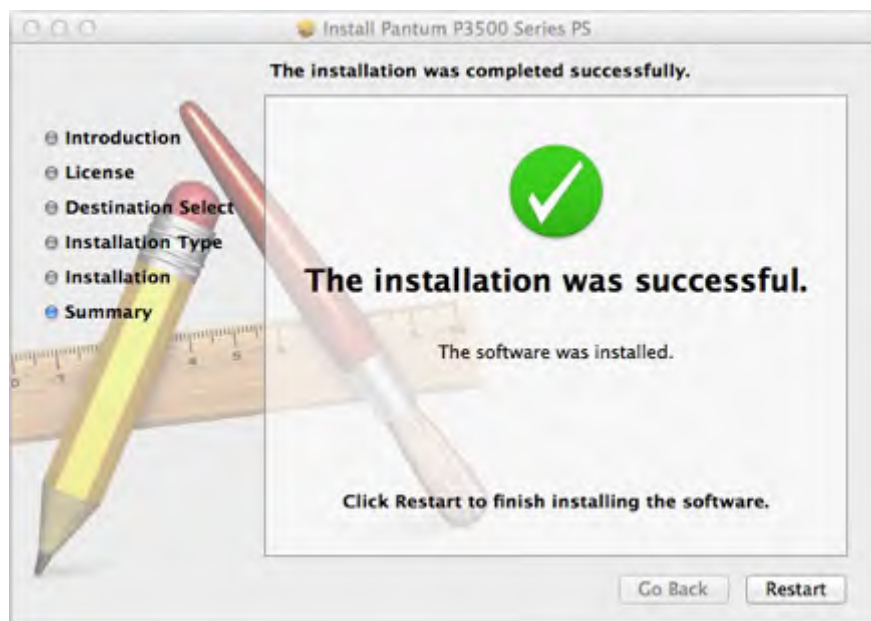

Network Configuration (For printer models that support wired/wireless network features)

4

Chapter

4. Network Configuration (For printer models that support wired/wireless network features)	4-2
4.1. Wired Network Configuration (For printer models that support wired network features)	4-2
4.2. Wireless Network Configuration (For printer models that support wireless network features)....	4-2
4.2.1. WiFi Protected Setup	4-2
4.2.2. Setting up through WiFi Configuration Tool	4-3
4.2.3. Setting up through Web Server.....	4-15
4.2.4. Turn on/off Wireless Device	4-16
4.3. Set Network Printer.....	4-17
4.3.1. Web Server Settings	4-17
4.3.2. Control Panel Settings	4-20

4. Network Configuration (For printer models that support wired/wireless network features)

4.1. Wired Network Configuration (For printer models that support wired network features)

Printers that support wired network printing can be connected to the LAN or WAN, thereby the printer will work through a wired network connection.

In this setting, the printer is directly connected to the network and can be set to allow all computers on the network to print directly on the printer, and achieve network sharing print.

Before starting the printer, first connect the network cable to the network port of the printer and ensure both the printer and the computer are under the same network environment to directly connect the printer to the network. For detail installation steps, please refer to [Chapter 3](#).

4.2. Wireless Network Configuration (For printer models that support wireless network features)

For printer models that support WiFi features, users can connect the printer with the wireless network through "WiFi Protected Setup", "Web Server Setup" or "WiFi Configuration Tool".

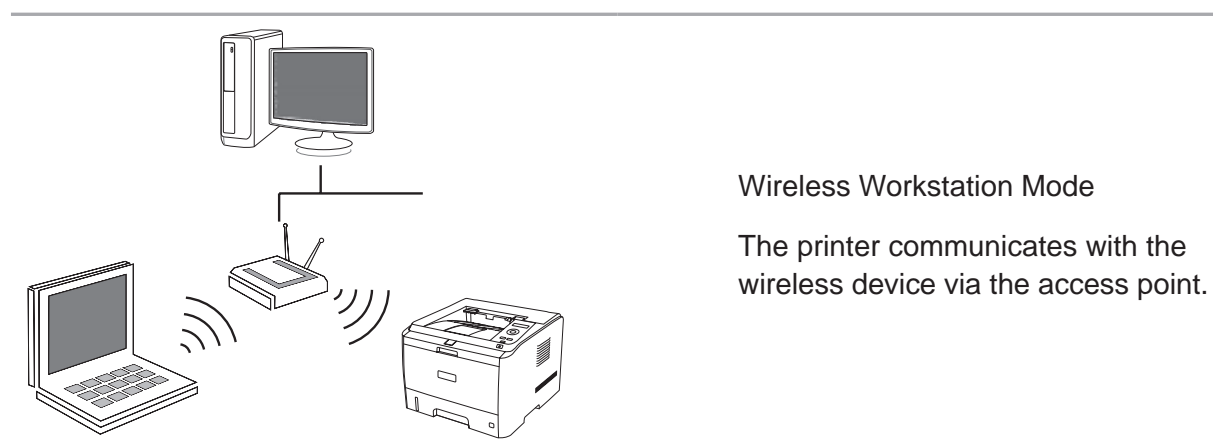

Note: • The printer can connect with both the wired and wireless network at the same time.

4.2.1. WiFi Protected Setup

If the wireless router to which the printer is going to be connected supports the WPS (WiFi Protected Setup) feature, it will be not necessary for users to use the computer, instead, they can just use the "WiFi" button on the control panel of the printer to complete the connection between the printer and the wireless network.

Setup Method: Press and hold the "WiFi" button on the control panel of the printer for about 2 seconds to start the WPS, with the indicator of "WiFi" button beginning to flash. Press the WPS button on the wireless router after 2 minutes of the launching, then the printer will be connected to the wireless network.



Note: • The access point (or the wireless router) must support WiFi Protected Setup™ (WPS).

4.2.2. Setting up through WiFi Configuration Tool

WiFi configuration tool is a computer software that helps users to set the printer SSID, encryption method and password. Use USB cable to connect the printer with the computer, then launch the Pantum wireless network configuration tool on your computer and conduct wireless network configuration on the printer.

Open the WiFi configuration tool from the driver installation package. The specific steps are as follows:

4.2.2.1. Windows System

1) Detect Wireless Network Card

WiFi configuration tool can search the wireless network automatically by using a wireless card in the computer. If the computer does not have a wireless card, the option of "Enter SSID Manually" will be automatically ticked on the "Wireless Network List" page. Please skip to Step 3 in this case.

2) Wireless Network List

After launching the configuration tool, the display of Network List detected by the wireless network configuration program appears, where you can select the wireless network.

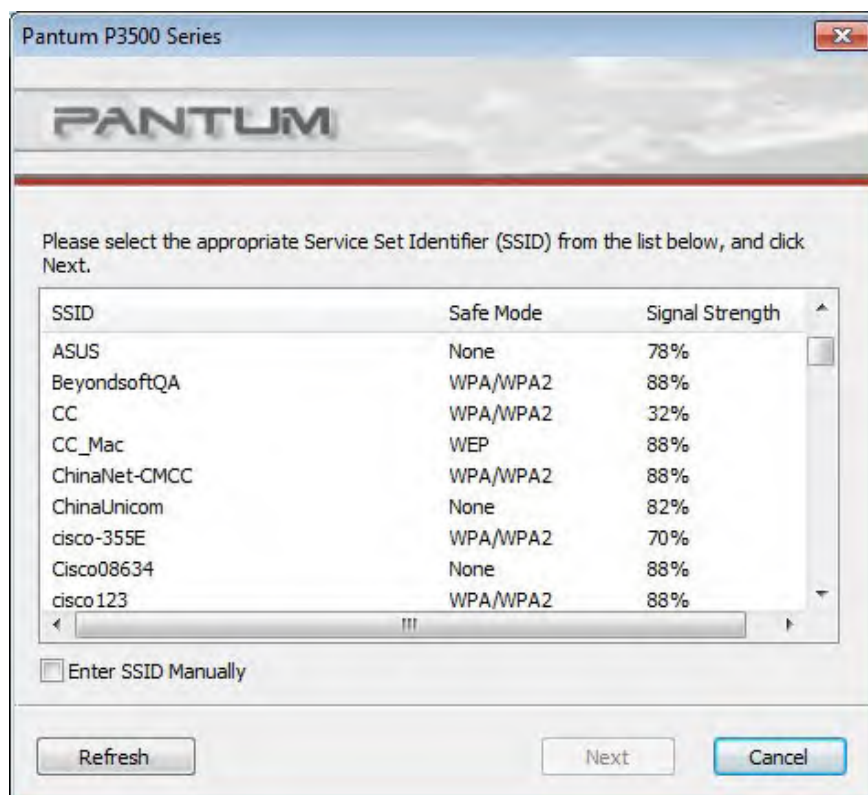



- Note:**
- After launching the configuration tool, the Network List interface appears with the information found by the program, e.g., the name of the wireless network, which is sorted by SSID. Users can select an item in the list, and then double-click or click Next to enter the Information Input interface.
 - "Enter SSID Manually": click to switch to the Enter SSID Manually interface, i.e., Step 3.
 - "Refresh": Searching for wireless network information again.
 - "Next": Enter the Information Input interface.
 - "Cancel": The prompt of cancellation appears after clicking it. As shown below (click "OK" to exit, otherwise stay at the original interface).

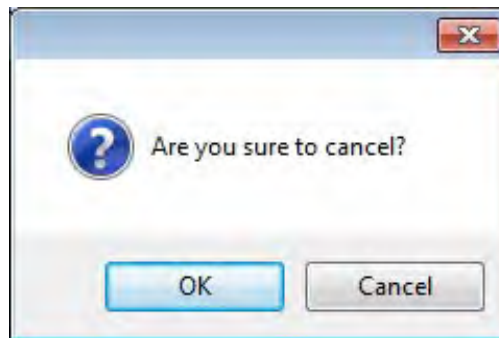

3) Enter SSID Manually

Click "Enter SSID Manually" to switch to the interface of manually entering the SSID.

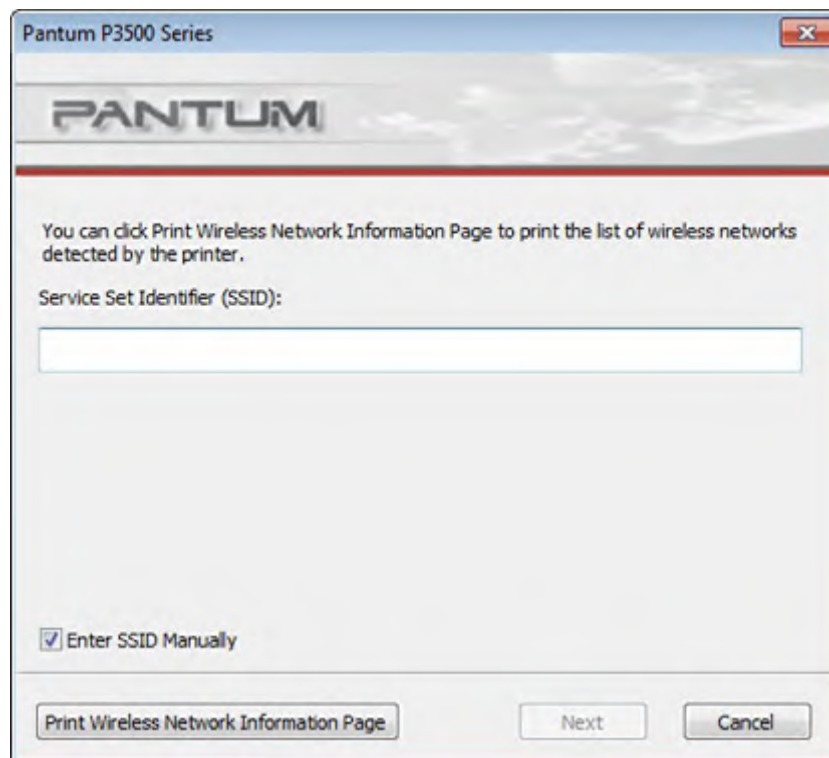

Enter the SSID for the printer to be connected in the "SSID" bar.

Click Print Wireless Network Information Page to print the list of wireless networks detected by the printer.



Note: • If the printer with current configuration has ongoing printing work, the following error prompting window will pop up.

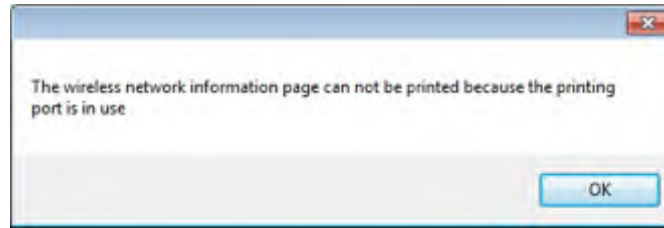

4) Information Input Configuration

Entering the Information Input interface, users can set relative information of the wireless network.

Pantum P3500 Series

PANTUM

Verify the wireless credential and click Next.

Service Set Identifier (SSID):
SW

Safe Mode:
WPA/WPA2

Password:

Show Password

Previous Next Cancel



Note: • Safe Mode is currently available in three types: None, WEP, and WPA/WPA2. When it is None, the password entry field will be hidden, which means no password is needed while connecting the SSID provided. The range for WEP entry is 1-26 characters, and that of WPA/WPA2 is 8-64 characters.

• Show Password is unchecked by default; when it is checked, the password entered will be displayed as it is instead of asterisks.

If the printer with current configuration has ongoing printing work, the following error prompting window will pop up.

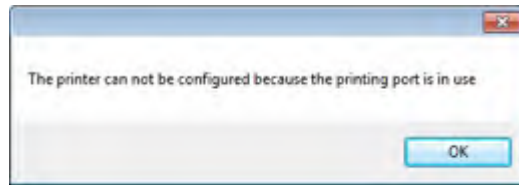

5) Configuration Completed

After completing the above steps, the Wireless Network Configuration Result interface pops up. The configuration result will be displayed.

If the configuration of the printer's wireless network is successful, the following interface will pop up:



The following message will appear if the printer is not connected to the computer: Please use the USB cable provided to connect your printer with the computer.

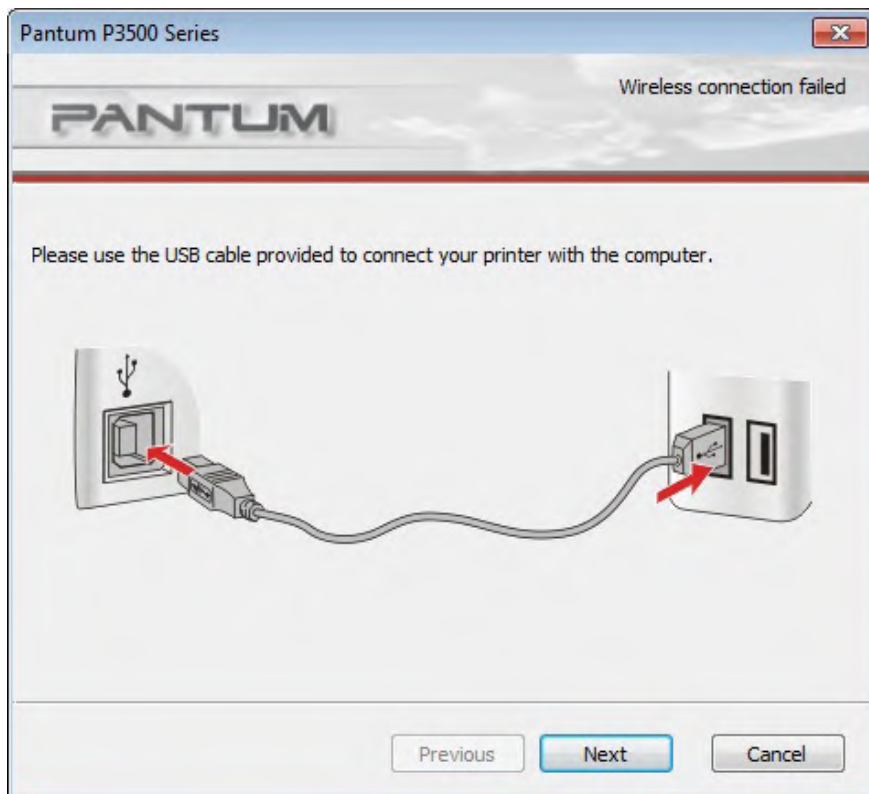

Click "Next" and the program will automatically search for the printers connected to the PC currently. If searching for the printer models supported by this PC is failed, it will remain at the current interface; if it finds any supported models, a message of "Trying to establish a wireless connection with the printer" will pop up.

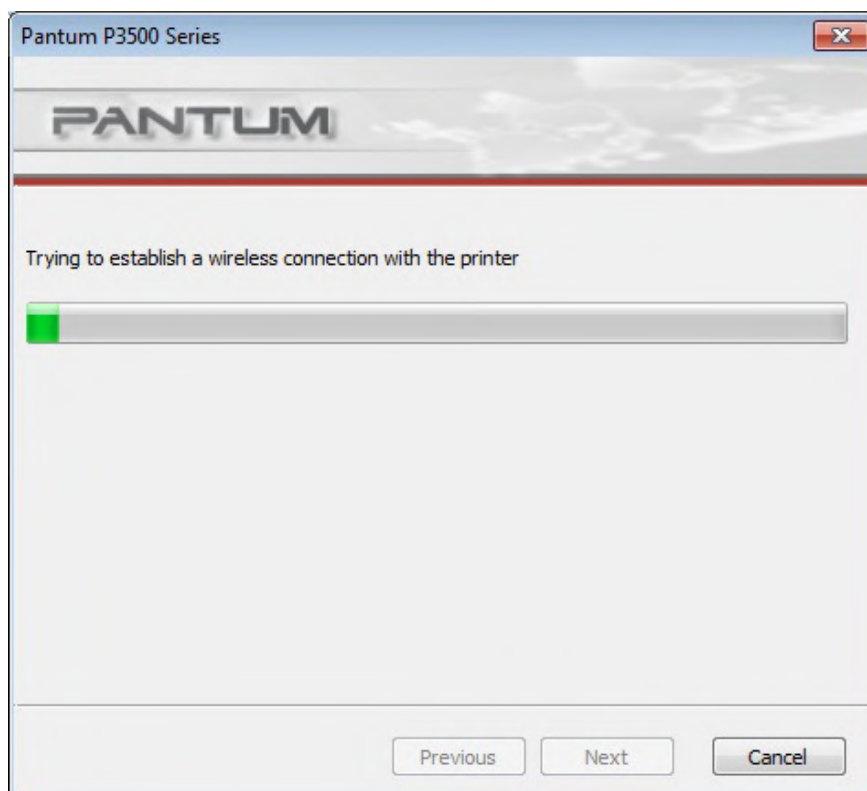

The following message will appear if the printer fails to apply the configuration by using the wireless network provided:

The printer cannot connect to any wireless networks with the wireless credentials provided. To reenter the credentials, please click Previous.



The following message will appear if the printer can apply the configuration by using the wireless network provided, but the PC does not support the wireless network:

"The printer can successfully connect to a wireless network with the wireless credentials provided. However, this computer is unable to communicate with the printer."



4.2.2.2. Mac System Configuration

The following operating systems are supported: Mac OS 10.6, 10.7, 10.8, 10.9, and 10.10.

1) Detect Wireless Network Card

WiFi configuration tool can search the wireless network automatically by using a wireless card in the computer. If the computer does not have a wireless card, the option of "Enter SSID Manually" will be automatically ticked on the "Wireless Network List" page. Please skip to Step 3 in this case.

2) Wireless Network List

After launching the configuration tool, the display of Network List detected by the wireless network configuration program appears, where you can select the wireless network.

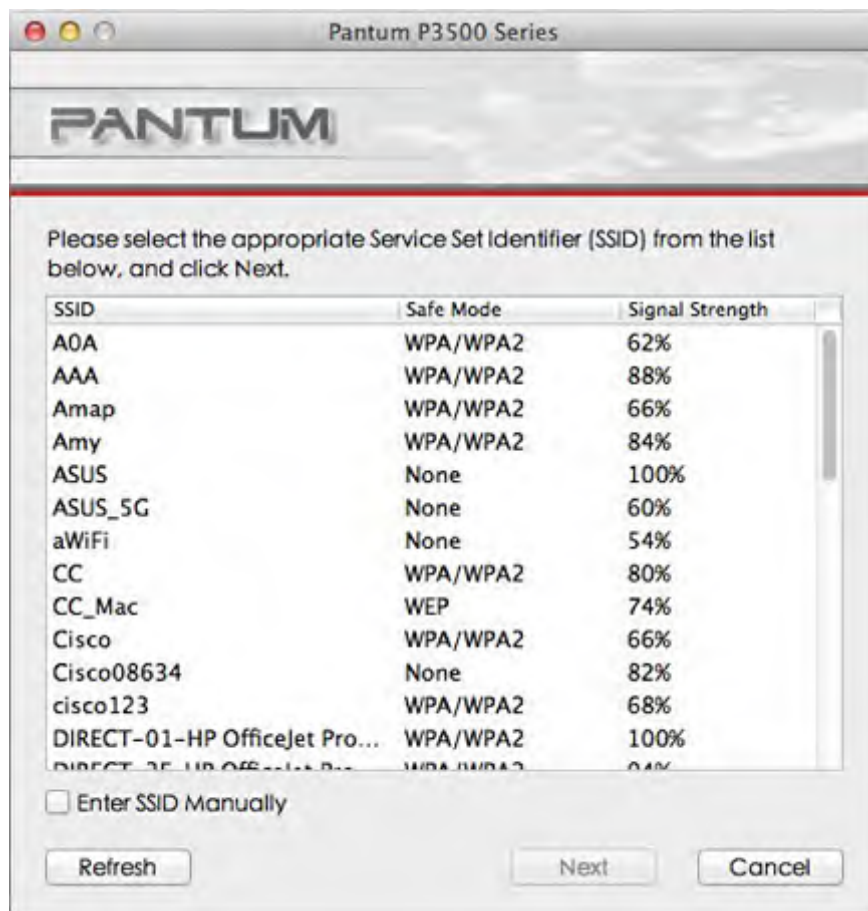



- Note:**
- After launching the configuration tool, the Network List interface appears with the information found by the program, e.g., the name of the wireless network, which is sorted by SSID. Users can select an item in the list, and then double-click or click Next to enter the Information Input interface.
 - Enter SSID Manually: click to switch to the Enter SSID Manually interface, i.e., Step 3.
 - Refresh: Searching for wireless network information again.
 - Next: Enter the Information Input interface.
 - Cancel: The prompt of cancellation appears after clicking it. As shown below (click OK to cancel, click Cancel to stay at the original interface):

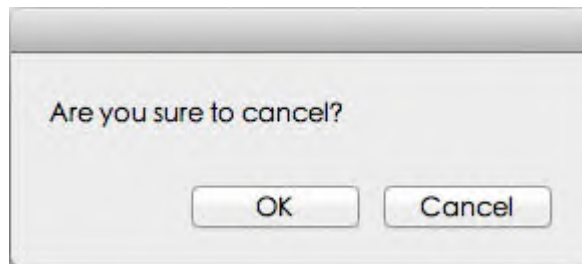

3) Enter SSID Manually

Click "Enter SSID Manually" to switch to the interface of manually entering the SSID.

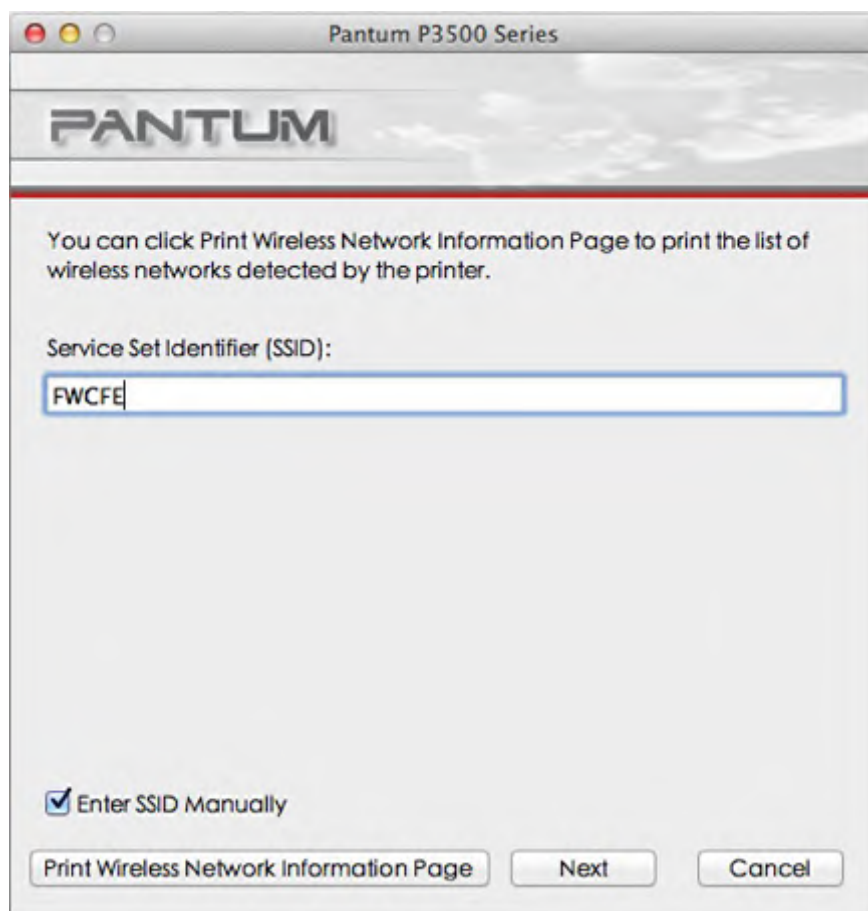

SSID: enter the service set identifier of the network for the printer to be connected, with the maximum length of 32 characters.

Print Wireless Network Information Page: allow you to print the list of wireless networks detected by the printer.

Next: enter the Information Input interface.



Note: • If the printer with current configuration has ongoing printing work, the following error prompting window will pop up.

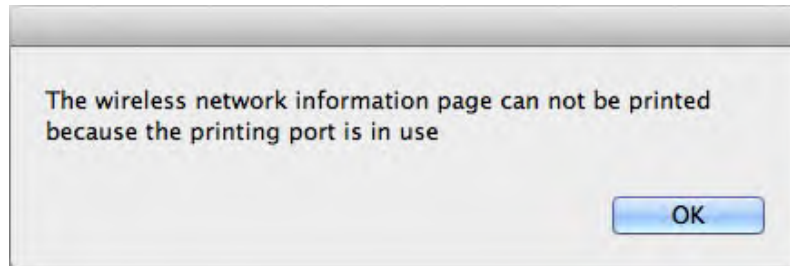

4) Information Input Configuration

Entering the Information Input interface, users can set relative information of the wireless network.

Pantum P3500 Series

PANTUM

Verify the wireless credential and click Next.

Service Set Identifier (SSID):
FWCFE

Safe Mode:
WPA/WPA2

Password:

Show Password

Previous Next Cancel



-
- Note:**
- Safe Mode is currently available in three types: None, WEP, and WPA/WPA2. When it is None, the password entry field will be hidden, which means no password is needed while connecting the SSID provided. The range for WEP entry is 1-26 characters, and that of WPA/WPA2 is 8-64 characters.
 - Show Password is unchecked by default; when it is checked, the password entered will be displayed as it is instead of asterisks.
-

If the printer with current configuration has ongoing printing work, the following error prompting window will pop up.

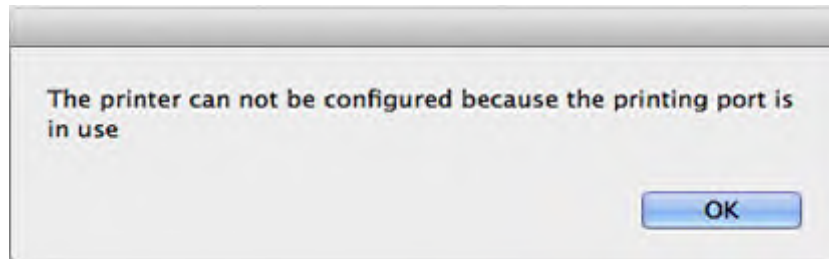

5) Configuration Completed

After completing the above steps, the Wireless Network Configuration Result interface pops up. The configuration result will be displayed.

If the configuration of the printer's wireless network is successful, the following interface will pop up:

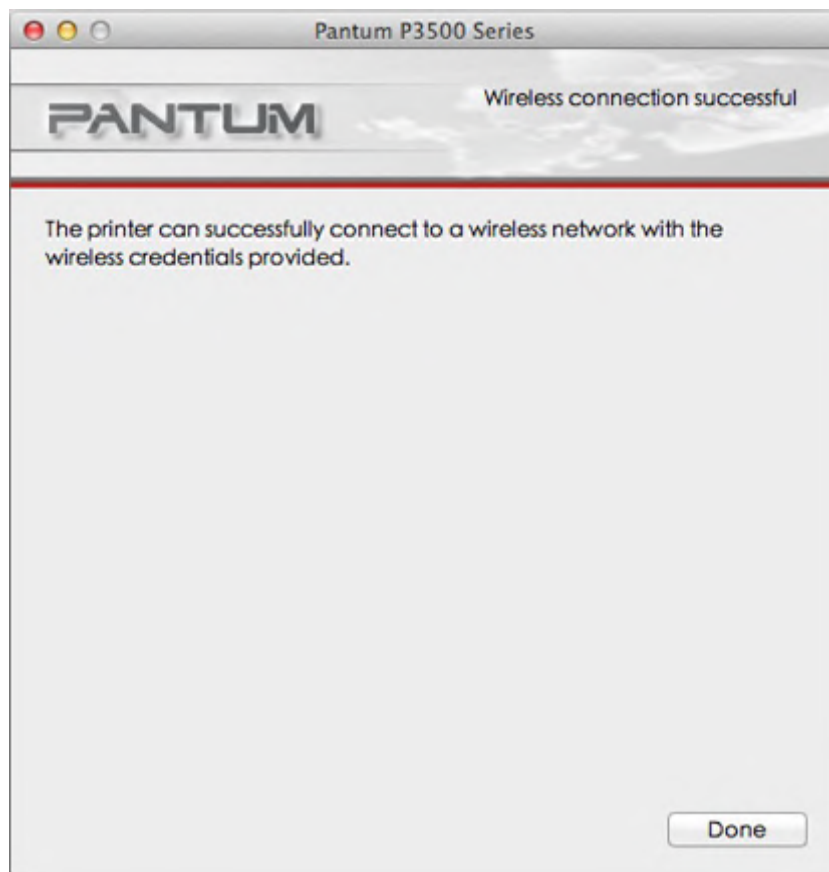

The following message will appear if the printer is not connected to the computer: Please use the USB cable provided to connect your printer with the computer.

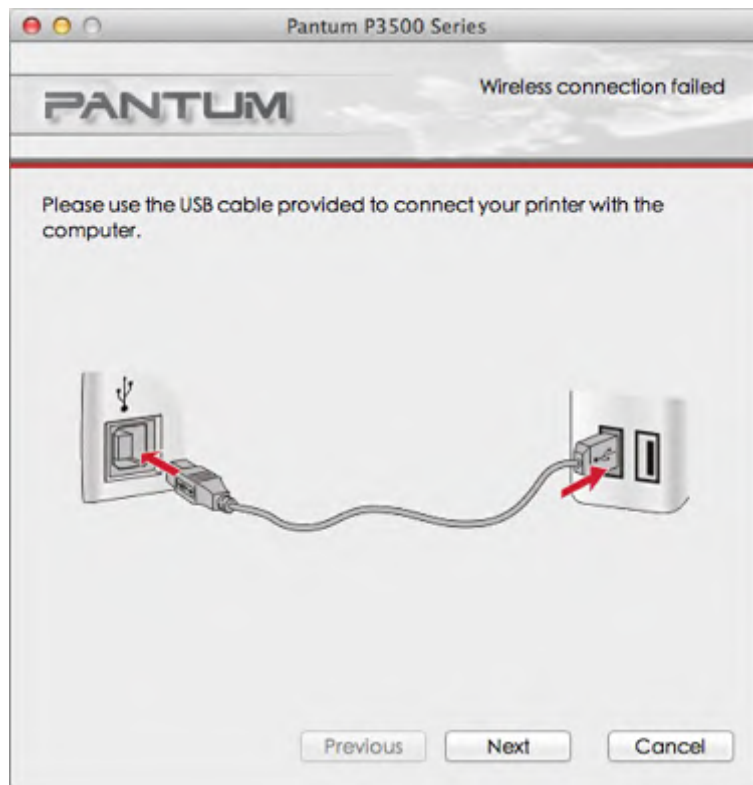

Click "Next" and the program will automatically search for the printers connected to the PC currently. If searching for the printer models supported by this PC is failed, it will remain at the current interface; if it finds any supported models, a message of "Trying to establish a wireless connection with the printer" will pop up.

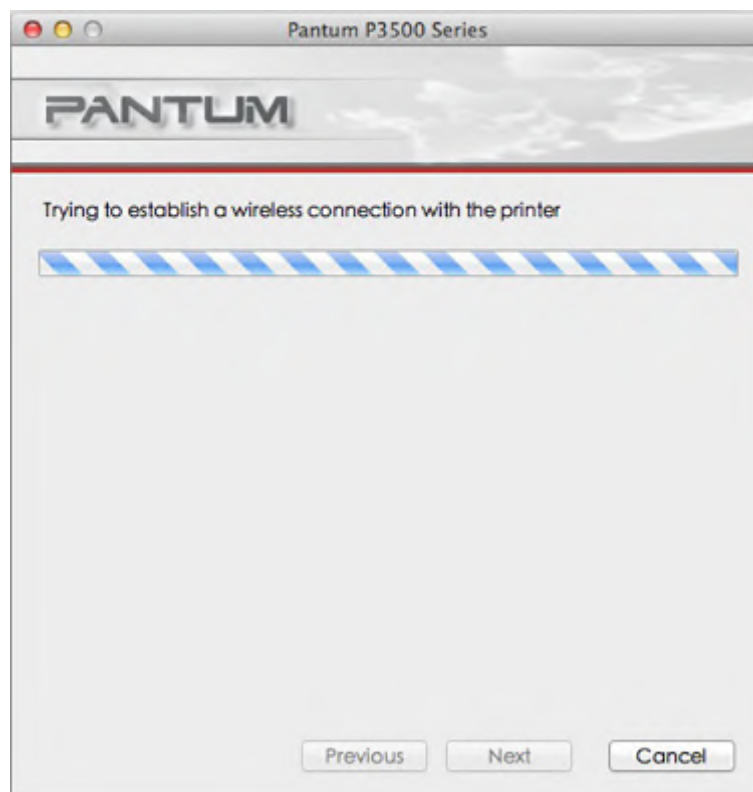

The following message will appear if the printer fails to apply the configuration by using the wireless network provided:

The printer cannot connect to any wireless networks with the wireless credentials provided. To reenter the credentials, please click Previous.

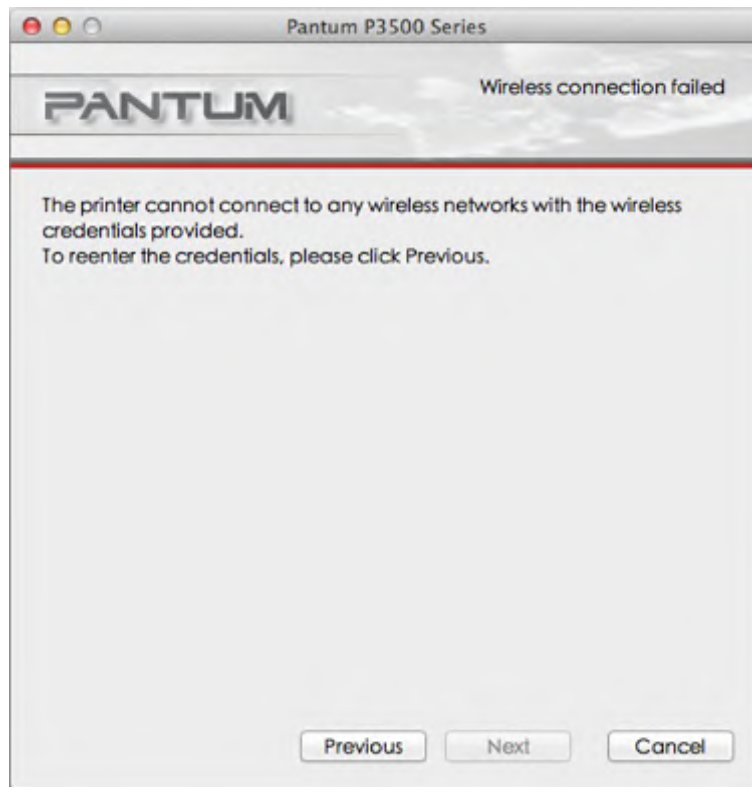

The following message will appear if the printer can apply the configuration by using the wireless network provided, but the PC does not support the wireless network:

The printer can successfully connect to a wireless network with the wireless credentials provided. However, this computer is unable to communicate with the printer.



If the printer can apply the configuration with the wireless network provided, and the PC supports the wireless network, the following message will appear:

The printer can successfully connect to a wireless network with the wireless credentials provided.

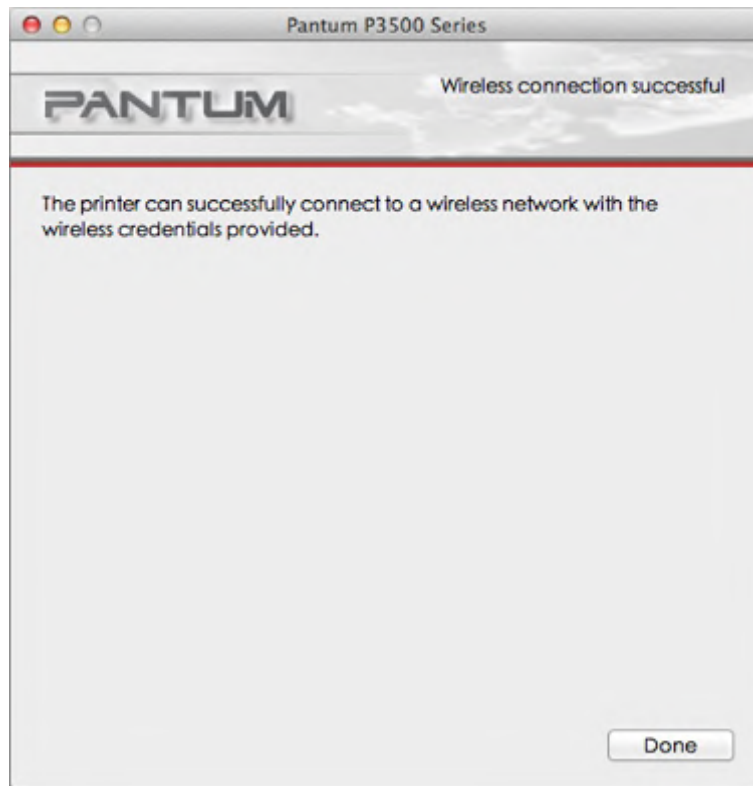

4.2.3. Setting up through Web Server

You can use the embedded Web server of the printer to conduct the wireless network configuration.

1. Print the network information page, and view the IP address of the printer.
2. Enter the IP address into the Web browser's address bar to access the embedded Web server of the printer. Click "Settings", and the page is shown as follows:

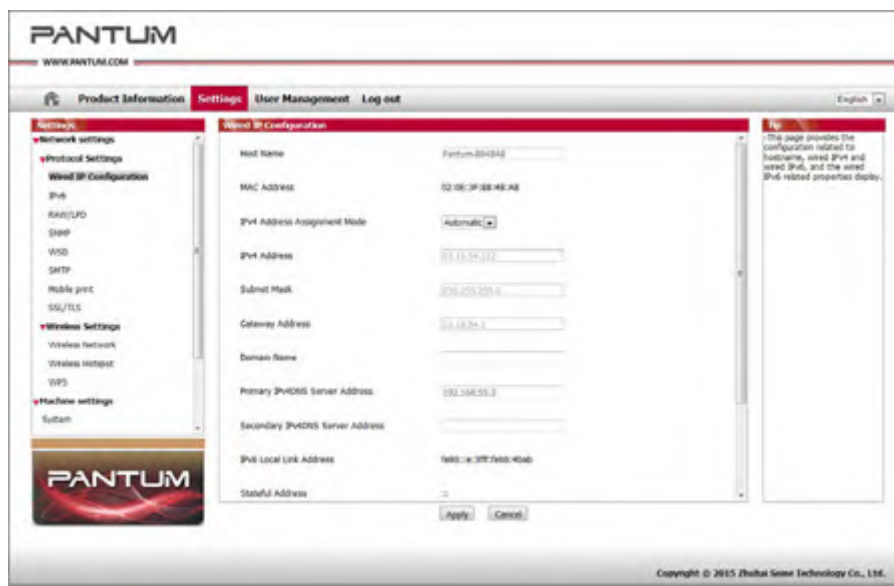

3. Click "Wireless Network" to enter the Wireless Network Configuration interface.

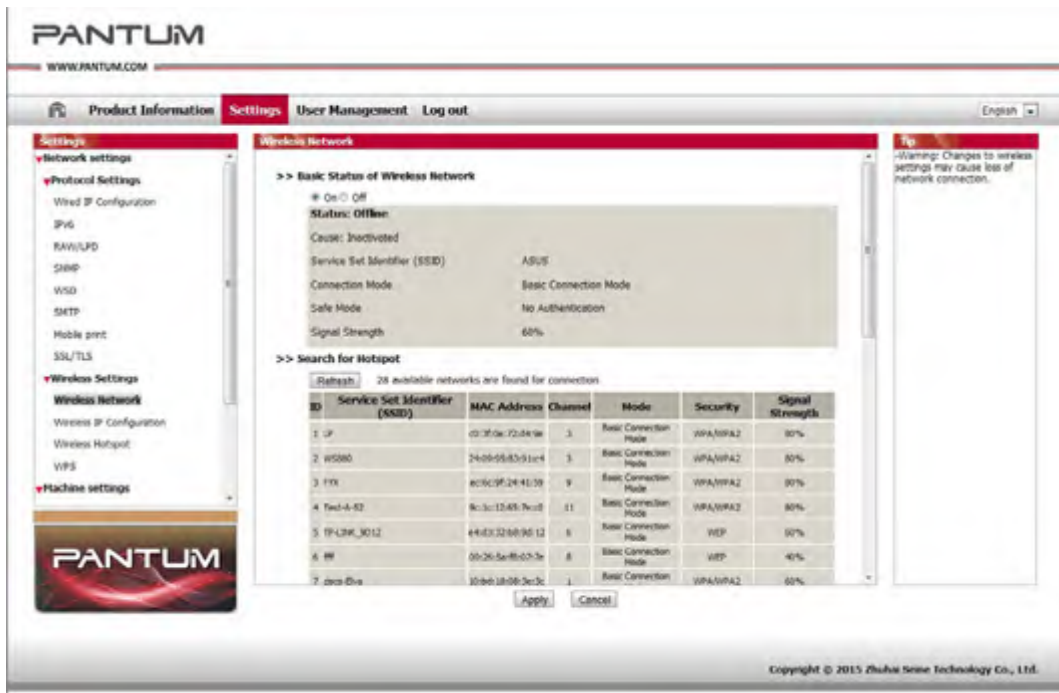

4.2.4. Turn on/off Wireless Device

If you want to disconnect the printer with the wireless network, you can turn off the wireless feature of the printer via the Menu button on the control panel.

- 1) Press "Menu" to enter the Menu Settings interface.
- 2) Press direction key "▲" or "▼" to select the "4.Network Set" option and press "OK".
- 3) Press direction key "▲" or "▼" to select the "2.Wireless Conf" option and press "OK".
- 4) Select the "1.Wireless NetW" option, and press "OK" to select the "1.Turn Off" option, and then click "OK" to turn off the wireless network.

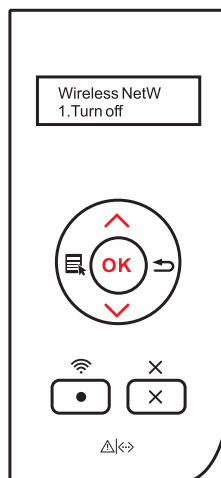

After the wireless network is turned off, the indicator of the WiFi button on the control panel goes out.

4.3. Set Network Printer

User can control the network settings through the embedded Web Server of the printer or the Printer Control Panel.

4.3.1. Web Server Settings

4.3.1.1. View Web Server or Change Network Settings

You can use the embedded Web server to view or change IP settings.

1. Print the network information page, and view the IP address of the printer.



Note: • For printing product network information page, please refer to [Chapter 1](#).

Enter the IP address into the Web browser's address bar to access the embedded Web server of the printer. The page is shown as the following figure:

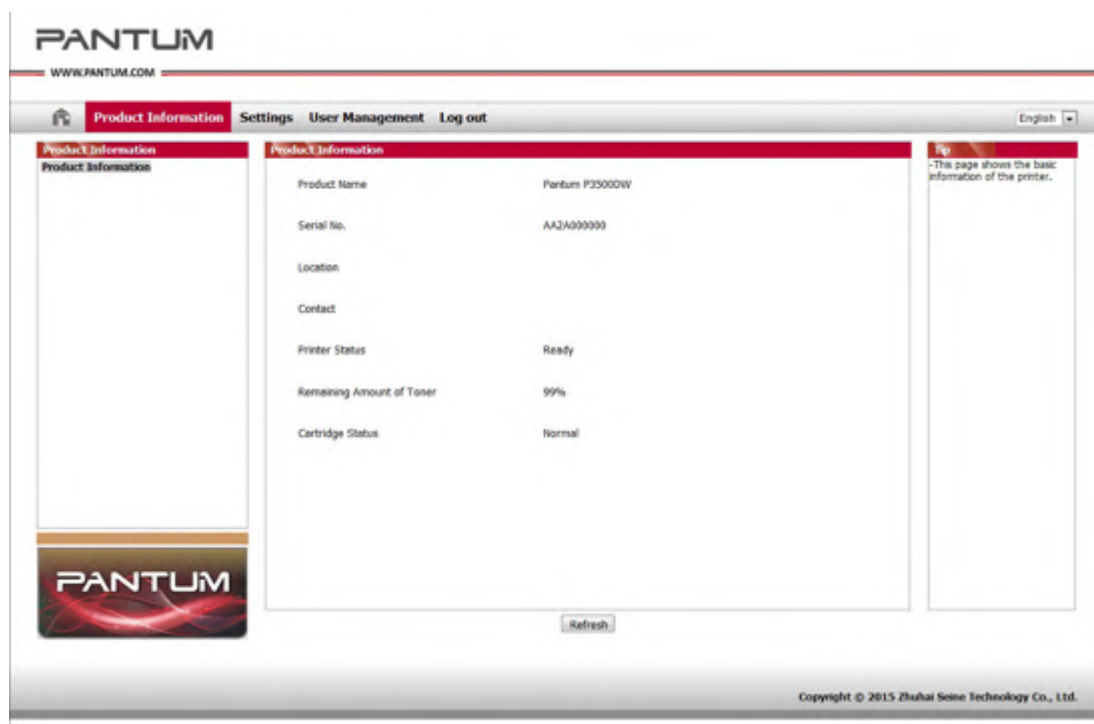

Note: • This printer supports the HTTP application protocol, and users can realize secure encrypted access by typing: `https://xxxx...` in the Web explorer.

2. There are Network Settings and Printer Settings in the "Settings" column. For Network Settings, users can complete the settings of the Networking Protocol, wireless network, WiFi hotspot, etc.; for Printer Setting, can complete the settings of Printing Preferences, e-mail and other relative configuration information.

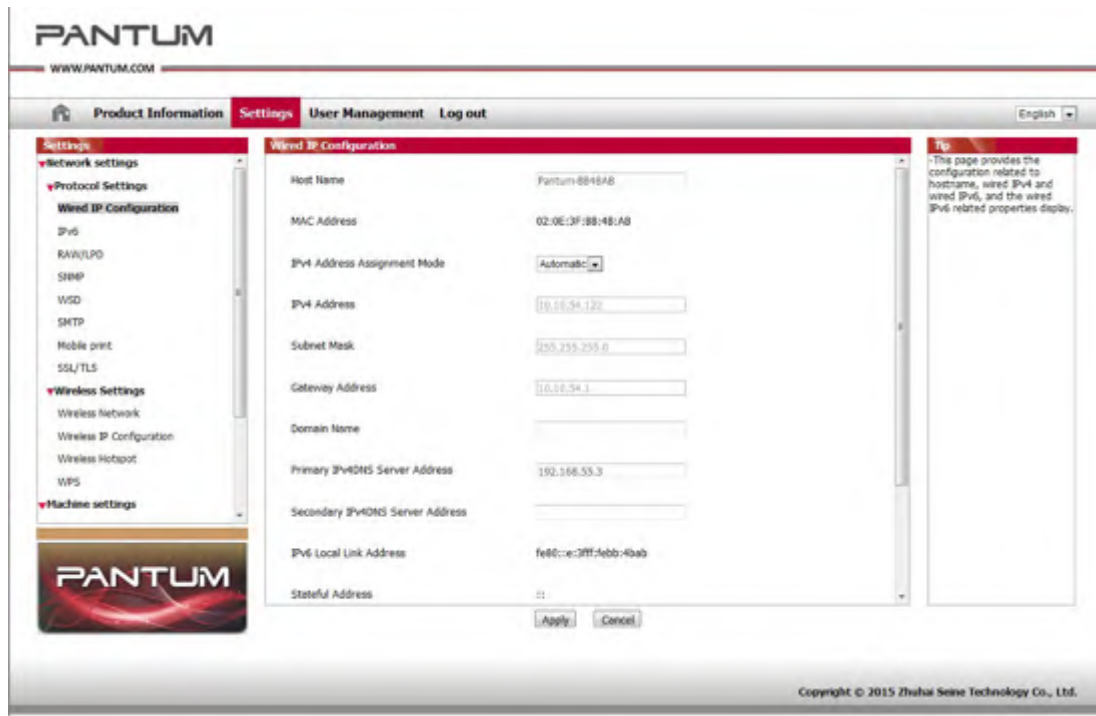

4.3.1.2. Set or Change Web Page Login Password

Users can realize the management and control of the printer through User Management Settings.

Steps:

1. To open the embedded Web server, please log in first. The login page is shown as follows:

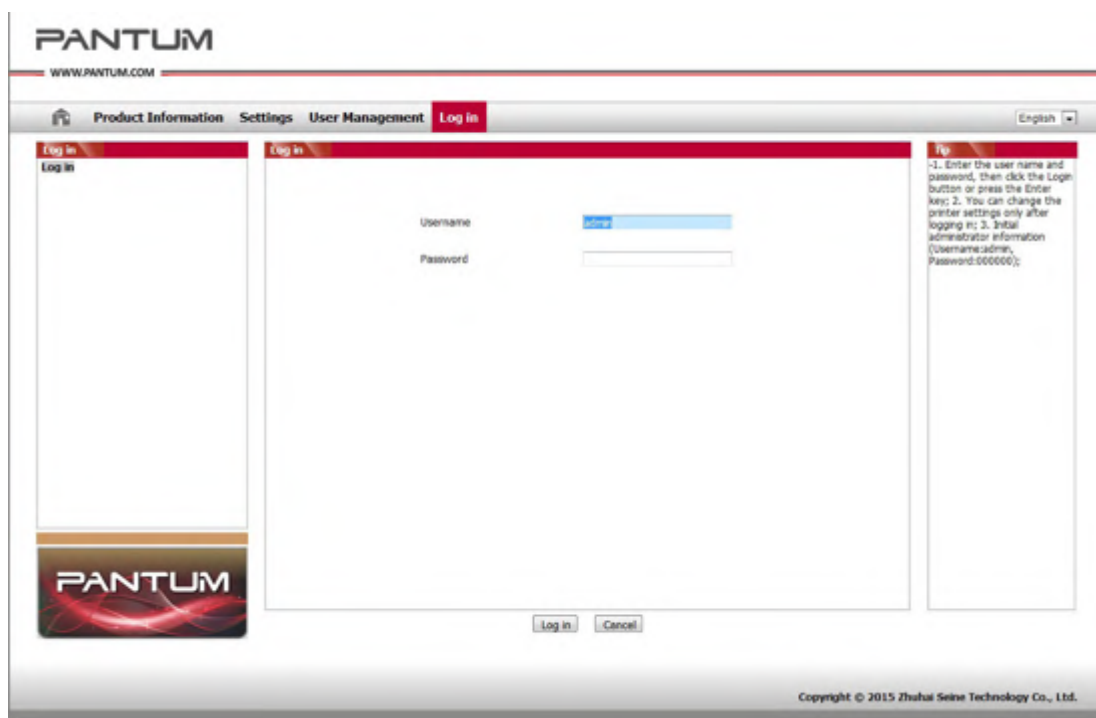



Note: • The default username of the printer is "admin", and the initial password is "000000".

2. Click the "User Management" tab to perform the corresponding operations.
3. Enter the new password in the Password box and Confirm Password box.

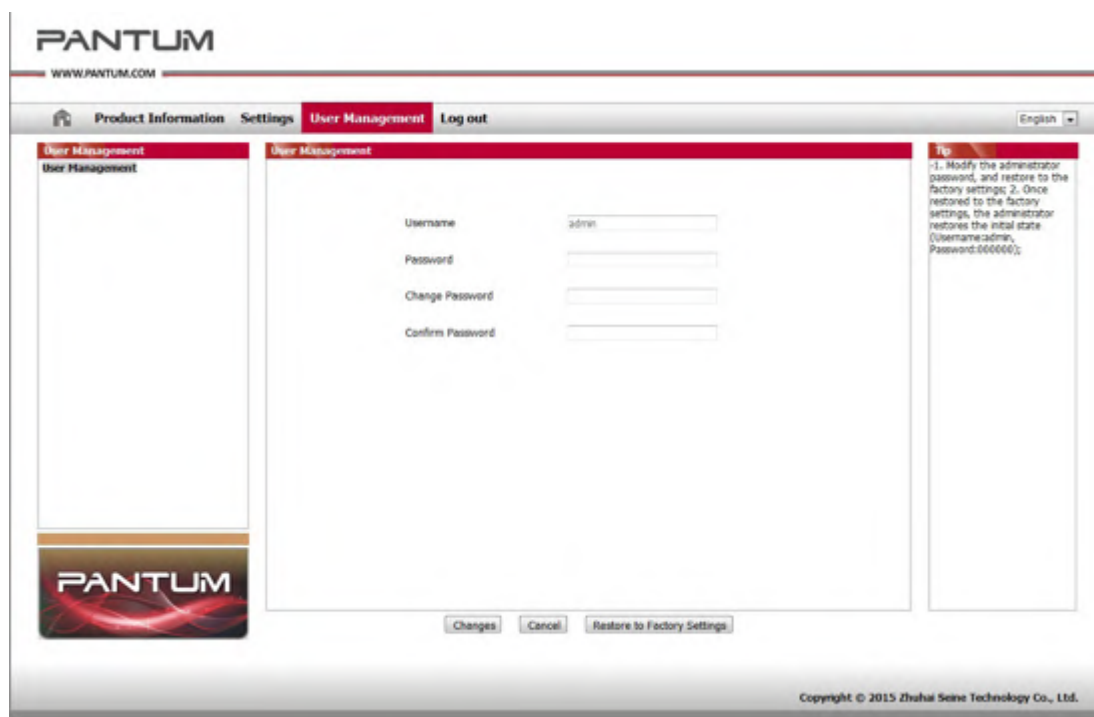

4. In the bottom of the window, click Changes to save the settings.

4.3.1.3. IP Address

The printer's IP address can be automatically set through the DHCP function and can also be set manually.

Automatic Setting

The DHCP automatic setting function is enabled by default.

1. Connect the printer to the network through a network cable and complete the startup preparation work.
2. The printer will automatically obtain the IP address assigned by the server. The IP address obtained automatically can be used after a few minutes.



Note: • If DHCP cannot automatically obtain the IP address, the printer will automatically use the default IP address: 169.254.1.1.
• Due to the features of DHCP, the IP address of the printer automatically assigned by the network may vary if the printer has not been used for a long time or the network access point changes, which could result in unsuccessful connection to the printer. It is recommended that the IP address automatically assigned by the network is bound to the Mac address of the printer while the DHCP function is enabled.

Manual Setting

Enter the IP address in the Web browser's address bar to open the embedded Web server.

1. Click Settings in the navigation bar to open the Settings page;
2. Select Network Settings - IPV4 Settings;
3. Set IP Address Assignment Mode (Manual), IP Address and Subnet Mask. Other items are optional;
4. Click Apply to save the settings.



- Note:**
- You can use the embedded Web server to change the IP Address Assignment Mode into Automatic or Manual.
 - To reset all the parameter settings of the printer, users can restore to the factory settings, and please refer to [Chapter 6](#) for the specific operations.

4.3.2. Control Panel Settings

Users can set up the wired network and wireless network through the Control Panel menu.

4.3.2.1. Network Settings

Users can set the network status through Network Settings.

- 1) Press "Menu" to enter the Menu Settings interface.
- 2) Press direction key "▲" or "▼" to select the "4.Network Set" option and press "OK".
- 3) Press direction key "▲" or "▼" to select the "1.Wired Config" and press "OK"; Press direction key "▲" or "▼" to select "1.IPv4" or "2.IPv6".

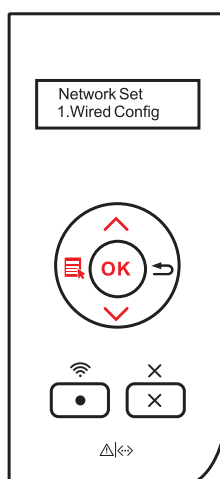

4) Press direction key "▲" or "▼" to select the "2.Wireless Conf" and press "OK"; Press direction key "▲" or "▼" to select "1.Wireless NetW" or "2.WPS PIN mode".

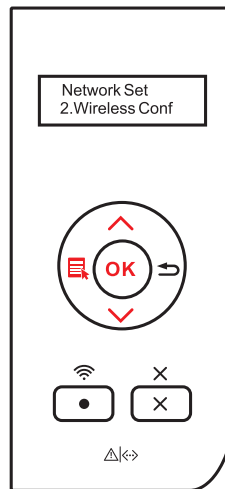

4.3.2.2. Network Information

Users can check the network status through Network Information.

- 1) Press "Menu" to enter the Menu Settings interface.
- 2) Press direction key "▲" or "▼" to select the "5.Network Info" option and press "OK".

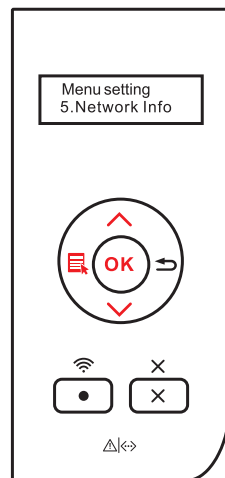

3) Press direction key "▲" or "▼" to select "1.Wired Info", "2.Wireless Info", or "3.WiFi Dir Info".

4) Select the "1.Wired Info" option and press "OK"; Press direction key "▲" or "▼" to select "1.IP Address", "2.Subnet mask", or "3.Gateway".

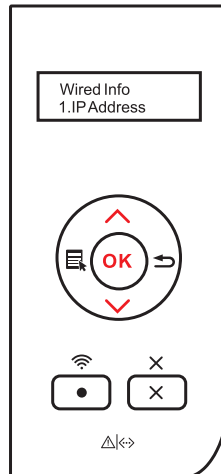

5) Select the "2.Wireless Info" option and press "OK"; Press direction key "▲" or "▼" to select "1 .Connect state", "2.IP Address", "3.Subnet mask", "4.Gateway", "5.Channel", or "6.SSID".

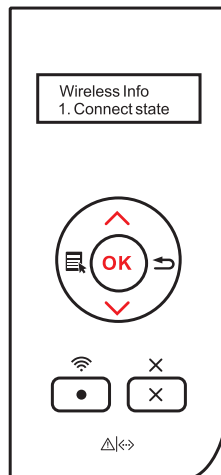

6) Select the "3.WiFi Dir Info" option and press "OK"; Press direction key "▲" or "▼" to select "1.Status", "2.Device name", "3.IP Address", "4.Password", "5.Channel", or "6.Conn device #".

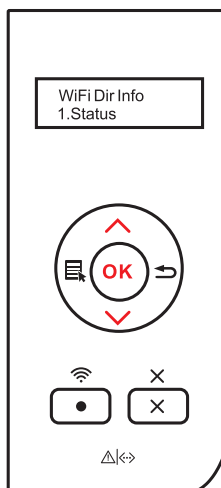

Mobile Print

5

Chapter

5. Mobile Print.....	5-2
5.1. WiFi Hotspot Connection Method	5-2
5.2. WiFi Printing Operations.....	5-2
5.2.1. For Android Devices.....	5-2
5.2.2. For Apple IOS Devices.....	5-2

5. Mobile Print

5.1. WiFi Hotspot Connection Method

1. Turn on the power of the printer; if the indicator keeps on, the WiFi feature of the printer is enabled; if not, please refer to [Chapter 4 Operation Steps](#) to enable the WiFi feature.
2. Enable the wireless feature on the mobile device, and connect it with the WiFi hotspot of Pantum printer (the hotspot may display as Pantum-AP-XXXXXX).

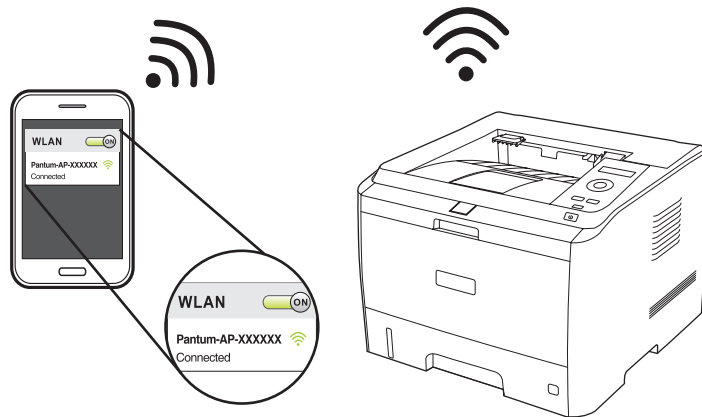

If there are more than one Pantum printers with WiFi feature, while selecting the printer hotspot, you may firstly print the Network Configuration Information Page report through the control panel to check the SSID hotspot names in it, so that you can connect the mobile device to the corresponding hotspot signal.

5.2. WiFi Printing Operations

5.2.1. For Android Devices

Print through the Mopria plug-in.

1. For Android mobile devices, download and install the Mopria Print Services plug-in through App Stores like Google Play.
2. Open the document to be printed or use the third party software programs to open it on the mobile device and print it. For instance, use WPS for printing.

5.2.2. For Apple IOS Devices

Print through Airprint

1. Select the file you need to print (for example, the folder of "Photos").
2. Click on "Photos" icon (as is shown below) to open the folder of "Photos".



3. Select photos you need to print, the following interface pops up:

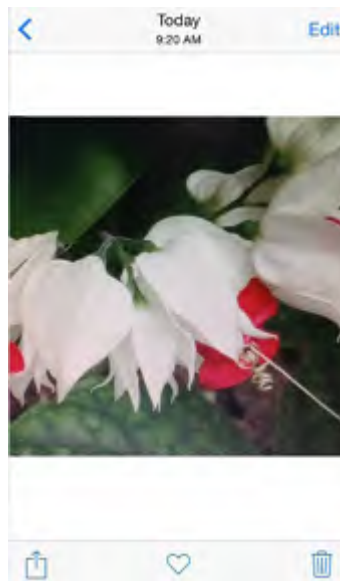

4. Click the "" icon on the bottom left corner, the following interface pops up:



5. Click "Print" on the bottom left corner, the following interface pops up:



6. Click "Select Printer" to select the corresponding printer.



7. Select the number of copies.

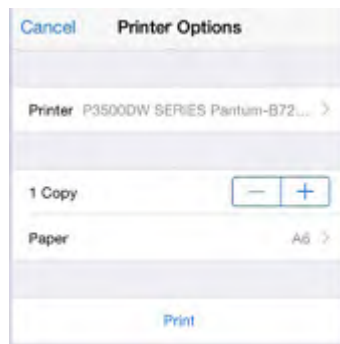

8. Click "Print" to start printing.

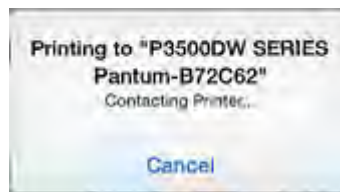

System Settings

6

Chapter

6. System Settings.....	6-2
6.1. Language Setting.....	6-2
6.2. Sleep Time Setting.....	6-2
6.3. Toner Save Setting	6-3
6.4. Restore Factory Settings	6-5

6. System Settings

This Chapter mainly introduces some general settings.

6.1. Language Setting

"Language Setting" is used to select the language to be displayed on the control panel. The default language is Chinese.

- 1) Press "Menu" to enter the Menu Settings interface.
- 2) Press "OK" to select the "1.System Setting" option.
- 3) Press "OK" to select the "1.Language Set" option, as shown below:

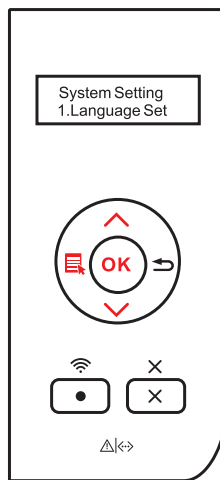

6.2. Sleep Time Setting

Set the Sleep Time Mode can lower the power consumption. "Sleep time Set" allows users to select the idle time before the device enter into Sleep Mode.

- 1) Press "Menu" to enter the Menu Settings interface.
- 2) Press "OK" to select the "1.System Setting" option.
- 3) Press direction key "▲" or "▼" to select the "2.Sleep time Set" option and press "OK".

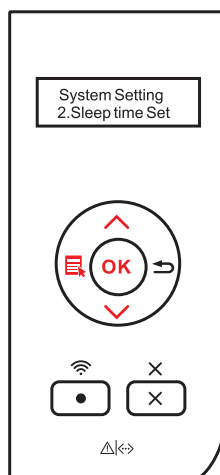

4) Press direction key "▲" or "▼" to select "1min", "5min", "15min", "30min", "60min", or "8hrs".



Note: • Pressing any button or sending any print job will wake it up when the printer is in Sleep mode.

6.3. Toner Save Setting

Users can select Toner Save Setting to lower the cost of printing. When the Toner Save mode is "On", the output color of the print will be lighter. The Default Setting is "Off".

- 1) Press "Menu" to enter the Menu Settings interface.
- 2) Press "OK" to select the "1.System Setting" option.

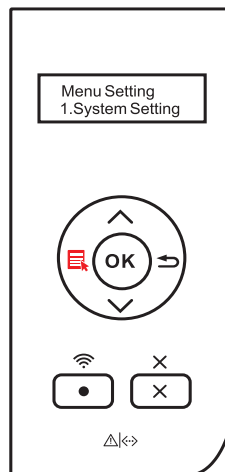

- 3) Press direction key "▲" or "▼" to select the "3.Toner Save" option and press "OK".

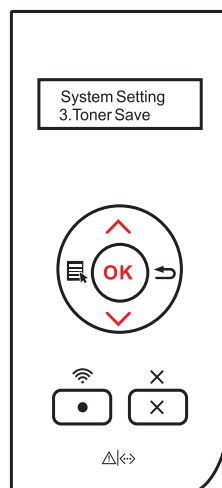

4) Press direction key "▲" or "▼" to select the "1.Turn Off" option and press "OK". When symbol "*" appears after "1.Close", it indicates that the toner save setting is off; or press direction key "▲" or "▼" to select the "2.Open" option and press "OK". When symbol "*" appears after selecting the "2.Open" option, it indicates that the toner save setting is on.



5) Press "Menu" to exit the menu interface, or select "Back" which is the last item of each menu, and press "OK" to exit the menu interface step by step.

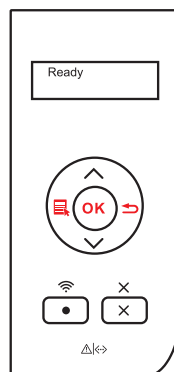

The Second Method:

Click "Printing Preferences" and then the "Layout" button on the top left to enter the following interface, and then select the "Toner Save" mode, under which the output color of the print will be lighter.

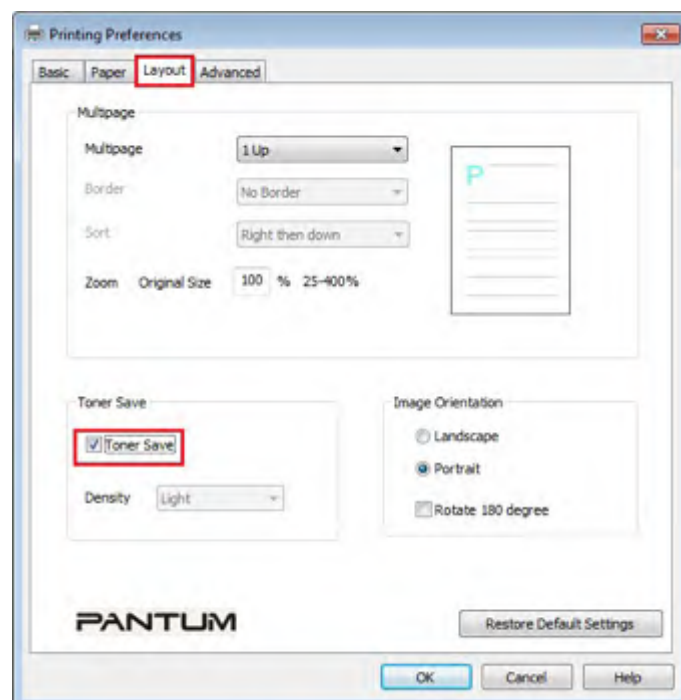

6.4. Restore Factory Settings

"Restore Factory Settings" is used to restore the default settings of the printer.

- 1) Press "Menu" to enter the Menu Settings interface.
- 2) Press "OK" to select the "1.System Setting" option.

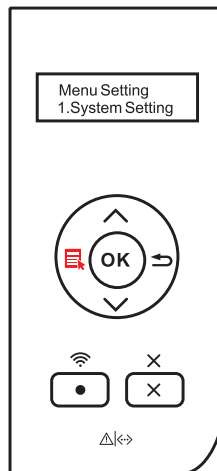

- 3) Press direction key "▲" or "▼" to select the "4.Restore Set" option and press "OK".

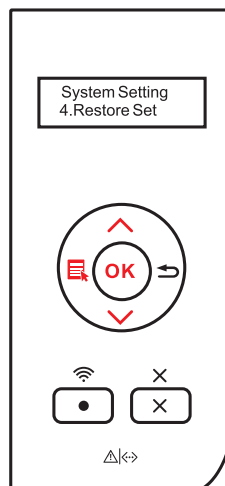

Print

7







Chapter

7. Print	7-2
7.1. Print Function.....	7-2
7.2. Tray Setup	7-3
7.2.1. Tray Dial Settings.....	7-3
7.2.2. Tray Settings through Control Panel	7-4
7.3. Open Help Document	7-5
7.4. Printing Mode.....	7-5
7.4.1. Printing with Standard Input Tray.....	7-6
7.4.2. Printing with Multipurpose Input Tray.....	7-6
7.4.3. Printing with Optional Tray	7-7
7.5. Automatic Duplex Print	7-9

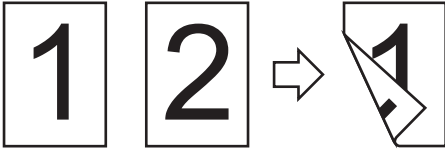
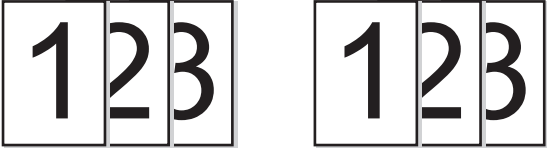
7. Print

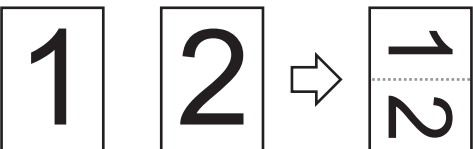
7.1. Print Function

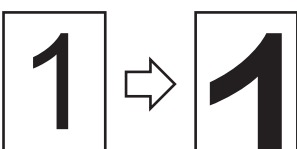
The following print functions can be achieved through the settings of various properties in the Printing Preferences.

Functions	Diagram
Automatic Duplex Print	
Collate Print	
Reverse Print	
N-in-1	
Poster Print (For Windows system only)	
Zoom Print	
Custom Size	



Note:

- You can select the 2 x 2 Poster Print in N-in-1 to enable the poster printing function.
- You can open the Printing Preferences and click Help to view the specific function explanation. For information about how to open the Help document, see [Chapter 7](#).

7.2. Tray Setup

7.2.1. Tray Dial Settings

Both the standard input tray and the optional tray have paper type dials, and we will take the standard tray as an example to illustrate the settings below.



Note: • Users can set the paper type dial according to their specific needs so that the paper is fed from the specific tray. Users can also choose not to set and adjust to the position of "*", providing no limitation on the tray and the paper type.

Dial Support Sizes: *, B5, STA, LGL, LTR, A4, and A5

1) Completely draw out the standard input tray from the printer.

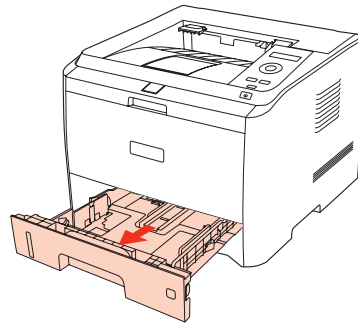

2) Adjust the dial to make its size the same as that of the paper in the tray.

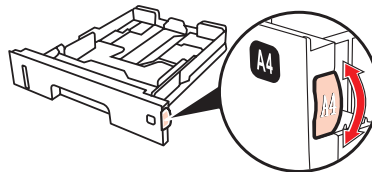

3) Put the tray back into the printer.

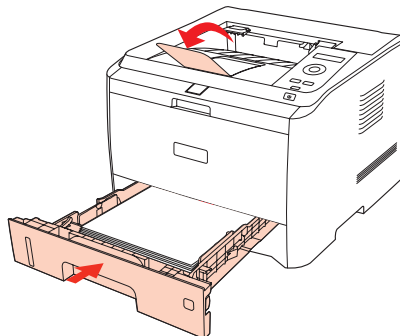

Note: • If the paper sizes users need to set is not shown on the dial, please set it on the control panel of the printer. Refer to [Chapter 7](#).

7.2.2. Tray Settings through Control Panel



Note: • Users can perform the paper size settings on the control panel for the standard tray, the multipurpose tray and the optional tray. Here we take the standard input tray as an example.

- 1) Press "Menu" to enter the Menu Settings interface.
- 2) Press direction key "▲" or "▼" to select the "2.Tray Setup" option and press "OK".

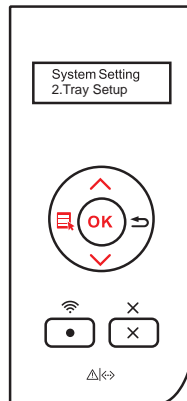

- 3) Press direction key "▲" or "▼" to select the "2.Standard Tray" option and press "OK".

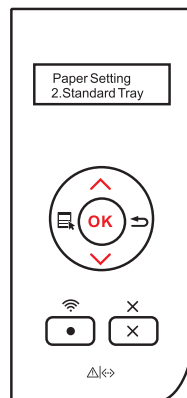

- 4) Press direction key "▲" or "▼" to select the "2.Paper size" option to make the settings.

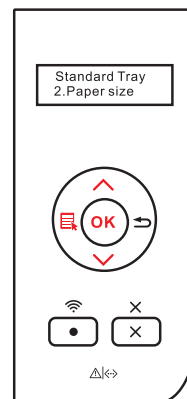

7.3. Open Help Document

You can open the "Printing Preferences" and click the "Help" button (for Windows system only). The Help document contains the User Guide where you can find the information on print settings.

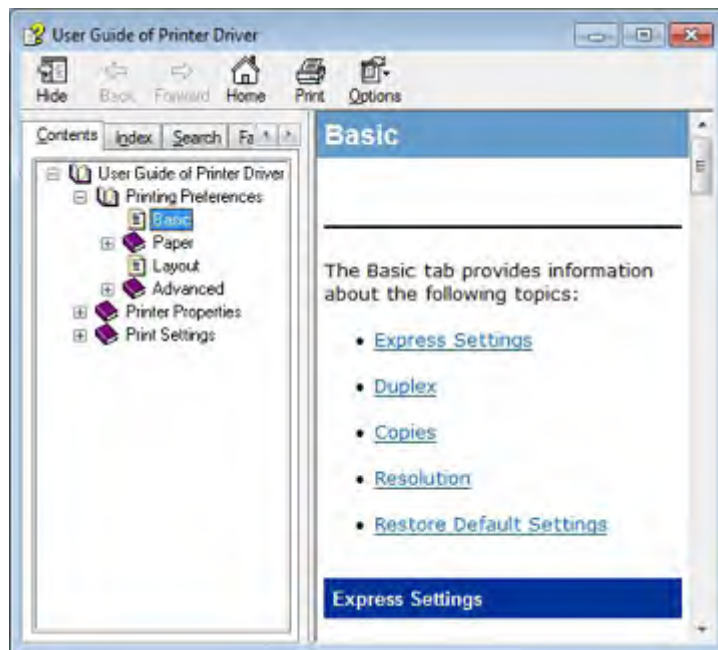
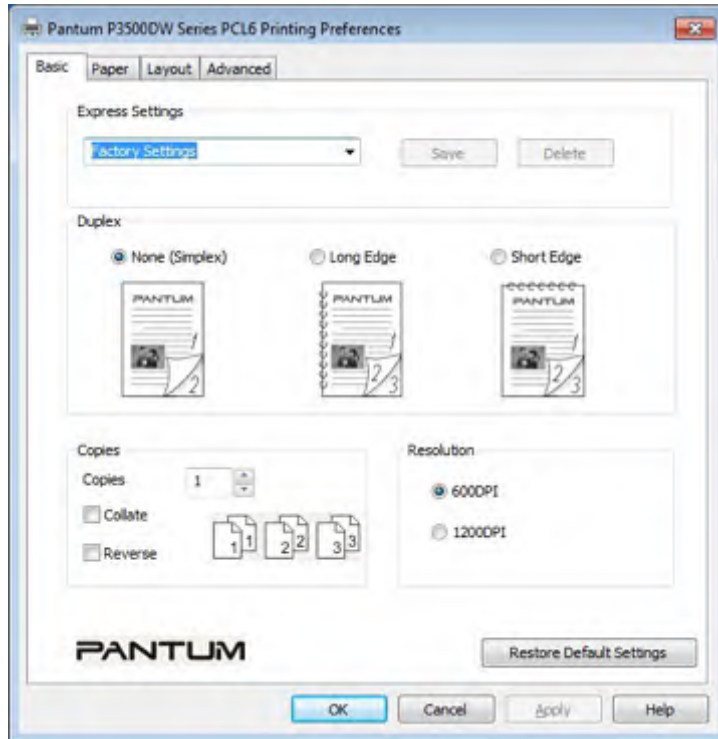

7.4. Printing Mode

This printer can perform the printing operation with the standard input tray, the multipurpose input tray and the optional tray. If there is any print media in the multipurpose input tray, the printer will firstly print with them. The priority order of this printer is: multipurpose input tray > standard input tray > optional tray.

7.4.1. Printing with Standard Input Tray

Ensure that certain amount of media is loaded into the standard input tray before printing.

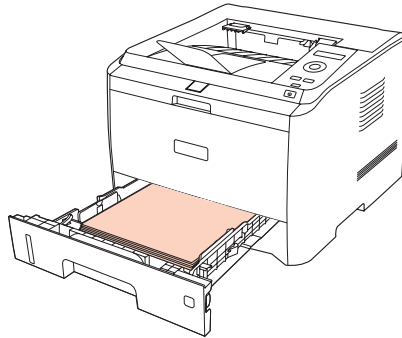

Note: • For precautions on loading paper, see [Chapter 2](#).

7.4.2. Printing with Multipurpose Input Tray

When loading paper into the multipurpose input tray, the printer will automatically print with the paper in the multipurpose input tray.

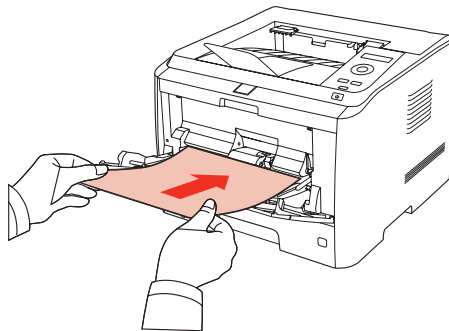

Note: • The multipurpose input tray can be used for printing special paper, such as envelopes, transparencies, etc., and 60 pages can be loaded each time at maximum.
• For loading paper into the multipurpose input tray, see [Chapter 2](#).

7.4.3. Printing with Optional Tray

7.4.3.1. Installation of Optional Tray

1. Please ensure the correct placement of the printer and the optional trays, as shown below.

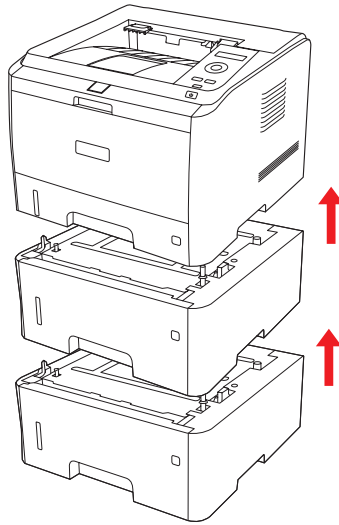

2. Plug the power cord into the printer to turn on the power.

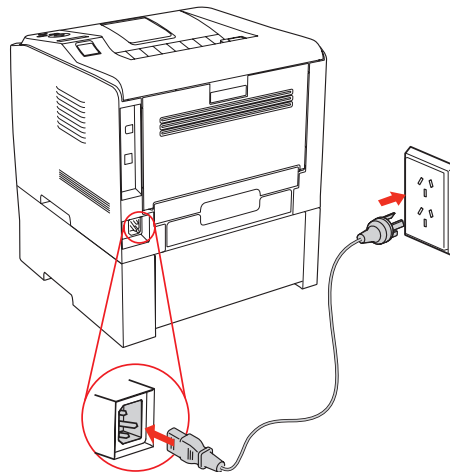

-
- Note:**
- Please cut off the power supply of the printer when install or remove the optional tray.
 - After the installation of the optional tray, please do not lift the printer up during the printing process, or else, the communication with the optional tray will fail. Users will need to restart the printer to restore in this case.
-

3. Open "Printer Properties" on the Device and Printer interface of the operating system, and click "Secondary Settings", select "Installed" in the "Installable Options" to complete the installation of the optional tray, as shown in the figure.

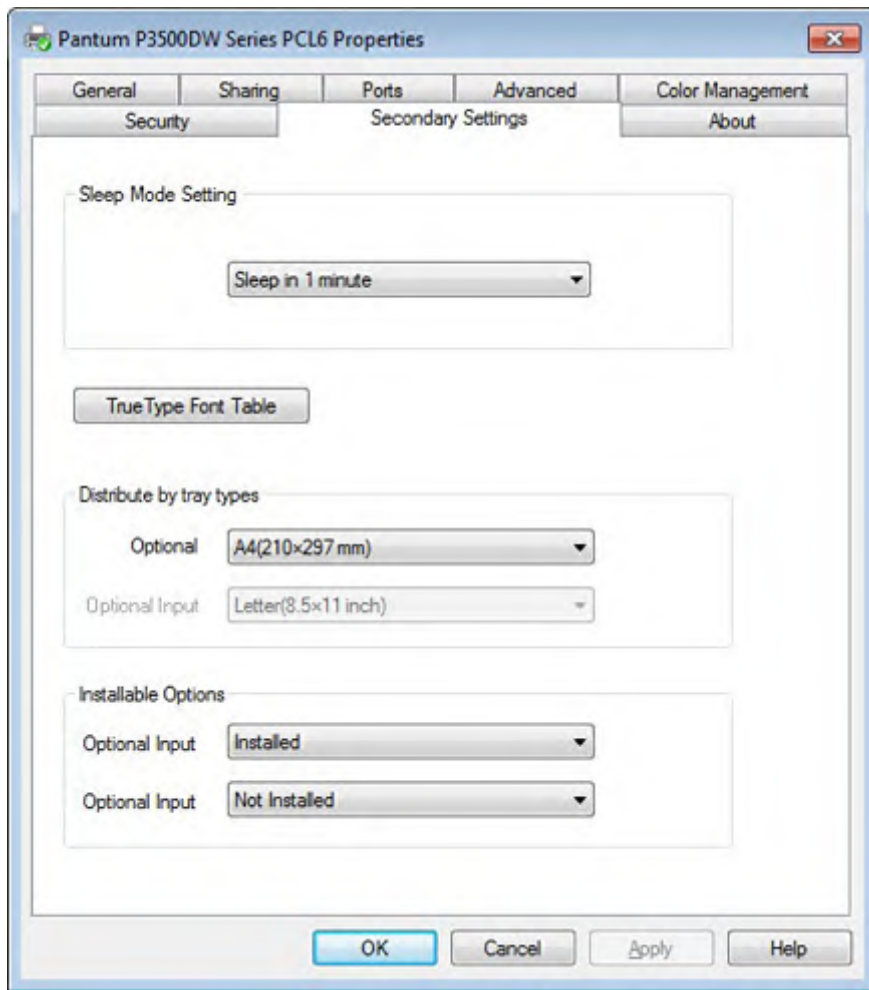

4. When there is no paper in the multipurpose input tray and the standard input tray, or the paper source is set as "Optional Tray I/II" by users, the printer will get paper from the optional tray to finish the print job.

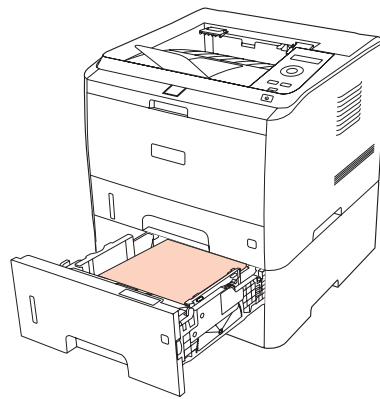

- Note:**
- The optional tray can be loaded with 550 pages of plain paper (80 g/m²) at maximum.
 - Please make sure the proper installation of the optional tray with the printer.

7.4.3.2. Removing the Optional Tray

1. Press and hold the power button of the printer to turn off the power.
2. Lift the printer up with two hands to remove the optional tray.



Note: • Make sure the power of the printer is turned off when removing the optional tray.

7.5. Automatic Duplex Print

1. The printer driver supports automatic duplex print with plain paper. Paper size supported by the automatic duplex print: A4/LETTER, LEGAL, OFICIO, and FOLIO.



- Note:**
- If the paper is thin, it may wrinkle.
 - If the paper is curled, make it flat and put it back into the automatic input tray.
 - Trying the automatic duplex print may damage the printer if some paper media are not suitable for automatic duplex print.
 - If the paper loaded into the standard input tray at one time exceed 250 pages, paper will jam or cannot be fed in.
 - Automatic duplex print does not support poster printing.
 - For loading paper, and the type of media to be printed with the standard input tray, see [Chapter 2](#). It is recommended to use the standard paper.
 - For information about how to deal with paper jams, see [Chapter 9](#).

2. This printer supports the automatic duplex print with the standard input tray, the multipurpose input tray and the optional tray.

- 1) Automatic duplex print with the standard input tray.

Ensure that certain amount of media is loaded into the standard input tray before printing.

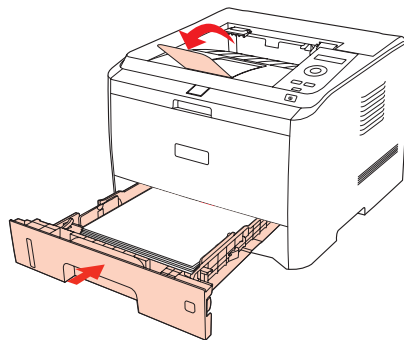

- 2) Automatic duplex print with the multipurpose input tray.

Feed paper from the multipurpose input tray for automatic duplex print.

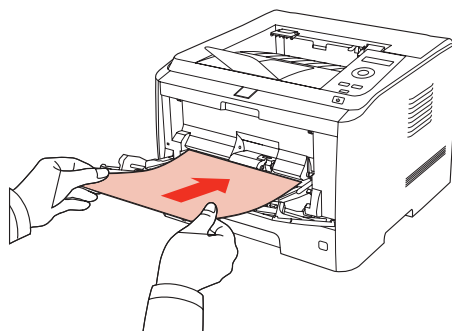

When you put paper in the multipurpose input tray, the printer will give priority to use the print paper in the multipurpose input tray.



-
- Note:**
- The multipurpose input tray can achieve automatic duplex print, but it can be loaded with 60 pages at maximum, and the recommended types of print paper should be used.
 - The multipurpose input tray supports multipurpose duplex printing with plain paper.
-

3) Automatic duplex print with the optional tray.

Before printing, ensure that certain amount of media is loaded into the optional tray, and there is no media in the standard and multipurpose input tray; or users can set the optional tray as paper source.

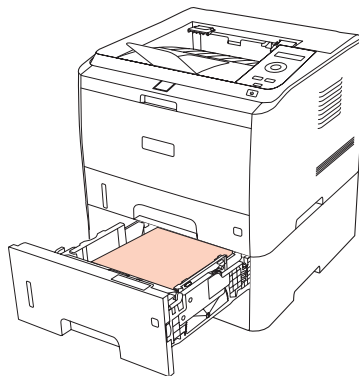

-
- Note:**
- The optional tray only supports the automatic duplex print with plain paper, so please do not load special print media.
-

Automatic duplex print steps are as follows (for Windows system only)

1. Open the print job to be printed from the application (such as Notepad).
2. Select Print from the File menu.

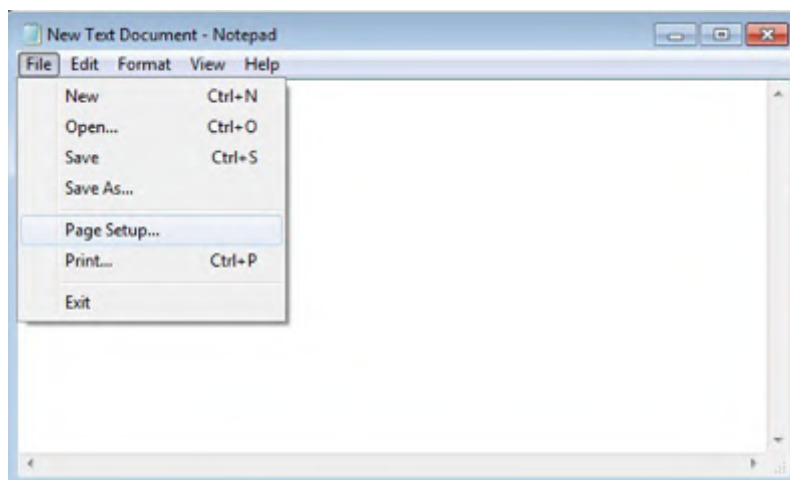

3. Select Pantum printer with the appropriate model.

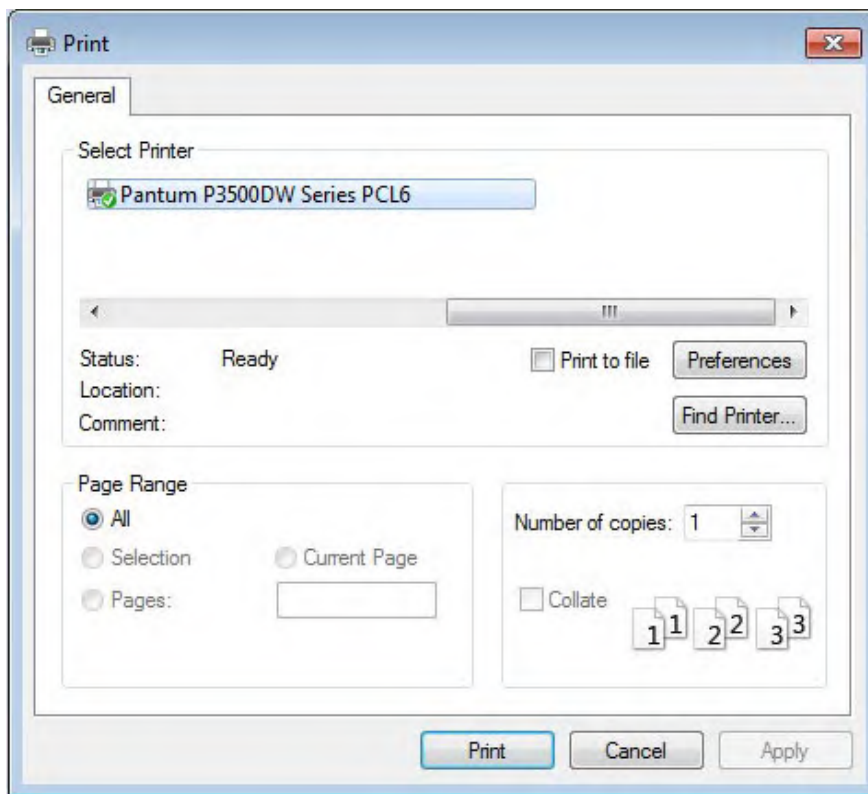

4. Click Preferences or Properties button for the configuration of printing.

5. Select Basic tab in the Duplex Printing area, and select Long Edge or Short Edge as the binding method.

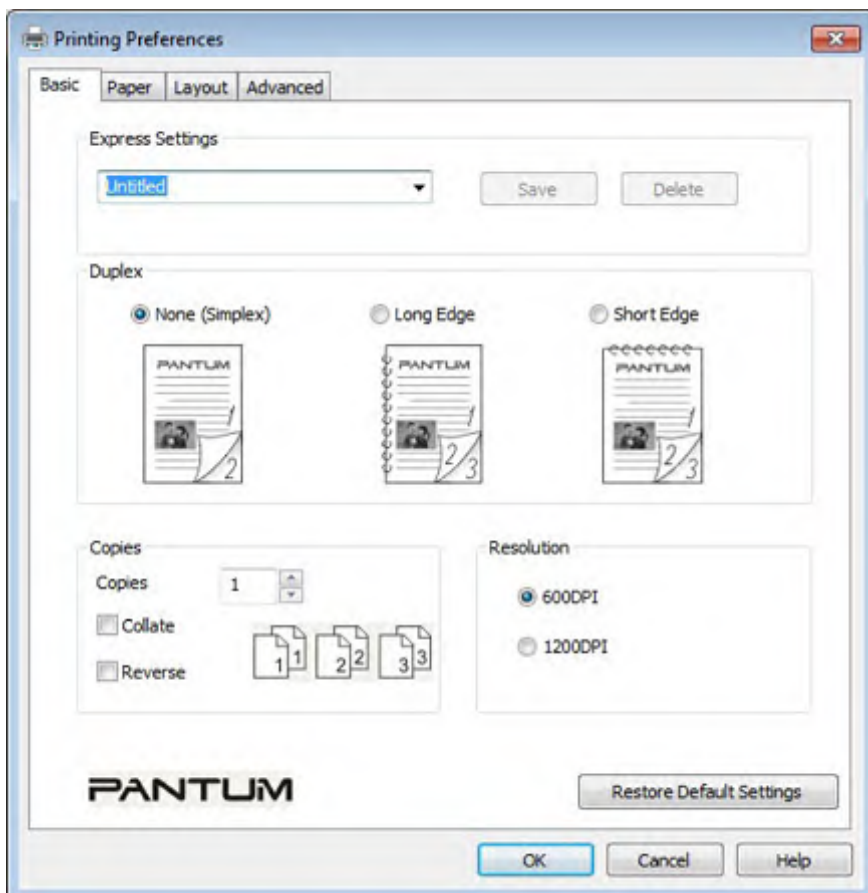

6. Click OK to complete the print settings, so as to achieve the automatic duplex print.

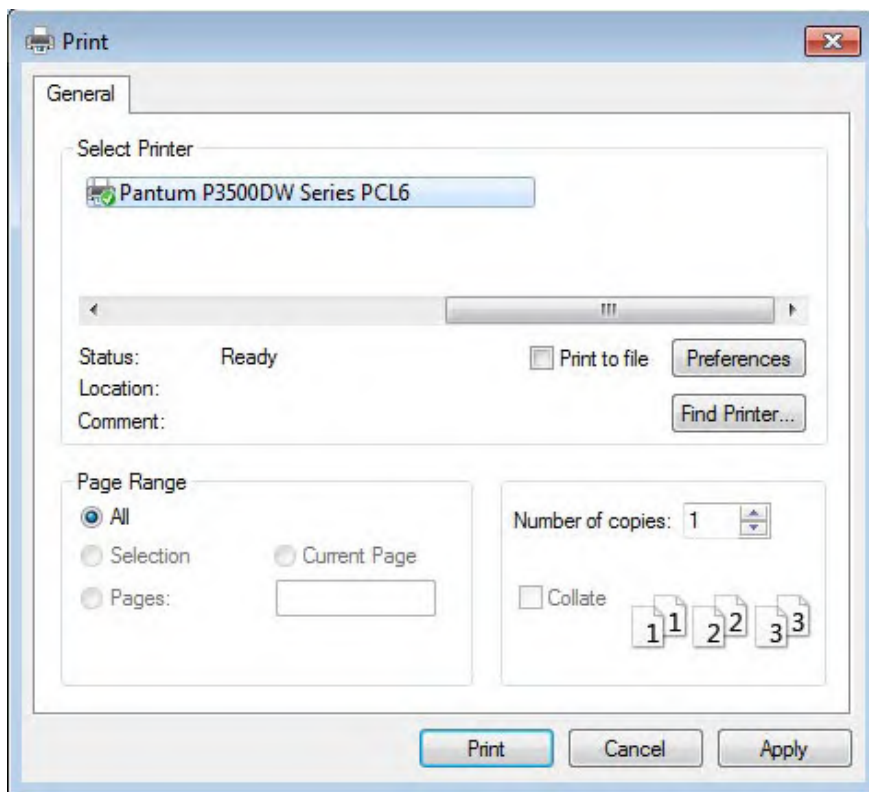

-
- Note:**
- It is recommended to raise the paper platform to prevent the printed paper from sliding out of the output tray. If you choose not to raise the paper platform of the output tray, we recommend that you immediately remove the printed paper output from the printer.
 - During the printing process, the printer will automatically adjust the direction of the text of the page.
-

Routine Maintenance

8

Chapter

8. Routine Maintenance.....	8-2
8.1. Cleaning the Printer	8-2
8.2. Maintenance of Laser Toner Cartridge	8-3
8.2.1. About Laser Toner Cartridge	8-3
8.2.2. Replace Laser Toner Cartridge	8-4

8. Routine Maintenance

8.1. Cleaning the Printer



- Note:**
- Please use mild detergents.
 - Some parts of the printer are still hot within a short time after using. When opening the front cover or rear cover to clean the parts inside the printer, please do not touch the parts in the shaded area as shown in the following figure.

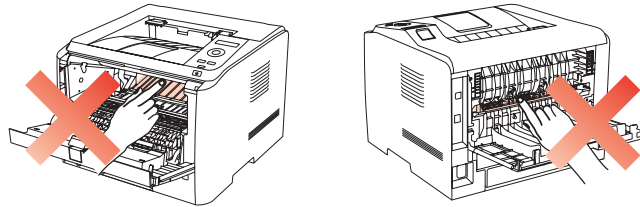

1. Use a soft cloth to wipe the outside of the printer clean.

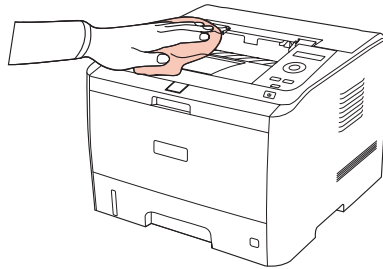

2. Open the front cover to take out the laser toner cartridge.

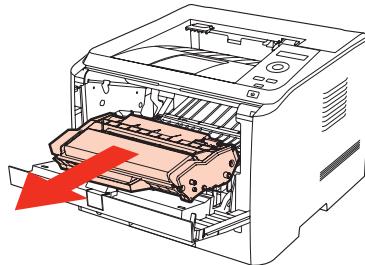

- Note:**
- When removing the laser toner cartridge, put the cartridge in a protective bag or wrap it with thick paper to avoid direct light damaging the photosensitive drum.

3. Clean the inside of the printer by using a dry and lint-free cloth to gently wipe the shaded area as shown in the figure below.

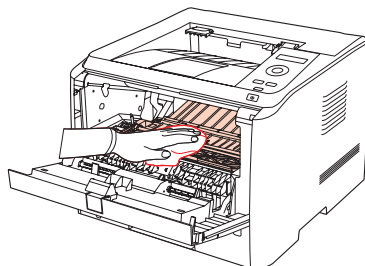

8.2. Maintenance of Laser Toner Cartridge

8.2.1. About Laser Toner Cartridge

1. Use and Maintenance of Laser Toner Cartridge

For better print quality, please use the original Pantum laser toner cartridge.

When using the laser toner cartridge, please pay attention to the following:

- Unless you want to use it immediately, otherwise, do not remove the laser toner cartridge from the package.
- Do not refill the laser toner cartridge without authorization. Otherwise, the resulting damage is not included in the printer warranty.
- Please store the laser toner cartridge under a cool and dry environment.
- Toner inside the laser toner cartridge is combustible. Please do not put the laser toner cartridge near any source of ignition, so as to avoid causing a fire.
- When removing or disassembling the laser toner cartridge, please pay attention to the toner leakage problem. In case of the toner leakage resulting in that the toner contacts with your skin or splashes into your eyes and mouth, please immediately wash with clear water, and consult a doctor immediately if you feel unwell.
- When placing the laser toner cartridge, please keep it away from the area reachable by children.

2. Service Life of the Laser Toner Cartridge

Service life of the laser toner cartridge depends on the amount of toner that print jobs require.

When the printer's LED indicator shows the status in the following figure or the LCD display shows "Ctg life expired", it indicates that the laser toner cartridge life has expired and needs to be replaced.

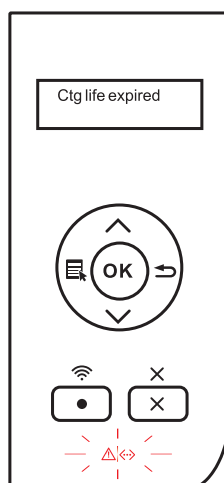

8.2.2. Replace Laser Toner Cartridge



- Note:** Before replacing the laser toner cartridge, please pay attention to the following:
- The laser toner cartridge surface may have toner. Please remove it carefully to avoid spilling.
 - Put the removed laser toner cartridge on a piece of paper to avoid the toner from accidentally spilling.
 - After removing the protective cover, please immediately install the laser toner cartridge into the printer, so as to avoid photosensitive drum damage caused by exposing to too much direct sunlight or indoor light.
 - When installing the laser toner cartridge, do not touch the surface of the photosensitive drum so as not to scratch it.

The steps of replacing the laser toner cartridge are shown below:

1. Turn off the printer.

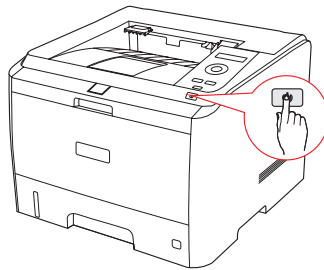

2. Open the front cover, and remove the empty laser toner cartridge along the guides.

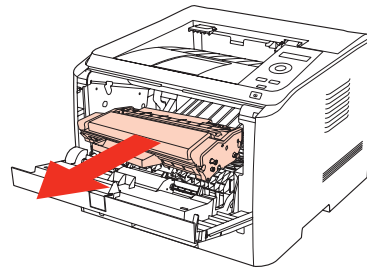

3. Open the package of a new laser toner cartridge, hold the handle of the cartridge and gently shake around 5-6 times, so as to make the toner evenly distributed inside the cartridge.

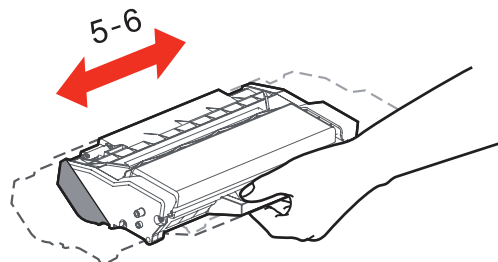

4. Remove the protective cover, and put the laser toner cartridge into the printer along the guides, and close the cover tightly.

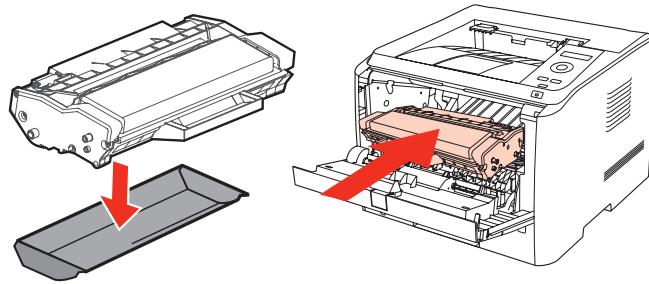

Note: • Check whether there is any seal before installing the toner cartridge into the printer; if there is any, please tear off the seal and then install the cartridge.

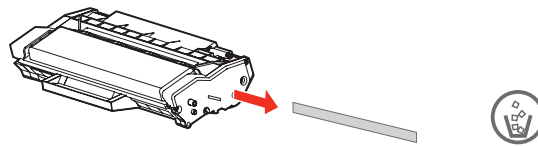

5. Restart the printer to print a test page.

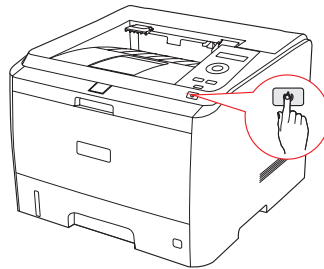

Troubleshooting

9

Chapter

9. Troubleshooting	9-2
9.1. Clearing Jammed Paper	9-2
9.1.1. Paper Jam in the Tray	9-2
9.1.2. Paper Jam in the Manual Input Tray	9-3
9.1.3. Paper Jam in the Optional Tray	9-4
9.1.4. Internal Paper Jam.....	9-5
9.1.5. Paper Jam in the Fuser Unit	9-6
9.1.6. Duplex Unit Jam.....	9-7
9.2. Software Failure	9-8
9.3. Common Trouble Shooting	9-8
9.3.1. Common Trouble	9-8
9.3.2. Image Defects	9-10

9. Troubleshooting

Please read this section carefully. It can help you solve common malfunctions in the printing process. If the problems appeared cannot be solved, please timely contact Pantum After-sales Service Center.

Prior to handling common malfunctions, firstly check the following situations:

- Whether the power cord is connected correctly and the printer is powered on.
- Whether all the protective parts are removed.
- Whether the laser toner cartridge is correctly installed.
- Whether the output bin is fully closed.
- Whether the paper is correctly loaded into the tray.
- Whether the interface cable is correctly connected between the printer and the computer.
- Whether the correct printer driver is selected and installed properly.
- Whether the computer port is properly configured and is connected to the proper printer port.

9.1. Clearing Jammed Paper



-
- Note:**
- Remove the jammed paper in accordance with the following steps, close the front cover and tidy the paper in the tray, then the printer will automatically resume printing. If the printer cannot automatically start printing, please press the button on the control panel.
 - If the printer still does not start printing, please check whether all the jammed paper inside the printer are cleared.
 - If you cannot remove the jammed paper yourself, please contact your local Pantum Authorized Repair Center or send the printer to the nearest Pantum Authorized Service Center for repair.
-

9.1.1. Paper Jam in the Tray

1. Open the tray.

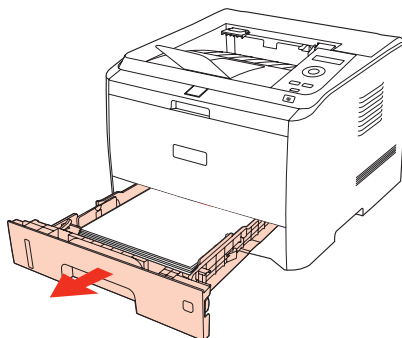

2. Gently draw the jammed paper straight out.

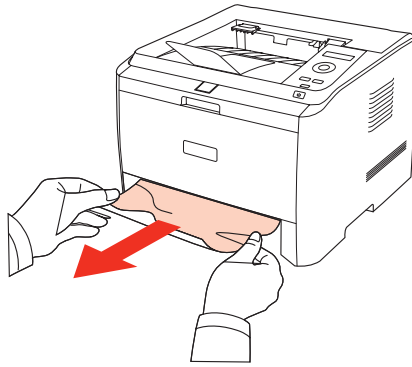

3. After removing the jammed paper, reload the tray into the printer, then the printer will automatically resume printing.

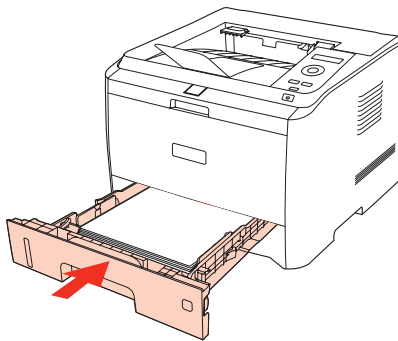

9.1.2. Paper Jam in the Manual Input Tray

1. Gently draw the jammed paper out.

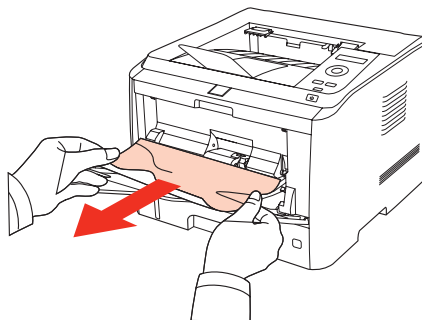

2. After removing the jammed paper, reload the tray, then the printer will automatically resume printing.

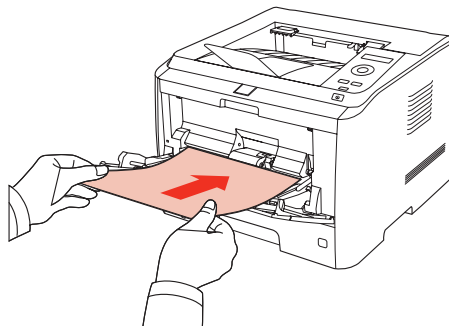

9.1.3. Paper Jam in the Optional Tray

If the paper is jammed in the optional tray, please operate according to the following steps based on the prompts on the LCD display of the control panel to remove the jammed paper.

1. Draw out the drawer of the optional tray.

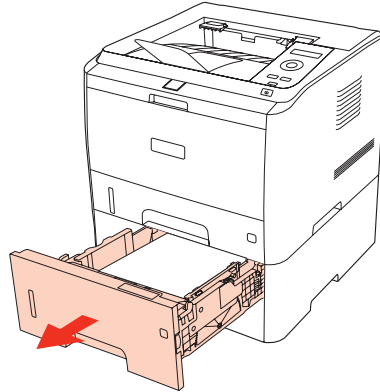

2. Gently draw the jammed paper straight out.

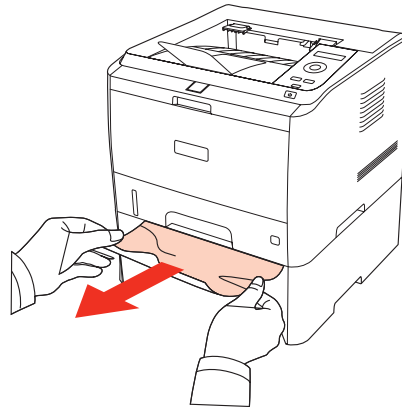

3. After removing the jammed paper, reload the tray into the printer, then the printer will automatically resume printing.

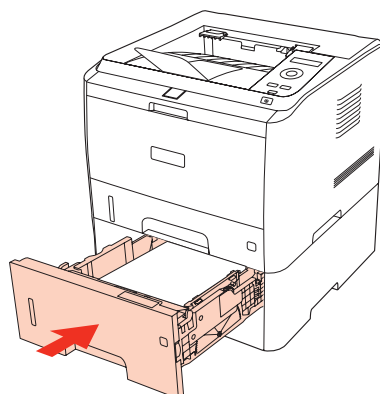

If no paper can be seen in this area, please stop and go to the next step:

1. Open the Standard Input Tray.

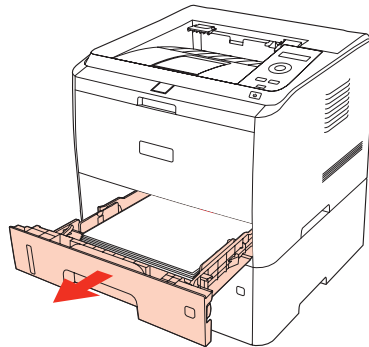

2. Remove the jammed paper from the standard input tray.

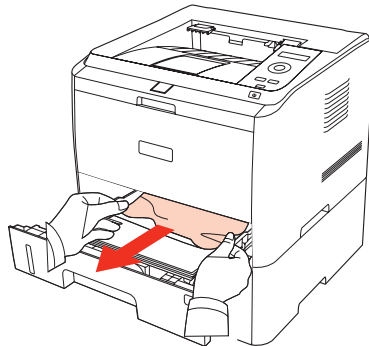

3. Put the tray back into the printer after removing the jammed paper.

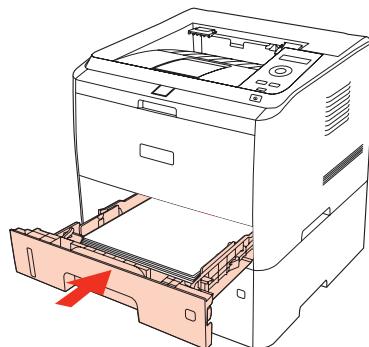

9.1.4. Internal Paper Jam



Note: • Do not touch the shaded area as follows to avoid burns when removing the internal jammed paper and the jammed paper in the fuser unit.

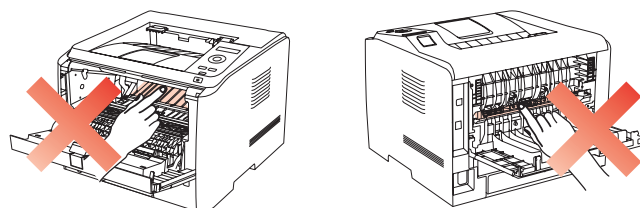

1. Open the front cover.

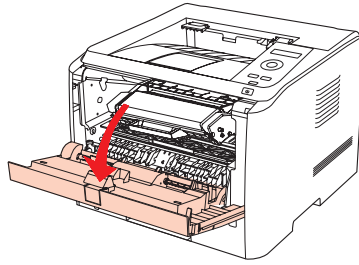

2. Straightly draw out the laser toner cartridge. (To avoid the exposure of the cartridge affecting the print quality, wrap the laser toner cartridge with a black plastic bag or cover it with paper).

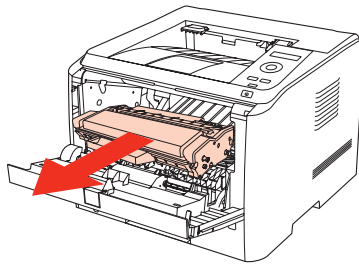

3. Gently draw the jammed paper straight out.

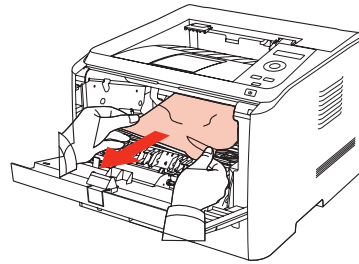

4. After removing the jammed paper, reload the laser toner cartridge and close the front cover, then the printer will automatically resume printing.

9.1.5. Paper Jam in the Fuser Unit

1. Open the rear cover.

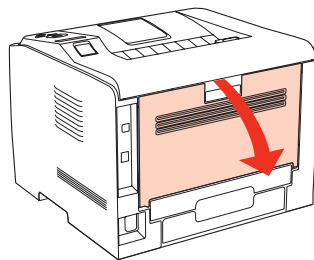

2. Open the fuser release unit by the handles on both sides.

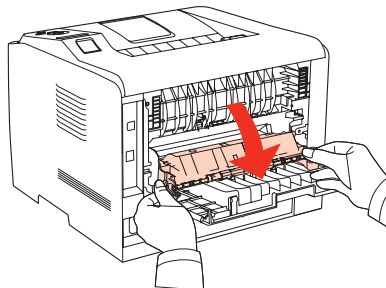

3. Gently draw the jammed paper out.

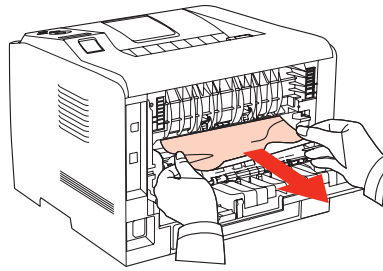

4. Remove the jammed paper and close the fuser decompression unit and the rear cover, then the printer will automatically resume printing.

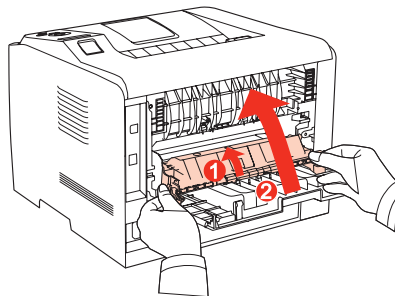

9.1.6. Duplex Unit Jam

1. Remove the duplex printing unit from the back of the printer.

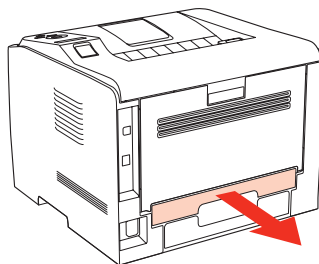

2. Remove the jammed paper from the duplex unit.

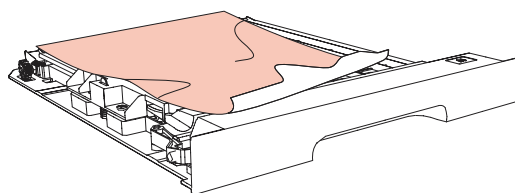

3. If the paper does not come out together with the duplex unit, open the tray and remove the jammed paper directly from the bottom.

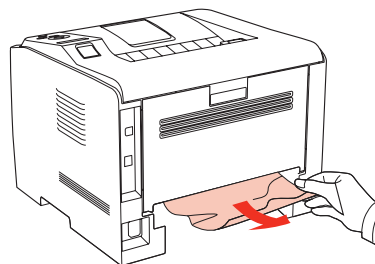

4. After removing the jammed paper, reload the duplex unit, check other parts of the printer, ensure that there is no jammed paper, and close the front cover, then the printer will automatically resume printing.

9.2. Software Failure

Trouble	Solution
Pantum 3500 Series Printer Driver cannot be found in the printer and fax folders.	Reinstall the printer driver. Ensure that the USB interface cable and the power cord are both properly connected.
The printer is in Ready mode but does not perform any print job.	If the failure still exists after restarting the printer, please reinstall the printer driver. Ensure that the USB interface cable is properly connected.
Failed to install the driver.	Check whether the Print Spooler service is enabled. Check the power supply and the connection of the printer.
The driver is not available after the IP address of the printer is changed.	Modify the IP address of the printer driver port. Please reinstall the printer program if the above method does not work. It is recommended to set the IP address of the network printer as a fixed one. It is recommended to bind the IP address with the printer Mac address in the DHCP network.

9.3. Common Trouble Shooting

9.3.1. Common Trouble



Trouble	Cause	Solution
Printer Problems		
The printer does not work	The cable between the computer and the printer is not connected properly. Error in specifying the print port. The printer is offline, and Use Printer Offline is checked. The printer does not recover from an internal error, such as a paper jam, paper empty, etc.	Disconnect and then reconnect the printer cable. Check the Windows printer settings to ensure that the print job is sent to the correct port. If the computer has more than one port, make sure that the printer is connected to the correct port. Make sure that the printer is in the normal online status.
Problems in Handling Paper		
Paper Feed Failure	The print media is loaded incorrectly. The print media is beyond the usage specification range. The feed roller is dirty.	Please correctly load the print media. If you use special print media for printing, please print with the multipurpose input tray. Please use the print media within the specification range. Clean the feed roller.

Trouble	Cause	Solution
Paper Jam	<p>There is too much paper in the tray.</p> <p>The print media is beyond the usage specification range.</p> <p>There is foreign matter in the feed channel.</p> <p>The feed roller is dirty.</p> <p>Internal parts failure.</p>	<p>Remove excess paper from the tray.</p> <p>If you print on special print media, please use the multipurpose input tray.</p> <p>Make sure to use the paper that meets specifications. If you print on special print media, please use the multipurpose input tray.</p> <p>Clean the feed channel.</p> <p>Clean the feed roller.</p>
Print with Multi-page Fed Paper	<p>Excessive static electricity on the print media.</p> <p>The print media is damp or sticks together.</p> <p>Internal parts failure.</p>	<p>Separate the print media to eliminate some static electricity.</p> <p>It is suggested that you use the recommended print media.</p> <p>Separate the print media or use better and dry print media.</p>



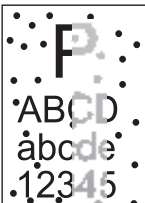

Note: • If the problem remains, please contact Pantum Customer Service.

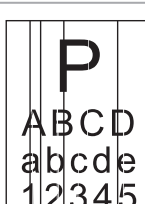
9.3.2. Image Defects

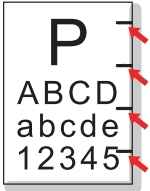
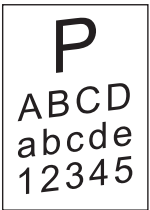
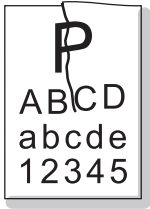
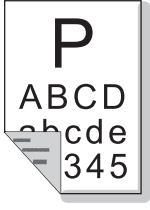
Trouble	Cause	Solution
 <p>The printout is whitish or light</p>	<ul style="list-style-type: none"> • Toner is low. • The print media does not meet usage specifications, such as the media is damp or too rough. • The resolution in the print program is set too low, the Density setting is too low, or the toner save mode is ticked. • The laser toner cartridge is damaged. 	<ul style="list-style-type: none"> • Please properly use the print media within the specification range. • Set the print resolution, density, or cancel the ticked toner save mode in the program.
 <p>Toner spots</p>	<ul style="list-style-type: none"> • The laser toner cartridge is dirty or leaks toner. • The laser toner cartridge is damaged. • The print media that does not meet usage specifications, such as the media is damp or too rough, has been used. • The feed channel is dirty. 	<ul style="list-style-type: none"> • Please use the print media within the specification range. • Clean the feed channel. • We recommend that you replace the toner cartridge and use an original one.
 <p>White spots</p>	<ul style="list-style-type: none"> • The print media that does not meet usage specifications, such as the media is damp or too rough, has been used. • The feed channel is dirty. • The internal part of the laser toner cartridge is damaged. • The reflective glass of the laser inside the printer is dirty. 	<ul style="list-style-type: none"> • Please use the print media within the specification range. • Clean the feed channel. • Clean the reflective glass of the laser.
 <p>Toner comes off</p>	<ul style="list-style-type: none"> • The print media that does not meet usage specifications, such as the media is damp or too rough, has been used. • The inside of the printer is dirty. • The laser toner cartridge is damaged. • The internal part of the printer is damaged. 	<ul style="list-style-type: none"> • Please use the print media within the specification range. • Clean the inside of the printer. • We recommend that you replace the toner cartridge and use an original one.
 <p>Black vertical stripes</p>	<ul style="list-style-type: none"> • The laser toner cartridge is dirty. • The internal part of the laser toner cartridge is damaged. • The reflective glass of the laser inside the printer is dirty. • The feed channel is dirty. 	<ul style="list-style-type: none"> • Clean the reflective glass of the laser at the back of the printer. • Clean the feed channel at the back of the printer.

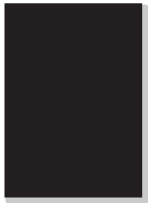
Trouble	Cause	Solution
 <p>Black background (gray background)</p>	<ul style="list-style-type: none"> • The print media that does not meet usage specifications, such as the media is damp or too rough, has been used. • The laser toner cartridge is dirty. • The internal part of the laser toner cartridge is damaged. • The feed channel is dirty. • The transfer voltage inside the printer is abnormal. 	<ul style="list-style-type: none"> • Please use the print media within the specification range. • Clean the feed channel inside the printer.
 <p>Cyclical traces appear</p>	<ul style="list-style-type: none"> • The laser toner cartridge is dirty. • The internal part of the laser toner cartridge is damaged. • The fuser component is damaged. 	<ul style="list-style-type: none"> • Clean the laser toner cartridge or replace it with a new one. • Please contact Pantum Customer Service to repair or replace the fuser component.
 <p>Skewed pages</p>	<ul style="list-style-type: none"> • The print media is loaded incorrectly. • The feed channel of the printer is dirty. 	<ul style="list-style-type: none"> • Ensure correct loading of the print media. • Clean the feed channel inside the printer.
 <p>Wrinkled paper</p>	<ul style="list-style-type: none"> • The print media is loaded incorrectly. • The print media does not meet the usage specifications. • The feed channel inside the printer is dirty. • The fuser component of the printer is damaged. 	<ul style="list-style-type: none"> • Ensure correct loading of the print media. • Please use the print media within the specification range. • Clean the feed channel inside the printer.
 <p>Dirt on the back</p>	<ul style="list-style-type: none"> • The laser toner cartridge is dirty. • The transfer roller inside the printer is dirty. • The transfer voltage inside the printer is abnormal. 	<ul style="list-style-type: none"> • Clean the laser toner cartridge or replace it with a new one. • Clean the internal transfer components of the printer.

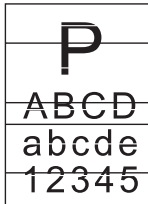
Trouble	Cause	Solution
 Whole page dark	<ul style="list-style-type: none"> • The laser toner cartridge is installed incorrectly. • The internal part of the laser toner cartridge is damaged. • Abnormal charge inside the printer; the laser toner cartridge is not charged. 	<ul style="list-style-type: none"> • Ensure to install the cartridge correctly. • We recommend that you replace the toner cartridge and use an original one.
 Toner smudges on paper	<ul style="list-style-type: none"> • The print media that does not meet usage specifications, such as the media is damp or too rough, has been used. • The inside of the printer is dirty. • The laser toner cartridge is damaged. • The internal part of the printer is damaged. 	<ul style="list-style-type: none"> • Please use the print media within the specification range. • Clean the inside of the printer.
 Horizontal stripes	<ul style="list-style-type: none"> • The laser toner cartridge is installed incorrectly. • The laser toner cartridge might be damaged. • The internal part of the printer is damaged. 	<ul style="list-style-type: none"> • Ensure to install the cartridge correctly.



Note: • The above troubles can be handled by cleaning or replacing the laser toner cartridge. If the problem remains, please contact Pantum Customer Service.

Company Name: Magnell Associate, Inc. (DBA NEWEGG.COM)
Office address: 16839 E. Gale Ave. , City of Industry, CA 91745
TEL: (626) 271-9700

PANTUM