

User's Manual

# In Room Full HD VideoWireless Kit

WHD100



WHD100 Receiver



WHD100 Transmitter

Please read the user manual and the quick installation guide so you can enjoy the product to the full extend.

# Table of Contents

|   |           |
|---|-----------|
| <b>TABLE OF CONTENTS</b> .....                            | <b>1</b>  |
| <b>1. IMPORTANT INFORMATION</b> .....                     | <b>2</b>  |
| <b>2. INTRODUCTION</b> .....                              | <b>7</b>  |
| <b>2.1 PACKING CONTENT</b> .....                          | <b>7</b>  |
| <b>2.2 OVERVIEW</b> .....                                 | <b>8</b>  |
| <b>2.2.1 TRANSMITTER</b> .....                            | <b>8</b>  |
| <b>2.2.2 RECEIVER</b> .....                               | <b>9</b>  |
| <b>3. INSTALLATION</b> .....                              | <b>10</b> |
| <b>STEP 1: SETUP THE TRANSMITTER</b> .....                | <b>10</b> |
| <b>STEP 2: SETUP THE RECEIVER</b> .....                   | <b>11</b> |
| <b>STEP 3: BOOT UP THE TRANSMITTER AND RECEIVER</b> ..... | <b>12</b> |
| <b>STEP 4: MOUNTING THE RECEIVER TO THE WALL</b> .....    | <b>16</b> |
| <b>4. TROUBLESHOOTING</b> .....                           | <b>17</b> |
| <b>5. SUPPORTED RESOLUTION</b> .....                      | <b>18</b> |
| <b>6. AUDIO BIT RATE SUPPORT</b> .....                    | <b>19</b> |
| <b>7. PRODUCT SPECIFICATION</b> .....                     | <b>20</b> |

# 1. Important Information



Please take the time to read this user manual before using the WHD100.

It contains important information about operating your video wireless kit.

Our company’s limited warranty applies when the product is handled properly for intended use, in accordance with its operating instruction. However, the warranty may be void in the following cases:

- Repair, product modification or alteration have been performed by unauthorized service personnel
- Damages caused by accidents, including but not limited to, lightning, water, fire, or moisture
- Use of an AC adapter not compatible with the product and its voltage rating
- The model number on the product has been altered, deleted, removed or made illegible.

## Safety Precautions

|   |  |   |
|---|--|---|
|    | <b>WARNING!</b><br>RISK OF<br>ELECTRICAL<br>SHOCK<br>DO NOT OPEN |  |
| <p><b>WARNING:</b><br/>TO REDUCE THE RISK OF ELECTRICAL SHOCK<br/>DO NOT REMOVE THE COVER<br/>NO USER-SERVICEABLE PARTS ARE INSIDE<br/>REFER SERVICING TO QUALIFIED<br/>PERSONNEL</p> |  |   |



**Danger:** Be careful with electricity.

- Power to the units must be switched off before any work is undertaken, such as any AV device connection or TV connection.
- **Power outlet:** To prevent electric shock,

make sure to use the appropriate AC adapters as power supply to the transmitter and the receiver.

- **Power cord:** Be sure the power cord is routed so that it will not be stepped on or pinched by heavy items.
- **Power overloading:** Avoid overloading electrical outlets or extension cords which otherwise could result in electric shock or fire.
- **Lightning:** Disconnect the product from the power source if it is left unattended for a long period of time, and to protect the product from lightning.
- Always disconnect the power cord from the power outlet when you are not using your Full HD Video wireless kit. This reduces the risk of electric shocks or fire.



### Warning

- This product should not be exposed to dripping or splashing. No object filled with liquids, such as vases, should be placed on the product.
- **Object Entry:** To avoid electric shock, never stick anything in the slots on the case or remove the cover.
- Place receiver/transmitter on a flat, hard and stable surface
- **Ventilation:** Do not block the ventilation slots on the receiver/transmitter or place any heavy object on the top cover. Blocking the air flow could damage the receiver. Arrange components so that air can flow freely around the receiver. Ensure that there is adequate ventilation if the receiver is placed in a stand. Put the receiver/transmitter in a property ventilated area, away from direct sunlight or any source of heat.
- **Water Exposure:** To reduce the risk of fire or electric shock, do not expose the receiver/transmitter to rain or moisture.
- **This is indoor solution.**
- **Our company has the right to modify this document without any notice.**

## DECLARATION OF CONFORMITY

This device complies with Part 15 of the FCC Rules. Operation is subject to the following two conditions:

- (1) This device may not cause harmful interference, and
- (2) This device must accept any interference received, including interference that may cause undesired operation.

This Class B digital apparatus complies Canadian ICES-003. Cet appareil numérique de la class B est conforme à la norme NMB-003 DU Canada.

**EMI (Electro Magnetic Interference) tested.**

## EN55032

Electromagnetic compatibility of multimedia equipment-Emission requirements

**EN 55022 Information technology equipment----**

Radio disturbance characteristics--- Limits and methods of measurement

**EN 61000-3-2 Electromagnetic compatibility (EMC)---**

Part 3-2:Limits---Limits for harmonic current emissions (equipment input current up to and including 16 A per phase)

**EN 61000-3-3 Electromagnetic compatibility (EMC)---**

Part 3:Limits---Section 3: Limitation of voltage changes, voltage fluctuations and flicker in public low-voltage supply systems, for equipment with rated current  $\leq 16$  A per phase and not subject to conditional connection

**EN 55024 Information technology equipment----**

Immunity characteristics---Limits and methods of measurement

**EN 60065** Audio › video and similar electronic apparatus—Safety requirements

## TRADEMARK INFORMATION

- HDMI, the HDMI Logo and High-Definition Multimedia Interface are trademarks of HDMI Licensing LLC.

## Special Notice

- Never use this product nearby an aircraft or medical facility. It can cause interference or undesirable effect on the operation result.
- Use of this product in the following locations may result in abnormal video and audio output (noise, blocked image... etc.).
  - Product installed in the walls made of concrete.
  - Product is situated near the refrigerator or metal fitment.
  - A cluttered room where the wireless signals may be blocked
- This product has been tested and manufactured to comply with each country's safety rules. However, there is no guarantee that interference will not occur in some installation scenario. If the interference happens, increase the distance between the transmitter and receiver.
- WHDI DEVICE may interfere 5GHz wireless devices, such as routers or other wireless devices. Therefore, if you have an 802.11n router, configure it to the 2.4 GHz band rather than the 5GHz band.
- Optimal range between WHDI DEVICE transmitter and receiver is between 2 and 20 meters within line of sight.



## Europe – EU Declaration of Conformity

This device complies with the essential requirements of the R&TTE Directive 2014/53/EU. The following test methods have been applied in order to prove presumption of conformity with the essential requirements of the R&TTE Directive 2014/53/EU:

- EN 60065: 2014/AC:2016  
Audio, Video and Similar electronic apparatus
- EN 62479:2010  
Assessments of the compliance of Low-power electronic and elect cal equipment with the basic restrictions related to human exposure to electromagnetic fields (10MHz to 300GHz).
- EN 50385:2002  
Product standard to demonstrate the compliances of radio base stations and fixed terminal stations for wireless telecommunication systems with the basic restrictions or the reference levels related to human exposure to radio frequency electromagnetic fields (110MHz - 40GHz). General public
- EN 301 893 V1.8.1: 2015  
Broadband Radio Access Networks (BRAN); 5 GHz high performance RLAN; Harmonized EN covering essential requirements of article 3.2 of the R&TTE Directive
- EN 301 489-1 V1.9.2: 2011  
Electromagnetic compatibility and Radio Spectrum Matters (ERM); Electro Magnetic Compatibility (EMC) standard for radio equipment and services; Part 1: Common technical requirements
- EN 301 489-17 V2.2.1 2012  
Electromagnetic compatibility and Radio spectrum Matters (ERM); Electro Magnetic Compatibility (EMC) standard for radio equipment  
Part 17: Specific conditions for Broadband Data transmission systems

Hereby, Zinwell declares that this Full HD Video wireless kit is in compliance with the essential requirements and other relevant provisions of Directive 2014/53/EU



## Federal Communication Commission Interference Statement

This device complies with Part 15 of the FCC Rules. Operation is subject to the following two conditions: (1) This device may not cause harmful interference, and (2) this device must accept any interference received, including interference that may cause undesired operation.

This equipment has been tested and found to comply with the limits for a Class B digital device, pursuant to Part 15 of the FCC Rules.

These limits are designed to provide reasonable protection against harmful interference in a residential installation. This equipment generates, uses and can radiate radio frequency energy and, if not installed and used in accordance with the instructions, may cause harmful interference to radio communications. However, there is no guarantee that interference will not occur in a particular installation.

If this equipment does cause harmful interference to radio or television reception, which can be determined by turning the equipment off and on, the user is encouraged to try to correct the interference by one of the following measures:

- Reorient or relocate the receiving antenna.
- Increase the separation between the equipment and receiver.
- Connect the equipment into an outlet on a circuit different from that to which the receiver is connected.
- Consult the dealer or an

For operation within 5.15 ~ 5.25GHz / 5.47 ~ 5.725GHz frequency range, it is restricted to indoor environment. The band from 5600-5650MHz will be disabled by the software during the manufacturing and cannot be changed by the end user. This device meets all the other requirements specified in Part 15E, Section 15.407 of the FCC Rules.†

experienced radio/TV technician for help.

FCC Caution: Any changes or modifications not expressly approved by the party responsible for compliance could void the user's authority to operate this equipment.

This transmitter must not be co-located or operating in conjunction with any other antenna or transmitter.



### **Radiation Exposure Statement (Transmitter):**

The product comply with the FCC portable F exposure limit set forth for an uncontrolled environment and are safe for intended operation as described in this manual. The further RF exposure reduction can be achieved if the product can be kept as far as possible from the user body or set the device to lower output power if such

function is available.

The USB dongle transmitter is approved for use in typical laptop computers. To comply with FCC RF exposure requirements, it should not be used in other devices or certain laptop and tablet computer configurations where the USB connectors on the host computer are unable to provide or ensure the necessary operating configurations intended for the device and its users or bystanders to satisfy RF exposure compliance requirements. Receiver should be installed and operated with minimum distance 20cm between the radiator & your body.



### **Radiation Exposure Statement (Receiver):**

This equipment complies with FCC radiation exposure limits set forth for an uncontrolled environment. This equipment should be installed and operated with minimum distance 20cm between the radiator & your body.

**Note: The country code selection is for non-US model only and is not available to all US model. Per FCC regulation, all WiFi product marketed in US must fixed to US operation channels only.**



### **Industry Canada statement:**

This device complies with ISED's licence-exempt Ross. Operation is subject to the following two conditions: (1) This device may not cause harmful interference, and (2) this device must accept any interference received, including interference that may cause undesired operation.

Le présent appareil est conforme aux CNR d' ISED applicables aux appareils radio exempts de licence. L'exploitation est autorisée aux deux conditions suivantes : (1) le dispositif ne doit pas produire de brouillage préjudiciable, et (2) ce dispositif doit accepter tout brouillage reçu, y compris un brouillage susceptible de provoquer un fonctionnement indésirable.



### **Caution :**

- (i) the device for operation in the band 5150-5250 MHz is only for indoor use to reduce the potential for harmful interference to co-channel mobile satellite systems;
- (ii) the maximum antenna gain permitted for devices in the bands 5250-5350 MHz and 5470-5725 MHz shall be such that the equipment still complies with the e.i.r.p. limit;
- (iii) the maximum antenna gain permitted for devices in the band 5725-5850 MHz shall be such that the equipment still complies with the e.i.r.p. limits specified for point-to-point and non-point-to-point operation as appropriate; and
- (iv) Users should also be advised that high-power radars are allocated as primary users (i.e. priority users) of the bands 5250-5350 MHz and 5650-5850 MHz and that these radars could cause interference and/or damage to LE-LAN devices.



### **Avertissement:**

Le guide d'utilisation des dispositifs pour réseaux locaux doit inclure des instructions précises sur les restrictions susmentionnées, notamment :

- (i) les dispositifs fonctionnant dans la bande 5150-5250 MHz sont réservés uniquement pour une utilisation à l'intérieur afin de réduire les risques de brouillage préjudiciable aux systèmes de satellites mobiles utilisant les mêmes canaux;
- (ii) le gain maximal d'antenne permis pour les dispositifs utilisant les bandes de 5250 à 5350 MHz et de 5470 à 5725 MHz doit être conforme à la limite de la p.i.r.e.;
- (iii) le gain maximal d'antenne permis (pour les dispositifs utilisant la bande de 5725 à 5850 MHz) doit être conforme à la limite de la p.i.r.e. spécifiée pour l'exploitation point à point et l'exploitation non point à point, selon le cas;
- (iv) De plus, les utilisateurs devraient aussi être avisés que les utilisateurs de radars de haute puissance sont désignés utilisateurs principaux (c.-à-d., qu'ils ont la priorité) pour les bandes 5250-5350 MHz et 5650-5850 MHz et que ces radars pourraient causer du brouillage et/ou des dommages aux dispositifs LAN-EL.



### **Radiation Exposure Statement:**

This equipment complies with ISED radiation exposure limits set forth for an uncontrolled environment. This equipment should be installed and operated with minimum distance 20cm between the radiator & your body.



### **Déclaration d'exposition aux radiations:**

Cet équipement est conforme aux limites d'exposition aux rayonnements ISED établies pour un environnement non contrôlé. Cet équipement doit être installé et utilisé avec un minimum de 20 cm de distance entre la source de rayonnement et votre corps.

## 2. Introduction

WHD100 is a Full HD wireless transmission device.

This solution delivers uncompressed 1080p full HD video and audio content to your existing HDTV set wirelessly. It operates the transmission in 5.1 GHz~ 5.9 GHz frequencies and it can adjust its communication frequency automatically in case of interference from another RF system. With built-in Omni-directional antennas, it can transmit uncompressed video content to 7 meters (20 feet) LOS (Line of sight) with no latency.

### 2.1 Packing Content

Please check whether the following items are present in the package. If any items missed or damaged, please call your dealer.

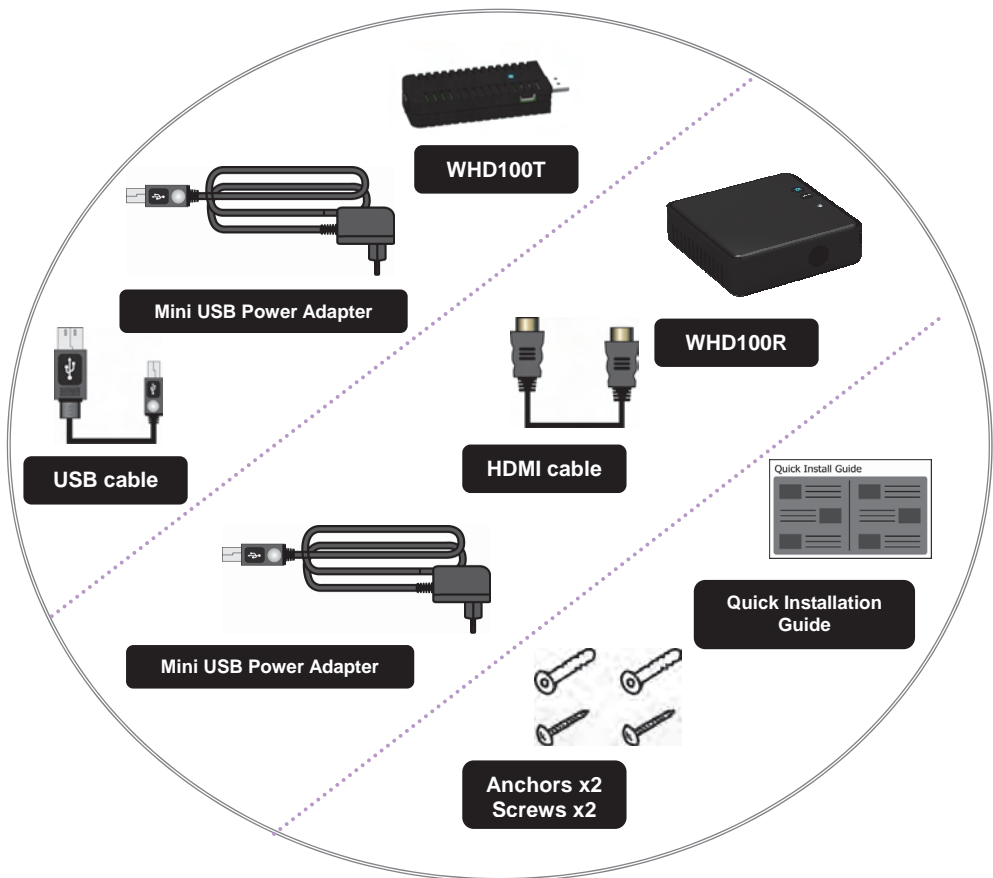



## 2.2 Overview

### 2.2.1 Transmitter

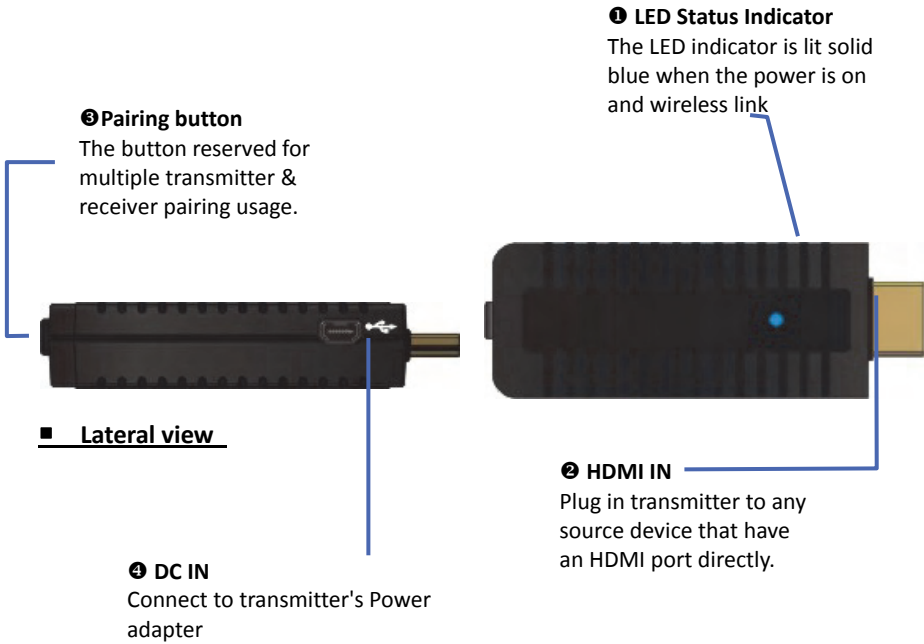

## 2.2.2 Receiver

### ■ Top view



**❶ Power Button with LED indicator**

Press to turn the receiver on and off. The indicator in the power button lights up in blue when the power is on, and turns red in standby mode.

**❸ Status LED**

Display the video status information.

**❷ INFO. Button**

Press this button for OSD displayed the information on the HDTV screen.

### ■ Rear view

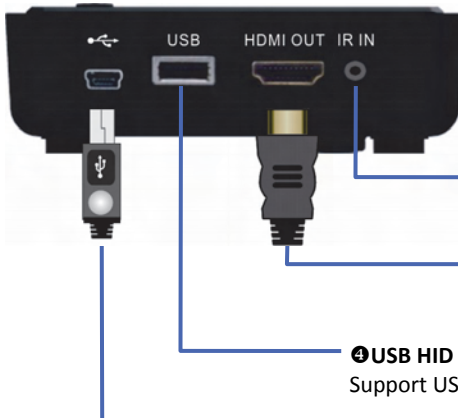

**❸ IR IN**

Connect to IR Sensor extended cable.

**❶ HDMI OUT**

Connect to HDTV set via an HDMI cable.

**❷ USB HID**

Support USB HID function for Keyboard/mouse usage.

**❹ DC IN**

Connect to receiver's power adapter.

### 3. Installation

#### Step 1: Setup the transmitter

Connect an HDMI-ready device to the transmitter:



- (1) Plug the transmitter's HDMI connector to the HDMI-ready Source player's "HDMI OUT" directly.
- (2) Connect the supplied power adapter to the DC IN port of the transmitter and a wall socket. When it's connected to the power mains and LED indicator lights up in blue.

## Step 2: Setup the receiver

### HDTV set connection with receiver

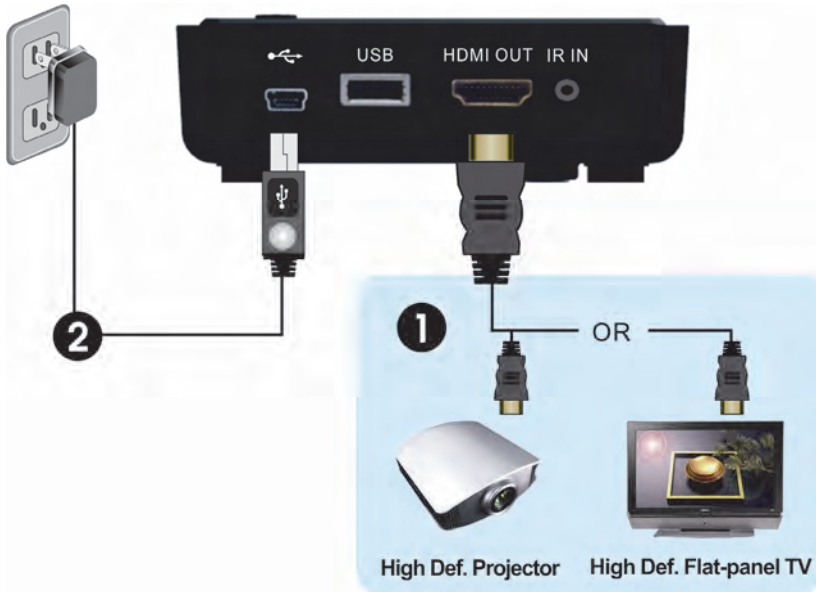

- (1) Connect the HDMI cable to the HDMI OUT jack of the receiver and to your HDTV set (or an HD projector).
- (2) Connect the supplied power adapter to the DC IN jack of the receiver and a wall socket. When it's connected to the power mains and Power LED indicator on the POWER button lights up in blue.

### Step 3: Boot up the transmitter and receiver

- (1) **After** the power cord is plugged into the electrical outlet, the WHD100 will be turned on and link established automatically.

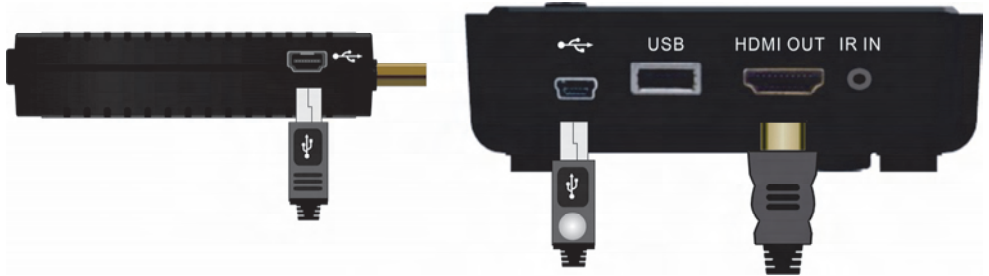

**When** unplug the power of transmitter, receiver will enter Standby mode (POWER LED of receiver is lit in red) when link drop over 10mins.

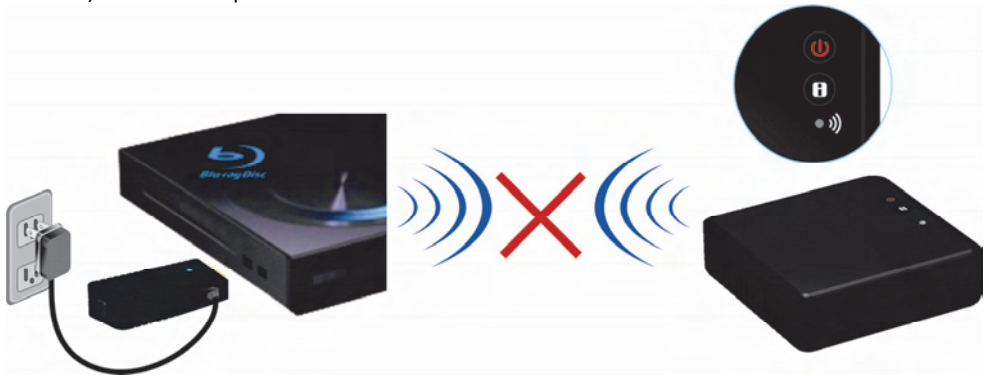

- (2) **When** receiver in Standby mode (Receiver POWER LED is lit in red), plug in the power of transmitter, the transmitter will wakes up the receiver automatically to establish a link.





- (3) **During** the warm-up period, the POWER LED will blink in blue until the signal link between the transmitter and the receiver is established. It will spend around 15 ~ 20 seconds for boot up and link established if the operation is in normal condition.

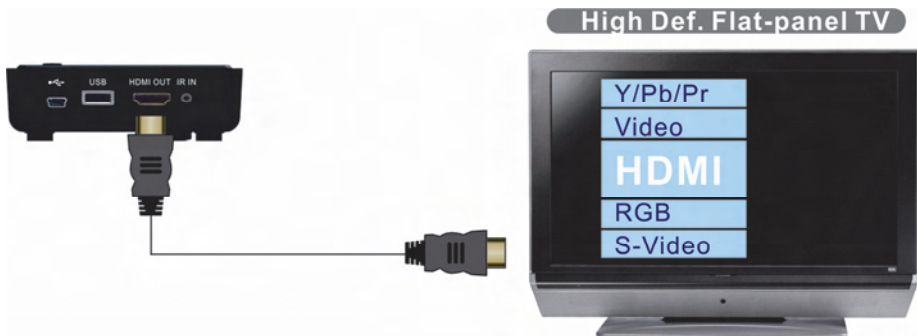

Ensure your TV set or projector is in “HDMI input” mode, and is already powered on.

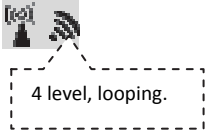
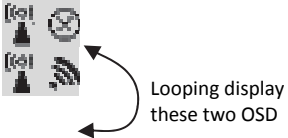

- (5) If all operation is normal, the POWER LED and INFO./CHANNEL LED will glow in solid blue. Please refer to the below form containing detailed LED indicator and OSD description of transmitter / receiver:

| Item / Mode                         | Status Description  | Power LED (on RX) | Status LED (on RX) | OSD Display (on RX)  |
|-------------------------------------|---|-------------------|--------------------|--|
| <b>Standby</b>                      | For power saving mode.  | Static Red        | off                |   |
| <b>Initial Boot up / Warm up</b>    | It will spend 15 ~ 20 seconds for system boot up.   | Blinking Blue     | Blinking           |   |
| <b>Searching available channels</b> | Continuing search available channels<br>If system can't establish link over 80s after initialization.<br>(Note A & D) | Blinking Blue     | Blinking           |  |
| <b>Wireless linked Mode</b>         | No input from selected source<br>(Note B)   | Static Blue       | Blinking (Quickly) |   |
|                                     | Video format not recognized<br>(Note C)   | Static Blue       | Blinking (Slowly)  |   |
|                                     | Video format is recognized  | Static Blue       | Static Blue        | -  |

**Note:**

- If the RF connection over 80sec and still not established, it might link is lost or the transmitter is most likely out of range. You may have to verify the range and adjust or shorten the distance between your HDTV set with the transmitter and the receiver. The maximum video transmission range for 1080p content is up to 15 feet in line of sight (LOS). < The minimum range is 6.5 feet. >
- Please make sure source device has been power on.
- If there is no video displayed and OSD displayed "Not Supported Format", this is an indication that the video frame rate from source device is not supported, please refer chapter 5 to switch a supported video timing.
- If you have more than one pair of WHD100, each transmitter and receiver should be at least 6.5 feet away from one another. If both the transmitter and the receiver exist in the same room, the suggested the distance between the two is 6.5 feet minimum.

(6) **TRANSMITTER/RECEIVER** Status on OSD vs. buttons:

❶ Press the **POWER** button on the top of Receiver to enter “Active-Standby mode” from “Active mode”.

- The OSD Shows: (Display 3secs and then enter Active-Standby mode.)



❷ Press the **INFO.** button on the top of Receiver, the **Signal Quality, Source, Channel and resolution will be displayed for user reference. Press INFO. button again for exit.**

OSD Displayed :

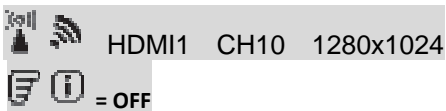



## Step 4: Mounting the receiver to the Wall

- (1) Refer the drawing of the bottom page that have relative position of the key holes and attach this paper on wall.

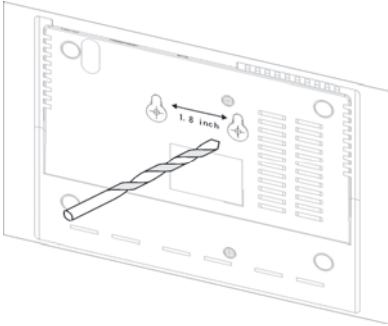

- (2) Drill pilot holes.
- (3) Insert the supplied two Anchors into the wall.

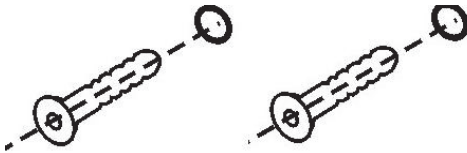

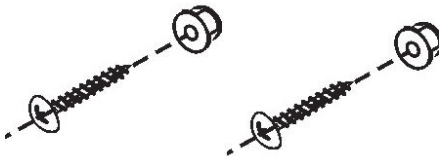

- (4) Insert two screws into the anchors. Leave 1/8" length for mounting the receiver.

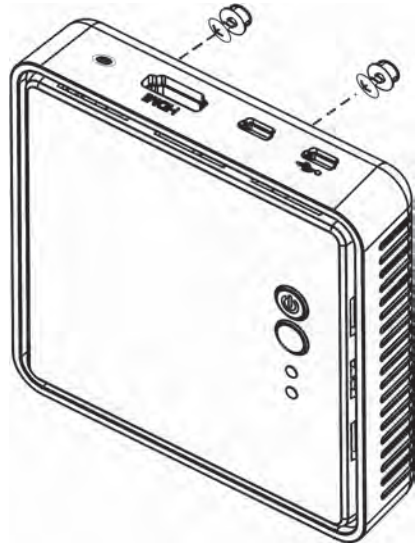

- (5) Place receiver key holes over the protruding screws and slide down into position.



## 4. Troubleshooting

| Problem   | Solution  |
|---|---|
| <p>The WHD100 front panel power indicator (red LED) doesn't light up.</p> | <ul style="list-style-type: none"> <li>• Check if the power plugs of transmitter/receiver are properly inserted into a functioning power outlet.</li> <li>• Make sure both POWER LED of transmitter/receiver are lit in the blue.</li> </ul>  |
| <p>There is no video displayed on your TV screen.</p>                     | <ul style="list-style-type: none"> <li>• Verify that the proper cables have been selected and installed between the transmitter input and your source device output.</li> <li>• On your TV side (connected to the receiver), select the HDMI as input source.</li> <li>• Verify the POWER LED and INFO. LED indicator of receiver.</li> </ul> <p><b>Power LED Flashing in Blue</b></p> <p><b>OSD displayed:</b>  (4 levels looping)</p> <ul style="list-style-type: none"> <li>* Ensure the transmission range between the transmitter and the receiver is not over 15 feet (LOS-line of sight) transmission distance. Move the transmitter closer to the receiver.</li> </ul> <p><b>POWER LED in Solid Blue + Slow and Flashing SOURCE LED</b></p> <p><b>OSD displayed :</b> </p> <ul style="list-style-type: none"> <li>* Ensure your video resolution and frame rate is recognized/ supported and within the transmission range.</li> <li>* Connect the source device to your TV to check and modify the video format compatibility.</li> <li>* Check your video resolution with HDMI input from your device is 1080p, 1080i, 720p, 576p, 480p. Please refer Chapter 5 for the detail supported Resolution.</li> </ul> <p><b>POWER LED in Solid Blue + STATUS LED Flash Quickly</b></p> <p><b>OSD displayed :</b> </p> <ul style="list-style-type: none"> <li>* Ensure the proper cables are connected between the transmitter and your source devices.</li> <li>* Ensure your source devices connected to the transmitter are powered on.</li> </ul> |

|  |  |
|--|--|
| Poor picture quality or intermittent video play. | <ul style="list-style-type: none"> <li>• Check if your video resolution with HDMI input from your source device is either 1080p, 1080i, 720p, 576p, or 480p. Please refer to the “Supported Resolution” chapter where the video frame rate from your source device WHD100 can support is defined.</li> <li>• Ensure the transmission distance is less than 15 feet (LOS).</li> </ul> |
| No audio.  | <ul style="list-style-type: none"> <li>• Check if your TV’s volume is properly set and not in "MUTE".</li> <li>• Ensure the bit rate of audio from the source device can be supported by WHD100. Please refer to the details in Chapter 6, Audio Bit Rate Support.</li> </ul>  |

## 5. Supported Resolution

If the SOURCE LED continues to blink in blue (slower than “no signal” mode); OSD display: “”, and there is no video displayed or the video quality suffers, it indicates that the video frame rate from your A/V source device is not supported. Ensure that the consumer timing of your HD device is compliant with the standard listed below:

| Video Format Timings              | Resolution | Supported |
|-----------------------------------|------------|-----------|
| <b>Primary CEA Video Timing</b>   |            |           |
| 640x480p @ 59.94 / 60Hz           | 480p       | YES       |
| 720x480p @ 59.94Hz                |            | YES       |
| 720x480p @ 60Hz                   |            | YES       |
| 720x576p @ 50Hz                   | 576p       | YES       |
| 1280x720p @ 50Hz                  | 720p       | YES       |
| 1280x720p @ 59.94 / 60Hz          |            | YES       |
| 1920x1080i @ 50Hz                 | 1080i      | YES       |
| 1920x1080i @ 59.94 / 60Hz         |            | YES       |
| 1920x1080p @ 50Hz                 | 1080p / 60 | YES       |
| 1920x1080p @ 59.94 / 60Hz         |            | YES       |
| <b>Secondary CEA Video Timing</b> |            |           |
| 1920x1080p @ 23.98 / 24Hz         | 1080p / 24 | YES       |
| 1920x1080p @ 25Hz                 |            | YES       |
| 1920x1080p @ 29.97 / 30Hz         |            | YES       |
| <b>VESA Timing (DVI only)</b>     |            |           |
| 640x480 @ 59.94 / 72.809Hz        | VGA        | YES       |
| 800x600 @ 60.317 / 72.188Hz       | SVGA       | YES       |
| 1024x768 @ 60 / 70.069Hz          | XGA        | YES       |
| 1280x768 @ 60 Hz                  | WXGA       | YES       |
| 1280x1024 @ 60 Hz                 | SXGA       | YES       |
| 1600x1200 @ 60Hz                  | UXGA       | YES       |

## 6. Audio Bit Rate Support

- Digital Audio from HDMI inputs: Up to 6Mbit/s bit-rate support.
- Support AC3 and DTS.
  - 2-channel PCM audio : 16~24 bits audio sample with 32~48KHz sampling rate

| 2channel PCM | 32KHz | 44.1KHz | 48KHz | 96KHz |
|--------------|-------|---------|-------|-------|
| 16 bits      | YES   | YES     | YES   | YES   |
| 24 bits      | YES   | YES     | YES   | YES   |

## 7. Product Specification

| General Specifications      |                       |  |                                |
|-----------------------------|-----------------------|--|--------------------------------|
| Supported Video Resolutions | HDMI Input            | 1080p, 1080i, 720p, 576p, 480p   |                                |
| Supported Audio Formats     | Digital Audio         | up to 6 Mbps AC3 and DTS   |                                |
| Transmission Distance       |                       | The maximum video transmission range is 5 meters (15 feet)<br>(The minimum range is 2 meters)<br>line of sight (LOS) scenarios |                                |
| System Latency              |                       | No latency (<1ms)  |                                |
| Antenna                     |                       | High Performance Internal Antennas   |                                |
| Operating Frequencies       |                       | 5.1~ 5.9GHz (Include non-DFS and DFS Frequency Bands)  |                                |
| Power Supply                |                       | 100~ 240V AC in, 5V DC out Power Adaptor   |                                |
| Operating Temperature       |                       | 0~40°C   |                                |
| Interfaces                  |                       | WHD100T  | WHD100R                        |
| A/V Interfaces              | HDMI Input            | One (Type A, Male)   | -                              |
|                             | HDMI Output           | -  | One (Type A, Female)           |
| Power Interface             | Power Input           | 5V mini USB  | 5V mini USB                    |
| Switches                    | Power Switch          | -  | YES (One Tack Switch)          |
|                             | INFO. Switch          | YES (One Tack Switch)  | YES (One Tack Switch)          |
| LEDs                        | Power LED             | -  | 1 x LED (Two Tone: Blue / Red) |
|                             | Status LED            | 1 x Blue LED   | 1 x Blue LED                   |
|                             | Signal Quality Status | -  | OSD Displayed                  |
| Dimensions                  |                       | 30(W) x 82.2(L) x 17.5(H) mm   | 194.8(W) x 146.8(L) x 31(H) mm |

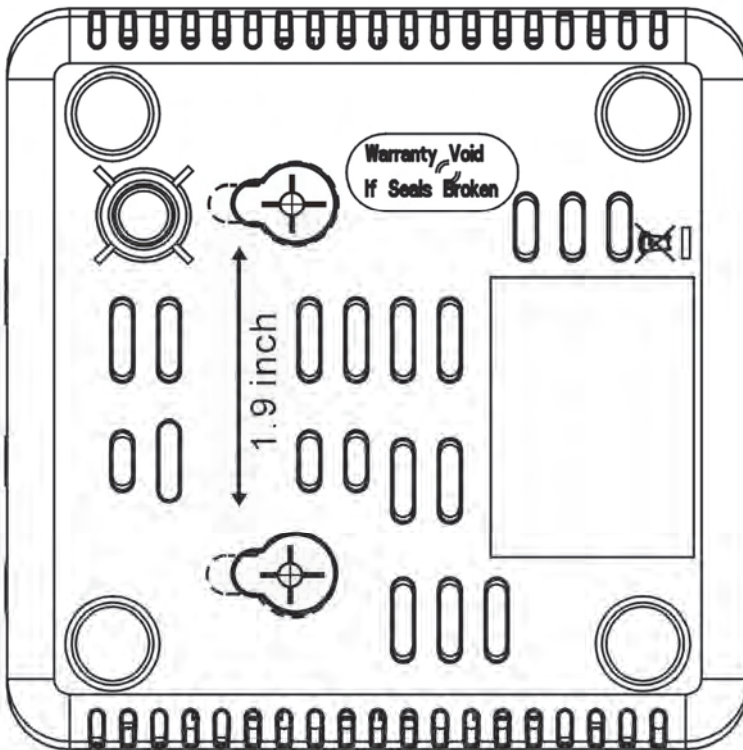







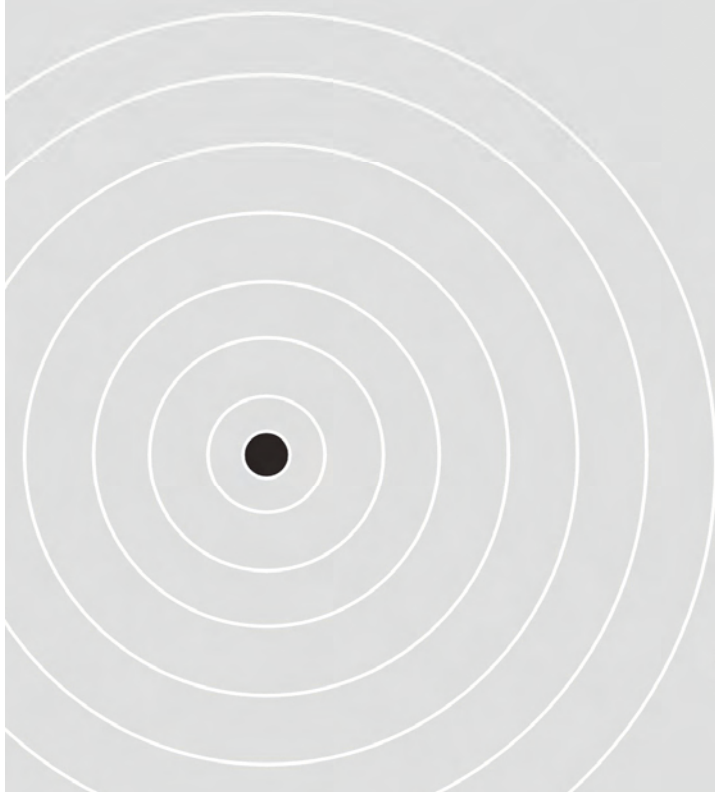

IB04360099 Rev.0