

Zip HydroTap® G4

Filtered boiling, chilled and sparkling drinking water for commercial kitchens.

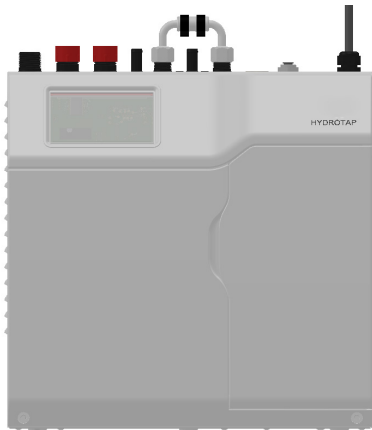

Boiling, chilled sparkling
compact model
Command-Centre™.



Affix model number label
here
802265UK



Tap options

The G4 series offers a range of interchangeable taps to suit the customer's needs



Classic HydroTap®G4 range



Arc / Cube range

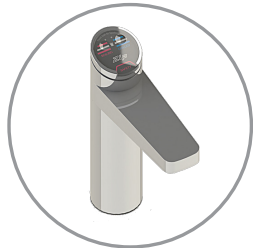

Elite range



Mixer range



All-in-One range

These standalone taps are directly compatible with the G4 Command-Centre™.

The mixer tap range may be used in conjunction with any of the above to provide mixed hot and cold water for sanitary use.

The All-in-One tap may be used as alternatives to any of the above combinations.

Index

HydroTap®G4 specifications

Installation check list	4
General product features	5
Important safety instructions	6
Warnings	7
Major components and accessories.....	8
Technical specification	9
Before installation and site requirements	10

Installation instructions

Step 1 - Measure and cut all the tap holes, fit the taps : Refer to 803341UK Tap installation instruction supplied with the tap head.

Step 2 - Check for adequate ventilation.

Section 1 - Ventilation.

1.1 - Ventilation on all models	11
1.2 - Preferred arrangement.....	11
1.3 - Alternative arrangement.....	11

Step 3 - Install the booster (if required)

Section 2 - Booster installation

2.1- Product details and installation procedure	12-14
---	-------

Step 4 - Mount the external filter / softener (if required)

3.1 Mounting the filter head and cartridge installation.....	15
--	----

Step 5 - Fit the CO₂ gas cylinder

Section 4 - CO₂ cylinder and regulator

4.1 - Connect, secure and test the CO ₂ cylinder	16-17
---	-------

Step 6 - Install the Command-Centre™.

Section 5 - Command-Centre™ installation

5.1- Check the external bypass valve setting & Mains water supply hose.....	18
5.3- Boiling, chilled and sparkling HydroTap®G4 models.....	19
5.4- Boiling, chilled and sparkling All-in-One 'Mains' tap	20
5.5- Boiling, chilled and sparkling All-in-One 'Vented' tap	21
5.6- Boiling, chilled and sparkling HydroTap®G4 and mixer tap combinations	22

Step 7 Commission the HydroTap®G4

Section 6 - Commissioning

6.1- 6.2 Select language and CO ₂ purge	23
6.3- Filter flush	23
6.4- Boiling calibration.....	24
6.5- 6.6 Booster.....	24
6.7- Safety sensor calibration.....	25

Trouble shooting

Trouble shooting table.....	26
End of life disposal	26
Warranty.....	27
Contact details	28

Installation checklist

Before installation

- Read the instructions and check if there is adequate space to mount all of the components.
- **Note** Not all fittings are supplied with the appliance kit. Isolation valves are not supplied.
- Check the mains water pressure is within min / max requirements (see page 9).
- Check the water quality to determine if extra filtration will be required.
- **Note** This product must be fitted to a potable water supply.
- Check the appliance rating plate and ensure correct power is available for the appliance.
- Check the under counter cupboard floor has sufficient strength to support the Command-Centre™ when full of water (see page 9 for weights).

Before commissioning

- Flush the supply line before connecting.
- Check the Command-Centre™ has been installed correctly.
- Check all plumbing fittings have been tightened.
- Ensure the outlet and vent pipes are positioned to drain correctly into a sink or font.
- Ensure there is adequate ventilation.
- Check all tubes and pipes from the Command-Centre™ to the tap have a constant rise and there are no sags or kinks in the hoses.
- Check all electrical connections are correct and there are no loose wires.

Commission (see section 6)

- Turn on the CO₂ and water and check for leaks.
- Purge the CO₂.
- Flush the filters, (this commences auto calibration).
- Activate / enable the booster (if fitted).
- Calibrate the safety sensor.
- Where applicable, programme the Command-Centre™ to suit the customer's requirements.

General product features

Thank you for purchasing a Zip HydroTap®G4. Please read and follow these instructions carefully to ensure safe and trouble free operation. If help and advice is required, please call 0345 6 005 005.

What is the Zip HydroTap®G4?

This Zip HydroTap®G4 is an electronically controlled, filtered, boiling, chilled and sparkling water, drinking system for the kitchen. The Zip HydroTap®G4 Command-Centre™ is an under counter drinking water appliance with a dispensing tap mounted on a sink or worktop, which has been designed for commercial applications. The Zip HydroTap®G4 Command-Centre™ utilises a conventional refrigerant compressor to chill the water and an immersion heating element to boil the water, all utilise a CO₂ gas cylinder to carbonate the chilled water. The Command-Centre™ will dispense boiling water (factory set to 98°C) and chilled and sparkling water (factory set to 3-5°C). The HydroTap®G4 is NOT designed to be used for sanitary fixtures. The Command-Centre™ is fitted with a tap mounted safety lock. In addition, there are various energy saving options accessible via the main menu. Each Command-Centre™ providing boiling water is equipped with a self-calibrating program which caters for altitude adjustment. The water filter and CO₂ cylinder are disposable items which will require periodic replacement and are covered by a limited OEM (original equipment manufacturer) warranty.

It is important that the installation be undertaken safely, correctly and completely, in order to utilise all the benefits that the HydroTap®G4 can provide. Each unit can be ordered with the tap head assembly for disabled use. The disabled levers are supplied with Braille caps for the visually impaired.

HydroTap®G4 Command-Centre™

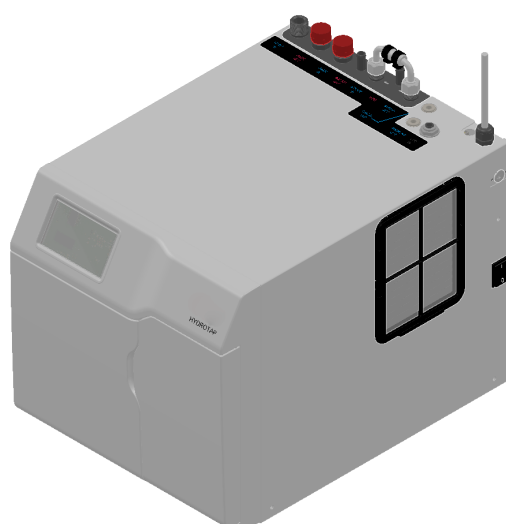

Commercial boiling, chilled and sparkling compact

Important safety instructions

This manual contains important safety and installation instructions for the Zip HydroTap®G4. Please read all warnings, installation requirements and installation instructions before installing any Zip HydroTap®G4. This system must be installed in accordance with water supply byelaws, current IEE regulations and relevant local authority byelaws.



Safety

This appliance is not intended for use by children under 8 years. Or persons (including children under 8 years) with reduced physical, sensory or mental capabilities, or lack of experience and knowledge, unless they have been given supervision or instruction concerning the use of the appliance by a person responsible for their safety. Children should be supervised to ensure that they do not play with the appliance. Cleaning and user maintenance shall not be made by children without supervision.

Refrigerant

The Zip HydroTap®G4 Command-Centre™ contains R134A refrigerant under pressure. Maintenance of the refrigeration unit must be carried out by an accredited service provider or qualified refrigeration technician.

Qualifications

If the power cable is damaged it must be repaired only by a qualified technician. To avoid hazards, all installation procedures must be carried out by a suitably qualified tradesperson. The power cable and power outlet must be in a safe visible position for connection.

Venting

Sometimes steam and / or boiling water may discharge through a vent outlet on the tap. If the tap is not installed using the front, ensure the tap body is located so the tap outlet safely dispenses into the sink bowl area.

Lifting

Take care when lifting the Zip HydroTap®G4. The Command-Centre™ may exceed safe lifting limits. If you feel this is beyond your personal capabilities, please seek assistance with the lift. The weight of the Command-Centre™ is marked on the packaging. Do not lift the Command-Centre™ by the front cover or any of its connections. Refer to the technical specification, see page 9, for the weight of the product.

Airflow

The Zip HydroTap®G4 operates within the ambient temperature range 5°C - 35°C. Proper air circulation must be provided. The system will operate satisfactorily only if the recommended air gaps are provided. See Section 1 'Ventilation', page 11, for correct installation to prevent overheating.

Altitude

Water boils at varying temperatures at different altitudes. The HydroTap®G4 adjusts for this during startup calibration and will recalibrate itself on a regular basis.

Frost protection

If the HydroTap®G4 is located where the ambient air temperature could fall below 5°C when the heater is not in use, do not turn off the appliance electrically. This safeguard does not offer the same protection to the connecting pipework and fittings.

Positioning

It is important to ensure the Command-Centre™ is positioned in an accessible area close to the floor level. The Command-Centre™ must have its base mounted in a horizontal position with all inlets and outlets facing up. The tap must be located above the Command-Centre™. See Section 5, Command-Centre™ installation pages 18 - 22.

Important safety instructions



WARNINGS

- ⚡ The Zip HydroTap®G4 Command-Centre™ must be earthed. The resistance of the earth connection from each exposed metal part must be less than 1Ω.
- All installation and service work must be completed by trained and suitably qualified tradespeople. Faulty operation due to unqualified persons working on this product, or any other Zip product may void warranty coverage.
- As the installer, it is your responsibility to supply (if necessary) and install all valves as required by local regulations and relevant standards.
- This Zip HydroTap®G4 Command-Centre™ is rated for 230V 50Hz AC operation.
- Do not remove the cover of the appliance under any circumstances without first isolating the appliance from the power supply.
- The Zip HydroTap®G4 Command-Centre™ must never be located near, or cleaned with water jets.
- Do not expose the Zip HydroTap® G4 to the elements of nature.
- Due to the process of continuous improvement, Zip Water (UK) reserves the right to change details mentioned in this manual, without notice.

Visit www.zipwater.com/uk to ensure you have the latest copy.



CO₂ - Disposable cylinder

Compressed carbon dioxide, food grade











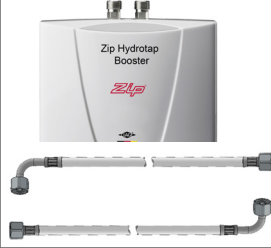



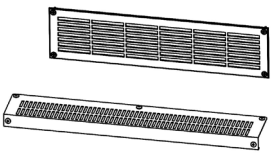

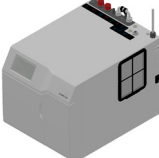
Cylinder specifications

- | | |
|----------------------------------|-----------------------------|
| • UN No. 1013 | • Class 2.2 |
| • Code ZT400 | • Volume 2.2 litres |
| • Contents 1kg | • Tare 1.745kg |
| • Test pressure 12 MPa (120 bar) | • Boiling point -78.5°C |
| • Non flammable gas | • Non toxic gas |
| • Std: EN12205 | • Temp range -20°C to +65°C |

CO₂ Cylinder warnings

- Pressurised container.
- Protect from sunlight.
- Contains gas under pressure, may explode if heated.
- Do not expose to temperatures exceeding 50°C.
- Do not pierce or burn, even after use.
- Do not refill – non rechargeable.
- Ensure cylinder is empty before disposal.
- Do not expose to naked flame or any incandescent material.
- Keep out of reach of children.
- High concentration of gas may cause asphyxiation.
- Use only in ventilated areas.
- Store in an area no less than 38 cubic meters.
- Use only in an upright position.
- This bottle must be used with the approved pressure regulator.
- Avoid shock.
- Use according to MSDS. (Material safety data sheet).

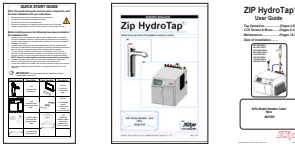
Major components and accessories

Parts supplied	Description	Accessories	Description
Tap options			
	1 x HydroTap®G4 Classic Elite or # Arc / Cube #(inc. Tube kit)		Booster (inc. connection hoses) ZT011
	1 x All-in-One HydroTap®G4 Mains or Vented		Scale filter installation kit *ZT200G4 Filter not included.
	1 x Mixer tap Classic, Arc or Cube		Font kit Classic & Elite 90915UK** Arc / Cube 93441UK**
Command-Centre™ and components			
	Vent kit 2 x outlet vent 1 x inlet vent		Replacement internal 0.2 micron filter ZT402
	1 x Command-Centre™ with air and water filters		Disabled lever kit BCS SP91564 (Classic HydroTap®)
	1 x Mains water connection hose		4-in-1 upgrade** SP91546 Classic SP93413 Arc SP93414 Cube
	1 x Booster inc. connection hoses (supplied dependant upon configuration)		All-in-One upgrade** SP93336 (vented) SP93335 (mains)
	1 x Installation fittings (configuration supplied dependant on tap model)		1 X CO ₂ gas cylinder ZT400
	1 x User guide and 1 x Quick start guide 1 x Installation instruction		Recommended water block HE45004
	1 x CO ₂ gas cylinder assembly		

*ZT200G4 kit to fit filters

** Chrome finish part numbers are shown, alternative finishes are available.

Technical specifications

Boiling Chilled and sparkling HydroTap® G4 range

HydroTap®s

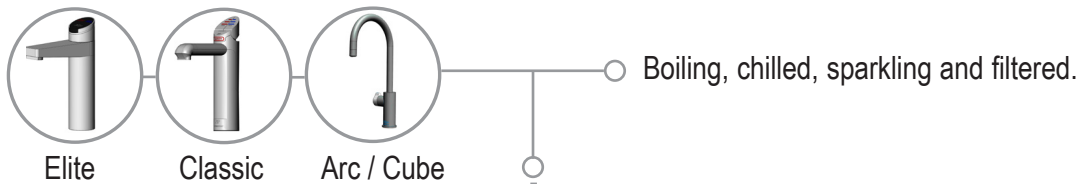

Mixer taps

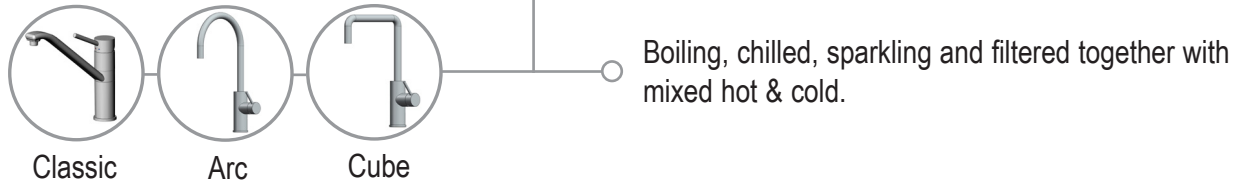

All-in-One taps

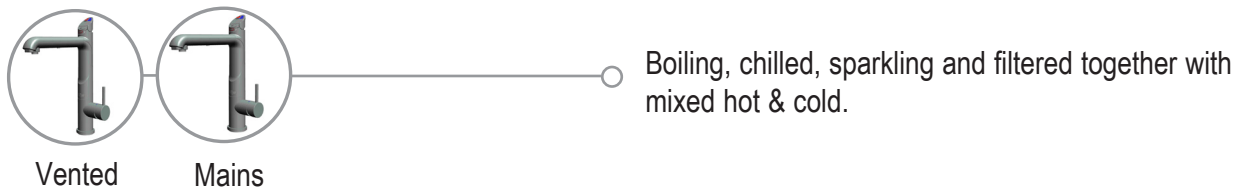

Boost (10A)	13A sockets required	Power rating (kW) 230V	Boost rating (kW) 230V	Unit Dimensions W x D x H (mm) with air duct	*Dry weight (kg)
Boiling, chilled, sparkling and filtered, without booster					
no	1x13A	2.13	N/A	339 x 460 x 335	30kg
Boiling, chilled, sparkling and filtered, with booster					
yes	2x13A	2.13	2.20	339 x 460 x 335	30kg

* Add an extra 5 kg when full of water

Min / Max water supply pressure

HydroTaps and Mains All-in-One taps.....0.25 MPa (2.5 bar) - 0.7 MPa (7 bar)

Mixer taps and Vented All-in-One taps.....0.25 MPa (2.5 bar) - 0.7 MPa (7 bar)

Booster and scale filtration (in these systems).....0.25 MPa (2.5 bar) - 0.7 MPa (7 bar)

Before installation



Before installation ensure that the following have been provided at the installation site

- Review of all the technical specifications.
- Ensure the under counter cupboard floor can support the product weight when full of water (allow an extra 5kg when full).
- Sufficient space in the cupboard to install the Command-Centre™ and other components in accordance with these installation instructions. See technical specification, page 9 for dimensions. Make allowance for a booster if required. See sections 2 pages 12 to 14 for installation instructions.
- For Zip HydroTap®G4 boiling, chilled and sparkling models, 1 x 220-240V AC 13A socket will be required.
- For Zip HydroTap®G4 boiling, chilled and sparkling models, with booster 2 x 220-240V AC 13A sockets will be required. (One socket is for the Command-Centre™ and the other for the booster).
- Both the Command-Centre™ and booster must be installed in accordance with IEE regulations. See Technical specification, page 9 for power ratings.

Note Check all cable and hose lengths against inlet /outlet positions before proceeding (see sections 3 to 5, pages 15 to 22 for general layout).

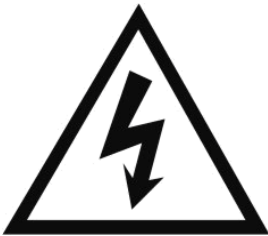

- A potable water supply connection with isolating valve inside the cupboard within reach of the braided hoses and positioned so that the connection point and the stop cock will not be obstructed when the Command-Centre™ is installed.
- For the All-in-One 'Mains' models an external hot and cold water supply is required.
- If an external filtration or water softening device is required, then it is important to allow extra space for these items.
- A potable cold water supply with a minimum working pressure of: (see page 9 min. / max. water supply pressure).
- If pressure is likely to exceed 0.7 MPa (7 bar), install a 0.35 MPa (3.5 bar) pressure limiting valve.
- The appliance must be placed with its base in a horizontal position.

IMPORTANT! Do not proceed with the installation if these requirements are not met.

Section 1 Ventilation

1.1 Ventilation for all models

- The clearance envelope dimensions stated in the specification sheets and installation instructions must be observed.
- Adequate ventilation must be provided to ensure that the cupboard space temperature does not exceed 35°C.

1.2 Preferred arrangement

- The vent kit supplied with the Command-Centre™ should be used to provide adequate ventilation by convection in normal usage.

Note The vent kit has to be installed in a way that allows air to be drawn in from the bottom of the cupboard and expelled through the top of the door (position **A2**) or side of the cupboard (position **A1**). (Where possible air inlet vent and the air outlet vent should be positioned at opposite ends of the same cupboard space).

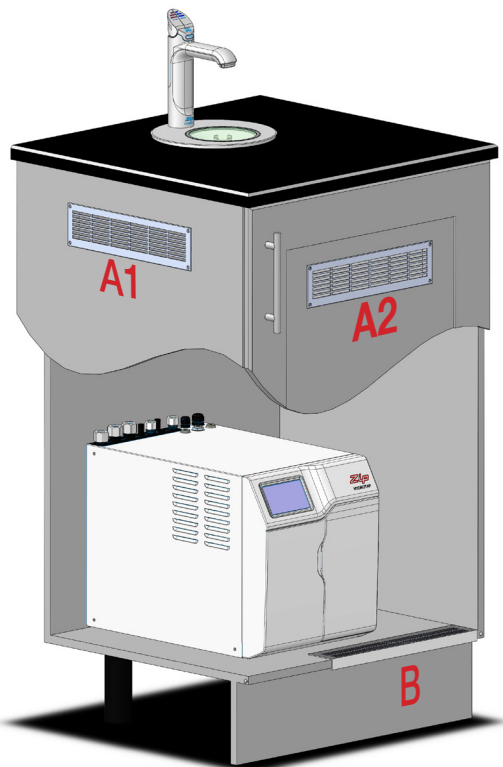

1.3 Alternative arrangement

In situations where the preferred arrangement does not provide adequate ventilation by natural convection a Dual exhaust fan kit* (SP93156) must be fitted to the cupboard door or side (as shown in the illustration below) and connected to the Command-Centre™ DIN socket.

* For dual exhaust fan cut-out dimensions see the instructions provided with the kit.

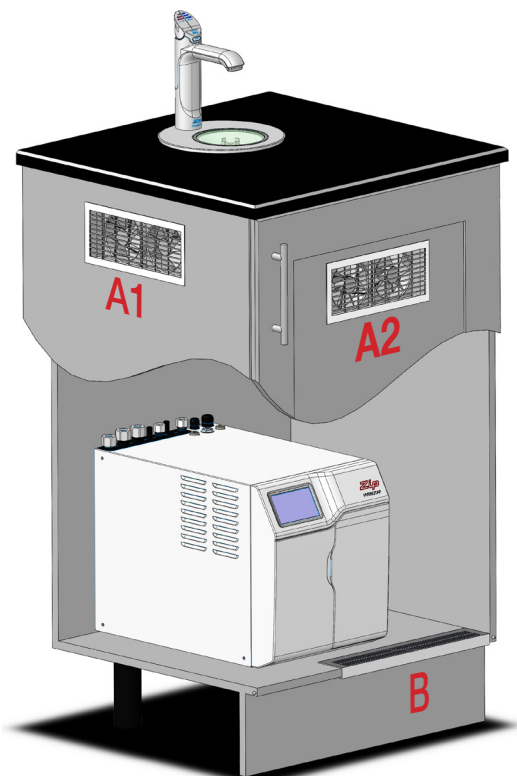

Vent cut-out details

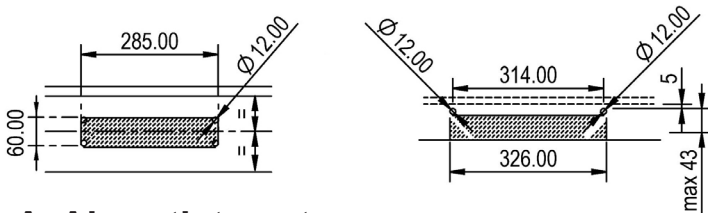

*A Air outlet vent

B Air inlet vent

Note Flat outlet vent detail shown above, louvred outlet vent also supplied.

Section 2

Booster system

2.1 Product description

The booster system is a compact electronically controlled auxiliary water heater. It is intended to provide pre-heating of water before it enters the Zip HydroTap®G4 boiling tank. The booster is supplied as standard with 'vented' All-in-One and mixer tap models. However, it may be later installed, as an accessory, for the Boiling, chilled and sparkling Classic, Elite & Arc / Cube as well as the 'mains' All-in-One and mixer tap models, to increase their boiling water output.



Note 1 Water connection,
blue cap - water in
red cap - water out.
The braided hoses cannot be
lengthened.

Note 2 The electrical cable
length is 1.0m.

Note 3 Position the booster
within reach of the fixed hose
lengths, keeping the booster as
close as possible to the
Command-Centre™ inlet / outlet
connections.

Note 4 Ensure the booster is
mounted in an upright position
(as shown) with a horizontal
base.

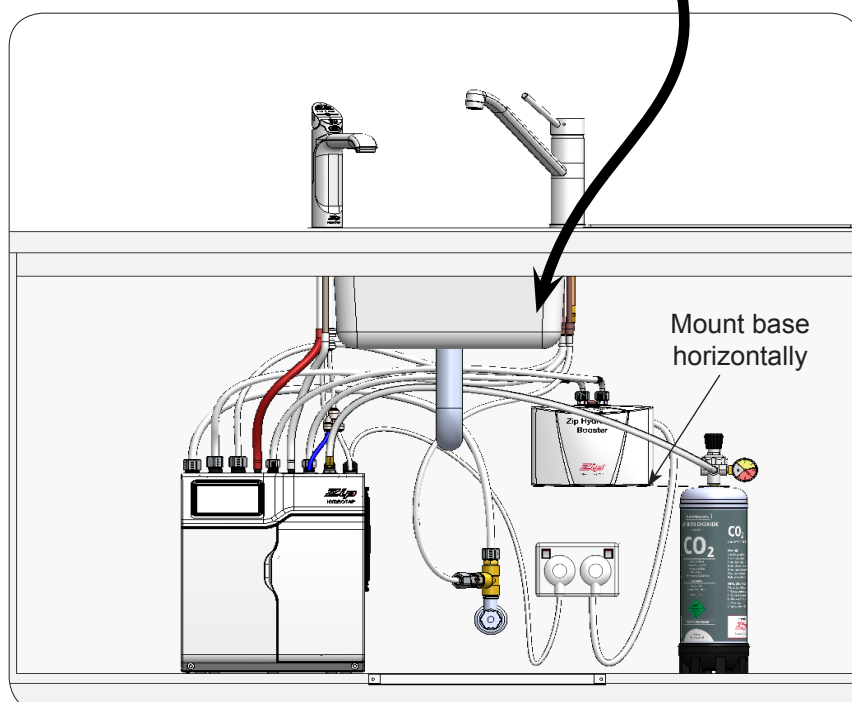

Note 5 Before you install a booster, determine whether an external water filter / softener is required. If an external water filter / softener is required, the external bypass valve must be set correctly, see page 18.

Booster specifications

	Rating	Unit
Nominal power rating	2.2	kW
Nominal current	10	A
Electricity supply 50Hz AC	230	V
Electrical flex, white - 1.0m nom. length	13	A
Fixed flow rate	1.2	L/min

Booster installation

2.2 Installation procedure

Site requirements

- Booster must only be installed in a frost-free area. Never expose booster to frost.
- The booster is designed for wall mounted installation and must be installed with water connectors facing upwards.
- The booster is protected against water ingress to class IP 25.
- The 500mm braided hoses supplied with the booster cannot be lengthened.
- The 90° elbow hose ends should be fitted to the inlet and outlet connections on top of the booster.
- The hot water outlet hose must be thermally insulated with the insulation provided.

2.3 Booster installation see diagrams below

- To remove the mounting chassis, insert a flat blade screwdriver all the way into the lock.
- Gently angle the screwdriver upwards by approximately 10°.
- Pull the booster forwards by approximately 15°.
- Carefully pull the booster upwards to complete the removal process. Take care not to break the lower clips.
- Attach the chassis horizontally to the wall / cupboard wall.
- To install, clip the booster into the mounting chassis and snap into position (see installation below).

Note Remove the mounting chassis for wall mounting.

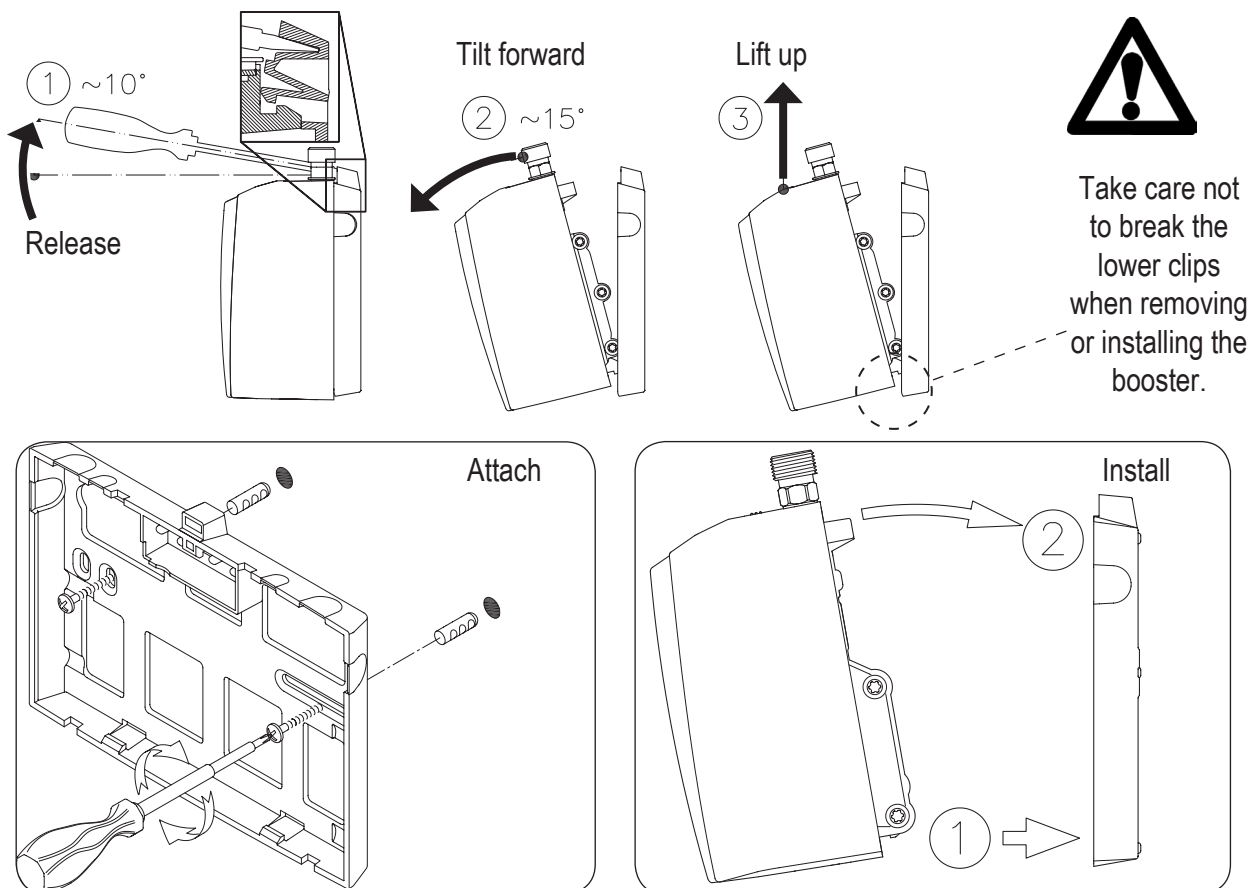

Booster system

Note 1 This appliance is intended for use with the Zip HydroTap®G4 Command-Centre™

Note 2 Water connections must be pointing vertically upwards.

Note 3 The booster unit should be installed as close as possible to the Zip HydroTap®G4 as the 500mm connection hoses cannot be lengthened.

2.4 Braided hose connections

- The cold water inlet (blue) and hot water outlet (red) are marked on the rating plate. Connect the braided hoses from the 'BYPASS OUT' fitting on the HydroTap®G4 to the water inlet of the booster (marked blue) and from the outlet of the booster unit (marked red) to the 'BYPASS IN' fitting on the Command-Centre™. Avoid exerting any mechanical pressure on the booster. This can be achieved by applying a spanner to the flats of the inlet and outlet connections when tightening the braided hose connectors. Do not overtighten ! Tighten the braided hoses by hand, then turn an additional 90° - 180° with a spanner.
- Once the water connections have been made, check for any leaks and rectify as necessary.

Typical installation

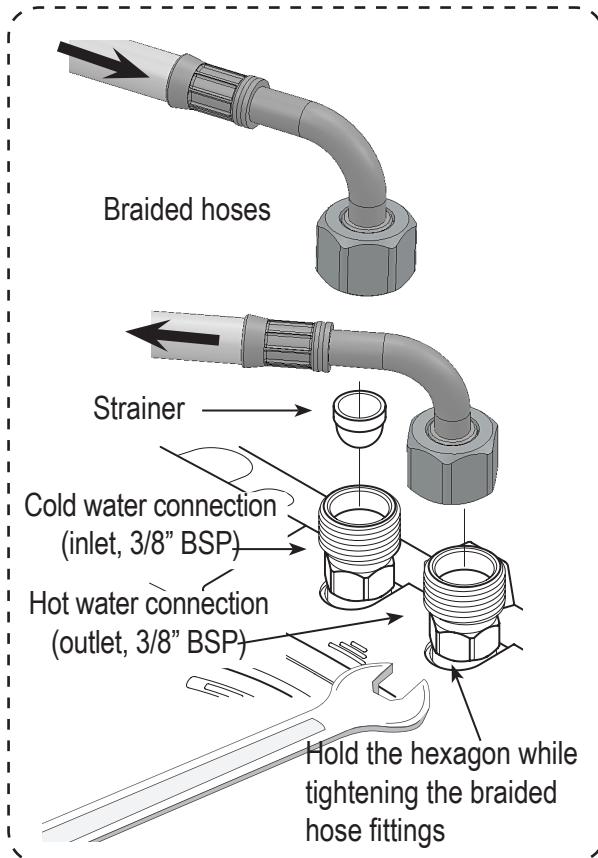
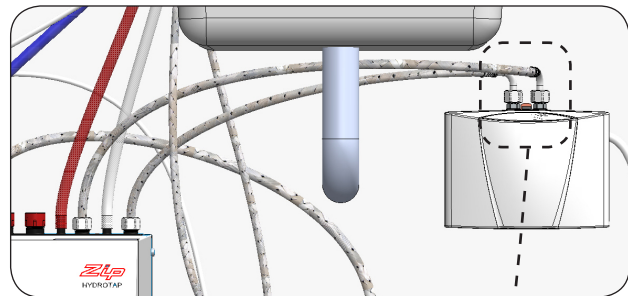

Section 3

Filter / softener installation

An external filter / softener may be fitted to reduce the incidence of scale build up in the hot tank or may be supplied at the customer's request. (Scale filter head fitting kit order code ZT200G4).

3.1 Mounting the filter head

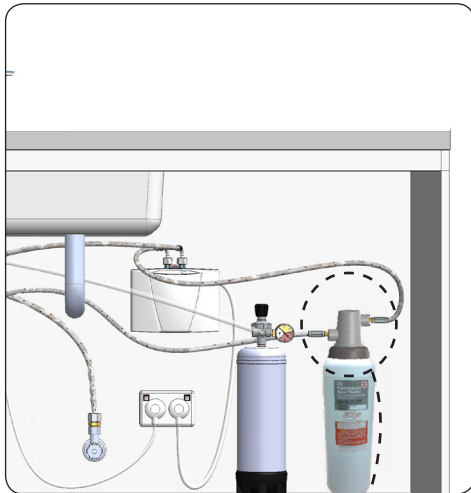

- Choose a suitable location, (cupboard back or side wall) within the reach of the braided hoses.
- Mount the filter head bracket in an upright position, using the screws supplied in the kit.
- Ensure there is enough headroom for the filter cartridge to be easily fitted and removed. *Allow a min. 80mm base clearance.
- Attach the hoses as adjacent diagram, noting the flow directions as marked on the filter head.

3.2 Cartridge installation and flush.

- Remove the sanitary cap from the new cartridge and make sure the o-rings are correctly positioned.
- Moisten o-rings with water. Do not use any petroleum products to lubricate the o-rings.
- Install cartridge with a quarter turn anticlockwise until cartridge comes to a complete stop.
- Cartridge installation is complete.

Note The following instructions to flush the filter must be undertaken AFTER commissioning of the complete HydroTap®G4 system, see section 6, Commissioning, page 23.

- Disconnect the braided hose from the filter outlet on the filter head (out arrow) & insert the filter flush pipe (JG plastic hose). Direct the pipe into a container of greater than 10 litre capacity.
- Turn the mains water supply on.
- Use the HydroTap®G4 to dispense boiling water. After a short time water will flush through the filter into the container.
- Allow 10 litres of water to flush through.
- Turn the mains water supply off.
- Remove the filter flush pipe (JG plastic hose) from the filter outlet, and refit the braided hose from the Command-Centre™.
- Turn the mains water supply on.
- If a booster is fitted, turn the power to the booster off and use the HydroTap®G4 boiling lever to dispense water for 30 seconds, allow the tank to refill.
- Turn the power to the booster on and dispense boiling water for a further 30 seconds.
- The filter / softener flush is complete.



Section 4

CO₂ Cylinder



STORAGE WARNING

WARNING! The cylinder (containing 1kg of CO₂) should be installed in a well ventilated area of area no less than 38m³.

If more than 1 gas cylinder containing 1kg of CO₂ is present within the same location, the recommended ventilation area should be in proportion to the number of gas cylinders stored in that location.

A ventilated area in a non-enclosed area which could include the kitchen, living room etc.

See gas cylinder and MSDS sheet for complete list of warnings.

4.1 Secure the cylinder

Secure the gas cylinder supplied to a suitable wall, within 1 metre of the Command-Centre™, in an upright position. This is undertaken by screwing the metal bar holding the Velcro strap to a cupboard wall, 200mm above the floor or base of the cupboard. Make sure the gas cylinder can stand in place before securing to the wall. Due to regulatory requirements the gas cylinder must be stored securely and in an upright position.

4.2 Connect the regulator

Remove the gas cylinder from the strap. Make sure the regulator knob is turned fully anti-clockwise to the end-stop before fitting. Screw on the regulator (clockwise). Be aware that some CO₂ may be discharged from the connection to the regulator as the cylinder and the regulator are assembled together. Any CO₂ released will be cold. Screw on the regulator to stop this leakage.

Note the leaking CO₂ will be cold.

Note Two plastic seals are supplied with a new regulator. Only one is required, the other is supplied as a spare part.

4.3 Connect the gas hose

Connect the threaded end of the braided gas hose to the regulator. Then connect the John Guest fitting to the top of the Command-Centre™ via connection marked 'CO₂ IN'

To turn the gas on, rotate the black knob on top of the cylinder clockwise. Then adjust the outlet pressure, by rotating the regulator knob clockwise to between 2.7- 3.0 bar (green zone).

Note The arrow should sit in the green zone of the regulator gauge; it should not fall in the red or yellow zones.

4.4 Test for gas leaks

Using soapy water perform a leak test. Apply the soapy water to the gas connections using a sponge or brush. If any bubbles appear and grow, there is a gas leak at the connection. Clean away the soapy residue and tighten or refit the leaking connection. Make sure the gas is turned off when tightening or refitting the leaking connection.

Refit the gas bottle to the velcro strap. Ensure the bottle is in an upright position

Note Care must be taken when working with high pressure CO₂, and in no cases should the normal operating pressure of between 2.7- 3.0 bar be exceeded.

CO₂ Regulator

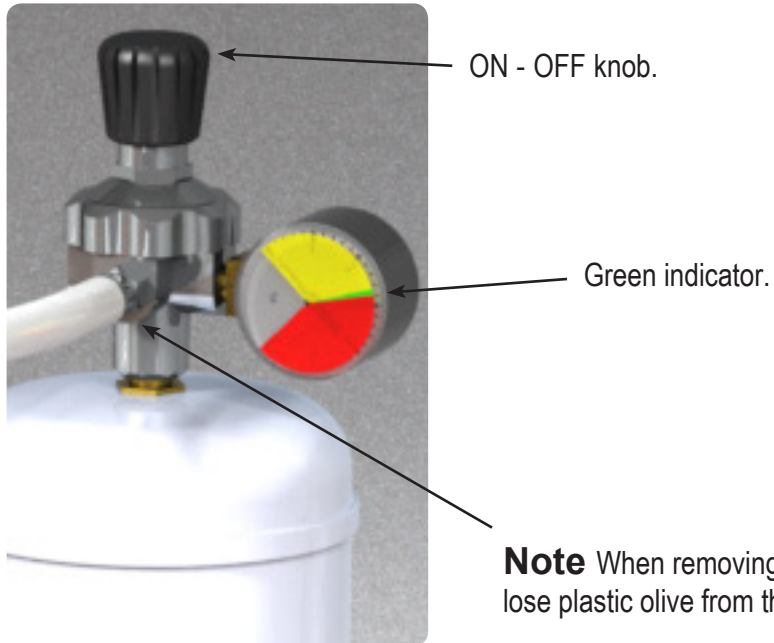

Leak Test

After replacing a cylinder or after making a gas connection, perform a leak test

Stage 1

1. Turn the gas off.
2. Using soapy water applied with a sponge, or with a brush, cover all of the gas joints with a liberal amount of suds.



Good seal joint

Stage 2

1. Turn the gas on.
2. Adjust the pressure to between 2.7- 3.0 bar.
3. Inspect the joints for leaks.
4. If any bubbles appear to grow, the joint will need to be resealed and tested again.



Faulty seal joint

Section 5

Command-Centre™ installation

Note Also refer to 803341UK Tap installation manual (supplied with the tap) in conjunction with this manual when installing the HydroTap® system.

5.1 External bypass valve

The diverter bypass valve allows the user to choose to have the boiling feed water bypass the internal filter and only be filtered by the external filtration. This diverter valve is located at the rear panel of the Command-Centre™, see the diagram below.

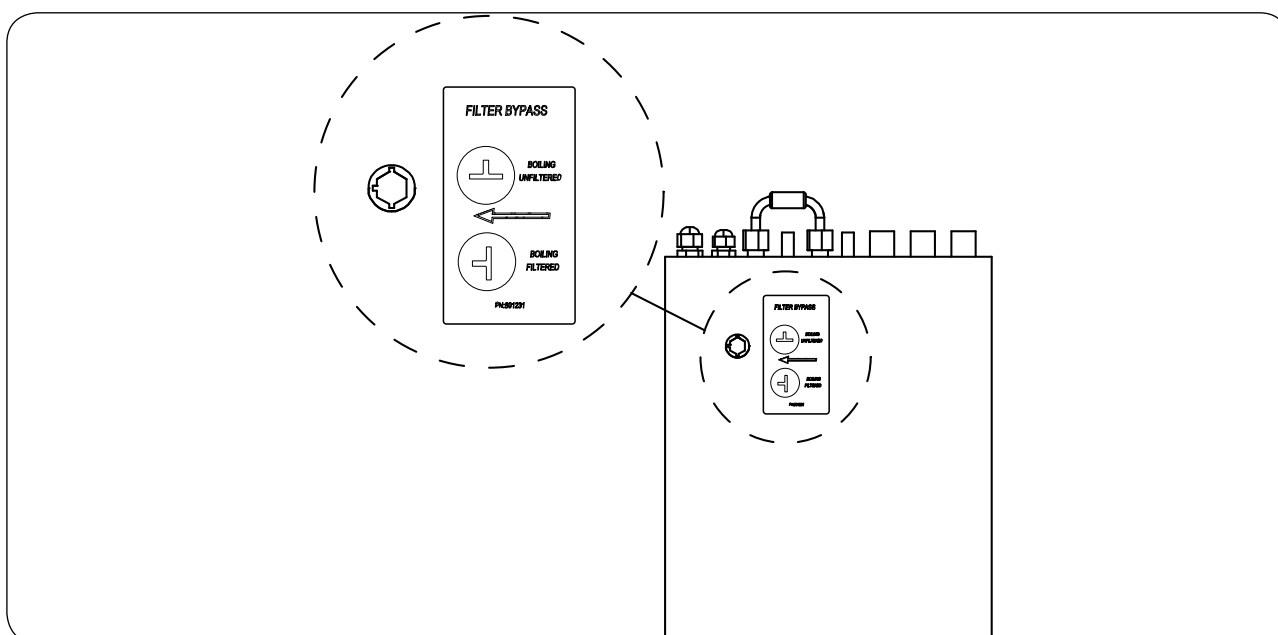

Check the table below to determine which filter bypass position you need for your product.

If no external filter is installed, select position A

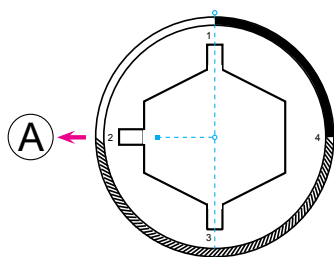

If an external filter is installed, select position B

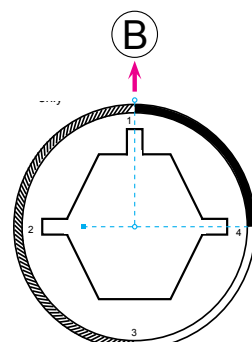

Leave in position **A** until after commissioning (section 6). Select position **B** if a scale filter is fitted, before flushing the scale filter as described on page 15.

5.2 Braided hose fitting

Install the mains water braided hoses to the Command-Centre™ before locating in place.

Installation instructions

5.3 Boiling, chilled and sparkling HydroTap®G4 models Refer to 803341UK Tap installation instructions, (for Arc / Cube also refer to the tube kit assembly instructions) supplied with the tap.

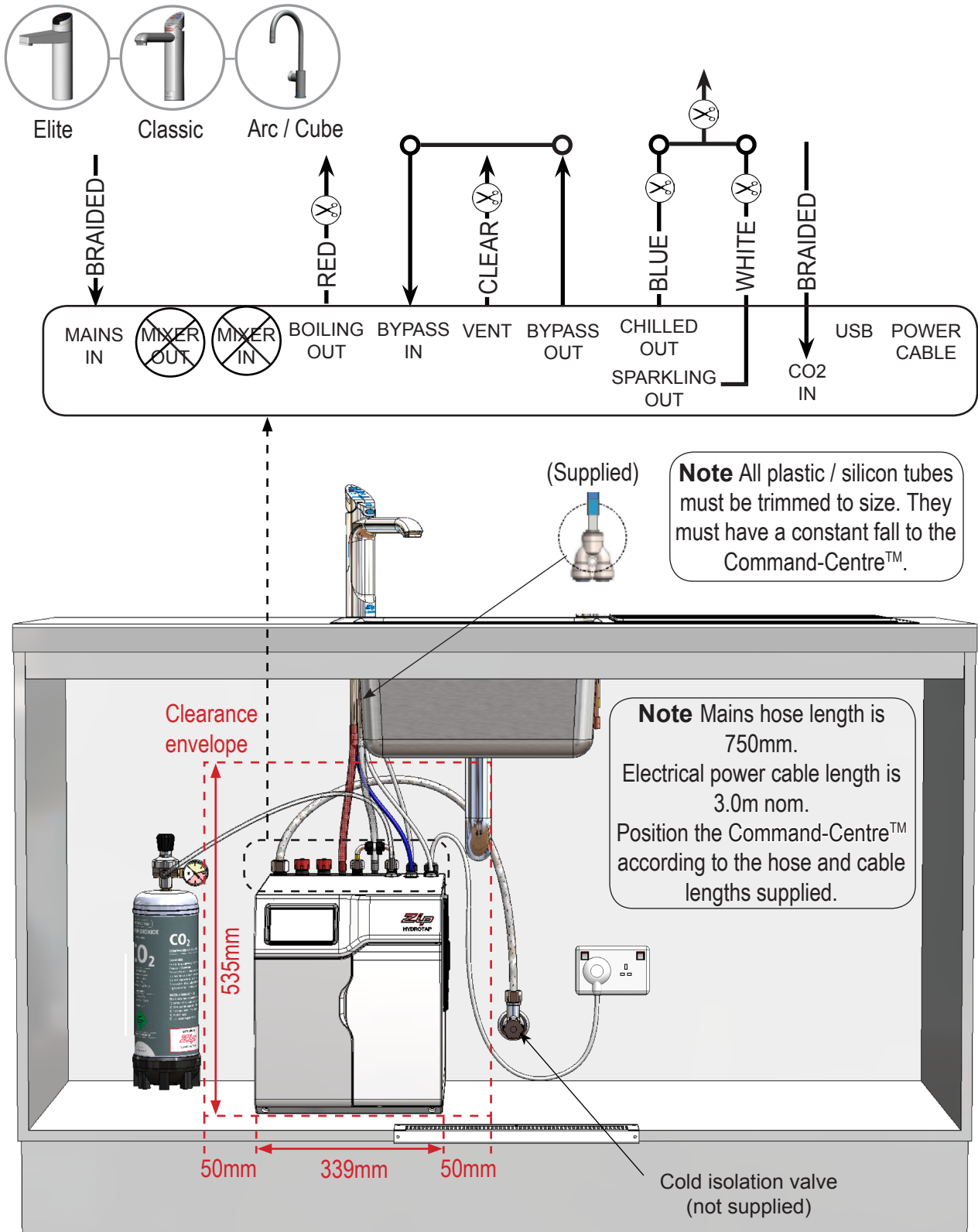

Note Neither the braided hoses or the tubes supplied with the tap can be lengthened. Take time to consider hose lengths when determining the mounting positions and cover the chilled and sparkling pipes with the insulation provided.

⊗ Not required for standard BCS HydroTap®G4 models.

Installation instructions

5.4 All-in-One 'Mains' tap Refer to 803341UK Tap installation instructions supplied with the tap.

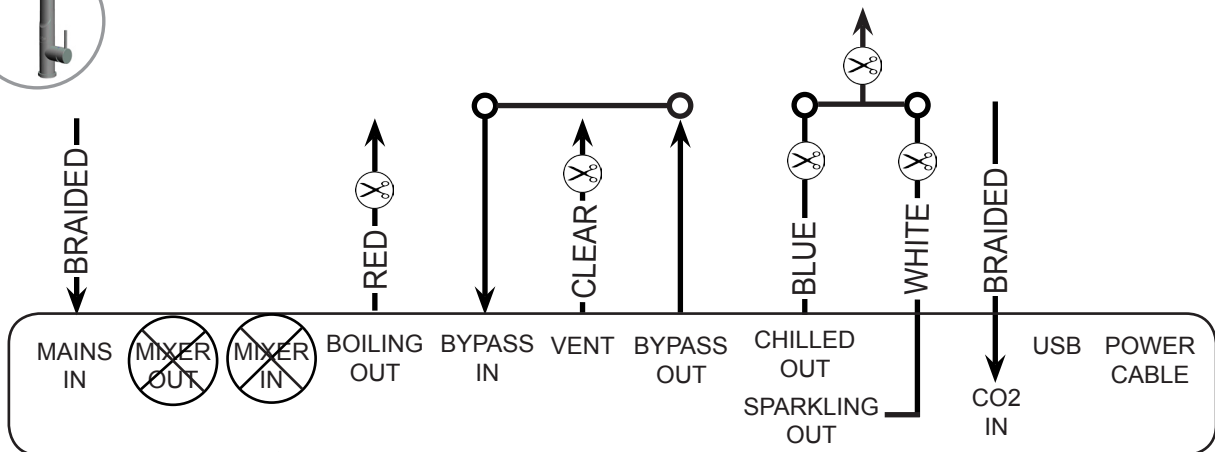

Note Mains hose length is 750mm.
Electrical power cable length is 3.0m nom
Position the Command-Centre™ according to the hose and cable lengths supplied.

Note All plastic / silicon tubes must be trimmed to size. They must have a constant fall to the Command-Centre™.

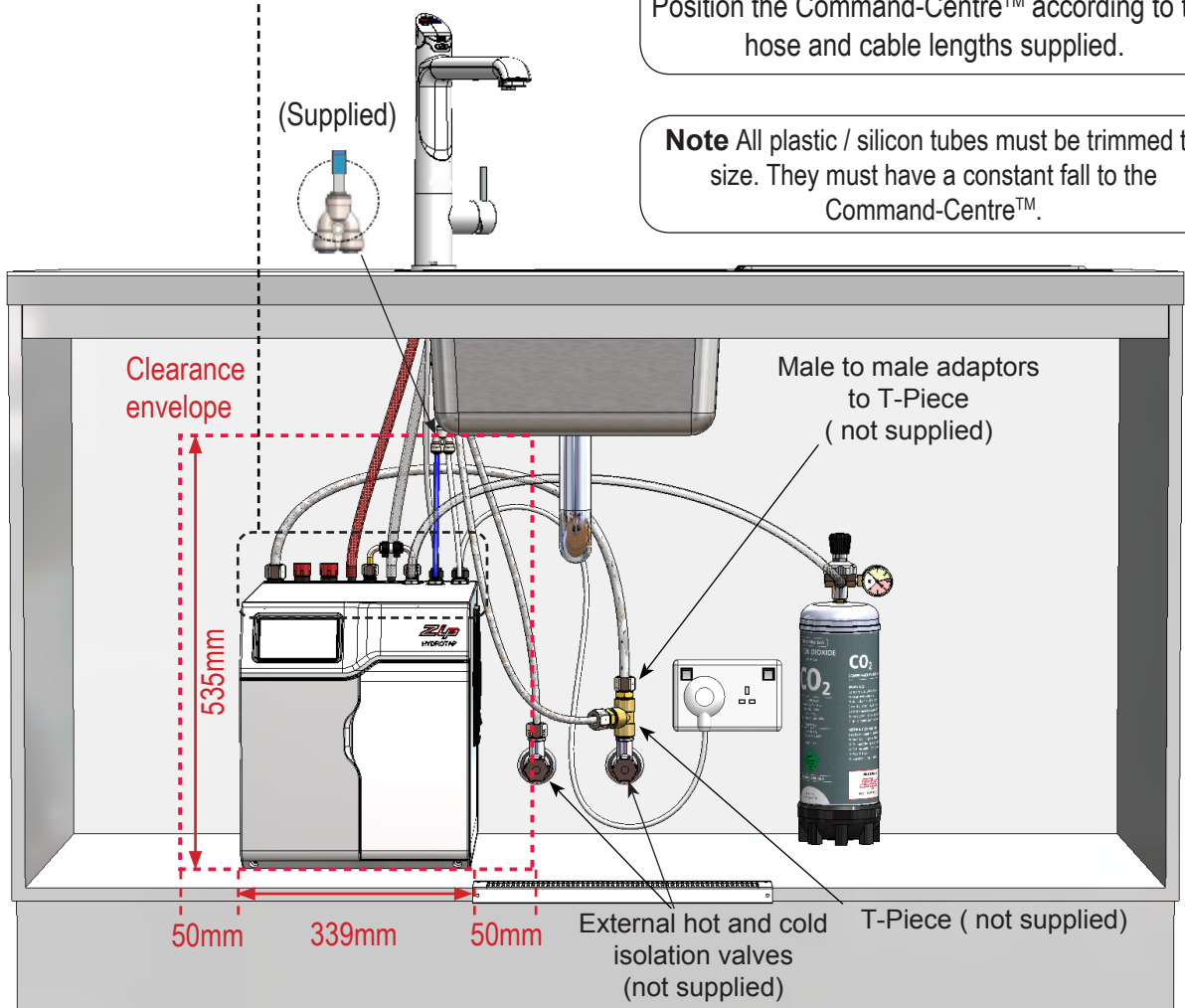

Note Neither the braided hoses or the tubes supplied with the tap, booster and ext. filter can be lengthened. Take time to consider hose lengths when determining the mounting positions for the different options, also ensure that the chilled and sparkling pipes are covered with the insulation provided.

Not required for AIO mains pressure HydroTap®G4.

Installation instructions

5.5 All-in-One 'Vented' tap Refer to 803341UK Tap installation instructions supplied with the tap.

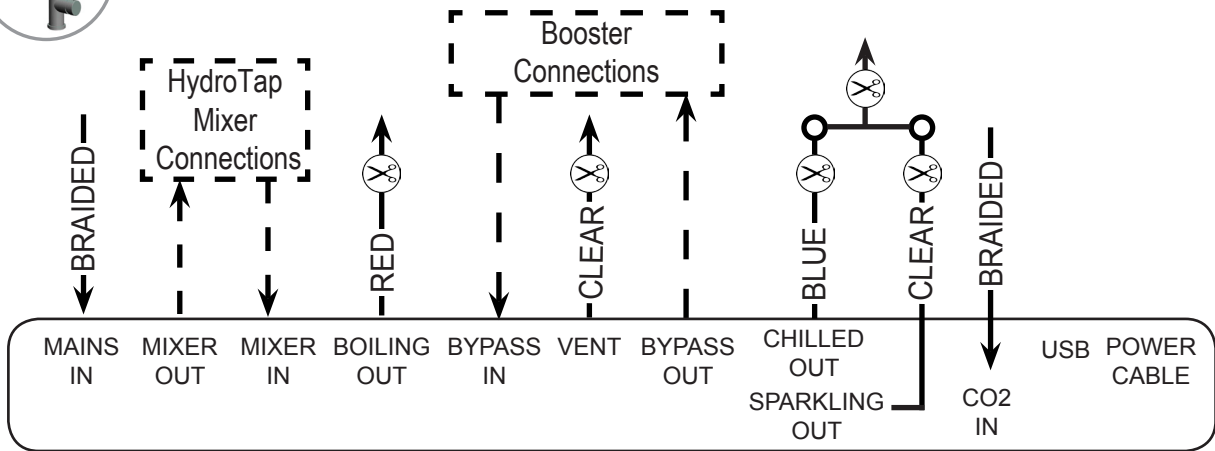

Note Mains hose length is 750mm. Electrical power cable length is 3.0m nom. Position the Command-Centre™ according to the hose and cable lengths supplied.

Note All plastic / silicon tubes must be trimmed to size. They must have a constant fall to the Command-Centre™.

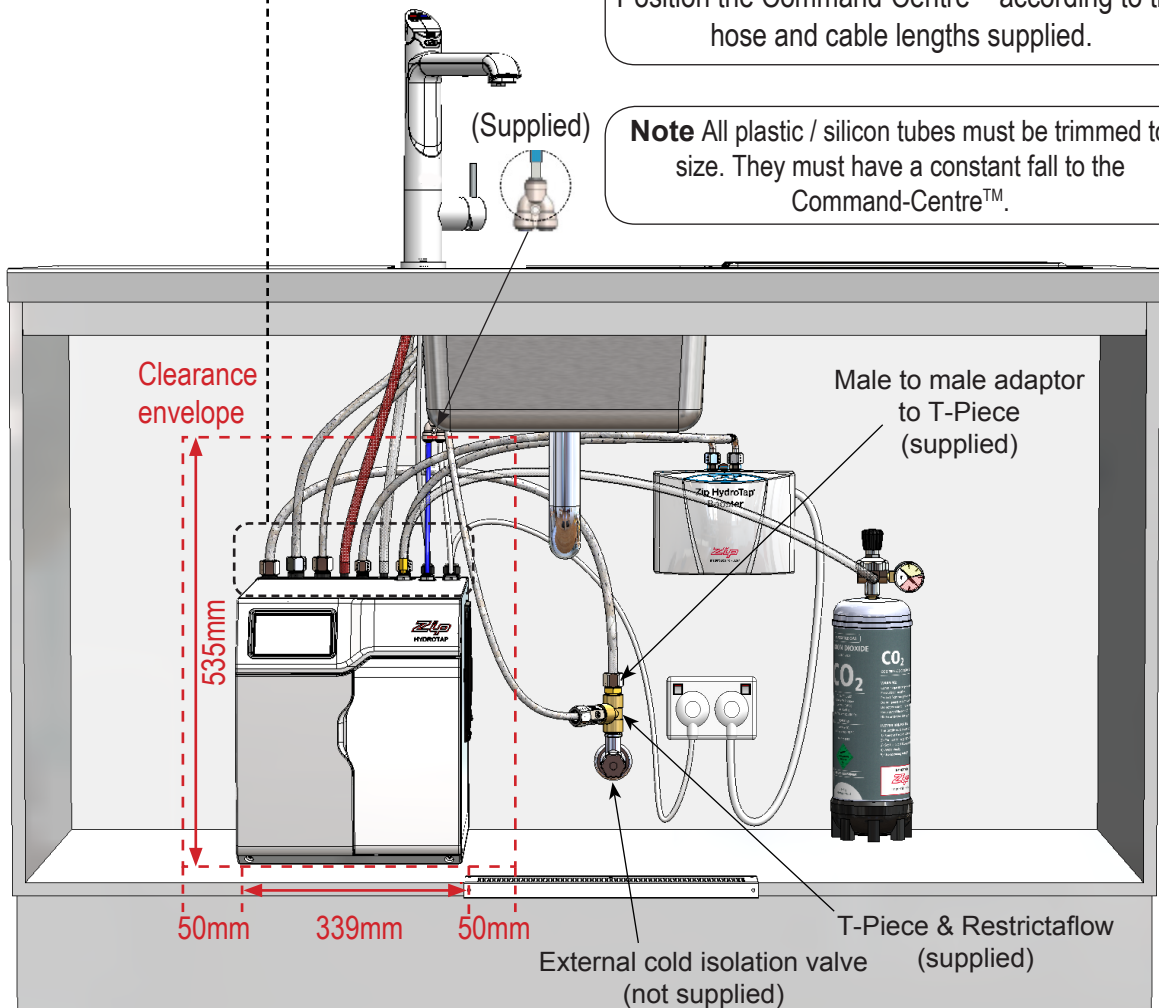

Note Neither the braided hoses or the tubes supplied with the tap, booster and ext. filter can be lengthened. Take time to consider hose lengths when determining the mounting positions for the different options, also ensure that the chilled and sparkling pipes are covered with the insulation provided.

Installation instructions

5.6 Boiling, chilled and sparkling HydroTap®G4 and mixer taps *Refer to 803341UK Tap installation instructions (for Arc / Cube also refer to the tube kit assembly instructions) supplied with the tap.

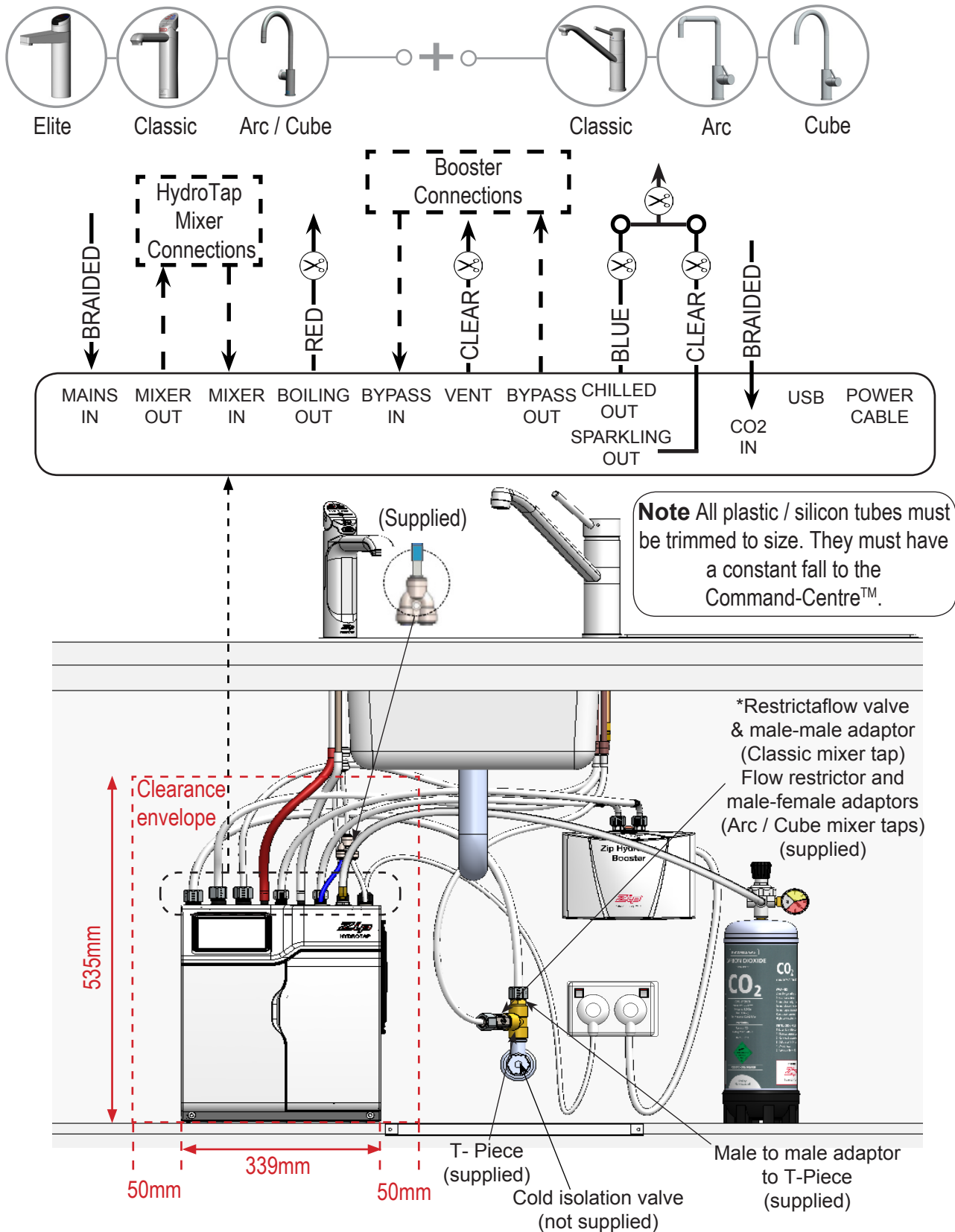

Note Neither the braided hoses or the tubes supplied with the tap and booster and ext. filter can be lengthened. Take time to consider hose lengths when determining the mounting positions for the different options, also ensure that the chilled and sparkling pipes are covered with the insulation provided.

Section 6

Commissioning

The HydroTap®G4 is now ready to be commissioned.

- Turn on the power, gas and water and check for any leaks.
- Familiarise yourself with the operation of the HydroTap®G4 in preparation for use (see user guide).
- Follow the installation instructions below (and review section C of the user guide).
- After commissioning, the system may be customised by selecting further options in section G - Settings, of the user guide.

Commissioning

6.1 Select the language

Initial commissioning screen

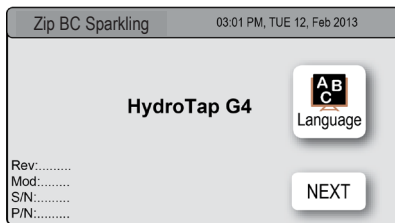

Language selection screen

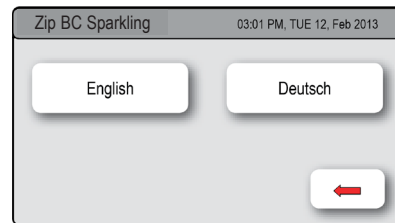

6.2 - CO₂ purge

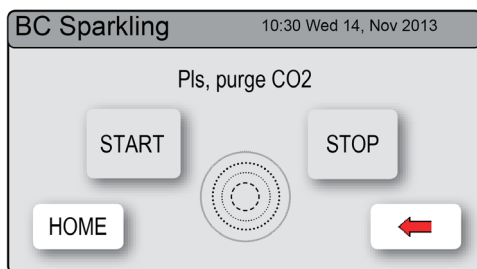
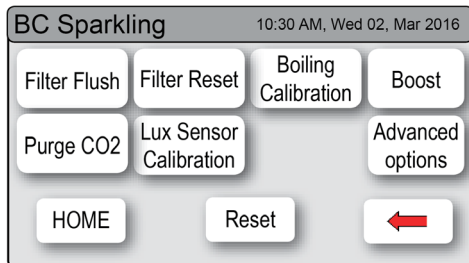

- Press the [MENU] button for main menu.
- Press the [Install] button.
- Press the [Purge CO] button.
- In the next screen, press the [START] button to commence the purging process.
- You will hear the CO₂ gas running through the tap.
- Run for 10 seconds to fully purge the CO₂.
- Press the [STOP] button to stop the purge.
- Press [Next] for filter flush screen.

6.3 - Filter flush

Have a bucket or similar container (not supplied) at the ready to hold a quantity of water that will be ejected while the filter flush mode is in operation. Open the filter access door on the front of the HydroTap®G4 and the filter cartridge will be exposed. Located to the rear right hand side of the cartridge is a flush line, approx 600mm long and the flush line stop cock. Place the free end of the flush line into the bucket or container (not supplied).

Note At first commissioning, the system will select the filter flush screen automatically after CO₂ purge.

Commissioning

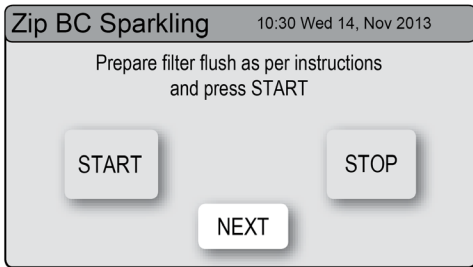

- Press [START] / [STOP] button to start and stop the filter flush.
- Open the flush stop cock.
- Allow at least 10 litres of water to flush through the filter.
- Once the filter flush is finished, Close the stop cock then press [STOP] to end filter flush mode.
- Press [NEXT] for the boiling calibration screen.

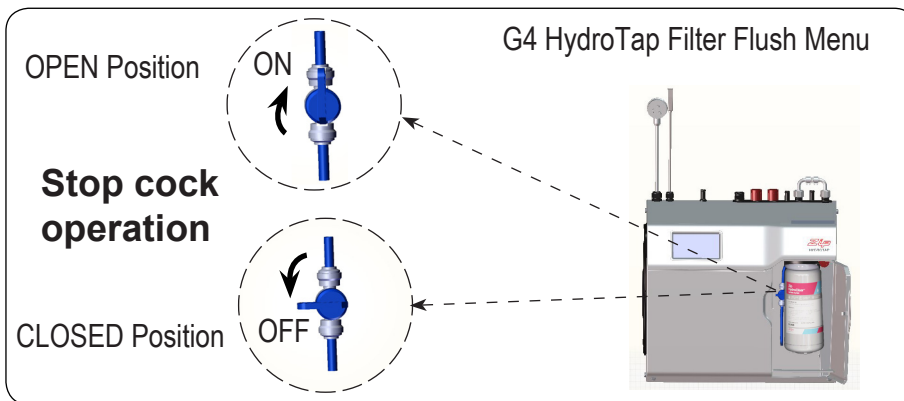

6.4 - Boiling calibration (boiling models)

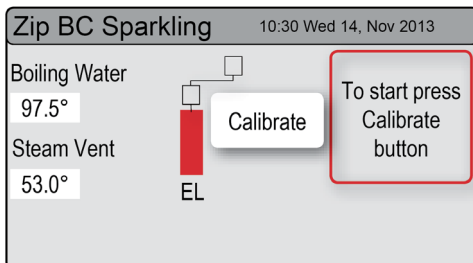

- Press the [Calibrate] button and the system will commence the boiling calibration procedure. This will take approx 5-6 minutes.

6.5 - Booster

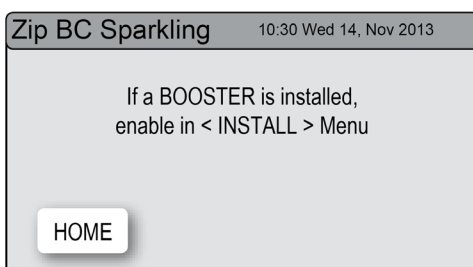

- Upon completion, a booster reminder screen will appear and allow you to return home by pressing the [HOME] button.
- Check the date and time settings (see note below).

Note failing to make the correct selection for the booster will affect product performance.

Note Depending on your location you may need to re-set the internal clock. See section G of the user guide to check and if necessary, reset the date and time for your time zone.

Commissioning

6.6 - To enable a booster, when installed

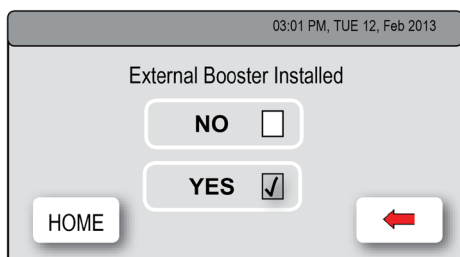

- Press the [MENU] button for main menu.
- Press the [Install] button.
- Press the [Boost] button.
- In the next screen, select [YES] to enable the booster.
- Before connecting the power to the booster, water must be run through for a min. of 30 seconds to purge. Run the boiling tap for 30 seconds and the allow the tank to refill.
- Dispense boiling water for 30 seconds and check the booster outlet hose is warm when the boiling water tank is replenishing.

Note For any subsequent filter changes or any operational procedures, please refer to the user guide, located inside the filter housing access door.

6.7 - Safety sensor calibration

Light intensity varies from site to site, therefore it is recommended that a re-calibration be performed at the time of the installation.

All direct sunlight must be shaded from the HydroTap®G4, during the calibration. This can be achieved by closing any nearby curtains, blinds, etc.

Procedure

- Shield the HydroTap®G4 from direct sunlight.
- In normal operating mode turn the power off.
- Pull both tap levers to the forward position.
- Turn the power on.
- The safety sensor will calibrate.
- Return the levers to the neutral position.

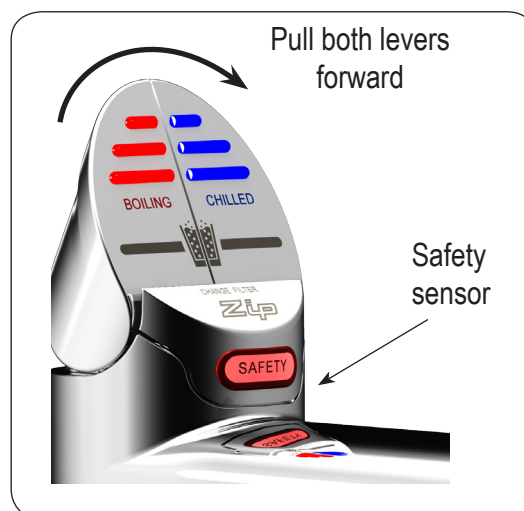

Trouble shooting

System fault message	Possible cause	Solutions
Power Board Fault	Electrical disruption	Check power supply and all fuses
Interface Fault	Internal fault	Call Zip service
Level Board Fault	Internal fault	Call Zip service
Condenser Screen Blocked	Blocked air filter	Remove blockage / clean filter / check user guide
Water leak, Isolate Mains	Water leak	Turn off mains water supply / call for service
Compressor Over Run	Compressor too hot	Check ventilation
Water Supply Failure	No water	Check water supply is turned on
Hot Sensor Open	Internal fault	Call Zip service
Hot Sensor Closed	Internal fault	Call Zip service
Cold Sensor Open	Internal fault	Call Zip service
Cold Sensor Closed	Internal fault	Call Zip service
Flood Sensor Open	Internal fault	Call Zip service
Condenser Sensor Closed	Internal fault	Check ventilation / Call Zip service
Condenser Sensor Open	Internal fault	Check ventilation / Call Zip service
Heater Driver Fault	No hot water	Call Zip service
Compressor. Driver Fault	No chilled water	Call Zip service
Hot Sensor Degraded	Internal fault	Call Zip service
Condenser Overtemp	Blocked air filter	Remove blockage / Clean filter / check user guide
A DC pump is faulty	Internal fault	Call Zip service
Steam is too cool	Internal fault	Call Zip service
Steam Sensor Open	Internal fault	Call Zip service
Steam Sensor Closed	Internal fault	Call Zip service
Over Steamed	Internal fault	Call Zip service
Hot Tank Overfilled	Internal fault	Call Zip Service
Comp Fuse/Driver Fault	Internal fault	Call Zip Service
Hot tank under filled	Hot tank under filled	Check water supply
Boil dry protection	Safety activated	Turn OFF / On power to reset
Flash Mem corrupted	Internal fault	Call Zip Service
Flow Sensor Fault	Internal fault	Call Zip Service

Call an electrician, a plumber, or Zip on 0345 6 005 005 for assistance, service, spare parts or enquiries.

End of life disposal



The use of this crossed out wheeled bin logo indicates that this product needs to be disposed of separately to any other household waste.

Within each of the European Union member countries, provisions have been made for collection and recycling of unwanted electrical and electronic equipment. In order to help preserve our environment we ask that you dispose of this product correctly. Please contact Zip Customer Service on 0345 6 005 005 for advice.

Warranty

Certain warranties may be implied by law into your contract with Zip. The warranty provided below is additional to these implied warranties and nothing set out below shall limit your statutory rights or rights at law. Zip Heaters (UK) warrants that, should the hot tank fail within five years of installation subject to satisfactory maintenance and registration of the product, or any part fail within three years of installation, the part will be repaired or replaced free of charge by Zip, its distributor or service provider, (except as set out below), provided the appliance is installed and used strictly in accordance with the instructions supplied, and that failure is not due to accident, misuse, abuse, unsuitable water conditions, or to any alteration, modification or repair by any party not expressly nominated by Zip.

No costs are payable by the customer other than any mileage or travelling-time charges incurred by a Zip service provider or the cost of removal, cartage and re-installation of any component of the appliance if it needs to be returned for repair to Zip or its distributor.

This warranty does not cover damage resulting from non-operation of the appliance, the use of non authorised parts or consequential damage to any other goods, furnishings or property.

No warranty applies to the life of any filtration cartridge installed with the appliance as cartridge life may vary according to water quality and the rate of water consumption.

Zip does not exclude, restrict or modify any liability that cannot be excluded, restricted or modified or which cannot, except to a limited extent, be excluded, restricted or modified as between the owner or user and Zip under the laws applicable.

Furthermore this warranty does not displace any statutory warranty, but, to the extent to which Zip is entitled to do so, the liability of Zip under any statutory warranty will be limited at Zip's option to the replacement of the appliance or supply of equivalent appliance, the payment of the cost of replacing the appliance or acquiring an equivalent appliance, or the payment of the cost of having the appliance repaired or the repair of the appliance.

HydroTap®G4 residential models are designed specifically for use in a domestic environment and inappropriate installations such as in a commercial location will invalidate the warranty.

Registering your purchase.

Registering your Zip installation on the Zip website may help to establish date of installation should it become necessary to service the appliance under terms of the Zip warranty. To register your installation go to www.zipwater.com/uk and look under the heading "Warranty".

Contact details

Head office

Zip Water UK
14 Bertie Ward Way
Dereham
Norfolk
NR19 1TE

Website: www.zipwater.com/uk
Email: sales@zipindustries.co.uk
Facsimile: 01362 692 448
Telephone / Mobile 0345 6 005 005

The standard cup referred to in this publication is 167 ml (6 fl oz).

The standard glass is 200 ml (7 fl oz).

The terms "Zip" and "HydroTap" are registered trade marks of Zip Heaters (Aust) Pty Ltd.

Zip products described in this publication are manufactured under one or more of the following patents: AU675601, AU637412, AU635979, GB0422305, GB2065848, US4354049, US5103859, US5099825 and SA2006/08043. Other patents are in force and patent applications are pending.

