



*Zonar Connect*® Installation/User Guide



REV: 09/16/16



# Zonar Connect®

## Installation/User Guide

### Introduction

## Zonar's Zonar Connect Tablet Hardware Installation Tips For Professional Installers

Zonar equipment will provide years of reliable service if properly installed and maintained. Zonar equipment is typically installed in heavy vehicle applications and is often subjected to extreme temperatures, dust, dirt, vibration, and shock. Proper installation is the critical first step to equipment longevity and optimal performance.

This guide is meant to be a general guideline for the professional installer and technician. While we attempt to point out the most common installation questions and issues; common sense, good housekeeping procedures, attention to detail, safety adherence, and technical competence of the professional installer are critical for a successful installation.

Please refer to your specific vehicle manufacturer guidelines for the installation of electrical components and wiring.

Details on operating the Zonar Connect and its built-in applications and software are given in this Zonar Connect User's Guide.

A professional team of Zonar support technicians and engineers are available to answer your installation questions. Contact Zonar at 1-877-843-3847 or by email at [customercare@zonarsystems.com](mailto:customercare@zonarsystems.com).

Thank you,

A handwritten signature in black ink that reads "Andre J Horochiwsky". The signature is written in a cursive, flowing style with a long horizontal stroke extending to the right.

Andre J Horochiwsky

Technical and Training Manager – Zonar

# Zonar Connect®

## Installation/User Guide

### Table of Contents

|                                       |       |
|---------------------------------------|-------|
| Introduction                          | 2     |
| System Overview                       | 4     |
| Zonar's Zonar Connect Tablet          | 5     |
| System Specifications                 | 7     |
| Zonar Connect Install & Checkout List | 8     |
| Prerequisites & Reference Material    | 9     |
| Base Equipment                        | 10    |
| Equipment Dimensions                  | 11    |
| Power, Data & Optional                |       |
| Back-up Camera Connection             | 12    |
| General Guidelines                    | 13    |
| Mounting & Operation                  | 14-15 |
| Zonar Connect Installation Example    | 16    |
| System Installation Diagram           | 17    |
| System Check                          | 18    |
| Warranty & Notices - FCC Compliance   | 19-21 |

© 2016 Zonar Systems • EVIR, Z Pass, Ground Traffic Control and V3 are trademarks of Zonar Systems. RAM and WI-FI are third party registered trademarks of National Products Inc. and WI-FI Alliance respectively. All Rights Reserved.

Products and services protected by one or more of the following US patents: 6,671,646; 6,804,626; 7,557,696; 7,117,121; 7,362,229; 7,564,375; 7,680,595; 7,776,499; 7,808,369; 7,944,345; 8,106,757, plus EP 2756504.3 and the AU.

# Zonar Connect®

## Installation/User Guide

### System Overview

Real-Time Delivery of Engine Condition and Performance Data, Driver Performance and Location  
**Zonar Secure Services:** Encrypted Data Transmissions to **Customer On-Site Location**

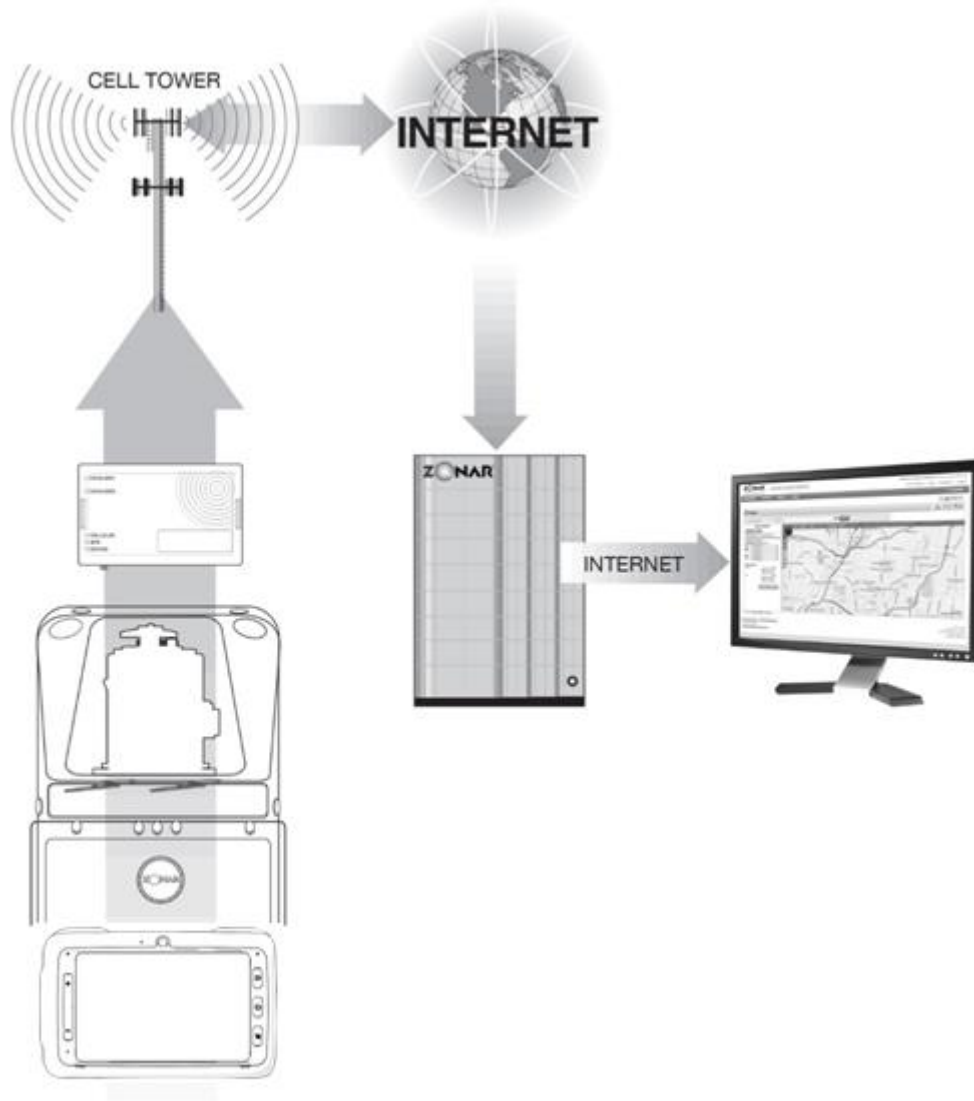

# Zonar Connect®

## Installation/User Guide

### Zonar's Zonar Connect Tablet All-in-One Device



Zonar's Zonar Connect Tablet is the most versatile mobile device in the transportation industry. Applicable to fleets of all vehicle types, this innovative platform works both inside and outside the vehicle to provide fleet managers valuable operational information. The Zonar Connect helps automate common processes offering the flexibility to create custom applications and integrating to maximize operational value.

Zonar's Zonar Connect Tablet features include:

- Driver Hours-of Service
- Verified Electronic Vehicle Inspections
- Two-Way Messaging
- Advanced navigation
- Visual driver feedback via the My Driving application
- Camera and video for documenting defects or damaged freight
- Driver friendly applications including web-browsing and Email access
- Flexible Android operating system

# **Zonar Connect**<sup>®</sup>

## Installation/User Guide

### **Important Notice**

It is the Owner's sole responsibility to install and use the Zonar products in a manner that will not cause accidents, personal injury or property damage. For the purposes of this notice, "Owner", "you" and "your" means the party (including any person authorized by that party to use and/or install the Product) that has either: (a) purchased the Product; or (b) leased the Product from Zonar Systems, Inc or its related companies. The Owner of this product is solely responsible for observing safe driving practices. The choice, location, and installation of all components of the Product is critical. If installation is not correct, the Product may not perform at its designed potential or specifications. If in doubt, consult your vehicle's manufacturer.

## System Specifications:

### Physical

|                    |  |
|--------------------|--|
| Mounting:<br>mount | Supplied dock and RAM®                                     |
| Weight:            | 1.5 pounds   |
| Dimensions:        | 8.0 x 5.3 x 1.0 inches<br>8.4 x 5.4 x 2.1 inches with dock |

### Environmental

|                                     |                                |
|-------------------------------------|--------------------------------|
| Operating Temperature<br>Docked:    | -4°F to 140°F (-20°C to 60°C)  |
| Operating Temperature<br>Un-Docked: | 14°F to 140°F (-10°C to 60°C)  |
| Storage Temperature:                | -40°F to 140°F (-40°C to 60°C) |
| Charge Temperature:                 | 32°F to 122°F (0°C to 50°C)    |
| Humidity:                           | 95% R.H., non-condensing       |
| Shock/Vibration:                    | SAE J1455, MIL-STD-202G        |
| EMC/EMI:                            | SAE J1113                      |
| ESD:                                | IEC 61000-4-2                  |
| IP Rating:                          | 54                             |

### RFID

|             |             |
|-------------|-------------|
| Frequency:  | 125 kHz     |
| Read Range: | 0 to 1 inch |

### Electrical

|          |                      |
|----------|----------------------|
| Battery: | 2760 mAh lithium ion |
|----------|----------------------|

### VOLTAGE

|                    |                                    |
|--------------------|------------------------------------|
| Operating Voltage: | 8 VDC to 30 VDC<br>vehicle battery |
|--------------------|------------------------------------|

### Typical current draw

| State                                  | Draw                    |
|--|-------------------------|
| Charge disabled                        | <1 mA                   |
| Charge enabled, Zonar Connect off      | 23 - 300mA              |
| Typical normal Zonar Connect operation | 400 - 600 mA Worst case |
|  | 1.0 A                   |

The Zonar Connect is configured to only charge the internal battery when the vehicle's engine is on and up to 30 minutes after the engine has been turned off.

# Zonar Connect®

## Installation/User Guide

### Zonar Connect Install & Checkout List



| Task #.   | Task  | Page # |
|-----------|---|--------|
| Complete? |   |        |
| 1         | Inventory all the Zonar Connect items   | 9      |
| 2         | Ensure V3 is connected to a minimum 1.5 Amp circuit (only required for the Zonar Connect operations) See V3 Installation Manual |        |
| 3         | Ensure V3 is fully functional (3 solid Green LED with engine running)   | 16     |
| 4         | Shut-off engine   |        |
| 5         | Disconnect vehicle battery (suggested)  | 13     |
| 6         | Disconnect 4 Pin connector at rear of V3  | 13     |
| 7         | Layout the Zonar Connect hardware and cables to desired location  | 13     |
| 8         | Install RAM mount and backing plate   | 13     |
| 9         | Route and connect the Zonar Connect Power/Data cable  | 13     |
| 10        | Re-connect vehicle battery  | 13     |
| 11        | Connect 4 Pin power connector into V3   | 13     |
| 12        | Start engine  |        |
| 13        | Ensure V3 has 3 solid Green LED's   | 13     |
| 14        | Snap the Zonar Connect into the dock (if it is not already there)   | 13     |
| 15        | Log into the Zonar Connect with ID number and PIN   | 17     |
| 16        | Perform the Zonar Connect system check  | 16     |
| 17        | Shut-off engine   |        |



# Zonar Connect®

## Installation/User Guide

### Prerequisites & Reference Material

#### Reference Material

- 1) Zonar's support website: <http://docs.zonarsystems.net>.

*Note: A user name and password are required to access this site.*

- 2) Please see "Zonar Troubleshooting Reference Guide" for any V3 or Zonar Connect issues you may encounter.

#### Prerequisites

- 1) The V3™ GPS unit must be fully installed, configured, checked-out and fully operational prior to installing the Zonar Connect. Please see the "V3 Installation and User Guide" on Zonar's support website.
- 2) The Zonar Connect requires coordination between Zonar and the customer for software setup. Please see "Zonar's Initial Setup Checklist" on Zonar's support website for a full listing of these tasks.

# Zonar Connect®

## Installation/User Guide

### Base Equipment

- A. Zonar's Zonar Connect Tablet
- B. The Zonar Connect Dock
- C. RAM Mount with Mounting Screws and Aluminum Backing Plate
- D. V3™
- E. Zonar Connect Power/Serial Cable
- F. AC/DC Power Adaptor (output 5V/2.5A) with a micro-USB cable (optional)

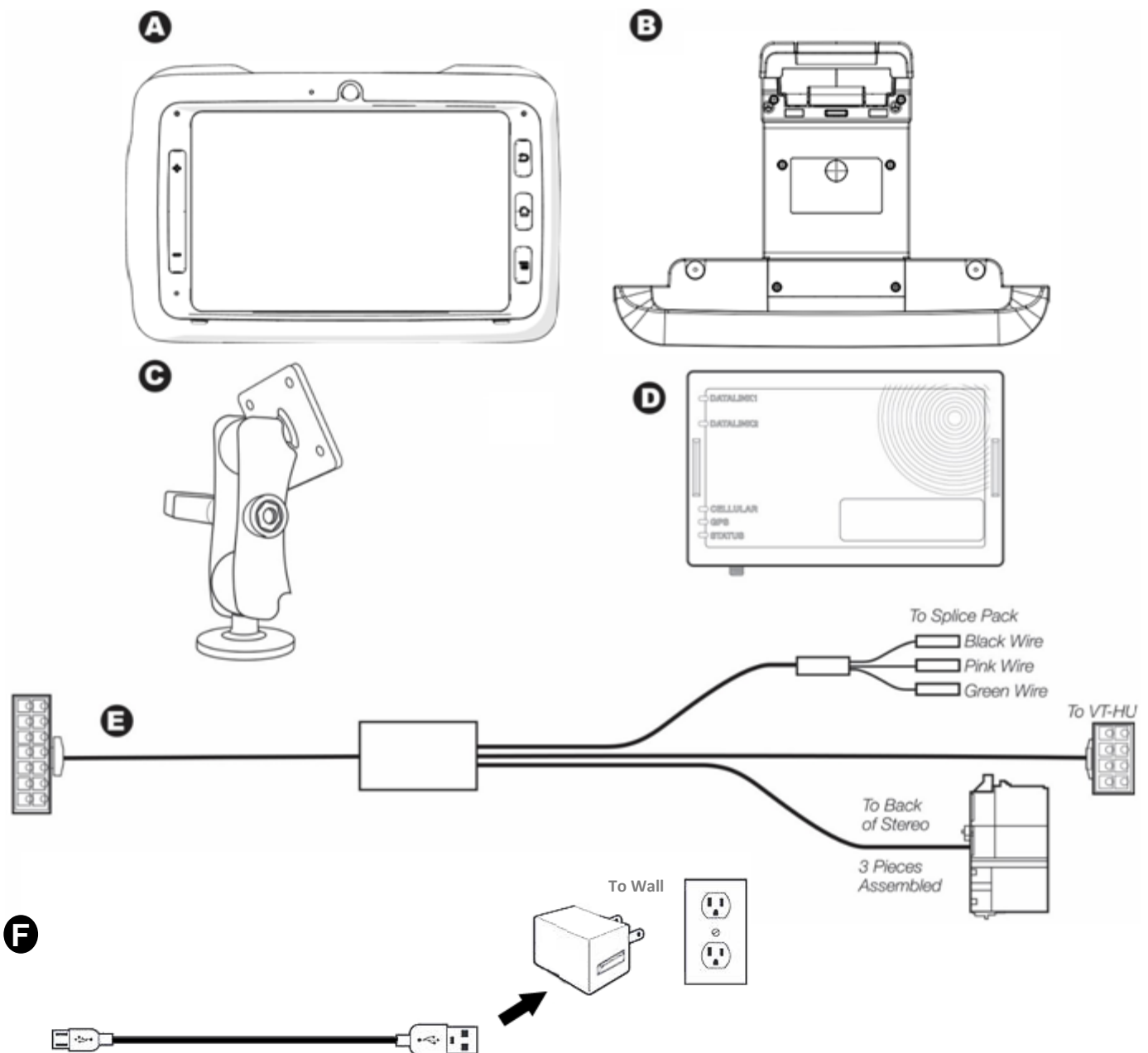

# Zonar Connect®

## Installation/User Guide

### Equipment Dimensions

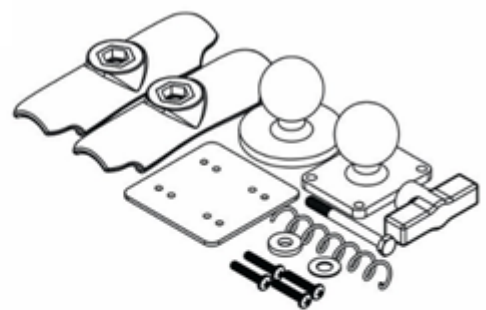
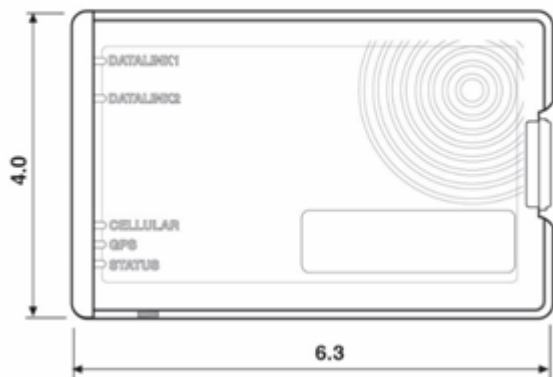
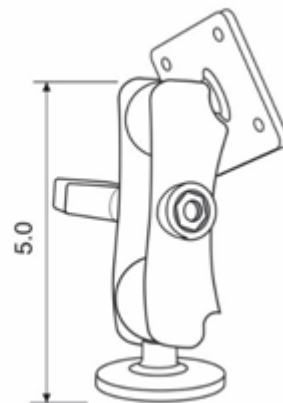
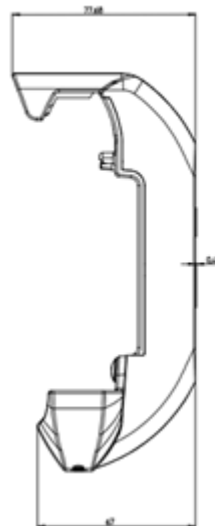
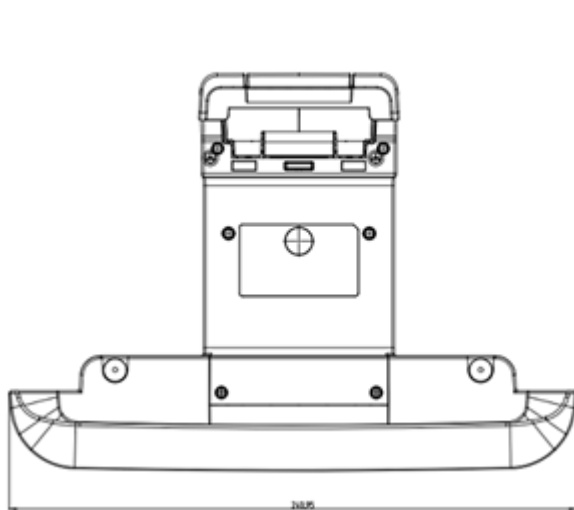
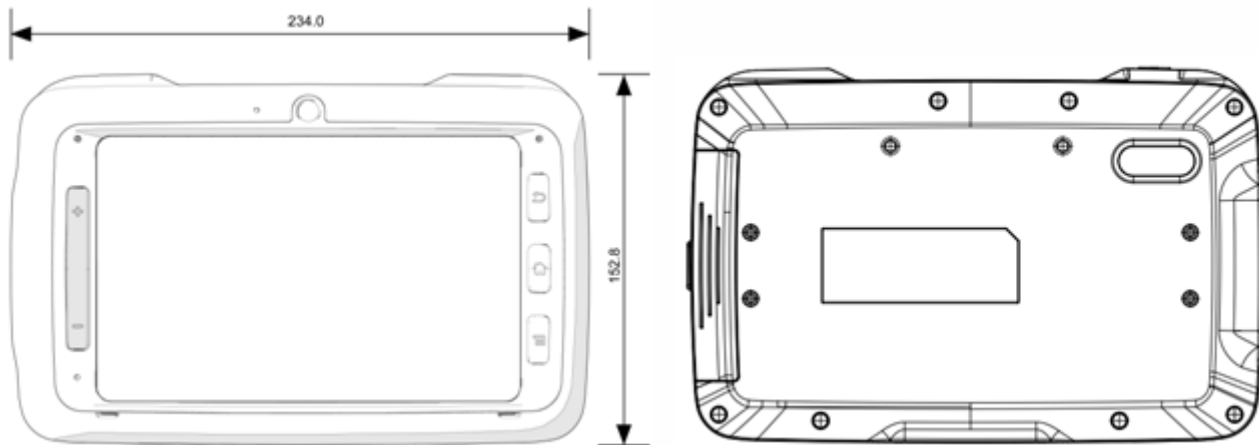

# Zonar Connect®

## Installation/User Guide

### Optional Camera Back-up Camera Information

Zonar's Zonar Connect Tablet is capable of automatically displaying video from 3rd party back-up cameras. The camera must only provide video feed when the vehicle is in reverse gear. The video feed must be turned off when the vehicle is not in reverse. Often this is accomplished by only supplying power to the back-up camera when the vehicle is in reverse. The Zonar Connect screen will automatically switch between computer and video display mode without user interaction.

While hooking a video feed from a backup camera into the Zonar Connect may provide a safety benefit, video feeds have the potential to be very distracting. Zonar strongly recommends that customers implement a thorough safety review before deciding to hook up any video feeds into the Zonar Connect. Customers assume all liability for use of any video feeds with the Zonar Connect.

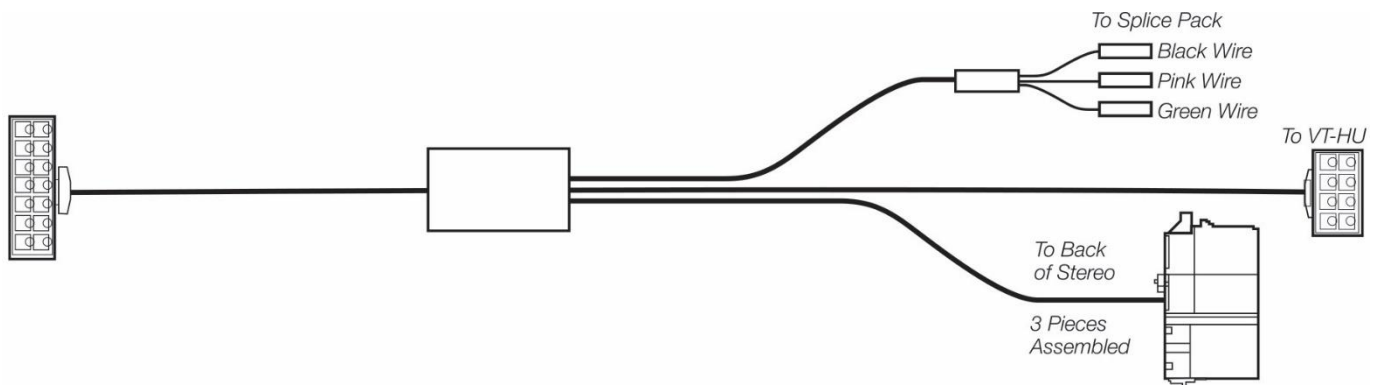

\*Contact Zonar or visit <http://docs.zonarsystems.net/> for questions and support.

# Zonar Connect®

## Installation/User Guide

### General Guidelines

#### Drill Holes

- 1) Do not drill into the Zonar Connect or the Zonar Connect dock unit. This will void the warranty.
- 2) Capture all drill chips during drilling operations. Do not allow chips to fall onto equipment, furnishings, etc.
- 3) Deburr all drill holes on both sides of drilled surface. Example deburr tool:

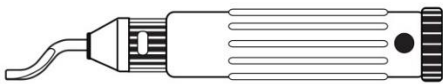

- 4) All drill holes must have a rubber grommet or similar anti-chaffing system installed to protect cable assemblies (e.g. plastic conduit).
- 5) Seal all penetration drill holes which may pass rain water.

#### Cable Management

- 1) Strain relieve and support all cable installations.
- 2) Avoid sharp bends and tight radius installations of cables.
- 3) Avoid moving components (e.g. doors, steering shafts, handles, fans, etc.).
- 4) Provide an adequate "Service Loop" i.e. "cable slack" to allow for servicing of equipment.
- 5) Avoid routing cables thru doors, windows, and other pinch points.
- 6) Avoid routing cables in high personnel traffic areas.
- 7) Avoid routing antenna cables near radio and PA equipment.

#### CORRECT

- Bend radius adequate
- Hole has grommet

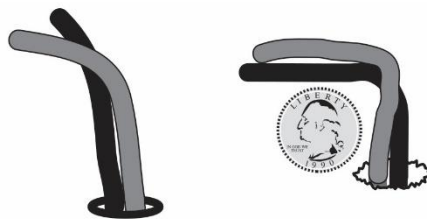

#### INCORRECT

- Bend radius too tight
- Hole has sharp edges
- Hole has no grommet

#### General Housekeeping

- 1) Capture all drill chips during drilling operations. Do not allow drill chips to fall onto electrical equipment, furnishings, heating ducts, etc. Magnets, sticky tape, vacuums, physical barriers, etc. may all be used to accomplish this task.
- 2) Remove excess sealant. Sealant should be debris/contaminant free (e.g. drill chips), consistent, and uniform in appearance.
- 3) Clip excess wire tie protrusions.

# Zonar Connect®

## Installation/User Guide

### Mounting & Operation

#### Mounting position considerations:

- 1) Verify placement acceptability with state DOT/Law Enforcement prior to installation.
- 2) Follow all general guidelines on page 12.

#### Do:

- 1) Mount in the vehicle at a convenient height and angle for drivers and co-drivers to access.
- 2) Ensure location of the installed Zonar Connect does not block driver view (including mirrors and gauges) or interfere with vehicle safe operation of the vehicle's controls.
- 3) Ensure that the placement of the Zonar Connect allows drivers/co-drivers to easily dock and undock the tablet.
- 4) Ensure mounting surface is strong enough to support RAM mount and the Zonar Connect.
- 5) Choose a location which does not impede driver/co-driver entry
- 6) Choose a location which is within easy reach of driver / co-driver, and within normal line-of-sight.
7. Lay all components out prior to installation to check for cable length and interference issues.

#### Don't:

- 1) Do not mount the Zonar Connect in an area that may interfere with the deployment of an air bag.
- 2) Do not install the Zonar Connect in a location that may impact the driver /co-driver in the event of an accident or sudden stop.
- 3) Do not mount the Zonar Connect in dirty or wet areas.
- 4) Do not mount the Zonar Connect in areas of direct sunlight
- 5) Do not install the Zonar Connect in front of an open AC or heater vent. If unable to install elsewhere, close the louvered vent the Zonar Connect is installed in front of.
- 6) Do not install the Zonar Connect near windows and vents which may pass rain water.
- 7) Avoid mounting the Zonar Connect in an area that may limit leg room or where the Zonar Connect may likely be used as foot, elbow, etc. rest.

#### Mounting Installation

Refer to mounting locations guide (see Fig. 15-1) for examples of ideal mounting locations. Mounting locations may vary based on the type of vehicle or driver requirements.

- 1) Attach RAM mount to a location visible and accessible to the driver.
- 2) Use backing plate to secure mount.

# Zonar Connect®

## Installation/User Guide

### Mounting & Operation - Cont.

- 3) Once mounting is securely installed, dock the Zonar Connect.

#### Wiring Installation

Refer to the cable guide (Fig. 3-1) for reference.

- 1) Disconnect vehicle battery (suggested).
- 2) Disconnect V3 4 Pin power.
- 3) Connect the Zonar Connect Power/Data cable to V3, the Zonar Connect dock, vehicle power and back-up camera (if required).

#### Operation

*Note: To learn how to operate the Zonar Connect's applications and software, please refer to the User's Guide, Quick Start Guide or the built-in Help Documents specific to the application.*

#### Operational Notes

- 1) The Zonar Connect requires a V3 to operate.
- 2) The Zonar Connect must be fully docked in order to send data to Zonar servers.
- 3) Sleep Modes:
  - A. The Zonar Connect enters sleep mode after 2 minutes of inactivity. This timeout can be adjusted to 30 seconds, 1 minute, 10 minutes or 30 minutes.
  - B. Power button ends sleep mode.
- 4) RFID Scanner's optimal range is 0-1".
- 5) Prolonged exposure to extreme temperatures can affect the Zonar Connect tablet's performance. See System Specifications.

# Zonar Connect®

## Installation/User Guide

### Installation Example

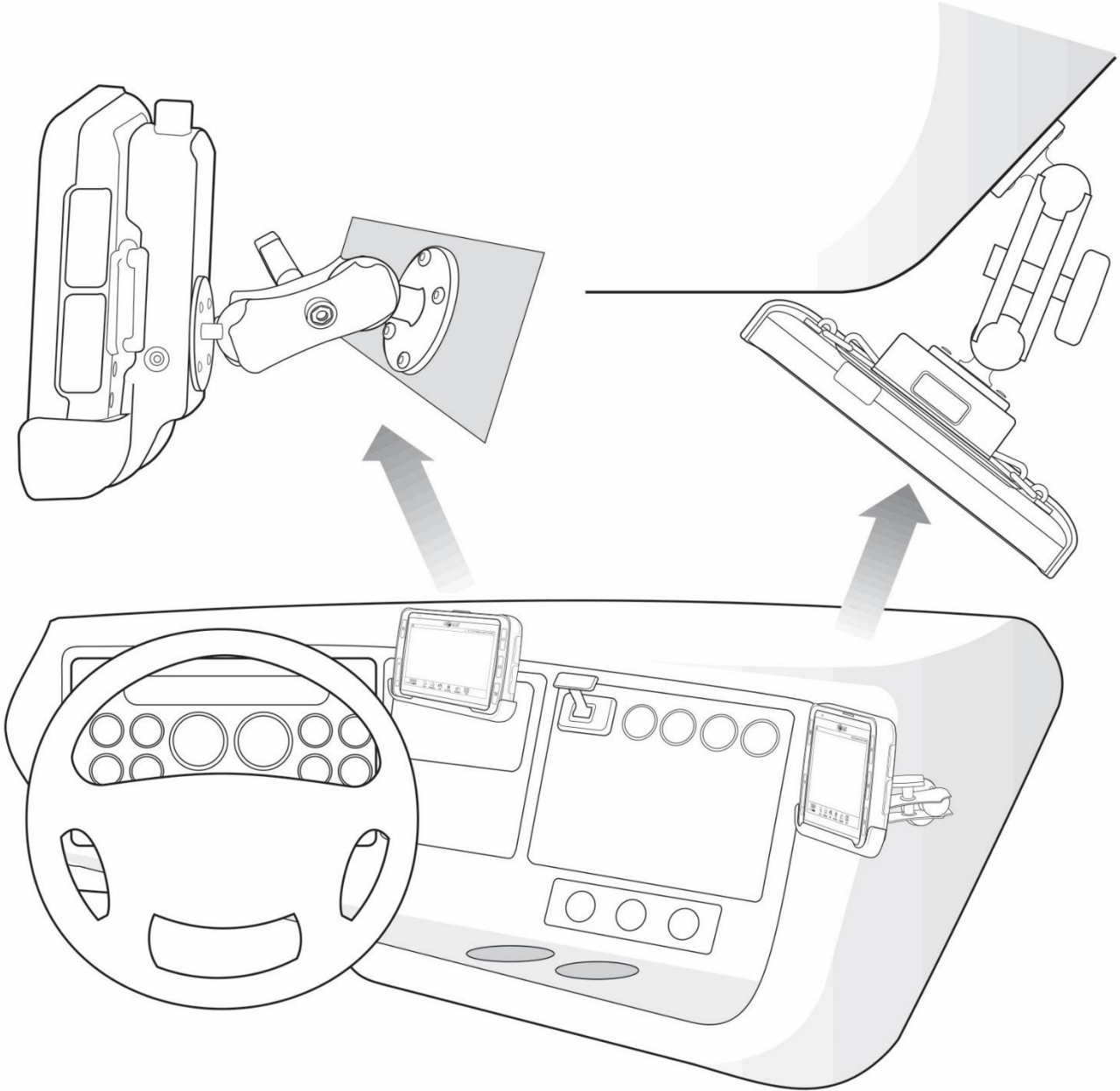

Figure 15-1



# Zonar Connect®

## Installation/User Guide

### System Installation Diagram

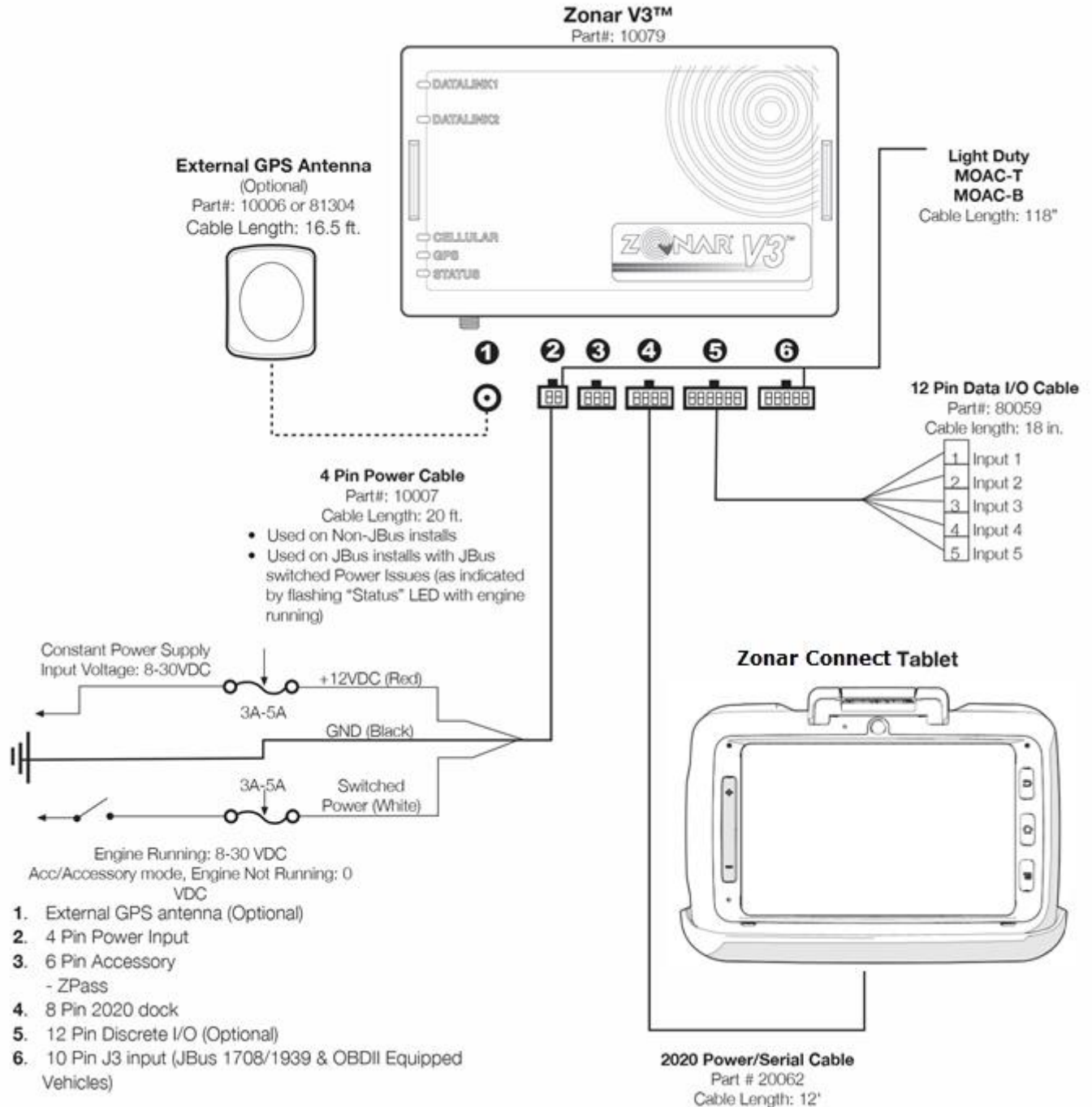

# System Installation Diagram (In door usage)

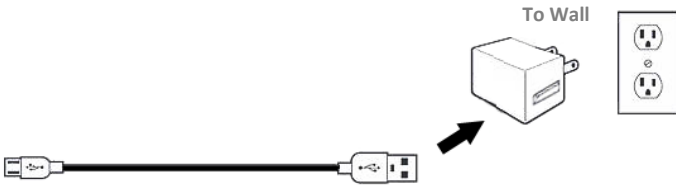

**Power Adapter/USB Cable**  
Part# 20083 / 20084  
Cable Length: 1.5meter

# Zonar Connect®

## Installation/User Guide

### System Check: Minimum requirements

*Note: If the terms and functions listed on this page are unfamiliar to you. Please refer to page 8 “prerequisites and reference material” for instructions on how to accomplish each step. We highly recommend referring to the Zonar Connect “Quick Reference Guides”.*

- 1) An installer must perform a full system check to verify the proper Zonar Connect connection and operation
- 2) Start vehicle engine and ensure the following LEDs are:
  - A. Cellular - Solid - Green
  - B. GPS - Solid - Green or Orange
  - C. Status -Solid - Green
- 3) Power on the Zonar Connect and allow the device to boot up to the login screen:
  - A. ID: Scan driver card or manually enter driver ID
  - B. PIN: Manually enter PIN (Personal Identification Number)
- 4) Connect to WI-FI® (Highly suggested)
- 5) Ensure all purchased application(s) are present on the Zonar Connect. They may include one or more of the following applications:
  - A. Zlogs - Hours of Service application
  - B. Navigation - Mapping and turn-by-turn direction application
  - C. Messaging - Two way communication between Asset and Dispatcher
  - d. EVIR® - Asset inspection application
- 6) Application checkout:
  - A. ZLogs® - Not required
  - B. Navigation - Open application, ensure map is oriented to your location. This ensures the V3 is properly passing Latitude / Longitude information to the Zonar Connect
  - C. Messaging - Ensure message can be sent:
    1. From the Zonar Connect to Dispatcher - Ensure dispatcher can read the message
    2. From Dispatcher to the Zonar Connect - Ensure message can be read on Zonar Connect
  - D. EVIR
    1. Perform a full inspection using the Zonar Connect and RFID tags
    2. Verify with dispatcher that inspection successfully uploads to Ground Traffic Control after Zonar Connect is placed back into the dock.
- 7) Back-Up Camera (if equipped)
  - A. Apply vehicle brake(s)
  - B. Put transmission in “reverse”, and the Zonar Connect will switch over to rear camera view
  - C. Take transmission out of “reverse” and the Zonar Connect will revert back to computer screen view

# Zonar Connect®

## Installation/User Guide

### Warranty & Notices - FCC Compliance

#### Limited Warranty

**LIMITED WARRANTY:** Zonar warrants that the Hardware provided under this agreement is free from all material defects in workmanship under normal use and service. Zonar's warranty period for its Hardware is as follows:

**V3™ Product Line - 5 Years • Zonar Connect® - 1 Year • EVIR® - 3 Years • All Other Hardware - 1 Year**

The above warranty periods run from the date of shipment. Provided that the Hardware is used and handled as intended, Zonar will replace any failed or functionally impaired Hardware with equivalent Hardware in terms of performance and functionality.

This warranty does not apply to any Hardware that has been misused, altered, willfully abused or that has been damaged due to improper installation by the customer. Hardware installations must follow Zonar's equipment specific installation guidelines. If product returned is determined to be damaged due to any of the aforementioned circumstances, the Customer will be charged the price of a refurbished unit plus shipping and handling.

CUSTOMER'S SOLE AND EXCLUSIVE REMEDY AND ZONAR'S ENTIRE OBLIGATION UNDER THESE LIMITED WARRANTIES for defective equipment is the repair and replacement of the equipment free of charge by Zonar. Zonar shall not be liable to Customer or any third party for any general, special, punitive, incidental, indirect or consequential damages, or any lost profits or business, arising out of Zonar's Subscription Agreement.

#### **Warning: (Part 15.21)**

Changes or modifications not expressly approved by Zonar Systems could void the user's authority to operate the equipment.

#### **Caution: RF Exposure (OET Bulletin 65)**

Users and installers must be provided with antenna installation instructions and transmitter operating conditions for satisfying RF exposure compliance. Use only supplied and approved antennas. Use of unauthorized antenna's or modifications could impair signal quality, void your warranty and/or result in violation of FCC regulations.

# Zonar Connect®

## Installation/User Guide

### Warranty & Notices - FCC Compliance - Cont.

#### FCC Warning

This equipment has been tested and found to comply with the limits for a Class B digital device, pursuant to part 15 of the FCC Rules. These limits are designed to provide reasonable protection against harmful interference in a residential installation. This equipment generates, uses and can radiate radio frequency energy and, if not installed and used in accordance with the instructions, may cause harmful interference to radio communications. However, there is no guarantee that interference will not occur in a particular installation. If this equipment does cause harmful interference to radio or television reception, which can be determined by turning the equipment off and on, the user is encouraged to try to correct the interference by one or more of the following measures:

- Reorient or relocate the receiving antenna.
  - Increase the separation between the equipment and receiver.
  - Connect the equipment into an outlet on a circuit different from that to which the receiver is connected.
  - Consult the dealer or an experienced radio/TV technician for help.
- Any changes or modifications not expressly approved by the party responsible for compliance could void the authority to operate equipment.
  - This device and its antenna must not be co-located or operating in conjunction with any other antenna or transmitter.
  - End-users and installers must be provided with antenna installation instructions and transmitter operating conditions for satisfying RF exposure compliance.
  - For product available in the USA/Canada market, only channel 1~11 can be operated. Selection of other channels is not possible

#### FCC RF Radiation Exposure Statement:

##### Portable Device

This equipment complies with FCC RF radiation exposure limits set forth for an uncontrolled environment for body-worn configuration in direct contact to the phantom.

This device complies with Part 15 of the FCC Rules. Operation is subject to the following two conditions: (1) this device may not cause harmful interference and (2) this device must accept any interference received, including interference that may cause undesired operation

#### IC Warning

This device complies with FCC and Industry Canada's licence-exempt RSSs. Operation is subject to the following two conditions: (1) This device may not cause interference; and (2) This device must accept any interference, including interference that may cause undesired operation of the device.

Cet appareil est conforme aux normes RSS de FAC et d'Industrie Canada. Son fonctionnement est soumis aux deux conditions suivantes: (1) Cet appareil ne doit pas provoquer d'interférences; Et (2) Cet appareil doit accepter toute interférence, y compris les interférences pouvant entraîner un fonctionnement indésirable de l'appareil.

#### Industry Canada ICES-003 Compliance Label:

*CAN ICES-3 (B)/NMB-3(B)*

#### Co-located

This device and its antenna(s) must not be co-located or operating in conjunction with any other antenna or transmitter.

*Cet appareil et son antenne (s) ne doivent pas être situés ou fonctionner en conjonction avec une autre antenne ou émetteur.*

### Lithium Battery Safety Statement

Lithium battery inside. Danger of explosion if battery is incorrectly replaced. Replace only with same or equivalent type recommended by battery manufacturer.