



# AMG1312-T10D

Wireless 2x2 802.11n ADSL2 4-port Gateway with USB

Version 1.14  
Edition 1, 12/2014

## User's Guide

### Default Login Details

LAN IP Address	http://192.168.1.1
User Name	admin
Password	1234

---

**IMPORTANT!**

**READ CAREFULLY BEFORE USE.**

**KEEP THIS GUIDE FOR FUTURE REFERENCE.**

Screenshots and graphics in this book may differ slightly from your product due to differences in your product firmware or your computer operating system. Every effort has been made to ensure that the information in this manual is accurate.

### **Related Documentation**

- Quick Start Guide

The Quick Start Guide shows how to connect the Device and get up and running right away.

# Contents Overview

Introduction .....	13
Introducing the Web Configurator .....	19
Quick Start .....	25
Connection Status and System Info .....	27
WAN Setup .....	31
Wireless .....	51
Home Networking .....	75
Static Route .....	101
Quality of Service (QoS) .....	105
Network Address Translation (NAT) .....	117
Port Binding .....	125
Dynamic DNS .....	131
Filter .....	133
Firewall .....	139
Parental Control .....	155
Certificates .....	159
System Monitor .....	167
User Account .....	173
TR-069 Client .....	175
System .....	177
Time Setting .....	179
Log Setting .....	181
Firmware Upgrade .....	185
Backup/Restore .....	187
Remote Management .....	191
Diagnostic .....	203
Troubleshooting .....	207



# Table of Contents

<b>Contents Overview .....</b>	<b>3</b>
<b>Table of Contents .....</b>	<b>5</b>
<b>Chapter 1</b>	
<b>Introduction.....</b>	<b>13</b>
1.1 Overview .....	13
1.2 Ways to Manage the Device .....	13
1.3 Good Habits for Managing the Device .....	13
1.4 Applications for the Device .....	14
1.4.1 Internet Access .....	14
1.5 Wireless Access .....	14
1.5.1 Using the WLAN/WPS Button .....	15
1.6 The RESET Button .....	16
1.6.1 Using the Reset Button .....	16
1.7 LEDs (Lights) .....	16
<b>Chapter 2</b>	
<b>Introducing the Web Configurator .....</b>	<b>19</b>
2.1 Overview .....	19
2.1.1 Accessing the Web Configurator .....	19
2.2 The Web Configurator Layout .....	21
2.2.1 Title Bar .....	22
2.2.2 Main Window .....	22
<b>Chapter 3</b>	
<b>Quick Start.....</b>	<b>25</b>
3.1 Overview .....	25
3.2 Quick Start Setup .....	25
<b>Chapter 4</b>	
<b>Connection Status and System Info .....</b>	<b>27</b>
4.1 Overview .....	27
4.2 The Connection Status Screen .....	27
4.3 The System Info Screen .....	28
<b>Chapter 5</b>	
<b>WAN Setup .....</b>	<b>31</b>
5.1 Overview .....	31
5.1.1 What You Can Do in the WAN Screens .....	31

- 5.1.2 What You Need to Know About WAN ..... 32
- 5.1.3 Before You Begin ..... 34
- 5.2 The Internet Connection Screen ..... 34
  - 5.2.1 Advanced Internet Connection ..... 38
- 5.3 The More Connections Screen ..... 40
  - 5.3.1 More Connections Edit ..... 41
  - 5.3.2 Configuring More Connections Advanced Setup ..... 44
- 5.4 The 3G Backup Screen ..... 46
- 5.5 WAN Technical Reference ..... 48
  - 5.5.1 Encapsulation ..... 48
  - 5.5.2 Multiplexing ..... 49
  - 5.5.3 VPI and VCI ..... 50
  - 5.5.4 IP Address Assignment ..... 50

**Chapter 6**  
**Wireless ..... 51**

- 6.1 Overview ..... 51
  - 6.1.1 What You Can Do in this Chapter ..... 51
  - 6.1.2 Wireless Network Overview ..... 51
  - 6.1.3 Before You Begin ..... 53
- 6.2 Wireless General Screen ..... 53
  - 6.2.1 No Security ..... 55
  - 6.2.2 Basic (Static WEP/Shared WEP Encryption) ..... 55
  - 6.2.3 More Secure (WPA2-PSK) ..... 56
  - 6.2.4 WPA2 Authentication ..... 57
- 6.3 More AP Screen ..... 59
  - 6.3.1 Edit More AP ..... 60
- 6.4 MAC Authentication Screen ..... 61
- 6.5 The WPS Screen ..... 62
- 6.6 The WDS Screen ..... 64
- 6.7 The WMM Screen ..... 65
- 6.8 Scheduling Screen ..... 66
  - 6.8.1 Add or Edit Schedule ..... 67
- 6.9 Advanced Screen ..... 67
- 6.10 Technical Reference ..... 69
  - 6.10.1 Additional Wireless Terms ..... 69
  - 6.10.2 Wireless Security Overview ..... 69
  - 6.10.3 Signal Problems ..... 71
  - 6.10.4 BSS ..... 71
  - 6.10.5 MBSSID ..... 72
  - 6.10.6 Wireless Distribution System (WDS) ..... 72

**Chapter 7**  
**Home Networking ..... 75**

7.1 Overview .....	75
7.1.1 What You Can Do in this Chapter .....	75
7.1.2 What You Need To Know .....	75
7.2 The LAN Setup Screen .....	78
7.3 The Static DHCP Screen .....	80
7.3.1 Before You Begin .....	80
7.4 The IP Alias Screen .....	81
7.5 The UPnP Screen .....	82
7.6 The IPv6 LAN Setup Screen .....	82
7.7 The File Sharing Screen .....	87
7.7.1 Before You Begin .....	87
7.7.2 Edit File Sharing User .....	89
7.8 The Printer Server Screen .....	89
7.8.1 Before You Begin .....	90
7.9 Technical Reference .....	91
7.10 Installing UPnP in Windows Example .....	92
7.11 Using UPnP in Windows XP Example .....	95

## **Chapter 8**

### **Static Route .....** **101**

8.1 Overview .....	101
8.1.1 What You Can Do in this Chapter .....	101
8.2 Configuring Static Route .....	102
8.2.1 Add/Edit Static Route .....	102
8.3 IPv6 Static Route .....	103
8.3.1 IPv6 Static Route Edit .....	104

## **Chapter 9**

### **Quality of Service (QoS).....** **105**

9.1 Overview .....	105
9.1.1 What You Can Do in this Chapter .....	105
9.1.2 What You Need to Know .....	105
9.2 The QoS General Screen .....	106
9.3 The Queue Setup Screen .....	107
9.3.1 Edit a QoS Queue .....	107
9.4 The Class Setup Screen .....	108
9.4.1 Add/Edit QoS Class .....	109
9.5 The QoS Policer Setup Screen .....	113
9.5.1 Add/Edit a QoS Policer .....	114
9.6 The QoS Game List Screen .....	115
9.7 QoS Technical Reference .....	116
9.7.1 DiffServ .....	116

<b>Chapter 10</b>	
<b>Network Address Translation (NAT).....</b>	<b>117</b>
10.1 Overview .....	117
10.1.1 What You Can Do in this Chapter .....	117
10.1.2 What You Need To Know .....	117
10.2 The General Screen .....	118
10.3 The Port Forwarding Screen .....	118
10.3.1 The Port Forwarding Screen .....	119
10.3.2 The Port Forwarding Add/Edit Screen .....	120
10.4 The DMZ Screen .....	121
10.5 The ALG Screen .....	122
10.6 Technical Reference .....	122
10.6.1 NAT Definitions .....	123
10.6.2 What NAT Does .....	123
10.6.3 How NAT Works .....	123
<b>Chapter 11</b>	
<b>Port Binding .....</b>	<b>125</b>
11.1 Overview .....	125
11.2 The Port Binding Screen .....	126
11.2.1 Port Binding Summary Screen .....	126
11.2.2 The Any Port Any Service Edit Screen .....	128
<b>Chapter 12</b>	
<b>Dynamic DNS .....</b>	<b>131</b>
12.1 Overview .....	131
12.1.1 What You Need To Know .....	131
12.2 The Dynamic DNS Screen .....	131
<b>Chapter 13</b>	
<b>Filter .....</b>	<b>133</b>
13.1 Overview .....	133
13.1.1 What You Can Do in the Filter Screens .....	133
13.2 The IP/MAC Filter Screen .....	133
13.3 The IPv6/MAC Filter Screen .....	135
<b>Chapter 14</b>	
<b>Firewall .....</b>	<b>139</b>
14.1 Overview .....	139
14.1.1 What You Can Do in the Firewall Screens .....	139
14.1.2 What You Need to Know About Firewall .....	140
14.2 Firewall General Screen .....	141
14.3 Default Action Screen .....	142



14.4 Rules Screen .....	143
14.4.1 Rules Add Screen .....	144
14.4.2 Customized Services .....	146
14.4.3 Customized Service Add/Edit .....	147
14.5 DoS Screen .....	148
14.5.1 The DoS Advanced Screen .....	149
14.5.2 Configuring Firewall Thresholds .....	150
14.6 Firewall Technical Reference .....	151
14.6.1 Firewall Rules Overview .....	151
14.6.2 Guidelines For Enhancing Security With Your Firewall .....	152
14.6.3 Security Considerations .....	152
14.6.4 Triangle Route .....	153
<b>Chapter 15</b>	
<b>Parental Control .....</b>	<b>155</b>
15.1 Overview .....	155
15.2 The Parental Control Screen .....	155
15.2.1 Add/Edit a Parental Control Rule .....	156
<b>Chapter 16</b>	
<b>Certificates .....</b>	<b>159</b>
16.1 Overview .....	159
16.1.1 What You Can Do in this Chapter .....	159
16.1.2 What You Need to Know .....	159
16.1.3 Verifying a Certificate .....	160
16.2 Local Certificates .....	161
16.3 Trusted CA .....	163
16.4 Trusted CA Import .....	163
16.5 View Certificate .....	164
<b>Chapter 17</b>	
<b>System Monitor .....</b>	<b>167</b>
17.1 Overview .....	167
17.1.1 What You Can Do in this Chapter .....	167
17.1.2 What You Need To Know .....	167
17.2 The Log Screen .....	168
17.3 The WAN Traffic Status Screen .....	169
17.4 The LAN Traffic Status Screen .....	169
17.5 The NAT Traffic Status Screen .....	170
<b>Chapter 18</b>	
<b>User Account .....</b>	<b>173</b>
18.1 Overview .....	173

18.2 The User Account Screen .....	173
<b>Chapter 19</b>	
<b>TR-069 Client.....</b>	<b>175</b>
19.1 Overview .....	175
19.2 The TR-069 Client Screen .....	175
<b>Chapter 20</b>	
<b>System.....</b>	<b>177</b>
20.1 Overview .....	177
20.2 The System Screen .....	177
<b>Chapter 21</b>	
<b>Time Setting .....</b>	<b>179</b>
21.1 Overview .....	179
21.2 The Time Setting Screen .....	179
<b>Chapter 22</b>	
<b>Log Setting .....</b>	<b>181</b>
22.1 Overview .....	181
22.2 The Log Setting Screen .....	181
<b>Chapter 23</b>	
<b>Firmware Upgrade .....</b>	<b>185</b>
23.1 Overview .....	185
23.2 The Firmware Upgrade Screen .....	185
<b>Chapter 24</b>	
<b>Backup/Restore .....</b>	<b>187</b>
24.1 Overview .....	187
24.2 The Backup/Restore Screen .....	187
24.3 The Reboot Screen .....	189
<b>Chapter 25</b>	
<b>Remote Management.....</b>	<b>191</b>
25.1 Overview .....	191
25.1.1 What You Can Do in the Remote Management Screens .....	191
25.1.2 What You Need to Know About Remote Management .....	192
25.2 The WWW Screen .....	192
25.2.1 Configuring the WWW Screen .....	192
25.3 Telnet Screen .....	194
25.4 FTP Screen .....	194
25.5 SNMP Screen .....	195

---

25.5.1 Configuring SNMP .....	196
25.6 DNS Screen .....	198
25.7 ICMP Screen .....	199
25.8 SSH Screen .....	199
25.8.1 SSH Example .....	200
<b>Chapter 26</b>	
<b>Diagnostic .....</b>	<b>203</b>
26.1 Overview .....	203
26.1.1 What You Can Do in the Diagnostic Screens .....	203
26.2 The Ping Screen .....	203
26.3 The DSL Line Screen .....	204
<b>Chapter 27</b>	
<b>Troubleshooting.....</b>	<b>207</b>
27.1 Overview .....	207
27.2 Power, Hardware Connections, and LEDs .....	207
27.3 Device Access and Login .....	208
27.4 Internet Access .....	209
27.5 Wireless Internet Access .....	211
27.6 USB Device Connection .....	212
27.7 UPnP .....	212
Appendix A Legal Information.....	213
<b>Index .....</b>	<b>219</b>



# Introduction

## 1.1 Overview

The switch is an ADSL2+ router which allows super-fast, secure Internet access over analog (POTS) telephone lines. It supports Asynchronous Transfer Mode (ATM). You can have ADSL, ADSL2, ADSL2+ connections.

The Device integrates DSL and NAT for ease of installation and high-speed, shared Internet access. It also provides a complete security solution with a robust firewall and content filtering. The product name format indicates the following:

- “H” denotes an integrated 4-port hub (switch).
- “N” denotes IEEE 802.11n wireless networking support.
- “U” denotes a USB port used to set up a 3G WAN connection via a 3G wireless card or share files via a USB memory stick or a USB hard drive. The Device can also function as a print server with an USB printer connected.

**Only use firmware for your Device’s specific model. Refer to the label on the bottom of your Device.**

## 1.2 Ways to Manage the Device

Use any of the following methods to manage the Device.

- Web Configurator. Use a (supported) web browser to manage the Device.
- FTP for firmware upgrades and configuration backup/restore.
- TR-069. This auto-configuration server remotely configures your device.

## 1.3 Good Habits for Managing the Device

Do the following things regularly to make the Device more secure and to manage the Device more effectively.

- Change the password. Use a password that’s not easy to guess and that consists of different types of characters, such as numbers and letters.
- Write down the password and put it in a safe place.

- Back up the configuration (and make sure you know how to restore it). Restoring an earlier working configuration may be useful if the device becomes unstable or even crashes. If you forget your password, you will have to reset the Device to its factory default settings. If you backed up an earlier configuration file, you would not have to totally re-configure the Device. You could simply restore your last configuration.

## 1.4 Applications for the Device

Here are some example uses for the Device.

### 1.4.1 Internet Access

Your Device provides shared Internet access by connecting the DSL port to the **DSL** or **MODEM** jack on a splitter or your telephone jack. Computers can connect to the Device's LAN ports (or wirelessly).

**Figure 1** Device's Router Features

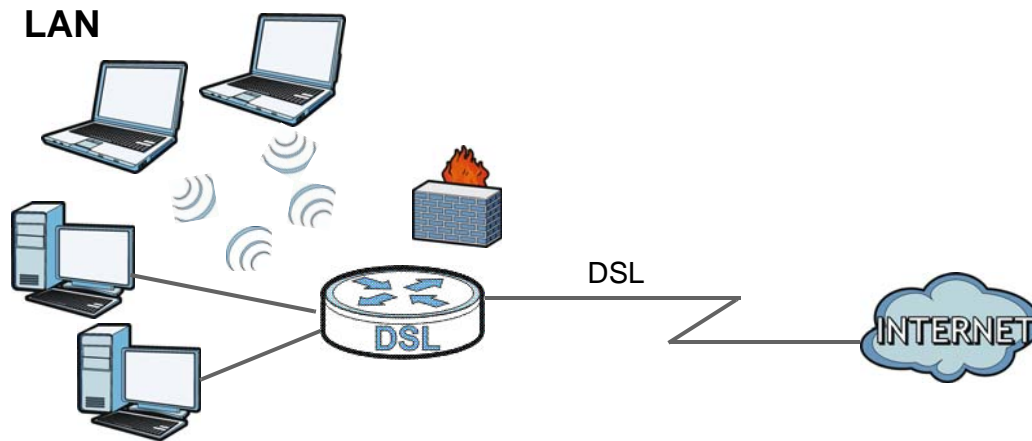

Configure firewall and filtering features on the Device for secure Internet access. Set the firewall to allow responses from the Internet for traffic initiated from your network and block traffic initiated from the Internet. This blocks probes from the outside to your network, but lets you safely browse the Internet and download files.

Use the filtering feature to block access to specific web sites or Internet applications such as MSN or Yahoo Messenger. You can also configure IP/MAC filtering rules for incoming or outgoing traffic.

Use QoS to efficiently manage traffic on your network by giving priority to certain types of traffic and/or to particular computers. For example, you could make sure that the Device gives voice over Internet calls high priority, and/or limit bandwidth devoted to the boss's excessive file downloading.

## 1.5 Wireless Access

The Device serves as a wireless Access Point (AP) to let wireless clients such as notebook computers, smart phones, and tablets connect to the Internet without Ethernet cables.

Configure your wireless network through the Web Configurator, or the WPS button.

**Figure 2** Wireless Access Example

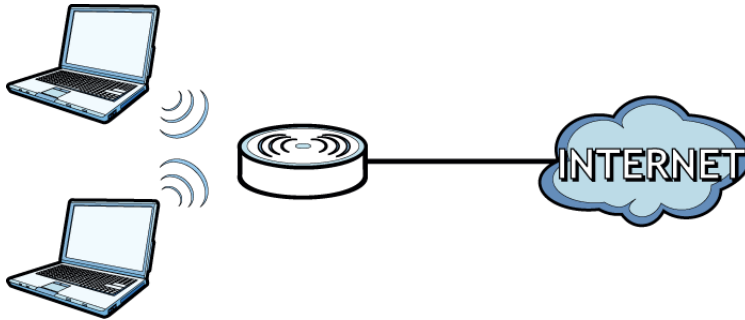

### 1.5.1 Using the WLAN/WPS Button

By default, the Device's wireless network is enabled. To turn it off, simply press the **WPS/WLAN** button on top of the Device for over 5 seconds. The **WLAN/WPS** LED turns off.

Use the **WLAN/WPS** button to quickly set up a secure wireless connection between the Device and a WPS-compatible client by adding one device at a time. To activate WPS:

- 1 With the **POWER** LED on steady, press the **WLAN/WPS** button for 1 second and release it.

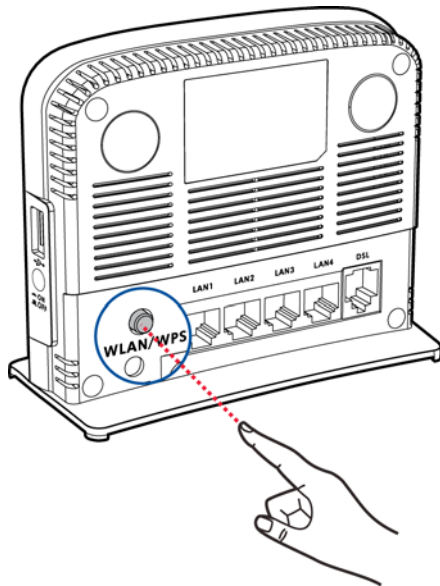

- 2 Within two minutes, press the WPS button on a WPS-enabled client within range of the Device. The **WPS/WLAN** LED should flash while the Device sets up a WPS connection with the client.
- 3 The **WPS/WLAN** LED shines green for a successful connection.

## 1.6 The RESET Button

If you forget your password or cannot access the web configurator, use the **RESET** button at the back of the device to reload the factory-default configuration file. This means that you will lose all configurations that you had previously and the user name and password will be reset to the default.

### 1.6.1 Using the Reset Button

With the **POWER** LED on steady, press the **RESET** button for ten seconds or until the **POWER** LED begins to blink and then release it. When the **POWER** LED begins to blink, the defaults have been restored and the device restarts.

## 1.7 LEDs (Lights)

The following graphic displays the labels of the LEDs.

**Figure 3** LEDs





None of the LEDs are on if the Device is not receiving power.

**Table 1** LED Descriptions

LED	COLOR	STATUS	DESCRIPTION
USB	Green	On	The Device recognizes a USB connection through the USB slot.
		Blinking	The Device is sending or receiving data to or from the connected USB device.
		Off	The Device does not detect a USB connection through the USB slot.
DSL	Green	On	The DSL line is up.
		Blinking	The DSL line is initializing.
	Off	The DSL line is down.	
WLAN/WPS	Green	On	The wireless network is activated.
		Blinking	The Device is communicating with other wireless clients.
	Orange	Blinking	The Device is setting up a WPS connection.
	Off	The wireless network is not activated.	
ETHERNET 1-4	Green	On	The Device has a successful 100 Mbps Ethernet connection with a device on the Local Area Network (LAN).
		Blinking	The Device is sending or receiving data to/from the LAN at 100 Mbps.
	Off	The Device does not have an Ethernet connection with the LAN.	
INTERNET	Green	On	The Device has an IP connection but no traffic.  Your device has a WAN IP address (either static or assigned by a DHCP server), PPP negotiation was successfully completed (if used) and the DSL connection is up.
		Blinking	The Device is sending or receiving IP traffic.
		Off	The Device does not have an IP connection.
	Red	On	The Device attempted to make an IP connection but failed.
POWER	Green	On	The Device is receiving power and ready for use.
		Blinking	The Device is self-testing.
	Red	On	The Device has hardware failure.
		Blinking	Firmware upgrade is in progress.
	Off	The Device is not receiving power.	

Refer to the Quick Start Guide for information on hardware connections.



# Introducing the Web Configurator

## 2.1 Overview

The web configurator is an HTML-based management interface that allows easy device setup and management via Internet browser. Use Internet Explorer 6.0 and later versions, Mozilla Firefox 3 and later versions, or Safari 2.0 and later versions. The recommended screen resolution is 1024 by 768 pixels.

In order to use the web configurator you need to allow:

- Web browser pop-up windows from your device. Web pop-up blocking is enabled by default in Windows XP SP (Service Pack) 2.
- JavaScript (enabled by default).
- Java permissions (enabled by default).

### 2.1.1 Accessing the Web Configurator

- 1 Make sure your Device hardware is properly connected (refer to the Quick Start Guide).
- 2 Launch your web browser.
- 3 Type "192.168.1.1" as the URL.
- 4 A password screen displays. Type "admin" as the default **Username** and "1234" as the default password to access the device's Web Configurator. Click **Login**. If you have changed the password, enter your password and click **Login**.

**Figure 4** Password Screen

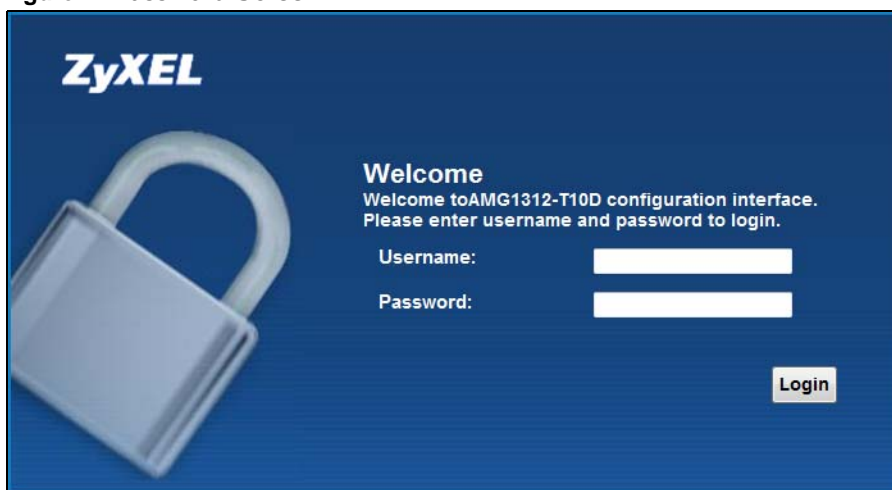

The screenshot shows a dark blue login screen for ZyXEL. On the left is a large, light blue padlock icon. The ZyXEL logo is in the top left. The text reads: "Welcome to AMG1312-T10D configuration interface. Please enter username and password to login." Below this are two white input fields: "Username:" and "Password:". A "Login" button is located at the bottom right of the form area.

Note: For security reasons, the Device automatically logs you out if you do not use the web configurator for five minutes (default). If this happens, log in again.

- 5 The following screen displays if you have not yet changed your password. It is strongly recommended you change the default password. Enter a new password, retype it to confirm and click **Apply**; alternatively click **Skip** to proceed to the main menu if you do not want to change the password now.

**Figure 5** Change Password Screen

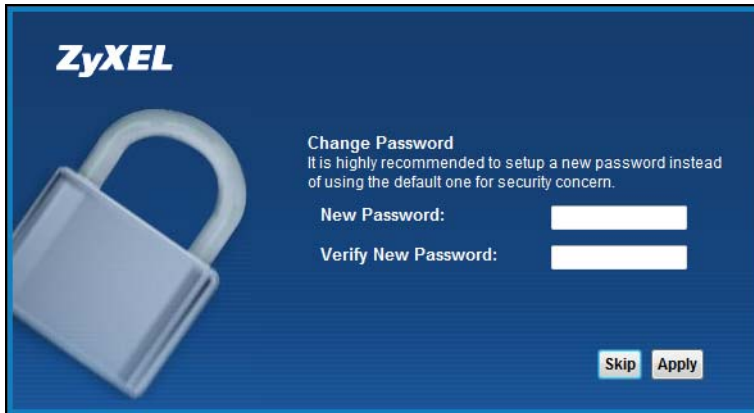

- 6 The **Connection Status** screen appears.

Figure 6 Connection Status

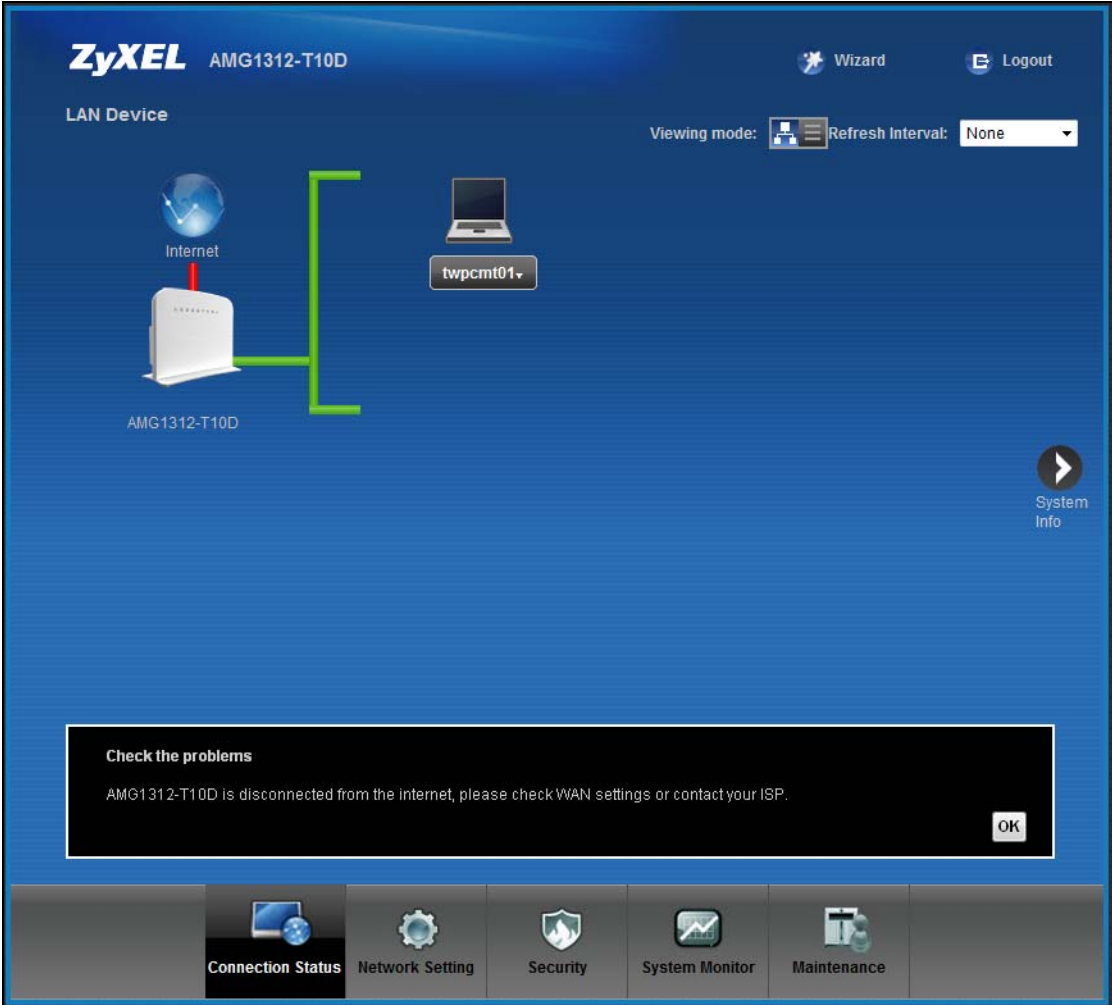

- 7 Click **System Info** to display the **System Info** screen, where you can view the Device’s interface and system information.

## 2.2 The Web Configurator Layout

Click **Connection Status** > **System Info** to show the following screen.

Figure 7 Web Configurator Layout

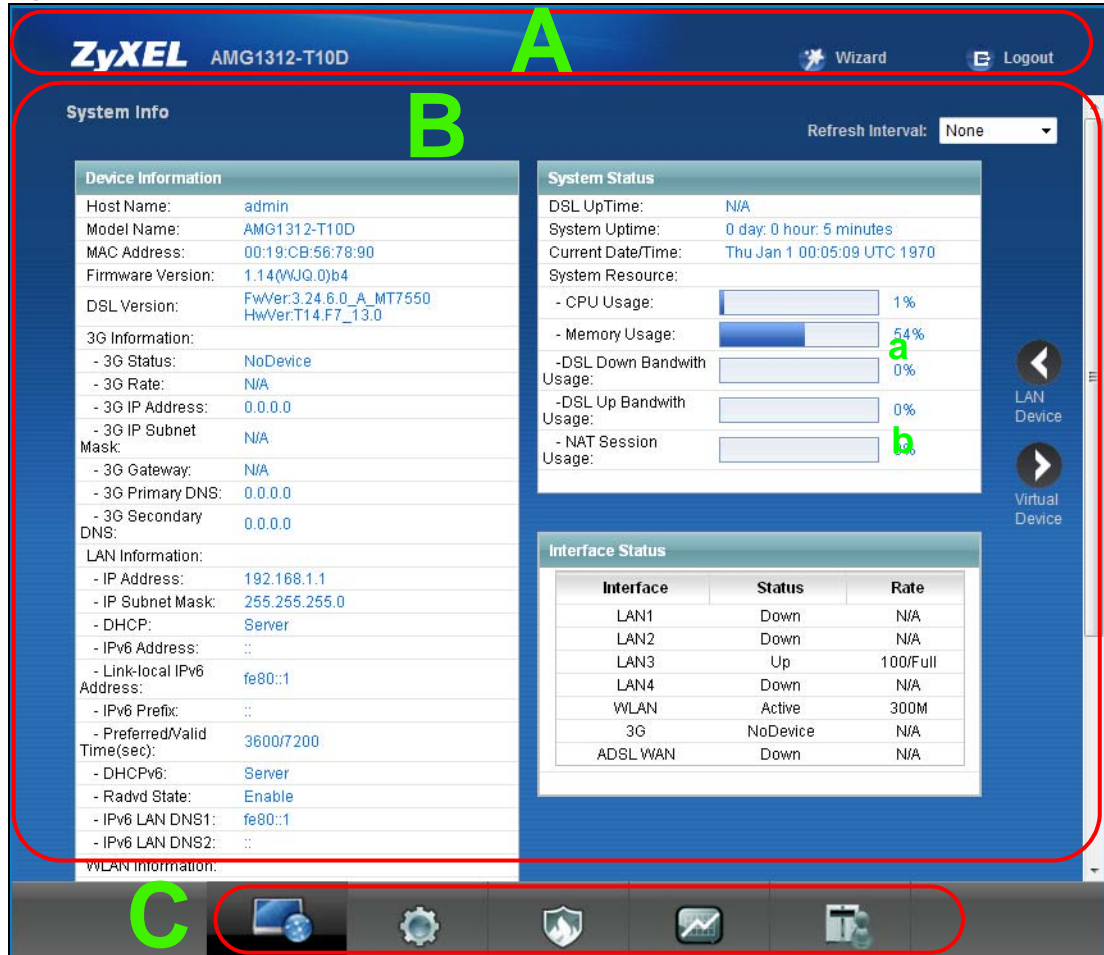

As illustrated above, the main screen is divided into these parts:

- **A** - title bar
- **B** - main window
- **C** - navigation panel

## 2.2.1 Title Bar

The title bar shows the **Wizard** and **Logout** icons in the upper right corner.



Click the **Wizard** icon to configure basic initial settings. Click the **Logout** icon to log out of the web configurator.

## 2.2.2 Main Window

The main window displays information and configuration fields. It is discussed in the rest of this document.

Click **LAN Device** on the **System Info** screen (a in Figure 7 on page 22) to display the **Connection Status** screen. See Chapter 4 on page 28 for more information on the **System Info** and **Connection Status** screens.

Click **Virtual Device** on the **System Info** screen (b in Figure 7 on page 22) to display a visual graphic showing the connection status of the Device's ports. The connected ports are in color and disconnected ports are gray.

Figure 8 Virtual Device







## Quick Start

### 3.1 Overview

Use the **Quick Start** screens to configure the Device's time zone, basic Internet access, and wireless settings.

Note: See the rest of this guide for background information on the features in this chapter.

### 3.2 Quick Start Setup

- 1 The **Quick Start Wizard** appears automatically after login. Or you can click the **Start** icon in the top right corner of the web configurator to open the quick start screens. Select the time zone of the Device's location and click **Next**.

**Figure 9** Time Zone

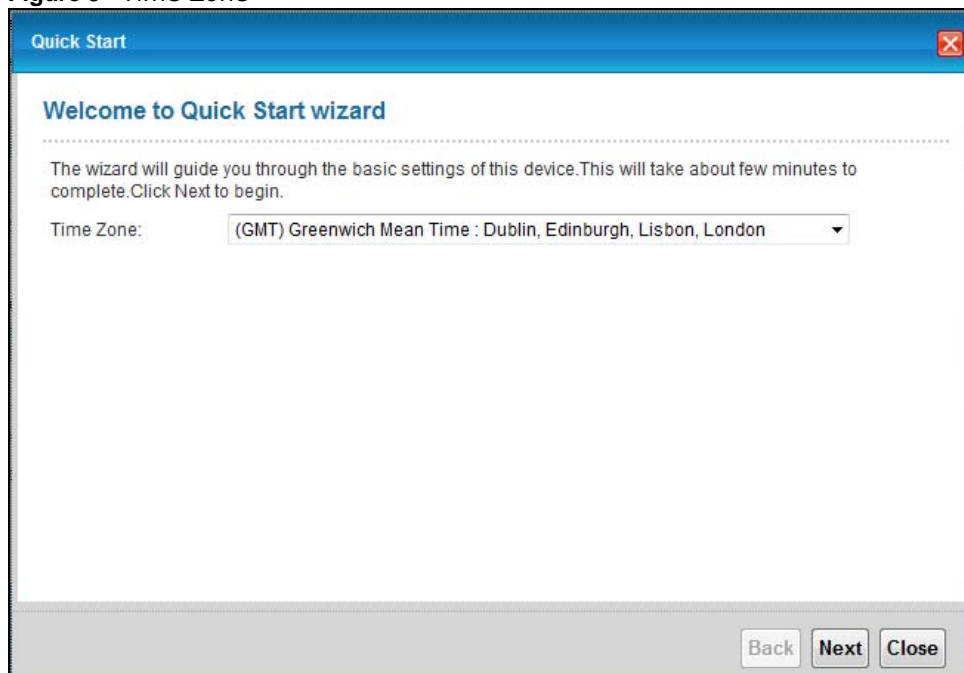

- 2 Enter your Internet connection information in this screen. The screen and fields to enter may vary depending on your current connection type. Click **Next**.

Figure 10 WAN Interface Selection

The screenshot shows a window titled "Quick Start" with a blue header bar. Below the header, the title "Internet Configuration" is displayed in blue, and "STEP 1" is shown in the top right corner. The main content area contains the following text: "The current connection type is set to PPPoE and needs a user name and password to get online." Below this, there are three input fields: "User Name:" with the text "ChangeMe", "Password:" with a masked password of ten dots, and "Service Name:" which is empty. Below the input fields, the text asks: "Is there specific IP address information from your Internet Service Provider (ISP)?" with two radio buttons: "Yes" (unselected) and "No" (selected). Below the radio buttons, it says: "Then the IP Address information will be dynamically assigned to you from your ISP." At the bottom right of the window, there are three buttons: "Back", "Next", and "Close".

- 3 Turn the wireless LAN on or off. If you keep it on, record the security settings so you can configure your wireless clients to connect to the Device. Click **Save**.

Figure 11 Internet Connection

The screenshot shows a window titled "Quick Start" with a blue header bar. Below the header, the title "Wireless Setup" is displayed in blue, and "STEP 2" is shown in the top right corner. The main content area contains the following text: "The following settings are the current wireless settings which your wireless client devices need in order to get connected to this device." Below this, there are four settings listed: "Wireless Service:" with a checked checkbox, "Wireless Network Name (SSID):" with the value "ZyXEL\_7890", "Security Level:" with the value "WPAPSKWPA2PSK", and "Pre-Shared Key:" with the value "4Wx4WU9EHER3E". At the bottom right of the window, there are three buttons: "Back", "Next", and "Close".

- 4 Your Device saves your settings and attempts to connect to the Internet.

# Connection Status and System Info

## 4.1 Overview

After you log into the web configurator, the **Connection Status** screen appears. This shows the network connection status of the Device and clients connected to it.

Use the **System Info** screen to look at the current status of the device, system resources, interfaces (LAN, WAN and WLAN), and SIP accounts. You can also register and unregister SIP accounts.

If you click **Virtual Device** on the **System Info** screen, a visual graphic appears, showing the connection status of the Device's ports. See [Section 2.2.2 on page 22](#) for more information.

## 4.2 The Connection Status Screen

Use this screen to view the network connection status of the device and its clients. A warning message appears if there is a connection problem. You can configure how often you want the Device to update this screen in **Refresh Interval**.

**Figure 12** Connection Status: Icon View

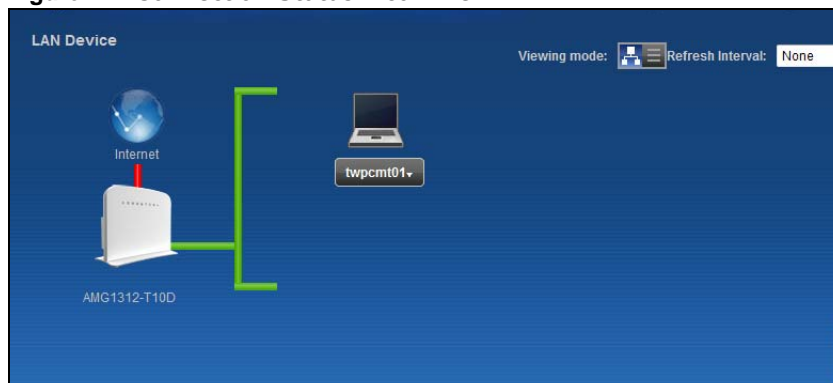

To view the connected LAN devices in a list, click **List View** in the **Viewing mode** selection box.

**Figure 13** Connection Status: List View

#	Device Name	IP Address	Link-local IPv6 Address	Global IPv6 Address	MAC Address	Reserve
1	twpcmt01165-01	192.168.1.33	fe80::20b4:7f47:36afd804	N/A	00:24:21:7E:20:E7	

In **Icon View**, if you want to view information about a client, click the client's name and **Info**.

In **List View**, you can also view the client's information.

## 4.3 The System Info Screen

Click **Connection Status > System Info** to open this screen.

**Figure 14** System Info Screen

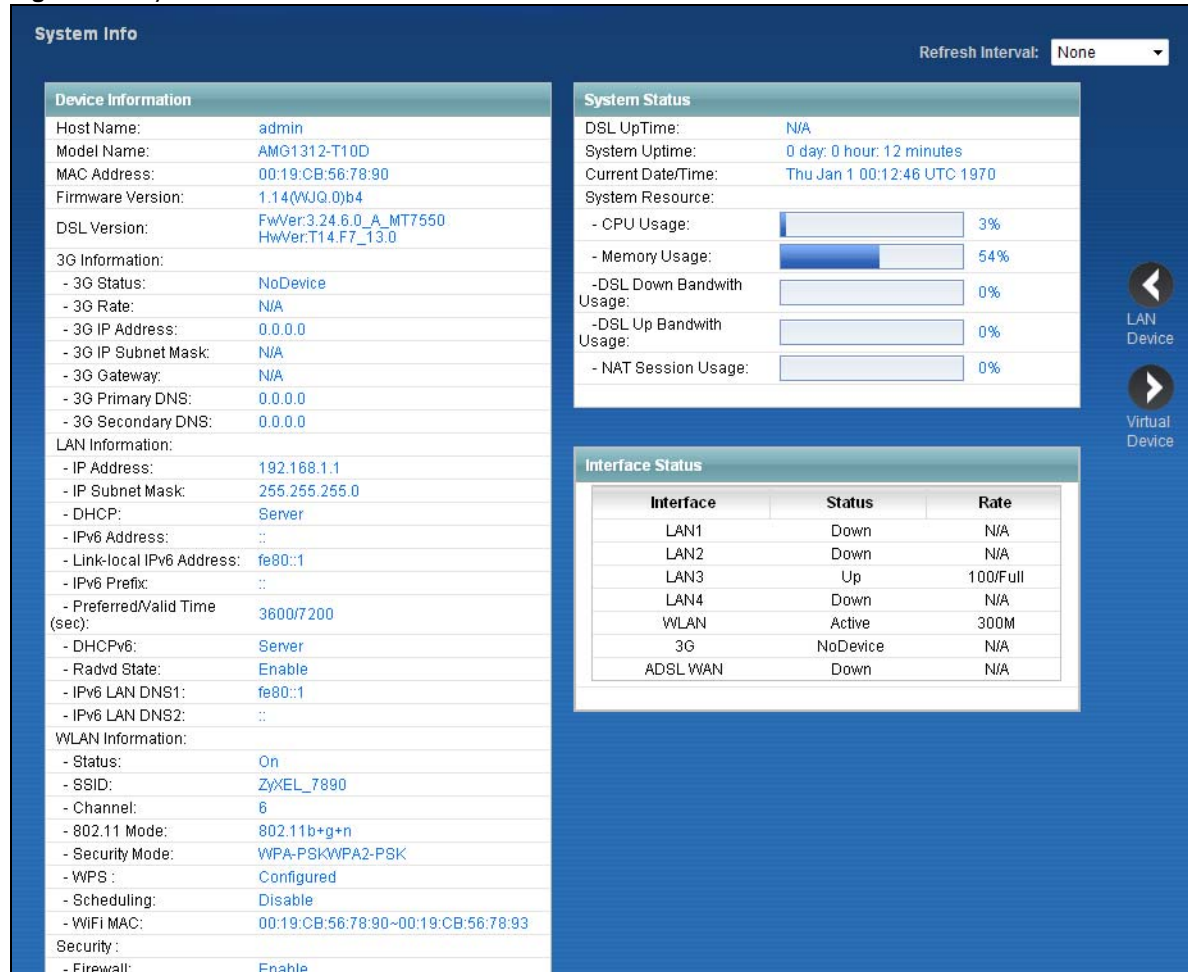

Each field is described in the following table.

**Table 2** System Info Screen

LABEL	DESCRIPTION
Refresh Interval	Select how often you want the Device to update this screen from the drop-down list box.
Device Information	
Host Name	This field displays the Device system name. It is used for identification. You can change this in the <b>Maintenance &gt; System</b> screen's <b>Host Name</b> field.
Model Name	This is the model name of your device.

**Table 2** System Info Screen (continued)

LABEL	DESCRIPTION
MAC Address	This is the MAC (Media Access Control) or Ethernet address unique to your Device.
Firmware Version	This field displays the current version of the firmware inside the device. It also shows the date the firmware version was created. Go to the <b>Maintenance &gt; Firmware Upgrade</b> screen to change it.
DSL Version	This is the current version of the Device's DSL modem code.
3G Information	
3G Status	This shows the current status of your 3G connection. <b>NoDevice</b> is shown when no 3G card is inserted.
3G Rate	This shows the rate of the 3G connection if it is available.
3G IP Address	This shows the IP address for the 3G connection.
3G IP Subnet Mask	This shows the current subnet mask for the 3G connection.
3G Gateway	This shows the IP address of the 3G connection's default gateway.
3G Primary/Secondary DNS	This shows the first and second DNS server address assigned by the ISP.
LAN Information	
IP Address	This field displays the current IP address of the Device in the LAN.
IP Subnet Mask	This field displays the current subnet mask in the LAN.
DHCP	This field displays what DHCP services the Device is providing to the LAN. Choices are: <b>Server</b> - The Device is a DHCP server in the LAN. It assigns IP addresses to other computers in the LAN. <b>None</b> - The Device is not providing any DHCP services to the LAN.
IPv6 Address	This is the current IPv6 address of the Device in the LAN.
Link-local IPv6 Address	This is the current LAN IPv6 link-local address of the Device.
IPv6 Prefix	This is the current IPv6 prefix length in the LAN.
Preferred/Valid Time(sec)	This is the Preferred Lifetime and Valid Lifetime in the LAN.
DHCPv6	This field displays what DHCPv6 services the Device is providing to the LAN. Choices are: <b>Server</b> - The Device is a DHCPv6 server in the LAN. It assigns IP addresses to other computers in the LAN. <b>None</b> - The Device is not providing any DHCPv6 services to the LAN.
Radvd State	This shows the status of RADVD.
IPv6 LAN DNS1/DNS2	This is the first/second DNS server IPv6 address the Device passes to the DHCP clients.
WLAN Information	
Status	This shows whether or not the wireless LAN is enabled (on).
SSID	This is the descriptive name used to identify the Device in the wireless LAN.
Channel	This is the channel number used by the Device now.
802.11 Mode	This displays the type of 802.11 mode the Device is using in the wireless LAN.
Security Mode	This displays the type of security the Device is using in the wireless LAN.
WPS	<b>Configured</b> displays when a wireless client has connected to the Device or WPS is enabled and wireless or wireless security settings have been configured. <b>Unconfigured</b> displays if WPS wireless security settings have not been configured. <b>Off</b> displays if WPS is disabled.

**Table 2** System Info Screen (continued)

LABEL	DESCRIPTION
Scheduling	This shows whether wireless scheduling is enabled or disabled.
WiFi MAC	This is the MAC (Media Access Control) or Ethernet address unique to your Device's WiFi interface.
Security	
Firewall	This shows whether or not the firewall is enabled (on).
System Status	
DSL UpTime	This field displays how long the DSL connection has been active.
System Uptime	This field displays how long the Device has been running since it last started up. The Device starts up when you plug it in, when you restart it ( <b>Maintenance &gt; Reboot</b> ), or when you reset it (see <a href="#">Section 1.6 on page 16</a> ).
Current Date/Time	This field displays the current date and time in the Device. You can change this in <b>Maintenance &gt; Time Setting</b> .
CPU Usage	This field displays what percentage of the Device's processing ability is currently used. When this percentage is close to 100%, the Device is running at full load, and the throughput is not going to improve anymore. If you want some applications to have more throughput, you should turn off other applications.
Memory Usage	This field displays what percentage of the Device's memory is currently used. Usually, this percentage should not increase much. If memory usage does get close to 100%, the Device is probably becoming unstable, and you should restart the device. See <a href="#">Chapter 24 on page 189</a> , or turn off the device (unplug the power) for a few seconds.
DSL Down Bandwidth Usage	This field displays what percentage of the Device's downstream DSL bandwidth is currently used. When this percentage is close to 100%, the Device is running at full load, and the throughput is not going to improve anymore. If you want some applications to have more throughput, you should turn off other applications.
DSL Up Bandwidth Usage	This field displays what percentage of the Device's upstream DSL bandwidth is currently used. When this percentage is close to 100%, the Device is running at full load, and the throughput is not going to improve anymore. If you want some applications to have more throughput, you should turn off other applications.
NAT Session Usage	This field displays what percentage of the Device supported NAT sessions are currently being used.
Interface Status	
Interface	This column displays each interface the Device has.
Status	<p>This field indicates whether or not the Device is using the interface.</p> <p>For the LAN interfaces, this field displays <b>Up</b> when the Device is using the interface and <b>Down</b> when the Device is not using the interface.</p> <p>For the WLAN interface, it displays <b>Active</b> when WLAN is enabled or <b>Down</b> when WLAN is disabled.</p> <p>For the 3G USB interface, this field displays <b>Up</b> when using the interface and <b>NoDevice</b> when no device is detected in any USB slot.</p> <p>For the xDSL WAN interface, this field displays <b>Down</b> when the line is down or <b>Up</b> when line is up or connected.</p>
Rate	<p>For the LAN interface, this displays the port speed and duplex setting.</p> <p>For the WLAN interface, it displays the maximum transmission rate when WLAN is enabled or N/A when WLAN is disabled.</p> <p>For the 3G interface, it displays the maximum transmission rate when 3G is enabled or N/A when 3G is disabled.</p> <p>For the xDSL WAN interface, it displays the downstream and upstream transmission rate.</p>

## WAN Setup

### 5.1 Overview

This chapter describes how to configure WAN settings from the **WAN** screens. Use these screens to configure your Device for Internet access.

A WAN (Wide Area Network) connection connects to another network or the Internet. It connects your private networks (such as a LAN (Local Area Network) and other networks, so that a computer in one location can communicate with computers in other locations.

**Figure 15** LAN and WAN

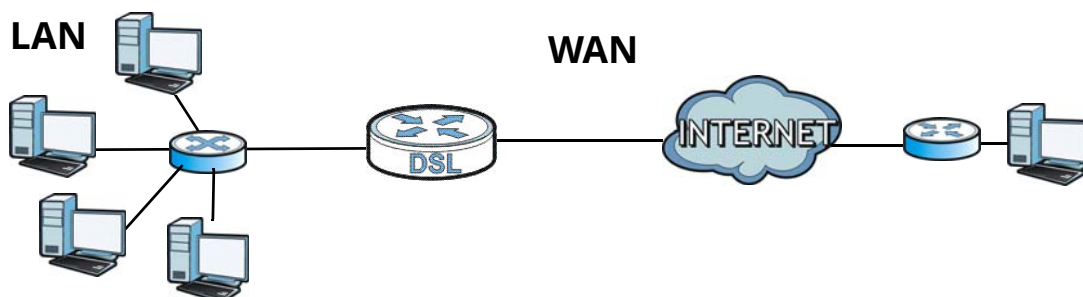

3G (third generation) standards for the sending and receiving of voice, video, and data in a mobile environment.

You can attach a 3G wireless adapter to the USB port and set the Device to use this 3G connection as your WAN or a backup when the wired WAN connection fails.

**Figure 16** 3G WAN Connection

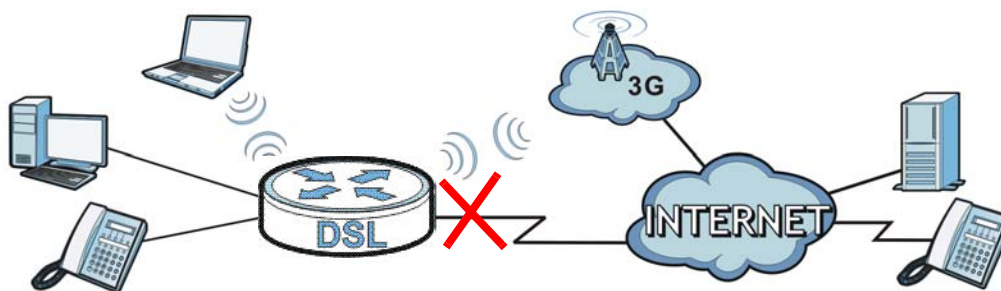

#### 5.1.1 What You Can Do in the WAN Screens

- Use the **Internet Connection** screen ([Section 5.2 on page 34](#)) to configure the WAN settings on the Device for Internet access.

- Use the **More Connections** screen ([Section 5.3 on page 40](#)) to set up additional Internet access connections.
- Use the **3G Backup** screen to configure 3G WAN connection ([Section 5.4 on page 46](#)).

## 5.1.2 What You Need to Know About WAN

### Encapsulation Method

Encapsulation includes data from an upper layer protocol into a lower layer protocol. To set up a WAN connection to the Internet, you need to use the same encapsulation method used by your ISP (Internet Service Provider). If your ISP offers a dial-up Internet connection using PPPoE (PPP over Ethernet) or PPPoA, they should also provide a username and password (and service name) for user authentication.

### WAN IP Address

The Device uses its WAN IP address to connect to the Internet and communicate with devices in other networks. It can be static (fixed) or dynamically assigned by the ISP when the Device connects to the Internet.

If your ISP assigns you a static WAN IP address, they should also assign you the subnet mask and DNS server IP address(es) (and a gateway IP address if you use the Ethernet or ENET ENCAP encapsulation method).

### Multicast

Traditionally, IP packets are transmitted in one of either two ways - Unicast (1 sender - 1 recipient) or Broadcast (1 sender - everybody on the network). Multicast delivers IP packets to a group of hosts on the network - not everybody and not just one.

### IGMP

Devices use the IGMP (Internet Group Management Protocol) network-layer protocol to establish membership in a multicast group - it does not carry user data. IGMP versions 2 and 3 offer improvements over the widely-used version 1.

### IPv6

IPv6 (Internet Protocol version 6) provides increased IP address space and enhanced features in comparison to IPv4. The Device supports IPv4/IPv6 dual stack and can connect to IPv4 and IPv6 networks.

### IPv6 Rapid Deployment

Use IPv6 Rapid Deployment (6rd) when the local network uses IPv6 and the ISP has an IPv4 network. When the Device has an IPv4 WAN address and you set **IPv6/IPv4 Dual Stack** to **IPv4**, you can enable 6rd to encapsulate IPv6 packets in IPv4 packets to cross the ISP's IPv4 network.

The Device generates a global IPv6 prefix from its IPv4 WAN address and tunnels IPv6 traffic to the ISP's Border Relay router (BR in the figure) to connect to the native IPv6 Internet. The local



network can also use IPv4 services. The Device uses its configured IPv4 WAN IP to route IPv4 traffic to the IPv4 Internet.

**Figure 17** IPv6 Rapid Deployment

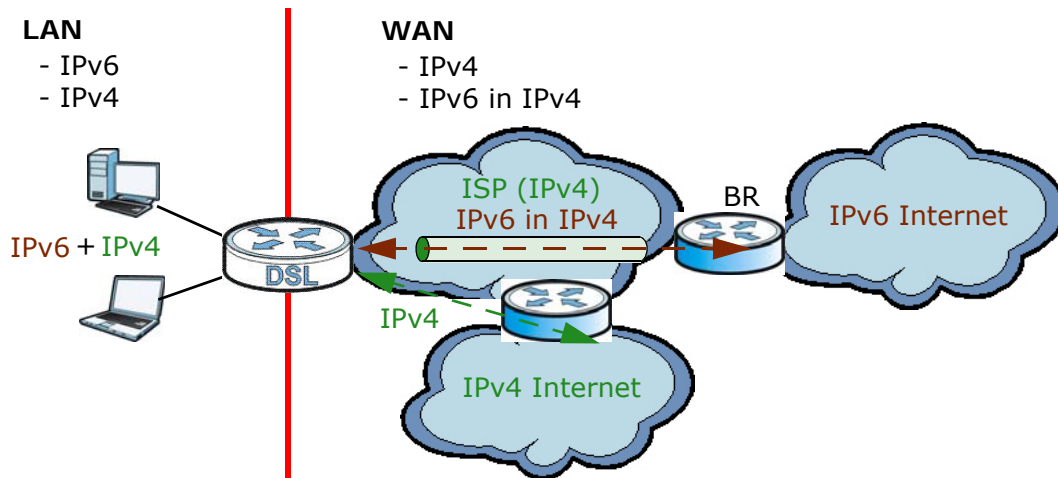

## Dual Stack Lite

Use Dual Stack Lite when local network computers use IPv4 and the ISP has an IPv6 network. When the Device has an IPv6 WAN address and you set **IPv6/IPv4 Dual Stack** to **IPv6**, you can enable Dual Stack Lite to use IPv4 computers and services.

The Device tunnels IPv4 packets inside IPv6 encapsulation packets to the ISP's Address Family Transition Router (AFTR in the graphic) to connect to the IPv4 Internet. The local network can also use IPv6 services. The Device uses its configured IPv6 WAN IP to route IPv6 traffic to the IPv6 Internet.

**Figure 18** Dual Stack Lite

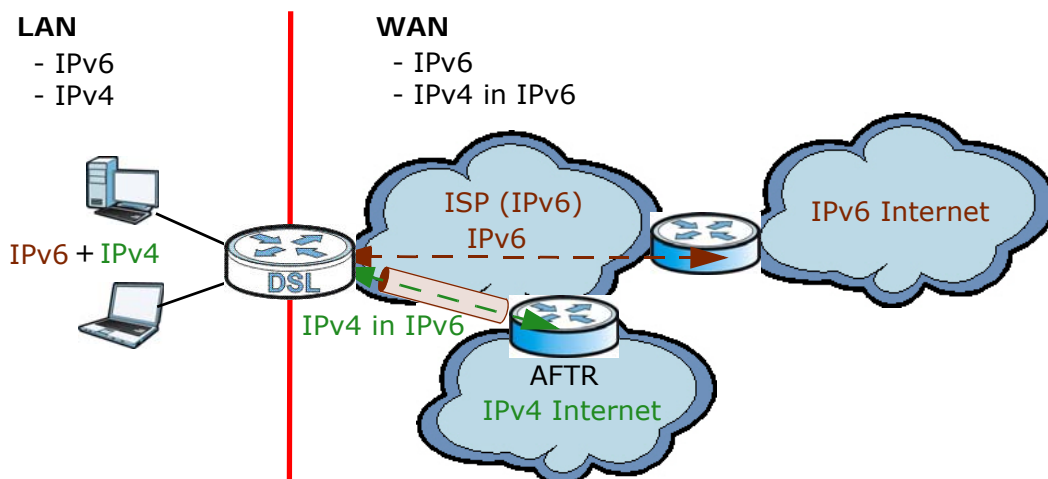

## 3G

3G (Third Generation) is a digital, packet-switched wireless technology. Bandwidth usage is optimized as multiple users share the same channel and bandwidth is only allocated to users when

they send data. It allows fast transfer of voice and non-voice data and provides broadband Internet access to mobile devices.

### Finding Out More

See [Section 5.5 on page 48](#) for technical background information on WAN.

### 5.1.3 Before You Begin

You need to know your Internet access settings such as encapsulation and WAN IP address. Get this information from your ISP.

## 5.2 The Internet Connection Screen

Use this screen to change your Device's WAN settings. Click **Network Setting > Broadband > Internet Connection**. The screen differs by the mode and encapsulation you select.

Figure 19 Network Setting &gt; Broadband &gt; Internet Connection

<b>Line</b>	
ADSL Mode	Auto Sync-Up
<b>General</b>	
Mode	Router
Encapsulation	PPPoE
User Name	ChangeMe
Password	••••••••
Service Name	
Multiplex	LLC
IPv6/IPv4 Dual Stack:	IPv4/IPv6
PPP Authentication	Auto
<b>Virtual Circuit ID</b>	
VPI	8 (Range : 0~255)
VCI	35 (Range : 32~65535)
<b>IP Address</b>	
<input checked="" type="radio"/> Obtain an IP Address Automatically	
<input type="radio"/> Static IP Address	
IP Address	0.0.0.0
<b>DNS Server</b>	
Primary DNS	Obtained From ISP 0.0.0.0
Secondary DNS	Obtained From ISP 0.0.0.0
<b>IPv6 Address</b>	
<input checked="" type="radio"/> Obtain an IP Address Automatically	
<input type="radio"/> Static IP Address	
DHCP IPv6	<input checked="" type="radio"/> DHCP&SLAAC <input type="radio"/> SLAAC <input type="radio"/> Auto <input type="radio"/> DHCP <input type="radio"/> None
DHCP PD	<input checked="" type="radio"/> Enable <input type="radio"/> Disable
WAN Identifier Type	<input type="radio"/> Manual <input checked="" type="radio"/> EUI64
WAN Identifier	
<b>Connection</b>	
<input checked="" type="radio"/> Keep Alive	
<input type="radio"/> Connect on Demand	
Max Idle Time	0 Sec
<input type="button" value="Apply"/> <input type="button" value="Cancel"/> <input type="button" value="Advanced Setup"/>	

The following table describes the labels in this screen.

**Table 3** Network Setting > Broadband >Internet Connection

LABEL	DESCRIPTION
Line	
ADSL Mode	<p>Select the kind of connection your Device uses to connect to the ISP.</p> <p>Use <b>Auto Sync-Up</b> if you are not sure which type to choose.</p> <p>Use <b>ADSLT1.413</b>, <b>ADSLG.DMT</b>, <b>ADSLG.lite</b>, <b>ADSL2</b>, <b>ADSL2+</b>, <b>ADSL2_AnnexM</b>, <b>ADSL2+_AnnexM</b>, or <b>READSL2</b> if you know the specific type of DSL the Device uses to connect to the ISP.</p>
General	
Mode	<p>Select <b>Router</b> (default) from the drop-down list box if your ISP gives you one IP address only and you want multiple computers to share an Internet account. Select <b>Bridge</b> when your ISP provides you more than one IP address and you want the connected computers to get individual IP address from ISP's DHCP server directly. If you select <b>Bridge</b>, you cannot use Firewall, DHCP server and NAT on the Device.</p>
Encapsulation	<p>Select the method of encapsulation used by your ISP from the drop-down list box. This field is available if you select <b>Router</b> in the <b>Mode</b> field.</p>
User Name	<p>(PPPoA and PPPoE encapsulation only) Enter the user name exactly as your ISP assigned. If assigned a name in the form user@domain where domain identifies a service name, then enter both components exactly as given.</p>
Password	<p>(PPPoA and PPPoE encapsulation only) Enter the password associated with the user name above.</p>
Service Name	<p>(PPPoE only) Type the name of your PPPoE service here.</p>
Multiplex	<p>This displays for an ADSL virtual channel. Select the method of multiplexing used by your ISP from the drop-down list. Choices are <b>VC-Mux</b> or <b>LLC</b>.</p>
IPv6/IPv4 Dual Stack	<p>This is not available if you select <b>PPPoA</b> in the <b>Encapsulation</b> field.</p> <p>Select <b>IPv4</b> to have the Device use only IPv4.</p> <p>Select <b>IPv4/IPv6</b> to let the Device connect to IPv4 and IPv6 networks and choose the protocol for applications according to the address type.</p> <p>Select <b>IPv6</b> to have the Device use only IPv6.</p>
PPP Authentication	<p>This is available if you select <b>PPPoE</b> or <b>PPPoA</b> in the <b>Encapsulation</b> field.</p> <p>The Device supports PAP (Password Authentication Protocol) and CHAP (Challenge Handshake Authentication Protocol). CHAP provides more security than PAP; however, PAP has higher availability on more platforms.</p> <p>Use the drop-down list box to select an authentication protocol for outgoing calls. Options are:</p> <p><b>Auto</b>- Your Device accepts either CHAP or PAP when requested by this remote node.</p> <p><b>CHAP</b> - Your Device accepts CHAP only.</p> <p><b>PAP</b> - Your Device accepts PAP only.</p>
Virtual Circuit ID	<p>VPI (Virtual Path Identifier) and VCI (Virtual Channel Identifier) define a virtual circuit. Refer to the appendix for more information.</p>
IP Address	<p>You can use these options when you set the <b>Mode</b> field to <b>Router</b> and the <b>IPv6/IPv4 Dual Stack</b> field to <b>IPv4</b> or <b>IPv4/IPv6</b>.</p> <p>Select <b>Obtain an IP Address Automatically</b> if the ISP assigns you a dynamic IP address; otherwise select <b>Static IP Address</b> and type your ISP assigned IP address in the <b>IP Address</b> field below.</p>
Static IP Address	<p>Select this option If the ISP assigned a fixed IP address.</p>

**Table 3** Network Setting > Broadband > Internet Connection (continued)

LABEL	DESCRIPTION
IP Address	Enter the static IP address provided by your ISP.
IPv6 Tunnel Mode	This is available if you select <b>ENET ENCAP</b> or <b>PPPoE</b> in the <b>Encapsulation</b> field and <b>IPv4</b> in the <b>IPv6/IPv4 Dual Stack</b> field.  Select <b>6rd</b> to tunnel IPv6 traffic from the local network through the ISP's IPv4 network.  Select <b>6to4</b> to enable IPv6 to IPv4 tunneling. This will encapsulate IPv6 packets in IPv4 packets so they can travel through IPv4 networks.
Relay Server	If you select <b>6to4</b> in the <b>IPv6 Tunnel Mode</b> field, enter the tunneling relay server's IPv4 address in this field.
Via DHCP Option 212	Select this to have the Device detect it automatically through DHCP option 212.
Manual	Select this to manually enter the following 6rd information.
6rd Prefix	Enter an IPv6 prefix for tunneling IPv6 traffic to the ISP's Border Relay router and connecting to the native IPv6 Internet.
6rd Prefix Length	Enter the IPv6 prefix length.
IPv4 Mask Length	Enter the subnet mask number for the IPv4 network.
Relay Server	Enter the relay server's IPv4 address.
DNS Server	
Primary / Secondary DNS	Set how the Device gets the IP addresses of the DNS servers it uses.  <b>UserDefined</b> - enter a static IP address.  <b>Obtained From ISP</b> - when the Device gets its IP address automatically, you can select this to have it also get the DNS server address.  <b>None</b> - the Device does not use the DNS server entry.
IPv6 Address	
Obtain an IP Address Automatically	Select this option to have the Device use the IPv6 prefix from the connected router's Router Advertisement (RA) to generate an IPv6 address.
Static IP Address	When you set the <b>Encapsulation</b> field to <b>ENET ENCAP</b> , select the <b>Static IP Address</b> option if you have a fixed IPv6 address assigned by your ISP.
DHCP IPv6	Select <b>DHCP&amp;SLAAC</b> to have the use both DHCPv6 and SLAAC to get an IP address.  Select <b>DHCP</b> to obtain an IPv6 address from a DHCPv6 server. The IP address assigned by a DHCPv6 server has priority over the IP address automatically generated by the Device using the IPv6 prefix from an RA.  Select <b>Auto</b> to have the Device try to use DHCPv6 to get an IP address and then SLAAC if DHCPv6 does not work.  Select <b>SLAAC</b> (Stateless address autoconfiguration) to have the Device use the prefix to automatically generate a unique IP address that does not need to be maintained by a DHCP server.  Select <b>None</b> if you do not want the Device to obtain an IPv6 address from a DHCPv6 server.
DHCP PD	Select <b>Enable</b> to use <b>DHCP PD</b> (Prefix Delegation) to allow the Device to pass the IPv6 prefix information to its LAN hosts. The hosts can then use the prefix to generate their IPv6 addresses.
Dual Stack Lite	The Dual Stack Lite fields display when you set the <b>IPv6/IPv4 Dual Stack</b> field to <b>IPv6</b> . Enable Dual Stack Lite to let local computers use IPv4 through an ISP's IPv6 network.

**Table 3** Network Setting > Broadband > Internet Connection (continued)

LABEL	DESCRIPTION
Mode	Select <b>Manual</b> if you have the IPv6 address of the Address Family Transition Router (AFTR), otherwise select <b>Auto</b> to have the Device detect it automatically through DHCPv6.
Remote IPv6 Address	When you set the <b>Mode</b> field to <b>Manual</b> , specify the AFTR IPv6 address.
IPv6 Address	When you enable <b>Static IP Address</b> , enter the IPv6 address of the Device in the WAN.
Prefix Length	When you enable <b>Static IP Address</b> , enter the IPv6 prefix length in the WAN here.
IPv6 Default Gateway	When you enable <b>Static IP Address</b> , enter the IPv6 address of the default gateway here.
IPv6 DNS Server1	When you enable <b>Static IP Address</b> , enter the primary DNS server IPv6 address here.
IPv6 DNS Server2	When you enable <b>Static IP Address</b> , enter the secondary DNS server IPv6 address here.
WAN Identifier Type	Select <b>Manual</b> to manually enter a WAN Identifier as the interface ID to identify the WAN interface. The Device appends the WAN Identifier to the IPv6 address prefix to create the routable global IPv6 address. Select <b>EUI 64</b> to use the EUI-64 format to generate an interface ID from the MAC address of the WAN interface.
WAN Identifier	If you selected <b>Manual</b> , enter the WAN Identifier in this field. The WAN identifier should be unique and 64 bits in hexadecimal form. Every 16 bit block should be separated by a colon as in XXXX:XXXX:XXXX:XXXX where X represents a hexadecimal character. Blocks of zeros can be represented with double colons as in XXXX:XXXX::XXXX.
Connection (PPPoA and PPPoE encapsulation only)	
Keep Alive	Select <b>Keep Alive</b> when you want your connection up all the time. The Device will try to bring up the connection automatically if it disconnects.
Connect on Demand	Select <b>Connect on Demand</b> when you don't want the connection up all the time and specify an idle time-out in the <b>Max Idle Timeout</b> field.
Max Idle Time	Specify an idle time-out in the <b>Max Idle Timeout</b> field when you select <b>Connect on Demand</b> . The default setting of 0 means the Internet session will not timeout.
Apply	Click this to save your changes.
Cancel	Click this to restore your previously saved settings.
Advanced Setup	Click this to display the <b>Advanced Internet Connection</b> section and edit more details of your WAN setup.

## 5.2.1 Advanced Internet Connection

Use this screen to edit your Device's advanced WAN settings. Click the **Advanced Setup** button in the **Internet Connection** screen. The screen appears as shown.

Figure 20 Internet Connection: Advanced Setup

RIP & Multicast Setup	
RIP Direction	None
RIP Version	N/A
Multicast	None
MLD Proxy	None
ATM QoS	
ATM QoS Type	UBR With PCR
Peak Cell Rate	0 cell/sec
Sustain Cell Rate	0 cell/sec
Maximum Burst Size	0 cell
PPPoE Passthrough	No
MTU	
MTU	1492
<input type="button" value="Apply"/> <input type="button" value="Cancel"/> <input type="button" value="Advanced Setup"/>	

The following table describes the labels in this screen.

Table 4 Internet Connection: Advanced Setup

LABEL	DESCRIPTION
RIP & Multicast Setup	This section does not apply when you configure the Device to bridge mode.
RIP Direction	RIP (Routing Information Protocol) allows a router to exchange routing information with other routers. Use this field to control how much routing information the Device sends and receives on the subnet.  Select the RIP direction from <b>None</b> , <b>Both</b> , <b>In Only</b> and <b>Out Only</b> .
RIP Version	This field does not apply if you select <b>None</b> in the <b>RIP Direction</b> field.  Select the RIP version from <b>RIP-1</b> , <b>RIP-2B/RIP-2M</b> .
Multicast	Multicast packets are sent to a group of computers on the LAN and are an alternative to unicast packets (packets sent to one computer) and broadcast packets (packets sent to every computer).  Devices use the IGMP (Internet Group Management Protocol) network-layer protocol to establish membership in a multicast group. Select <b>IGMP v1/IGMP v2/IGMP v3</b> . Select <b>None</b> to disable it.
MLD Proxy	Select the version of MLD proxy (v1 or v2) to have the Device act as for this connection. This allows the Device to get subscription information and maintain a joined member list for each multicast group. It can reduce multicast traffic significantly. Select <b>None</b> to turn off MLD proxy.
ATM QoS	This section is available when the connection's <b>Virtual Channel</b> field is set to an ADSL option.
ATM QoS Type	Select <b>CBR</b> (Continuous Bit Rate) to specify fixed (always-on) bandwidth for voice or data traffic. Select <b>UBR With PCR</b> (Unspecified Bit Rate with Peak Cell Rate) for applications that are non-time sensitive, such as e-mail. Select <b>Non Realtime VBR</b> (Variable Bit Rate-non Real Time) or <b>Realtime VBR</b> (Variable Bit Rate-Real Time) for bursty traffic and bandwidth sharing with other applications.













**Table 4** Internet Connection: Advanced Setup (continued)

LABEL	DESCRIPTION
Peak Cell Rate	Divide the DSL line rate (bps) by 424 (the size of an ATM cell) to find the Peak Cell Rate (PCR). This is the maximum rate at which the sender can send cells. Type the PCR here.
Sustain Cell Rate	The Sustain Cell Rate (SCR) sets the average cell rate (long-term) that can be transmitted. Type the SCR, which must be less than the PCR. Note that system default is 0 cells/sec.
Maximum Burst Size	Maximum Burst Size (MBS) refers to the maximum number of cells that can be sent at the peak rate. Type the MBS, which is less than 65535.
PPPoE Passthrough	If the encapsulation type is PPPoE, select this to enable PPPoE Passthrough. In addition to the Device's built-in PPPoE client, you can select this to allow hosts on the LAN to use PPPoE client software on their computers to connect to the ISP via the device. Each host can have a separate account and a public WAN IP address.
MTU	
MTU	The Maximum Transmission Unit (MTU) defines the size of the largest packet allowed on an interface or connection. Enter the MTU in this field.  For ENET ENCAP, the MTU value is 1500.  For PPPoE, the MTU value is 1492.  For PPPoA and RFC 1483, the MTU is 65535.
Apply	Click this to save your changes.
Cancel	Click this to restore your previously saved settings.
Advanced Setup	Click this to close the <b>Advanced Internet Connection</b> section.

## 5.3 The More Connections Screen

The Device allows you to configure more than one Internet access connection. To configure additional Internet access connections click **Network Setting > Broadband > More Connections**. The screen differs by the encapsulation you select. When you use the **Broadband > Internet Connection** screen to set up Internet access, you are configuring the first WAN connection.

**Figure 21** Network Setting > Broadband > More Connections

#	Activ	Node Name	VPI/VCI	Encapsulation	Modify
1	<input checked="" type="checkbox"/>	Wan_ADSL_VC0	8/35	PPPoE LLC	
2	<input type="checkbox"/>	N/A	--	--	 
3	<input type="checkbox"/>	N/A	--	--	 
4	<input type="checkbox"/>	N/A	--	--	 
5	<input type="checkbox"/>	N/A	--	--	 
6	<input type="checkbox"/>	N/A	--	--	 
7	<input type="checkbox"/>	N/A	--	--	 
8	<input type="checkbox"/>	N/A	--	--	 



The following table describes the labels in this screen.

**Table 5** Network Setting > Broadband > More Connections

LABEL	DESCRIPTION
#	This is an index number indicating the number of the corresponding connection.
Active	This field indicates whether the connection is active or not. This field is read-only.
Node Name	This is the name of the Internet connection.
VPI/VCI	This field displays the Virtual Path Identifier (VPI) and Virtual Channel Identifier (VCI) numbers configured for this WAN connection.
Encapsulation	This field indicates the encapsulation method and multiplexing type the Internet connection uses.
Modify	<p>The first (ISP) connection is read-only in this screen. Use the <b>Broadband &gt; Internet Connection</b> screen to edit it.</p> <p>Click the <b>Edit</b> icon to edit the Internet connection settings. Click this icon on an empty configuration to add a new Internet access setup.</p> <p>Click the <b>Remove</b> icon to delete the Internet access setup from your connection list.</p>

### 5.3.1 More Connections Edit

Use this screen to configure a connection. Click the **Edit** icon in the **More Connections** screen to display the following screen.

Figure 22 More Connections: Edit

The following table describes the labels in this screen.

Table 6 More Connections: Edit

LABEL	DESCRIPTION
General	
Active	Select the check box to activate or clear the check box to deactivate this connection.
Node Name	Enter a unique, descriptive name of up to 13 ASCII characters for this connection.
Mode	Select <b>Router</b> from the drop-down list box if your ISP allows multiple computers to share an Internet account.  If you select <b>Bridge</b> , the Device will forward any packet that it does not route to this remote node; otherwise, the packets are discarded.
Encapsulation	Select the method of encapsulation used by your ISP from the drop-down list box. This field is available if you select <b>Router</b> in the <b>Mode</b> field.
User Name	(PPPoA and PPPoE encapsulation only) Enter the user name exactly as your ISP assigned. If assigned a name in the form user@domain where domain identifies a service name, then enter both components exactly as given.
Password	(PPPoA and PPPoE encapsulation only) Enter the password associated with the user name above.

**Table 6** More Connections: Edit (continued)

LABEL	DESCRIPTION
Service Name	(PPPoE only) Type the name of your PPPoE service here.
Multiplex	<p>Select the method of multiplexing used by your ISP from the drop-down list. Choices are <b>VC-Mux</b> or <b>LLC</b>.</p> <p>By prior agreement, a protocol is assigned a specific virtual circuit, for example, VC1 will carry IP. If you select VC-mux, specify separate VPI and VCI numbers for each protocol.</p> <p>For LLC-based multiplexing or PPP encapsulation, one VC carries multiple protocols with protocol identifying information being contained in each packet header. In this case, only one set of VPI and VCI numbers need be specified for all protocols.</p>
IPv6/IPv4 Dual Stack	<p>Select <b>IPv4</b> to have the Device use only IPv4.</p> <p>Select <b>IPv4/IPv6</b> to let the Device connect to IPv4 and IPv6 networks and choose the protocol for applications according to the address type.</p> <p>Select <b>IPv6</b> to have the Device use only IPv6.</p>
PPP Authentication	<p>The Device supports PAP (Password Authentication Protocol) and CHAP (Challenge Handshake Authentication Protocol). CHAP is more secure than PAP; however, PAP is readily available on more platforms.</p> <p>Use the drop-down list box to select an authentication protocol for outgoing calls. Options are:</p> <p><b>AUTO</b> - Your Device accepts either CHAP or PAP when requested by this remote node.</p> <p><b>CHAP</b> - Your Device accepts CHAP only.</p> <p><b>PAP</b> - Your Device accepts PAP only.</p>
VPI, VCI	VPI (Virtual Path Identifier) and VCI (Virtual Channel Identifier) define a virtual circuit. Refer to the appendix for more information.
IP Address	<p>You can use these options when you set the <b>Mode</b> field to <b>Router</b> and the <b>IPv6/IPv4 Dual Stack</b> field to <b>IPv4</b> or <b>IPv4/IPv6</b>.</p> <p>Select <b>Obtain an IP Address Automatically</b> if the ISP assigns you a dynamic IP address; otherwise select <b>Static IP Address</b> and type your ISP assigned IP address in the <b>IP Address</b> field below.</p>
Static IP Address	Select this option if the ISP assigned a fixed IP address.
IP Address	Enter the static IP address provided by your ISP.
Subnet Mask	Enter a subnet mask in dotted decimal notation.
Gateway IP Address	Specify a gateway IP address (supplied by your ISP).
Primary / Secondary DNS	<p>Set how the Device gets the IP addresses of the DNS servers it uses.</p> <p><b>UserDefined</b> - enter a static IP address.</p> <p><b>Obtained From ISP</b> - when the Device gets its IP address automatically, you can select this to have it also get the DNS server address.</p> <p><b>None</b> - the Device does not use the DNS server entry.</p>
IPv6 Address	
Obtain an IP Address Automatically	Select this option if you want to have the Device use the IPv6 prefix from the connected router's Router Advertisement (RA) to generate an IPv6 address.
Static IP Address	Select this option if you have a fixed IPv6 address assigned by your ISP.

**Table 6** More Connections: Edit (continued)

LABEL	DESCRIPTION
DHCP IPv6	Select <b>DHCP</b> if you want to obtain an IPv6 address from a DHCPv6 server.  The IP address assigned by a DHCPv6 server has priority over the IP address automatically generated by the Device using the IPv6 prefix from an RA.  Select <b>SLAAC</b> (Stateless address autoconfiguration) to have the Device use the prefix to automatically generate a unique IP address that does not need to be maintained by a DHCP server.
DHCP PD	Select <b>Enable</b> to use <b>DHCP PD</b> (Prefix Delegation) to allow the Device to pass the IPv6 prefix information to its LAN hosts. The hosts can then use the prefix to generate their IPv6 addresses.
IPv6 Address	With <b>Static IP Address</b> enabled, enter the IPv6 address of the Device in the WAN.
Prefix Length	With <b>Static IP Address</b> enabled, enter the IPv6 prefix length in the WAN.
IPv6 Default Gateway	With <b>Static IP Address</b> enabled, enter the IPv6 address of the default gateway
IPv6 DNS Server1	With <b>Static IP Address</b> enabled, enter the primary DNS server IPv6 address for the Device.
IPv6 DNS Server2	With <b>Static IP Address</b> enabled, enter the secondary DNS server IPv6 address for the Device.
Connection	
Keep Alive	Select <b>Keep Alive</b> when you want your connection up all the time. The Device will try to bring up the connection automatically if it disconnects.
Connect on Demand	Select <b>Connect on Demand</b> when you don't want the connection up all the time and specify an idle time-out in the <b>Max Idle Timeout</b> field.
Max Idle Timeout	Specify an idle time-out in the <b>Max Idle Timeout</b> field when you select <b>Connect on Demand</b> . The default setting of 0 means the Internet session will not timeout.
NAT	If you set the <b>Mode</b> field to <b>Router</b> , you can select <b>SUA Only</b> if you have one public IP address and want to use NAT.  Otherwise, select <b>None</b> to disable NAT.
Back	Click this to return to the previous screen without saving.
Apply	Click this to save your changes.
Advanced Setup	Click this to display the <b>More Connections Advanced Setup</b> screen and edit more details of your WAN setup.

### 5.3.2 Configuring More Connections Advanced Setup

Use this screen to edit your Device's advanced WAN settings. Click the **Advanced Setup** button in the **More Connections Edit** screen. The screen appears as shown.

Figure 23 More Connections: Edit: Advanced Setup

The following table describes the labels in this screen.

Table 7 More Connections: Edit: Advanced Setup

LABEL	DESCRIPTION
RIP & Multicast Setup	
RIP Direction	Select the <b>RIP Direction</b> from <b>None</b> , <b>Both</b> , <b>In Only</b> and <b>Out Only</b> .
RIP Version	You do not configure this field if you set the <b>RIP Direction</b> field to <b>None</b> . Select the <b>RIP Version</b> from <b>RIP-1</b> , <b>RIP-2B/RIP-2M</b> .
Multicast	Devices use the IGMP (Internet Group Management Protocol) network-layer protocol to establish membership in a multicast group. Select <b>IGMP v1/IGMP-v2/IGMP-v3</b> . Select <b>None</b> to disable it.
MLD Proxy	Select the version of MLD proxy (v1 or v2) to have the Device act as for this connection. This allows the Device to get subscription information and maintain a joined member list for each multicast group. It can reduce multicast traffic significantly. Select <b>None</b> to turn off MLD proxy.
ATM QoS	
ATM QoS Type	Select <b>CBR</b> (Continuous Bit Rate) to specify fixed (always-on) bandwidth for voice or data traffic. Select <b>UBR With PCR</b> (Unspecified Bit Rate with Peak Cell Rate) for applications that are non-time sensitive, such as e-mail. Select <b>Non Realtime VBR</b> (Variable Bit Rate-non Real Time) or <b>Realtime VBR</b> (Variable Bit Rate-Real Time) for bursty traffic and bandwidth sharing with other applications.
Peak Cell Rate	Divide the DSL line rate (bps) by 424 (the size of an ATM cell) to find the Peak Cell Rate (PCR). This sets the maximum rate at which the sender can send cells. Type the PCR here.
Sustain Cell Rate	The Sustain Cell Rate (SCR) sets the average cell rate (long-term) that can be transmitted. Type the SCR, which must be less than the PCR. Note the system default of 0 cells/sec.
Maximum Burst Size	Maximum Burst Size (MBS) refers to the maximum number of cells that can be sent at the peak rate. Type the MBS (less than 65535).

**Table 7** More Connections: Edit: Advanced Setup (continued)

LABEL	DESCRIPTION
PPPoE Passthrough	When using the PPPoE the encapsulation type, select this to enable PPPoE passthrough. In addition to the Device's built-in PPPoE client, this allows hosts on the LAN to use PPPoE client software on their computers to connect to the ISP through the Device. Each host can have a separate account and a public WAN IP address.
MTU	
MTU	The Maximum Transmission Unit (MTU) defines the size of the largest packet allowed on an interface or connection. Enter the MTU in this field.  For ENET ENCAP, the MTU value equals 1500.  For PPPoE, the MTU value equals 1492.  For PPPoA and RFC, the MTU equals 100-1500.
Apply	Click this to save your changes.
Cancel	Click this to restore your previously saved settings.

## 5.4 The 3G Backup Screen

Use this screen to configure your 3G settings. Click **Network Setting > Broadband > 3G Backup**.

Note: The actual data rate you obtain varies depending the 3G card you use, the signal strength to the service provider's base station, and so on.

If the signal strength of a 3G network is too low, the 3G card may switch to an available 2.5G or 2.75G network. Refer to [Section 5.5 on page 48](#) for a comparison between 2G, 2.5G, 2.75G and 3G wireless technologies.

**Figure 24** Network Setting > Broadband > 3G Backup

General	
3G Backup	<input checked="" type="checkbox"/> Enable 3G Backup
Card Description	No Card
Username	<input type="text"/> (Optional)
Password	<input type="text"/> (Optional)
PIN	<input type="text"/> (Optional) Only for unlock PIN next time (PIN remaining authentication times: N/A)
Dial String	<input type="text"/>
APN	<input type="text"/>
IP Address	
<input checked="" type="radio"/> Obtain an IP Address Automatically	
<input type="radio"/> Use the Following Static IP Address	
IP Address	<input type="text"/>
DNS Server	
<input checked="" type="radio"/> Obtain DNS Info Dynamically	
<input type="radio"/> Use the Following Static DNS IP Address	
Primary DNS Server	<input type="text"/>
Secondary DNS Server	<input type="text"/>
Connection	
<input checked="" type="radio"/> Keep Alive	
<input type="radio"/> Connect on Demand	Max Idle Time <input type="text"/> Sec
<input type="button" value="Apply"/> <input type="button" value="Cancel"/>	

The following table describes the labels in this screen.

**Table 8** Network Setting > Broadband > 3G Backup

LABEL	DESCRIPTION
3G Backup	Select <b>Enable 3G Backup</b> to have the Device use the 3G connection as your WAN or a backup when the wired WAN connection fails.
Card Description	This field displays the manufacturer and model name of your 3G card if you inserted one in the Device. Otherwise, it displays <b>N/A</b> .
Username	Type the user name (of up to 70 ASCII printable characters) given to you by your service provider.
Password	Type the password (of up to 70 ASCII printable characters) associated with the user name above.
PIN	A PIN (Personal Identification Number) code is a key to a 3G card. Without the PIN code, you cannot use the 3G card.  If your ISP enabled PIN code authentication, enter the 4-digit PIN code (0000 for example) provided by your ISP. If you enter the PIN code incorrectly, the 3G card may be blocked by your ISP and you cannot use the account to access the Internet.  If your ISP disabled PIN code authentication, leave this field blank.
Dial String	Enter the phone number (dial string) used to dial up a connection to your service provider's base station. Your ISP should provide the phone number.  For example, *99# is the dial string to establish a GPRS or 3G connection in Taiwan.

**Table 8** Network Setting > Broadband > 3G Backup (continued)

LABEL	DESCRIPTION
APN Code	Enter the APN (Access Point Name) provided by your service provider. Connections with different APNs may provide different services (such as Internet access or MMS (Multi-Media Messaging Service)) and charge method.  You can enter up to 31 ASCII printable characters. Spaces are allowed.
Obtain an IP Address Automatically	Select this option If your ISP did not assign you a fixed IP address.
Use the following static IP address	Select this option If the ISP assigned a fixed IP address.
IP Address	Enter your WAN IP address in this field if you selected <b>Use the following static IP address</b> .
Obtain DNS info dynamically	Select this to have the Device get the DNS server addresses from the ISP automatically.
Use the following static DNS IP address	Select this to have the Device use the DNS server addresses you configure manually.
Primary DNS server	Enter the first DNS server address assigned by the ISP.
Secondary DNS server	Enter the second DNS server address assigned by the ISP.
Connection	Select <b>Nailed-UP</b> if you do not want the connection to time out.  Select <b>On-Demand</b> if you do not want the connection up all the time and specify an idle time-out in the <b>Max Idle Timeout</b> field.
Max Idle Timeout	This value specifies the time in minutes that elapses before the Device automatically disconnects from the ISP.
Apply	Click <b>Apply</b> to save your changes back to the Device.
Cancel	Click <b>Cancel</b> to return to the previous configuration.

## 5.5 WAN Technical Reference

This section provides some technical background information about the topics covered in this chapter.

### 5.5.1 Encapsulation

Be sure to use the encapsulation method required by your ISP. The Device supports the following methods.

#### 5.5.1.1 ENET ENCAP

The Device only implements the MAC Encapsulated Routing Link Protocol (ENET ENCAP) with the IP network protocol. IP packets get routed between the Ethernet interface and the WAN interface and then formatted to work in a bridged environment. For instance, it encapsulates routed Ethernet frames into bridged ATM cells. ENET ENCAP requires that you specify a gateway IP address in the **Gateway IP Address** field in the wizard or WAN screen. You can get this information from your ISP.



### 5.5.1.2 PPP over Ethernet

The Device supports PPPoE (Point-to-Point Protocol over Ethernet). PPPoE specifies how a personal computer (PC) interacts with a broadband modem (DSL, cable, wireless, etc.) connection. The PPPoE option provides a dial-up connection using PPPoE.

For the service provider, PPPoE offers an access and authentication method that works with existing access control systems (for example RADIUS).

PPPoE lets you access one of multiple network services, a function known as dynamic service selection. This enables the service provider to easily create and offer new IP services for individuals.

Operationally, PPPoE saves significant effort for both you and the ISP or carrier, as it requires no specific configuration of the broadband modem at the customer site.

By implementing PPPoE directly on the Device (rather than individual computers), the computers on the LAN do not need PPPoE software installed, since the Device does that part of the task. Furthermore, with NAT, all of the LANs' computers will have access.

### 5.5.1.3 PPPoA

PPPoA stands for Point to Point Protocol over ATM Adaptation Layer 5 (AAL5). A PPPoA connection functions like a dial-up Internet connection. The Device encapsulates the PPP session based on RFC 1483 and sends it through an ATM PVC (Permanent Virtual Circuit) to the Internet Service Provider's (ISP) DSLAM (Digital Subscriber Line (DSL) Access Multiplexer). Please refer to RFC 2364 for more information on PPPoA. Refer to RFC 1661 for more information on PPP.

### 5.5.1.4 RFC 1483

RFC 1483 describes two methods for Multiprotocol Encapsulation over ATM Adaptation Layer 5 (AAL5). The first method allows multiplexing of multiple protocols over a single ATM virtual circuit (LLC-based multiplexing) and the second method assumes a separate ATM virtual circuit (VC-based multiplexing) carries each protocol. Please refer to RFC 1483 for more detailed information.

## 5.5.2 Multiplexing

There are two conventions to identify what protocols the virtual circuit (VC) carries. Use the multiplexing method required by your ISP.

### VC-based Multiplexing

In this case, by prior mutual agreement, each protocol uses a specific virtual circuit; for example, VC1 carries IP, etc. VC-based multiplexing may be dominant in environments where dynamic creation of large numbers of ATM VCs is fast and economical.

### LLC-based Multiplexing

In this case one VC carries multiple protocols with protocol identifying information being contained in each packet header. Despite the extra bandwidth and processing overhead, this method may be advantageous if it is not practical to have a separate VC for each carried protocol, for example, if charging heavily depends on the number of simultaneous VCs.

### 5.5.3 VPI and VCI

Be sure to use the correct Virtual Path Identifier (VPI) and Virtual Channel Identifier (VCI) numbers assigned to you. The valid range for the VPI is 0 to 255 and for the VCI is 32 to 65535 (0 to 31 is reserved for local management of ATM traffic). Please see the appendix for more information.

### 5.5.4 IP Address Assignment

A static IP is a fixed IP that your ISP gives you. A dynamic IP is not fixed; the ISP assigns you a different one each time. The Single User Account feature can be enabled or disabled if you have either a dynamic or static IP. However the encapsulation method assigned influences your choices for IP address and ENET ENCAP gateway.

#### IP Assignment with PPPoA or PPPoE Encapsulation

If you have a dynamic IP, then the **IP Address** and **Gateway IP Address** fields are not applicable (N/A). If you have a **Static IP Address** assigned by your ISP, then they should also assign you a **Subnet Mask** and a **Gateway IP Address**.

#### IP Assignment with RFC 1483 Encapsulation

In this case the IP address assignment must be static.

#### IP Assignment with ENET ENCAP Encapsulation

In this case you can have either a static or dynamic IP. For a static IP you must fill in all the **IP Address** and **Gateway IP Address** fields as supplied by your ISP. However for a dynamic IP, the Device acts as a DHCP client on the WAN port and so the **IP Address** and **Gateway IP Address** fields are not applicable (N/A) as the DHCP server assigns them to the Device.

## 6.1 Overview

This chapter describes the Device's **Network Setting** > **Wireless** screens. Use these screens to set up your Device's wireless connection.

### 6.1.1 What You Can Do in this Chapter

- Use the **General** screen to enable the wireless LAN, enter the SSID and select the wireless security mode ([Section 6.2 on page 53](#)).
- Use the **More AP** screen to set up multiple wireless networks on your Device ([Section 6.3 on page 59](#)).
- Use the **MAC Authentication** screen to allow or deny wireless clients based on their MAC addresses from connecting to the Device ([Section 6.4 on page 61](#)).
- Use the **WPS** screen to enable or disable WPS, view or generate a security PIN (Personal Identification Number) ([Section 6.5 on page 62](#)).
- Use the **WDS** screen (see [Section 6.6 on page 64](#)) to set up a Wireless Distribution System, in which the Device acts as a bridge with other access points.
- Use the **WMM** screen to enable Wi-Fi MultiMedia (WMM) to ensure quality of service in wireless networks for multimedia applications ([Section 6.7 on page 65](#)).
- Use the **Scheduling** screen to schedule a time period for the wireless LAN to operate each day ([Section 6.8 on page 66](#)).
- Use the **Advanced** screen to configure advanced wireless features ([Section 6.9 on page 67](#)).

You don't necessarily need to use all these screens to set up your wireless connection. For example, you may just want to set up a network name, a wireless radio channel and some security in the **General** screen.

### 6.1.2 Wireless Network Overview

Wireless networks consist of wireless clients, access points and bridges.

- A wireless client is a radio connected to a user's computer.
- An access point is a radio with a wired connection to a network, which can connect with numerous wireless clients and let them access the network.
- A bridge is a radio that relays communications between access points and wireless clients, extending a network's range.

Traditionally, a wireless network operates in one of two ways.

- An "infrastructure" type of network has one or more access points and one or more wireless clients. The wireless clients connect to the access points.

- An “ad-hoc” type of network is one in which there is no access point. Wireless clients connect to one another in order to exchange information.

The following figure provides an example of a wireless network.

**Figure 25** Example of a Wireless Network

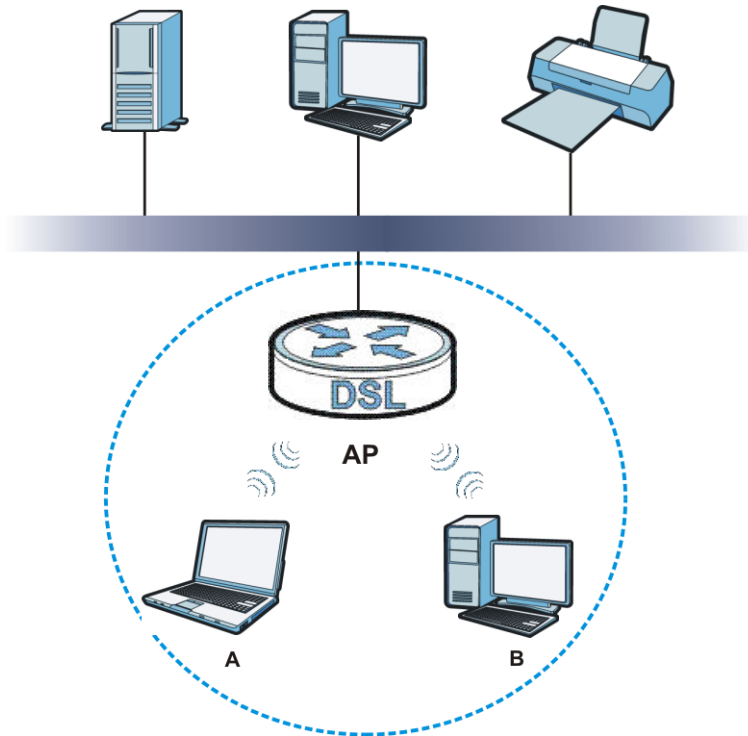

The wireless network is the part in the blue circle. In this wireless network, devices **A** and **B** use the access point (**AP**) to interact with the other devices (such as the printer) or with the Internet. Your Device is the AP.

Every wireless network must follow these basic guidelines.

- Every device in the same wireless network must use the same SSID.  
The SSID is the name of the wireless network. It stands for Service Set Identifier.
- If two wireless networks overlap, they should use a different channel.  
Like radio stations or television channels, each wireless network uses a specific channel, or frequency, to send and receive information.
- Every device in the same wireless network must use security compatible with the AP.
- Security stops unauthorized devices from using the wireless network. It can also protect the information that is sent in the wireless network.

## Radio Channels

In the radio spectrum, there are certain frequency bands allocated for unlicensed, civilian use. For the purposes of wireless networking, these bands are divided into numerous channels. This allows a variety of networks to exist in the same place without interfering with one another. When you create a network, you must select a channel to use.

Since the available unlicensed spectrum varies from one country to another, the number of available channels also varies.

### 6.1.3 Before You Begin

Before you start using these screens, ask yourself the following questions. See [Section 6.10 on page 69](#) if some of the terms used here do not make sense to you.

- What wireless standards do the other wireless devices support (IEEE 802.11g, for example)? What is the most appropriate standard to use?
- What security options do the other wireless devices support (WPA2-PSK, for example)? What is the best one to use?
- Do the other wireless devices support WPS (Wi-Fi Protected Setup)? If so, you can set up a well-secured network very easily.

Even if some of your devices support WPS and some do not, you can use WPS to set up your network and then add the non-WPS devices manually, although this is somewhat more complicated to do.

- What advanced options do you want to configure, if any? If you want to configure advanced options, ensure that you know precisely what you want to do. If you do not want to configure advanced options, leave them alone.

## 6.2 Wireless General Screen

Use this screen to enable the Wireless LAN, enter the SSID and select the wireless security mode.

**Note:** If you are configuring the Device from a computer connected to the wireless LAN and you change the Device's SSID or security settings, you will lose your wireless connection when you press **Apply** to confirm. You must then change the wireless settings of your computer to match the Device's new settings.

Click **Network Setting > Wireless** to open the **General** screen. Select the **Enable Wireless LAN** checkbox to show the Wireless configurations.

**Figure 26** Network Setting > Wireless > General

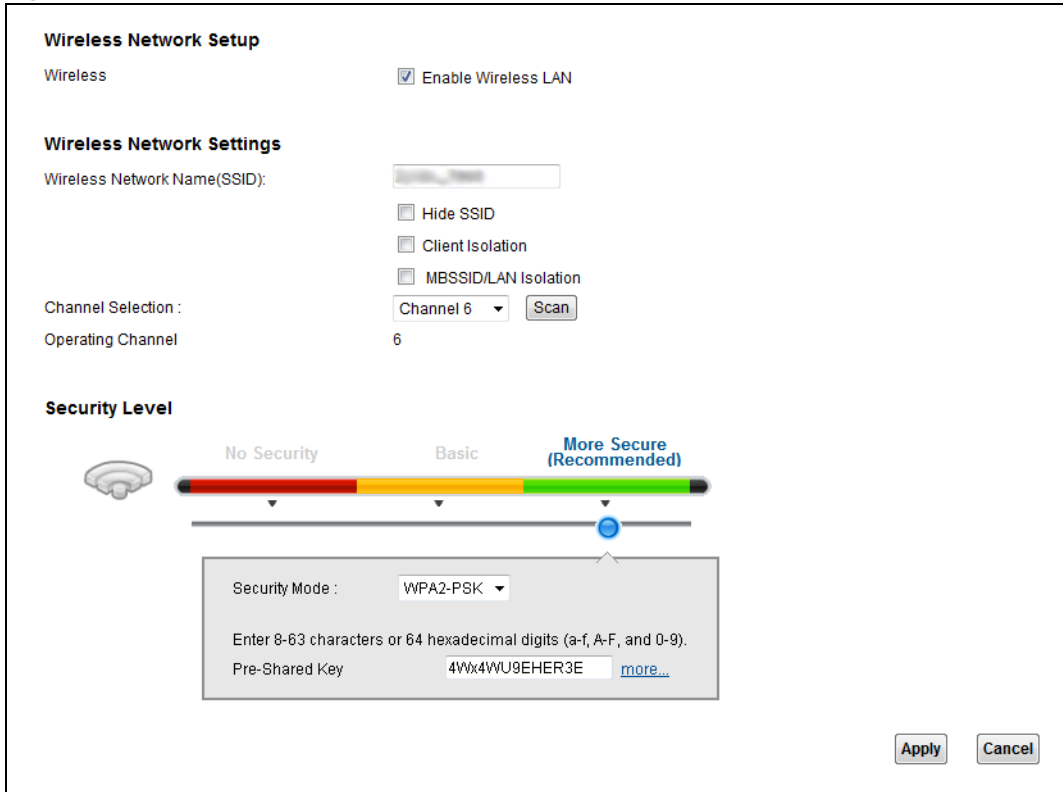

The following table describes the labels in this screen.

**Table 9** Network > Wireless LAN > General

LABEL	DESCRIPTION
Wireless Network Setup	
Wireless	Select the <b>Enable Wireless LAN</b> check box to activate the wireless LAN.  Note: You must also set the Device's physical <b>WLAN ON/OFF</b> button to <b>ON</b> to use wireless LAN. The <b>WLAN</b> LED should be on.
Wireless Network Settings	
Wireless Network Name (SSID)	The SSID (Service Set IDentity) identifies the service set with which a wireless device is associated. Wireless devices associating to the access point (AP) must have the same SSID.  Enter a descriptive name (up to 32 English keyboard characters) for the wireless LAN.
Hide SSID	Select this check box to hide the SSID in the outgoing beacon frame so a station cannot obtain the SSID through scanning using a site survey tool.
Client Isolation	Select this to keep the wireless clients in this SSID from communicating with each other directly through the Device.
MBSSID/LAN Isolation	Select this to keep the wireless clients in this SSID from communicating with clients in other SSIDs or wired LAN devices through the Device.  Select both <b>Client Isolation</b> and <b>MBSSID/LAN Isolation</b> to allow this SSID's wireless clients to only connect to the Internet through the Device.

**Table 9** Network > Wireless LAN > General (continued)

LABEL	DESCRIPTION
Channel Selection	Set the channel depending on your particular region.  Select a channel or use <b>Auto</b> to have the Device automatically determine a channel to use. If you are having problems with wireless interference, changing the channel may help. Try to use a channel that is as many channels away from any channels used by neighboring APs as possible. The channel number which the Device is currently using then displays in the <b>Operating Channel</b> field.
Scan	Click this button to have the Device immediately scan for and select a channel (which is not used by another device) whenever the device reboots or the wireless setting is changed.
Operating Channel	This is the channel currently being used by your AP.
Security Level	
Security Mode	Select <b>Basic</b> or <b>More Secure</b> to add security on this wireless network. The wireless clients which want to associate to this network must have same wireless security settings as the Device. When you select to use a security, additional options appears in this screen.  Or you can select <b>No Security</b> to allow any client to associate with this network without any data encryption or authentication.  See the following sections for more details about wireless security modes.
Apply	Click <b>Apply</b> to save your changes back to the Device.
Cancel	Click <b>Cancel</b> to restore your previously saved settings.

## 6.2.1 No Security

Select **No Security** to allow wireless stations to communicate with the access points without any data encryption or authentication.

Note: If you do not enable any wireless security on your Device, your network is accessible to any wireless networking device that is within range.

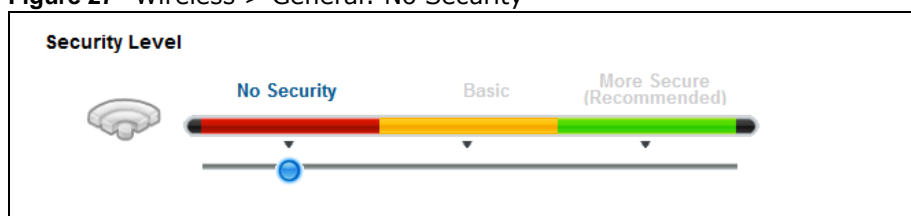
**Figure 27** Wireless > General: No Security

The following table describes the labels in this screen.

**Table 10** Wireless > General: No Security

LABEL	DESCRIPTION
Security Level	Choose <b>No Security</b> from the sliding bar.

## 6.2.2 Basic (Static WEP/Shared WEP Encryption)

WEP encryption scrambles the data transmitted between the wireless stations and the access points (AP) to keep network communications private. Both the wireless stations and the access points must use the same WEP key.

There are two types of WEP authentication namely, Open System (**Static WEP**) and Shared Key (**Shared WEP**).

Open system is implemented for ease-of-use and when security is not an issue. The wireless station and the AP or peer computer do not share a secret key. Thus the wireless stations can associate with any AP or peer computer and listen to any transmitted data that is not encrypted.

Shared key mode involves a shared secret key to authenticate the wireless station to the AP or peer computer. This requires you to enable the wireless LAN security and use same settings on both the wireless station and the AP or peer computer.

In order to configure and enable WEP encryption, click **Network Settings > Wireless** to display the **General** screen. Select **Basic** as the security level. Then select **Static WEP** or **Shared WEP** from the **Security Mode** list.

**Figure 28** Wireless > General: Basic (Static WEP/Shared WEP)

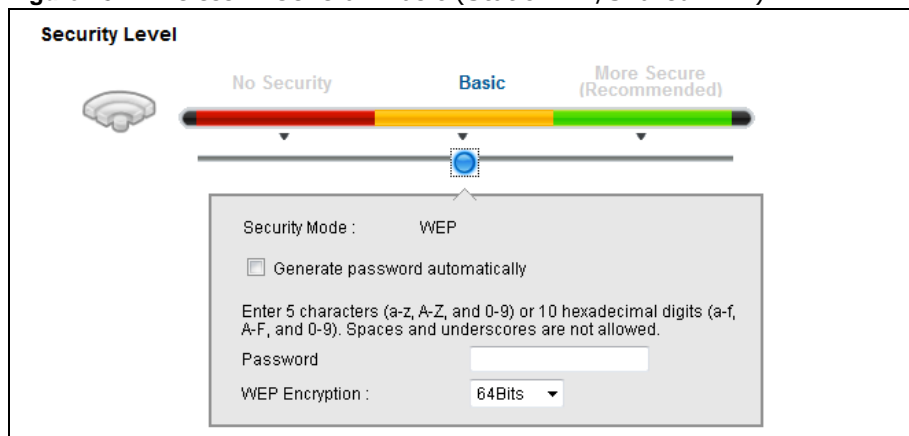

The following table describes the labels in this screen.

**Table 11** Wireless > General: Basic (Static WEP/Shared WEP)

LABEL	DESCRIPTION
Security Level	Select <b>Basic</b> to enable WEP data encryption.
Generate password automatically	Select this option to have the Device automatically generate a password. The password field will not be configurable when you select this option.
Password 1~4	The password (WEP key) is used to encrypt data. Both the Device and the wireless stations must use the same password (WEP key) for data transmission.  If you chose <b>64-bit</b> WEP, then enter any 5 ASCII characters or 10 hexadecimal characters ("0-9", "A-F").  If you chose <b>128-bit</b> WEP, then enter 13 ASCII characters or 26 hexadecimal characters ("0-9", "A-F").
WEP Encryption	Select <b>64-bits</b> or <b>128-bits</b> .  This dictates the length of the security key that the network is going to use.

### 6.2.3 More Secure (WPA2-PSK)

The WPA2-PSK security mode provides both improved data encryption and user authentication over WEP. Using a Pre-Shared Key (PSK), both the Device and the connecting client share a common



password in order to validate the connection. This type of encryption, while robust, is not as strong as WPA2.

Click **Network Settings > Wireless** to display the **General** screen. Select **More Secure** as the security level. Then select **WPA2-PSK** from the **Security Mode** list.

**Figure 29** Wireless > General: More Secure: WPA2-PSK

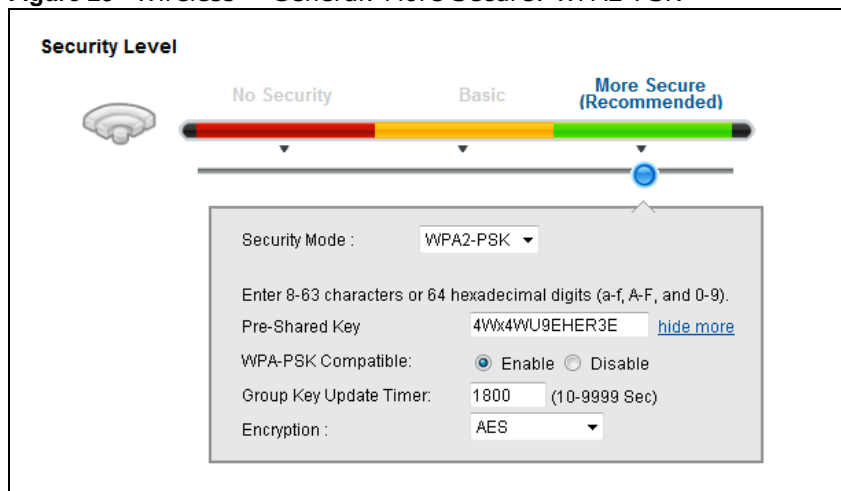

The following table describes the labels in this screen.

**Table 12** Wireless > General: WPA2-PSK

LABEL	DESCRIPTION
Security Level	Select <b>More Secure</b> to enable WPA2-PSK data encryption.
Security Mode	Select <b>WPA2-PSK</b> from the drop-down list box.
Pre-Shared Key	The encryption mechanisms used for <b>WPA2</b> and <b>WPA2-PSK</b> are the same. The only difference between the two is that <b>WPA2-PSK</b> uses a simple common password, instead of user-specific credentials.  Type a pre-shared key from 8 to 63 case-sensitive ASCII characters or 64 hexadecimal digits.
more.../hide more	Click <b>more...</b> to show more fields in this section. Click <b>hide more</b> to hide them.
WPA-PSK Compatible	Enable this to allow wireless devices using <b>WPA-PSK</b> security mode to connect to your Device. The Device supports WPA-PSK and WPA2-PSK simultaneously.
Group Key Update Timer	The <b>Group Key Update Timer</b> is the rate at which the RADIUS server sends a new group key out to all clients.
Encryption	If the security mode is <b>WPA2-PSK</b> and <b>WPA-PSK Compatible</b> is disabled, the encryption mode is set to <b>AES</b> to enable Advanced Encryption System (AES) security on your wireless network. AES provides superior security to TKIP.  If the security mode is <b>WPA2-PSK</b> and <b>WPA-PSK Compatible</b> is enabled, the encryption mode also allows you to select <b>TKIPAES MIX</b> to allow both TKIP and AES types of security in your wireless network.

## 6.2.4 WPA2 Authentication

The WPA2 security mode is currently the most robust form of encryption for wireless networks. It requires a RADIUS server to authenticate user credentials and is a full implementation the security protocol. Use this security option for maximum protection of your network. However, it is the least backwards compatible with older devices.

Click **Network Settings > Wireless** to display the **General** screen. Select **More Secure** as the security level. Then select **WPA2** from the **Security Mode** list.

**Figure 30** Wireless > General: More Secure: WPA2

The screenshot shows a configuration interface for wireless security. At the top, a 'Security Level' slider is positioned at 'More Secure (Recommended)'. Below this, a 'Security Mode' dropdown menu is set to 'WPA2'. The 'Authentication Server' section contains several fields: 'IP Address' (0.0.0.0), 'Port Number' (1812), 'Shared Secret' (with a 'hide more' link), 'ReAuthentication Timer' (1800, with a range of 60-9999 Sec), 'WPA Compatible' (radio buttons for 'Enable' and 'Disable', with 'Disable' selected), 'Group Key Update Timer' (1800, with a range of 10-9999 Sec), and 'Encryption' (AES).

The following table describes the labels in this screen.

**Table 13** Wireless > General: More Secure: WPA2

LABEL	DESCRIPTION
Security Level	Select <b>More Secure</b> to enable WPA2 data encryption.
Security Mode	Choose <b>WPA2</b> from the drop-down list box.
Authentication Server	
IP Address	Enter the IP address of the external authentication server in dotted decimal notation.
Port Number	Enter the port number of the external authentication server. The default port number is <b>1812</b> .  You need not change this value unless your network administrator instructs you to do so with additional information.
Shared Secret	Enter a password (up to 128 alphanumeric characters) as the key to be shared between the external authentication server and the Device.  The key must be the same on the external authentication server and your Device. The key is not sent over the network.
more.../hide more	Click <b>more...</b> to show more fields in this section. Click <b>hide more</b> to hide them.
ReAuthentication Timer	Specify how often wireless stations have to resend user names and passwords in order to stay connected.  The default value is 0, which means the reauthentication off.  Note: If wireless station authentication is done using a RADIUS server, the reauthentication timer on the RADIUS server has priority.
WPA Compatible	Select this if you want the Device to support WPA and WPA2 simultaneously.

**Table 13** Wireless > General: More Secure: WPA2 (continued)

LABEL	DESCRIPTION
Group Key Update Timer	The <b>Group Key Update Timer</b> is the rate at which the RADIUS server sends a new group key out to all clients.  If the value is set to "0", the update timer function is disabled.
Encryption	If the security mode is <b>WPA2</b> and <b>WPA-PSK Compatible</b> is disabled, the encryption mode is set to <b>AES</b> to enable Advanced Encryption System (AES) security on your wireless network. AES provides superior security to TKIP.  If the security mode is <b>WPA2</b> and <b>WPA-PSK Compatible</b> is enabled, the encryption mode also allows you to select <b>TKIPAES MIX</b> to allow both TKIP and AES types of security in your wireless network.

## 6.3 More AP Screen

The Device can broadcast up to four wireless network names at the same time. This means that users can connect to the Device using different SSIDs. You can secure the connection on each SSID profile so that wireless clients connecting to the Device using different SSIDs cannot communicate with each other.

This screen allows you to enable and configure multiple Basic Service Sets (BSSs) on the Device.

Click **Network Settings > Wireless > More AP**. The following screen displays.

**Figure 31** Network Settings > Wireless > More AP

#	Active	SSID	Security	Modify
1		N/A	N/A	
2		N/A	N/A	
3		N/A	N/A	

The following table describes the labels in this screen.

**Table 14** Network Settings > Wireless > More AP

LABEL	DESCRIPTION
#	This is the index number of the entry.
Active	This field indicates whether this SSID is active. A yellow bulb signifies that this SSID is active. A gray bulb signifies that this SSID is not active.
SSID	An SSID profile is the set of parameters relating to one of the Device's BSSs. The SSID (Service Set Identifier) identifies the Service Set with which a wireless device is associated.  This field displays the name of the wireless profile on the network. When a wireless client scans for an AP to associate with, this is the name that is broadcast and seen in the wireless client utility.
Security	This field indicates the security mode of the SSID profile.
Modify	Click the <b>Edit</b> icon to configure the SSID profile.

### 6.3.1 Edit More AP

Use this screen to edit an SSID profile. Click the **Edit** icon next to an SSID in the **More AP** screen. The following screen displays.

**Figure 32** Wireless > More AP: Edit

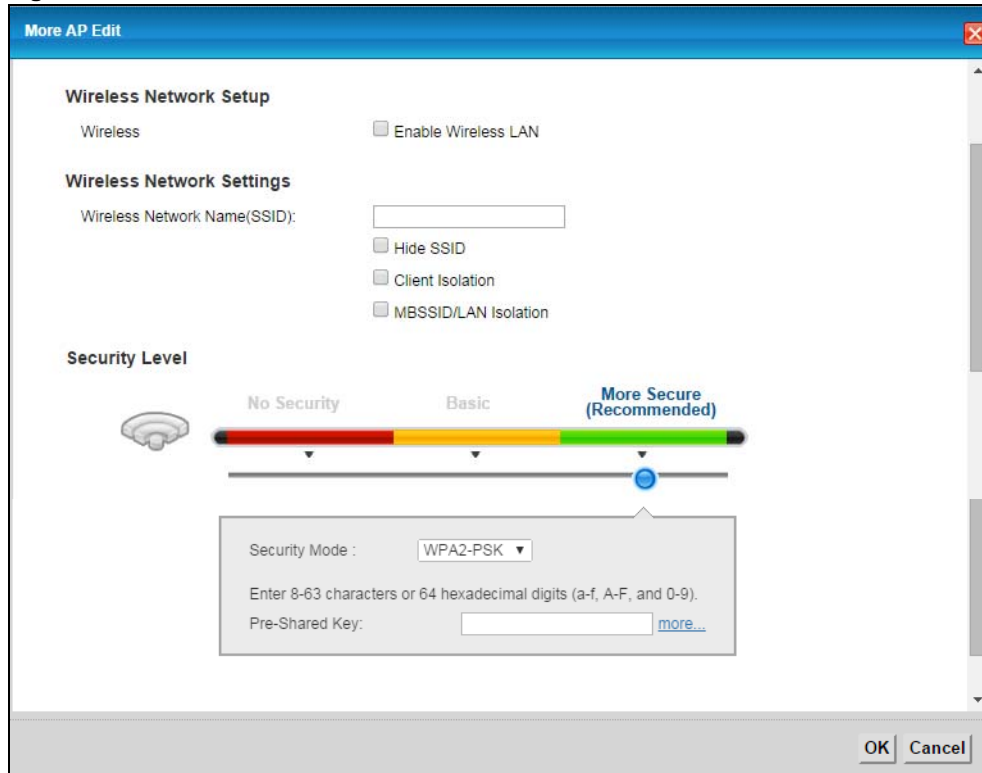

The following table describes the fields in this screen.

**Table 15** Wireless > More AP: Edit

LABEL	DESCRIPTION
Wireless Network Setup	
Wireless	Select the <b>Enable Wireless LAN</b> check box to activate the wireless LAN.
Wireless Network Settings	
Wireless Network Name (SSID)	The SSID (Service Set Identity) identifies the service set with which a wireless device is associated. Wireless devices associating to the access point (AP) must have the same SSID.  Enter a descriptive name (up to 32 English keyboard characters) for the wireless LAN.
Hide SSID	Select this check box to hide the SSID in the outgoing beacon frame so a station cannot obtain the SSID through scanning using a site survey tool.
Client Isolation	Select this to keep the wireless clients in this SSID from communicating with each other directly through the Device.
MBSSID/LAN Isolation	Select this to keep the wireless clients in this SSID from communicating with clients in other SSIDs or wired LAN devices through the Device.  Select both <b>Client Isolation</b> and <b>MBSSID/LAN Isolation</b> to allow this SSID's wireless clients to only connect to the Internet through the Device.
Security Level	

**Table 15** Wireless > More AP: Edit (continued)

LABEL	DESCRIPTION
Security Mode	Select <b>Basic (WEP)</b> or <b>More Secure (WPA2-PSK, WPA2)</b> to add security on this wireless network. Wireless clients must use the same wireless security settings as the Device to connect to the wireless LAN. After you select to use security, additional options appears in this screen.  Or you can select <b>No Security</b> to allow any client to connect to this network without any data encryption or authentication.  See <a href="#">Section 6.2.1 on page 55</a> through <a href="#">Section 6.2.4 on page 57</a> for more details about this field.
OK	Click this to save your changes.
Cancel	Click this to exit this screen without saving.

## 6.4 MAC Authentication Screen

Use this screen to configure the Device to give exclusive access to specific devices (**Allow**) or exclude specific devices from accessing the Device (**Deny**). Every Ethernet device has a unique MAC (Media Access Control) address. The MAC address is assigned at the factory and consists of six pairs of hexadecimal characters, for example, 00:A0:C5:00:00:02. You need to know the MAC addresses of the devices to configure this screen.

Use this screen to view your Device's MAC filter settings and add new MAC filter rules. Click **Network Setting > Wireless > MAC Authentication**. The screen appears as shown.

**Figure 33** Wireless > MAC Authentication

The following table describes the labels in this screen.

**Table 16** Wireless > MAC Authentication

LABEL	DESCRIPTION
SSID	Select the SSID for which you want to configure MAC filter settings.
MAC Restrict Mode	Define the filter action for the list of MAC addresses in the <b>MAC Address</b> table.  Select <b>Disable</b> to turn off MAC filtering.  Select <b>Deny</b> to block access to the Device. MAC addresses not listed will be allowed to access the Device.  Select <b>Allow</b> to permit access to the Device. MAC addresses not listed will be denied access to the Device.

**Table 16** Wireless > MAC Authentication (continued)

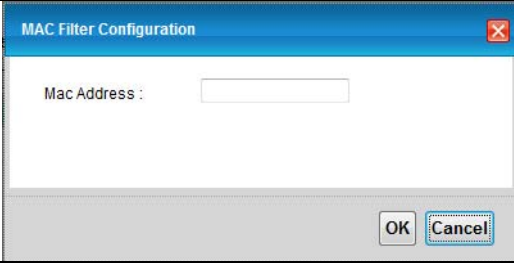
LABEL	DESCRIPTION
Add new MAC address	<p>Click this if you want to add a new MAC address entry to the MAC filter list below.</p> <p>Enter the MAC addresses of the wireless devices that are allowed or denied access to the Device in these address fields. Enter the MAC addresses in a valid MAC address format, that is, six hexadecimal character pairs, for example, 12:34:56:78:9a:bc.</p> <p><b>Figure 34</b> Wireless &gt; MAC Authentication &gt; Add new MAC address</p> 
#	This is the index number of the entry.
MAC Address	This is the MAC addresses of the wireless devices that are allowed or denied access to the Device.
Modify	Click the <b>Delete</b> icon to delete the entry.
Apply	Click <b>Apply</b> to save your changes.
Cancel	Click <b>Cancel</b> to exit this screen without saving.

## 6.5 The WPS Screen

Use this screen to configure WiFi Protected Setup (WPS) on your Device.

WPS allows you to quickly set up a wireless network with strong security, without having to configure security settings manually. Set up each WPS connection between two devices. Both devices must support WPS.

Note: The Device applies the security settings of the **SSID1** profile (see [Section 6.2 on page 53](#)). If you want to use the WPS feature, make sure you have set the security mode of **SSID1** to WPA2-PSK or WPA2-PSK/WPA-PSK mixed or no security.





Click **Network Setting > Wireless > WPS**. The following screen displays. Select **Enable** and click **Apply** to activate the WPS function. Then you can configure the WPS settings in this screen.

Figure 35 Network Setting &gt; Wireless &gt; WPS

**General**

WPS :  Enable  Disable (settings are invalid when disabled)

**Add a new device with WPS Method**

<p> <b>Method 1 PBC</b></p> <p><b>Step 1.</b> Click WPS button </p> <p><b>Step 2.</b> Press the WPS button on your new wireless client device within 120 seconds</p>	<p> <b>Method 2 PIN</b></p> <p><b>Step 1.</b> Enter the PIN of your new wireless client device and then click Register </p> <p><input style="width: 80px;" type="text"/></p> <p><b>Step 2.</b> Press the WPS button on your new wireless client device within 120 seconds</p>
--	---

**WPS Configuration Summary**

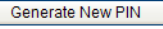
AP PIN : 00000000 

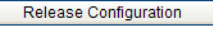
Status : Configured 

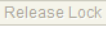
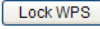
Lock Status : Unlocked  

802.11 Mode : 802.11b+g+n



SSID : XXXXXXXXXX

Security : WPA-PSK/WPA2-PSK

Pre-Shared Key : 4Wx4WU9EHER3E

**Note:**

- 1.If you enable WPS, it will turned on UPnP service automatically.
- 2.This feature is available only when WPA2-PSK, WPA-PSK/WPA2-PSK or No Security mode is configured.

The following table describes the labels in this screen.

Table 17 Network Setting &gt; Wireless &gt; WPS

LABEL	DESCRIPTION
Enable WPS	Select <b>Enable</b> and click <b>Apply</b> to activate WPS on the Device.
Add a new device with WPS Method - These fields display after you enable WPS and click <b>Apply</b> .	
Method 1 PBC	Use this section to set up a WPS wireless network using Push Button Configuration (PBC).
WPS	Click this button to add another WPS-enabled wireless device (within wireless range of the Device) to your wireless network. This button may either be a physical button on the outside of device, or a menu button similar to the <b>WPS button</b> on this screen.  Note: You must press the other wireless device's WPS button within two minutes of pressing this button.
Method 2 PIN	Use this section to set up a WPS wireless network by entering the PIN (Personal Identification Number) of the client into the Device.
Register	Enter the PIN of the device that you are setting up a WPS connection with and click <b>Register</b> to authenticate and add the wireless device to your wireless network.  You can find the PIN either on the outside of the device, or by checking the device's settings.  Note: You must also activate WPS on that device within two minutes to have it present its PIN to the Device.
WPS Configuration Summary	

**Table 17** Network Setting > Wireless > WPS (continued)

LABEL	DESCRIPTION
AP PIN	<p>The PIN of the Device is shown here. Enter this PIN in the configuration utility of the device you want to connect to using WPS.</p> <p>The PIN is not necessary when you use WPS push-button method.</p> <p>Click the <b>Generate New PIN</b> button to have the Device create a new PIN.</p>
Status	<p>This displays <b>Configured</b> when the Device has connected to a wireless network using WPS or <b>Enable WPS</b> is selected and wireless or wireless security settings have been changed. The current wireless and wireless security settings also appear in the screen.</p> <p>This displays <b>Not Configured</b> when there is no wireless or wireless security changes on the Device or you click <b>Release Configuration</b> to remove the configured wireless and wireless security settings.</p>
Release Configuration	<p>This button is available when the WPS status is <b>Configured</b>.</p> <p>Click this button to remove all configured wireless and wireless security settings for WPS connections on the Device.</p>
802.11 Mode	This is the 802.11 mode used. Only compliant WLAN devices can associate with the Device.
SSID	This is the name of the wireless network.
Security	This is the type of wireless security employed by the network.
Pre-Shared Key	This is the wireless LAN password.
Apply	Click <b>Apply</b> to save your changes.
Cancel	Click this to restore your previously saved settings.

## 6.6 The WDS Screen

An AP using the Wireless Distribution System (WDS) can function as a wireless network bridge allowing you to wirelessly connect wired network segments. The **WDS** screen allows you to configure the Device to connect to other APs wirelessly when WDS is enabled.

Use this screen to set up your WDS (Wireless Distribution System) links between the Device and other wireless APs. You need to know the MAC address of the peer device. Once the security settings of peer sides match one another, the connection between devices is made.

**Note:** WDS security is independent of the security settings between the Device and any wireless clients.

**Note:** Not all APs support WDS links. Check your other AP's documentation.

Click **Network Setting > Wireless > WDS**. The following screen displays.



**Figure 36** Network Setting > Wireless > WDS

WDS Security

TKIP (ZyAIR Series Compatible)

AES

#	Active	Remote Bridge MAC Address	PSK
1	<input checked="" type="checkbox"/>	00:00:00:00:00:00	
2	<input type="checkbox"/>	00:00:00:00:00:00	
3	<input type="checkbox"/>	00:00:00:00:00:00	
4	<input type="checkbox"/>	00:00:00:00:00:00	

Apply Cancel

The following table describes the labels in this screen.

**Table 18** Network Setting > Wireless > WDS

LABEL	DESCRIPTION
WDS Security	Select the type of the key used to encrypt data between APs. All the wireless APs (including the Device) must use the same pre-shared key for data transmission.  The option is available only when you set the security mode to <b>WPA2</b> or <b>WPA2-PSK</b> in the <b>Wireless &gt; General</b> screen.
TKIP	Select this to use TKIP (Temporal Key Integrity Protocol) encryption.
AES	Select this to use AES (Advanced Encryption Standard) encryption.
#	This is the index number of the individual WDS link.
Active	Select this to activate the link between the Device and the peer device to which this entry refers. When you do not select the check box this link is down.
Remote Bridge MAC Address	Type the MAC address of the peer device in a valid MAC address format (six hexadecimal character pairs, for example 12:34:56:78:9a:bc).
PSK	Enter a Pre-Shared Key (PSK) from 8 to 63 case-sensitive ASCII characters (including spaces and symbols).
Apply	Click this to save your changes.
Cancel	Click this to restore your previously saved settings.

## 6.7 The WMM Screen

Use this screen to enable or disable Wi-Fi MultiMedia (WMM) wireless networks for multimedia applications.

Click **Network Setting > Wireless > WMM**. The following screen displays.

**Figure 37** Network Setting > Wireless > WMM

The following table describes the labels in this screen.

**Table 19** Network Setting > Wireless > WMM

LABEL	DESCRIPTION
Enable WMM of SSID1~4	This enables the Device to automatically give a service a priority level according to the ToS value in the IP header of packets it sends. WMM QoS (Wifi MultiMedia Quality of Service) gives high priority to voice and video, which makes them run more smoothly.
Apply	Click <b>Apply</b> to save your changes.
Cancel	Click <b>Cancel</b> to restore your previously saved settings.

## 6.8 Scheduling Screen

Click **Network Setting > Wireless > Scheduling** to open the **Wireless Scheduling** screen. Use this screen to manage schedules that turn off wireless service for power saving purposes.

**Figure 38** Network Setting > Wireless > Scheduling

The following table describes the labels in this screen.

**Table 20** Network Setting > Wireless > Scheduling

LABEL	DESCRIPTION
Wireless LAN Scheduling	Select <b>Enable</b> to activate wireless LAN scheduling on your Device.
Add New Rule	Click this to create a new wireless LAN scheduling rule.
#	This is the index number of the entry.
Rule Name	This field shows the name configured for the scheduling rule.
Days	This field displays to which days of the week the schedule applies.

**Table 20** Network Setting > Wireless > Scheduling (continued)

LABEL	DESCRIPTION
Start Time	This field displays the time (in 24-hour time format) the rule turns off the wireless LAN.
End Time	This field displays the time (in 24-hour time format) the rule turns the wireless LAN back on.
Security	This field indicates the security mode of the SSID profile.
Modify	Click the <b>Edit</b> icon to configure the scheduling rule. Click the <b>Delete</b> icon to remove the scheduling rule.
Apply	Click <b>Apply</b> to save your changes.
Cancel	Click <b>Cancel</b> to restore your previously saved settings.

## 6.8.1 Add or Edit Schedule

Use this screen to add or edit a wireless LAN schedule. In the **Network Setting > Wireless > Scheduling** screen, click **Add New Rule** or the **Edit** icon next to an existing schedule. The following screen displays.

**Figure 39** Network Setting > Wireless > Scheduling > Add New Rule

The following table describes the fields in this screen.

**Table 21** Network Setting > Wireless > Scheduling > Add New Rule

LABEL	DESCRIPTION
From Schedule Rules	To create a new scheduling rule based off an existing one, select it here.
Rule Name	Specify a descriptive name to identify the scheduling rule.
Day	Select the days of the week to which to apply the schedule.
Time of Day Range	Enter the wireless LAN service start and end times in 24-hour time format.
Apply	Click <b>Apply</b> to save your changes.
Cancel	Click <b>Cancel</b> to exit this screen without saving.

## 6.9 Advanced Screen

Use this screen to configure advanced wireless settings. Click **Network Setting > Wireless > Advanced**, the screen appears as shown.

See [Section 6.10.1 on page 69](#) for detailed definitions of the terms listed in this screen.

**Figure 40** Network Setting > Wireless> Advanced

Fragmentation Threshold:	<input type="text" value="2346"/> (256 ~ 2346, even numbers only)
Output Power :	<input type="text" value="100%"/> ▼
Preamble :	<input type="text" value="Long"/> ▼
802.11 Mode :	<input type="text" value="802.11b+g+n"/> ▼
Channel Width :	<input type="text" value="Auto"/> ▼
<input type="button" value="Apply"/> <input type="button" value="Cancel"/>	

The following table describes the labels in this screen.

**Table 22** Network Setting > Wireless> Advanced

LABEL	DESCRIPTION
Fragmentation Threshold	This is the maximum data fragment size that can be sent. Enter a value between 256 and 2346.
Output Power	Set the output power of the Device. If there is a high density of APs in an area, decrease the output power to reduce interference with other APs. Select one of the following: <b>100%</b> , <b>75%</b> , <b>50%</b> or <b>25%</b> .
Preamble	Select a preamble type from the drop-down list menu. Choices are <b>Long</b> or <b>Short</b> .
802.11 Mode	<p>Select <b>802.11b</b> to allow only IEEE 802.11b compliant WLAN devices to associate with the Device.</p> <p>Select <b>802.11g</b> to allow only IEEE 802.11g compliant WLAN devices to associate with the Device.</p> <p>Select <b>802.11b+g</b> to allow either IEEE 802.11b or IEEE 802.11g compliant WLAN devices to associate with the Device. The transmission rate of your Device might be reduced.</p> <p>Select <b>802.11n</b> to allow only IEEE 802.11n compliant WLAN devices to associate with the Device.</p> <p>Select <b>802.11g+n</b> to allow either IEEE 802.11g or IEEE 802.11n compliant WLAN devices to associate with the Device. The transmission rate of the Device might be reduced when an 802.11g wireless client is associated with it.</p> <p>Select <b>802.11b+g+n</b> to allow IEEE 802.11b, IEEE 802.11g or IEEE 802.11n compliant WLAN devices to associate with the Device. The transmission rate of the Device might be reduced when an 802.11b or 802.11g wireless client is associated with it.</p> <p>Note: The transmission rate varies depending on the mode the wireless client uses to associate with the Device.</p>
Channel Width	<p>A standard 20MHz channel offers transfer speeds of up to 150Mbps whereas a 40MHz channel uses two standard channels and offers speeds of up to 300 Mbps.</p> <p>Select <b>20MHz</b> if you want to lessen radio interference with other wireless devices in your neighborhood or the wireless clients do not support channel bonding.</p> <p>Select <b>Auto</b> to have the Device configure the wireless channel width automatically.</p> <p>This field is available only when you set the <b>802.11 Mode</b> to <b>802.11n</b> or <b>802.11b+g+n</b> in the <b>Advanced Setup</b> screen.</p>
Apply	Click this to save your changes.
Cancel	Click this to restore your previously saved settings.

## 6.10 Technical Reference

This section discusses wireless LANs in depth.

### 6.10.1 Additional Wireless Terms

The following table describes some wireless network terms and acronyms used in the Device's web configurator.

**Table 23** Additional Wireless Terms

TERM	DESCRIPTION
RTS/CTS Threshold	<p>In a wireless network which covers a large area, wireless devices are sometimes not aware of each other's presence. This may cause them to send information to the AP at the same time and result in information colliding and not getting through.</p> <p>By setting this value lower than the default value, the wireless devices must sometimes get permission to send information to the Device. The lower the value, the more often the devices must get permission.</p> <p>If this value is greater than the fragmentation threshold value (see below), then wireless devices never have to get permission to send information to the Device.</p>
Preamble	A preamble affects the timing in your wireless network. There are two preamble modes: long and short. If a device uses a different preamble mode than the Device does, it cannot communicate with the Device.
Authentication	The process of verifying whether a wireless device is allowed to use the wireless network.
Fragmentation Threshold	A small fragmentation threshold is recommended for busy networks, while a larger threshold provides faster performance if the network is not very busy.

### 6.10.2 Wireless Security Overview

By their nature, radio communications are simple to intercept. For wireless data networks, this means that anyone within range of a wireless network without security can not only read the data passing over the airwaves, but also join the network. Once an unauthorized person has access to the network, he or she can steal information or introduce malware (malicious software) intended to compromise the network. For these reasons, a variety of security systems have been developed to ensure that only authorized people can use a wireless data network, or understand the data carried on it.

These security standards do two things. First, they authenticate. This means that only people presenting the right credentials (often a username and password, or a "key" phrase) can access the network. Second, they encrypt. This means that the information sent over the air is encoded. Only people with the code key can understand the information, and only people who have been authenticated are given the code key.

These security standards vary in effectiveness. Some can be broken, such as the old Wired Equivalent Protocol (WEP). Using WEP is better than using no security at all, but it will not keep a determined attacker out. Other security standards are secure in themselves but can be broken if a user does not use them properly. For example, the WPA2-PSK security standard is very secure if you use a long key which is difficult for an attacker's software to guess - for example, a twenty-letter long string of apparently random numbers and letters - but it is not very secure if you use a short key which is very easy to guess - for example, a three-letter word from the dictionary.

Because of the damage that can be done by a malicious attacker, it's not just people who have sensitive information on their network who should use security. Everybody who uses any wireless network should ensure that effective security is in place.

A good way to come up with effective security keys, passwords and so on is to use obscure information that you personally will easily remember, and to enter it in a way that appears random and does not include real words. For example, if your mother owns a 1970 Dodge Challenger and her favorite movie is Vanishing Point (which you know was made in 1971) you could use "70dodchal71vanpoi" as your security key.

The following sections introduce different types of wireless security you can set up in the wireless network.

### **6.10.2.1 SSID**

Normally, the Device acts like a beacon and regularly broadcasts the SSID in the area. You can hide the SSID instead, in which case the Device does not broadcast the SSID. In addition, you should change the default SSID to something that is difficult to guess.

This type of security is fairly weak, however, because there are ways for unauthorized wireless devices to get the SSID. In addition, unauthorized wireless devices can still see the information that is sent in the wireless network.

### **6.10.2.2 User Authentication**

Authentication is the process of verifying whether a wireless device is allowed to use the wireless network. You can make every user log in to the wireless network before using it. However, every device in the wireless network has to support IEEE 802.1x to do this.

For wireless networks, you can store the user names and passwords for each user in a RADIUS server. This is a server used in businesses more than in homes. If you do not have a RADIUS server, you cannot set up user names and passwords for your users.

Unauthorized wireless devices can still see the information that is sent in the wireless network, even if they cannot use the wireless network. Furthermore, there are ways for unauthorized wireless users to get a valid user name and password. Then, they can use that user name and password to use the wireless network.

### **6.10.2.3 Encryption**

Wireless networks can use encryption to protect the information that is sent in the wireless network. Encryption is like a secret code. If you do not know the secret code, you cannot understand the message.

The types of encryption you can choose depend on the type of authentication. (See [Section 6.10.2.2 on page 70](#) for information about this.)

**Table 24** Types of Encryption for Each Type of Authentication

	NO AUTHENTICATION	RADIUS SERVER
<b>Weakest</b>	No Security	WPA
↕	Static WEP	
	WPA-PSK	
<b>Strongest</b>	WPA2-PSK	WPA2

For example, if the wireless network has a RADIUS server, you choose **WPA2**. If users do not log in to the wireless network, you can choose no encryption, **Static WEP** or **WPA2-PSK**.

Usually, you should set up the strongest encryption that every device in the wireless network supports. For example, suppose you have a wireless network with the Device and you do not have a RADIUS server. Therefore, there is no authentication. Suppose the wireless network has two devices. Device A only supports WEP, and device B supports WEP and WPA2. Therefore, you should set up **Static WEP** in the wireless network.

Note: It is recommended that wireless networks use **WPA2-PSK** or **WPA2** encryption. The other types of encryption are better than none at all, but it is still possible for unauthorized wireless devices to figure out the original information pretty quickly.

When you select **WPA2** or **WPA2-PSK** in your Device, you can also select an option (**WPA compatible**) to support WPA as well. In this case, if some of the devices support WPA and some support WPA2, you should set up **WPA2-PSK** or **WPA2** (depending on the type of wireless network login) and select the **WPA compatible** option in the Device.

Many types of encryption use a key to protect the information in the wireless network. The longer the key, the stronger the encryption. Every device in the wireless network must have the same key.

### 6.10.3 Signal Problems

Because wireless networks are radio networks, their signals are subject to limitations of distance, interference and absorption.

Problems with distance occur when the two radios are too far apart. Problems with interference occur when other radio waves interrupt the data signal. Interference may come from other radio transmissions, such as military or air traffic control communications, or from machines that are coincidental emitters such as electric motors or microwaves. Problems with absorption occur when physical objects (such as thick walls) are between the two radios, muffling the signal.

### 6.10.4 BSS

A Basic Service Set (BSS) exists when all communications between wireless stations or between a wireless station and a wired network client go through one access point (AP).

Intra-BSS traffic is traffic between wireless stations in the BSS. When Intra-BSS traffic blocking is disabled, wireless station A and B can access the wired network and communicate with each other.

When Intra-BSS traffic blocking is enabled, wireless station A and B can still access the wired network but cannot communicate with each other.

**Figure 41** Basic Service set

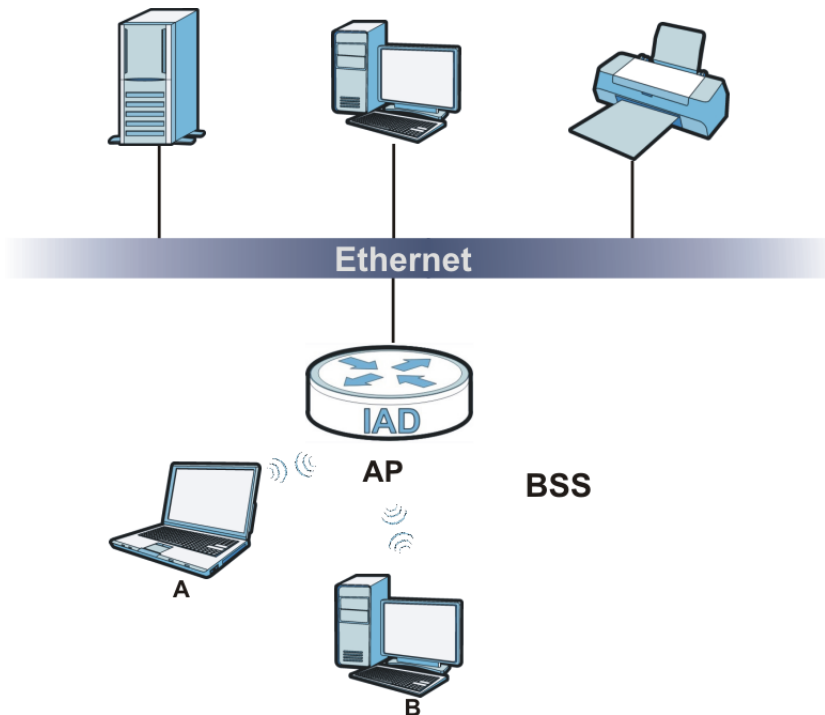

## 6.10.5 MBSSID

Traditionally, you need to use different APs to configure different Basic Service Sets (BSSs). As well as the cost of buying extra APs, there is also the possibility of channel interference. The Device's MBSSID (Multiple Basic Service Set Identifier) function allows you to use one access point to provide several BSSs simultaneously. You can then assign varying QoS priorities and/or security modes to different SSIDs.

Wireless devices can use different BSSIDs to associate with the same AP.

### 6.10.5.1 Notes on Multiple BSSs

- A maximum of eight BSSs are allowed on one AP simultaneously.
- You must use different keys for different BSSs. If two wireless devices have different BSSIDs (they are in different BSSs), but have the same keys, they may hear each other's communications (but not communicate with each other).
- MBSSID should not replace but rather be used in conjunction with 802.1x security.

## 6.10.6 Wireless Distribution System (WDS)

The Device can act as a wireless network bridge and establish WDS (Wireless Distribution System) links with other APs. You need to know the MAC addresses of the APs you want to link to. Once the security settings of peer sides match one another, the connection between devices is made.



At the time of writing, WDS security is not compatible with all access points. Refer to your other access point's documentation for details.

The following figure illustrates how WDS link works between APs. Notebook computer **A** is a wireless client connecting to access point **AP 1**. **AP 1** has no wired Internet connection, but it can establish a WDS link with access point **AP 2**, which has a wired Internet connection. When **AP 1** has a WDS link with **AP 2**, the notebook computer can access the Internet through **AP 2**.

**Figure 42** WDS Link Example





# Home Networking

## 7.1 Overview

A Local Area Network (LAN) is a shared communication system to which many computers are attached. A LAN is usually located in one immediate area such as a building or floor of a building.

The LAN screens can help you configure a LAN DHCP server and manage IP addresses.

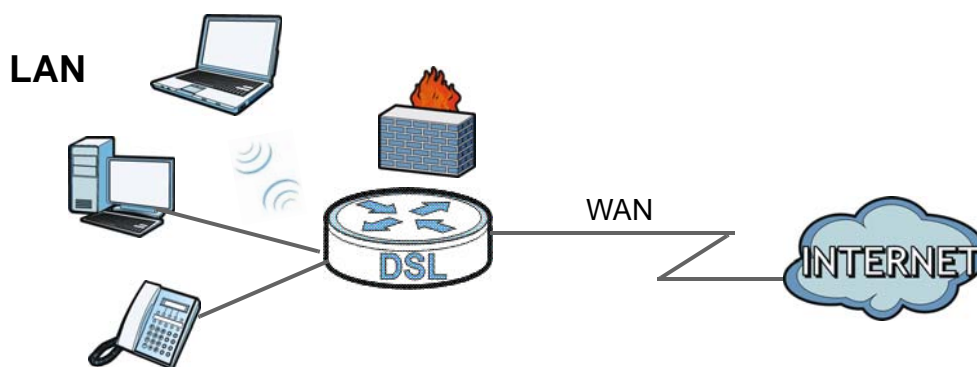

### 7.1.1 What You Can Do in this Chapter

- Use the **LAN Setup** screen to set the LAN IP address, subnet mask, and DHCP settings ([Section 7.2 on page 78](#)).
- Use the **Static DHCP** screen to assign IP addresses on the LAN to specific individual computers based on their MAC Addresses ([Section 7.3 on page 80](#)).
- Use the **IP Alias** screen ([Section 7.4 on page 81](#)) to configure another logical network in the physical LAN network.
- Use the **UPnP** screen to enable UPnP ([Section 7.5 on page 82](#)).
- Use the **UPnP Rule** screen to
- Use the **IPv6 LAN Setup** screen ([Section 7.6 on page 82](#)) to configure the IPv6 settings on your Device's LAN interface.
- Use the **File Sharing** screen to enable file-sharing server ([Section 7.7 on page 87](#)).
- Use the **Printer Server** screen to enable the print server ([Section 7.8 on page 89](#)).

### 7.1.2 What You Need To Know

The following terms and concepts may help as you read this chapter.

### 7.1.2.1 About LAN

#### IP Address

Similar to the way houses on a street share a common street name, so too do computers on a LAN share one common network number. This is known as an Internet Protocol address.

#### Subnet Mask

The subnet mask specifies the network number portion of an IP address. Your Device will compute the subnet mask automatically based on the IP address that you entered. You don't need to change the subnet mask computed by the Device unless you are instructed to do otherwise.

#### DHCP

DHCP (Dynamic Host Configuration Protocol) allows clients to obtain TCP/IP configuration at start-up from a server. This Device has a built-in DHCP server capability that assigns IP addresses and DNS servers to systems that support DHCP client capability.

#### DNS

DNS (Domain Name System) maps a domain name to its corresponding IP address and vice versa. The DNS server is extremely important because without it, you must know the IP address of a computer before you can access it. The DNS server addresses you enter when you set up DHCP are passed to the client machines along with the assigned IP address and subnet mask.

### 7.1.2.2 About UPnP

#### How do I know if I'm using UPnP?

UPnP hardware is identified as an icon in the Network Connections folder (Windows XP). Each UPnP compatible device installed on your network will appear as a separate icon. Selecting the icon of a UPnP device will allow you to access the information and properties of that device.

#### Cautions with UPnP

The automated nature of NAT traversal applications in establishing their own services and opening firewall ports may present network security issues. Network information and configuration may also be obtained and modified by users in some network environments.

When a UPnP device joins a network, it announces its presence with a multicast message. For security reasons, the Device allows multicast messages on the LAN only.

All UPnP-enabled devices may communicate freely with each other without additional configuration. Disable UPnP if this is not your intention.

#### UPnP and ZyXEL

ZyXEL has achieved UPnP certification from the Universal Plug and Play Forum UPnP™ Implementers Corp. (UIC). ZyXEL's UPnP implementation supports Internet Gateway Device (IGD) 1.0.

See [Section 7.10 on page 92](#) for examples of installing and using UPnP.

### 7.1.2.3 About File Sharing

#### Workgroup name

This is the name given to a set of computers that are connected on a network and share resources such as a printer or files. Windows automatically assigns the workgroup name when you set up a network.

#### Shares

When settings are set to default, each USB device connected to the Device is given a folder, called a "share". If a USB hard drive connected to the Device has more than one partition, then each partition will be allocated a share. You can also configure a "share" to be a sub-folder or file on the USB device.

#### File Systems

A file system is a way of storing and organizing files on your hard drive and storage device. Often different operating systems such as Windows or Linux have different file systems. The file sharing feature on your Device supports FAT16, FAT32, NTFS, EXT2, and EXT3.

#### Common Internet File System

The Device uses Common Internet File System (CIFS) protocol for its file sharing functions. CIFS compatible computers can access the USB file storage devices connected to the Device. CIFS protocol is supported on Microsoft Windows, Linux Samba and other operating systems (refer to your systems specifications for CIFS compatibility).

### 7.1.2.4 About Printer Server

#### Print Server

This is a computer or other device which manages one or more printers, and which sends print jobs to each printer from the computer itself or other devices.

#### Operating System

An operating system (OS) is the interface which helps you manage a computer. Common examples are Microsoft Windows, Mac OS or Linux.

#### TCP/IP

TCP/IP (Transmission Control Protocol/ Internet Protocol) is a set of communications protocols that most of the Internet runs on.

## Port

A port maps a network service such as http to a process running on your computer, such as a process run by your web browser. When traffic from the Internet is received on your computer, the port number is used to identify which process running on your computer it is intended for.

## Supported OSs

Your operating system must support TCP/IP ports for printing and be compatible with the RAW (port 9100) protocol.

The following OSs support Device's printer sharing feature.

- Microsoft Windows 95, Windows 98 SE (Second Edition), Windows Me, Windows NT 4.0, Windows 2000, Windows XP or Macintosh OS X.

## 7.2 The LAN Setup Screen

Click **Network Setting > Home Networking** to open the **LAN Setup** screen. Use this screen to set the Local Area Network IP address and subnet mask of your Device and configure the DNS server information that the Device sends to the DHCP client devices on the LAN.

**Figure 43** Network Setting > Home Networking > LAN Setup

The screenshot shows the LAN Setup screen with the following configuration details:

- LAN IP Setup**
  - IP Address : 192.168.1.1
  - Subnet Mask : 255.255.255.0
  - RIP Version : RIP1 (dropdown) Direction : None (dropdown)
  - Multicast : IGMP v1/IGMP v2/IGMP v3 (dropdown)
  - IGMP Snooping :  Disabled  Enabled
- DHCP Server State**
  - DHCP :  Disable  Enable  DHCP Relay
- IP Addressing Values**
  - IP Pool Starting Address : 192.168.1.33
  - Pool Size : 32
- DHCP Server Lease Time**
  - Lease Time : 259200 seconds
- DNS Values**
  - DNS Server 1 : DNS Proxy (dropdown) 192.168.1.1
  - DNS Server 2 : None (dropdown) 0.0.0.0

Buttons: Apply, Cancel

The following table describes the fields in this screen.

**Table 25** Network Setting > Home Networking > LAN Setup

LABEL	DESCRIPTION
LAN IP Setup	
IP Address	Enter the LAN IP address you want to assign to your Device in dotted decimal notation, for example, 192.168.1.1 (factory default).
IP Subnet Mask	Type the subnet mask of your network in dotted decimal notation, for example 255.255.255.0 (factory default). Your Device automatically computes the subnet mask based on the IP address you enter, so do not change this field unless you are instructed to do so.
RIP Version	RIP (Routing Information Protocol) allows a router to exchange routing information with other routers. Select the RIP version from <b>RIP-1</b> and <b>RIP2-B/RIP2-M</b> .
Direction	Use this field to control how much routing information the Device sends and receives on the subnet. Select the <b>RIP Direction</b> from <b>None</b> , <b>Both</b> , <b>IN Only</b> and <b>OUT Only</b> .
Multicast	IGMP (Internet Group Multicast Protocol) is a network-layer protocol used to establish membership in a multicast group. The Device supports <b>IGMP v1/IGMP v2/IGMP v3</b> . Select <b>None</b> to disable it.
IGMP Snooping	Select <b>Enabled</b> to activate IGMP Snooping. This allows the Device to passively learn memberships in multicast groups. Otherwise, select <b>Disabled</b> to deactivate it.
DHCP Server State	
DHCP	<p>Select <b>Enable</b> to have your Device assign IP addresses, an IP default gateway and DNS servers to LAN computers and other devices that are DHCP clients.</p> <p>If you select <b>Disable</b>, you need to manually configure the IP addresses of the computers and other devices on your LAN.</p> <p>When DHCP is used, the following fields need to be set.</p>
IP Addressing Values	
IP Pool Starting Address	This field specifies the first of the contiguous addresses in the IP address pool.
Pool Size	This field specifies the size, or count of the IP address pool.
DNS Values	
DNS Server 1-2	<p>The Device supports DNS proxy by default. The Device sends out its own LAN IP address to the DHCP clients as the first DNS server address. DHCP clients use this first DNS server to send domain-name queries to the Device. The Device sends a response directly if it has a record of the domain-name to IP address mapping. If it does not, the Device queries an outside DNS server and relays the response to the DHCP client.</p> <p>Select <b>From ISP</b> if your ISP dynamically assigns DNS server information (and the Device's WAN IP address).</p> <p>Select <b>DNS Proxy</b> to have the DHCP clients use the Device's own LAN IP address. The Device works as a DNS relay.</p> <p>Select <b>User-Defined</b> if you have the IP address of a DNS server. Enter the DNS server's IP address in the field to the right.</p> <p>Select <b>None</b> to not configure extra DNS servers.</p>
Apply	Click <b>Apply</b> to save your changes.
Cancel	Click <b>Cancel</b> to restore your previously saved settings.

## 7.3 The Static DHCP Screen

This table allows you to assign IP addresses on the LAN to specific individual computers based on their MAC Addresses.

Every Ethernet device has a unique MAC (Media Access Control) address. The MAC address is assigned at the factory and consists of six pairs of hexadecimal characters, for example, 00:A0:C5:00:00:02.

### 7.3.1 Before You Begin

Find out the MAC addresses of your network devices if you intend to add them to the **Static DHCP** screen.

Use this screen to change your Device's static DHCP settings. Click **Network Setting > Home Networking > Static DHCP** to open the following screen.

**Figure 44** Network Setting > Home Networking > Static DHCP

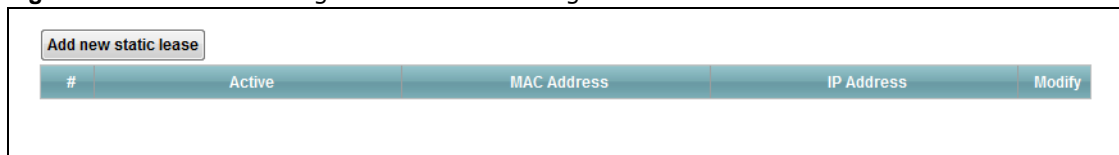

The following table describes the labels in this screen.

**Table 26** Network Setting > Home Networking > Static DHCP

LABEL	DESCRIPTION
Add new static lease	Click this to add a new static DHCP entry.
#	This is the index number of the entry.
Status	This field displays whether the client is connected to the Device.
Host Name	This field displays the client host name.
MAC Address	The MAC (Media Access Control) or Ethernet address on a LAN (Local Area Network) is unique to your computer (six pairs of hexadecimal notation).  A network interface card such as an Ethernet adapter has a hardwired address that is assigned at the factory. This address follows an industry standard that ensures no other adapter has a similar address.
IP Address	This field displays the IP address relative to the # field listed above.
Reserve	Select the check box in the heading row to automatically select all check boxes or select individual entry check boxes in each entry to have the Device always assign the selected entries's IP addresses to the corresponding MAC addresses and host names. You can select up to 128 entries in this table.
Apply	Click <b>Apply</b> to save your changes.
Cancel	Click <b>Cancel</b> to restore your previously saved settings.
Refresh	Click <b>Refresh</b> to reload the DHCP table.

If you click **Add new static lease** in the **Static DHCP** screen, the following screen displays.



**Figure 45** Static DHCP: Add

The following table describes the labels in this screen.

**Table 27** Static DHCP: Add

LABEL	DESCRIPTION
MAC Address	Enter the MAC address of a computer on your LAN.
IP Address	Enter the IP address that you want to assign to the computer on your LAN with the MAC address that you will also specify.
Apply	Click <b>Apply</b> to save your changes.
Cancel	Click <b>Cancel</b> to exit this screen without saving.

## 7.4 The IP Alias Screen

IP alias allows you to partition a physical network into different logical networks over the same Ethernet interface. The Device supports multiple logical LAN interfaces via its physical Ethernet interface with the Device itself as the gateway for the LAN network.

When you use IP alias, you can also configure firewall rules to control access to the LAN's logical network (subnet).

Use this screen to change your Device's IP alias settings. Click **Network Setting > Home Networking > IP Alias** to open the following screen.

**Figure 46** Network Setting > Home Networking > IP Alias

The following table describes the labels in this screen.

**Table 28** Network Setting > Home Networking > IP Alias

LABEL	DESCRIPTION
IP Alias	Select <b>Enable</b> to configure a LAN network for the Device.
IP Address	Enter the IP address of your Device in dotted decimal notation.

**Table 28** Network Setting > Home Networking > IP Alias

LABEL	DESCRIPTION
Subnet Mask	Your Device will automatically calculate the subnet mask based on the IP address that you assign. Unless you are implementing subnetting, use the subnet mask computed by the Device.
Apply	Click this to save your changes.
Cancel	Click this to restore your previously saved settings.

## 7.5 The UPnP Screen

Universal Plug and Play (UPnP) is a distributed, open networking standard that uses TCP/IP for simple peer-to-peer network connectivity between devices. A UPnP device can dynamically join a network, obtain an IP address, convey its capabilities and learn about other devices on the network. In turn, a device can leave a network smoothly and automatically when it is no longer in use.

See [page 92](#) for more information on UPnP.

Use the following screen to configure the UPnP settings on your Device. Click **Network Setting > Home Networking > Static DHCP > UPnP** to display the screen shown next.

**Figure 47** Network Setting > Home Networking > UPnP

UPnP State

UPnP:  Enable  Disable

Apply Cancel

The following table describes the labels in this screen.

**Table 29** Network Settings > Home Networking > UPnP

LABEL	DESCRIPTION
UPnP	Select <b>Enable</b> to activate UPnP. Be aware that anyone could use a UPnP application to open the web configurator's login screen without entering the Device's IP address (although you must still enter the password to access the web configurator).
Apply	Click <b>Apply</b> to save your changes.
Cancel	Click this to restore your previously saved settings.

## 7.6 The IPv6 LAN Setup Screen

Use this screen to configure the IPv6 settings for your Device's LAN interface.

Figure 48 Network Setting &gt; Home Networking &gt; IPv6 LAN Setup

IPv6 LAN Setup	
Link Local Address Type :	<input checked="" type="radio"/> Manual <input type="radio"/> EUI64
IPv6 Address :	<input type="text" value="fe80::1"/>
Prefix :	<input type="text" value="64"/>
MLD Snooping :	<input checked="" type="radio"/> Enabled <input type="radio"/> Disabled
Lan Global Identifier Type :	<input checked="" type="radio"/> Manual <input type="radio"/> EUI64
Lan Identifier :	<input type="text" value="0:0:0:1"/>
IPv6 ULA Address Type :	<input type="radio"/> Auto Generate <input checked="" type="radio"/> Manual
IPv6 ULA Address :	<input type="text" value="fd79:27e7:4700:0::1"/>
LAN IPv6 Address Setting	
<input checked="" type="radio"/> Delegate prefix from WAN	<input type="text" value="PVC0"/>
<input type="radio"/> Static	
Static IPv6 Address Prefix :	<input type="text"/>
Prefix length :	<input type="text" value="64"/>
Preferred Lifetime :	<input type="text" value="3600"/>
Valid Lifetime :	<input type="text" value="7200"/>
LAN IPv6 Address Assign Setup :	<input type="text" value="Stateless and Stateful"/>
LAN IPv6 DNS Assign Setup :	<input type="text" value="Stateless and Stateful"/>
DHCPv6	
DHCPv6 Server :	<input type="radio"/> Disable <input checked="" type="radio"/> Enable
DNSv6 Mode :	<input checked="" type="radio"/> Proxy <input type="radio"/> Relay <input type="radio"/> Manual
Primary DNS :	<input type="text" value="fe80::1"/>
Secondary DNS :	<input type="text" value="fe80::2"/>
Information refresh time :	<input type="text" value="14400"/>
DNS Query Mode :	<input type="text" value="IPv4 DNS Server First"/>
RADVD Setup	
<input checked="" type="checkbox"/> Send RA on	
<input checked="" type="radio"/> Delegate M/O flag from WAN	
<input type="radio"/> Manual	
<input type="checkbox"/> Managed config flag on	
<input checked="" type="checkbox"/> Other config flag on	
<input checked="" type="checkbox"/> Advertisement interval option on	
Hop limit :	<input type="text" value="64"/>
Router Lifetime :	<input type="text" value="60"/>
Router Preference :	<input type="text" value="High"/>
Reachable Time (ms) :	<input type="text" value="0"/>
Retrans Timer (ms) :	<input type="text" value="0"/>
RA Interval :	<input type="text" value="30"/>
<input checked="" type="radio"/> Delegate MTU from WAN	
<input type="radio"/> Manual	
MTU :	<input type="text" value="1500"/>
DAD attempts :	<input type="text" value="1"/>
<input type="button" value="Apply"/> <input type="button" value="Cancel"/> <input type="button" value="Advanced Setup"/>	

The following table describes the labels in this screen.

**Table 30** Network Setting > Home Networking > IPv6 LAN Setup

LABEL	DESCRIPTION
IPv6 LAN Setup	
Link Local Address Type	Select <b>Manual</b> to manually enter a link local address. Select <b>EUI 64</b> to use the EUI-64 format to generate a link local address from the Ethernet MAC address.
IPv6 Address	If you selected <b>Manual</b> in the <b>Link Local Address Type</b> field, enter the LAN IPv6 address you want to assign to your Device in hexadecimal notation, for example, fe80::1 (factory default).
Prefix	Enter the address prefix to specify how many most significant bits in an IPv6 address compose the network address.
MLD Snooping	Multicast Listener Discovery (MLD) allows an IPv6 switch or router to discover the presence of MLD hosts who wish to receive multicast packets and the IP addresses of multicast groups the hosts want to join on its network. Select <b>Enabled</b> to activate MLD Snooping on the Device. This allows the Device to check MLD packets passing through it and learn the multicast group membership. It helps reduce multicast traffic.
Lan Global Identifier Type	Select <b>Manual</b> to manually enter a LAN Identifier as the interface ID to identify the LAN interface. The LAN Identifier is appended to the IPv6 address prefix to create the routable global IPv6 address. Select <b>EUI 64</b> to use the EUI-64 format to generate an interface ID from the Ethernet MAC address.
Lan Identifier	If you selected <b>Manual</b> , enter the LAN Identifier in this field. The LAN identifier should be unique and 64 bits in hexadecimal form. Every 16 bit block should be separated by a colon as in XXXX:XXXX:XXXX:XXXX where X is a hexadecimal character. Blocks of zeros can be represented with double colons as in XXXX:XXXX::XXXX.
IPv6 ULA Address Type	A unique local address (ULA) is a unique IPv6 address for use in private networks but not routable in the global IPv6 Internet.  Select <b>Auto Generate</b> to have the Device automatically generate a globally unique address for the LAN IPv6 address. Select <b>Manual</b> to enter a static IPv6 ULA address. The address format is like fdxx:xxxx:xxxx:xxxx::/64.
IPv6 ULA Address	If Manual is selected in the <b>IPv6 ULA Address Type</b> field, enter the IPv6 address prefix that the Device uses for the LAN IPv6 address.
LAN IPv6 Address Setting	
Delegate prefix from WAN	Select this option to automatically obtain an IPv6 network prefix from the service provider or an uplink router.
Static	Select this option to configure a fixed IPv6 address for the Device's LAN IPv6 address.
Static IPv6 Address Prefix	If you select static IPv6 address, enter the IPv6 address prefix that the Device uses for the LAN IPv6 address.
Prefix length	If you select static IPv6 address, enter the IPv6 prefix length that the Device uses to generate the LAN IPv6 address.  An IPv6 prefix length specifies how many most significant bits (starting from the left) in the address compose the network address. This field displays the bit number of the IPv6 subnet mask.
Preferred Lifetime	Enter the preferred lifetime for the prefix.
Valid Lifetime	Enter the valid lifetime for the prefix.

**Table 30** Network Setting > Home Networking > IPv6 LAN Setup (continued)

LABEL	DESCRIPTION
LAN IPv6 Address Assign Setup	<p>Select how you want to obtain an IPv6 address:</p> <ul style="list-style-type: none"> <li>• <b>Stateless:</b> The Device uses IPv6 stateless autoconfiguration. RADVD (Router Advertisement Daemon) is enabled to have the Device send IPv6 prefix information in router advertisements periodically and in response to router solicitations. DHCPv6 server is disabled.</li> <li>• <b>Stateful:</b> The Device uses IPv6 stateful autoconfiguration. The DHCPv6 server is enabled to have the Device act as a DHCPv6 server and pass IPv6 addresses to DHCPv6 clients.</li> <li>• <b>Stateless and Stateful:</b> The Device uses both IPv6 stateless and stateful autoconfiguration. The LAN IPv6 clients can obtain IPv6 addresses either through router advertisements or through DHCPv6.</li> </ul>
LAN IPv6 DNS Assign Setup	<p>Select how the Device provide DNS server and domain name information to the clients:</p> <ul style="list-style-type: none"> <li>• <b>Stateless:</b> The Device uses IPv6 stateless autoconfiguration. RADVD (Router Advertisement Daemon) is enabled to have the Device send IPv6 prefix information in router advertisements periodically and in response to router solicitations. DHCPv6 server is disabled.</li> <li>• <b>Stateful:</b> The Device uses IPv6 stateful autoconfiguration. The DHCPv6 server is enabled to have the Device act as a DHCPv6 server and pass IPv6 addresses to DHCPv6 clients.</li> <li>• <b>Stateless and Stateful:</b> The Device uses both IPv6 stateless and stateful autoconfiguration. The LAN IPv6 clients can obtain IPv6 addresses either through router advertisements or through DHCPv6.</li> </ul>
DHCPv6	
DHCPv6 Server	Use this field to <b>Enable</b> or <b>Disable</b> DHCPv6 server on the Device.
DNSv6 Mode	Select the DNS role ( <b>Proxy</b> or <b>Relay</b> ) that you want the Device to act in the IPv6 LAN network. Alternatively, select <b>Manual</b> and specify the DNS servers' IPv6 address in the fields below.
Primary DNS	This field is available if you choose <b>Manual</b> as the DNSv6 mode. Enter the first DNS server IPv6 address the Device passes to the DHCP clients.
Secondary DNS	This field is available if you choose <b>Manual</b> as the DNSv6 mode. Enter the second DNS server IPv6 address the Device passes to the DHCP clients.
Information refresh time	Enter the number of seconds a DHCPv6 client should wait before refreshing information retrieved from DHCPv6.
DNS Query Mode	<p>Select how the Device handles clients' DNS information requests.</p> <ul style="list-style-type: none"> <li>• <b>IPv4 DNS Server First:</b> The Device forwards the requests to the IPv4 DNS server first and then the IPv6 DNS server. Then it sends clients the first DNS information it receives.</li> <li>• <b>IPv6 DNS Server First:</b> The Device forwards the requests to the IPv6 DNS server first and then the IPv4 DNS server. Then it sends clients the first DNS information it receives.</li> <li>• <b>IPv4 DNS Server Only:</b> The Device forwards the requests to the IPv4 DNS server and sends clients the DNS information it receives.</li> <li>• <b>IPv6 DNS Server Only:</b> The Device forwards the requests to the IPv6 DNS server and sends clients the DNS information it receives.</li> </ul>
Advanced Setup	Click this to open the <b>IPv6 LAN Setup Advanced Setup</b> section.
RADVD Setup	

**Table 30** Network Setting > Home Networking > IPv6 LAN Setup (continued)

LABEL	DESCRIPTION
Send RA on	<p>Select this to have the Device send router advertisement messages to the LAN hosts.</p> <p>Router advertisement is a response to a router solicitation or a periodical multicast advertisement from a router to advertise its presence and other parameters, such as IPv6 prefix and DNS information.</p> <p>Router solicitation is a request from a host to locate a router that can act as the default router and forward packets.</p> <p>Note: The LAN hosts neither generate global IPv6 addresses nor communicate with other networks if you disable this feature.</p>
Delegate M/O flag from WAN	Select this to have the Device obtain the M/O (Managed/Other) flag setting from the service provider or uplink router.
Manual	Select this to specify the M/O flag setting manually.
Managed config flag on	<p>Select this to have the Device indicate to hosts to obtain network settings (such as prefix and DNS settings) through DHCPv6.</p> <p>Clear this to have the Device indicate to hosts that DHCPv6 is not available and they should use the prefix in the router advertisement message.</p>
Other config flag on	<p>Select this to have the Device indicate to hosts to obtain DNS information through DHCPv6.</p> <p>Clear this to have the Device indicate to hosts that DNS information is not available in this network.</p>
Advertisement interval option on	Select this to have the Router Advertisement messages the Device sends specify the allowed interval between Router Advertisement messages.
Hop limit	Enter the maximum number of network segments that a packet can cross before reaching the destination. When forwarding an IPv6 packet, IPv6 routers are required to decrease the Hop Limit by 1 and to discard the IPv6 packet when the Hop Limit is 0. Possible value for this field are 0-255.
Router Lifetime	Enter the time in seconds that hosts should consider the Device to be the default router. Possible values for this field are 0-9000.
Router Preference	<p>Select the router preference (<b>Low</b>, <b>Medium</b> or <b>High</b>) for the Device. The Device sends this preference in the router advertisements to tell hosts what preference they should use for the Device. This helps hosts to choose their default router especially when there are multiple IPv6 router in the network.</p> <p>Note: Make sure the hosts also support router preference to make this function work.</p>
Reachable Time (ms)	Enter the time in milliseconds that can elapse before a neighbor is detected. Possible values for this field are 0-3600000.
Retrans Timer (ms)	Enter the time in milliseconds between neighbor solicitation packet retransmissions. Possible values for this field are 1000-4294967295.
RA Interval	Enter the time in seconds between router advertisement messages. Possible values for this field are 4-1800.
Delegate MTU from WAN	Select this to have the Device obtain the MTU setting from the service provider or uplink router.
Manual	Select this to specify the MTU manually.
MTU	The Maximum Transmission Unit. Type the maximum size of each IPv6 data packet, in bytes, that can move through this interface. If a larger packet arrives, the Device divides it into smaller fragments.
DAD attempts	Specify the number of DAD (Duplicate Address Detection) attempts before an IPv6 address is assigned to the Device LAN interface. Possible values for this field are 1-7.
Apply	Click this to save your changes.

**Table 30** Network Setting > Home Networking > IPv6 LAN Setup (continued)

LABEL	DESCRIPTION
Cancel	Click this to restore your previously saved settings.
Advanced Setup	Click this to close the <b>IPv6 LAN Setup Advanced Setup</b> section.

## 7.7 The File Sharing Screen

You can share files on a USB memory stick or hard drive connected to your Device with users on your network.

The following figure is an overview of the Device's file server feature. Computers **A** and **B** can access files on a USB device (**C**) which is connected to the Device.

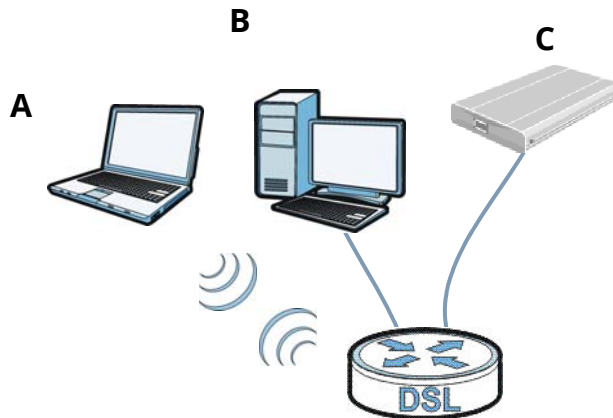
**Figure 49** File Sharing Overview

The Device will not be able to join the workgroup if your local area network has restrictions set up that do not allow devices to join a workgroup. In this case, contact your network administrator.

### 7.7.1 Before You Begin

Make sure the Device is connected to your network and turned on.

- 1 Connect the USB device to one of the Device's USB ports. Make sure the Device is connected to your network.
- 2 The Device detects the USB device and makes its contents available for browsing. If you are connecting a USB hard drive that comes with an external power supply, make sure it is connected to an appropriate power source that is on.

Note: If your USB device cannot be detected by the Device, see the troubleshooting for suggestions.

Use this screen to set up file sharing using the Device. To access this screen, click **Network Setting > Home Networking > File Sharing**.

**Figure 50** Network Setting > Home Networking > File Sharing

**Server Configuration**

Active the File Sharing Services (SMB)

Share Directory Access Level: Public ▾

**Account Management**

#	Status	User Name	Modify
1	⚡		
2	⚡		
3	⚡		
4	⚡		
5	⚡		
6	⚡		
7	⚡		
8	⚡		
9	⚡		
10	⚡		
11	⚡		
12	⚡		
13	⚡		
14	⚡		
15	⚡		
16	⚡		

Apply Cancel

Each field is described in the following table.

**Table 31** Network Setting > Home Networking > File Sharing

LABEL	DESCRIPTION
Server Configuration	
File Sharing Services (SMB)	Select <b>Enable</b> to activate file sharing through the Device.
Share Directory Access Level	Select <b>Public</b> to allow all LAN users to access the shared folders. Select <b>Security</b> to allow only the users added and activated in the <b>Account Management</b> section below to access the shared folders.
Account Management	
#	This is the index number of the file sharing user account.
Status	This shows whether or not the file sharing user account is activated.
User Name	This field displays the user name of the file sharing user account.
Modify	Click the <b>Edit</b> icon to configure a file sharing user account’s settings. Click the <b>Delete</b> icon to delete this user account from the list.
Apply	Click <b>Apply</b> to save your changes.
Cancel	Click <b>Cancel</b> to restore your previously saved settings.



## 7.7.2 Edit File Sharing User

Use this screen to edit a file sharing user on the Device. Click the **Edit** icon next to a user account.

**Figure 51** File Sharing: Add/Edit

Each field is described in the following table.

**Table 32** File Sharing: Add/Edit

LABEL	DESCRIPTION
Active	Select this to activate the file sharing user account.
User Name	Type the user name for the account.
New Password	Type your new system password (up to 30 characters). Note that as you type a password, the screen displays a (*) for each character you type. After you change the password, use the new password to access the Device.
Retype New Password	Type the new password again for confirmation.
Apply	Click <b>Apply</b> to save your changes.
Cancel	Click <b>Cancel</b> to exit this screen without saving.

## 7.8 The Printer Server Screen

The Device allows you to share a USB printer on your LAN. You can do this by connecting a USB printer to one of the USB ports on the Device and then configuring a TCP/IP port on the computers connected to your network.

**Figure 52** Sharing a USB Printer

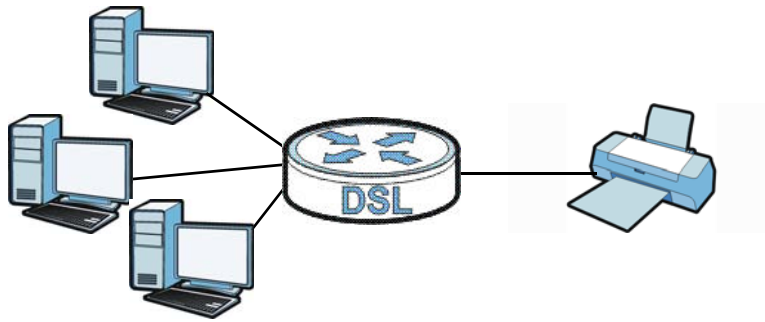

### 7.8.1 Before You Begin

To configure the print server you need the following:

- Your Device must be connected to your computer and any other devices on your network. The USB printer must be connected to your Device.
- A USB printer with the driver already installed on your computer.
- The computers on your network must have the printer software already installed before they can create a TCP/IP port for printing via the network. Follow your printer manufacturers instructions on how to install the printer software on your computer.

**Note:** Your printer’s installation instructions may ask that you connect the printer to your computer. Connect your printer to the Device instead.

Use this screen to enable or disable sharing of a USB printer via your Device.

To access this screen, click **Network Setting > Home Networking > Printer Server**.

**Figure 53** Network Setting > Home Networking > Printer Server

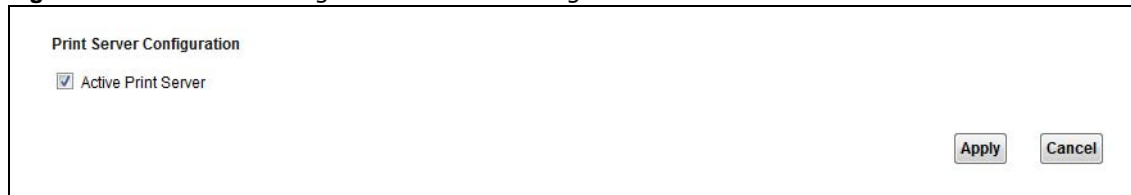

The following table describes the labels in this menu.

**Table 33** Network Setting > Home Networking > Print Server

LABEL	DESCRIPTION
Active Printer Server	Select this to have the Device share a USB printer.
Apply	Click <b>Apply</b> to save your changes.
Cancel	Click <b>Cancel</b> to restore your previously saved settings.

## 7.9 Technical Reference

This section provides some technical background information about the topics covered in this chapter.

### LANs, WANs and the Device

The actual physical connection determines whether the Device ports are LAN or WAN ports. There are two separate IP networks, one inside the LAN network and the other outside the WAN network as shown next.

**Figure 54** LAN and WAN IP Addresses

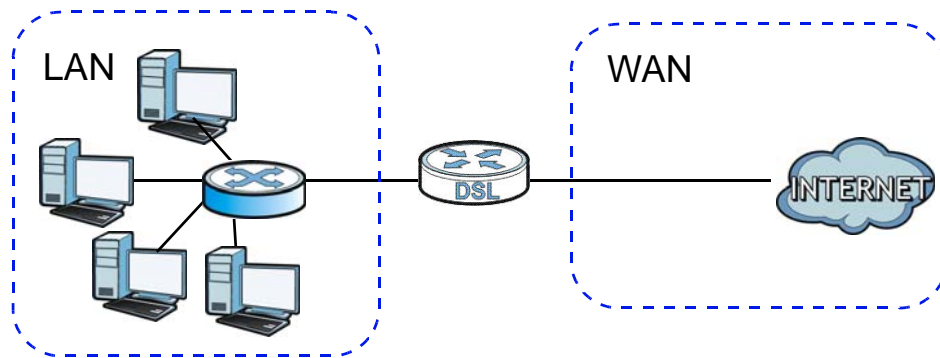

### DHCP Setup

DHCP (Dynamic Host Configuration Protocol, RFC 2131 and RFC 2132) allows individual clients to obtain TCP/IP configuration at start-up from a server. You can configure the Device as a DHCP server or disable it. When configured as a server, the Device provides the TCP/IP configuration for the clients. If you turn DHCP service off, you must have another DHCP server on your LAN, or else the computer must be manually configured.

### IP Pool Setup

The Device is pre-configured with a pool of IP addresses for the DHCP clients (DHCP Pool). See the product specifications in the appendices. Do not assign static IP addresses from the DHCP pool to your LAN computers.

### LAN TCP/IP

The Device has built-in DHCP server capability that assigns IP addresses and DNS servers to systems that support DHCP client capability.

### IP Address and Subnet Mask

Similar to the way houses on a street share a common street name, so too do computers on a LAN share one common network number.

Where you obtain your network number depends on your particular situation. If the ISP or your network administrator assigns you a block of registered IP addresses, follow their instructions in selecting the IP addresses and the subnet mask.

If the ISP did not explicitly give you an IP network number, then most likely you have a single user account and the ISP will assign you a dynamic IP address when the connection is established. If this is the case, it is recommended that you select a network number from 192.168.0.0 to 192.168.255.0 and you must enable the Network Address Translation (NAT) feature of the Device. The Internet Assigned Number Authority (IANA) reserved this block of addresses specifically for private use; please do not use any other number unless you are told otherwise. Let's say you select 192.168.1.0 as the network number; which covers 254 individual addresses, from 192.168.1.1 to 192.168.1.254 (zero and 255 are reserved). In other words, the first three numbers specify the network number while the last number identifies an individual computer on that network.

Once you have decided on the network number, pick an IP address that is easy to remember, for instance, 192.168.1.1, for your Device, but make sure that no other device on your network is using that IP address.

The subnet mask specifies the network number portion of an IP address. Your Device will compute the subnet mask automatically based on the IP address that you entered. You don't need to change the subnet mask computed by the Device unless you are instructed to do otherwise.

### **Private IP Addresses**

Every machine on the Internet must have a unique address. If your networks are isolated from the Internet, for example, only between your two branch offices, you can assign any IP addresses to the hosts without problems. However, the Internet Assigned Numbers Authority (IANA) has reserved the following three blocks of IP addresses specifically for private networks:

- 10.0.0.0 — 10.255.255.255
- 172.16.0.0 — 172.31.255.255
- 192.168.0.0 — 192.168.255.255

You can obtain your IP address from the IANA, from an ISP or it can be assigned from a private network. If you belong to a small organization and your Internet access is through an ISP, the ISP can provide you with the Internet addresses for your local networks. On the other hand, if you are part of a much larger organization, you should consult your network administrator for the appropriate IP addresses.

**Note:** Regardless of your particular situation, do not create an arbitrary IP address; always follow the guidelines above. For more information on address assignment, please refer to RFC 1597, "Address Allocation for Private Internets" and RFC 1466, "Guidelines for Management of IP Address Space".

## **7.10 Installing UPnP in Windows Example**

This section shows how to install UPnP in Windows Me and Windows XP.

### **Installing UPnP in Windows Me**

Follow the steps below to install the UPnP in Windows Me.

- 1 Click **Start** and **Control Panel**. Double-click **Add/Remove Programs**.
- 2 Click the **Windows Setup** tab and select **Communication** in the **Components** selection box. Click **Details**.

**Figure 55** Add/Remove Programs: Windows Setup: Communication

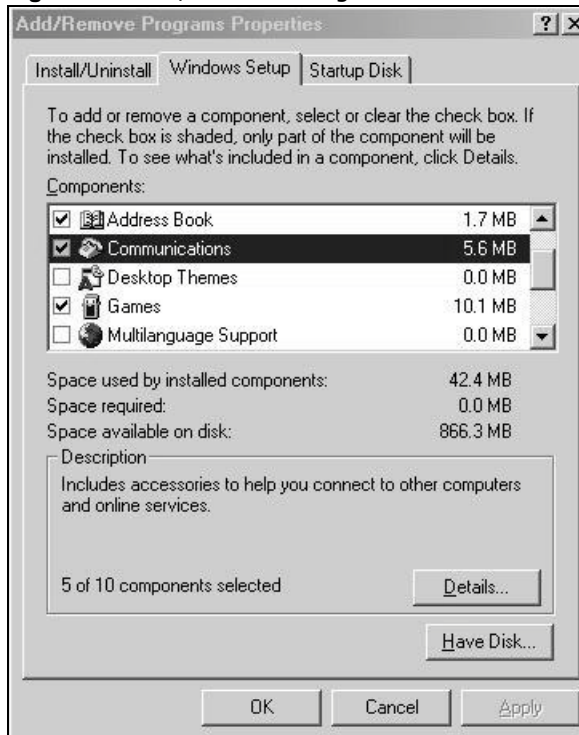

- 3 In the **Communications** window, select the **Universal Plug and Play** check box in the **Components** selection box.

**Figure 56** Add/Remove Programs: Windows Setup: Communication: Components

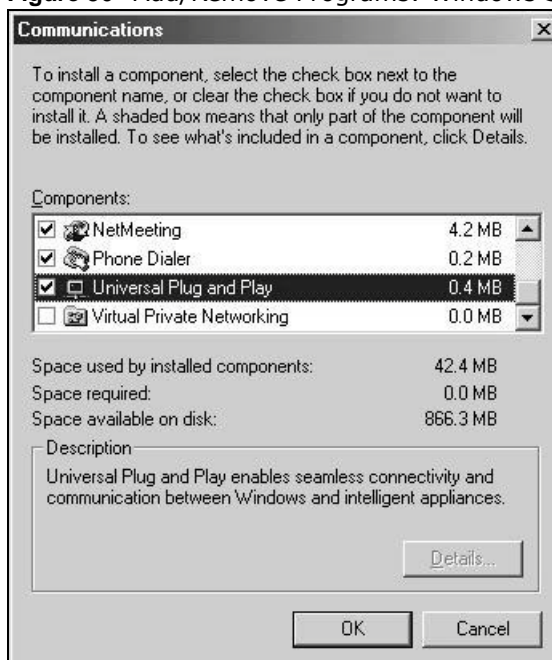

- 4 Click **OK** to go back to the **Add/Remove Programs Properties** window and click **Next**.
- 5 Restart the computer when prompted.

### Installing UPnP in Windows XP

Follow the steps below to install the UPnP in Windows XP.

- 1 Click **Start** and **Control Panel**.
- 2 Double-click **Network Connections**.
- 3 In the **Network Connections** window, click **Advanced** in the main menu and select **Optional Networking Components ...**

Figure 57 Network Connections

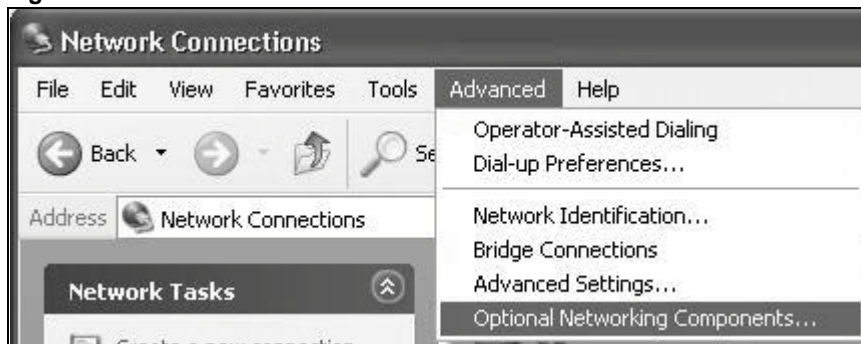

- 4 The **Windows Optional Networking Components Wizard** window displays. Select **Networking Service** in the **Components** selection box and click **Details**.

Figure 58 Windows Optional Networking Components Wizard

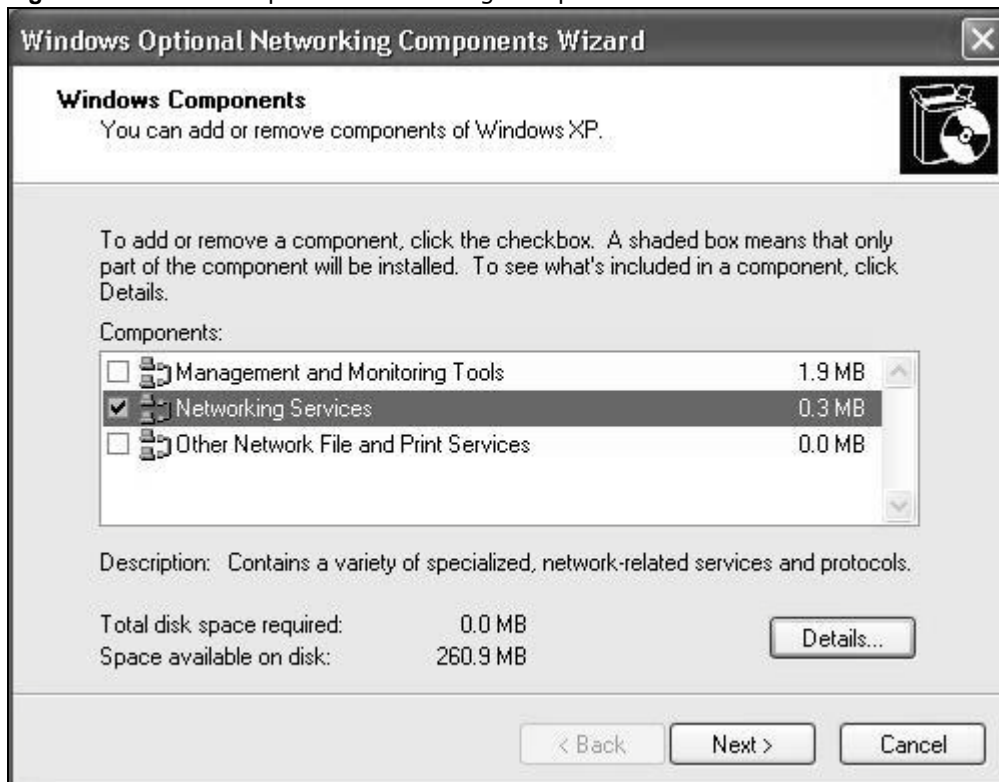

- 5 In the **Networking Services** window, select the **Universal Plug and Play** check box.

**Figure 59** Networking Services

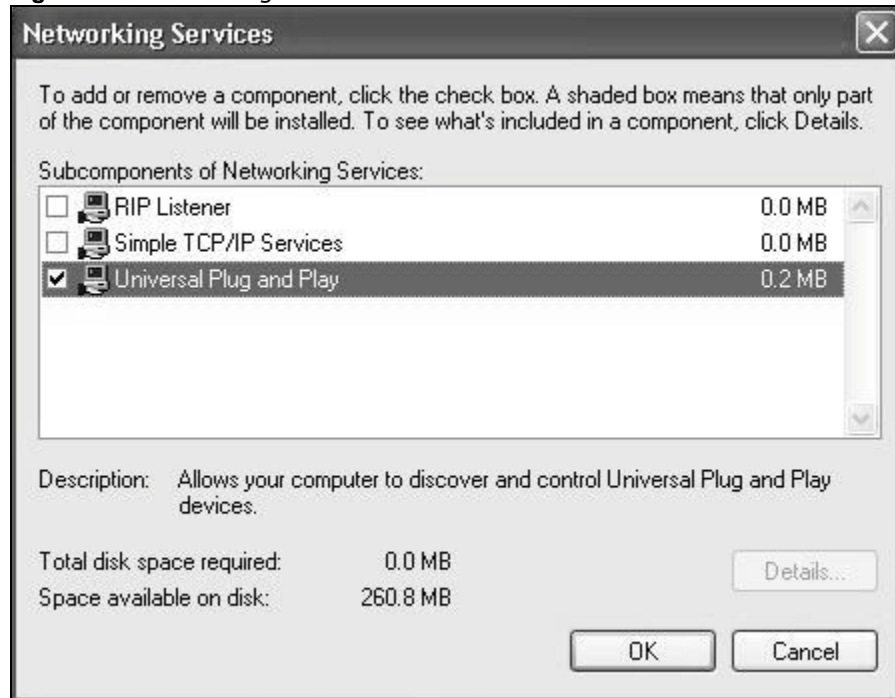

- 6 Click **OK** to go back to the **Windows Optional Networking Component Wizard** window and click **Next**.

## 7.11 Using UPnP in Windows XP Example

This section shows you how to use the UPnP feature in Windows XP. You must already have UPnP installed in Windows XP and UPnP activated on the Device.

Make sure the computer is connected to a LAN port of the Device. Turn on your computer and the Device.

### Auto-discover Your UPnP-enabled Network Device

- 1 Click **Start** and **Control Panel**. Double-click **Network Connections**. An icon displays under Internet Gateway.
- 2 Right-click the icon and select **Properties**.

Figure 60 Network Connections

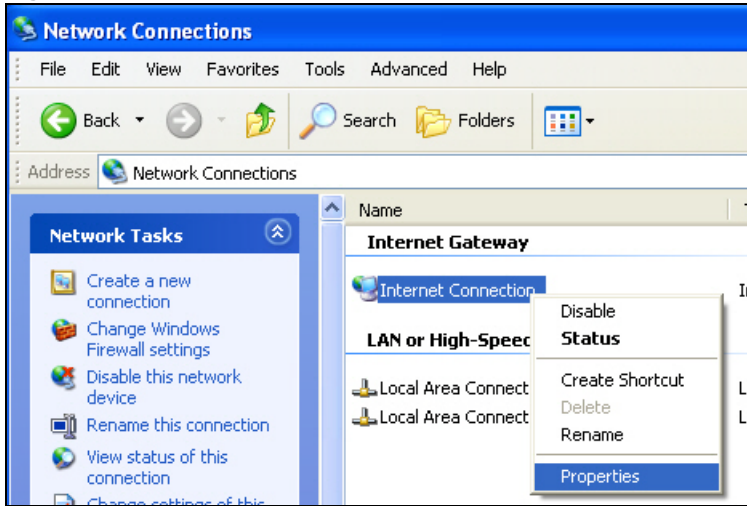

- 3 In the **Internet Connection Properties** window, click **Settings** to see the port mappings there were automatically created.

Figure 61 Internet Connection Properties

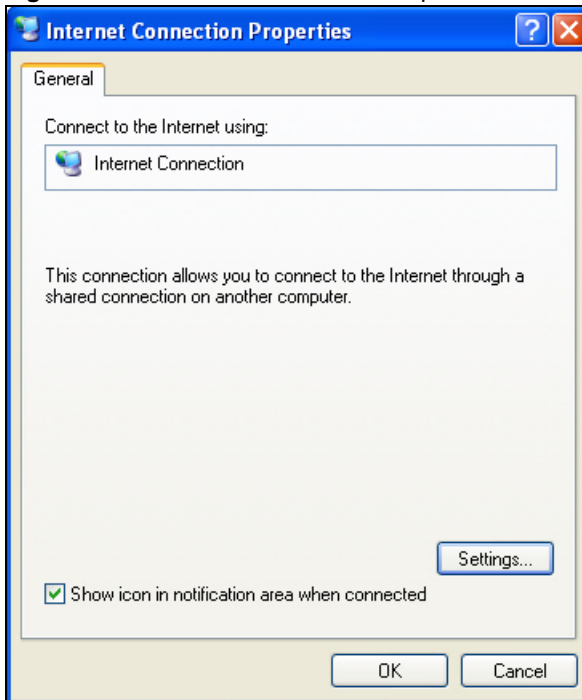

- 4 You may edit or delete the port mappings or click **Add** to manually add port mappings.

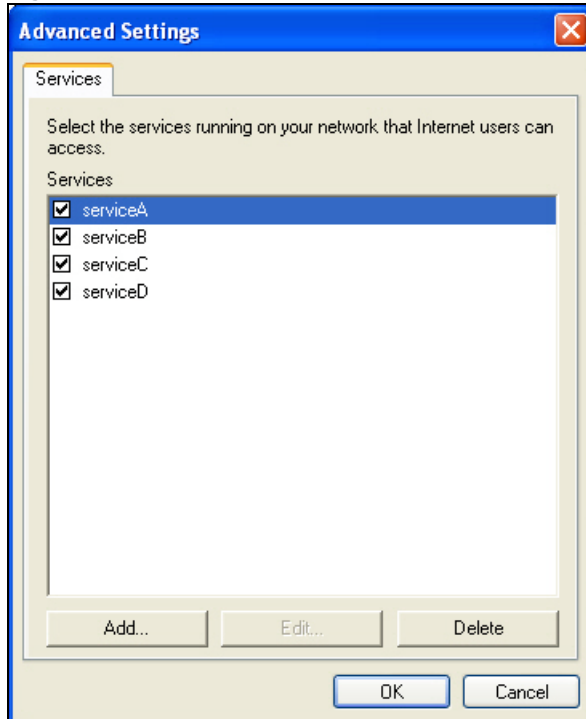
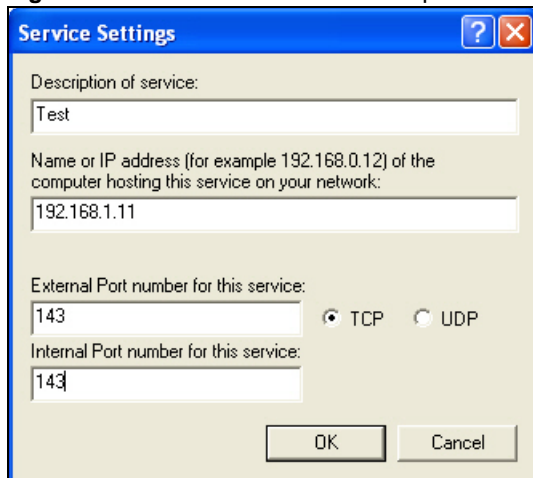

**Figure 62** Internet Connection Properties: Advanced Settings**Figure 63** Internet Connection Properties: Advanced Settings: Add

- 5 When the UPnP-enabled device is disconnected from your computer, all port mappings will be deleted automatically.
- 6 Select **Show icon in notification area when connected** option and click **OK**. An icon displays in the system tray.

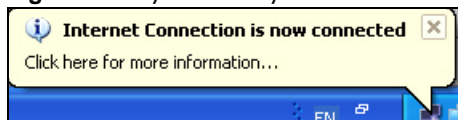
**Figure 64** System Tray Icon

- 7 Double-click on the icon to display your current Internet connection status.

**Figure 65** Internet Connection Status

### Web Configurator Easy Access

With UPnP, you can access the web-based configurator on the Device without finding out the IP address of the Device first. This comes helpful if you do not know the IP address of the Device.

Follow the steps below to access the web configurator.

- 1 Click **Start** and then **Control Panel**.
- 2 Double-click **Network Connections**.
- 3 Select **My Network Places** under **Other Places**.

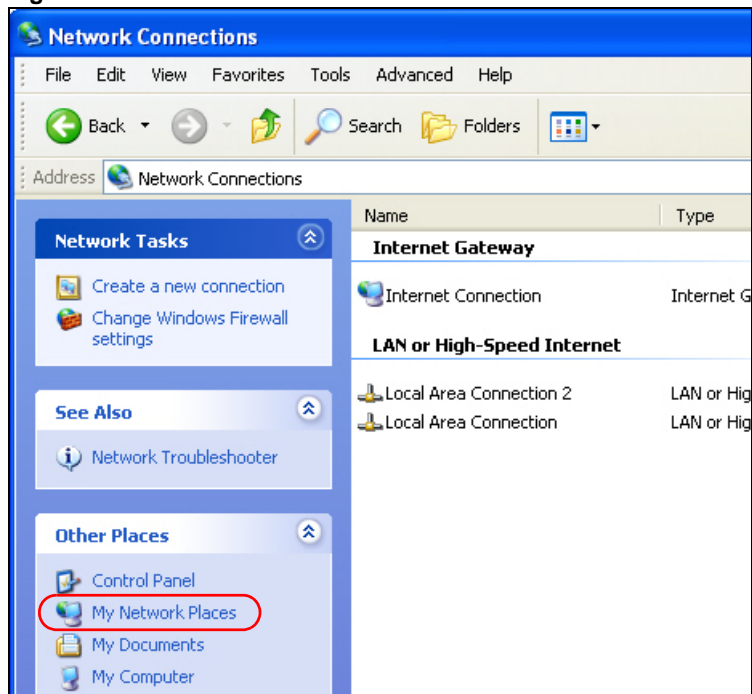
**Figure 66** Network Connections

- 4 An icon with the description for each UPnP-enabled device displays under **Local Network**.
- 5 Right-click on the icon for your Device and select **Invoke**. The web configurator login screen displays.

**Figure 67** Network Connections: My Network Places

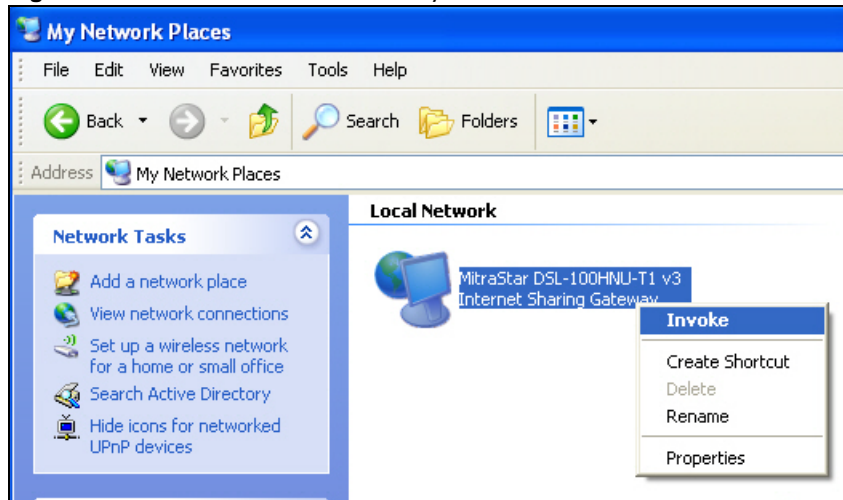

- 6 Right-click on the icon for your Device and select **Properties**. A properties window displays with basic information about the Device.

**Figure 68** Network Connections: My Network Places: Properties: Example





# Static Route

## 8.1 Overview

The Device usually uses the default gateway to route outbound traffic from computers on the LAN to the Internet. To have the Device send data to devices not reachable through the default gateway, use static routes.

For example, the next figure shows a computer (**A**) connected to the Device's LAN interface. The Device routes most traffic from **A** to the Internet through the Device's default gateway (**R1**). You create one static route to connect to services offered by your ISP behind router **R2**. You create another static route to communicate with a separate network behind a router **R3** connected to the LAN.

**Figure 69** Example of Static Routing Topology

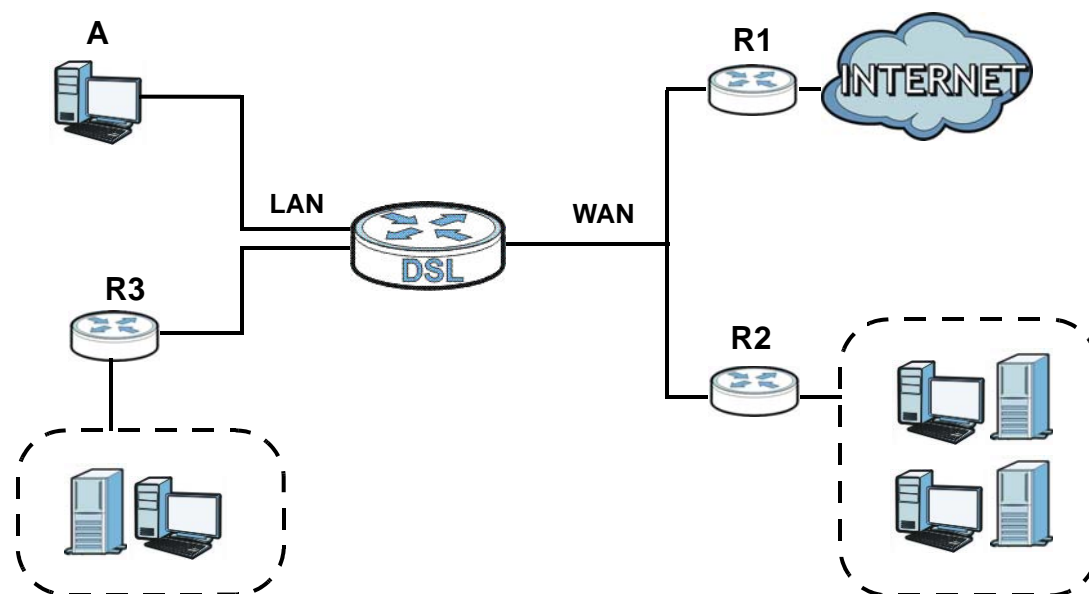



### 8.1.1 What You Can Do in this Chapter

- Use the **Static Route** screens ([Section 8.2 on page 102](#)) to view and configure IP static routes on the Device.
- Use the **IPv6 Static Route** screens ([Section 8.3 on page 103](#)) to view and configure IPv6 static routes on the Device.

## 8.2 Configuring Static Route

Use this screen to view and configure IP static routes on the Device. Click **Network Setting > Static Route** to open the following screen.

**Figure 70** Network Setting > Static Route

Add New Static Route						
#	Destination IP	Gateway	Subnet Mask	Interface	Metric	Modify
1	192.168.0.0	192.168.1.3	255.255.255.0	N/A	2	 

The following table describes the labels in this screen.

**Table 34** Network Setting > Static Route

LABEL	DESCRIPTION
Add New Static Route	Click this to set up a new static route on the Device.
#	This is the number of an individual static route.
Destination IP	This parameter specifies the IP network address of the final destination. Routing is always based on network number.
Gateway	This is the IP address of the gateway. The gateway is a router or switch on the same network segment as the device's LAN or WAN port. The gateway helps forward packets to their destinations.
Subnet Mask	This parameter specifies the IP network subnet mask of the final destination.
Interface	This is the WAN interface through which the traffic is routed.
Metric	This is the "cost" of transmission for routing purposes.
Modify	Click the <b>Edit</b> icon to go to the screen where you can set up a static route on the Device. Click the <b>Delete</b> icon to remove a static route from the Device.

### 8.2.1 Add/Edit Static Route

Click **Add New Static Route** in the **Static Route** screen or click the **Edit** icon next to a rule. The following screen appears. Use this screen to configure the required information for a static route.

**Figure 71** Static Route: Add/Edit

Add New Static Route
✕

Destination IP Address :

IP Subnet Mask :

Gateway IP Address :

Bound Interface:  LAN ▼

Metric :

The following table describes the labels in this screen.

**Table 35** Routing: Add/Edit

LABEL	DESCRIPTION
Destination IP Address	This parameter specifies the IP network address of the final destination. Routing is always based on network number. If you need to specify a route to a single host, use a subnet mask of 255.255.255.255 in the subnet mask field to force the network number to be identical to the host ID.
IP Subnet Mask	Enter the IP subnet mask here.
Gateway IP Address	You can decide if you want to forward packets to a gateway IP address or a bound interface.  If you want to configure <b>Gateway IP Address</b> , enter the IP address of the next-hop gateway. The gateway is a router or switch on the same network segment as the device's LAN or WAN port. The gateway helps forward packets to their destinations.
Bound Interface	You can decide if you want to forward packets to a gateway IP address or a bound interface.  If you want to configure <b>Bound Interface</b> , select the check box and choose an interface through which the traffic is sent. You must have the WAN interfaces already configured in the <b>Broadband</b> screen.
Metric	Enter the "cost" of transmission for routing purposes. IP routing uses hop count as the measurement of cost, with a minimum of 1 for directly-connected networks.
OK	Click this to save your changes.
Cancel	Click this to exit this screen without saving.

## 8.3 IPv6 Static Route

Use this screen to view the IPv6 static route rules. Click **Network Setting > Static Route > IPv6 Static Route** to open the **IPv6 Static Route** screen.

**Figure 72** Network Setting > Static Route > IPv6 Static Route

Add New Static Route					
#	Destination IP	Prefix length	Gateway	Device	Modify

The following table describes the labels in this screen.

**Table 36** Network Setting > Static Route > IPv6 Static Route

LABEL	DESCRIPTION
Add New Static route	Click this to configure a new IPv6 static route.
#	This is the number of an individual static route.
Destination IP	This is the IP network address of the final destination. Routing is always based on network number.
Prefix length	An IPv6 prefix length specifies how many most significant bits (starting from the left) in the address compose the network address. This field displays the bit number of the IPv6 subnet mask.
Gateway	This is the IPv6 address of the gateway. The gateway is a router or switch on the same network segment as the device's LAN or WAN port. The gateway has a route to the destination network and helps forward packets to their destinations.

**Table 36** Network Setting > Static Route > IPv6 Static Route (continued)

LABEL	DESCRIPTION
Device	This specifies the LAN or WAN PVC.
Modify	Click the <b>Edit</b> icon to go to the screen where you can set up a static route on the Device. Click the <b>Remove</b> icon to remove a static route from the Device. A window displays asking you to confirm that you want to delete the route.

### 8.3.1 IPv6 Static Route Edit

Use this screen to configure the required information for an IPv6 static route. Click **Add New Static Route** or select an IPv6 static route index number and click **Edit**. The screen shown next appears.

**Figure 73** Network Setting > Static Route > IPv6 Static Route: Add/Edit

The following table describes the labels in this screen.

**Table 37** Network Setting > Static Route > IPv6 Static Route: Add/Edit

LABEL	DESCRIPTION
Destination IPv6 Address	This parameter specifies the IP network address of the final destination. Routing is always based on network number. If you need to specify a route to a single host, use a prefix length of 128 in the prefix length field to force the network number to be identical to the host ID.
IPv6 Prefix Length	Enter the address prefix to specify how many most significant bits compose the network address.
Gateway IPv6 Address	Enter the IPv6 address of the gateway. The gateway is a router or switch on the same network segment as the device's LAN or WAN port. The gateway has a route to the destination network and helps forward packets to their destinations. If a link local address is used, the interface should also be specified.
Bound Interface	If you want to forward IPv6 packets to a bound interface, select the interface through which the traffic is sent.
OK	Click this to save your changes.
Cancel	Click this to restore your previously saved settings.



# Quality of Service (QoS)

## 9.1 Overview

This chapter discusses the Device's **QoS** screens. Use these screens to set up your Device to use QoS for traffic management.

Quality of Service (QoS) refers to both a network's ability to deliver data with minimum delay, and the networking methods used to control the use of bandwidth. QoS allows the Device to group and prioritize application traffic and fine-tune network performance.

Without QoS, all traffic data is equally likely to be dropped when the network is congested. This can cause a reduction in network performance and make the network inadequate for time-critical application such as video-on-demand.

The Device assigns each packet a priority and then queues the packet accordingly. Packets assigned a high priority are processed more quickly than those with low priority if there is congestion, allowing time-sensitive applications to flow more smoothly. Time-sensitive applications include both those that require a low level of latency (delay) and a low level of jitter (variations in delay) such as Internet gaming, and those for which jitter alone is a problem such as Internet radio or streaming video.

### 9.1.1 What You Can Do in this Chapter

- Use the **General** screen to enable QoS, set the bandwidth, and allow the Device to automatically assign priority to upstream traffic according to the IP precedence or packet length ([Section 9.2 on page 106](#)).
- Use the **Queue Setup** screen to configure QoS queue assignment ([Section 9.3 on page 107](#)).
- Use the **Class Setup** screen to set up classifiers to sort traffic into different flows and assign priority and define actions to be performed for a classified traffic flow ([Section 9.4 on page 108](#)).
- Use the **Policer Setup** screen to add, edit or delete QoS policers ([Section 9.5 on page 113](#)).
- Use the **Game List** screen to to give priority to traffic for specific games ([Section 9.6 on page 115](#)).

### 9.1.2 What You Need to Know

The following terms and concepts may help as you read this chapter.

#### QoS versus Cos

QoS is used to prioritize source-to-destination traffic flows. All packets in the same flow are given the same priority. CoS (class of service) is a way of managing traffic in a network by grouping similar types of traffic together and treating each type as a class. You can use CoS to give different priorities to different packet types.

CoS technologies includes DiffServ (Differentiated Services or DS). DiffServ is a new protocol and defines a new DS field, which replaces the eight-bit ToS (Type of Service) field in the IP header.

## Tagging and Marking

In a QoS class, you can configure whether to add or change the DSCP (DiffServ Code Point) value in a matched packet. When the packet passes through a compatible network, the networking device, such as a backbone switch, can provide specific treatment or service based on the tag or marker.

## 9.2 The QoS General Screen

Use this screen to enable or disable QoS, set the bandwidth, and select to have the Device automatically assign priority to upstream traffic according to the IP precedence or packet length.

Click **Network Setting** > **QoS** to open the **General** screen.

**Figure 74** Network Setting > QoS > General

The following table describes the labels in this screen.

**Table 38** Network Setting > QoS > General

LABEL	DESCRIPTION
Active QoS	Select the check box to turn on QoS to improve your network performance.  You can give priority to traffic that the Device forwards out through the WAN interface. Give high priority to voice and video to make them run more smoothly. Similarly, give low priority to many large file downloads so that they do not reduce the quality of other applications.
Traffic priority will be automatically assigned by	Select how the Device assigns priorities to various upstream traffic flows. <ul style="list-style-type: none"> <li>• <b>None:</b> Disables auto priority mapping and has the Device put packets into the queues according to your classification rules. Traffic which does not match any of the classification rules is mapped into the default queue with the lowest priority.</li> <li>• <b>Ethernet Priority:</b> Automatically assign priority based on the IEEE 802.1p priority level.</li> <li>• <b>IP Precedence:</b> Automatically assign priority based on the first three bits of the TOS field in the IP header.</li> <li>• <b>Packet Length:</b> Automatically assign priority based on the packet size. Smaller packets get higher priority since control, signaling, VoIP, internet gaming, or other real-time packets are usually small while larger packets are usually best effort data packets like file transfers.</li> </ul>
Apply	Click <b>Apply</b> to save your changes.
Cancel	Click <b>Cancel</b> to restore your previously saved settings.

## 9.3 The Queue Setup Screen

Use this screen to configure QoS queue assignment. Click **Network Setting > QoS > Queue Setup** to open the screen as shown next.

**Figure 75** Network Setting > QoS > Queue Setup

Inde:	Status	Name	Interface	Priority	Weight	Rate Limit	Modify
1		N/A	N/A	N/A	N/A	N/A N/A	 
2		N/A	N/A	N/A	N/A	N/A N/A	 
3		N/A	N/A	N/A	N/A	N/A N/A	 
4		N/A	N/A	N/A	N/A	N/A N/A	 

**Note :**  
If queue is deleted, then related classifiers will be removed too.

The following table describes the labels in this screen.

**Table 39** Network Setting > QoS > Queue Setup

LABEL	DESCRIPTION
Index	This is the index number of this entry.
Status	This indicates whether the queue is active or not. A yellow bulb signifies that this queue is active. A gray bulb signifies that this queue is not active.
Name	This shows the descriptive name of this queue.
Interface	This shows the name of the Device's interface through which traffic in this queue passes.
Priority	This shows the priority of this queue.
Weight	This shows the weight of this queue.
Rate Limit (kbps)	This shows the maximum transmission rate allowed for traffic on this queue.
Modify	Click the <b>Edit</b> icon to edit the queue. Click the <b>Delete</b> icon to delete an existing queue. Note that subsequent rules move up by one when you take this action.

### 9.3.1 Edit a QoS Queue

Use this screen to configure a queue. Click the **Edit** icon next to a QoS queue.

**Figure 76** Queue Setup: Edit

The following table describes the labels in this screen.

**Table 40** Queue Setup: Edit

LABEL	DESCRIPTION
Active	Select to enable or disable this queue.
Name	Enter the descriptive name of this queue.
Interface	Select the interface of this queue.
Priority	Select the priority level (from 1 to 7) of this queue.  The lower the number, the higher the priority level. Traffic assigned to higher priority queues gets through faster while traffic in lower priority queues is dropped if the network is congested.
Weight	Select the weight (from 1 to 15) of this queue.  If two queues have the same priority level, the Device divides the bandwidth across the queues according to their weights. Queues with larger weights get more bandwidth than queues with smaller weights.
Rate Limit	Specify the maximum transmission rate (in Kbps or %) allowed for traffic on this queue.
OK	Click this to save your changes.
Cancel	Click this to exit this screen without saving.

## 9.4 The Class Setup Screen

Use this screen to add, edit or delete QoS classifiers. A classifier groups traffic into data flows according to specific criteria such as the source address, destination address, source port number, destination port number or incoming interface. For example, you can configure a classifier to select traffic from the same protocol port (such as Telnet) to form a flow.

You can give different priorities to traffic that the Device forwards out through the WAN interface. Give high priority to voice and video to make them run more smoothly. Similarly, give low priority to many large file downloads so that they do not reduce the quality of other applications.

Click **Network Setting > QoS > Class Setup** to open the following screen.

**Figure 77** Network Setting > QoS > Class Setup

Index	Status	From Interface	Classification Criteria	DSCP (Traffic Class) Mark	802.1P/1Q Mark	To Queue	Modify
1						High	

The following table describes the labels in this screen.

**Table 41** Network Setting > QoS > Class Setup

LABEL	DESCRIPTION
Add new Classifier	Click this to create a new classifier.
Index	This field displays the order number of the classifier.
Status	This indicates whether the classifier is active or not. A yellow bulb signifies that this classifier is active. A gray bulb signifies that this classifier is not active.
From Interface	If the classifier applies to traffic coming in through a specific interface, it displays here.
Classification Criteria	This shows criteria specified in this classifier, for example the interface from which traffic of this class should come and the source MAC address of traffic that matches this classifier.
DSCP (Traffic Class) Mark	This is the DSCP number added to traffic of this classifier.
802.1P/1Q Mark	This is the IEEE 802.1p priority level assigned to traffic of this classifier.
To Queue	This is the name of the queue in which traffic of this classifier is put.
Modify	Click the <b>Edit</b> icon to edit the classifier. Click the <b>Delete</b> icon to delete an existing classifier. Note that subsequent rules move up by one when you take this action.

### 9.4.1 Add/Edit QoS Class

Click **Add new Classifier** in the **Class Setup** screen or the **Edit** icon next to an existing classifier to configure it.

**Figure 78** Class Setup: Add/Edit

The following table describes the labels in this screen.

**Table 42** Class Setup: Add/Edit

LABEL	DESCRIPTION
Rule Index	Select the (order) number of this rule.
Class Configuration	
Active	Select to enable this classifier.
Ether Type	Select the Ether type (IPv4, IPv6, ARP, or IEEE 802.1Q) to which this rule applies.
Interface	Select whether to apply this class to traffic from the LAN or from the WAN.

**Table 42** Class Setup: Add/Edit (continued)

LABEL	DESCRIPTION
To Queue	Select a queue to apply to this class (available when you set <b>Interface</b> to <b>From WAN</b> ). You should have configured a queue in the <b>Queue Setup</b> screen already.
Criteria Configuration	
Use the following fields to configure the criteria for traffic classification.	
Basic	
From Interface	Select the interface from which the traffic class comes.
Source	
IP Address	Select the check box and enter the source IP address in dotted decimal notation. A blank source IP address means any source IP address.
IP Subnet Mask	Enter the source subnet mask.
Exclude	Select this option to exclude the packets that match the specified criteria from this classifier.
Port Range	If you select <b>TCP</b> or <b>UDP</b> in the <b>IP Protocol</b> field, select the check box and enter the port number(s) of the source.
Exclude	Select this option to exclude the packets that match the specified criteria from this classifier.
MAC Address	Select the check box and enter the source MAC address of the packet.
MAC Mask	Type the mask for the specified MAC address to determine which bits a packet's MAC address should match.  Enter "f" for each bit of the specified source MAC address that the traffic's MAC address should match. Enter "0" for the bits of the matched traffic's MAC address, which can be of any hexadecimal characters. For example, if you set the MAC address to 00:13:49:00:00:00 and the mask to ff:ff:ff:00:00:00, a packet with a MAC address of 00:13:49:12:34:56 matches this criteria.
Exclude	Select this option to exclude the packets that match the specified criteria from this classifier.
Destination	
IP Address	Select the check box and enter the destination IP address in dotted decimal notation. A blank source IP address means any source IP address.
IP Subnet Mask	Enter the destination subnet mask.
Port Range	If you select <b>TCP</b> or <b>UDP</b> in the <b>IP Protocol</b> field, select the check box and enter the port number(s) of the source.
MAC Address	Select the check box and enter the destination MAC address of the packet.
MAC Mask	Type the mask for the specified MAC address to determine which bits a packet's MAC address should match.  Enter "f" for each bit of the specified source MAC address that the traffic's MAC address should match. Enter "0" for the bit(s) of the matched traffic's MAC address, which can be of any hexadecimal character(s). For example, if you set the MAC address to 00:13:49:00:00:00 and the mask to ff:ff:ff:00:00:00, a packet with a MAC address of 00:13:49:12:34:56 matches this criteria.
Exclude	Select this option to exclude the packets that match the specified criteria from this classifier.
Others	
Service	Select the service classification of the traffic ( <b>FTP</b> or <b>SIP</b> ).
IP Protocol	Select this option and select the protocol (service type) from <b>TCP</b> or <b>UDP</b> . If you select <b>User defined</b> , enter the protocol (service type) number.

**Table 42** Class Setup: Add/Edit (continued)

LABEL	DESCRIPTION
TCP ACK	If you select this option, the matched TCP packets must contain the ACK (Acknowledge) flag.
DHCP	<p>Select this option and select a DHCP option.</p> <p>If you select <b>Vendor Class ID (DHCP Option 60)</b>, enter the <b>Class ID</b> of the matched traffic, such as the type of the hardware or firmware.</p> <p>If you select <b>ClientID (DHCP Option 61)</b>, enter the <b>Type</b> of the matched traffic and <b>Client ID</b> of the DHCP client.</p> <p>If you select <b>User Class ID (DHCP Option 77)</b>, enter the <b>User Class Data</b>, which is a string that identifies the user's category or application type in the matched DHCP packets.</p> <p>If you select <b>VendorSpecificIntro (DHCP Option 125)</b>, enter the <b>Enterprise Number</b> of the software of the matched traffic and <b>Vendor Class Data</b> used by all the DHCP clients.</p>
Packet Length	<p>This field is available only when you select <b>IPv4 (0x0800)</b> in the <b>Ether Type</b> field.</p> <p>Select this option and enter the minimum and maximum packet length (from 46 to 1504) in the fields provided.</p>
IPP/DS Field	<p>Select <b>IPP/TOS</b> to specify an IP precedence range and type of services.</p> <p>Select <b>DSCP</b> to specify a DiffServ Code Point (DSCP) range.</p>
IP Precedence Range	Enter a range from 0 to 7 for IP precedence. 0 is the lowest priority and 7 is the highest.
Type of Service	Select a type of service from the drop-down list box.
DSCP Range (0 ~ 63)	Select this option and specify a DSCP (DiffServ Code Point) number between 0 and 63 in the field provided.
802.1P	<p>Select this option and select a priority level (between 0 and 7) from the drop-down list box.</p> <p>"0" is the lowest priority level and "7" is the highest.</p>
VLAN ID	Select this option and enter the source VLAN ID in this field.
Exclude	Select this option to exclude the packets that match the specified criteria from this classifier.
Action	
Forward To	<p>Select the interface through which traffic that matches the rule is forwarded out. If you select <b>Unchange</b>, the Device forwards traffic of this class according to the default routing table.</p> <p>If traffic of this class comes from a WAN interface and is in a queue that forwards traffic through the LAN/WLAN interface, the Device ignores the setting here.</p>
IPP/DS Field	<p>Select <b>IPP/TOS</b> to specify an IP precedence range and type of services.</p> <p>Select <b>DSCP</b> to specify a DiffServ Code Point (DSCP) range.</p>
IP Precedence Mark	Enter a range from 0 to 7 to re-assign IP precedence to matched traffic. 0 is the lowest priority and 7 is the highest.
Type Of Service Mark	<p>Select a type of service to re-assign the priority level to matched traffic.</p> <p>Available options are: <b>Normal service</b>, <b>Minimize delay</b>, <b>Maximize throughput</b>, <b>Maximize reliability</b> and <b>Minimize monetary cost</b>.</p>



**Table 42** Class Setup: Add/Edit (continued)

LABEL	DESCRIPTION
DSCP Mark(0~63)	This field is available only when you select <b>IPv4 (0x0800)</b> in the <b>Ether Type</b> field. If you select <b>Mark</b> , enter a DSCP value with which the Device replaces the DSCP field in the packets. If you select <b>Unchange</b> , the Device keep the DSCP field in the packets.
802.1Q Tag	If you select <b>Remark</b> , select a priority level (in the <b>Ethernet Priority</b> field) and enter a VLAN ID number (in the <b>VLAN ID</b> field) with which the Device replaces the IEEE 802.1p priority field and VLAN ID of the frames. If you select <b>Remove</b> , the Device deletes the VLAN ID of the frames before forwarding them out. If you select <b>Add</b> , the Device treat all matched traffic untagged and add a second priority level and VLAN ID that you specify in the <b>Ethernet Priority</b> and <b>VLAN ID</b> fields. If you select <b>Same</b> , the Device keep the Ethernet Priority and VLAN ID in the packets. To configure the Ethernet Priority, you can either select a priority number in the first drop-down list box (7 is the highest and 0 is the lowest priority) or select an application from the second drop-down list box which automatically maps to the corresponding priority number. (Key Net Traffic: 7; Voice: 6; Video: 5; IGMP: 4; Key Data: 3)
VLAN ID	Select this option and enter the source VLAN ID in this field.
OK	Click this to save your changes.
Cancel	Click this to exit this screen without saving.

## 9.5 The QoS Policer Setup Screen

Use this screen to configure QoS policers that allow you to limit the transmission rate of incoming traffic. Click **Network Setting > QoS > Policer Setup**. The screen appears as shown.

**Figure 79** Network Setting > QoS > Policer Setup

Add new Policer							
Index	Status	Name	Regulated Classes	Meter Type	Rule	Action	Modify
1		test	Class ID:#1;	SimpleTokenBucket	Committed Rate:200;Committed Burst Size:300	Conforming Action:Pass;Non-Conforming Action:Drop	

The following table describes the labels in this screen.

**Table 43** Network Setting > QoS > Policer Setup

LABEL	DESCRIPTION
Add new Policer	Click this to create a new entry.
#	This is the index number of the entry.
Status	This field displays whether the policer is active or not. A yellow bulb signifies that this policer is active. A gray bulb signifies that this policer is not active.
Name	This field displays the descriptive name of this policer.
Regulated Classes	This field displays the name of a QoS classifier.
Meter Type	This field displays the type of QoS metering algorithm used in this policer.

**Table 43** Network Setting > QoS > Policer Setup (continued)

LABEL	DESCRIPTION
Rule	These are the rates and burst sizes against which the policer checks the traffic of the member QoS classes.
Action	This shows the how the policer has the Device treat different types of traffic belonging to the policer’s member QoS classes.
Modify	Click the <b>Edit</b> icon to edit the policer.  Click the <b>Delete</b> icon to delete an existing policer. Note that subsequent rules move up by one when you take this action.

### 9.5.1 Add/Edit a QoS Policer

Click **Add new Policer** in the **Policer Setup** screen or the **Edit** icon next to a policer to show the following screen.

**Figure 80** Policer Setup: Add/Edit

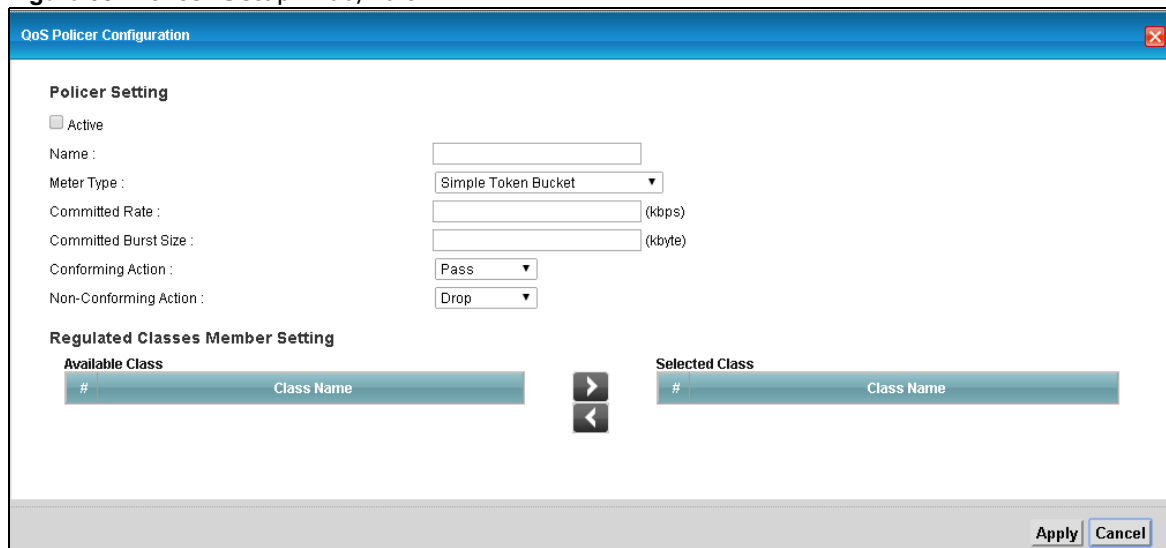

The following table describes the labels in this screen.

**Table 44** Policer Setup: Add/Edit

LABEL	DESCRIPTION
Active	Select the check box to activate this policer.
Name	Enter the descriptive name of this policer.
Meter Type	This shows the traffic metering algorithm used in this policer.  The <b>Simple Token Bucket</b> algorithm uses tokens in a bucket to control when traffic can be transmitted. Each token represents one byte. The algorithm allows bursts of up to <i>b</i> bytes which is also the bucket size.  The <b>Single Rate Three Color Marker (srTCM)</b> is based on the token bucket filter and identifies packets by comparing them to the Committed Information Rate (CIR), the Committed Burst Size (CBS) and the Excess Burst Size (EBS).  The <b>Two Rate Three Color Marker (trTCM)</b> is based on the token bucket filter and identifies packets by comparing them to the Committed Information Rate (CIR) and the Peak Information Rate (PIR).

**Table 44** Policer Setup: Add/Edit (continued)

LABEL	DESCRIPTION
Committed Rate	Specify the committed rate. When the incoming traffic rate of the member QoS classes is less than the committed rate, the device applies the conforming action to the traffic.
Committed Burst Size	Specify the committed burst size for packet bursts. This must be equal to or less than the peak burst size (two rate three color) or excess burst size (single rate three color) if it is also configured.  This is the maximum size of the (first) token bucket in a traffic metering algorithm.
Conforming Action	Specify what the Device does for packets within the committed rate and burst size (green-marked packets). <ul style="list-style-type: none"> <li>• <b>Pass:</b> Send the packets without modification.</li> <li>• <b>DSCP Mark:</b> Change the DSCP mark value of the packets. Enter the DSCP mark value to use.</li> </ul>
Non-Conforming Action	Specify what the Device does for packets that exceed the excess burst size or peak rate and burst size (red-marked packets). <ul style="list-style-type: none"> <li>• <b>Drop:</b> Discard the packets.</li> <li>• <b>DSCP Mark:</b> Change the DSCP mark value of the packets. Enter the DSCP mark value to use. The packets may be dropped if there is congestion on the network.</li> </ul>
Available Class	Select a QoS classifier to apply this QoS policer to traffic that matches the QoS classifier.
Selected Class	Highlight a QoS classifier in the <b>Available Class</b> box and use the > button to move it to the <b>Selected Class</b> box.  To remove a QoS classifier from the <b>Selected Class</b> box, select it and use the < button.
Apply	Click <b>Apply</b> to save your changes.
Cancel	Click <b>Cancel</b> to exit this screen without saving.

## 9.6 The QoS Game List Screen

Use this screen to give priority to traffic for specific games. Click **Advanced Setup > QoS > Game List** to open the screen as shown next.

**Figure 81** Network Setting > QoS > Game List

The following table describes the labels in this screen.

**Table 45** Network Setting > QoS > Game List

LABEL	DESCRIPTION
Enable Game List	Select this to have QoS give the highest priority to traffic for the games you specify. This priority is higher than the other QoS queues.  Select the games below.
Apply	Click this to save your changes.
Cancel	Click this to restore your previously saved settings.

## 9.7 QoS Technical Reference

This section provides some technical background information about the topics covered in this chapter.

### 9.7.1 DiffServ

QoS is used to prioritize source-to-destination traffic flows. All packets in the flow are given the same priority. You can use CoS (class of service) to give different priorities to different packet types.

DiffServ (Differentiated Services) is a class of service (CoS) model that marks packets so that they receive specific per-hop treatment at DiffServ-compliant network devices along the route based on the application types and traffic flow. Packets are marked with DiffServ Code Points (DSCPs) indicating the level of service desired. This allows the intermediary DiffServ-compliant network devices to handle the packets differently depending on the code points without the need to negotiate paths or remember state information for every flow. In addition, applications do not have to request a particular service or give advanced notice of where the traffic is going.

#### DSCP and Per-Hop Behavior

DiffServ defines a new DS (Differentiated Services) field to replace the Type of Service (TOS) field in the IP header. The DS field contains a 2-bit unused field and a 6-bit DSCP field which can define up to 64 service levels. The following figure illustrates the DS field.

DSCP is backward compatible with the three precedence bits in the ToS octet so that non-DiffServ compliant, ToS-enabled network device will not conflict with the DSCP mapping.

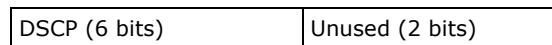

The DSCP value determines the forwarding behavior, the PHB (Per-Hop Behavior), that each packet gets across the DiffServ network. Based on the marking rule, different kinds of traffic can be marked for different kinds of forwarding. Resources can then be allocated according to the DSCP values and the configured policies.

# Network Address Translation (NAT)

## 10.1 Overview

NAT (Network Address Translation - NAT, RFC 1631) is the translation of the IP address of a host in a packet, for example, the source address of an outgoing packet, used within one network to a different IP address known within another network.

### 10.1.1 What You Can Do in this Chapter

- Use the **General** screen to limit the number of concurrent NAT sessions each client can use ([Section 10.2 on page 118](#)).
- Use the **Port Forwarding** screen to configure forward incoming service requests to the servers on your local network ([Section 10.3 on page 118](#)).
- Use the **DMZ** screen to configure a default server ([Section 10.4 on page 121](#)).
- Use the **ALG** screen to enable or disable the SIP ALG ([Section 10.5 on page 122](#)).

### 10.1.2 What You Need To Know

The following terms and concepts may help as you read this chapter.

#### Inside/Outside and Global/Local

Inside/outside denotes where a host is located relative to the Device, for example, the computers of your subscribers are the inside hosts, while the web servers on the Internet are the outside hosts.

Global/local denotes the IP address of a host in a packet as the packet traverses a router, for example, the local address refers to the IP address of a host when the packet is in the local network, while the global address refers to the IP address of the host when the same packet is traveling in the WAN side.

#### NAT

In the simplest form, NAT changes the source IP address in a packet received from a subscriber (the inside local address) to another (the inside global address) before forwarding the packet to the WAN side. When the response comes back, NAT translates the destination address (the inside global address) back to the inside local address before forwarding it to the original inside host.

## Port Forwarding

A port forwarding set is a list of inside (behind NAT on the LAN) servers, for example, web or FTP, that you can make visible to the outside world even though NAT makes your whole inside network appear as a single computer to the outside world.

## Finding Out More

See [Section 10.6 on page 122](#) for advanced technical information on NAT.

## 10.2 The General Screen

Use the **General** screen to limit the number of concurrent NAT sessions each client can use.

Click **Network Setting > NAT > General** to display the following screen.

**Figure 82** Network Setting > NAT > General

The following table describes the fields in this screen.

**Table 46** Network Setting > NAT > General

LABEL	DESCRIPTION
Max NAT/ Firewall Session Per User	Use this field to set a common limit to the number of concurrent NAT sessions each client computer can have.  If only a few clients use peer to peer applications, you can raise this number to improve their performance. With heavy peer to peer application use, lower this number to ensure no single client uses too many of the available NAT sessions.
Apply	Click <b>Apply</b> to save your changes.
Cancel	Click <b>Cancel</b> to restore your previously saved settings.

## 10.3 The Port Forwarding Screen

Use the **Port Forwarding** screen to forward incoming service requests to the servers on your local network.

You may enter a single port number or a range of port numbers to be forwarded, and the local IP address of the desired server. The port number identifies a service; for example, web service is on port 80 and FTP on port 21. In some cases, such as for unknown services or where one server can support more than one service (for example both FTP and web service), it might be better to

specify a range of port numbers. You can allocate a server IP address that corresponds to a port or a range of ports. Please refer to RFC 1700 for further information about port numbers.

**Note:** Many residential broadband ISP accounts do not allow you to run any server processes (such as a Web or FTP server) from your location. Your ISP may periodically check for servers and may suspend your account if it discovers any active services at your location. If you are unsure, refer to your ISP.

### Configuring Servers Behind Port Forwarding (Example)

Let's say you want to assign ports 21-25 to one FTP, Telnet and SMTP server (**A** in the example), port 80 to another (**B** in the example) and assign a default server IP address of 10.0.0.35 to a third (**C** in the example). You assign the LAN IP addresses and the ISP assigns the WAN IP address. The NAT network appears as a single host on the Internet.

**Figure 83** Multiple Servers Behind NAT Example

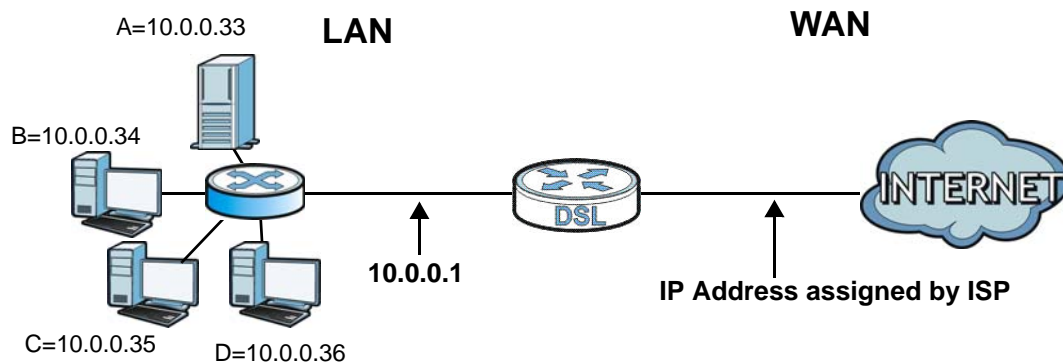

## 10.3.1 The Port Forwarding Screen

Click **Network Setting > NAT** to open the **Port Forwarding** screen.

**Figure 84** Network Setting > NAT > Port Forwarding

WAN Interface: ADSL_VCO								
<a href="#">Add new rule</a>								
#	Active	Service Name	External Start Port	External End Port	Internal Start Port	Internal End Port	Server IP Address	Modify
1	💡	FTP	20	21	20	21	192.168.1.35	🗑️
<b>Note:</b> The TCP port 7547 is reserved for TR069 connection request port.								

The following table describes the fields in this screen.

**Table 47** Network Setting > NAT > Port Forwarding

LABEL	DESCRIPTION
WAN Interface	Select the WAN interface for which to configure NAT port forwarding rules.
Add new rule	Click this to add a new port forwarding rule.
#	This is the index number of the entry.

**Table 47** Network Setting > NAT > Port Forwarding (continued)

LABEL	DESCRIPTION
Active	This field indicates whether the rule is active or not. A yellow bulb signifies that this rule is active. A gray bulb signifies that this rule is not active.
Service Name	This is the service's name. This shows <b>User Defined</b> if you manually added a service. You can change this by clicking the edit icon.
External Start Port	This is the first external port number that identifies a service.
External End Port	This is the last external port number that identifies a service.
Internal Start Port	This is the first internal port number that identifies a service.
Internal End Port	This is the last internal port number that identifies a service.
Server IP Address	This is the server's IP address.
Modify	Click the <b>Edit</b> icon to edit the port forwarding rule. Click the <b>Delete</b> icon to delete an existing port forwarding rule. Note that subsequent address mapping rules move up by one when you take this action.
Apply	Click <b>Apply</b> to save your changes.
Cancel	Click <b>Cancel</b> to restore your previously saved settings.

### 10.3.2 The Port Forwarding Add/Edit Screen

This screen lets you create or edit a port forwarding rule. Click **Add new rule** in the **Port Forwarding** screen or the **Edit** icon next to an existing rule to open the following screen.

**Figure 85** Port Forwarding: Add/Edit

The following table describes the labels in this screen.

**Table 48** Port Forwarding: Add/Edit

LABEL	DESCRIPTION
Active	Select or clear this field to turn the port forwarding rule on or off.
Service Name	Select a service to forward or select <b>User Defined</b> and enter a name in the field to the right.



**Table 48** Port Forwarding: Add/Edit (continued)

LABEL	DESCRIPTION
External Start Port	Configure this for a user-defined entry. Enter the original destination port for the packets.  To forward only one port, enter the port number again in the <b>External End Port</b> field.  To forward a series of ports, enter the start port number here and the end port number in the <b>External End Port</b> field.
External End Port	Configure this for a user-defined entry. Enter the last port of the original destination port range.  To forward only one port, enter the port number in the <b>External Start Port</b> field above and then enter it again in this field.  To forward a series of ports, enter the last port number in a series that begins with the port number in the <b>External Start Port</b> field above.
Server IP Address	Enter the inside IP address of the virtual server here.
Protocol	Select the protocol supported by this virtual server. Choices are <b>TCP</b> , <b>UDP</b> , or <b>TCP/UDP</b> .
Open Start Port	Configure this for a user-defined entry. This shows the port number to which you want the Device to translate the incoming port. For a range of ports, enter the first number of the range to which you want the incoming ports translated.
Open End Port	Configure this for a user-defined entry. This shows the last port of the translated port range.
Apply	Click this to save your changes.
Cancel	Click this to exit this screen without saving.

## 10.4 The DMZ Screen

Click **Network Setting > NAT > DMZ** to open the **DMZ** screen. Use this screen to specify the IP address of a default server to receive packets from ports not specified in the **Port Forwarding** screen.

**Figure 86** Network Setting > NAT > DMZ

WAN Interface :

Default Server Address :

**Note :**  
Enter IP address and click 'Apply' to activate the DMZ host.  
Input 0.0.0.0 in IP address field and click 'Apply' to deactivate the DMZ host.

The following table describes the fields in this screen.

**Table 49** Network Setting > NAT > DMZ

LABEL	DESCRIPTION
WAN Interface	Select the WAN interface for which to configure a default server.
Default Server Address	Enter the IP address of the default server which receives packets from ports that are not specified in the <b>Port Forwarding</b> screen.  Note: If you do not assign a default server, the Device discards all packets received for ports not specified in the virtual server configuration.
Apply	Click this to save your changes back to the Device.
Cancel	Click <b>Cancel</b> to restore your previously saved settings.

## 10.5 The ALG Screen

Click **Network Setting > NAT > ALG** to open the **ALG** screen. Use this screen to enable and disable the NAT Application Layer Gateway (ALG) in the Device.

The SIP ALG allows SIP calls to pass through NAT by examining and translating IP addresses embedded in the data stream. When the Device registers with the SIP register server, the SIP ALG translates the Device's private IP address inside the SIP data stream to a public IP address. You do not need to use STUN or an outbound proxy if you enable the SIP ALG.

**Figure 87** Network Setting > NAT > ALG

The screenshot shows a configuration window titled "ALG State". Below the title, it says "ALG:" followed by two radio buttons: "Enable" (which is unselected) and "Disable" (which is selected). At the bottom right of the window, there are two buttons: "Apply" and "Cancel".

The following table describes the fields in this screen.

**Table 50** Network Setting > NAT > ALG

LABEL	DESCRIPTION
SIP ALG	Enable this to make sure SIP (VoIP) works correctly with port-forwarding.
Apply	Click this to save your changes back to the Device.
Cancel	Click <b>Cancel</b> to restore your previously saved settings.

## 10.6 Technical Reference

This section provides some technical background information about the topics covered in this chapter.

## 10.6.1 NAT Definitions

Inside/outside denotes where a host is located relative to the Device, for example, the computers of your subscribers are the inside hosts, while the web servers on the Internet are the outside hosts.

Global/local denotes the IP address of a host in a packet as the packet traverses a router, for example, the local address refers to the IP address of a host when the packet is in the local network, while the global address refers to the IP address of the host when the same packet is traveling in the WAN side.

Note that inside/outside refers to the location of a host, while global/local refers to the IP address of a host used in a packet. Thus, an inside local address (ILA) is the IP address of an inside host in a packet when the packet is still in the local network, while an inside global address (IGA) is the IP address of the same inside host when the packet is on the WAN side. The following table summarizes this information.

**Table 51** NAT Definitions

ITEM	DESCRIPTION
Inside	This refers to the host on the LAN.
Outside	This refers to the host on the WAN.
Local	This refers to the packet address (source or destination) as the packet travels on the LAN.
Global	This refers to the packet address (source or destination) as the packet travels on the WAN.

NAT never changes the IP address (either local or global) of an outside host.

## 10.6.2 What NAT Does

In the simplest form, NAT changes the source IP address in a packet received from a subscriber (the inside local address) to another (the inside global address) before forwarding the packet to the WAN side. When the response comes back, NAT translates the destination address (the inside global address) back to the inside local address before forwarding it to the original inside host. Note that the IP address (either local or global) of an outside host is never changed.

The global IP addresses for the inside hosts can be either static or dynamically assigned by the ISP. In addition, you can designate servers, for example, a web server and a Telnet server, on your local network and make them accessible to the outside world. If you do not define any servers, NAT offers the additional benefit of firewall protection. With no servers defined, your Device filters out all incoming inquiries, thus preventing intruders from probing your network. For more information on IP address translation, refer to *RFC 1631, The IP Network Address Translator (NAT)*.

## 10.6.3 How NAT Works

Each packet has two addresses – a source address and a destination address. For outgoing packets, the ILA (Inside Local Address) is the source address on the LAN, and the IGA (Inside Global Address) is the source address on the WAN. For incoming packets, the ILA is the destination address on the LAN, and the IGA is the destination address on the WAN. NAT maps private (local) IP addresses to globally unique ones required for communication with hosts on other networks. It replaces the original IP source address (and TCP or UDP source port numbers for Many-to-One and Many-to-Many Overload NAT mapping) in each packet and then forwards it to the Internet. The

Device keeps track of the original addresses and port numbers so incoming reply packets can have their original values restored. The following figure illustrates this.

**Figure 88** How NAT Works

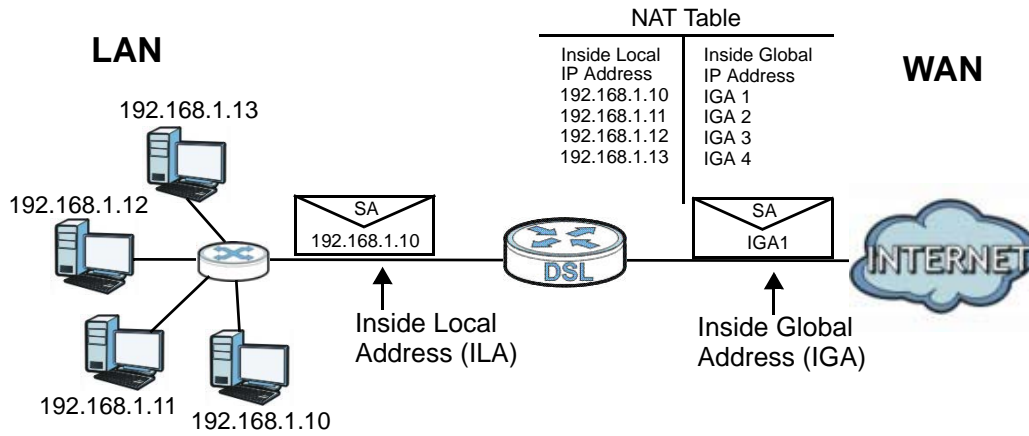

## Port Binding

### 11.1 Overview

Port binding aggregates port connections into logical groups. Bind WAN virtual channels (VCs) to Ethernet ports and WLANs to specify how traffic is forwarded. The Device forwards traffic from an Ethernet port only through the bound WAN virtual channel and vice versa. For ports not belonging to a port binding group, the Device forwards traffic according to the routing table.

Additionally, specify ATM QoS settings for an ADSL virtual channel (PVC) to satisfy the bandwidth requirements of the traffic the PVC carries. For example, create two port binding groups on the device (R1) for two different WAN ATM PVC connections. The first PVC (PVC1) handles non time-sensitive data traffic. The second PVC (PVC2) handle time sensitive Media-On-Demand (MOD) video traffic.

**Figure 89** Port Binding Groups

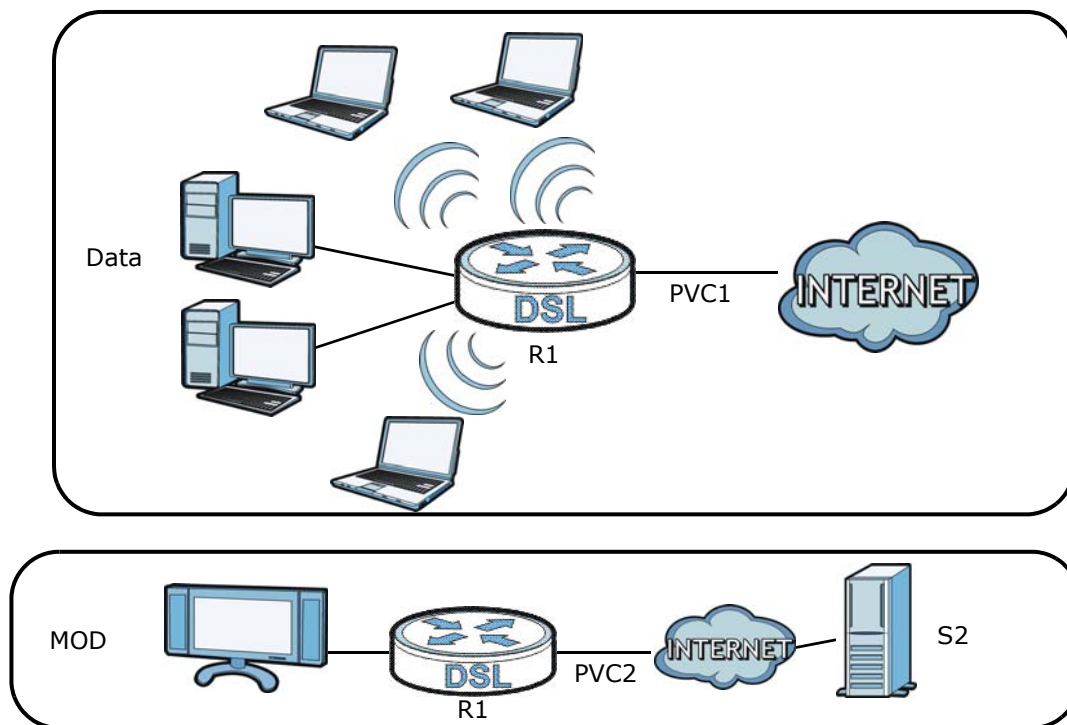

## 11.2 The Port Binding Screen

Use this screen to enable or disable port binding or any port any service. Click **Network Setting > Port Binding**. If you want to enable the port binding feature and configure port binding groups, select **Enable Port Binding**.

**Figure 90** Network Setting > Port Binding: Enable Port Binding

The following table describes the labels in this screen.

**Table 52** Network Setting > Port Binding: Enable Port Binding

LABEL	DESCRIPTION
Active	Activate or deactivate the port binding group.
Group Index	Select the index number for the port binding group.  When a port is assigned to a port binding group, traffic will be forwarded to the other ports in the group, but not to ports in other groups. If a port is not included in any groups, traffic will be forwarded according to the routing table.
ATM VCs	Select the ATM VC (PVC) to include in the port binding group. Each ATM VC can only be bound to one group.
Ethernet	Select the Ethernet (Eth) ports to include in the port binding group. Each Ethernet port can only be bound to one group.
Wireless LAN	Select the WLAN (AP) connections to include in the port binding group. Additional APs can be enabled on the <b>More AP</b> screen ( <a href="#">Section 6.3 on page 59</a> ).
Group Summary	
Port Binding Summary	Click this to view a summary of configured port binding groups.
Apply	Add the selected port binding group configuration.
Delete	Delete the selected port binding group configuration.
Cancel	Click this to restore your previously saved settings.

### 11.2.1 Port Binding Summary Screen

Use this screen to view configured port binding groups.

In the **Port Binding** screen, click the **Port Binding Summary** button in the **Group Summary** section to display the following screen.

**Figure 91** Network Setting > Port Binding: Port Binding Summary

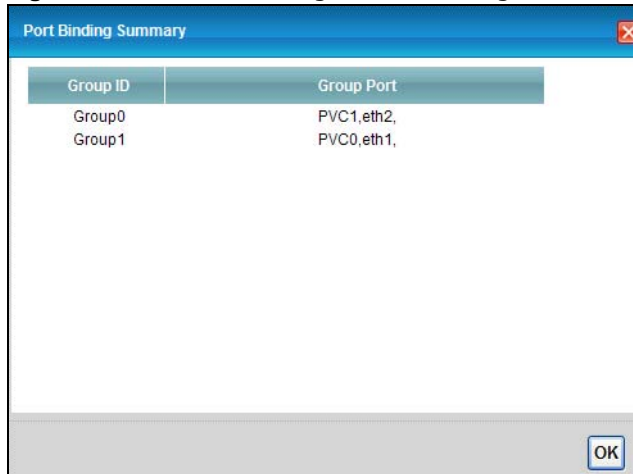

The following table describes the labels in this screen.

**Table 53** Network Setting > Port Binding: Port Binding Summary

LABEL	DESCRIPTION
Group ID	This field displays the group index number.
Group Port	This field displays the ports and virtual channels included in the group.
OK	Click this to close the screen.

If you want to enable the Any Port Any Service feature, select **Enable Any Port Any Service**. The Device binds a LAN port with WAN interface per source MAC or DHCP options from the LAN host dynamically. You can configure up to 5 dynamic port binding groups.

**Figure 92** Network Setting > Port Binding: Any Port Any Service

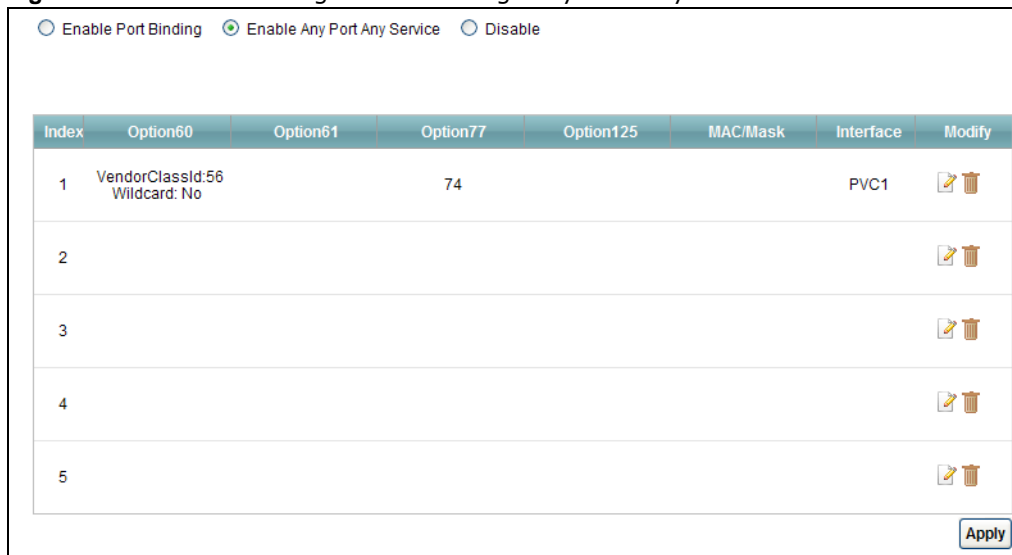

The following table describes the labels in this screen.

**Table 54** Network Setting > Port Binding: Any Port Any Service

LABEL	DESCRIPTION
Index	This is the index number for the port binding group.
Option60	This is the Vendor Class Identifier of the matched traffic.
Option61	This is the device identity of the matched traffic.
Option77	This is the User Class Identifier of the matched traffic
Option125	This is the vendor specific information of the matched traffic.
MAC/Mask	This is the source MAC address and MAC mask of the matched traffic.
Interface	This is the WAN interface of the port binding group.
Modify	Click the <b>Edit</b> icon to edit the port binding group. Click the <b>Delete</b> icon to delete an existing port binding group.
Apply	Click this to apply the settings.

## 11.2.2 The Any Port Any Service Edit Screen

This screen lets you create or edit a dynamic port binding group. Click the **Edit** icon of a port binding group in the **Port Binding: Any Port Any Service** screen to open the following screen.

**Figure 93** Any Port Any Service: Add/Edit

The screenshot shows the 'Any Port Any Service Edit' dialog box. The title bar reads 'Any Port Any Service Edit'. The main content area is organized into several sections:

- Interface:** A dropdown menu currently showing 'PVC0'.
- Source MAC:** A checkbox labeled 'Source MAC' is unchecked. Below it are two text input fields for 'MAC address' and 'MAC mask'.
- DHCP option60:** A checkbox labeled 'DHCP option60' is unchecked. Below it is a text input field for 'VendorClassId' and a checkbox labeled 'Enable wildcard on DHCP option 60' which is also unchecked.
- DHCP option61:** A checkbox labeled 'DHCP option61' is unchecked. Below it are text input fields for 'IAID' and 'DUID type' (which is a dropdown menu).
- DHCP option77:** A checkbox labeled 'DHCP option77' is unchecked. Below it is a text input field for 'Value'.
- DHCP option125:** A checkbox labeled 'DHCP option125' is unchecked. Below it are text input fields for 'Enterprise Number', 'Manufacturer OUI', 'Product Class', 'Model Name', and 'Serial Number'.

At the bottom right of the dialog, there are two buttons: 'OK' and 'Cancel'.



The following table describes the labels in this screen.

**Table 55** Any Port Any Service: Add/Edit

LABEL	DESCRIPTION
Interface	Select the WAN interface of the port binding group.
Source MAC	If you want to configure the port binding group by the source MAC address of the packet, select this check box and enter the MAC address and MAC mask.
MAC address	Enter the source MAC address of the packet.
MAC mask	Type the mask for the specified MAC address to determine which bits a packet's MAC address should match.  Enter "f" for each bit of the specified source MAC address that the traffic's MAC address should match. Enter "0" for the bit(s) of the matched traffic's MAC address, which can be of any hexadecimal character(s). For example, if you set the MAC address to 00:13:49:00:00:00 and the mask to ff:ff:ff:00:00:00, a packet with a MAC address of 00:13:49:12:34:56 matches this criteria.
DHCP Option60	Select this option and enter the Vendor Class Identifier (Option 60) of the matched traffic, such as the type of the hardware or firmware.
VendorClassId	Enter the Vendor Class Identifier of the matched traffic.
Enable wildcard on DHCP option 60	Select this option to be able to use wildcards in the Vendor Class Identifier configured for DHCP option 60.
DHCP option61	Select this and enter the device identity of the matched traffic.
IAID	Enter the Identity Association Identifier (IAID) of the device, for example, the WAN connection index number.
DUID type	Select <b>DUID-LLT</b> (DUID Based on Link-layer Address Plus Time) to enter the hardware type, a time value and the MAC address of the device.  Select <b>DUID-EN</b> (DUID Assigned by Vendor Based upon Enterprise Number) to enter the vendor's registered enterprise number.  Select <b>DUID-LL</b> (DUID Based on Link-layer Address) to enter the device's hardware type and hardware address (MAC address) in the following fields.  Select <b>Other</b> to enter any string that identifies the device in the DUID field.
DHCP option77	Select this and enter a string that identifies the user's category or application type in the matched DHCP packets.
Value	Enter a string that identifies the user's category or application type in the matched DHCP packets
DHCP option125	Select this and enter vendor specific information of the matched traffic.
Enterprise Number	Enter the vendor's 32-bit enterprise number registered with the IANA (Internet Assigned Numbers Authority).
Manufacturer OUI	Specify the vendor's OUI (Organization Unique Identifier). It is usually the first three bytes of the MAC address.
Product Class	Enter the product class of the device.
Model Name	Enter the model name of the device.
Serial Number	Enter the serial number of the device.
OK	Click this to save your changes.
Cancel	Click this to exit this screen without saving.

If you want to disable the port binding feature on the Device, select **Disable** in the **Port Binding** screen and click **Apply**.

It is suggested to reboot the Device after you have changed the port binding settings or WAN encapsulation.

**Figure 94** Network Setting > Port Binding: Disable

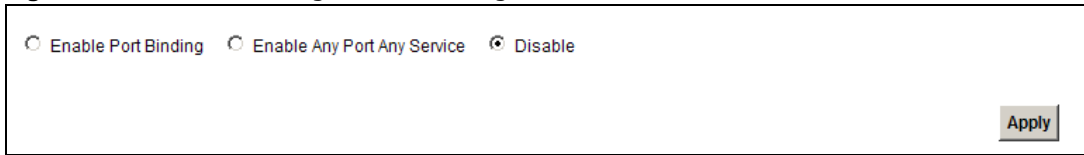

The screenshot shows a configuration page for "Port Binding: Disable". It contains three radio button options: "Enable Port Binding", "Enable Any Port Any Service", and "Disable". The "Disable" option is selected. An "Apply" button is located in the bottom right corner of the configuration area.

# Dynamic DNS

## 12.1 Overview

This chapter discusses how to configure your Device to use Dynamic DNS.

Dynamic DNS allows you to update your current dynamic IP address with one or many dynamic DNS services so that anyone can contact you (in applications such as NetMeeting and CU-SeeMe). You can also access your FTP server or Web site on your own computer using a domain name (for instance myhost.dhs.org, where myhost is a name of your choice) that will never change instead of using an IP address that changes each time you reconnect. Your friends or relatives will always be able to call you even if they don't know your IP address.

First of all, you need to have registered a dynamic DNS account with [www.dyndns.org](http://www.dyndns.org). This is for people with a dynamic IP from their ISP or DHCP server that would still like to have a domain name. The Dynamic DNS service provider will give you a password or key.

### 12.1.1 What You Need To Know

#### DYNDNS Wildcard

Enabling the wildcard feature for your host causes \*.yourhost.dyndns.org to be aliased to the same IP address as yourhost.dyndns.org. This feature is useful if you want to be able to use, for example, [www.yourhost.dyndns.org](http://www.yourhost.dyndns.org) and still reach your hostname.

If you have a private WAN IP address, then you cannot use Dynamic DNS.

## 12.2 The Dynamic DNS Screen

Use the **Dynamic DNS** screen to enable DDNS and configure the DDNS settings on the Device. To change your Device's DDNS, click **Network Setting** > **Dynamic DNS**. The screen appears as shown.

**Figure 95** Network Setting > Dynamic DNS

**Dynamic DNS Configuration**

Dynamic DNS  Enable  Disable

Service Provider :

Host Name :

Username :

Password :

**Dynamic DNS Status**

User Authentication Result:

Last Updated Time:

Current Dynamic IP:

The following table describes the fields in this screen.

**Table 56** Network Setting > Dynamic DNS

LABEL	DESCRIPTION
Dynamic DNS Configuration	
Dynamic DNS	Select <b>Enable</b> to use dynamic DNS.
Service Provider	Select the name of your Dynamic DNS service provider.
Host Name	Type the domain name assigned to your Device by your Dynamic DNS provider.
Username	Type your user name for the Dynamic DNS service provider.
Password	Type your password for the Dynamic DNS service provider.
Apply	Click <b>Apply</b> to save your changes.
Cancel	Click <b>Cancel</b> to restore your previously saved settings.
Dynamic DNS Status	
User Authentication Result	This field displays the results of the Device's attempt to authenticate with the Dynamic DNS service provider.
Last Updated Time	This field displays when the Device last updated its WAN IP address to the Dynamic DNS service provider.
Current Dynamic IP	This field displays the Device's current WAN IP address.

## 13.1 Overview

This chapter introduces filter rules you can configure to restrict traffic by IPv4 and IPv6 addresses and MAC addresses.

### 13.1.1 What You Can Do in the Filter Screens

- Use the **IP/MAC Filter** screen ([Section 13.2 on page 133](#)) to create IPv4/MAC filter rules.
- Use the **IPv6/MAC Filter** screen ([Section 13.3 on page 135](#)) to create IPv6/MAC filter rules.

## 13.2 The IP/MAC Filter Screen

Use this screen to create and apply IPv4/MAC filters. Click **Security > Filter** to display the screen as shown.

**Figure 96** Security > Filter

**Rule Type**

Rule Type selection: White List

**IP / MAC Filter Rule Editing**

IP / MAC Filter Rule Index: 1

Active:  Yes  No

Interface: PVC0

Direction: Incoming

Rule Type: IP

Source IP Address: 0.0.0.0 (0.0.0.0 means Don't care)

Subnet Mask: 0.0.0.0

Port Number: 0 (0 means Don't care)

Destination IP Address: 0.0.0.0 (0.0.0.0 means Don't care)

Subnet Mask: 0.0.0.0

Port Number: 0

Protocol: TCP

**IP / MAC Filter Listing**

IP / MAC Filter Rule Index: 1

#	Active	Interface	Direction	Src IP/Mask	Dest IP/Mask	Mac Address	Src Port	Dest Port	Protocol
1	No	PVC0	Incoming	0.0.0.0/ 0.0.0.0	0.0.0.0/ 0.0.0.0	N/A	0	0	TCP

The following table describes the labels in this screen.

**Table 57** Security > Filter

LABEL	DESCRIPTION
Rule Type	
Rule Type selection	Select <b>White List</b> to create a filter rule that allows traffic. Select <b>Black List</b> to create a filter rule that blocks traffic.
IP/MAC Filter Rule Editing	
IP/MAC Filter Rule Index	Select the index number of the filter rule.
Active	Use this field to enable or disable the rule.
Interface	Select the interface to which to apply the filter.
Direction	Apply the filter to <b>Incoming</b> or <b>Outgoing</b> traffic direction.
Rule Type	Select <b>IP</b> to filter traffic by IP addresses. Select <b>MAC</b> to filter traffic by MAC address.
Source IP Address	Enter the source IP address of the packets you wish to filter. This field is ignored if it is 0.0.0.0.
Subnet Mask	Enter the IP subnet mask for the source IP address.
Port Number	Enter the source port of the packets that you wish to filter. The range of this field is 0 to 65535. This field is ignored if it is 0.
Destination IP Address	Enter the destination IP address of the packets you wish to filter. This field is ignored if it is 0.0.0.0.
Subnet Mask	Enter the IP subnet mask for the destination IP address.
Port Number	Enter the destination port of the packets that you wish to filter. The range of this field is 0 to 65535. This field is ignored if it is 0.
Protocol	Select <b>ICMP</b> , <b>TCP</b> or <b>UDP</b> for the upper layer protocol.
Source MAC Address	This field is only available when you select <b>MAC</b> in the <b>Rule Type</b> field. Enter the MAC address of the packets you wish to filter.
IP / MAC Filter Listing	
#	This is the index number of the filter rule.
Active	This field shows whether the rule is activated.
Interface	This field shows the interface to which the filter rule applies.
Direction	The filter rule applies to this traffic direction.
Src IP/Mask	This is the source IP address and subnet mask when you select <b>IP</b> as the rule type. This is the MAC address when you select <b>MAC</b> as the rule type.
Dest IP/Mask	This is the destination IP address and subnet mask.
MAC Address	For a MAC filter rule this field shows the MAC address of the packets to filter.
Src Port	This is the source port number.
Dest Port	This is the destination port number.
Protocol	This is the upper layer protocol.
Apply	Click this to save your changes.
Delete	Click this to remove the filter rule selected in the <b>IP / MAC Filter Rule Index</b> field.
Cancel	Click this to restore your previously saved settings.

## 13.3 The IPv6/MAC Filter Screen

Use this screen to create and apply IPv6/MAC filters. Click **Security > Filter > IPv6/MAC Filter** to display the screen as shown.

**Figure 97** Security > Filter > IPv6/MAC Filter

**Rule Type**  
Rule Type selection: White List

**IPv6 / MAC Filter Rule Editing**  
IPv6 / MAC Filter Rule Index: 1  
Active:  Yes  No  
Interface: PVC0  
Direction: Incoming  
Rule Type: IP  
Source IP Address:   
Source Prefix Length:   
Destination IPv6 Address:   
Destination Prefix Length:   
ICMPv6 Type: 1 / Destination Unreachable (0 - no route to destination)  
Protocol: ICMPv6

**IPv6 / MAC Filter Listing**  
IPv6 / MAC Filter Rule Index: 1

#	Active	Interface	Direction	ICMPv6Type	Src IP/Prefix length	Dest IP/Prefix length	Mac Address	Protocol
1	No	PVC0	Incoming	N/A	N/A/ N/A	N/A/ N/A	N/A	ICMPv6

Apply Delete Cancel

The following table describes the labels in this screen.

**Table 58** Security > Filter > IPv6/MAC Filter

LABEL	DESCRIPTION
Rule Type	
Rule Type selection	Select <b>White List</b> to create a filter rule that allows traffic. Select <b>Black List</b> to create a filter rule that blocks traffic.
IPv6 / MAC Filter Rule Editing	
IPv6 / MAC Filter Rule Index	Select the index number of the filter rule.
Active	Use this field to enable or disable the rule.
Interface	Select the interface to which to apply the filter.
Direction	Apply the filter to <b>Incoming</b> or <b>Outgoing</b> traffic direction.
Rule Type	Select <b>IP</b> to filter traffic by IP addresses. Select <b>MAC</b> to filter traffic by MAC address.
Source IP Address	Enter the source IPv6 address of the packets you wish to filter. This field is ignored if it is ::.
Subnet Mask	Enter the IPv6 subnet mask for the source IPv6 address.
Source Prefix Length	Enter the prefix length for the source IPv6 address.

**Table 58** Security > Filter > IPv6/MAC Filter (continued)

LABEL	DESCRIPTION
Destination IPv6 Address	Enter the destination IPv6 address of the packets you wish to filter. This field is ignored if it is ::.
Destination Prefix Length	Enter the prefix length for the destination IPv6 address.
ICMPv6 Type	<p>Select one of the following ICMPv6 message types to filter.</p> <p><b>1 / Destination Unreachable:</b> 0 - no route to destination; 1 - communication with destination administratively prohibited; 3 - address unreachable; 4 - port unreachable</p> <p><b>2 / Packet Too Big</b></p> <p><b>3 / Time Exceeded:</b> 0 - hop limit exceeded in transit; 1 - fragment reassembly time exceeded</p> <p><b>4 / Parameter Problem:</b> 0 - erroneous header field encountered; 1 - unrecognized Next Header type encountered; 2 - unrecognized IPv6 option encountered</p> <p><b>128 / Echo Request</b></p> <p><b>129 / Echo Response</b></p> <p><b>130 / Listener Query</b> - Multicast listener query</p> <p><b>131 / Listener Report</b> - Multicast listener report</p> <p><b>132 / Listener Done</b> - Multicast listener done</p> <p><b>143 / Listener Reportv2</b> - Multicast listener report v2</p> <p><b>133 / Router Solicitation</b></p> <p><b>134 / Router Advertisement</b></p> <p><b>135 / Neighbor Solicitation</b></p> <p><b>136 / Neighbor Advertisement</b></p> <p><b>137 / Redirect</b> - Redirect message</p>
Protocol	This is the (upper layer) protocol that defines the service to which this rule applies. By default it is ICMPv6.
Source MAC Address	<p>This field is only available when you select <b>MAC</b> in the <b>Rule Type</b> field.</p> <p>Enter the MAC address of the packets you wish to filter.</p>
IPv6 / MAC Filter Listing	
IPv6 / MAC Filter Rule Index	Select the index number of the filter set from the drop-down list box.
#	This is the index number of the rule in a filter set.
Active	This field shows whether the rule is activated.
Interface	This is the interface that the rule applies to.
Direction	The filter set applies to this traffic direction.
ICMPv6 Type	The ICMPv6 message type to filter.
Src IP/PrefixLength	This displays the source IPv6 address and prefix length.
Dest IP/PrefixLength	This displays the destination IPv6 address and prefix length.
Mac Address	This is the MAC address of the packets being filtered.
Protocol	This is the (upper layer) protocol that defines the service to which this rule applies. By default it is ICMPv6.
Apply	Click this to save your changes.



**Table 58** Security > Filter > IPv6/MAC Filter (continued)

LABEL	DESCRIPTION
Delete	Click this to remove the filter rule selected in the <b>IPv6 / MAC Filter Rule Index</b> field.
Cancel	Click this to restore your previously saved settings.



## 14.1 Overview

This chapter shows you how to enable the Device firewall. Use the firewall to protect your Device and network from attacks by hackers on the Internet and control access to it. The firewall:

- allows traffic that originates from your LAN computers to go to all other networks.
- blocks traffic that originates on other networks from going to the LAN.
- blocks SYN and port scanner attacks.

By default, the Device blocks DDOS, LAND and Ping of Death attacks whether the firewall is enabled or disabled.

The following figure illustrates the firewall action. User **A** can initiate an IM (Instant Messaging) session from the LAN to the WAN (1). Return traffic for this session is also allowed (2). However other traffic initiated from the WAN is blocked (3 and 4).

**Figure 98** Default Firewall Action

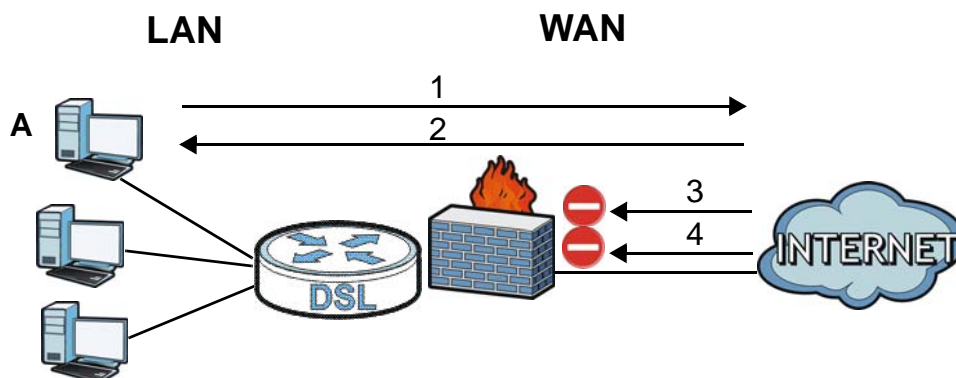

### 14.1.1 What You Can Do in the Firewall Screens

- Use the **General** screen ([Section 14.2 on page 141](#)) to select the firewall protection level on the Device.
- Use the **Default Action** screen ([Section 14.3 on page 142](#)) to set the default action that the firewall takes on packets that do not match any of the firewall rules.
- Use the **Rules** screen ([Section 14.4 on page 143](#)) to view the configured firewall rules and add, edit or remove a firewall rule.

- Use the **Dos** screen ([Section 14.5 on page 148](#)) to set the thresholds that the Device uses to determine when to start dropping sessions that do not become fully established (half-open sessions).

## 14.1.2 What You Need to Know About Firewall

### SYN Attack

A SYN attack floods a targeted system with a series of SYN packets. Each packet causes the targeted system to issue a SYN-ACK response. While the targeted system waits for the ACK that follows the SYN-ACK, it queues up all outstanding SYN-ACK responses on a backlog queue. SYN-ACKs are moved off the queue only when an ACK comes back or when an internal timer terminates the three-way handshake. Once the queue is full, the system will ignore all incoming SYN requests, making the system unavailable for legitimate users.

### DoS

Denials of Service (DoS) attacks are aimed at devices and networks with a connection to the Internet. Their goal is not to steal information, but to disable a device or network so users no longer have access to network resources. The Device is pre-configured to automatically detect and thwart all known DoS attacks.

### DDoS

A Distributed DoS (DDoS) attack is one in which multiple compromised systems attack a single target, thereby causing denial of service for users of the targeted system.

### LAND Attack

In a Local Area Network Denial (LAND) attack, hackers flood SYN packets into the network with a spoofed source IP address of the target system. This makes it appear as if the host computer sent the packets to itself, making the system unavailable while the target system tries to respond to itself.

### Ping of Death

Ping of Death uses a "ping" utility to create and send an IP packet that exceeds the maximum 65,536 bytes of data allowed by the IP specification. This may cause systems to crash, hang or reboot.

### SPI

Stateful Packet Inspection (SPI) tracks each connection crossing the firewall and makes sure it is valid. Filtering decisions are based not only on rules but also context. For example, traffic from the WAN may only be allowed to cross the firewall in response to a request from the LAN.

### RFC 4890 SPEC Traffic

RFC 4890 specifies the filtering policies for ICMPv6 messages. This is important for protecting against security threats including DoS, probing, redirection attacks and renumbering attacks that

can be carried out through ICMPv6. Since ICMPv6 error messages are critical for establishing and maintaining communications, filtering policy focuses on ICMPv6 informational messages.

## Anti-Probing

If an outside user attempts to probe an unsupported port on your Device, an ICMP response packet is automatically returned. This allows the outside user to know the Device exists. The Device supports anti-probing, which prevents the ICMP response packet from being sent. This keeps outsiders from discovering your Device when unsupported ports are probed.

## ICMP

Internet Control Message Protocol (ICMP) is a message control and error-reporting protocol between a host server and a gateway to the Internet. ICMP uses Internet Protocol (IP) datagrams, but the messages are processed by the TCP/IP software and directly apparent to the application user.

## DoS Thresholds

For DoS attacks, the Device uses thresholds to determine when to drop sessions that do not become fully established. These thresholds apply globally to all sessions. You can use the default threshold values, or you can change them to values more suitable to your security requirements.

## 14.2 Firewall General Screen

Use this screen to select the firewall protection level on the Device. Click **Security > Firewall > General** to display the following screen.

**Figure 99** Security > Firewall > General

**Firewall**

- High  
This setting blocks all traffic to and from the Internet. Only local network traffic and LAN to WAN service (Telnet, FTP, HTTP, HTTPS, DNS, POP3, SMTP) is permitted.
- Medium  
This is the recommended setting. It allows traffic to the Internet but blocks anyone from the Internet from accessing any services on your local network.
- Low  
This setting allows traffic to the Internet and also allows someone from the Internet to access services on your local network. This would be used with Port Forwarding, Default Server.
- Custom  
This setting allows the customer to create and edit individual firewall rules.
- Off  
This setting is not recommended. It disables firewall protection for your network and could potentially expose your network to significant security risks. This option should only be used for troubleshooting or if you intend using another firewall in conjunction with your ZyXEL router.

The following table describes the labels in this screen.

**Table 59** Security > Firewall > General

LABEL	DESCRIPTION
High	This setting blocks all traffic to and from the Internet. Only local network traffic and LAN to WAN service (Telnet, FTP, HTTP, HTTPS, DNS, POP3, SMTP) is permitted.
Medium	This is the recommended setting. It allows traffic to the Internet but blocks anyone from the Internet from accessing any services on your local network.
Low	This setting allows traffic to the Internet and also allows someone from the Internet to access services on your local network. This would be used with Port Forwarding, Default Server.
Custom	This setting allows the customer to create and edit individual firewall rules.  Firewall rules can be created in the Default Action screen ( <a href="#">Section 14.3 on page 142</a> ) and Rules screen ( <a href="#">Section 14.4 on page 143</a> ).
Off	This setting is not recommended. It disables firewall protection for your network and could potentially expose your network to significant security risks. This option should only be used for troubleshooting or if you intend using another firewall in conjunction with your router.
Apply	Click this to save your changes.
Cancel	Click this to restore your previously saved settings.

## 14.3 Default Action Screen

Use this screen to set the default action that the firewall takes on packets that do not match any of the firewall rules. Click **Security > Firewall > Default Action** to display the following screen.

**Figure 100** Security > Firewall > Default Action

The screenshot shows a configuration screen for the Default Action. It is divided into two columns: 'Packet Direction' and 'Default Action'. Under 'Packet Direction', there are four entries: 'WAN to LAN', 'LAN to WAN', 'WAN to Router', and 'LAN to Router'. Under 'Default Action', there are four dropdown menus corresponding to each direction, with the following selected values: 'Drop', 'Permit', 'Drop', and 'Permit'. At the bottom of the screen, there are two buttons: 'Apply' and 'Cancel'.

Packet Direction	Default Action
WAN to LAN	Drop
LAN to WAN	Permit
WAN to Router	Drop
LAN to Router	Permit

Buttons: Apply, Cancel

The following table describes the labels in this screen.

**Table 60** Security > Firewall > Default Action

LABEL	DESCRIPTION
Packet Direction	This is the direction of travel of packets ( <b>WAN to LAN</b> , <b>LAN to WAN</b> , <b>WAN to Router</b> , <b>LAN to Router</b> ).  Firewall rules are grouped based on the direction of travel of packets to which they apply. For example, <b>LAN to Router</b> means packets traveling from a computer/subnet on the LAN to the Device itself.
Default Action	Use the drop-down list boxes to select the default action that the firewall is to take on packets that are traveling in the selected direction and do not match any of the firewall rules.  Select <b>Drop</b> to silently discard the packets without sending a TCP reset packet or an ICMP destination-unreachable message to the sender.  Select <b>Reject</b> to deny the packets and send a TCP reset packet (for a TCP packet) or an ICMP destination-unreachable message (for a UDP packet) to the sender.  Select <b>Permit</b> to allow the passage of the packets.
Apply	Click this to save your changes.
Cancel	Click this to restore your previously saved settings.

## 14.4 Rules Screen

Click **Security > Firewall > Rules** to display the following screen. This screen displays a list of the configured firewall rules. Note the order in which the rules are listed.

Note: The ordering of your rules is very important as rules are applied in turn.

**Figure 101** Security > Firewall > Rules

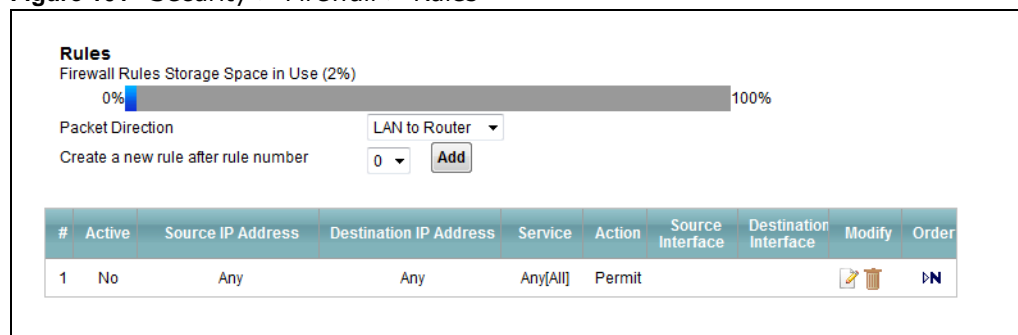

The following table describes the labels in this screen.

**Table 61** Security > Firewall > Rules

LABEL	DESCRIPTION
Firewall Rules Storage Space in Use	This read-only bar shows how much of the Device's memory for recording firewall rules it is currently using. When you are using 80% or less of the storage space, the bar is green. When the amount of space used is over 80%, the bar is red.
Packet Direction	Use the drop-down list box to select a direction of travel of packets for which you want to configure firewall rules.

**Table 61** Security > Firewall > Rules (continued)

LABEL	DESCRIPTION
Create a new rule after rule number	Select an index number and click <b>Add</b> to add a new firewall rule after the selected index number. For example, if you select "6", your new rule becomes number 7 and the previous rule 7 (if there is one) becomes rule 8.
	The following read-only fields summarize the rules you have created that apply to traffic traveling in the selected packet direction. The firewall rules that you configure (summarized below) take priority over the general firewall action settings in the <b>General</b> screen.
#	This is your firewall rule number. The ordering of your rules is important as rules are applied in turn.
Active	This field displays whether a firewall is turned on or not. Select the check box to enable the rule. Clear the check box to disable the rule.
Source IP Address	This column displays the source addresses or ranges of addresses to which this firewall rule applies. Please note that a blank source or destination address is equivalent to <b>Any</b> .
Destination IP Address	This column displays the destination addresses or ranges of addresses to which this firewall rule applies. Please note that a blank source or destination address is equivalent to <b>Any</b> .
Service	This column displays the services to which this firewall rule applies.
Action	This field displays whether the firewall silently discards packets ( <b>Drop</b> ), discards packets and sends a TCP reset packet or an ICMP destination-unreachable message to the sender ( <b>Reject</b> ) or allows the passage of packets ( <b>Permit</b> ).
Source Interface	This column displays the source interface to which this firewall rule applies. This is the interface through which the traffic entered the Device. Please note that a blank source interface is equivalent to <b>Any</b> .
Destination Interface	This column displays the destination interface to which this firewall rule applies. This is the interface through which the traffic is destined to leave the Device. Please note that a blank source interface is equivalent to <b>Any</b> .
Modify	Click the <b>Edit</b> icon to go to the screen where you can edit the rule.  Click the <b>Remove</b> icon to delete an existing firewall rule. A window displays asking you to confirm that you want to delete the firewall rule. Note that subsequent firewall rules move up by one when you take this action.

### 14.4.1 Rules Add Screen

Use this screen to configure firewall rules. In the **Rules** screen, select an index number and click **Add** or click a rule's **Edit** icon to display this screen and refer to the following table for information on the labels.



Figure 102 Security &gt; Firewall &gt; Rules &gt; Add

The following table describes the labels in this screen.

Table 62 Security &gt; Firewall &gt; Rules &gt; Add

LABEL	DESCRIPTION
Active	Select this option to enable this firewall rule.
Action for Matched Packets	Use the drop-down list box to select whether to discard ( <b>Drop</b> ), deny and send an ICMP destination-unreachable message to the sender of ( <b>Reject</b> ) or allow the passage of ( <b>Permit</b> ) packets that match this rule.
IP Version Type	Select the IP version, <b>IPv4</b> or <b>IPv6</b> , to apply this firewall rule to.
Rate Limit	Set a maximum number of packets per second, minute, or hour to limit the throughput of traffic that matches this rule.
Maximum Burst Number	Set the maximum number of packets that can be sent at the peak rate.
Log	This field determines if a log for packets that match the rule is created or not.

**Table 62** Security > Firewall > Rules > Add (continued)

LABEL	DESCRIPTION
Rules/Source Address	
Address Type	Do you want your rule to apply to packets with a particular (single) IP, a range of IP addresses (for instance, 192.168.1.10 to 192.169.1.50), a subnet or any IP address? Select an option from the drop-down list box that includes: <b>Single Address, Range Address, Subnet Address</b> and <b>Any Address</b> .
Start IP Address	Enter the single IP address or the starting IP address in a range here.
End IP Address	Enter the ending IP address in a range here.
Subnet Mask	Enter the subnet mask here, if applicable.
Source Mac Address	Specify a source MAC address of traffic to which to apply this firewall rule applies. Please note that a blank source MAC address is equivalent to any.
Destination Address	
Address Type	Do you want your rule to apply to packets with a particular (single) IP, a range of IP addresses (for instance, 192.168.1.10 to 192.169.1.50), a subnet or any IP address? Select an option from the drop-down list box that includes: <b>Single Address, Range Address, Subnet Address</b> and <b>Any Address</b> .
Start IP Address	Enter the single IP address or the starting IP address in a range here.
End IP Address	Enter the ending IP address in a range here.
Subnet Mask	Enter the subnet mask here, if applicable.
Source Interface	Specify a source interface to which this firewall rule applies. This is the interface through which the traffic entered the Device. Please note that a blank source interface is equivalent to any.
Service	
Available Services	Select a service from the <b>Available Services</b> box.
Edit Customized Services	Click the <b>Edit Customized Service</b> button to bring up the screen that you use to configure a new custom service that is not in the predefined list of services.
TCP Flag	Specify any TCP flag bits the firewall rule is to check for.
Schedule	Select the days and time during which to apply the rule. Select <b>Everyday</b> and <b>All Day</b> to always apply the rule.
OK	Click this to save your changes.
Cancel	Click this to exit this screen without saving.

## 14.4.2 Customized Services

Configure customized services and port numbers not predefined by the Device. For a comprehensive list of port numbers and services, visit the IANA (Internet Assigned Number Authority) website. Click the **Edit Customized Services** button while editing a firewall rule to configure a custom service port. This displays the following screen.

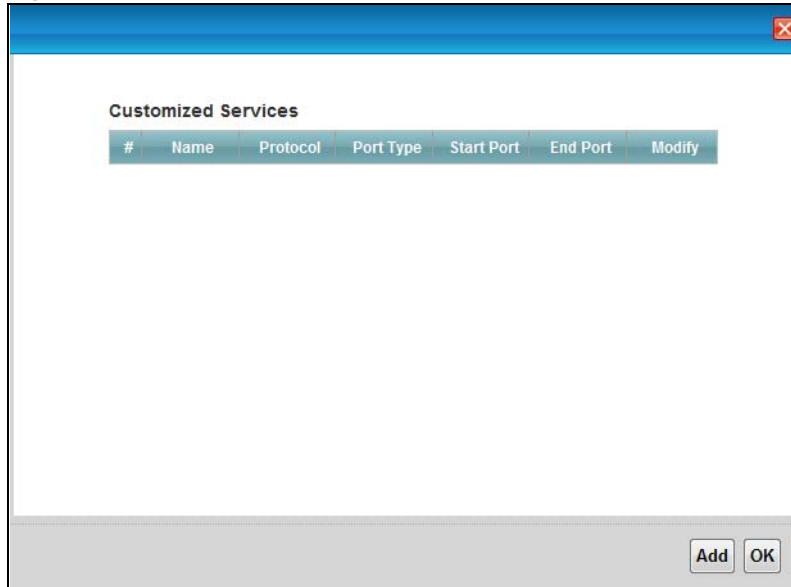
**Figure 103** Security > Firewall > Rules: Edit: Edit Customized Services

The following table describes the labels in this screen.

**Table 63** Security > Firewall > Rules: Edit: Edit Customized Services

LABEL	DESCRIPTION
#	This is the number of your customized port.
Name	This is the name of your customized service.
Protocol	This shows the IP protocol ( <b>TCP</b> or <b>UDP</b> ) that defines your customized service.
Port Type	This is the port number or range that defines your customized service.
Start Port	This is a single port number or the starting port number of a range that defines your customized service.
End Port	This is a single port number or the ending port number of a range that defines your customized service.
Modify	Click this to edit a customized service.
Add	Click this to configure a customized service.
OK	Click this to return to the <b>Firewall Edit Rule</b> screen.

### 14.4.3 Customized Service Add/Edit

Use this screen to add a customized rule or edit an existing rule. Click **Add** or the **Edit** icon next to a rule number in the **Firewall Customized Services** screen to display the following screen.

**Figure 104** Security > Firewall > Rules: Edit: Edit Customized Services: Add/Edit

The following table describes the labels in this screen.

**Table 64** Security > Firewall > Rules: Edit: Edit Customized Services: Add/Edit

LABEL	DESCRIPTION
Config	
Service Name	Type a unique name for your custom port.
Service Type	Choose the IP port ( <b>TCP</b> or <b>UDP</b> ) that defines your customized port from the drop down list box.
Port Configuration	
Type	Click <b>Single</b> to specify one port only or <b>Port Range</b> to specify a span of ports that define your customized service.
Port Number	Type a single port number or the range of port numbers that define your customized service.
Back	Click this to return to the previous screen without saving.
Apply	Click this to save your changes.
Cancel	Click this to exit this screen without saving.

## 14.5 DoS Screen

Use this screen to enable DoS protection. Click **Security > Firewall > Dos** to display the following screen.

**Figure 105** Security > Firewall > Dos

The following table describes the labels in this screen.

**Table 65** Security > Firewall > Dos

LABEL	DESCRIPTION
Denial of Services	Enable this to protect against DoS attacks. The Device will drop sessions that surpass maximum thresholds.
Apply	Click this to save your changes.
Cancel	Click this to restore your previously saved settings.
Advanced	Click this to go to a screen to specify maximum thresholds at which the Device will start dropping sessions.

## 14.5.1 The DoS Advanced Screen

For DoS attacks, the Device uses thresholds to determine when to start dropping sessions that do not become fully established (half-open sessions). These thresholds apply globally to all sessions.

For TCP, half-open means that the session has not reached the established state—the TCP three-way handshake has not yet been completed. Under normal circumstances, the application that initiates a session sends a SYN (synchronize) packet to the receiving server. The receiver sends back an ACK (acknowledgment) packet and its own SYN, and then the initiator responds with an ACK (acknowledgment). After this handshake, a connection is established.

**Figure 106** Three-Way Handshake

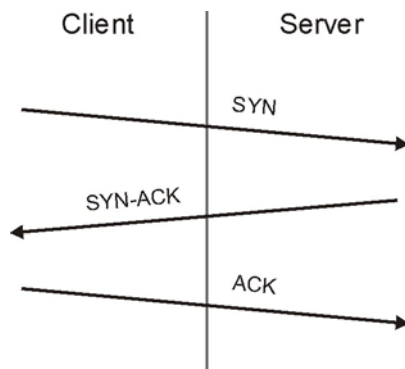

For UDP, half-open means that the firewall has detected no return traffic. An unusually high number (or arrival rate) of half-open sessions could indicate a DOS attack.

### 14.5.1.1 Threshold Values

If everything is working properly, you probably do not need to change the threshold settings as the default threshold values should work for most small offices. Tune these parameters when you believe the Device has been receiving DoS attacks that are not recorded in the logs or the logs show that the Device is classifying normal traffic as DoS attacks. Factors influencing choices for threshold values are:

- 1 The maximum number of opened sessions.
- 2 The minimum capacity of server backlog in your LAN network.
- 3 The CPU power of servers in your LAN network.

- 4 Network bandwidth.
- 5 Type of traffic for certain servers.

Reduce the threshold values if your network is slower than average for any of these factors (especially if you have servers that are slow or handle many tasks and are often busy).

- If you often use P2P applications such as file sharing with eMule or eDonkey, it's recommended that you increase the threshold values since lots of sessions will be established during a small period of time and the Device may classify them as DoS attacks.

## 14.5.2 Configuring Firewall Thresholds

Click **Security > Firewall > DoS > Advanced** to display the following screen.

**Figure 107** Security > Firewall > DoS > Advanced

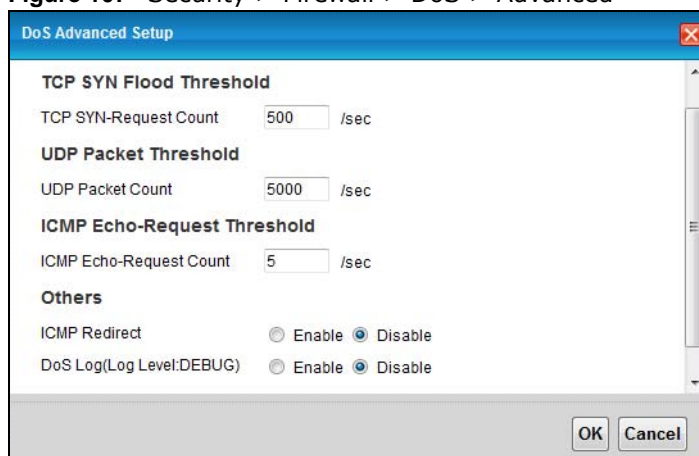

The following table describes the labels in this screen.

**Table 66** Security > Firewall > DoS > Advanced

LABEL	DESCRIPTION
TCP SYN-Request Count	This is the rate of new TCP half-open sessions per second that causes the firewall to start deleting half-open sessions. When the rate of new connection attempts rises above this number, the Device deletes half-open sessions as required to accommodate new connection attempts.
UDP Packet Count	This is the rate of new UDP half-open sessions per second that causes the firewall to start deleting half-open sessions. When the rate of new connection attempts rises above this number, the Device deletes half-open sessions as required to accommodate new connection attempts.
ICMP Echo-Request Count	This is the rate of new ICMP Echo-Request half-open sessions per second that causes the firewall to start deleting half-open sessions. When the rate of new connection attempts rises above this number, the Device deletes half-open sessions as required to accommodate new connection attempts.
ICMP Redirect	Select <b>Enable</b> to monitor for and block ICMP redirect attacks.  An ICMP redirect attack is one where forged ICMP redirect messages can force the client device to route packets for certain connections through an attacker's host.
DoS Log(Log Level: DEBUG)	Select <b>Enable</b> to log DoS attacks. See <a href="#">Section 17.2 on page 168</a> for information on viewing logs.

**Table 66** Security > Firewall > DoS > Advanced (continued)

LABEL	DESCRIPTION
OK	Click this to save your changes.
Cancel	Click this to exit this screen without saving.

## 14.6 Firewall Technical Reference

This section provides some technical background information about the topics covered in this chapter.

### 14.6.1 Firewall Rules Overview

Your customized rules take precedence and override the Device's default settings. The Device checks the source IP address, destination IP address and IP protocol type of network traffic against the firewall rules (in the order you list them). When the traffic matches a rule, the Device takes the action specified in the rule.

Firewall rules are grouped based on the direction of travel of packets to which they apply:

- LAN to Router
- LAN to WAN
- WAN to LAN
- WAN to Router

Note: The LAN includes both the LAN port and the WLAN.

By default, the Device's stateful packet inspection allows packets traveling in the following directions:

- LAN to Router
  - These rules specify which computers on the LAN can manage the Device (remote management).

Note: You can also configure the remote management settings to allow only a specific computer to manage the Device.

- LAN to WAN
  - These rules specify which computers on the LAN can access which computers or services on the WAN.

By default, the Device's stateful packet inspection drops packets traveling in the following directions:

- WAN to LAN
  - These rules specify which computers on the WAN can access which computers or services on the LAN.

Note: You also need to configure NAT port forwarding (or full featured NAT address mapping rules) to allow computers on the WAN to access devices on the LAN.

- WAN to Router

By default the Device stops computers on the WAN from managing the Device. You could configure one of these rules to allow a WAN computer to manage the Device.

**Note:** You also need to configure the remote management settings to allow a WAN computer to manage the Device.

You may define additional rules and sets or modify existing ones but please exercise extreme caution in doing so.

For example, you may create rules to:

- Block certain types of traffic, such as IRC (Internet Relay Chat), from the LAN to the Internet.
- Allow certain types of traffic, such as Lotus Notes database synchronization, from specific hosts on the Internet to specific hosts on the LAN.
- Allow everyone except your competitors to access a web server.
- Restrict use of certain protocols, such as Telnet, to authorized users on the LAN.

These custom rules work by comparing the source IP address, destination IP address and IP protocol type of network traffic to rules set by the administrator. Your customized rules take precedence and override the Device's default rules.

## 14.6.2 Guidelines For Enhancing Security With Your Firewall

- 1 Change the default password via web configurator.
- 2 Think about access control before you connect to the network in any way.
- 3 Limit who can access your router.
- 4 Don't enable any local service (such as telnet or FTP) that you don't use. Any enabled service could present a potential security risk. A determined hacker might be able to find creative ways to misuse the enabled services to access the firewall or the network.
- 5 For local services that are enabled, protect against misuse. Protect by configuring the services to communicate only with specific peers, and protect by configuring rules to block packets for the services at specific interfaces.
- 6 Protect against IP spoofing by making sure the firewall is active.
- 7 Keep the firewall in a secured (locked) room.

## 14.6.3 Security Considerations

**Note:** Incorrectly configuring the firewall may block valid access or introduce security risks to the Device and your protected network. Use caution when creating or deleting firewall rules and test your rules after you configure them.

Consider these security ramifications before creating a rule:



- 1 Does this rule stop LAN users from accessing critical resources on the Internet? For example, if IRC is blocked, are there users that require this service?
- 2 Is it possible to modify the rule to be more specific? For example, if IRC is blocked for all users, will a rule that blocks just certain users be more effective?
- 3 Does a rule that allows Internet users access to resources on the LAN create a security vulnerability? For example, if FTP ports (TCP 20, 21) are allowed from the Internet to the LAN, Internet users may be able to connect to computers with running FTP servers.
- 4 Does this rule conflict with any existing rules?

Once these questions have been answered, adding rules is simply a matter of entering the information into the correct fields in the web configurator screens.

## 14.6.4 Triangle Route

When the firewall is on, your Device acts as a secure gateway between your LAN and the Internet. In an ideal network topology, all incoming and outgoing network traffic passes through the Device to protect your LAN against attacks.

**Figure 108** Ideal Firewall Setup

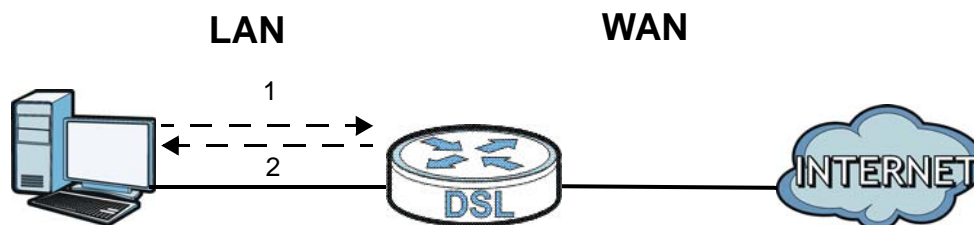

### 14.6.4.1 The “Triangle Route” Problem

A traffic route is a path for sending or receiving data packets between two Ethernet devices. You may have more than one connection to the Internet (through one or more ISPs). If an alternate gateway is on the LAN (and its IP address is in the same subnet as the Device’s LAN IP address), the “triangle route” (also called asymmetrical route) problem may occur. The steps below describe the “triangle route” problem.

- 1 A computer on the LAN initiates a connection by sending out a SYN packet to a receiving server on the WAN.
- 2 The Device reroutes the SYN packet through Gateway **A** on the LAN to the WAN.
- 3 The reply from the WAN goes directly to the computer on the LAN without going through the Device.

As a result, the Device resets the connection, as the connection has not been acknowledged.

Figure 109 “Triangle Route” Problem

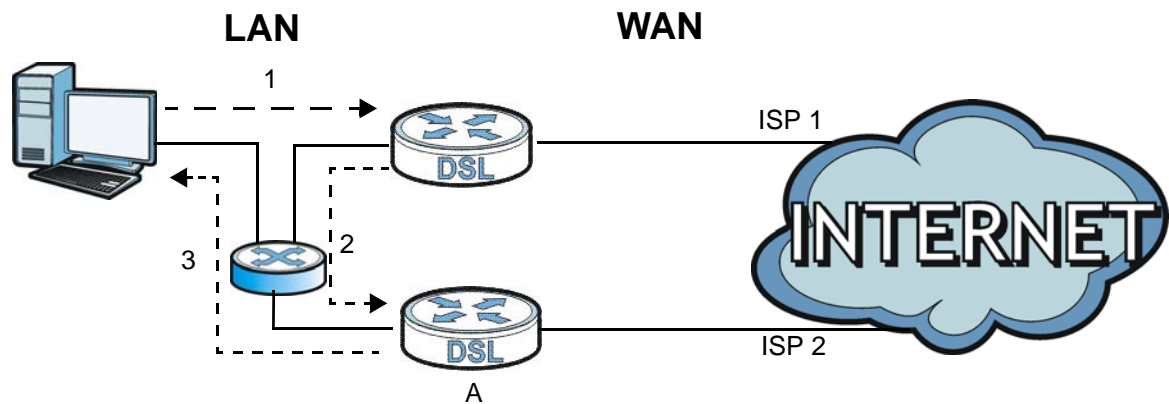

#### 14.6.4.2 Solving the “Triangle Route” Problem

If you have the Device allow triangle route sessions, traffic from the WAN can go directly to a LAN computer without passing through the Device and its firewall protection.

Another solution is to use IP alias. IP alias allows you to partition your network into logical sections over the same Ethernet interface. Your Device supports up to three logical LAN interfaces with the Device being the gateway for each logical network.

It's like having multiple LAN networks that actually use the same physical cables and ports. By putting your LAN and Gateway **A** in different subnets, all returning network traffic must pass through the Device to your LAN. The following steps describe such a scenario.

- 1 A computer on the LAN initiates a connection by sending a SYN packet to a receiving server on the WAN.
- 2 The Device reroutes the packet to Gateway A, which is in Subnet 2.
- 3 The reply from the WAN goes to the Device.
- 4 The Device then sends it to the computer on the LAN in Subnet 1.

Figure 110 IP Alias

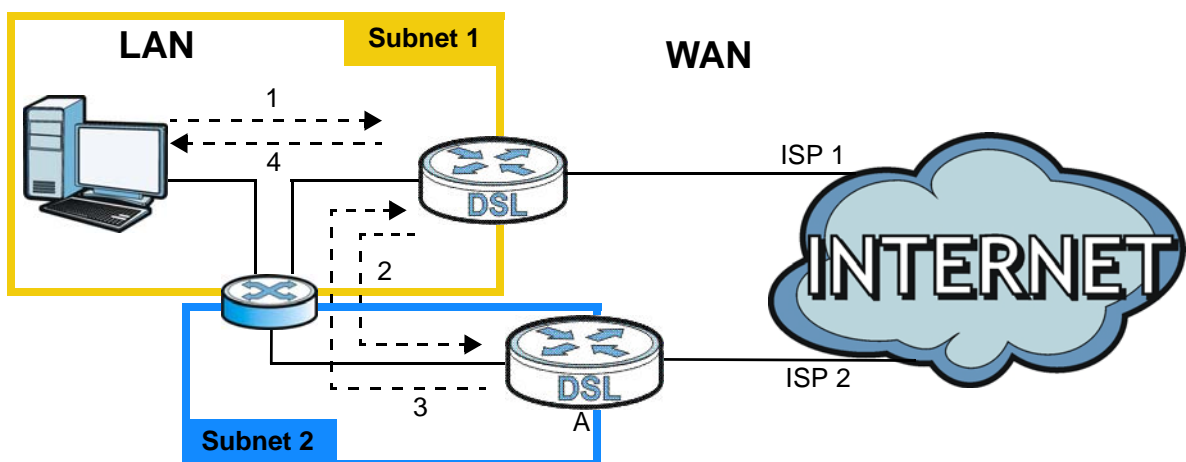

## Parental Control

### 15.1 Overview

Parental control allows you to block web sites with the specific URL. You can also define time periods and days during which the Device performs parental control on a specific user.

### 15.2 The Parental Control Screen

Use this screen to enable parental control, view the parental control rules and schedules.

Click **Security > Parental Control** to open the following screen.

**Figure 111** Security > Parental Control

The screenshot shows the 'Parental Control' settings screen. At the top, there is a 'General' section with a 'Parental Control' toggle set to 'Disable (settings are invalid when disabled)'. Below this is an 'Add new PCP' button. A table lists the current rule:

#	Status	PCP Name	Home Network User	Internet Access Schedule	Network Service	Website Blocked	Modify
1		Night	All	M T W T F S S 22:00-23:59	None	None	

At the bottom right, there are 'Apply' and 'Cancel' buttons.

The following table describes the fields in this screen.

**Table 67** Parental Control > Parental Control

LABEL	DESCRIPTION
Parental Control	Select <b>Enable</b> to activate parental control.
Add new PCP	Click this if you want to configure a new parental control rule.
#	This shows the index number of the rule.
Status	This indicates whether the rule is active or not. A yellow bulb signifies that this rule is active. A gray bulb signifies that this rule is not active.
PCP Name	This shows the name of the rule.
Home Network User	This shows the MAC address of the LAN user's computer to which this rule applies.
Internet Access Schedule	This shows the days and time on which parental control is enabled.
Network Service	This shows whether the network service is configured. If not, <b>None</b> will be shown.

**Table 67** Parental Control > Parental Control (continued)

LABEL	DESCRIPTION
Website Blocked	This shows whether the website block is configured. If not, <b>None</b> will be shown.
Modify	Click the <b>Edit</b> icon to go to the screen where you can edit the rule. Click the <b>Delete</b> icon to delete an existing rule.
Add	Click <b>Add</b> to create a new schedule.
Apply	Click <b>Apply</b> to save your changes back to the Device.
Cancel	Click <b>Cancel</b> to return your last saved settings.

## 15.2.1 Add/Edit a Parental Control Rule

Click **Add new PCP** in the **Parental Control** screen to add a new rule or click the **Edit** icon next to an existing rule to edit it. Use this screen to configure a restricted access schedule and/or URL filtering settings to block the users on your network from accessing certain web sites.

**Figure 112** Add/Edit Parental Control Rule

**Add new PCP**

**General**

Active

Parental Control Profile Name :

Home Network User :

**Internet Access Schedule**

Day :  Everyday  Monday  Tuesday  Wednesday  
 Thursday  Friday  Saturday  Sunday

**Time of Day to Apply:(24-Hour Format)**

Time (Start - End) **00:00-24:00**

00:00  24:00

No access  Authorized access

**Network Service**

Network Service Setting :  selected service(s)

Active	Service Name	Protocol	Port	Modify
<input type="checkbox"/>	UserDefined	TCP	<input type="text"/>	<input type="button" value="Delete"/>

**Note :**

In "Port" column, the format of "Multi-port" should be like: 3091,4091 (the max port number you can put is 15), the format of "Range-port" should be like: 5091:6892.

**Blocked Site/URL**

Site/URL :

Site/URL :

Site/URL :

Site/URL :

Site/URL :

The following table describes the fields in this screen.

**Table 68** Add/Edit Parental Control Rule

LABEL	DESCRIPTION
General	
Active	Select the checkbox to activate this parental control rule.
Parental Control Profile Name	Enter a descriptive name for the rule.
Home Network User	Select the LAN user that you want to apply this rule to from the drop-down list box. If you select <b>Custom</b> , enter the LAN user's MAC address. If you select <b>All</b> , the rule applies to all LAN users.
Internet Access Schedule	
Day	Select check boxes for the days that you want the Device to perform parental control.
Time of Day to Apply: (24-Hour Format)	
Start Time End Time	Enter the time period of each day, in 24-hour format, during which parental control will be enforced.
Time	Drag the time bar to define the time that the LAN user is allowed access.
Network Service	
Network Service Setting	If you select <b>Block</b> , the Device prohibits the users from viewing the Web sites with the URLs listed below.  If you select <b>Access</b> , the Device blocks access to all URLs except ones listed below.
Add new service	Click this to show a screen in which you can add a new service rule. You can configure the <b>Service Name</b> , <b>Protocol</b> , and <b>Name</b> of the new rule.
Active	Select the check box next to the service to apply this rule to the service. Clear the check box to not apply this rule to it.
Service Name	Select a service.
Protocol	For services that support multiple protocols, select the protocol.
Port	Specify the port number from 1 to 65535.
Modify	Click the <b>Edit</b> icon to go to the screen where you can edit the rule.  Click the <b>Delete</b> icon to delete an existing rule.
Blocked Site/URL	Specify web sites or URLs to which the Device blocks access.
Apply	Click this button to save your settings back to the Device.
Cancel	Click this to exit this screen without saving.



# Certificates

## 16.1 Overview

The Device can use certificates (also called digital IDs) to authenticate users. Certificates are based on public-private key pairs. A certificate contains the certificate owner's identity and public key. Certificates provide a way to exchange public keys for use in authentication.

### 16.1.1 What You Can Do in this Chapter

- Use the **Local Certificates** screen to view and import the Device's CA-signed certificates ([Section 16.2 on page 161](#)).
- Use the **Trusted CA** screen to save the certificates of trusted CAs to the Device. You can also export the certificates to a computer ([Section 16.3 on page 163](#)).

### 16.1.2 What You Need to Know

The following terms and concepts may help as you read this chapter.

#### Certification Authorities

A Certification Authority (CA) issues certificates and guarantees the identity of each certificate owner. There are commercial certification authorities like CyberTrust or VeriSign and government certification authorities.

#### Public and Private Keys

When using public-key cryptology for authentication, each host has two keys. One key is public and can be made openly available; the other key is private and must be kept secure. Public-key encryption in general works as follows.

- 1 Tim wants to send a private message to Jenny. Tim generates a public-private key pair. What is encrypted with one key can only be decrypted using the other.
- 2 Tim keeps the private key and makes the public key openly available.
- 3 Tim uses his private key to encrypt the message and sends it to Jenny.
- 4 Jenny receives the message and uses Tim's public key to decrypt it.
- 5 Additionally, Jenny uses her own private key to encrypt a message and Tim uses Jenny's public key to decrypt the message.

The Device uses certificates based on public-key cryptology to authenticate users attempting to establish a connection. The method used to secure the data that you send through an established connection depends on the type of connection. For example, a VPN tunnel might use the triple DES encryption algorithm.

The certification authority uses its private key to sign certificates. Anyone can then use the certification authority's public key to verify the certificates.

### **Certification Path**

A certification path is the hierarchy of certification authority certificates that validate a certificate. The Device does not trust a certificate if any certificate on its path has expired or been revoked.

### **Certificate Directory Servers**

Certification authorities maintain directory servers with databases of valid and revoked certificates. A directory of certificates that have been revoked before the scheduled expiration is called a CRL (Certificate Revocation List). The Device can check a peer's certificate against a directory server's list of revoked certificates. The framework of servers, software, procedures and policies that handles keys is called PKI (public-key infrastructure).

### **Advantages of Certificates**

Certificates offer the following benefits.

- The Device only has to store the certificates of the certification authorities that you decide to trust, no matter how many devices you need to authenticate.
- Key distribution is simple and very secure since you can freely distribute public keys and you never need to transmit private keys.

### **Certificate File Format**

The certification authority certificate that you want to import has to be in PEM (Base-64) encoded X.509 file format. This Privacy Enhanced Mail format uses 64 ASCII characters to convert a binary X.509 certificate into a printable form.

## **16.1.3 Verifying a Certificate**

Before you import a trusted CA or trusted remote host certificate into the Device, you should verify that you have the actual certificate. This is especially true of trusted CA certificates since the Device also trusts any valid certificate signed by any of the imported trusted CA certificates.

You can use a certificate's fingerprint to verify it. A certificate's fingerprint is a message digest calculated using the MD5 or SHA1 algorithms. The following procedure describes how to check a certificate's fingerprint to verify that you have the actual certificate.

- 1 Browse to where you have the certificate saved on your computer.
- 2 Make sure that the certificate has a ".cer" or ".crt" file name extension.

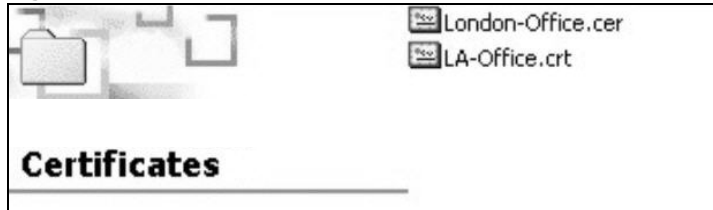

**Figure 113** Certificates on Your Computer

- 3 Double-click the certificate's icon to open the **Certificate** window. Click the **Details** tab and scroll down to the **Thumbprint Algorithm** and **Thumbprint** fields.

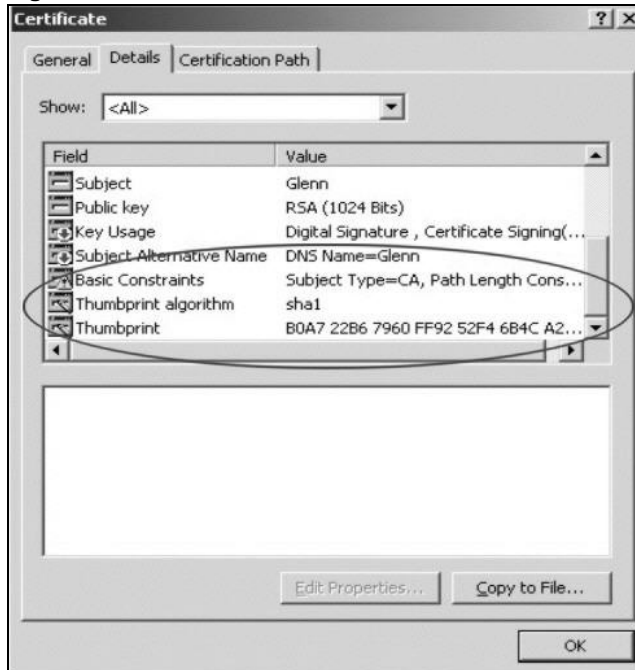
**Figure 114** Certificate Details

- 4 Use a secure method to verify that the certificate owner has the same information in the **Thumbprint Algorithm** and **Thumbprint** fields. The secure method may very based on your situation. Possible examples would be over the telephone or through an HTTPS connection.

## 16.2 Local Certificates

Use this screen to view the Device's summary list of certificates and certification requests. You can import the following certificates to your Device:

- Web Server - This certificate secures HTTP connections.
- SIP TLS - This certificate secures VoIP connections.
- SSH/SCP/SFTP - This certificate secures remote connections.

Click **Security** > **Certificates** to open the **Local Certificates** screen.

**Figure 115** Security > Certificates > Local Certificates

Replace PrivateKey/Certificate file in PEM format

WebServer

Current File	Subject	Issuer	Valid From	Valid To	Cert
httpsCert.pem	C=CN/ST=TAIWAN/L=XINZHUI/O=ZyXEL/OU=DSL Unit/CN=ZyXEL	C=CN/ST=TAIWAN/L=XINZHUI/O=ZyXEL/OU=DSL Unit/CN=ZyXEL	2012-03-27 09:31:36 GMT	2022-03-25 09:31:36 GMT	↕

SSH

Current File	Key Type
ssh.rsa	RSA

**Note:**  
SSH -- Maximum key length supported is up to 4096 bits (default is 2048 bits), and the initialization time is proportional to key length. You need to adjust your application timeout settings to adapt this variation.

The following table describes the labels in this screen.

**Table 69** Security > Certificates > Local Certificates

LABEL	DESCRIPTION
WebServer	Click <b>Browse...</b> to find the certificate file you want to upload.
Current File	This field displays the name used to identify this certificate. It is recommended that you give each certificate a unique name.
Subject	This field displays identifying information about the certificate's owner, such as <b>CN</b> (Common Name), <b>OU</b> (Organizational Unit or department), <b>O</b> (Organization or company) and <b>C</b> (Country). It is recommended that each certificate have unique subject information.
Issuer	This field displays identifying information about the certificate's issuing certification authority, such as a common name, organizational unit or department, organization or company and country.
Valid From	This field displays the date that the certificate becomes applicable. The text displays in red and includes a <b>Not Yet Valid!</b> message if the certificate has not yet become applicable.
Valid To	This field displays the date that the certificate expires. The text displays in red and includes an <b>Expiring!</b> or <b>Expired!</b> message if the certificate is about to expire or has already expired.
Cert	Click this button and then <b>Save</b> in the <b>File Download</b> screen. The <b>Save As</b> screen opens, browse to the location that you want to use and click <b>Save</b> .
SSH/SCP/SFTP	Type in the location of the <b>SSH /SCP/SFTP</b> certificate file you want to upload in this field or click <b>Browse</b> to find it.
Choose file	Click this link to find the certificate file you want to upload.
Current File	This field displays the name used to identify this certificate. It is recommended that you give each certificate a unique name.
Key Type	This field applies to the <b>SSH/SCP/SFTP</b> certificate. This shows the file format of the current certificate.
Replace	Click this to replace the certificates and save your changes back to the Device.
Reset	Click this to clear your settings.

## 16.3 Trusted CA

Use this screen to view a summary list of certificates of the certification authorities that you have set the Device to accept as trusted. The Device accepts any valid certificate signed by a certification authority on this list as being trustworthy; thus you do not need to import any certificate that is signed by one of these certification authorities.

Click **Security > Certificates > Trusted CA** to open the **Trusted CA** screen.

**Figure 116** Security > Certificates > Trusted CA

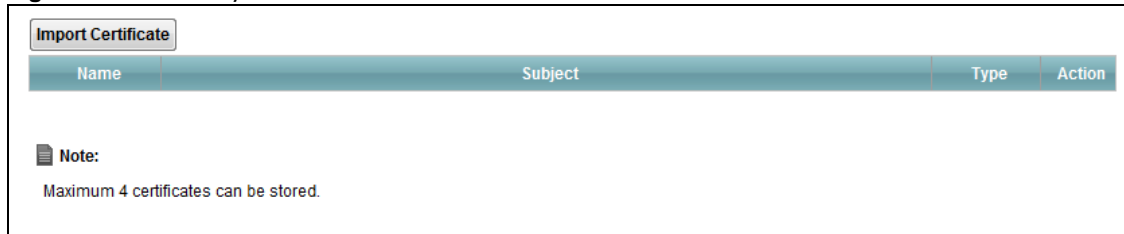

The following table describes the labels in this screen.

**Table 70** Security > Certificates > Trusted CA

LABEL	DESCRIPTION
Import Certificate	Click this button to open a screen where you can save the certificate of a certification authority that you trust to the Device.
Name	This field displays the name used to identify this certificate.
Subject	This field displays information that identifies the owner of the certificate, such as Common Name (CN), OU (Organizational Unit or department), Organization (O), State (ST) and Country (C). It is recommended that each certificate have unique subject information.
Type	This field displays general information about the certificate. <b>ca</b> means that a Certification Authority signed the certificate.
Action	Click the <b>View</b> icon to open a screen with an in-depth list of information about the certificate (or certification request).  Click the <b>Delete</b> icon to delete the certificate (or certification request). You cannot delete a certificate that one or more features is configured to use.

## 16.4 Trusted CA Import

Click **Import Certificate** in the **Trusted CA** screen to open the **Import Certificate** screen. You can save a trusted certification authority's certificate to the Device.

**Note:** You must remove any spaces from the certificate's filename before you can import the certificate.

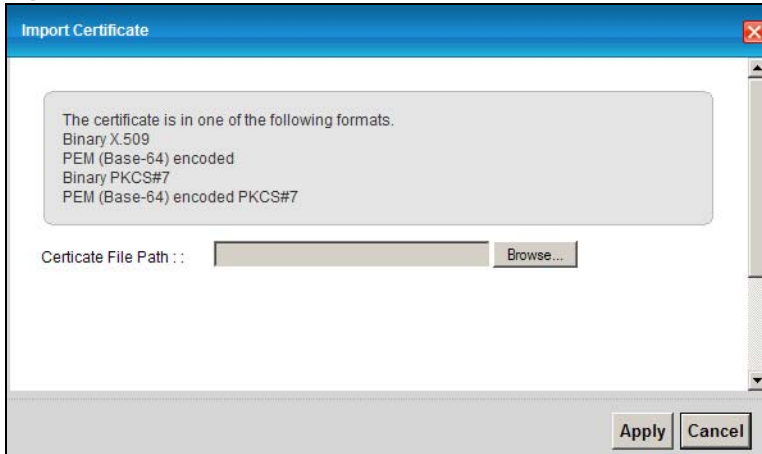
**Figure 117** Trusted CA > Import

The following table describes the labels in this screen.

**Table 71** Security > Certificates > Trusted CA > Import

LABEL	DESCRIPTION
Certificate File Path	Type in the location of the file you want to upload in this field or click <b>Browse</b> to find it.
Browse	Click <b>Browse</b> to find the certificate file you want to upload.
Apply	Click this to save the certificate on the Device.
Cancel	Click this to exit this screen without saving.

## 16.5 View Certificate

Use this screen to view in-depth information about the certification authority's certificate, change the certificate's name and set whether or not you want the Device to check a certification authority's list of revoked certificates before trusting a certificate issued by the certification authority.

Click **Security > Certificates > Trusted CA** to open the **Trusted CA** screen. Click the **View** icon to open the **View Certificate** screen.

**Figure 118** Trusted CA: View

The following table describes the labels in this screen.

**Table 72** Trusted CA: View

LABEL	DESCRIPTION
Certificate Name	This field displays the identifying name of this certificate. If you want to change the name, type up to 31 characters to identify this key certificate. You may use any character (not including spaces).
Certificate Detail	This read-only text box displays the certificate or certification request in Privacy Enhanced Mail (PEM) format. PEM uses 64 ASCII characters to convert the binary certificate into a printable form.  You can copy and paste the certificate into an e-mail to send to friends or colleagues or you can copy and paste the certificate into a text editor and save the file on a management computer for later distribution (via floppy disk for example).
Back	Click this to return to the previous screen.



# System Monitor

## 17.1 Overview

Use the **Traffic Status** screens to view status and log information.

### 17.1.1 What You Can Do in this Chapter

- Use the **Log** screen to see the system logs for the categories that you select ([Section 17.2 on page 168](#)).
- Use the **WAN Traffic Status** screen to view the WAN traffic statistics ([Section 17.3 on page 169](#)).
- Use the **LAN Traffic Status** screen to view the LAN traffic statistics ([Section 17.4 on page 169](#)).
- Use the **NAT Traffic Status** screen to view the NAT status of the Device's clients ([Section 17.5 on page 170](#)).

### 17.1.2 What You Need To Know

The following terms and concepts may help as you read this chapter.

#### Alerts and Logs

An alert is a type of log that warrants more serious attention. They include system errors, attacks (access control) and attempted access to blocked web sites. Some categories such as **System Errors** consist of both logs and alerts. You may differentiate them by their color in the **View Log** screen. Alerts display in red and logs display in black.

#### Syslog Overview

The syslog protocol allows devices to send event notification messages across an IP network to syslog servers that collect the event messages. A syslog-enabled device can generate a syslog message and send it to a syslog server.

Syslog is defined in RFC 3164. The RFC defines the packet format, content and system log related information of syslog messages. Each syslog message has a facility and severity level. The syslog facility identifies a file in the syslog server. Refer to the documentation of your syslog program for details. The following table describes the syslog severity levels.

**Table 73** Syslog Severity Levels

CODE	SEVERITY
0	Emergency: The system is unusable.
1	Alert: Action must be taken immediately.
2	Critical: The system condition is critical.

**Table 73** Syslog Severity Levels (continued)

CODE	SEVERITY
3	Error: There is an error condition on the system.
4	Warning: There is a warning condition on the system.
5	Notice: There is a normal but significant condition on the system.
6	Informational: The syslog contains an informational message.
7	Debug: The message is intended for debug-level purposes.

## 17.2 The Log Screen

Click **System Monitor > Log** to open the **Log** screen. Use the **Log** screen to see the system logs for the categories that you select in the upper left drop-down list box.

**Figure 119** System Monitor > Log

#	Time	Level	Message
1	Apr 28 13:45:25	INFO	received REQUEST
2	Apr 28 13:45:25	INFO	sending NAK
3	Apr 28 13:45:29	INFO	received REQUEST
4	Apr 28 13:45:29	INFO	sending NAK
5	Apr 28 13:45:29	INFO	received DISCOVER
6	Apr 28 13:45:31	INFO	DHCP client connect,IP:192.168.1.33
7	Apr 28 13:45:31	INFO	sending OFFER of 192.168.1.33
8	Apr 28 13:45:31	INFO	received REQUEST
9	Apr 28 13:45:31	INFO	server_id = c0a80101
10	Apr 28 13:45:31	INFO	sending ACK to 192.168.1.33
11	Apr 28 13:45:31	INFO	DHCP client connect,IP:192.168.1.33
12	Apr 28 13:45:34	INFO	received INFORM

The following table describes the fields in this screen.

**Table 74** System Monitor > Log

LABEL	DESCRIPTION
Level	Select a severity level from the drop-down list box. This filters search results according to the severity level you have selected. When you select a severity, the Device searches through all logs of that severity or higher.
Refresh	Click this to renew the log screen.
Clear Logs	Click this to delete all the logs.
Export	Click this to save a copy of the logs to your computer.
Email Log Now	Click this to have the Device send the log to the email server you configured in the <b>Log Setting</b> screen.
#	This field is a sequential value and is not associated with a specific entry.
Time	This field displays the time the log was recorded.
Level	This field displays the severity level of the logs that the device is to send to this syslog server.
Messages	This field states the reason for the log.



## 17.3 The WAN Traffic Status Screen

Click **System Monitor > Traffic Status** to open the **WAN Traffic Status** screen. You can view the WAN traffic statistics in this screen.

**Figure 120** System Monitor > Traffic Status > WAN

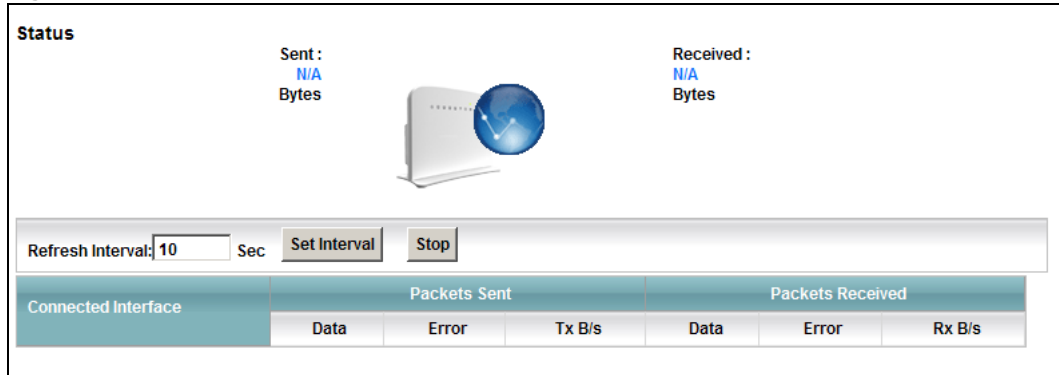

The following table describes the fields in this screen.

**Table 75** System Monitor > Traffic Status > WAN

LABEL	DESCRIPTION
Status	This shows the number of bytes sent and received through the WAN interface of the Device.
Refresh Interval	Specify how often you want the Device to update this screen and click <b>Set Interval</b> to apply the change. Click <b>Stop</b> to halt updating of the screen.
Connected Interface	This shows the name of the WAN interface that is currently connected.
Packets Sent	
Data	This indicates the number of transmitted packets on this interface.
Error	This indicates the number of frames with errors transmitted on this interface.
Drop	This indicates the number of outgoing packets dropped on this interface.
Packets Received	
Data	This indicates the number of received packets on this interface.
Error	This indicates the number of frames with errors received on this interface.
Drop	This indicates the number of received packets dropped on this interface.

## 17.4 The LAN Traffic Status Screen

Click **System Monitor > Traffic Status > LAN** to open the following screen. You can view the LAN traffic statistics in this screen.

**Figure 121** System Monitor > Traffic Status > LAN

Refresh Interval: <input type="text" value="10"/> Sec <input type="button" value="Set Interval"/> <input type="button" value="Stop"/>						
Interface	LAN1	LAN2	LAN3	LAN4	Wireless	
Bytes Sent	112977148	106177910	140815158	107510202	0	
Bytes Received	907231	170423	3491093	234823	1162517121	
Interface	LAN1	LAN2	LAN3	LAN4	Wireless	
Sent (Packet)	Data	370891	362143	406576	363196	3465339
	Error	0	0	0	0	0
	Drop	0	0	0	0	0
Received (Packet)	Data	10106	1844	39651	2351	95386671
	Error	0	0	0	0	0
	Drop	0	0	0	0	0

The following table describes the fields in this screen.

**Table 76** System Monitor > Traffic Status > LAN

LABEL	DESCRIPTION
Refresh Interval	Specify how often you want the Device to update this screen and click <b>Set Interval</b> to apply the change. Click <b>Stop</b> to halt updating of the screen.
Interface	This shows the LAN or WLAN interface.
Bytes Sent	This indicates the number of bytes transmitted on this interface.
Bytes Received	This indicates the number of bytes received on this interface.
Interface	This shows the LAN or WLAN interface.
Sent (Packet)	
Data	This indicates the number of transmitted packets on this interface.
Error	This indicates the number of frames with errors transmitted on this interface.
Drop	This indicates the number of outgoing packets dropped on this interface.
Received (Packet)	
Data	This indicates the number of received packets on this interface.
Error	This indicates the number of frames with errors received on this interface.
Drop	This indicates the number of received packets dropped on this interface.

## 17.5 The NAT Traffic Status Screen

Click **System Monitor > Traffic Status > NAT** to open the following screen. You can view the NAT status of the Device’s clients in this screen.

**Figure 122** System Monitor > Traffic Status > NAT

Refresh Interval: <input type="text" value="10"/> Sec <input type="button" value="Set Interval"/> <input type="button" value="Stop"/>			
Device Name	IP Address	MAC Address	No. of Open Session
twpc11477-03	192.168.1.33	00:21:85:0C:44:1A	59
			<b>Total : 59</b>

The following table describes the fields in this screen.

**Table 77** System Monitor > Traffic Status > NAT

LABEL	DESCRIPTION
Refresh Interval	Specify how often you want the Device to update this screen and click <b>Set Interval</b> to apply the change. Click <b>Stop</b> to halt updating of the screen.
Device Name	This shows the name of the client.
IP Address	This shows the IP address of the client.
MAC Address	This shows the MAC address of the client.
No. of Open Session	This shows the number of NAT sessions used by the client.
Total	This shows the total number of NAT sessions currently open on the Device.



# User Account

## 18.1 Overview

You can configure the system password in the **User Account** screen.

## 18.2 The User Account Screen

Use the **User Account** screen to configure system password.

Click **Maintenance > User Account** to open the following screen.

**Figure 123** Maintenance > User Account

The screenshot shows a web form for configuring the user account. It contains the following elements:

- User Name :** A text input field containing the value "admin".
- Old Password :** An empty text input field.
- New Password :** An empty text input field.
- Retype to Confirm :** An empty text input field.
- Buttons:** Two buttons labeled "Apply" and "Cancel" are located at the bottom right of the form.

The following table describes the labels in this screen.

**Table 78** Maintenance > User Account

LABEL	DESCRIPTION
User Name	You can configure the password for the admin account.
Old Password	Type the default password or the existing password you use to access the system in this field.
New Password	Type your new system password (up to 30 characters). Note that as you type a password, the screen displays a (*) for each character you type. After you change the password, use the new password to access the Device.
Retype to Confirm	Type the new password again for confirmation.
Apply	Click <b>Apply</b> to save your changes.
Cancel	Click <b>Cancel</b> to restore your previously saved settings.



## TR-069 Client

### 19.1 Overview

This chapter explains how to configure the Device's TR-069 auto-configuration settings.

### 19.2 The TR-069 Client Screen

TR-069 defines how Customer Premise Equipment (CPE), for example your Device, can be managed over the WAN by an Auto Configuration Server (ACS). TR-069 is based on sending Remote Procedure Calls (RPCs) between an ACS and a client device. RPCs are sent in Extensible Markup Language (XML) format over HTTP or HTTPS.

An administrator can use an ACS to remotely set up the Device, modify settings, perform firmware upgrades as well as monitor and diagnose the Device. You have to enable the device to be managed by the ACS and specify the ACS IP address or domain name and username and password.

Click **Maintenance > TR-069 Client** to open the following screen. Use this screen to configure your Device to be managed by an ACS.

**Figure 124** Maintenance > TR-069 Client

CWMP	<input checked="" type="radio"/> Enable <input type="radio"/> Disable
ACS URL:	<input type="text"/>
ACS User Name:	<input type="text" value="admin"/>
ACS Password:	<input type="text" value="admin"/>
Connection Request Path:	<input type="text" value="/tr69"/>
Connection Request Port:	<input type="text" value="7547"/>
Connection Request User Name:	<input type="text" value="admin"/>
Connection Request Password:	<input type="text" value="admin"/>
Inform	<input checked="" type="radio"/> Enable <input type="radio"/> Disable
Inform Interval:	<input type="text" value="300"/> Sec
<input type="button" value="Apply"/> <input type="button" value="Cancel"/>	

The following table describes the fields in this screen.

**Table 79** Maintenance > TR-069 Client

LABEL	DESCRIPTION
CWMP	Select <b>Enable</b> to allow the Device to be managed by a management server. Otherwise, select <b>Disable</b> to not allow the Device to be managed by a management server.
ACS URL	Enter the URL or IP address of the auto-configuration server.
ACS User Name	Enter the TR-069 user name for authentication with the auto-configuration server.
ACS Password	Enter the TR-069 password for authentication with the auto-configuration server.
Connection Request Path	Type the IP address or domain name of the Device. The management server uses this path to verify the Device.
Connection Request Port	The default port for access to the Device from the management server is the HTTP port, port 80. If you change it, make sure it does not conflict with another port on your network and it is recommended to use a port number above 1024 (not a commonly used port). The management server should use this port to connect to the Device. You may need to alter your NAT port forwarding rules if they were already configured.
Connection Request User Name	Enter the connection request user name.  When the ACS makes a connection request to the Device, this user name is used to authenticate the ACS.
Connection Request Password	Enter the connection request password.  When the ACS makes a connection request to the Device, this password is used to authenticate the ACS.
Inform	Select <b>Enable</b> for the Device to send periodic inform via TR-069 on the WAN. Otherwise, select <b>Disable</b> .
Inform Interval	Enter the time interval (in seconds) at which the Device sends information to the auto-configuration server.
Apply	Click <b>Apply</b> to save your changes.
Cancel	Click <b>Cancel</b> to restore the screen's last saved settings.



## 20.1 Overview

You can configure system settings, including the host name, domain name and the inactivity time-out interval in the **System** screen.

## 20.2 The System Screen

Use the **System** screen to configure the system's inactivity time-out interval.

Click **Maintenance > System** to open the following screen.

**Figure 125** Maintenance > System

The screenshot shows a configuration screen for the Administrator Inactivity Timer. It features a text input field containing the number '300', followed by the text '(seconds, 0 means no timeout)'. Below the input field are two buttons: 'Apply' and 'Cancel'.

The following table describes the labels in this screen.

**Table 80** Maintenance > System

LABEL	DESCRIPTION
Administrator Inactivity Timer	Type how many minutes a management session (either via the web configurator) can be left idle before the session times out. The default is 5 minutes. After it times out you have to log in with your password again. Very long idle timeouts may have security risks. A value of "0" means a management session never times out, no matter how long it has been left idle (not recommended).
Apply	Click this to save your changes back to the Device.
Cancel	Click this to begin configuring this screen afresh.



# Time Setting

## 21.1 Overview

You can configure the system's time and date in the **Time Setting** screen.

## 21.2 The Time Setting Screen

To change your Device's time and date, click **Maintenance > Time**. The screen appears as shown. Use this screen to configure the Device's time based on your local time zone.

**Figure 126** Maintenance > Time Setting

The screenshot shows the 'Time Setting' screen with the following sections:

- Current Date/Time:** Current Time: 28 Apr 2014 13:45:21
- Time and Date Setup:**
  - Manual
    - Current Date/Time: 13 : 45 : 00
    - Current Time: 2014 / 4 / 28
  - Get from Time Server
    - Time Server Address 1: ntp1.cs.wisc.edu
    - Time Server Address 2: 0.0.0.0
- Time Zone Setup:**
  - Time Zone: (GMT) Greenwich Mean Time : Dublin, Edinburgh, Lisbon, London
  - Daylight Savings
    - Start Date: First of January at [ ] o'clock
    - End Date: First of January at [ ] o'clock

Buttons: Apply, Cancel

The following table describes the fields in this screen.

**Table 81** Maintenance > System > Time Setting

LABEL	DESCRIPTION
Current Date/Time	
Current Time	This field displays the time of your Device.
Current Date	This field displays the date of your Device.
Time and Date Setup	
Manual	Select this to enter the time and date manually in hh:mm:ss and yyyy/mm/dd format.

**Table 81** Maintenance > System > Time Setting (continued)

LABEL	DESCRIPTION
Get from Time Server	Select this to have the Device get the time automatically from a time server.
Time Server Address 1, 2	Enter the IP address or URL (up to 31 extended ASCII characters in length) of your time server. Check with your ISP/network administrator if you are unsure of this information.
Time Zone	Choose the time zone of your location. This will set the time difference between your time zone and Greenwich Mean Time (GMT).
Daylight Savings	Daylight saving is a period from late spring to early fall when many countries set their clocks ahead of normal local time by one hour to give more daytime light in the evening. Select this option if you use Daylight Saving Time.
Start Date	<p>Configure the day and time when Daylight Saving Time starts if you selected <b>Daylight Savings</b>. The <b>o'clock</b> field uses the 24 hour format. Here are a couple of examples:</p> <p>Daylight Saving Time starts in most parts of the United States on the second Sunday of March. Each time zone in the United States starts using Daylight Saving Time at 2 A.M. local time. So in the United States you would select <b>Second, Sunday, March</b> and type <b>2</b> in the <b>o'clock</b> field.</p> <p>Daylight Saving Time starts in the European Union on the last Sunday of March. All of the time zones in the European Union start using Daylight Saving Time at the same moment (1 A.M. GMT or UTC). So in the European Union you would select <b>Last, Sunday, March</b>. The time you type in the <b>o'clock</b> field depends on your time zone. In Germany for instance, you would type <b>2</b> because Germany's time zone is one hour ahead of GMT or UTC (GMT+1).</p>
End Date	<p>Configure the day and time when Daylight Saving Time ends if you selected <b>Daylight Savings</b>. The <b>o'clock</b> field uses the 24 hour format. Here are a couple of examples:</p> <p>Daylight Saving Time ends in the United States on the first Sunday of November. Each time zone in the United States stops using Daylight Saving Time at 2 A.M. local time. So in the United States you would select <b>First, Sunday, November</b> and type <b>2</b> in the <b>o'clock</b> field.</p> <p>Daylight Saving Time ends in the European Union on the last Sunday of October. All of the time zones in the European Union stop using Daylight Saving Time at the same moment (1 A.M. GMT or UTC). So in the European Union you would select <b>Last, Sunday, October</b>. The time you type in the <b>o'clock</b> field depends on your time zone. In Germany for instance, you would type <b>2</b> because Germany's time zone is one hour ahead of GMT or UTC (GMT+1).</p>
Apply	Click <b>Apply</b> to save your changes.
Cancel	Click <b>Cancel</b> to restore the screen's last saved settings.

# Log Setting

## 22.1 Overview

You can configure where the Device sends logs and which logs and/or immediate alerts the Device records in the **Log Setting** screen.

## 22.2 The Log Setting Screen

To change your Device's log settings, click **Maintenance > Log Setting**. The screen appears as shown.

**Figure 127** Maintenance > Log Setting

**Syslog Settings**

Syslog Logging  Active

Mode Local File

Syslog Server IP Address

Syslog Server UDP Port 514

**Email Log Settings**

SMTP Authentication

Mail Server  (Outgoing SMTP Server Name or IP Address)

Mail Subject

From  (E-Mail Address)

To  (E-Mail Address)

User Name

Password

Log Schedule None

Day For Sending Log Sunday

Time for Sending Log 0 (hour) 0 (minute)

Clear log after sending mail

**Email Alarm Log Settings**

Send Alarm to  (E-Mail Address)

Alarm Interval  (Second0~3600)

**Active Log and Select Level**

Log Category	Log Level
<input checked="" type="checkbox"/> WAN-DHCP	<span style="border: 1px solid black; padding: 2px;">ALL</span>
<input checked="" type="checkbox"/> xDSL	<span style="border: 1px solid black; padding: 2px;">ALL</span>
<input checked="" type="checkbox"/> PPP	<span style="border: 1px solid black; padding: 2px;">ALL</span>
<input checked="" type="checkbox"/> System Maintenance	<span style="border: 1px solid black; padding: 2px;">ALL</span>
<input checked="" type="checkbox"/> Remote Management	<span style="border: 1px solid black; padding: 2px;">ALL</span>
<input checked="" type="checkbox"/> TR069	<span style="border: 1px solid black; padding: 2px;">ALL</span>
<input checked="" type="checkbox"/> NTP	<span style="border: 1px solid black; padding: 2px;">ALL</span>
<input checked="" type="checkbox"/> DDNS	<span style="border: 1px solid black; padding: 2px;">ALL</span>
<input checked="" type="checkbox"/> NAT	<span style="border: 1px solid black; padding: 2px;">ALL</span>
<input checked="" type="checkbox"/> Firewall	<span style="border: 1px solid black; padding: 2px;">ALL</span>
<input checked="" type="checkbox"/> DHCP-Server	<span style="border: 1px solid black; padding: 2px;">ALL</span>
<input checked="" type="checkbox"/> WLAN	<span style="border: 1px solid black; padding: 2px;">ALL</span>
<input checked="" type="checkbox"/> Internet	<span style="border: 1px solid black; padding: 2px;">ALL</span>
<input checked="" type="checkbox"/> UPnP	<span style="border: 1px solid black; padding: 2px;">ALL</span>
<input checked="" type="checkbox"/> DoS	<span style="border: 1px solid black; padding: 2px;">ALL</span>

The following table describes the fields in this screen.

**Table 82** Maintenance > Log Setting

LABEL	DESCRIPTION
Syslog Setting	
Syslog Logging	Select the <b>Active</b> check box to enable syslog logging.
Mode	Select <b>Local File</b> to have the Device save the log file locally. Select <b>Local File and Remote</b> to have the Device save the log file locally and send it to an external syslog server.
Syslog Server IP Address	Enter the server name or IP address of the syslog server that will log the selected categories of logs.
Syslog Server UDP Port	Enter the port number used by the syslog server.

**Table 82** Maintenance > Log Setting (continued)

LABEL	DESCRIPTION
E-mail Log Settings	
SMTP Authentication	SMTP (Simple Mail Transfer Protocol) is the message-exchange standard for the Internet. SMTP enables you to move messages from one E-mail server to another.  Select the check box to activate SMTP authentication. If mail server authentication is needed but this feature is disabled, you will not receive the E-mail logs.
Mail Server	Enter the server name or the IP address of the mail server for the e-mail addresses specified below. If this field is left blank, logs and alert messages will not be sent via E-mail.
Mail Subject	Type a title that you want to be in the subject line of the system log e-mail message that the Device sends.
From	Specify where the logs are sent from.
To	The Device sends logs to the e-mail address specified in this field. If this field is left blank, the Device does not send logs via E-mail.
User Name	Enter the user name (up to 32 characters) (usually the user name of a mail account).
Password	Enter the password associated with the user name above.
Log Schedule	Specify the schedule for sending log. Specify days and times for sending logs in the following fields.
Day For Sending Log	Specify the day for sending log.
Time for Sending Log	Specify the time for sending log.
Clear log after sending mail	Select this to delete all the logs after the Device sends an E-mail of the logs.
E-mail Alarm Log Settings	
Send Alarm to	Alerts are real-time notifications that are sent as soon as an event, such as a DoS attack, system error, or forbidden web access attempt occurs. Enter the E-mail address where the alert messages will be sent. Alerts include system errors, attacks and attempted access to blocked web sites. If this field is left blank, alert messages will not be sent via E-mail.
Alarm Interval	Specify the number of seconds between the sending of alarm log e-mails.
Active Log and Select Level	
Log Category	Select the categories of logs that you want to record.
Log Level	Select the severity level of logs that you want to record. If you want to record all logs, select <b>ALL</b> .
Apply	Click <b>Apply</b> to save your changes.
Cancel	Click <b>Cancel</b> to restore your previously saved settings.





# Firmware Upgrade

## 23.1 Overview

This chapter explains how to upload new firmware to your Device. You can download new firmware releases from your nearest ZyXEL FTP site (or [www.zyxel.com](http://www.zyxel.com)) to use to upgrade your device's performance.

**Only use firmware for your device's specific model. Refer to the label on the bottom of your Device.**

## 23.2 The Firmware Upgrade Screen

Click **Maintenance > Firmware Upgrade** to open the **following** screen. The upload process uses HTTP (Hypertext Transfer Protocol) and may take up to three minutes. After a successful upload, the system will reboot.

**Do NOT turn off the Device while firmware upload is in progress!**

**Figure 128** Maintenance > Firmware Upgrade

The following table describes the labels in this screen.

**Table 83** Maintenance > Firmware Upgrade

LABEL	DESCRIPTION
Upgrade Firmware	Use these fields to upload firmware to the Device.
Current Firmware Version	This is the present firmware version.
File Path	Type in the location of the file you want to upload in this field or click <b>Browse ...</b> to find it.
Browse...	Click this to find the .bin file you want to upload. Remember that you must decompress compressed (.zip) files before you can upload them.
Upload	Click this to begin the upload process. This process may take up to three minutes.

After you see the firmware updating screen, wait a few minutes before logging into the Device again.

**Figure 129** Firmware Uploading

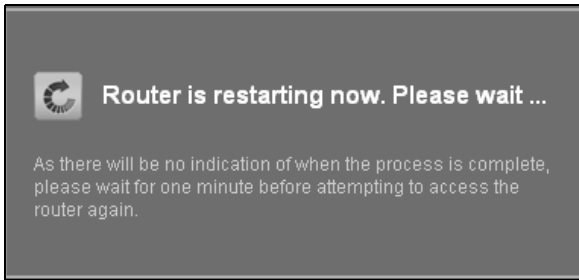

The Device automatically restarts in this time causing a temporary network disconnect. In some operating systems, you may see the following icon on your desktop.

**Figure 130** Network Temporarily Disconnected



After two minutes, log in again and check your new firmware version in the **Status** screen.

If the upload was not successful, an error screen will appear. Click **OK** to go back to the **Firmware Upgrade** screen.

**Figure 131** Error Message

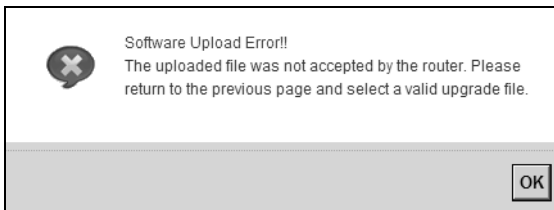

# Backup/Restore

## 24.1 Overview

The **Backup/Restore** screen allows you to backup and restore device configurations. You can also reset your device settings back to the factory default.

## 24.2 The Backup/Restore Screen

Click **Maintenance > Backup/Restore**. Information related to factory defaults, backup configuration, and restoring configuration appears in this screen, as shown next.

**Figure 132** Maintenance > Backup/Restore

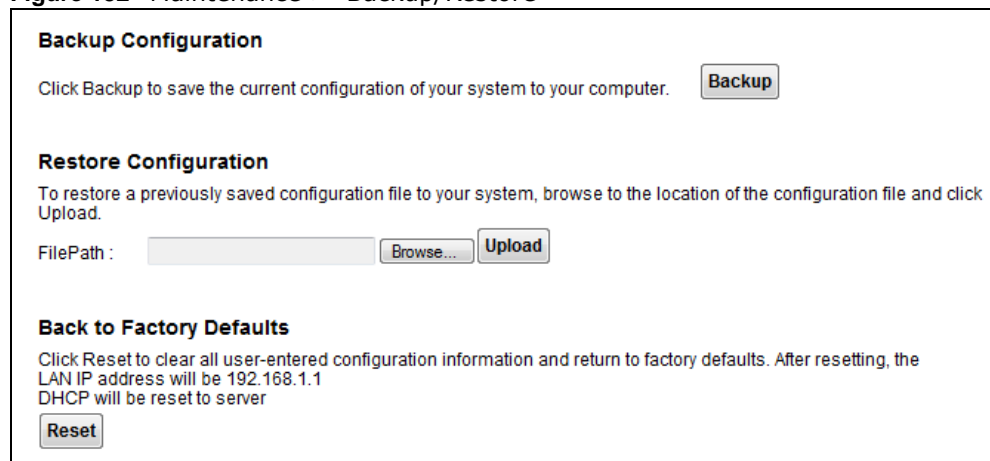

**Backup Configuration**

Click Backup to save the current configuration of your system to your computer.

**Restore Configuration**

To restore a previously saved configuration file to your system, browse to the location of the configuration file and click Upload.

FilePath:

**Back to Factory Defaults**

Click Reset to clear all user-entered configuration information and return to factory defaults. After resetting, the LAN IP address will be 192.168.1.1  
DHCP will be reset to server

### Backup Configuration

Backup Configuration allows you to back up (save) the Device's current configuration to a file on your computer. Once your Device is configured and functioning properly, it is highly recommended that you back up your configuration file before making configuration changes. The backup configuration file will be useful in case you need to return to your previous settings.

Click **Backup** to save the Device's current configuration to your computer.

## Restore Configuration

Restore Configuration allows you to upload a new or previously saved configuration file from your computer to your Device.

**Table 84** Restore Configuration

LABEL	DESCRIPTION
File Path	Type in the location of the file you want to upload in this field or click <b>Browse ...</b> to find it.
Browse...	Click this to find the file you want to upload. Remember that you must decompress compressed (.ZIP) files before you can upload them.
Upload	Click this to begin the upload process.
Reset	Click this to reset your device settings back to the factory default.

**Do not turn off the Device while configuration file upload is in progress.**

After the Device configuration has been restored successfully, the login screen appears. Login again to restart the Device.

The Device automatically restarts in this time causing a temporary network disconnect. In some operating systems, you may see the following icon on your desktop.

**Figure 133** Network Temporarily Disconnected



If you restore the default configuration, you may need to change the IP address of your computer to be in the same subnet as that of the default device IP address (192.168.1.1).

If the upload was not successful, an error screen will appear. Click **OK** to go back to the **Configuration** screen.

## Reset to Factory Defaults

Click the **Reset** button to clear all user-entered configuration information and return the Device to its factory defaults. The following warning screen appears.

**Figure 134** Reset Warning Message

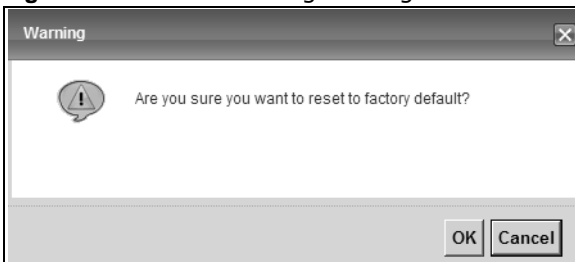

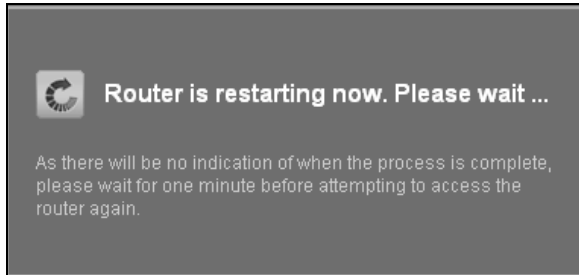
**Figure 135** Reset In Process Message

You can also press the **RESET** button on the back panel to reset the factory defaults of your Device. Refer to [Section 1.6 on page 16](#) for more information on the **RESET** button.

## 24.3 The Reboot Screen

System restart allows you to reboot the Device remotely without turning the power off. You may need to do this if the Device hangs, for example.

Click **Maintenance > Reboot**. Click the **Reboot** button to have the Device reboot. This does not affect the Device's configuration.



# Remote Management

## 25.1 Overview

Remote management allows you to determine which services/protocols can access which Device interface (if any) from which computers.

The following figure shows remote management of the Device coming in from the WAN.

**Figure 136** Remote Management From the WAN

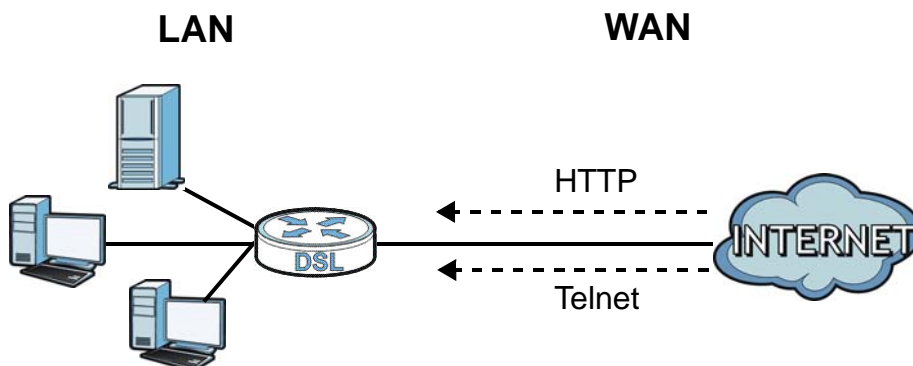

Note: When you configure remote management to allow management from the WAN, you still need to configure a IP filter rule to allow access.

You may manage your Device from a remote location via:

- Internet (WAN only)
- LAN only
- LAN and WAN
- None (Disable)

To disable remote management of a service, select **Disable** in the corresponding **Service Access** field.

### 25.1.1 What You Can Do in the Remote Management Screens

- Use the **WWW** screen ([Section 25.2 on page 192](#)) to configure through which interfaces and from which IP addresses users can use HTTP to manage the Device.
- Use the **Telnet** screen ([Section 25.3 on page 194](#)) to configure through which interfaces and from which IP addresses users can use Telnet to manage the Device.
- Use the **FTP** screen ([Section 25.4 on page 194](#)) to configure through which interfaces and from which IP addresses users can use FTP to access the Device.

- Your Device can act as an SNMP agent, which allows a manager station to manage and monitor the Device through the network. Use the **SNMP** screen (see [Section 25.5 on page 195](#)) to configure through which interfaces and from which IP addresses users can use SNMP to access the Device.
- Use the **DNS** screen ([Section 25.6 on page 198](#)) to configure through which interfaces and from which IP addresses users can send DNS queries to the Device.
- Use the **ICMP** screen ([Section 25.7 on page 199](#)) to set whether or not your Device will respond to pings and probes for services that you have not made available.
- Use the **SSH** screen ([Section 25.8 on page 199](#)) to configure through which interfaces and from which IP addresses users can use SSH to manage the Device.

## 25.1.2 What You Need to Know About Remote Management

### Remote Management Limitations

- Remote management does not work when:
  - You have not enabled that service on the interface in the corresponding remote management screen.
  - You have disabled that service in one of the remote management screens.
  - The IP address in the **Secured Client IP Address** field does not match the client IP address. If it does not match, the Device will disconnect the session immediately.
  - There is a firewall rule that blocks it.

### Remote Management and NAT

When NAT is enabled:

- Use the Device's WAN IP address when configuring from the WAN.
- Use the Device's LAN IP address when configuring from the LAN.

## 25.2 The WWW Screen

Use this screen to specify how to connect to the Device from a web browser, such as Internet Explorer.

### 25.2.1 Configuring the WWW Screen

Click **Maintenance > Remote MGMT** to display the **WWW** screen.



**Figure 137** Maintenance > Remote MGMT > WWW

Remote MGMT enables to access this device remotely from a WAN and/or LAN connection by WWW.

Server Port:

Server Access:

Secured Client IP Address:  All

Range

From:  To:

From:  To:

From:  To:

Remote MGMT enables to access this device remotely from a WAN and/or LAN connection by HTTPS.

Server Port:

Server Access:

Secured Client IP Address:  All

Range

From:  To:

From:  To:

From:  To:

**Note :**

- 1: For UPnP to function normally, the HTTP and HTTPS service must be available for LAN computers using UPnP.
- 2: The session will be reset after apply.
- 3: The Range IP could be IPv4 or IPv6.

The following table describes the labels in this screen.

**Table 85** Maintenance > Remote MGMT > WWW

LABEL	DESCRIPTION
Server Port	This displays the service port number for accessing the Device using HTTP or HTTPS. If the number is grayed out, it is not editable.
Server Access	Select the interfaces through which a computer may access the Device using this service.  Note: It is recommended if you are allowing WAN access even temporarily to change the default password (in <b>Maintenance &gt; User Account</b> ). To allow access from the WAN, you will need to configure a WAN to Router firewall rule.
Secured Client IP Address	A secured client is a "trusted" computer that is allowed to communicate with the Device using this service.  Select <b>All</b> to allow any computer to access the Device using this service.  Choose <b>Range</b> to just allow the computers with an IP address in the range that you specify to access the Device using this service.
Apply	Click this to save your changes.
Cancel	Click this to restore your previously saved settings.

## 25.3 Telnet Screen

You can use Telnet to access the Device's command line interface. Specify which interfaces allow Telnet access and from which IP address the access can come.

Click **Maintenance > Remote MGMT > Telnet** tab to display the screen as shown.

**Figure 138** Maintenance > Remote MGMT > Telnet

Server Port: 23

Server Access: LAN

Secured Client IP Address:  All

Range From: 0.0.0.0 To: 0.0.0.0

Range From: 0.0.0.0 To: 0.0.0.0

Range From: 0.0.0.0 To: 0.0.0.0

**Note:**

- 1.The session will be reset after apply.
- 2.The Range IP could be IPv4 or IPv6.

Apply Cancel

The following table describes the labels in this screen.

**Table 86** Maintenance > Remote MGMT > Telnet

LABEL	DESCRIPTION
Server Port	This displays the service port number for accessing the Device. If the number is grayed out, it is not editable.
Server Access	Select the interfaces through which a computer may access the Device using this service.  Note: It is recommended if you are allowing WAN access even temporarily to change the default password (in <b>Maintenance &gt; User Account</b> ). To allow access from the WAN, you will need to configure a WAN to Router firewall rule.
Secured Client IP Address	A secured client is a "trusted" computer that is allowed to communicate with the Device using this service.  Select <b>All</b> to allow any computer to access the Device using this service.  Choose <b>Range</b> to just allow the computers with an IP address in the range that you specify to access the Device using this service.
Apply	Click this to save your changes.
Cancel	Click this to restore your previously saved settings.

## 25.4 FTP Screen

You can use FTP (File Transfer Protocol) to upload and download the Device's firmware and configuration files. To use this feature, your computer must have an FTP client.

Use this screen to specify which interfaces allow FTP access and from which IP address the access can come. To change your Device's FTP settings, click **Maintenance > Remote MGMT > FTP**. The screen appears as shown.

**Figure 139** Maintenance > Remote MGMT > FTP

Server Port: 21

Server Access: LAN

Secured Client IP Address:  All

From: 0.0.0.0 To: 0.0.0.0

Range From: 0.0.0.0 To: 0.0.0.0

From: 0.0.0.0 To: 0.0.0.0

**Note :**

- 1.The session will be reset after apply.
- 2.The Range IP could be IPv4 or IPv6.

Apply Cancel

The following table describes the labels in this screen.

**Table 87** Maintenance > Remote MGMT > FTP

LABEL	DESCRIPTION
Server Port	This displays the service port number for accessing the Device. If the number is grayed out, it is not editable.
Server Access	Select the interfaces through which a computer may access the Device using this service.
Secured Client IP Address	A secured client is a "trusted" computer that is allowed to communicate with the Device using this service.  Select <b>All</b> to allow any computer to access the Device using this service.  Choose <b>Range</b> to just allow the computers with an IP address in the range that you specify to access the Device using this service.
Apply	Click this to save your changes.
Cancel	Click this to restore your previously saved settings.

## 25.5 SNMP Screen

Simple Network Management Protocol is a protocol used for exchanging management information between network devices. Your Device supports SNMP agent functionality, which allows a manager station to manage and monitor the Device through the network. The Device supports SNMP version one (SNMPv1) and version two (SNMPv2c). The next figure illustrates an SNMP management operation.

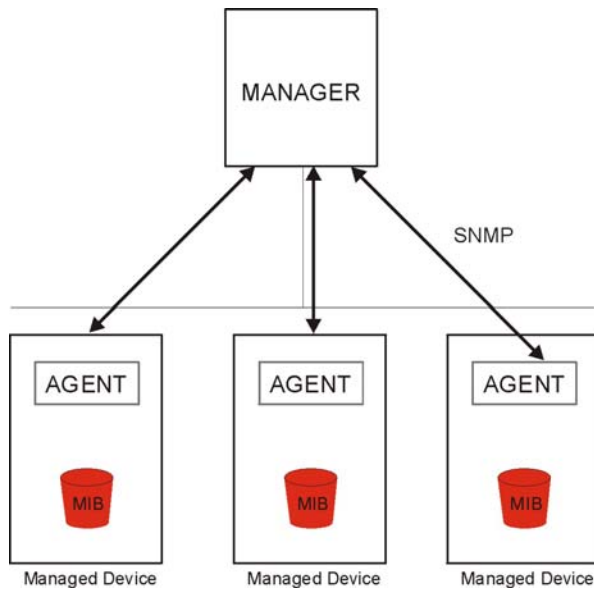
**Figure 140** SNMP Management Model

An SNMP managed network consists of two main types of component: agents and a manager.

An agent is a management software module that resides in a managed device (the Device). An agent translates the local management information from the managed device into a form compatible with SNMP. The manager is the console through which network administrators perform network management functions. It executes applications that control and monitor managed devices.

The managed devices contain object variables/managed objects that define each piece of information to be collected about a device. Examples of variables include such as number of packets received, node port status etc. A Management Information Base (MIB) is a collection of managed objects. SNMP allows a manager and agents to communicate for the purpose of accessing these objects.

### 25.5.1 Configuring SNMP

To change your Device's SNMP settings, click **Maintenance > Remote MGMT > SNMP** tab. The screen appears as shown.

**Figure 141** Maintenance > Remote MGMT > SNMP

Server Port: 161

Server Access: LAN

SNMPv3:  Enable  Disable

Secured Client IP Address:  All

Range

From: 0.0.0.0 To: 0.0.0.0

From: 0.0.0.0 To: 0.0.0.0

From: 0.0.0.0 To: 0.0.0.0

**SNMP Setup**

Get Community: public

Set Community: public

Trap Community: public

IPv4 Trap Destination: 0.0.0.0

IPv6 Trap Destination: ::1

**Note :**

1.The session will be reset after apply.

2.The Range IP could be IPv4 or IPv6.

Apply Cancel

The following table describes the labels in this screen.

**Table 88** Maintenance > Remote MGMT > SNMP

LABEL	DESCRIPTION
Server Port	This displays the port the SNMP agent listens on. If the number is grayed out, it is not editable.
Server Access	Select the interfaces through which a computer may access the Device using this service.
Secured Client IP Address	A secured client is a "trusted" computer that is allowed to access the SNMP agent on the Device.  Select <b>All</b> to allow any computer to access the SNMP agent.  Choose <b>Range</b> to just allow the computers with an IP address in the range that you specify to access the Device using this service.
Get Community	Enter the <b>Get Community</b> , which is the password for the incoming Get and GetNext requests from the management station. The default is public and allows all requests.
Set Community	Enter the <b>Set community</b> , which is the password for incoming Set requests from the management station. The default is public and allows all requests.
Trap Community	Type the trap community, which is the password sent with each trap to the SNMP manager. The default is public and allows all requests.
IPv4 Trap Destination	Type the IPv4 IP address of the station to send your SNMP traps to.
IPv6 Trap Destination	Type the IPv6 IP address of the station to send your SNMP traps to.

**Table 88** Maintenance > Remote MGMT > SNMP (continued)

LABEL	DESCRIPTION
Apply	Click <b>Apply</b> to save your changes back to the Device.
Cancel	Click <b>Cancel</b> to begin configuring this screen afresh.

## 25.6 DNS Screen

Use DNS (Domain Name System) to map a domain name to its corresponding IP address and vice versa.

Use this screen to set from which IP address the Device will accept DNS queries and on which interface it can send them your Device's DNS settings. This feature is not available when the Device is set to bridge mode. Click **Maintenance > Remote MGMT > DNS** to change your Device's DNS settings.

**Figure 142** Maintenance > Remote MGMT > DNS

Server Port: 53

Server Access: LAN

Secured Client IP Address:  All

Range

From: 0.0.0.0 To: 0.0.0.0

From: 0.0.0.0 To: 0.0.0.0

From: 0.0.0.0 To: 0.0.0.0

**Note:**

1. The Range IP could be IPv4 or IPv6.

Apply Cancel

The following table describes the labels in this screen.

**Table 89** Maintenance > Remote MGMT > DNS

LABEL	DESCRIPTION
Server Port	This displays the service port number for accessing the Device. If the number is grayed out, it is not editable.
Access Status	Select the interfaces through which a computer may send DNS queries to the Device.
Secured Client IP Address	A secured client is a "trusted" computer that is allowed to send DNS queries to the Device. Select <b>All</b> to allow any computer to send DNS queries to the Device. Choose <b>Range</b> to just allow the computers with an IP address in the range that you specify to send DNS queries to the Device.
Apply	Click this to save your changes.
Cancel	Click this to restore your previously saved settings.

## 25.7 ICMP Screen

To change your Device's security settings, click **Maintenance > Remote MGMT > ICMP**. The screen appears as shown.

If an outside user attempts to probe an unsupported port on your Device, an ICMP response packet is automatically returned. This allows the outside user to know the Device exists. Your Device supports anti-probing, which prevents the ICMP response packet from being sent. This keeps outsiders from discovering your Device when unsupported ports are probed.

**Note:** If you want your device to respond to pings and requests for unauthorized services, you will also need to configure the firewall accordingly by disabling SPI.

**Figure 143** Maintenance > Remote MGMT > ICMP

Respond to Ping on: LAN

Secured Client IP Address:  All

From: 0.0.0.0 To: 0.0.0.0

Range From: 0.0.0.0 To: 0.0.0.0

From: 0.0.0.0 To: 0.0.0.0

**Note :**

1. The Range IP could be IPv4 or IPv6.

Apply Cancel

The following table describes the labels in this screen.

**Table 90** Maintenance > Remote MGMT > ICMP

LABEL	DESCRIPTION
Respond to Ping on	The Device will not respond to any incoming Ping requests when <b>Disable</b> is selected. Select <b>LAN</b> to reply to incoming LAN Ping requests. Select <b>WAN</b> to reply to incoming WAN Ping requests. Otherwise select <b>LAN &amp; WAN</b> to reply to both incoming LAN and WAN Ping requests.
Secured Client IP Address	A secured client is a "trusted" computer that is allowed to send Ping requests to the Device.  Select <b>All</b> to allow any computer to send Ping requests to the Device.  Choose <b>Range</b> to just allow the computers with an IP address in the range that you specify to send Ping requests to the Device.
Apply	Click this to save your changes.
Cancel	Click this to restore your previously saved settings.

## 25.8 SSH Screen

You can use Secure SHell (SSH) to securely access the Device's command line interface. Specify which interfaces allow SSH access and from which IP address the access can come. SSH is a secure communication protocol that combines authentication and data encryption to provide secure encrypted communication between two hosts over an unsecured network.

Click **Maintenance > Remote MGMT > SSH** tab to display the screen as shown.

**Figure 144** Maintenance > Remote MGMT > SSH

Server Port: 22

Server Access: LAN

Secured Client IP Address:  All

Range:  Range

From: 0.0.0.0 To: 0.0.0.0

From: 0.0.0.0 To: 0.0.0.0

From: 0.0.0.0 To: 0.0.0.0

**Note :**

1. The Range IP could be IPv4 or IPv6.

Apply Cancel

The following table describes the labels in this screen.

**Table 91** Maintenance > Remote MGMT > SSH

LABEL	DESCRIPTION
Server Port	This displays the service port number for accessing the Device. If the number is grayed out, it is not editable.
Server Access	Select the interfaces through which a computer may access the Device using this service.  Note: It is recommended if you are allowing WAN access even temporarily to change the default password (in <b>Maintenance &gt; User Account</b> ). To allow access from the WAN, you will need to configure a WAN to Router firewall rule.
Secured Client IP Address	A secured client is a "trusted" computer that is allowed to communicate with the Device using this service.  Select <b>All</b> to allow any computer to access the Device using this service.  Choose <b>Range</b> to just allow the computers with an IP address in the range that you specify to access the Device using this service.
Apply	Click this to save your changes.
Cancel	Click this to restore your previously saved settings.

## 25.8.1 SSH Example

This section shows an example using a graphical interface SSH client program to remotely access the device. The configuration and connection steps are similar for most SSH client programs. Refer to your SSH client program user's guide.

- 1 Enter the IP address and port number. Select **SSH**.



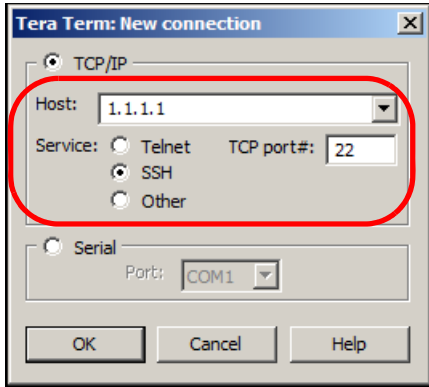

- 2 A window displays prompting you to store the host key in your computer. Click **Yes** to continue.



- 3 Enter your user name and password.

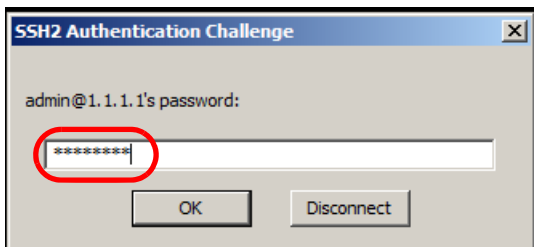
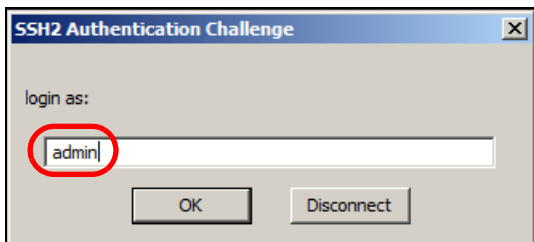

- 4 The command line interface displays.

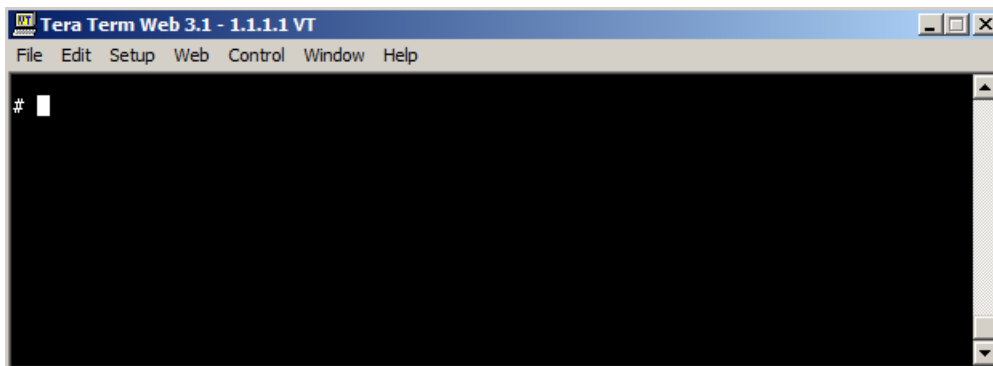

## 26.1 Overview

You can use different diagnostic methods to test a connection and see the detailed information. These read-only screens display information to help you identify problems with the Device.

### 26.1.1 What You Can Do in the Diagnostic Screens

- Use the **Ping** screen (Section 26.2 on page 203) to ping an IP address.
- Use the **DSL Line** screen (Section 26.3 on page 204) to view the DSL line statistics and reset the ADSL line.

## 26.2 The Ping Screen

Ping and traceroute help check availability of remote hosts and also help troubleshoot network or Internet connections. Click **Maintenance > Diagnostic** to open the **Ping** screen shown next.

**Figure 145** Maintenance > Diagnostic > Ping

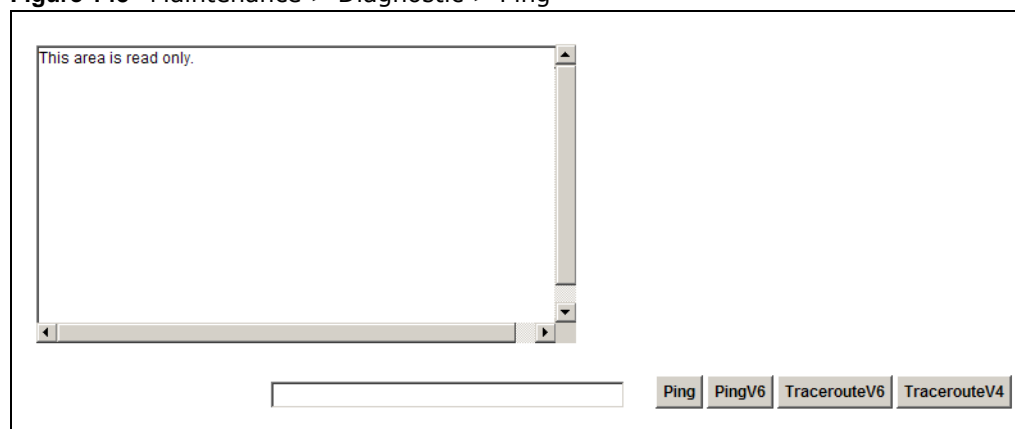

The following table describes the fields in this screen.

**Table 92** Maintenance > Diagnostic > Ping

LABEL	DESCRIPTION
Ping	Type the IP address of a computer that you want to ping in order to test a connection. Click <b>Ping</b> and the ping statistics will show in the diagnostic .
PingV6	Click this to ping the IPv6 address that you entered.

**Table 92** Maintenance > Diagnostic > Ping (continued)

LABEL	DESCRIPTION
TracerouteV6	Click this to show the path that packets take from the system to the IPv6 address that you entered.
TraceRouteV4	Click this button to perform the traceroute function. This determines the path a packet takes to the specified host.

## 26.3 The DSL Line Screen

Use this screen to view the DSL line statistics and reset the DSL line. Click **Maintenance > Diagnostic > DSL Line**. This screen is different for ADSL and VDSL connections. If your WAN connection is ADSL, the screen is as shown next.

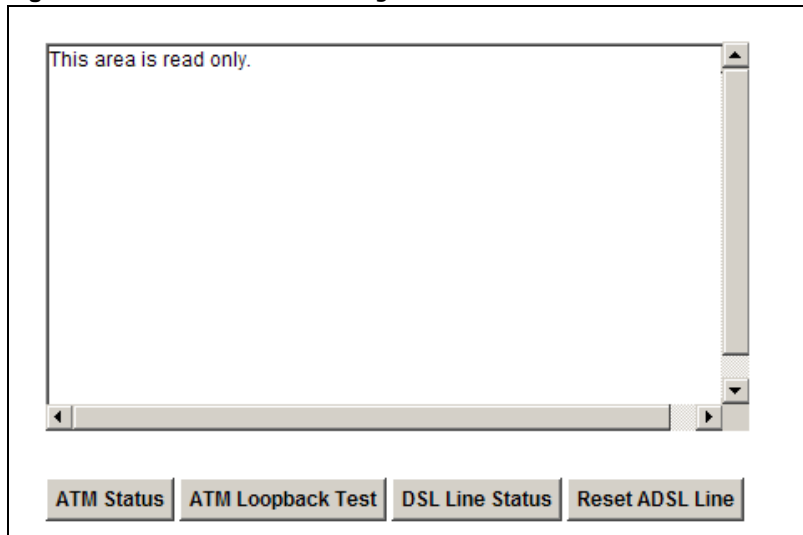
**Figure 146** Maintenance > Diagnostic > DSL Line: ADSL

The following table describes the fields in this screen.

**Table 93** Maintenance > Diagnostic > DSL Line

LABEL	DESCRIPTION
ATM Status	<p>Click this to view your DSL connection's Asynchronous Transfer Mode (ATM) statistics. ATM is a networking technology that provides high-speed data transfer. ATM uses fixed-size packets of information called cells. With ATM, a high QoS (Quality of Service) can be guaranteed.</p> <p>The (Segmentation and Reassembly) SAR driver translates packets into ATM cells. It also receives ATM cells and reassembles them into packets.</p> <p>These counters are set back to zero whenever the device starts up.</p> <p><b>inPkts</b> is the number of good ATM cells that have been received.</p> <p><b>inF4Pkts</b> is the number of ATM Operations, Administration, and Management (OAM) F4 cells that have been received. See ITU recommendation I.610 for more on OAM for ATM.</p> <p><b>inF5Pkts</b> is the number of ATM OAM F5 cells that have been received.</p> <p><b>inDiscards</b> is the number of received ATM cells that were rejected.</p> <p><b>outPkts</b> is the number of ATM cells that have been sent.</p> <p><b>outF4Pkts</b> is the number of ATM OAM F4 cells that have been sent.</p> <p><b>outF5Pkts</b> is the number of ATM OAM F5 cells that have been sent.</p> <p><b>outDiscards</b> is the number of ATM cells sent that were rejected.</p>
ATM Loopback Test	<p>Click this to start the ATM loopback test. Make sure you have configured at least one PVC with proper VPIS/VCIs before you begin this test. The Device sends an OAM F5 packet to the DSLAM/ATM switch and then returns it (loops it back) to the Device. The ATM loopback test is useful for troubleshooting problems with the DSLAM and ATM network.</p>
DSL Line Status	<p>Click this to view statistics about the DSL connections.</p> <p><b>noise margin downstream</b> is the signal to noise ratio for the downstream part of the connection (coming into the Device from the ISP). It is measured in decibels. The higher the number the more signal and less noise there is.</p> <p><b>output power upstream</b> is the amount of power (in decibels) that the Device is using to transmit to the ISP.</p> <p><b>attenuation downstream</b> is the reduction in amplitude (in decibels) of the DSL signal coming into the Device from the ISP.</p> <p>Discrete Multi-Tone (DMT) modulation divides up a line's bandwidth into sub-carriers (sub-channels) of 4.3125 KHz each called tones. The rest of the display is the line's bit allocation. This is displayed as the number (in hexadecimal format) of bits transmitted for each tone. This can be used to determine the quality of the connection, whether a given sub-carrier loop has sufficient margins to support certain ADSL transmission rates, and possibly to determine whether particular specific types of interference or line attenuation exist. Refer to the ITU-T G.992.1 recommendation for more information on DMT.</p> <p>The better (or shorter) the line, the higher the number of bits transmitted for a DMT tone. The maximum number of bits that can be transmitted per DMT tone is 15. There will be some tones without any bits as there has to be space between the upstream and downstream channels.</p>
Reset ADSL Line	<p>Click this to reinitialize the ADSL line. The large text box above then displays the progress and results of this operation.</p>



# Troubleshooting

## 27.1 Overview

This chapter offers some suggestions to solve problems you might encounter. The potential problems are divided into the following categories.

- [Power, Hardware Connections, and LEDs](#)
- [Device Access and Login](#)
- [Internet Access](#)
- [Wireless Internet Access](#)
- [USB Device Connection](#)
- [UPnP](#)

## 27.2 Power, Hardware Connections, and LEDs

---

The Device does not turn on. None of the LEDs turn on.

---

- 1 Make sure the Device is turned on.
- 2 Make sure you are using the power adaptor or cord included with the Device.
- 3 Make sure the power adaptor or cord is connected to the Device and plugged in to an appropriate power source. Make sure the power source is turned on.
- 4 Turn the Device off and on.
- 5 If the problem continues, contact the vendor.

---

One of the LEDs does not behave as expected.

---

- 1 Make sure you understand the normal behavior of the LED. See [Section 1.7 on page 16](#).
- 2 Check the hardware connections. See the Quick Start Guide.
- 3 Inspect your cables for damage. Contact the vendor to replace any damaged cables.

- 4 Turn the Device off and on.
- 5 If the problem continues, contact the vendor.

## 27.3 Device Access and Login

---

### I forgot the IP address for the Device.

---

- 1 The default IP address is 192.168.1.1.
- 2 If you changed the IP address and have forgotten it, you might get the IP address of the Device by looking up the IP address of the default gateway for your computer. To do this in most Windows computers, click **Start > Run**, enter **cmd**, and then enter **ipconfig**. The IP address of the **Default Gateway** might be the IP address of the Device (it depends on the network), so enter this IP address in your Internet browser.
- 3 If this does not work, you have to reset the device to its factory defaults. See [Section 1.6 on page 16](#).

---

### I forgot the password.

---

- 1 The default admin password is **1234** and the default user password is **1234**.
- 2 If you can't remember the password, you have to reset the device to its factory defaults. See [Section 1.6 on page 16](#).

---

### I cannot see or access the **Login** screen in the web configurator.

---

- 1 Make sure you are using the correct IP address.
  - The default IP address is 192.168.1.1.
  - If you changed the IP address ([Section on page 91](#)), use the new IP address.
  - If you changed the IP address and have forgotten it, see the troubleshooting suggestions for [I forgot the IP address for the Device](#).
- 2 Check the hardware connections, and make sure the LEDs are behaving as expected. See the Quick Start Guide.
- 3 Make sure your Internet browser does not block pop-up windows and has JavaScript and Java enabled.



- 4 Reset the device to its factory defaults, and try to access the Device with the default IP address. See [Section 1.6 on page 16](#).
- 5 If the problem continues, contact the network administrator or vendor, or try one of the advanced suggestions.

#### Advanced Suggestions

- Try to access the Device using another service, such as Telnet. If you can access the Device, check the remote management settings and firewall rules to find out why the Device does not respond to HTTP.

---

#### I can see the **Login** screen, but I cannot log in to the Device.

---

- 1 Make sure you have entered the user name and password correctly. The default user name is **admin**. These fields are case-sensitive, so make sure [Caps Lock] is not on.
- 2 You cannot log in to the web configurator while someone is using Telnet to access the Device. Log out of the Device in the other session, or ask the person who is logged in to log out.
- 3 Turn the Device off and on.
- 4 If this does not work, you have to reset the device to its factory defaults. See [Section 27.2 on page 207](#).

---

#### I cannot Telnet to the Device.

---

See the troubleshooting suggestions for [I cannot see or access the Login screen in the web configurator](#). Ignore the suggestions about your browser.

---

#### I cannot use FTP to upload / download the configuration file. / I cannot use FTP to upload new firmware.

---

See the troubleshooting suggestions for [I cannot see or access the Login screen in the web configurator](#). Ignore the suggestions about your browser.

## 27.4 Internet Access

---

#### I cannot access the Internet.

---

- 1 Check the hardware connections, and make sure the LEDs are behaving as expected. See the Quick Start Guide and [Section 1.7 on page 16](#).
- 2 Make sure you entered your ISP account information correctly. These fields are case-sensitive, so make sure [Caps Lock] is not on.
- 3 If you are trying to access the Internet wirelessly, make sure the wireless settings in the wireless client are the same as the settings in the AP.
- 4 If you are trying to access the Internet wirelessly, make sure you have enabled the wireless LAN by the **WPS/WLAN** button or the **Network Setting > Wireless > General** screen.
- 5 Disconnect all the cables from your device, and follow the directions in the Quick Start Guide again.
- 6 If the problem continues, contact your ISP.

---

[I cannot access the Internet anymore. I had access to the Internet \(with the Device\), but my Internet connection is not available anymore.](#)

---

- 1 Check the hardware connections, and make sure the LEDs are behaving as expected. See the Quick Start Guide and [Section 1.7 on page 16](#).
- 2 Turn the Device off and on.
- 3 If the problem continues, contact your ISP.

---

[The Internet connection is slow or intermittent.](#)

---

- 1 There might be a lot of traffic on the network. Look at the LEDs, and check [Section 1.7 on page 16](#). If the Device is sending or receiving a lot of information, try closing some programs that use the Internet, especially peer-to-peer applications.
- 2 Turn the Device off and on.
- 3 If the problem continues, contact the network administrator or vendor, or try one of the advanced suggestions.

**Advanced Suggestions**

- Check the settings for QoS. If it is disabled, you might consider activating it. If it is enabled, you might consider raising or lowering the priority for some applications.

## 27.5 Wireless Internet Access

---

What factors may cause intermittent or unstabled wireless connection? How can I solve this problem?

---

The following factors may cause interference:

- Obstacles: walls, ceilings, furniture, and so on.
- Building Materials: metal doors, aluminum studs.
- Electrical devices: microwaves, monitors, electric motors, cordless phones, and other wireless devices.

To optimize the speed and quality of your wireless connection, you can:

- Move your wireless device closer to the AP if the signal strength is low.
- Reduce wireless interference that may be caused by other wireless networks or surrounding wireless electronics such as cordless phones.
- Place the AP where there are minimum obstacles (such as walls and ceilings) between the AP and the wireless client.
- Reduce the number of wireless clients connecting to the same AP simultaneously, or add additional APs if necessary.
- Try closing some programs that use the Internet, especially peer-to-peer applications. If the wireless client is sending or receiving a lot of information, it may have too many programs open that use the Internet.

---

What wireless security modes does my Device support?

---

Wireless security is vital to your network. It protects communications between wireless stations, access points and the wired network.

The available security modes in your ZyXEL device are as follows:

- **WPA2-PSK:** (recommended) This uses a pre-shared key with the WPA2 standard.
- **WPA-PSK:** This has the device use either WPA-PSK or WPA2-PSK depending on which security mode the wireless client uses.
- **WPA2:** WPA2 (IEEE 802.11i) is a wireless security standard that defines stronger encryption, authentication and key management than WPA. It requires the use of a RADIUS server and is mostly used in business networks.
- **WPA:** Wi-Fi Protected Access (WPA) is a subset of the IEEE 802.11i standard. It requires the use of a RADIUS server and is mostly used in business networks.
- **WEP:** Wired Equivalent Privacy (WEP) encryption scrambles the data transmitted between the wireless stations and the access points to keep network communications private.

## 27.6 USB Device Connection

---

The Device fails to detect my USB device.

---

- 1 Disconnect the USB device.
- 2 Reboot the Device.
- 3 If you are connecting a USB hard drive that comes with an external power supply, make sure it is connected to an appropriate power source that is on.
- 4 Re-connect your USB device to the Device.

## 27.7 UPnP

---

When using UPnP and the Device reboots, my computer cannot detect UPnP and refresh **My Network Places > Local Network**.

---

- 1 Disconnect the Ethernet cable from the Device's LAN port or from your computer.
- 2 Re-connect the Ethernet cable.

---

The **Local Area Connection** icon for UPnP disappears in the screen.

---

Restart your computer.

---

I cannot open special applications such as white board, file transfer and video when I use the MSN messenger.

---

- 1 Wait more than three minutes.
- 2 Restart the applications.

# Legal Information

## Copyright

Copyright © 2014 by ZyXEL Communications Corporation.

The contents of this publication may not be reproduced in any part or as a whole, transcribed, stored in a retrieval system, translated into any language, or transmitted in any form or by any means, electronic, mechanical, magnetic, optical, chemical, photocopying, manual, or otherwise, without the prior written permission of ZyXEL Communications Corporation.

Published by ZyXEL Communications Corporation. All rights reserved.

## Disclaimer

ZyXEL does not assume any liability arising out of the application or use of any products, or software described herein. Neither does it convey any license under its patent rights nor the patent rights of others. ZyXEL further reserves the right to make changes in any products described herein without notice. This publication is subject to change without notice.

Your use of the Device is subject to the terms and conditions of any related service providers.

## Trademarks

ZyNOS (ZyXEL Network Operating System) is a registered trademark of ZyXEL Communications, Inc. Other trademarks mentioned in this publication are used for identification purposes only and may be properties of their respective owners.

Trademarks mentioned in this publication are used for identification purposes only and may be properties of their respective owners.

## Certifications

### Federal Communications Commission (FCC) Interference Statement

The device complies with Part 15 of FCC rules. Operation is subject to the following two conditions:

- This device may not cause harmful interference.
- This device must accept any interference received, including interference that may cause undesired operations.

This device has been tested and found to comply with the limits for a Class B digital device pursuant to Part 15 of the FCC Rules. These limits are designed to provide reasonable protection against harmful interference in a residential installation. This device generates, uses, and can radiate radio frequency energy, and if not installed and used in accordance with the instructions, may cause harmful interference to radio communications. However, there is no guarantee that interference will not occur in a particular installation.

If this device does cause harmful interference to radio/television reception, which can be determined by turning the device off and on, the user is encouraged to try to correct the interference by one or more of the following measures:

- 1 Reorient or relocate the receiving antenna.
- 2 Increase the separation between the equipment and the receiver.
- 3 Connect the equipment into an outlet on a circuit different from that to which the receiver is connected.
- 4 Consult the dealer or an experienced radio/TV technician for help.

FCC Caution: Any changes or modifications not expressly approved by the party responsible for compliance could void the user's authority to operate this equipment.



### FCC Radiation Exposure Statement

- This transmitter must not be co-located or operating in conjunction with any other antenna or transmitter.
- IEEE 802.11b, 802.11g or 802.11n (20MHz) operation of this product in the U.S.A. is firmware-limited to channels 1 through 11. IEEE 802.11n (40MHz) operation of this product in the U.S.A. is firmware-limited to channels 3 through 9.
- IEEE 802.11b or 802.11g operation of this product in the U.S.A. is firmware-limited to channels 1 through 11.
- To comply with FCC RF exposure compliance requirements, a separation distance of at least 20 cm must be maintained between the antenna of this device and all persons.

### IC Radiation Exposure Statement

This equipment complies with IC radiation exposure limits set forth for an uncontrolled environment. End users must follow the specific operating instructions for satisfying RF exposure compliance.

## Notices

Changes or modifications not expressly approved by the party responsible for compliance could void the user's authority to operate the equipment.

This device is designed for the WLAN 2.4 GHz networks throughout the EC region and Switzerland, with restrictions in France.

Ce produit est conçu pour les bandes de fréquences 2,4 GHz conformément à la législation Européenne. En France métropolitaine, suivant les décisions n°03-908 et 03-909 de l'ARCEP, la puissance d'émission ne devra pas dépasser 10 mW (10 dB) dans le cadre d'une installation WiFi en extérieur pour les fréquences comprises entre 2454 MHz et 2483,5 MHz.

## Viewing Certifications

Go to <http://www.zyxel.com> to view this product's documentation and certifications.

## ZyXEL Limited Warranty

ZyXEL warrants to the original end user (purchaser) that this product is free from any defects in material or workmanship for a specific period (the Warranty Period) from the date of purchase. The Warranty Period varies by region. Check with your vendor and/or the authorized ZyXEL local distributor for details about the Warranty Period of this product. During the warranty period, and upon proof of purchase, should the product have indications of failure due to faulty workmanship and/or materials, ZyXEL will, at its discretion, repair or replace the defective products or components without charge for either parts or labor, and to whatever extent it shall deem necessary to restore the product or components to proper operating condition. Any replacement will consist of a new or re-manufactured functionally equivalent product of equal or higher value, and will be solely at the discretion of ZyXEL. This warranty shall not apply if the product has been modified, misused, tampered with, damaged by an act of God, or subjected to abnormal working conditions.

### Note

Repair or replacement, as provided under this warranty, is the exclusive remedy of the purchaser. This warranty is in lieu of all other warranties, express or implied, including any implied warranty of merchantability or fitness for a particular use or purpose. ZyXEL shall in no event be held liable for indirect or consequential damages of any kind to the purchaser.

To obtain the services of this warranty, contact your vendor. You may also refer to the warranty policy for the region in which you bought the device at [http://www.zyxel.com/web/support\\_warranty\\_info.php](http://www.zyxel.com/web/support_warranty_info.php).

### Registration

Register your product online to receive e-mail notices of firmware upgrades and information at [www.zyxel.com](http://www.zyxel.com) for global products, or at [www.us.zyxel.com](http://www.us.zyxel.com) for North American products.

## Open Source Licenses

This product contains in part some free software distributed under GPL license terms and/or GPL like licenses. Open source licenses are provided with the firmware package. You can download the latest firmware at [www.zyxel.com](http://www.zyxel.com). If you cannot find it there, contact your vendor or ZyXEL Technical Support at [support@zyxel.com.tw](mailto:support@zyxel.com.tw). To obtain the source code covered under those Licenses, please contact your vendor or ZyXEL Technical Support at [support@zyxel.com.tw](mailto:support@zyxel.com.tw).

## Regulatory Information

### European Union

The following information applies if you use the product within the European Union.

### Declaration of Conformity with Regard to EU Directive 1999/5/EC (R&TTE Directive)

Compliance Information for Wireless Products Relevant to the EU and Other Countries Following the EU Directive 1999/5/EC (R&TTE Directive)

[Czech]	ZyXEL tímto prohlašuje, že tento zařízení je ve shodě se základními požadavky a dalšími příslušnými ustanoveními směrnice 1999/5/EC.
[Danish]	Undertegnede ZyXEL erklærer herved, at følgende udstyr overholder de væsentlige krav og øvrige relevante krav i direktiv 1999/5/EF.
[German]	Hiermit erklärt ZyXEL, dass sich das Gerät Ausstattung in Übereinstimmung mit den grundlegenden Anforderungen und den übrigen einschlägigen Bestimmungen der Richtlinie 1999/5/EU befindet.
[Estonian]	Käesolevaga kinnitab ZyXEL seadme seadmed vastavust direktiivi 1999/5/EÜ põhinõuetele ja nimetatud direktiivist tulenevatele teistele asjakohastele sätetele.
[English]	Hereby, ZyXEL declares that this equipment is in compliance with the essential requirements and other relevant provisions of Directive 1999/5/EC.
[Spanish]	Por medio de la presente ZyXEL declara que el equipo cumple con los requisitos esenciales y cualesquiera otras disposiciones aplicables o exigibles de la Directiva 1999/5/CE.
[Greek]	ΜΕ ΤΗΝ ΠΑΡΟΥΣΑ ΖΥΧΕΛ ΔΗΛΩΝΕΙ ΟΤΙ ΕΞΟΛΙΣΜΟΣ ΣΥΜΜΟΡΦΩΝΕΤΑΙ ΠΡΟΣ ΤΙΣ ΟΥΣΙΩΔΕΙΣ ΑΠΑΙΤΗΣΕΙΣ ΚΑΙ ΤΙΣ ΛΟΙΠΕΣ ΣΧΕΤΙΚΕΣ ΔΙΑΤΑΞΕΙΣ ΤΗΣ ΟΔΗΓΙΑΣ 1999/5/ΕΚ.
[French]	Par la présente ZyXEL déclare que l'appareil équipements est conforme aux exigences essentielles et aux autres dispositions pertinentes de la directive 1999/5/EC.
[Italian]	Con la presente ZyXEL dichiara che questo attrezzatura è conforme ai requisiti essenziali ed alle altre disposizioni pertinenti stabilite dalla direttiva 1999/5/CE.
[Latvian]	Ar šo ZyXEL deklarē, ka iekārtas atbilst Direktīvas 1999/5/EK būtiskajām prasībām un citiem ar to saistītajiem noteikumiem.
[Lithuanian]	Šiuo ZyXEL deklaruoja, kad šis įranga atitinka esminius reikalavimus ir kitas 1999/5/EB Direktyvos nuostatas.
[Dutch]	Hierbij verklaart ZyXEL dat het toestel uitrusting in overeenstemming is met de essentiële eisen en de andere relevante bepalingen van richtlijn 1999/5/EC.
[Maltese]	Hawnhekk, ZyXEL, jiddikjara li dan tagħmir jikkonforma mal-ħtiġijiet essenzjali u ma provvedimenti oħrajn relevanti li hemm fid-Dirrettiva 1999/5/EC.
[Hungarian]	Alulírott, ZyXEL nyilatkozom, hogy a berendezés megfelel a vonatkozó alapvető követelményeknek és az 1999/5/EK irányelv egyéb előírásainak.

[Polish]	Niniejszym ZyXEL oświadcza, że sprzęt jest zgodny z zasadniczymi wymogami oraz pozostałymi stosownymi postanowieniami Dyrektywy 1999/5/EC.
[Portuguese]	ZyXEL declara que este equipamento está conforme com os requisitos essenciais e outras disposições da Directiva 1999/5/EC.
[Slovenian]	ZyXEL izjavlja, da je ta oprema v skladu z bistvenimi zahtevami in ostalimi relevantnimi določili direktive 1999/5/EC.
[Slovak]	ZyXEL týmto vyhlasuje, že zariadenia spĺňa základné požiadavky a všetky príslušné ustanovenia Smernice 1999/5/EC.
[Finnish]	ZyXEL vakuuttaa täten että laitteet tyyppinen laite on direktiivin 1999/5/EY oleellisten vaatimusten ja sitä koskevien direktiivin muiden ehtojen mukainen.
[Swedish]	Härmed intygar ZyXEL att denna utrustning står i överensstämmelse med de väsentliga egenskapskrav och övriga relevanta bestämmelser som framgår av direktiv 1999/5/EC.
[Bulgarian]	С настоящото ZyXEL декларира, че това оборудване е в съответствие със съществените изисквания и другите приложими разпоредбите на Директива 1999/5/EC.
[Icelandic]	Hér með lýsir, ZyXEL því yfir að þessi búnaður er í samræmi við grunnkröfur og önnur viðeigandi ákvæði tilskipunar 1999/5/EC.
[Norwegian]	Erklærer herved ZyXEL at dette utstyret er i samsvar med de grunnleggende kravene og andre relevante bestemmelser i direktiv 1999/5/EF.
[Romanian]	Prin prezenta, ZyXEL declară că acest echipament este în conformitate cu cerințele esențiale și alte prevederi relevante ale Directivei 1999/5/EC.



### National Restrictions

This product may be used in all EU countries (and other countries following the EU directive 1999/5/EC) without any limitation except for the countries mentioned below:

Ce produit peut être utilisé dans tous les pays de l'UE (et dans tous les pays ayant transposés la directive 1999/5/CE) sans aucune limitation, excepté pour les pays mentionnés ci-dessous:

Questo prodotto è utilizzabile in tutte i paesi EU (ed in tutti gli altri paesi che seguono le direttive EU 1999/5/EC) senza nessuna limitazione, eccetto per i paesi menzionati di seguito:

Das Produkt kann in allen EU Staaten ohne Einschränkungen eingesetzt werden (sowie in anderen Staaten die der EU Direktive 1995/5/CE folgen) mit Ausnahme der folgenden aufgeführten Staaten:

In the majority of the EU and other European countries, the 2, 4- and 5-GHz bands have been made available for the use of wireless local area networks (LANs). Later in this document you will find an overview of countries in which additional restrictions or requirements or both are applicable.

The requirements for any country may evolve. ZyXEL recommends that you check with the local authorities for the latest status of their national regulations for 2,4-GHz wireless LANs.

The following countries have restrictions and/or requirements in addition to those given in the table labeled "Overview of Regulatory Requirements for Wireless LANs":

Overview of Regulatory Requirements for Wireless LANs			
Frequency Band (MHz)	Max Power Level (EIRP) <sup>1</sup> (mW)	Indoor ONLY	Indoor and Outdoor
2400-2483.5	100		✓

#### Belgium

The Belgian Institute for Postal Services and Telecommunications (BIPT) must be notified of any outdoor wireless link having a range exceeding 300 meters. Please check <http://www.bipt.be> for more details.

Draadloze verbindingen voor buitengebruik en met een reikwijdte van meer dan 300 meter dienen aangemeld te worden bij het Belgisch Instituut voor postdiensten en telecommunicatie (BIPT). Zie <http://www.bipt.be> voor meer gegevens.

Les liaisons sans fil pour une utilisation en extérieur d'une distance supérieure à 300 mètres doivent être notifiées à l'Institut Belge des services Postaux et des Télécommunications (IBPT). Visitez <http://www.ibpt.be> pour de plus amples détails.

#### Denmark

#### France

For 2.4 GHz, the output power is restricted to 10 mW EIRP when the product is used outdoors in the band 2454 - 2483.5 MHz. There are no restrictions when used indoors or in other parts of the 2.4 GHz band. Check <http://www.arcep.fr/> for more details.

Pour la bande 2.4 GHz, la puissance est limitée à 10 mW en p.i.r.e. pour les équipements utilisés en extérieur dans la bande 2454 - 2483.5 MHz. Il n'y a pas de restrictions pour des utilisations en intérieur ou dans d'autres parties de la bande 2.4 GHz. Consultez <http://www.arcep.fr/> pour de plus amples détails.

R&TTE 1999/5/EC		
WLAN 2.4 - 2.4835 GHz		
IEEE 802.11 b/g/n		
Location	Frequency Range (GHz)	Power (EIRP)

Indoor (No restrictions)	2.4 – 2.4835	100mW (20dBm)
Outdoor	2.4 – 2.454	100mW (20dBm)
	2.454 – 2.4835	10mW (10dBm)

**Italy**

This product meets the National Radio Interface and the requirements specified in the National Frequency Allocation Table for Italy. Unless this wireless LAN product is operating within the boundaries of the owner's property, its use requires a "general authorization." Please check <http://www.sviluppoeconomico.gov.it/> for more details.

Questo prodotto è conforme alla specifiche di Interfaccia Radio Nazionali e rispetta il Piano Nazionale di ripartizione delle frequenze in Italia. Se non viene installato all'interno del proprio fondo, l'utilizzo di prodotti Wireless LAN richiede una "Autorizzazione Generale". Consultare <http://www.sviluppoeconomico.gov.it/> per maggiori dettagli.

**Latvia**

The outdoor usage of the 2.4 GHz band requires an authorization from the Electronic Communications Office. Please check <http://www.esd.lv> for more details.

2.4 GHz frekvenču joslas izmantošanai ārpus telpām nepieciešama atļauja no Elektronisko sakaru direkcijas. Vairāk informācijas: <http://www.esd.lv>.

**Notes:**

1. Although Norway, Switzerland and Liechtenstein are not EU member states, the EU Directive 1999/5/EC has also been implemented in those countries.
2. The regulatory limits for maximum output power are specified in EIRP. The EIRP level (in dBm) of a device can be calculated by adding the gain of the antenna used (specified in dBi) to the output power available at the connector (specified in dBm).

**List of national codes**

COUNTRY	ISO 3166 2 LETTER CODE	COUNTRY	ISO 3166 2 LETTER CODE
Austria	AT	Malta	MT
Belgium	BE	Netherlands	NL
Cyprus	CY	Poland	PL
Czech Republic	CR	Portugal	PT
Denmark	DK	Slovakia	SK
Estonia	EE	Slovenia	SI
Finland	FI	Spain	ES
France	FR	Sweden	SE
Germany	DE	United Kingdom	GB
Greece	GR	Iceland	IS
Hungary	HU	Liechtenstein	LI
Ireland	IE	Norway	NO
Italy	IT	Switzerland	CH
Latvia	LV	Bulgaria	BG
Lithuania	LT	Romania	RO
Luxembourg	LU	Turkey	TR

**Safety Warnings**

- Do NOT use this product near water, for example, in a wet basement or near a swimming pool.
- Do NOT expose your device to dampness, dust or corrosive liquids.
- Do NOT store things on the device.
- Do NOT install, use, or service this device during a thunderstorm. There is a remote risk of electric shock from lightning.
- Connect ONLY suitable accessories to the device.
- Do NOT open the device or unit. Opening or removing covers can expose you to dangerous high voltage points or other risks. ONLY qualified service personnel should service or disassemble this device. Please contact your vendor for further information.
- Make sure to connect the cables to the correct ports.
- Place connecting cables carefully so that no one will step on them or stumble over them.
- Always disconnect all cables from this device before servicing or disassembling.
- Use ONLY an appropriate power adaptor or cord for your device. Connect it to the right supply voltage (for example, 110V AC in North America or 230V AC in Europe).
- Do NOT allow anything to rest on the power adaptor or cord and do NOT place the product where anyone can walk on the power adaptor or cord.
- Do NOT use the device if the power adaptor or cord is damaged as it might cause electrocution.
- If the power adaptor or cord is damaged, remove it from the device and the power source.
- Do NOT attempt to repair the power adaptor or cord. Contact your local vendor to order a new one.
- Do not use the device outside, and make sure all the connections are indoors. There is a remote risk of electric shock from lightning.
- Do NOT obstruct the device ventilation slots, as insufficient airflow may harm your device.
- Use only No. 26 AWG (American Wire Gauge) or larger telecommunication line cord.
- Antenna Warning! This device meets ETSI and FCC certification requirements when using the included antenna(s). Only use the included antenna(s).
- If you wall mount your device, make sure that no electrical lines, gas or water pipes will be damaged.
- This product is for indoor use only (utilisation intérieure exclusivement).



- Do not use this product near water for example, near a bathtub, washbowl, kitchen sink or laundry tub, in a wet basement or near a swimming pool.
- Avoid using a telephone (other than a cordless type) during an electrical storm. There may be a remote risk of electric shock from lightning.
- Do not use the telephone to report a gas leak in the vicinity of the leak.

Your product is marked with this symbol, which is known as the WEEE mark. WEEE stands for Waste Electronics and Electrical Equipment. It means that used electrical and electronic products should not be mixed with general waste. Used electrical and electronic equipment should be treated separately.





# Index

## A

ACS [175](#)  
activation  
  port binding [126](#)  
  SSID [59](#)  
  wireless LAN  
    scheduling [66](#)  
administrator password [19](#)  
anti-probing [141](#)  
Asynchronous Transfer Mode, see ATM  
ATM [205](#)  
  MBS [40, 45](#)  
  PCR [40, 45](#)  
  QoS [39, 45](#)  
  SCR [40, 45](#)  
  status [205](#)  
authentication [69, 70](#)  
  RADIUS server [70](#)  
Auto Configuration Server, see ACS [175](#)  
automatic logout [20](#)

## B

backup  
  configuration [187](#)  
bandwidth management [105](#)  
Basic Service Set, see BSS  
blinking LEDs [17](#)  
broadcast [32](#)  
BSS [71](#)  
  example [72](#)

## C

CA [159](#)  
CBR [39, 45](#)  
certificate

  factory default [162](#)  
certificates [159](#)  
  CA [159](#)  
  replacing [162](#)  
  storage space [162](#)  
  thumbprint algorithms [161](#)  
  thumbprints [161](#)  
  trusted CAs [163](#)  
  verifying fingerprints [160](#)  
Certification Authority, see CA  
certifications [213](#)  
  notices [213](#)  
  viewing [214](#)  
channel scan [55](#)  
channel, wireless LAN [52](#)  
CLI [13](#)  
client list [80](#)  
Command Line Interface, see CLI  
compatibility, WDS [64](#)  
configuration [91](#)  
  backup [187](#)  
  IP alias [81](#)  
  IP precedence [112](#)  
  IP/MAC filter [134, 135](#)  
  reset [188](#)  
  restoring [188](#)  
  static route [104](#)  
  WAN [34](#)  
connection  
  on demand [44](#)  
copyright [213](#)  
CoS [116](#)  
CTS threshold [69](#)  
customized services [146, 148](#)

## D

data fragment threshold [68, 69](#)  
DDoS [140](#)  
default LAN IP address [19](#)

Denials of Service, see DoS  
DHCP [29](#), [76](#), [91](#), [131](#)  
diagnostic [203](#)  
Differentiated Services, see DiffServ  
DiffServ (Differentiated Services)  
    marking rule [116](#)  
DiffServ Code Point, see DSCP  
disclaimer [213](#)  
DNS [76](#), [198](#)  
documentation  
    related [2](#)  
domain name system, see DNS  
DoS [140](#)  
    three-way handshake [149](#)  
    thresholds [141](#), [149](#)  
DS (Differentiated Services) [116](#)  
DS field [116](#)  
DSCP [112](#), [116](#)  
DSL connections, status [205](#)  
dynamic DNS [131](#)  
Dynamic Host Configuration Protocol, see DHCP  
DYNDNS wildcard [131](#)

## E

encapsulation [32](#), [36](#), [42](#)  
    ENET ENCAP [48](#)  
    PPPoA [49](#)  
    PPPoE [49](#)  
    RFC 1483 [49](#)  
encryption [70](#)  
ENET ENCAP [36](#), [42](#), [48](#)  
Extended Service Set IDentification [54](#), [60](#)

## F

FCC interference statement [213](#)  
File Sharing [87](#)  
filters [133](#)  
    IP/MAC [133](#), [135](#)  
    IP/MAC filter  
        configuration [134](#), [135](#)  
    MAC address [61](#)

firewalls [139](#)  
    actions [145](#)  
    address types [146](#)  
    anti-probing [141](#)  
    customized services [146](#), [148](#)  
    DDoS [140](#)  
    default action [143](#)  
    DoS [140](#)  
        thresholds [141](#), [149](#)  
    ICMP [141](#)  
    LAND attack [140](#)  
    logs [145](#)  
    P2P [150](#)  
    packet direction [143](#)  
    Ping of Death [140](#)  
    rules [151](#)  
    security [152](#)  
    SYN attack [140](#)  
    three-way handshake [149](#)  
    triangle route [153](#)  
        solutions [154](#)  
firmware [185](#)  
fragmentation threshold [68](#), [69](#)  
FTP [13](#), [118](#), [194](#)

## G

Guide  
    Quick Start [2](#)

## H

host [173](#)  
host name [28](#)

## I

IANA [92](#)  
ICMP [141](#), [199](#)  
IGMP [32](#), [79](#)  
importing trusted CAs [163](#)  
install UPnP [92](#)  
    Windows Me [92](#)

- Windows XP [94](#)
- Internet
  - wizard setup [25](#)
- Internet access
  - wizard setup [25](#)
- Internet Assigned Numbers Authority
  - See IANA
- Internet Control Message Protocol, see ICMP
- Internet Group Management Protocol, see IGMP
- IP address [29](#), [32](#), [44](#), [50](#), [91](#)
  - default [19](#)
- IP alias [81](#)
  - configuration [81](#)
- IP pool [79](#)
- IP pool setup [91](#)
- IP precedence [112](#)
  - configuration [112](#)
- IP/MAC filter [133](#), [135](#)
  - configuration [134](#), [135](#)

## L

- LAN [75](#)
  - and USB printer [90](#)
  - client list [80](#)
  - IP alias [81](#)
    - configuration [81](#)
  - MAC address [80](#)
  - multicast [79](#)
- LAN TCP/IP [91](#)
- LAND attack [140](#)
- limitations
  - wireless LAN [71](#)
- Local Area Network, see LAN
- login
  - passwords [19](#)
- logout [20](#)
  - automatic [20](#)
- logs [181](#)
  - firewalls [145](#)

## M

- MAC [29](#), [30](#)
- MAC address [62](#), [80](#)
  - filter [61](#)
- MAC authentication [61](#)
- Management Information Base (MIB) [196](#)
- Maximum Burst Size, see MBS
- Maximum Transmission Unit, see MTU
- MBS [40](#), [45](#)
- MBSSID [72](#)
- Media Access Control, see MAC Address
- model name [28](#)
- MTU [40](#)
- multicast [32](#), [39](#), [79](#)
  - IGMP [32](#)
- Multiple BSS, see MBSSID
- multiplexing [36](#), [43](#), [49](#)
  - LLC-based [49](#)
  - VC-based [49](#)

## N

- nailed-up connection [38](#), [44](#)
- NAT [44](#), [92](#), [119](#)
  - default server [121](#)
  - definitions [123](#)
  - DMZ host [121](#)
  - how it works [123](#)
  - remote management [192](#)
  - what it does [123](#)
- Network Address Translation, see NAT

## O

- other documentation [2](#)

## P

- P2P [150](#)
- packet direction [143](#)

- passwords [19](#)
- PCR [40, 45](#)
- Peak Cell Rate, see PCR
- PHB [116](#)
- Ping of Death [140](#)
- port binding [125](#)
  - activation [126](#)
  - summary screen [126](#)
- ports [17](#)
- PPPoA [36, 42, 49](#)
- PPPoE [36, 42, 49](#)
- preamble [68, 69](#)
- Printer Server [89](#)
- printer sharing
  - and LAN [90](#)
  - requirements [90](#)
- probing, firewalls [141](#)
- product registration [214](#)
- push button [15](#)

## Q

- QoS [105, 116](#)
  - DSCP [112](#)
  - IP precedence [112](#)
- Quality of Service, see QoS
- Quick Start Guide [2, 19](#)

## R

- RADIUS server [70](#)
- registration
  - product [214](#)
- related documentation [2](#)
- remote management [191](#)
  - DNS [198](#)
  - FTP [194](#)
  - ICMP [199](#)
  - NAT [192](#)
  - TR-069 [175](#)
  - WWW [192](#)
- Remote Procedure Calls, see RPCs [175](#)
- reset [16, 188](#)

- restart [189](#)
- restoring configuration [188](#)
- RFC 1483 [36, 42, 49](#)
- RFC 1631 [117](#)
- RFC 3164 [167](#)
- RIP [39](#)
- Routing Information Protocol, see RIP
- RPPCs [175](#)
- RTS threshold [69](#)

## S

- scan [55](#)
- scheduling
  - wireless LAN [66](#)
- SCR [40, 45](#)
- security
  - network [152](#)
  - wireless LAN [69](#)
- Security Parameter Index, see SPI
- Service Set [54, 60](#)
- setup
  - IP alias [81](#)
  - IP precedence [112](#)
  - IP/MAC filter [134, 135](#)
  - static route [104](#)
  - WAN [34](#)
- Simple Network Management Protocol, see SNMP
- SNMP [195](#)
  - agents [196](#)
  - Manager [196](#)
  - managers [196](#)
  - MIB [196](#)
  - network components [196](#)
  - versions [195](#)
- SPI [140](#)
- SSID [70](#)
  - activation [59](#)
  - MBSSID [72](#)
- static route [101](#)
  - configuration [104](#)
- status [27](#)
  - ATM [205](#)
  - DSL connections [205](#)
- status indicators [17](#)

subnet mask [91](#)  
 Sustain Cell Rate, see SCR  
 SYN attack [140](#)  
 syslog  
   protocol [167](#)  
   severity levels [167](#)  
 system  
   firmware [185](#)  
   passwords [19](#)  
   reset [16](#)  
   status [27](#)  
 System Info [28](#)  
 system name [28](#)

## T

three-way handshake [149](#)  
 thresholds  
   data fragment [68, 69](#)  
   DoS [141, 149](#)  
   P2P [150](#)  
   RTS/CTS [69](#)  
 TR-069 [13, 175](#)  
   ACS setup [175](#)  
 trademarks [213](#)  
 triangle route [153](#)  
   solutions [154](#)  
 trusted CAs, and certificates [163](#)

## U

UBR [39, 45](#)  
 unicast [32](#)  
 Universal Plug and Play, see UPnP  
 upgrading firmware [185](#)  
 UPnP [82](#)  
   forum [76](#)  
   security issues [76](#)

## V

VBR-nRT [39, 45](#)

VBR-RT [39, 45](#)  
 VCI [36, 43, 50](#)  
 version  
   firmware  
     version [29](#)  
 Virtual Channel Identifier, see VCI  
 Virtual Path Identifier, see VPI  
 VPI [36, 43, 50](#)

## W

WAN [31](#)  
   ATM QoS [39, 45](#)  
   encapsulation [32, 36, 42](#)  
   IGMP [32](#)  
   IP address [32, 44, 50](#)  
   mode [36, 42](#)  
   MTU [40](#)  
   multicast [32, 39](#)  
   multiplexing [36, 43, 49](#)  
   nailed-up connection [38, 44](#)  
   NAT [44](#)  
   RIP [39](#)  
   setup [34](#)  
   VCI [36, 43, 50](#)  
   VPI [36, 43, 50](#)  
 warranty [214](#)  
   note [214](#)  
 WDS [64, 72](#)  
   compatibility [64](#)  
   example [73](#)  
 Web Configurator [19](#)  
 web configurator [13](#)  
   passwords [19](#)  
 WEP [71](#)  
 WEP Encryption [56, 57](#)  
 Wide Area Network, see WAN  
 Wireless Distribution System, see WDS  
 wireless LAN [51](#)  
   authentication [69, 70](#)  
   BSS [71](#)  
     example [72](#)  
   channel [52](#)  
   encryption [70](#)  
   example [52](#)  
   fragmentation threshold [68, 69](#)

- limitations [71](#)
- MAC address filter [61](#)
- MBSSID [72](#)
- preamble [68](#), [69](#)
- RADIUS server [70](#)
- RTS/CTS threshold [69](#)
- scheduling [66](#)
- security [69](#)
- SSID [70](#)
  - activation [59](#)
- WDS [64](#), [72](#)
  - compatibility [64](#)
  - example [73](#)
- WEP [71](#)
- WPA [71](#)
- WPA-PSK [71](#)
- WPS
  - push button [15](#)
- wireless network
  - example [51](#)
- wizard setup
  - Internet [25](#)
- WLAN [51](#)
  - auto-scan channel [55](#)
  - scheduling [66](#)
  - see also wireless.
- WPA [71](#)
- WPA-PSK [71](#)
- WPS
  - push button [15](#)