

# IPC-2605N

*The First Consumer-Friendly Network Camera*

## *User's Guide*



Edition 0.1, 6/2012

[www.zyxel.com](http://www.zyxel.com)

# ZyXEL

Copyright © 2012  
ZyXEL Communications Corporation



1	Contents	
2	Getting to know your IPC-2605N.....	6
	2.1 Package Contents .....	6
	2.2 Features .....	7
	2.3 Camera Layout.....	8
	2.4 LED Status Indicator.....	9
3	Installation.....	10
	3.1 Connecting Your IPC-2605N .....	10
	3.2 Wireless.....	11
	3.3 Wall and Ceiling Mounting .....	12
4	Initial Setup.....	13
5	Accessing your camera .....	14
	5.1 CloudEnabled™ Viewing.....	15
	5.2 Direct Viewing of your Camera (For Advanced Users).....	17
6	Configuration .....	23
	6.1 Video Settings.....	23
	6.2 Camera Settings .....	24
	6.3 Audio Settings.....	26
	6.4 User Settings .....	26
	6.5 Network Settings.....	27
	6.6 PTZ Control .....	33
	6.7 Event Setup .....	36
	6.8 Recording Setup.....	42
	6.9 Recording History.....	43
	6.10 Date.....	43
7	Event Viewer .....	44
8	Maintenance.....	45
	8.1 Information .....	45
	8.2 Log .....	45
	8.3 Maintenance.....	45
9	Troubleshooting .....	48
	9.1 Reconfiguring Your Device.....	48
	9.2 Cabling Check.....	48
	9.3 Resetting to Factory Defaults.....	49
	9.4 Trouble with Active X .....	50
	9.5 Trouble with Remote Viewing on Browser.....	52
	9.6 Symptoms, Causes, and Solutions .....	54
10	Technical Specifications .....	59
11	Open-Sourced Components .....	61

# Important Notices

## Regulatory Notice

This device complies with Part 15 of the FCC Rules. Operation is subject to the following two conditions: (1) This device may not cause harmful interference, and (2) This device must accept any interference received, including interference that may cause undesired operation.

## FCC Interference Statement

This equipment has been tested and found to comply with the limits for a Class B digital device, pursuant to Part 15 of the FCC Rules. These limits are designed to provide reasonable protection against harmful interference in a residential installation.

This equipment generates, uses, and can radiate radio frequency energy and, if not installed and used in accordance with the instructions, may cause harmful interference to radio communications. However, there is no guarantee that interference will not occur in a particular installation. If this equipment does cause harmful interference to radio or television reception, which can be determined by turning the equipment off and on, the user is encouraged to try to correct the interference by one of the following measures:

- Reorient or relocate the receiving antenna
- Increase the separation between the equipment and the receiver
- Connect the equipment to an outlet on a different circuit than the receiver is connected.
- Consult the dealer or an experienced TV/radio technician for help.

To assure continued compliance, any changes or modifications not expressly approved by the party responsible for compliance could void the user's authority to operate this equipment.

## Operation Safety

Before using this camera, please read and follow the steps below to protect your IP camera.

- Please place the IP camera on a level surface and keep it out of direct sunlight
- Keep the IP camera indoors and away from water, dust, humidity, and magnetic products
- Do not rotate your IP camera by hand. It may cause damage to the camera.
- Do not drop the IP camera, this may damage the mechanical parts of the camera.
- Do not disassemble or remodel the product, it can cause damage or fire.
- Do not shake, move, or disturb the camera when it is in operation, as such actions may result in the malfunction of the device.
- Power the camera off if it produces smoke or unusual odor.
- Do not place the IP camera around heat sources such as a Television or microwave oven.

## About This Manual

This manual is indented only for users of the ZyXEL IPC-2605N network camera.

## Conventions in this Manual

While using this manual, pay attention to symbols and notations used to draw attention to special situations, such as:



### Caution!

Information provided with this symbol is critical to prevent damage to the product or injury to the user.



### Important!

This symbol indicates instructions that a user must follow in order to complete a task.



### Note:

This symbol indicates additional information or tips to help the user operate the product.

## 2 Getting to know your IPC-2605N

### 2.1 Package Contents

Before setup, ensure your package contains all contents. If anything is missing, contact your distributor.

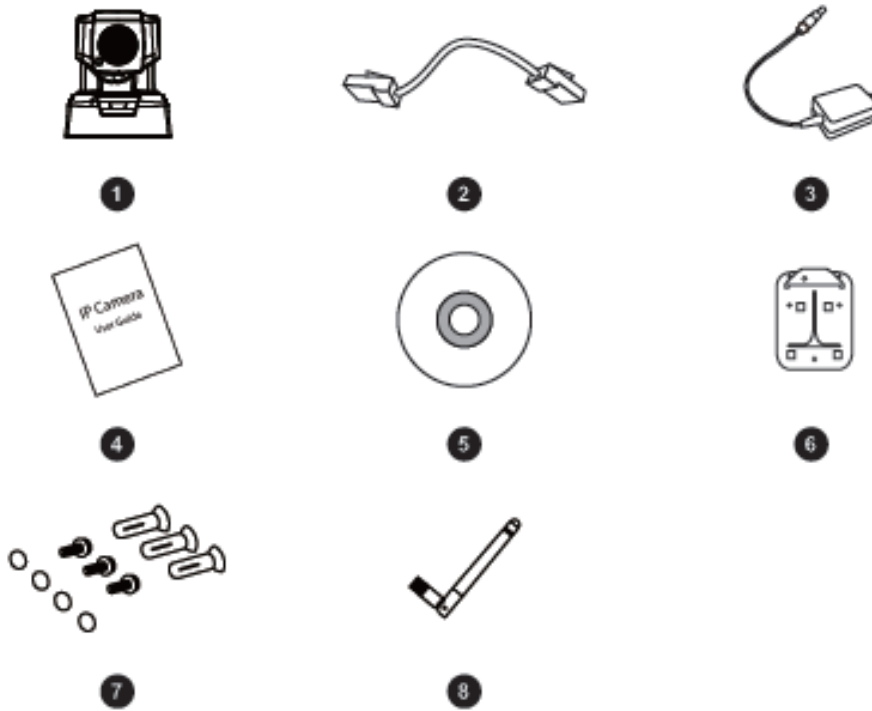

Number	Contents
1	IPC-2605N Network Camera
2	Ethernet Cable
3	Power Adapter
4	Quick Installation Guide
5	Install Disk
6	Wall/Ceiling Mount Plate
7	Camera Pad x4, Screw Mount x3, Screw x3
8	Detachable Wireless Antenna

## 2.2 Features

ZyXEL's IPC-2605N sports an advanced 340-degree pan and 100-degree tilt mechanical design, ideal for deployment in warehouses, offices, restaurant, lobby area, or anywhere it's important to have a wide field of view.

- Pan/Tilt with 10x digital zoom
- Day/Night functionality
- Network bandwidth detection
- SMS & E-Mail Notification
- Built-in microphone
- Two-way audio communication
- Plug n Play installation

## 2.3 Camera Layout

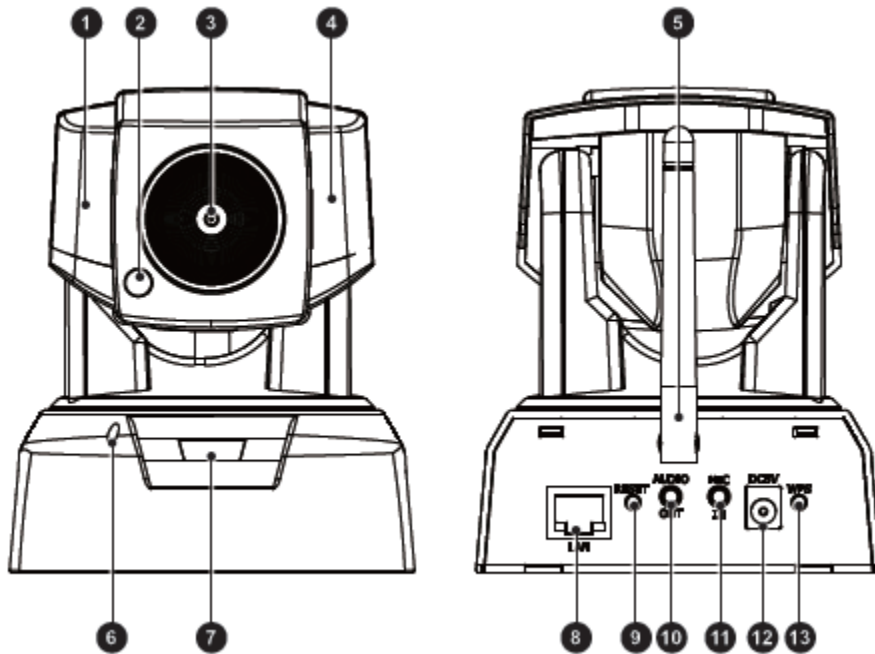

Number	Contents
1	IR LEDs x6 (12 in total)
2	Light Sensor
3	Lens 2.0 mm, F2.8, fixed iris
4	IR LEDs x6 (12 in total)
5	Detachable Wireless Antenna
6	Microphone
7	LED Status Indicator
8	Ethernet Port
9	Reset Button
10	Audio Output
11	Microphone In
12	Power Connector
13	WPS Button



## 2.4 LED Status Indicator

The LED status indicator consists of a blue status indicator and red IR LEDs. The LEDs appear as follows:



*Red IR LEDs (Left), Blue Status LED (Right)*

When the IP camera is turned on, the LEDs will light in the following patterns:

Red LEDs	Blue LED	Indication
On	On	System booting
Off	On	Successfully established network connection
On	Off	Performing hardware test
Off	Off	Powered off
Blinking (Every 0.5 seconds)	Off	Failed to connect to network/Failed to establish WPS connection
Off	Blinking (Every 0.5 seconds)	Attempting to establish a WPS connection
Off	Blinking (Every 0.2 seconds)	Successfully established a WPS connection
Blinking	Blinking	Attempting to establish a network connection

## 3 Installation

### 3.1 Connecting Your IPC-2605N

The picture below illustrates the basic connection of your IPC-2605N camera:

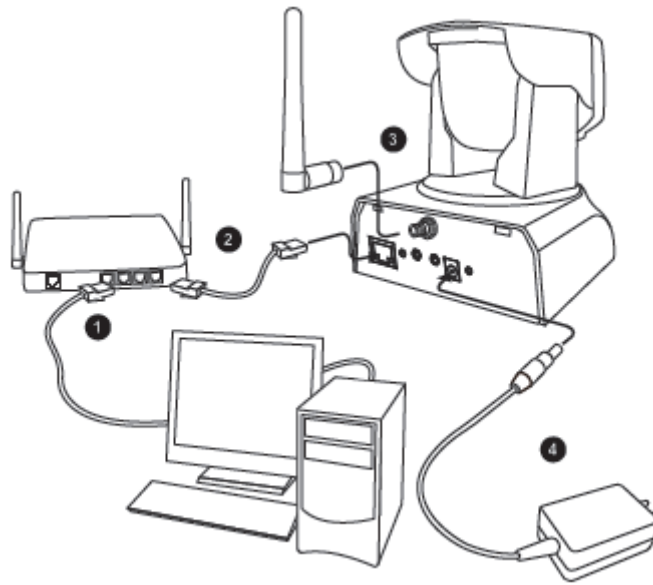

The following table describes the numbered items:

Number	Contents
①	Ethernet cable from PC to hub/router.
②	Ethernet cable from router to camera.
③	Wireless antenna. Attach to connector on the back of the camera.
④	Power: Attach the power adapter to the camera's power port, and connect the plug to a power outlet.



#### Important!

- Do not rotate your camera by hand. Doing so can damage the camera
- After unplugging the camera's power cable, wait at least 4 seconds before restoring power to the camera.

## 3.2 Wireless

While using the ZyXEL Wireless antenna, you'll be able to connect your camera to your network via WiFi. Keep in mind that you can only have one active connection at any given time – either through LAN or a wireless network.

Note: If the wireless connection drops or seems slow, try moving your IP camera closer to the wireless access point for an improved signal.



### Important!

- Obstacles between your camera and wireless access point, particularly if made of materials like wood, cement, or metal, will weaken the strength of your wireless signal.
- Other 2.4 GHz devices such as microwaves and wireless phones may degrade performance. Attempt to keep your camera away from such devices.

### 3.3 Wall and Ceiling Mounting

- 1 Screw the mounting plate into the mounting surface

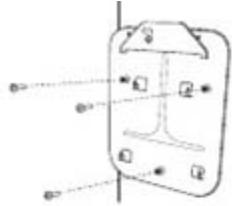

- 2 Secure the IP camera to the mounting plate

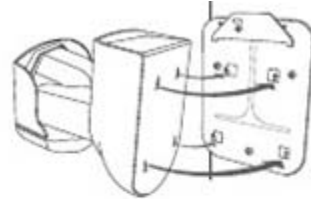

- 3 Loosen the top screw on the trapezoid-shaped fastening bracket.

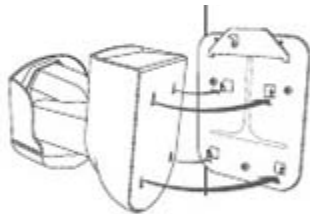

- 4 Insert the tips of the fastening bracket into the IP camera as shown.



- 5 Return fastening bracket to its original position.



- 6 Use a screwdriver to tighten the fastening bracket firmly back in place.



## 4 Initial Setup

Before running the setup utility, make sure you have the IP Camera properly connected. To begin setup, insert the installation CD supplied with the camera into the CD-ROM drive of the viewing PC, and the eaZy Wizard utility will start and guide you during the installation process of the hardware and software for your IP camera.

## 5 Accessing your camera

Your camera's video feeds can be accessed in a number of ways, as follows.

- 1) Your camera is CloudEnabled™ and can be viewed from any PC running a modern web browser with the Flash plug-in installed. When you first setup your camera using the included CD, it will register your camera with iSecurity+. Simply point your web browser to <http://zyxel.isecurityplus.com> and login with the username and password you created during setup. You can also download the iSecurity+ app from iTunes or the Android Market to view your camera from a smartphone or tablet. This is by far the easiest way to view & control your camera.
- 2) View the live video stream on the web browser of any computer. This feature is compatible with all Desktops, Laptops, or Tablets modern browser. This is the easiest way to view the video of the IP camera and requires little learning time. This may require advanced configuration of your home router in order to view the camera remotely.  
(Note: Non-IE web browsers, such as FireFox and Safari, are supported after a VLC plug-in installation.)
- 3) View the live video stream on the mobile web browser of your iPhone/iPod, Android phone, BlackBerry, PDA, or any other mobile phones with a built-in web browser. Through live Motion-JPEG video streaming, you can view your ZyXEL IP camera while on the go. This may require advanced configuration of your home router in order to view the camera remotely.  
(Note: This functionality requires that a secondary video stream be enabled. Motion-JPEG mode only offers live viewing function.)

## 5.1 CloudEnabled™ Viewing

### 5.1.1 Accessing via iSecurity+ Smartphone App

iSecurity+ is an iOS/Android App designed to allow you to quickly and easily access, control, and view your camera's video feeds from anywhere.

The iSecurity+ can be located on the App Store and Android Market from your device by searching "iSecurity+," or directly from your computer at the Android Market (<http://market.android.com>) for Android devices, or the App Store through iTunes (<http://www.apple.com/itunes>).

### 5.1.2 Accessing via iSecurity+ Web App

Once a second stream has been successfully enabled on your ZyXEL camera, you can use the iSecurity+ web app to view your video feeds. To access the app, simply navigate to <http://zyxel.isecurityplus.com/login> in your web browser.

From the login screen, simply enter the username and password you configured during the camera's initial setup (For more information, see the eaZy Setup Wizard).

The following screen will appear:

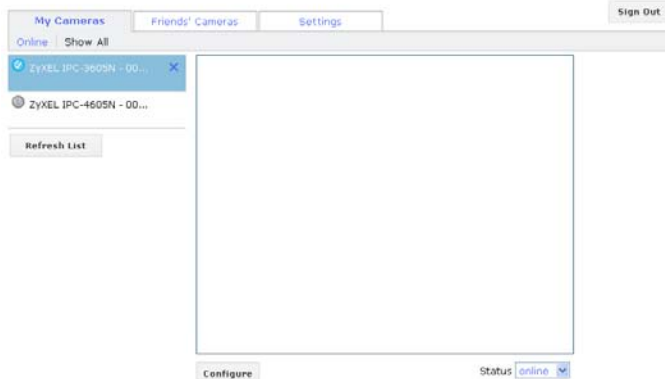

To configure your camera's settings, click the Configure button beneath the video display.

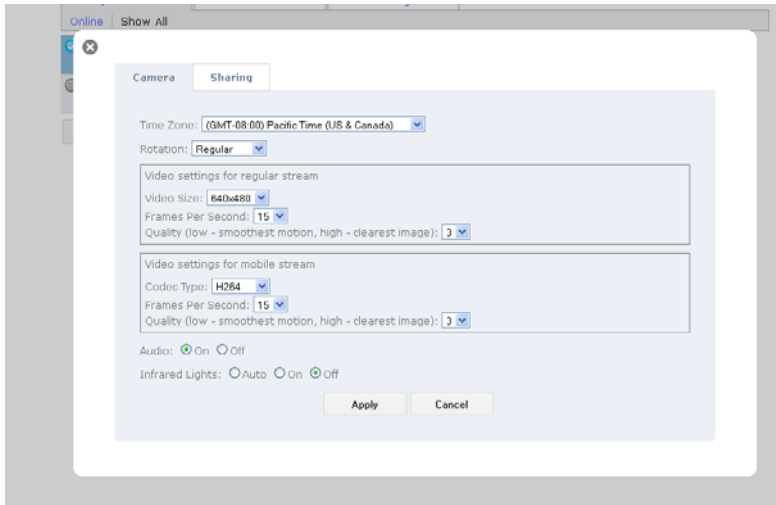

This page allows you to easily adjust your camera's time zone, display and audio settings, and infrared lighting.

Sharing options can be accessed from the Sharing tab at the top of the screen.

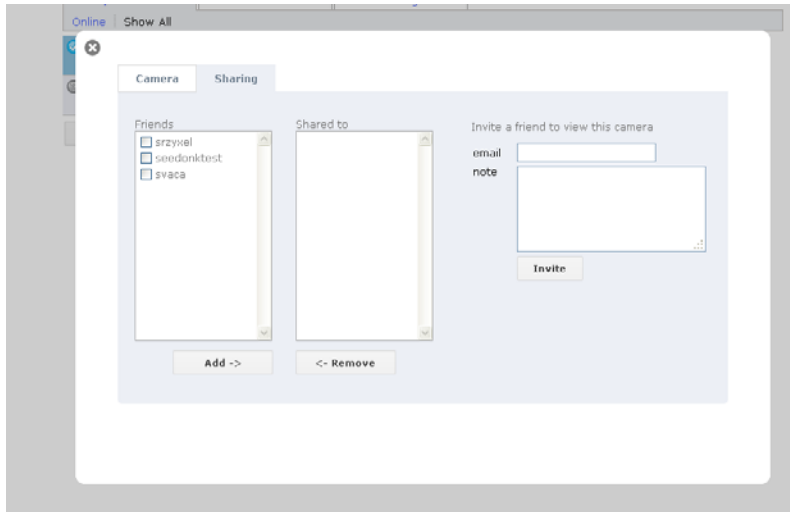



## 5.2 Direct Viewing of your Camera (For Advanced Users)

### 5.2.1 Accessing via PC web browser

Users can access their video feeds and camera management tools easily through any web browser. Simply follow these steps.

- 1) Open any web browser (Internet Explorer, Safari, Firefox, Chrome, etc.)
- 2) Type in your camera's IP address (eg. 192.168.1.11. This number can be easily found by using the eaZy set up Wizard utility)
- 3) A dialogue box will appear requesting a user name and password. (Default username and password are both 'admin')



- 4) After entering a valid username and password, your browser will prompt installation of camera software from ZyXEL Communications Corporation. Click on the warning message, and choose to Install ActiveX
- 5) A confirmation dialogue box will appear. Select [Install] twice to install both USActiveX.cab and IPCamClientActiveX.cab.



Note: ZyXEL ActiveX only supports 32-Bit browsers. If you're running a 64-bit Operating System, you'll still have to run the 32-Bit version of your browser in order to access your camera.

- 6) If a security alert appears, select "Unblock."



7) You're now ready to view and manage your camera from your web browser.



Note: If your IP camera falls behind a firewall, you will need to enable ports 80 and 554 in your firewall and link them to the internal IP address of the camera. Should you have more than one, increase the values above by 1 (For example, the second camera would have ports 81 and 555.)

### 5.2.1.1 Page Layout

On the first page, you can see the basic control panel on the top and left, and live video on the right hand side. Click the ▲ icon to collapse control panels.

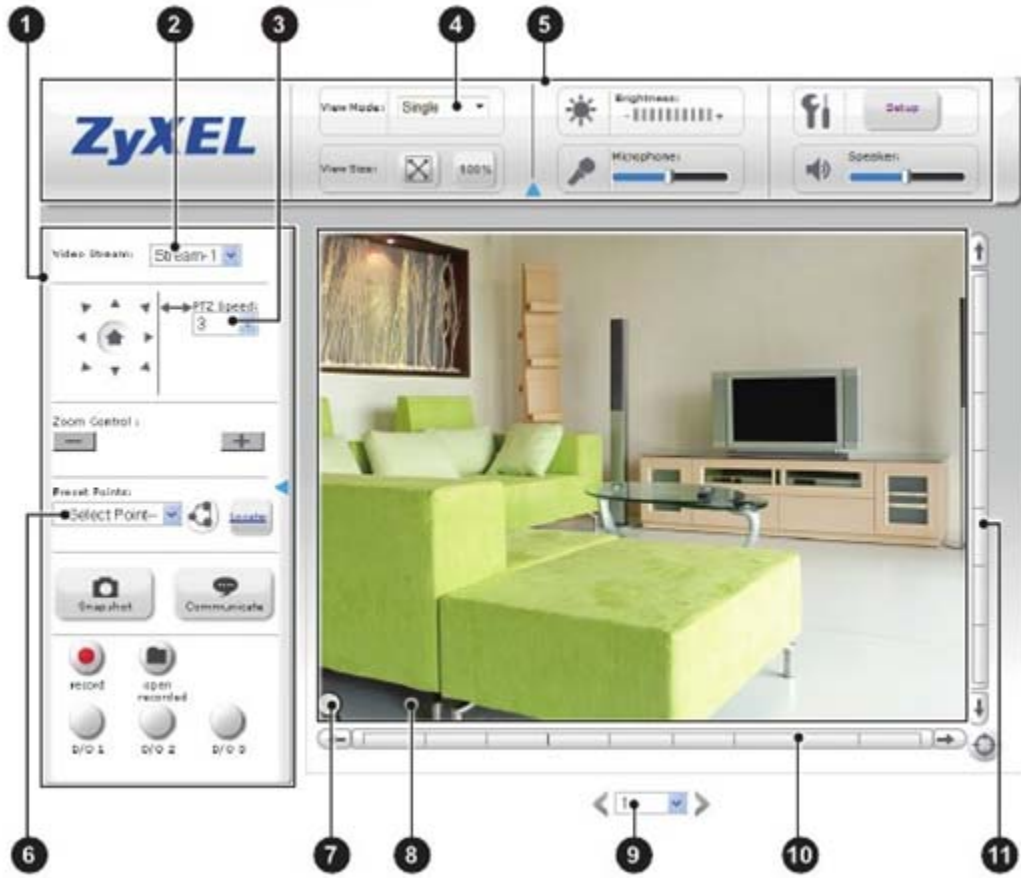













The following table describes the labels found on this screen.





Number	Label	Description
1	Left control panel	provides control over video recording, voice communication, I/O, Pan/Tilt, and snapshot
2	Video stream	Allows you to change between stream-1 and stream-2. (Stream 2 can be enabled and configured in [Settings] > [Video])
3	PTZ speed	set the pan and tilt speed on a scale of 1 to 10
4	Video mode selection	Allows you to change the video display between single, multi, and auto scan.
5	Top control panel	Allows you to adjust Brightness, Speaker volume, and microphone volume.
6	Preset Point	Changing the preset point allows you move the camera to a pre-defined point. (Preset points can be configured in [setup] > [PTZ control])
7	Magnifier	Click on the magnifier icon to bring up digital zoom control.
8	Live video pane	Live video stream. Click any spot on the video window to pan/tilt. You can switch to full-screen mode by right-

		clicking on the video pane and selecting “Fullscreen”
9	Channel	Select a channel from the drop-down list, or click on the arrow icon to switch to the next/previous channel.
10	X-Axis	Adjust the camera’s position on the X-Axis
11	Y-Axis	Adjust the camera’s position on the Y-Axis

## 5.2.1.2 Icons

The following table describes the icons found on this screen.

Icon	Label	Description
	Fit browser	Resizes the live video pane to fit your browser window
	Actual size	Resizes the live video pane to the original size
	Brightness	Adjusts the camera’s brightness.
	Microphone Volume	Adjust microphone volume. Click the icon to mute the built-in microphone
	Setup	Click the [Setup] button to access the settings for you camera.
	Speaker Volume	Adjust speaker volume. Click this icon to mute the built-in speaker
	Control	Direction control buttons to rotate the camera, and a home button for returning to the preset position.
	Patrol Mode	Use patrol mode to make the camera rotate through different predefined camera positions. Predefined positions can be defined in [Setup] > [PTZ control] > [Patrol mode]
	Locate	Shows your camera’s position on the X-Axis and Y-Axis
	Snapshot	Click the snapshot button to take a snapshot from live view. A preview window will pop up. Right-click and choose ‘Save Image As...’ to save the snapshot to your PC.
	Communicate	Allows you to speak into your PC microphone and broadcast through the camera’s speaker. See the Voice Communication section for details.
	Digital Out	Triggers the alarm and siren connected to the Digital Out port of your camera
	Record	Record live video by pressing the [Record] button. (If your computer cannot play .mkv files, download and install VLC media player from the internet.)

	Open	Open a file browser to search and playback video files captured by the camera
	Digital Zoom	Digital zoom button. Available zoom: 1~10x
	Switch Channel	Click the Left/Right arrow to switch channel
	Crosshair/Arrow	The crosshair allows you to move your cursor over a point on the live view and make that point the new center of view. The arrow moves the camera in the direction of the mouse click.

### 5.2.1.3 Enable Digital Zoom

To enable the digital zoom feature:

- 1) Click on the magnifier icon located on the lower-left corner of the real-time video display. The digital zoom control window will appear.

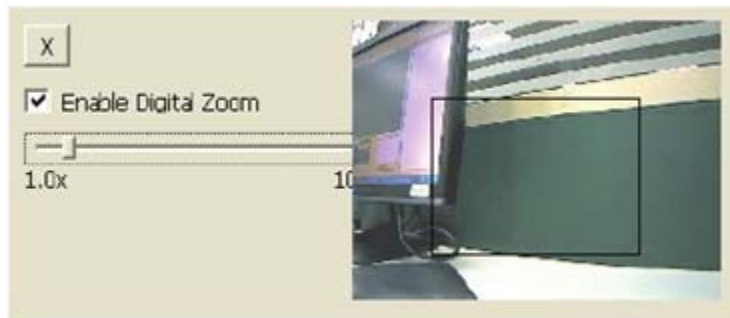

- 2) Check [Enable Digital Zoom], and set the desired zoom by dragging the slider bar. Then set the area to be enlarged by dragging the black square shown above. Click on the [X] button or press the [Esc] key to save the changes and/or close the previous window.

### 5.2.1.4 Voice Communication

Pressing the  button allows you to speak into your PC microphone and broadcast through the camera's speaker or audio line out. To talk through the external

speaker connected to the IP camera, place your cursor on the  button, right-click, and select [Settings] to choose input device and input source.

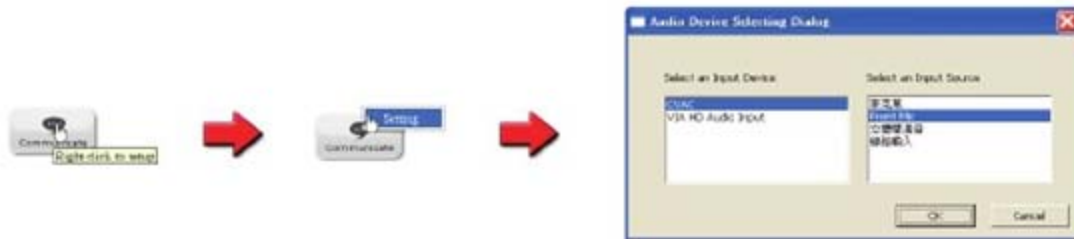

With the device configured, clicking the  will allow you to speak through your microphone and be heard from the camera for 90 seconds.



Note:

When using the voice communication feature, you may experience various degrees of delay between transmission from the computer and playback on the camera, depending on the condition of your network environment.

## 6 Configuration

### 6.1 Video Settings

The Video Settings screen consists of all the basic settings options. To access the main setup page, click the setup button at the top right in the live view screen. You can configure detailed settings of your IP camera here.

**ZyXEL** LiveView Setup Event Viewer Maintenance

#### Video settings

Turbo Picture (offers best picture quality up to 1.3 megapixels at 15 fps)  
 Motion Adaptive (offers highest frame rate up to 30 fps at a lower max resolution.)

Enable 2nd Stream(include 3GPP)  
Please enable 3GPP stream to allow the live view on cell phones.

**Stream-1:** Resolution: QVGA, Codec: H.264, Framerate: 15, Quality: 512Kbps

**Stream-2:**  3GPP Mode, Resolution: QVGA, Codec: Motion-JPEG, Framerate: 10, Quality: Medium

Active bandwidth management: Enable

Video preference:

Motion Smoothness Image Quality

Viewing on PC: <http://66.85.124.30>  
Viewing on Phone Browser: <http://66.85.124.30/mjpeg.html>  
You may wish to bookmark the above links in your browser for future reference.

Save Reset

The following table describes the labels found on this screen.

Label	Description
Turbo Picture	This mode provides best video quality, but frame rate is limited to 15.
Motion Adaptive	This mode provides 30FPS at a lower resolution
Enable 2 <sup>nd</sup> Stream	This enables the second stream for viewing from mobile devices.
Stream-1/Stream-2	
Resolution	Resolution settings. Options are QQVGA, QVGA, VGA, and 1080x720 (720p)
Codec	The codec used to encode video. MPEG-4 can be viewed from external devices, while H.264 uses less bandwidth.

Framerate	Framerate. 5~30 FPS. Higher framerate is more bandwidth-intensive.
Quality	Video quality settings. 64kpbs~3Mbps.
Active Bandwidth Management	Allows the IPC-2605N to intelligently change video bitrate depending on network congestion. This avoids video deterioration and frame dropping.
Video Preference	Allows you to choose between a preference toward higher quality image or a higher framerate. Click on the bar to set.
Viewing on PC	The IP to view your camera from a PC outside the network.
Viewing on Phone Browser	The address to view your camera from a mobile device.
Save	Saves current settings
Reset	Reset to defaults.

## 6.2 Camera Settings

To access the Camera Settings screen, click on ‘Camera’ on the navigation bar in the settings menu. From this page, you can control image and color related settings, as well as the IR lights of your camera.

The screenshot displays the ZyXEL Camera Setting web interface. The navigation bar at the top includes 'LiveView', 'Setup', 'Event Viewer', and 'Maintenance'. The 'Camera Setting' page is active, showing a left-hand navigation menu with options like Video, Camera, Audio, Users, Network, PTZ Control, Event Setup, Recording Setup, Recording History, Date, and Multi-Camera. The main content area is divided into several sections:

- Video Properties:** Brightness (12), Sharpness (3), Saturation (6).
- White Balance:** White Balance set to Auto.
- Backlight Compensation:** Disable.
- Flickerless:** Flickerless-60Hz.
- Exposure Control:** Auto selected, Shutter Speed 1/5s.
- Low Light Behavior:** On selected, Maximum Exposure (sec) 15 fps, Maximum Gain (dB) 8.5.
- LED Indicator:** Enable LED Indicator checked.
- IR Light Control:** Operation Mode set to Always Off. Includes options to activate/deactivate IR light on specific days of the week.
- Embed Text and Image:** Location set to Upper Left. Includes a text input field and an image upload button.
- Flip Mode:** Enable Flip Mode unchecked.

At the bottom of the page, there are 'Save' and 'Reset' buttons.



The following table describes the labels found on this screen.

Label	Description
Video Properties	
Brightness	Set image brightness (1~100)
Sharpness	Set image sharpness (1~8)
Saturation	Set image saturation (1~10)
White Balance	Set image's white balance to compensate for different lighting conditions.
Flickerless	Sets Flickerless mode. 50(default) or 60 Hz
Exposure Control	
Auto	Allow the camera to automatically control shutter speed.
Manual	Manually configure shutter speed (1/5s~1/1600s)
Low Light Behavior	
On/Off	Controls your camera's automatic behavior in low-light.
Maximum Exposure	Control shutter speed in low light. (Disable~30FPS)
Maximum Gain	Controls image gain in low light. (1~8.5dB)
LED Indicator	Turns the blue LED on the front of your camera On/Off
IR Light Control	
Operation Mode	Allows you to set when your camera's IR lights will turn on. Options include Always Off, Always On, Auto, or By Schedule.
Activate/Deactive IR light on...	Allows you to set days and times when the camera's IR lights will be active.
Embed Text and Image	
Location	Embed text in the upper left, upper right, lower left, or lower right of the video feed.
Text	Enter the text you wish to display.
Enable Flip Mode	Flips the image 180 degrees vertically. Enable this feature when the camera is mounted upside-down.

## 6.3 Audio Settings

The Audio Settings screen allows you to enable or disable audio, as well as adjust volume.

To access the Audio Settings screen, go to settings, then select Audio from the sidebar. The following screen will appear.

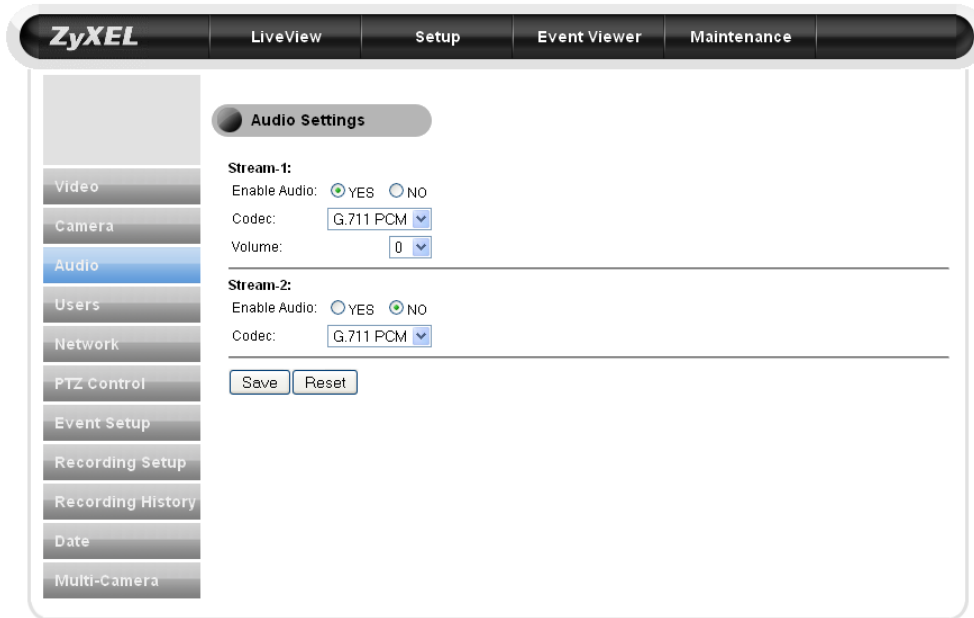

The following table describes the labels found within this screen.

Label	Description
Enable Audio	Select Yes or No to enable or disable audio.
Codec	Select the codec which will be used to encode audio.
Volume	Select volume level (1~10)
Save	Save settings
Reset	Reset to default settings

## 6.4 User Settings

The User Settings pane allows you to add, modify, or remove viewers/administrators. Viewers are only able to view live audio, and can't change any camera settings. Administrators may control the camera and make changes to settings.

To access the user settings pane, navigate to Settings, then select Users from the sidebar. The following screen will appear.

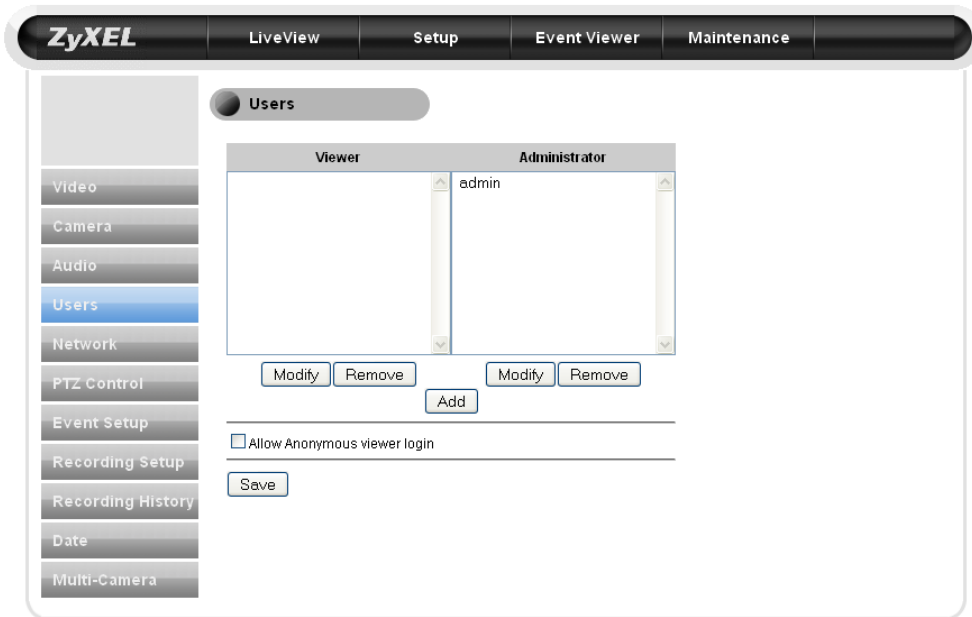

The following table describes the labels found within this screen.

Label	Description
Modify/Remove	Click here to Modify or Remove an existing viewer
Add	Click here to add a new viewer or administrator
Allow anonymous viewer login	Click here to allow anonymous viewers without requiring name and password. These viewers are restricted to viewing live video only.

When you add a new user, the following screen will appear to allow you to provide user name, password, and group type.



## 6.5 Network Settings

The Network Settings page allows you to check your network settings and make detailed adjustments.

To access the Network Settings pane, navigate to settings and select Network from the sidebar. The following screen will appear.

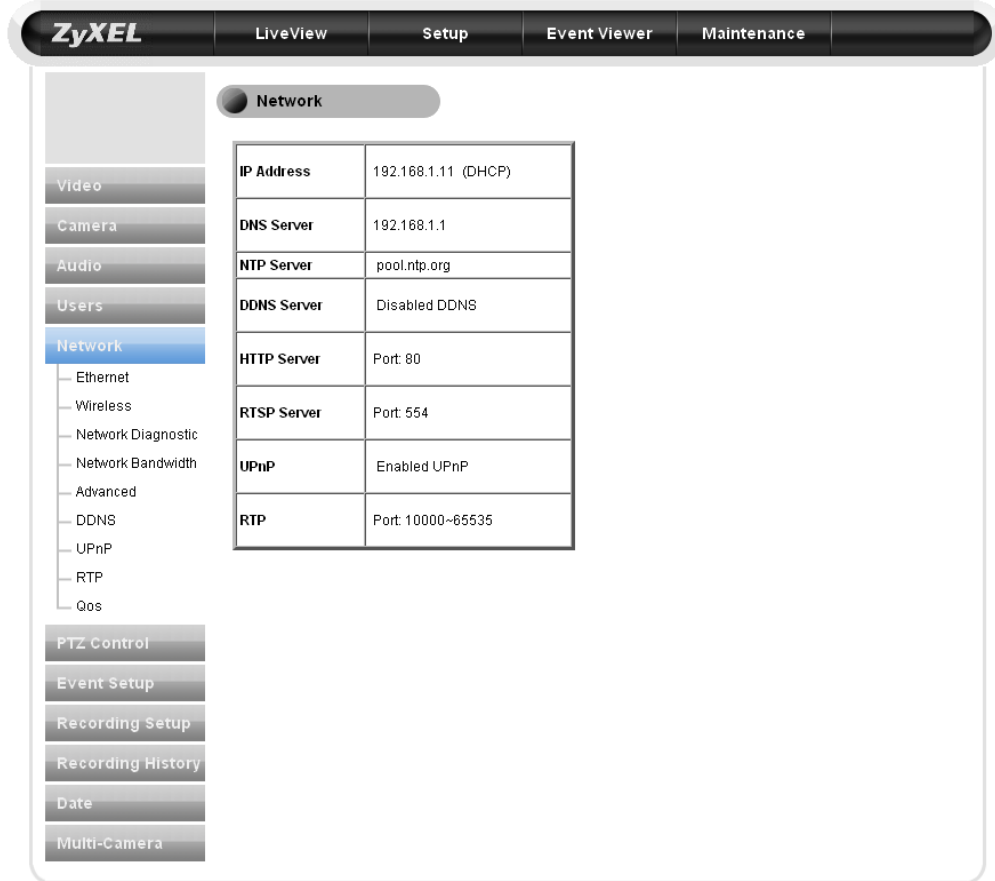

The screenshot shows the ZyXEL web interface. At the top, there is a navigation bar with the ZyXEL logo and tabs for LiveView, Setup, Event Viewer, and Maintenance. The main content area is titled "Network" and contains a table of network settings. The sidebar on the left lists various settings categories, with "Network" currently selected.

<b>IP Address</b>	192.168.1.11 (DHCP)
<b>DNS Server</b>	192.168.1.1
<b>NTP Server</b>	pool.ntp.org
<b>DDNS Server</b>	Disabled DDNS
<b>HTTP Server</b>	Port: 80
<b>RTSP Server</b>	Port: 554
<b>UPnP</b>	Enabled UPnP
<b>RTP</b>	Port: 10000-65535

## 6.5.1 Ethernet Settings

The Ethernet Settings page will allow you to choose your IP address configuration. To access the Ethernet Settings page, navigate to Settings, then select Network, and Ethernet from the sidebar. The following page will appear.

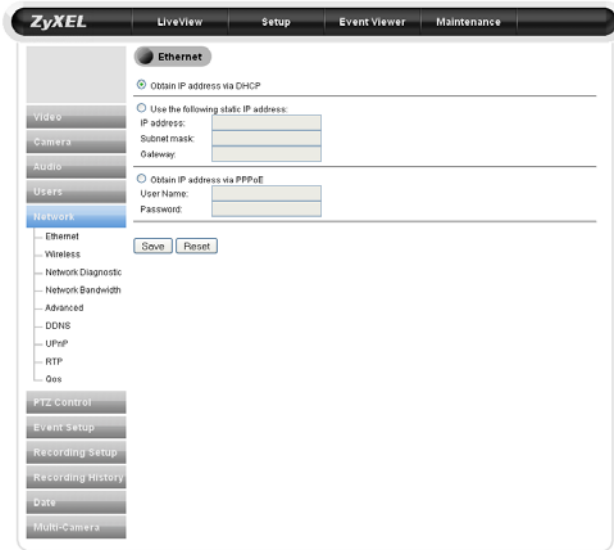

On this page, you can set the camera to obtain an IP address via DHCP (recommended), use a manual IP address, or obtain an IP address via PPPoE, for which a valid user name and password are required.

## 6.5.2 Wireless Settings

If you have installed the wireless antenna, you'll be able to set up a wireless connection from this page. To connect wirelessly, check the [Use Wireless First] box to give priority to wireless connections when the LAN network is also connected. You will also be able to choose to connect via DHCP or a static IP address and specific access point.

To access the wireless settings, navigate to Settings, then to Network on the side panel, then select Wireless from the dropdown menu. The following screen will appear.

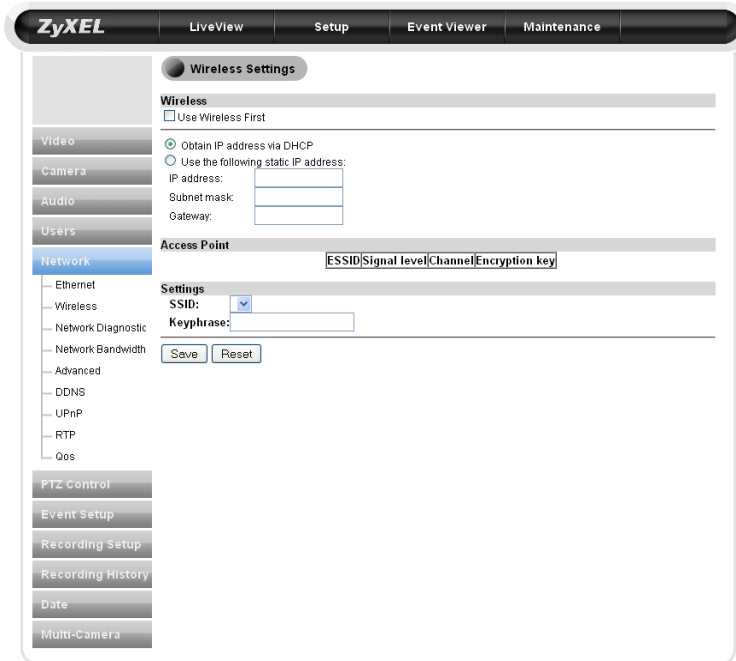

### 6.5.3 Network Diagnostic

Here you can run the diagnostic tool for your current network settings, and it will show error messages if any anomaly is detected. For further information on error messages, please refer to the troubleshooting section.

### 6.5.4 Network Bandwidth

This automatic network connection test helps users better define the appropriate video bitrate for their network. To perform the network bandwidth test:

1. Go to [Setup] > [Network], and click on [Network Bandwidth] located on the left menu to start.
2. Wait for your browser to prompt the installation of a java plug-in. Click the text to accept.

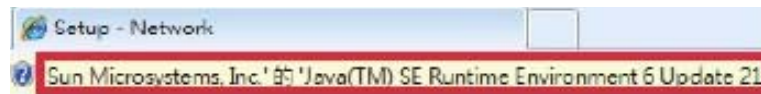

3. The camera will begin testing your connection's speed.
4. When the diagnostic is complete, the camera will advise you as to the optimal settings for your camera.



The camera's current connection speed can provide a smooth viewing of the video and you may open 10x simultaneous viewing of the 1st stream.

This message indicates that the currently connected network has the capacity to support up to 10 network cameras of identical bit rate settings (either on Stream 1 or Stream 2). If the message shows a less favorable result, go to [Setup] > [Video] to select a lower bitrate.

## 6.5.5 Advanced

This page allows you to adjust advanced network settings. To access this pane, navigate to [Setup] > [Network] > [Advanced]. The following screen will appear.

**ZyXEL** LiveView Setup Event Viewer Maintenance

**Advanced**

Obtain DNS server address via DHCP

---

Use the following DNS server address:  
Domain name:   
Primary DNS server:   
Secondary DNS server:

---

**NTP Configuration**

Obtain NTP server address via DHCP  
Network address:

Use the following NTP server address  
Network address:  (host name or IP address)

---

**HTTP Server**

HTTP Port:  (Default: 80, Range: 1~32767)

---

**RTSP Server**

RTSP over TCP  
RTSP Port:  (Default: 554)

---

Video  
Camera  
Audio  
Users  
**Network**  
— Ethernet  
— Wireless  
— Network Diagnostic  
— Network Bandwidth  
— Advanced  
— DDNS  
— UPnP  
— RTP  
— Qos  
PTZ Control  
Event Setup  
Recording Setup  
Recording History  
Date  
Multi-Camera

The following table describes the labels on this screen.

Label	Description
DNS Server	Set the DNS server to be found via DHCP, or enter a manual DNS address
NTP Configuration	NTP stands for Network Time Protocol. To synchronize your camera's clock with an NTP server, choose to either obtain an NTP server address via DHCP, or use an external NTP server (default address is pool.ntp.org)
HTTP Server	Set the HTTP port for your IP camera to be viewed and controlled from the internet. Valid port ranges fall between 1 and 32767 (Default port: 80). If your network setup requires port forwarding, refer to the Port Forwarding section of this manual.

## 6.5.6 DDNS

This page allows you to use DDNS (Dynamic Domain Name Service) to tie your camera's current IP address to a domain name, making it easier to remember. If you already have an account with DDNS or no-ip, you can input your domain name here for easier access to your camera.

To access the DDNS page, navigate to [Settings] > [Network] > [DDNS]. The following screen will appear.

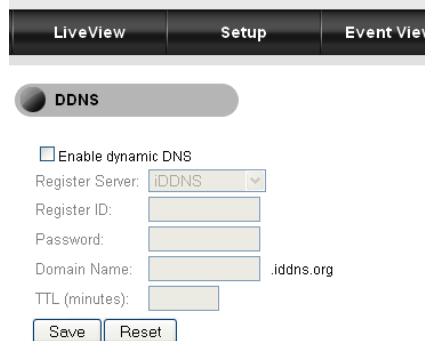

The screenshot shows a web interface with a top navigation bar containing 'LiveView', 'Setup', and 'Event View'. Below this is a 'DDNS' section with a toggle switch. The configuration options include: 'Enable dynamic DNS' (checkbox), 'Register Server' (dropdown menu showing 'iDDNS'), 'Register ID' (text input), 'Password' (text input), 'Domain Name' (text input with '.iddns.org' as a placeholder), and 'TTL (minutes)' (text input). At the bottom are 'Save' and 'Reset' buttons.

## 6.5.7 UPnP

This page allows you to enable/disable the Universal Plug and Play feature of your IP camera, as well as change your device's name. If your operating system supports UPnP, and DHCP is in use on your current network, the IPC2605 will automatically be detected and added to My Network Places in Windows. If you want to use the IGD (Internet Gateway Device) protocol on your camera, it can be enabled from this screen.



To access the UPnP screen, navigate to [Settings] > [Network] > [UPnP]. The following screen will appear.

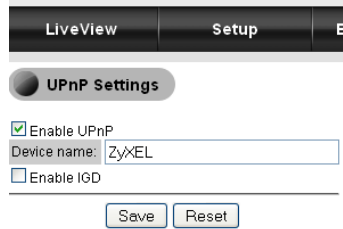

LiveView Setup E

UPnP Settings

Enable UPnP

Device name: ZyXEL

Enable IGD

Save Reset



Note: To enable UPnP on Windows, go to Add or Remove Programs in Control Panel, then click Add/Remove Windows Components, double-click “Network Services,” and check “UPnP User Interface.”

## 6.6 PTZ Control

The PTZ control page allows you to manage your camera’s preset positions and configure patrol mode to allow the camera to patrol the preset positions.

### 6.6.1 Preset Points

#### 6.6.1.1 Add Preset Points

To access the Preset Points menu, navigate to [Settings] > [PTZ Control] > [Preset Points]. The following screen will appear.

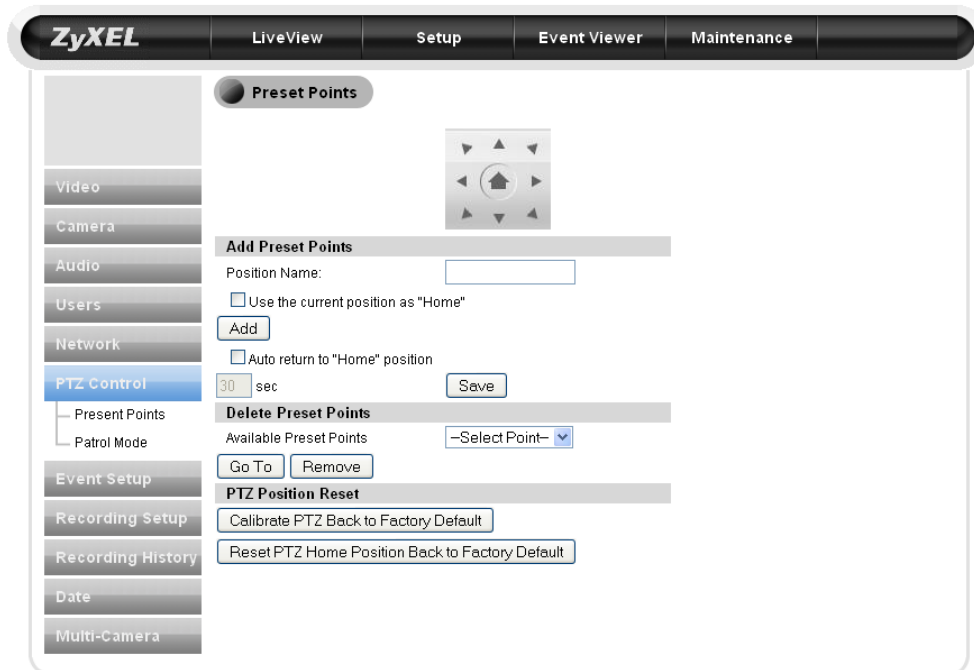

To add preset points, follow these steps:

- 1) Use the directional buttons to navigate your IP camera to the desired position
- 2) Enter a position name into the “Position Name” field.
- 3) Press the “Add” button.
  - a. If you would like to designate this as your camera’s ‘Home’ position, check the ‘Use the current position as “home”’ box.
  - b. If you would like the camera to always return to this position after moving, check the “Auto return to “Home” position” box, then enter a period of time you wish the camera to wait before returning to “Home.” (Between 30 and 300 seconds.)
- 4) Press Save.

### 6.6.1.2 Delete Preset Points

To delete a preset point, select a preset point from the “Available Preset Points” list, click [Go To] to be sure this is the correct point, then click [Remove].

### 6.6.1.3 PTZ Position Reset

The PTZ Position reset menu allows you to reset the PTZ functionality back to factory defaults. There are two reset buttons:

Button	Function
Calibrate PTZ Back to Factory Default	Calibrates Pan/Tilt position back to factory defaults
Reset PTZ Home Position Back to Factory Default	Resets the camera's Home position back to factory default.

### 6.6.2 Patrol Mode

The Patrol Mode menu allows you to define your camera's behavior while in patrol mode. To access this menu, navigate to [Settings] > [PTZ Control] > [Patrol Mode]

#### 6.6.2.1 Patrol Ordering

After you have created preset points, you'll be able to configure how long the camera will stay in each position while in patrol mode. To set the patrol order, check and select preset positions from the drop-down menu, then enter the duration for each preset position. Press [Save] to apply settings.

Patrol Ordering

<input checked="" type="checkbox"/>	mk1	Duration: 5	Second(s)
<input checked="" type="checkbox"/>	mk2	Duration: 10	Second(s)
<input checked="" type="checkbox"/>	home	Duration: 3	Second(s)

Save Reset

#### 6.6.2.2 Patrol Speed

The Patrol Speed settings allow you to choose how quickly your camera will patrol – Fast, Medium, or Slow. After you've chosen a speed setting, click the [save] button to save your settings.

## 6.7 Event Setup

From this page, your camera can be programmed to respond to events – such as detected motion, or a triggered I/O device – and send a snapshot directly to your e-mail account, ftp server, image server, notification server, HTTP server, or SMS server in order to warn you about what’s happened.

### 6.7.1 Event Servers

This page provides 6 different server-types capable of receiving notification of events: E-mail, FTP, Image, Image, Notify, HTTP, and SMS. To set up Event Servers, navigate to [Setup] > [Event Setup] > [Event Server Setup]. The following screen will appear.

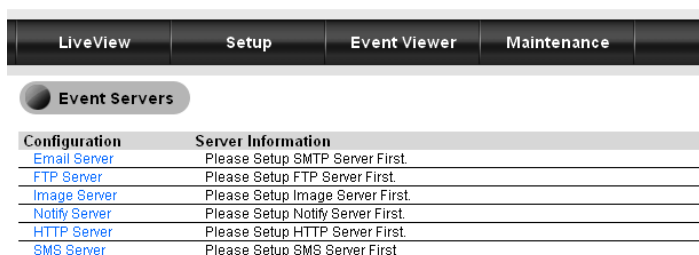

#### 6.7.1.1 E-Mail Server

Your camera supports standard SMTP on SSL-protected webmail platforms such as Hotmail (Windows Live), and Gmail. To utilize this function, navigate to [Setup] > [Event Setup] > [Event Server Setup] > [Email Event Server Setup]. The following screen will appear.

SMTP Server:	<input type="text"/>
SMTP Port:	<input type="text"/>
From Address:	<input type="text"/>
To Address:	<input type="text"/>
Authentication Method:	none <input type="button" value="v"/>
User Name:	<input type="text"/>
Password:	<input type="text"/>
Subject:	Alarm from IP Camera

The following table describes the labels found in this screen.

Label	Description
SMTP Server	Enter SMTP server information in this field (ie. smtp.gmail.com)
SMTP Port	Enter your SMTP server’s port information
From Address	Enter your full e-mail address (ie. <a href="#">xxxx@xx.com</a> )

To Address	Enter the full e-mail address you wish to receive notifications.
Authentication Method	Login or Plain. For most e-mail servers, select Login.
User Name	Enter your full username (ie. xxxx@xxx.com)
Password	Enter your e-mail account's password
Subject	Enter the subject line you want alert e-mails to have.
Save	Save settings
Clear	Clear settings
Cancel	Cancel

### 6.7.1.2 FTP Server

This page allows you to set up your camera to automatically upload triggered snapshots to an FTP server. To access this page, navigate to [Setup] > [Event Server Setup] > [FTP Server]. The following screen will appear.

The following table describes the labels found within this screen.

Label	Description
FTP Address	Enter the address of your FTP server
FTP Port	Enter the port of your FTP server
User Name	Enter your user name here
Password	Enter your Password here
Upload Path	Enter the file path of the folder where you want snapshots to be stored.
Save	Save settings
Clear	Clear settings
Cancel	Cancel

### 6.7.1.3 Image Server

This page allows you to set the file name that will be used when snapshots are taken. To access this page, navigate to [Setup] > [Event Setup] > [Event Server Setup] > [Image]. The following screen will appear.

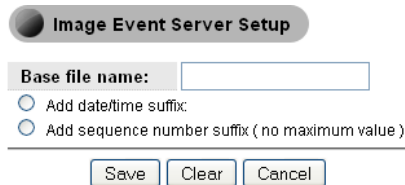

The screenshot shows a configuration window titled "Image Event Server Setup". It contains a text input field for "Base file name:". Below this are two radio button options: "Add date/time suffix:" and "Add sequence number suffix ( no maximum value )". At the bottom of the window are three buttons: "Save", "Clear", and "Cancel".

### 6.7.1.4 SMS Server

Your IP camera is capable of sending SMS notifications to one or more pre-defined recipients in case an event is triggered. This feature requires no additional hardware – users need only to have an account with a third-party web-based SMS gateway service provider.

To access this page, navigate to [Setup] > [Event Setup] > [Event Server Setup] > [SMS Server]. The following screen will appear.

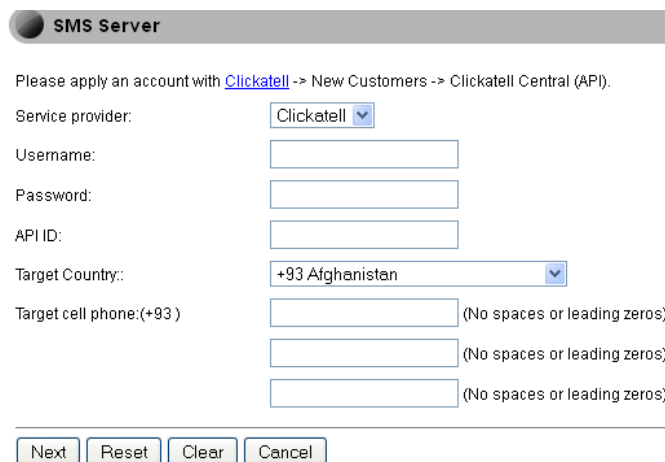

The screenshot shows a configuration window titled "SMS Server". It includes a note: "Please apply an account with [Clickatell](#) -> New Customers -> Clickatell Central (API)". The form contains several fields: "Service provider:" with a dropdown menu set to "Clickatell"; "Username:" with a text input field; "Password:" with a text input field; "API ID:" with a text input field; "Target Country:." with a dropdown menu set to "+93 Afghanistan"; and "Target cell phone:(+93)" with three stacked text input fields, each followed by the instruction "(No spaces or leading zeros)". At the bottom are four buttons: "Next", "Reset", "Clear", and "Cancel".

The following table describes the labels found within this screen.

Field	Description
Service Provider	Your SMS gateway service provider. (Default: Clickatell)
User Name	Your user name
API ID	API ID provided by your service provider
Target country	The country code for the recipient's phone number

Target Cell Phone recipient's mobile phone number	Cell phone number of the recipient.
Next	Accept settings and move to the next page
Reset	Reset settings
Clear	Clear settings
Cancel	Cancel

After you input your settings, click [Next]. The following page will appear.

**SMS Message**

You may wish to customize the message content which you receive.  
 Note: The maximum characters allowed in a message is 39 characters.

#camera has been triggered by #event.

characters: 37 / 39

Parameters: You may enter the following parameters into the text cell above and it will automatically gather the required information from the camera.  
 #camera: Camera's name  
 #event: Event type

Next Previous Reset Cancel

This page allows you to input the message that will be sent when an event is triggered. Enter your message, then click [Next]. The following screen will appear.

**SMS Server**

Send me a SMS message via the SMS Gateway

You should be receiving a test message within 20 seconds of pressing the test button. If you hadn't receive the message after more than a minute, please check the Clickatell setting or check if your cell phone operator is supported here. [Clickatell](#).

Note: You must top your account with Clickatell in order to receive alarms from your camera. The service provider does not allow sending of custom messages with free messages.

Previous Finish Cancel

This page will allow you to test your camera's SMS functionality. To send yourself a test SMS, click the [Send me a SMS message via the SMS Gateway] button.

Click [Finish] to complete setup.

## 6.7.2 Trigger Setup

This page allows you to create, modify, or delete event triggers. To access the Trigger Setup page, navigate to [Setup] > [Event Setup] > [Trigger Setup]. The following screen will appear.

To create an event trigger, click the [Create] button. The following screen will appear.

The following table describes the fields in this screen.

Field	Description
Event Trigger	Set the trigger for this event. Triggers can be based on schedule, I/O port activity, or audio detection.
Schedule	If you wish to schedule an event, input the time and day on which you want events to be triggered.
Motion Detection	Select the area in which motion detection will trigger an event.
Audio Detection	Check the [Enable] box if you wish audio detection to trigger an event
I/O Ports	Select the I/O port you wish to trigger with an event.
Next	Accept settings and move to the next page
Cancel	Cancel

Upon clicking [Next], users will be able to define actions to take when an event is triggered.



---

**Event Actions**

Output Port 0

Output Port 1

Output Port 2

Goto PTZ Point -Select Point-

---

Select the actions to be taken, then click [Finish] to complete trigger setup.

### 6.7.3 Motion Detection

Motion Detection allows you to define up to three regions that will trigger an event if motion is detected.

**Motion Detection**

Select Region: 0

Sensitivity: Lowest

Select a region, sensitivity level (S1: Lowest ~ S5: Highest) from the dropdown list, and then click and drag on the video display to define the region. Click [Save] for settings to take effect.

### 6.7.4 Audio Detection

The Audio Detection page allows you to define the threshold at which sound will trigger an event. The audio detection function on this IP camera works by measuring volume levels.

Sensitivity	Trigger Threshold
Low	Approx 65~70dB
Medium	Approx 80~85dB
High	Approx 100~105dB

## 6.8 Recording Setup

The IPC-2605N supports storage of both snapshots and video clips to local storage. To configure this function, navigate to [Setup] > [Recording Setup]. The following screen will appear.

**Recording Setting**

SD Card Status: not detected  
SD Card capacity:

Format:

Enable recording during network failure

Note: The CamVR uses a First In First Out (FIFO) buffer which will erase the oldest recording one by one once the SD card becomes full.

This page allows you to view your SD Card's status, capacity, and gives you the option of formatting the card, as well as enabling recording to an SD card in the event of network failure.

Click [Next] to continue. The following screen will appear.

**Event Selection**

Event based:

When motion is detected  
 When audio is detected  
 When digital input(s) are triggered

Recording duration:  seconds

Schedule recording:

Monday  Tuesday  Wednesday  Thursday  
 Friday  Saturday  Sunday

From (24 hour clock):  :   
Until (24 hour clock):  :

Disable Recording

This page allows you to configure the circumstances in which recording to the SD card will occur. Users may choose to record when motion is detected, when audio is detected, when digital input(s) are detected, and the duration of the recording in seconds.

Users may also schedule recording, or disable recording entirely.

Click [Save] to complete recording setup.



Note:

- This camera uses a First In, First Out storage method. When the SD card is full, the oldest files will be automatically rewritten.
- If you want to record video clips of detected motion to the SD card, you'll need to set a motion detection region before setting up event-based recording.

## 6.9 Recording History

The Recording History page allows users to manage video clips that have been recorded by the camera. You'll see a playback menu as displayed below.

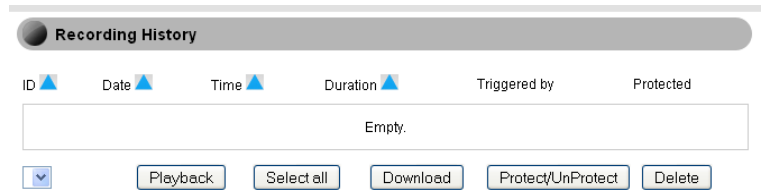

The following table describes the labels found within this screen.

Label	Description
Playback	Click to download then play the selected clip
Download	Click to download the selected clip to your PC
Protect/UnProtect	Protected files will not be erased. Click this button to Protect or remove protection from selected clips
Select All/Deselect/Delete	File Management

## 6.10 Date

This page allows you to set the current Date/Time information stored in your camera, as well as set time zones, enable or disable daylight savings time, synchronize the clock of your camera system with your PC, and obtain time information from an NTP server. To access this page, navigate to [Setup] > [Date]. The following page will appear.

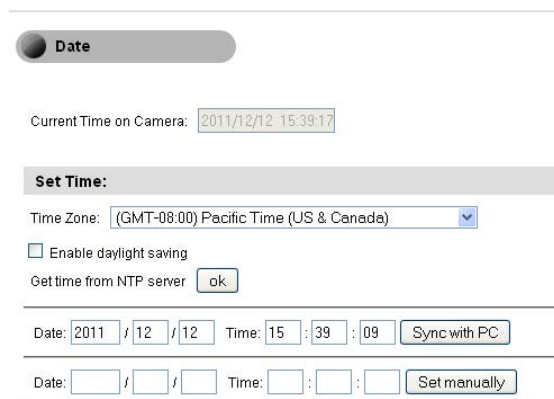

## 7 Event Viewer

The Event Viewer allows you to view detailed logs of events which have been triggered. To access this page, navigate to [Setup], then select [Event Viewer] from the top panel. Select any type of event from the sidebar (Motion, I/O, Scheduled Triggers, or Audio Detection) to view that type's history, or click on image links to view event-triggered snapshots.

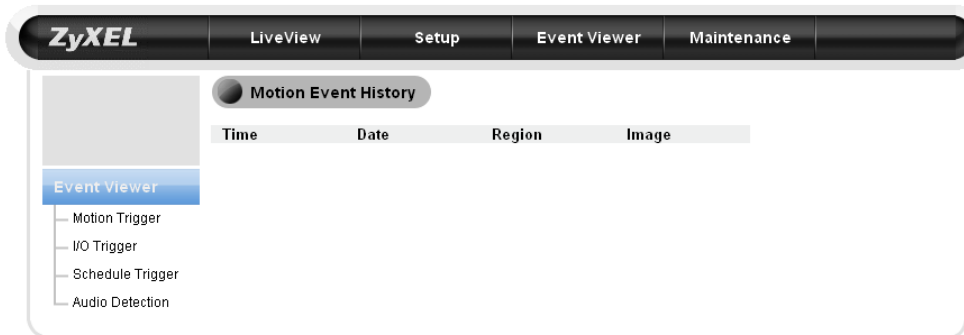

## 8 Maintenance

The Maintenance screen provides information about your IP camera, access to the history log, and system maintenance functions.

### 8.1 Information

To access the Maintenance Information screen, navigate to [Setup], then select [Maintenance] from the top panel. The following screen will appear.

#### Information

Item		Information Valid	
Firmware Ver.		IPC-4605N 0.1_71111251596	
Stream 1	Video	Resolution	320x240
		Codec	H264
		Quality	512Kbps
Stream 2	Video	Resolution	320x240
		Codec	MJPEG
		Quality	512Kbps
Camera	White Balance	Auto	
	Exposure Control	Auto	
	Low Light Mode	OFF	
Ethernet	IP	192.168.1.11	
	DNS	192.168.1.1	

### 8.2 Log

This page provides a system log for your camera. To access this page, navigate to [Setup], select [Maintenance] from the top panel, and then select [Log] from the side panel.

To clear the system log, click the [Clear Log] button.

### 8.3 Maintenance

The Maintenance page allows you to reboot your IP camera, change the User Interface language, export/import profiles, reset to factory defaults, or update your camera's firmware.

---

**System Maintenance**

---

**Reboot Camera**

Reboot

**Warning:** Once the reboot button is pressed, the camera will be offline for approximately 1 minute, depending on your configuration. All monitoring and reporting capability will be offline until the system comes back online.

---

**Language Select**

English

---

**Profile Management**

Export

---

**Reset all settings to default**

---

**Firmware Update**

**Warning:** Upgrading firmware may take 3 minutes, please don't turn off the power or press the reset button. If the network is congestion, it may take more time to complete the upgrading.

### 8.3.1 Reboot Camera

Press the [Reboot] button to reboot your camera.

### 8.3.2 Profile Management

Profile Management allows users to easily set up multiple cameras. After one camera is properly configured, users can export that camera's configuration to a profile on their PC, which can then be loaded onto other cameras. This feature also serves as a backup in case settings need to be restored.

- 1) After the first camera has been properly configured, go to [Maintenance] > [Profile Management], and click [Export] to download a profile to a user-specified location.
- 2) To load an existing profile into a camera, log into that camera's System Maintenance page, press [Browse], and locate the profile you wish to load. Click [Import] to load the profile.
- 3) The camera will reboot, which can take approximately 60 seconds. Do not interrupt the reboot process, as this can damage your camera permanently



Caution:  
You may only import profiles among identical camera models.

### 8.3.3 Reset All Settings to Default

This will reset your camera to its factory default settings. All changes you've made will be lost.

### 8.3.4 Firmware Update

Firmware updates are available at [us.zyxel.com/support](http://us.zyxel.com/support). After downloading the latest firmware for your camera, click the [Browse] button to locate the firmware file on your hard drive, then click the [Upgrade] button to update the camera's firmware. Once the upgrade process begins, it must not be interrupted or you risk permanently damaging your camera.

If some icons are out of place after reboot, press [Ctrl] + [F5] to force your browser to refresh its cache.



Caution:

Before updating firmware, close all other browser windows and background applications.



Note: Should you accidentally close your browser's window during the upgrade process, DO NOT unplug the power cable or reset the camera immediately. Try waiting 3-5 minutes, as the camera may complete the upgrade process on its own.

## 9 Troubleshooting

During the course of installation, you might encounter various issues. The following section contains some troubleshooting procedures to help you solve these problems.

### 9.1 Reconfiguring Your Device

Anytime you need to re-configure your IP camera, you can simply double-click on the eaZy Wizard icon to launch the eaZy Wizard configuration tool. During the configuration, the eaZy Wizard will automatically scan for all of the available ZyXEL IP surveillance products installed on your LAN network (even if they are not on the same subnet). Scanning generally takes around 1 minute to complete, and once it completes, you will see all available IP cameras populate the list.



### 9.2 Cabling Check

If your camera doesn't appear on the device list in the eaZy Wizard, follow these steps to check your cables:

- 1) Check that your IP camera has been connected to the LAN network and powered on for more than 1 minute
- 2) Check to see if your computer has a successful connection to the network.



Note: You can check your router's connection status from the maintenance page of your router's settings.



## 9.3 Resetting to Factory Defaults

If you've forgotten your password, or your camera's been acting generally strange, you can follow the steps below to reset the camera to its default settings. To reset the camera:

- 1) Press and hold the reset button (located on the camera's rear panel) for approximately 10 seconds. When successful, you should see the status indicator light turn off.
- 2) After approximately 5 more seconds, the status indicator light should turn on again. This indicates that the camera has been successfully reset to factory defaults.
- 3) Reconfigure your camera using the eaZy Wizard.

Once the camera is reset, it will take approximately 1 minute to reboot. Wait for it to finish, then load the eaZy Wizard to scan for the camera.

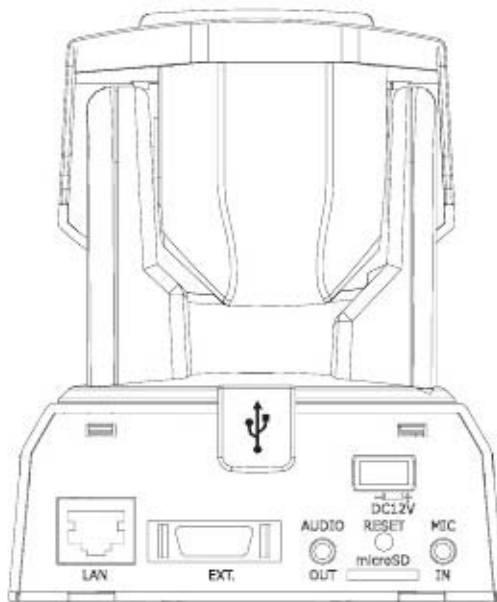

## 9.4 Trouble with Active X

After launching your browser and entering your camera's IP address, you'll be asked for the username and password combination (Default is admin/admin, case sensitive.)

### No User Interface in the Browser

This issue could have three possible causes.

- 1) ActiveX was not installed. Follow the instructions on-screen to install ActiveX, or you won't have access to the user interface.

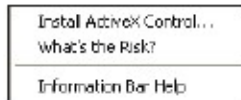

Note:



ZyXEL's ActiveX components only support 32-bit Internet Explorer. If your computer is running a 64-bit operating system, you'll still need to use a 32-bit browser to access the camera.

- 2) ActiveX was installed but not enabled. Ensure that ActiveX has been properly registered in Internet Explorer. Make sure that both USActiveX.cab and IPCamClientActiveX.cab are registered under the Tools > Manage Add-Ons menu in Internet Explorer.
- 3) Browser security settings. Ensure your browser's security settings allow the installation of ActiveX by adding the IP address of the camera to the list of trusted sites in Internet Explorer.



If you've gone through all above steps but still can't obtain video/audio on your browser, close all browser windows and delete the 'IPSurveillance Embedded' folder found in C:\Program Files. (If using 64-bit windows, look in C:\Program Files (x86)), then open your browser, log into your IP camera, and reinstall the ActiveX client.

If your browser is returning a "213 file not found" error, try rebooting your computer.

## 9.5 Trouble with Remote Viewing on Browser

You can view your camera's video streams remotely over the Internet. If you're having trouble viewing video remotely, refer to the section below for troubleshooting tips.

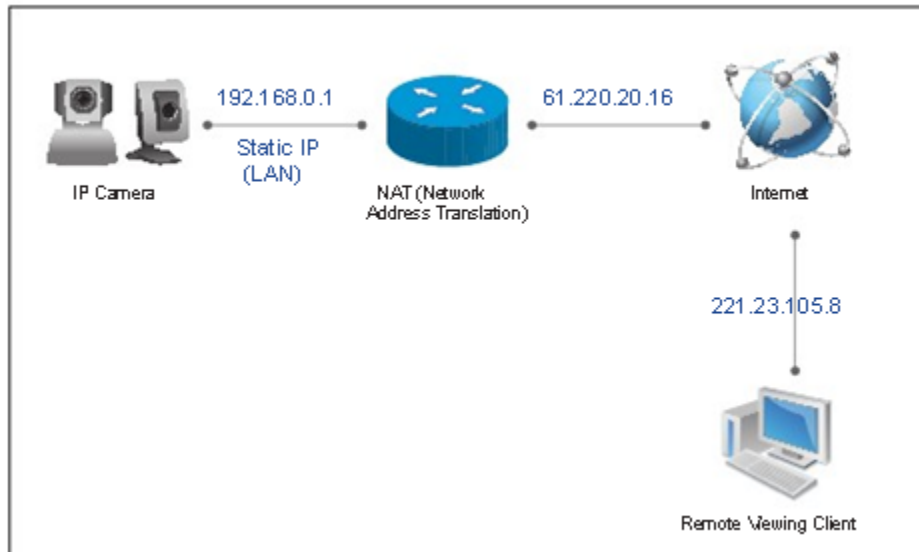

The above figure depicts a typical setup in which:

- The IP camera has a static virtual IP address of 192.168.0.1
- The WAN IP address at the IP camera site is 61.220.20.16
- The client (user) is trying to receive the video/audio stream remotely.

To successfully view live video streamed from the IP camera, you need to:

- 1) Ensure that the camera's image quality setting stays within the bandwidth limit of your local network. You can check the camera's image quality setting in [Setup] > [Video]. If your quality setting exceeds your bandwidth limit, you will experience stuttering video or a blank screen.
- 2) Check the ports used by the camera in [Setup] > [Network] and note the HTTP and RTSP server ports, in this case ports 80 and 554 respectively, as shown below.

Users	
Network	
Ethernet	
Wireless	
Advance	
DDNS	
NTP Server	time.stdtime.gov.tw
DDNS Server	Disabled DDNS
HTTP Server	Port: 80
RTSP Server	Port: 554

- 3) Enable port forwarding on your router and allow traffic on the ports the IP camera is using. You may need to consult the manufacturer of your router for setting details. Note: Your router may require a reboot after port forwarding is set. The following figure details the settings required to remotely view the IP camera.

The image shows a screenshot of a router's port forwarding configuration interface. It contains two entries for port forwarding. The first entry is for 'NVR HTTP' with a name 'NVR HTTP', IP address '192.168.0.170', and port '80'. The second entry is for 'NVR RTSP' with a name 'NVR RTSP', IP address '192.168.0.170', and port '554'. Annotations with arrows point to various fields: 'Fill in any name' points to the Name field of the first entry; 'Punch in HTTP port number here' points to the port field of the first entry; 'Camera's IP Address' points to the IP Address field of the second entry; 'Punch in RTSP port number here' points to the port field of the second entry; and 'Allow Traffic' points to the Inbound Filter field of the second entry.

Name	Application Name	Protocol	Port	Schedule	Inbound Filter
NVR HTTP	Application Name	TCP	80	Always	Allow All
NVR RTSP	Application Name	TCP	554	Always	Allow All

After taking the above steps, you should be able to log into your IP camera from a remote location by entering the DDNS address or the static IP address into the navigation field of your web browser. For example, in this case, you could enter <http://61.220.20.16:80> into the location field of Internet Explorer to access your IP camera.



**Important:**

- If you have multiple IP cameras installed on a network, you'll need to change HTTP and RTSP ports manually so each camera uses a different port. For example, the second device in the above example would need to use ports 80 and 555, and the second device would be accessed at <http://61.220.20.16:81>
- When configuring port forwarding/mapping on your router, note that the public RTSP port must be equal to the internal RTSP port used by the IP camera. For example, if the IP camera uses RTSP port 554 internally, then its mapped public RTSP port should also be 554. The same does not apply to the HTTP port.

## 9.6 Symptoms, Causes, and Solutions

Listed below are some common problems, and their solutions.

Symptom	Possible Cause/Solution
Problems accessing from LAN network using web browser	<p>The entered IP address is incorrect.            Make sure the IP address you entered matches the IP address of your camera. If you are certain that your camera is configured with the same subnet mask as that of your PC, you can first disconnect other cameras, then run the eaZy Wizard to scan for the camera on your network. It will display the camera's IP address on your network.            (Note: If you're running Windows7/Vista, you'll need to run the eaZy Wizard tool with system administrator rights. Simply right-click the eaZy Wizard icon and select "run as administrator")            If you're not sure whether your camera is on the same subnet as your PC, reconnect your camera to your PC directly (configure the IP address of your PC as 192.168.0.X), and run eaZy Wizard again to reconfigure its subnet address to match that of your PC, then reconnect it to your router or switch and run eaZy Wizard again.</p>
	<p>The viewing PC is not connected to the LAN network.            Check to see if your PC has a successful connection to the LAN network your camera is installed on. You can open a command prompt window (by pressing Winkey+R, typing "cmd," and hitting OK), then input 'ipconfig' and press [Enter]. When your PC is connected to the network, it will display information about your IP address, subnet mask, etc.</p>
Problems accessing via wireless connection	<p>The wireless antenna is not firmly screwed in to the camera.            Check if the wireless antenna is firmly screwed in to the camera. When camera has established wireless connection successfully, the LED status indicator of the wireless dongle will appear green and blue.</p>
	<p>Wireless settings are not configured properly.            Check to see if wireless settings are configured correctly. Go to the camera's Wireless Settings page and make sure you have inputted the right IP address, SSID and Keyphrase.</p>
	<p>The wireless connection is broken.            If you intend to access your camera by way of wireless connection, please check that:            1. The IP camera is connected to the correct wireless access point.            2. You have correctly set the encryption type and key for the wireless connection. If you didn't use a router on your network, the default IP address for the camera will be 192.168.0.128.            You can check the status of the connection by logging on to your router's maintenance page. Consult with the manufacturer of your router for detailed instructions.</p>

Symptom	Possible Cause/Solution
Scanning and connecting to wireless AP takes a long time	<p>Too many wireless APs nearby.</p> <p>The amount of time taken to scan wireless APs depends on the number of wireless APs around the camera. If there are too many wireless APs (30 or more), it may take as long as 3 minutes to complete the scanning process. A possible workaround is to turn down the video setting a notch temporarily, and then turn it up again after you have completed configuring your wireless connection.</p> <p>For example, you can first set your video setting as QVGA, MPEG-4, 5fps, 512Kbps; Then go to network page for wireless connection setup and set the video setting back to its original state. This could reduce scanning time</p>
Successful login to the camera, but no image is displayed	<p>The ActiveX component is not installed.</p> <p>If you are viewing the camera video on Internet Explorer, make sure you have installed and enabled the camera's ActiveX components. Open Internet Explorer and go to [Tools] &gt; [Manage Add-ons] and check that you've got both the "IPCamClientActiveX.cab" and "USActiveX.cab" control components registered and enabled. Refer to the "Trouble with the ActiveX Client" section of this manual for further help.</p> <p>The VLC plugin is not installed for non-IE browsers.</p> <p>If you're viewing the camera from Firefox, Safari, or Chrome, make sure your VLC plugin is properly installed. (Visit <a href="http://www.videolan.org/vlc/">www.videolan.org/vlc/</a> to download the codec.)</p>
Successful access on local network, but trouble accessing from the Internet.	<p>The entered hostname/WAN IP address is incorrect.</p> <p>Make sure you entered the correct hostname (if you use DDNS) or the WAN IP address of your camera in the location field of the web browser.</p> <p>The LAN network is not connected to Internet.</p> <p>Both the device you're using and the camera need to have a connection to the Internet. Check if you can browse the Internet on your LAN network. If not, contact your network administrator for assistance.</p> <p>The camera's WAN IP address has changed but yet to be updated into DNS cache.</p> <p>If you use DDNS service, the information of your camera's IP address and the domain name the IP address is linked to are stored in the DNS cache. The cache is used to retrieve the IP information by the DNS server which translates entered hostname into the camera's IP address. Though the information is updated every few minutes (determined by the value of TTL, Time to Live), occasionally the DNS information changes (e.g. your camera acquires a new IP address) but the old information is still stored in the cache, resulting in connection failure.</p> <p>When this happens, try waiting a few minutes for the new IP information to be updated to the DNS server and then retry connection, or try to decrease the TTL value. If it still doesn't work, refer to other possible causes and solutions.</p> <p>The router's configuration does not allow incoming traffic to the camera.</p> <p>To access your camera from the internet, you'll need to enable port forwarding on your router and allow incoming traffic on the HTTP and RTSP port your camera is using (your router may require a reboot after port forwarding is set). Refer to the "Remote Viewing via Internet Explorer" section in the user manual for detailed information. If you don't know how to enable port forwarding on the router, consult the manufacturer of your router for instruction.</p>

Symptom	Possible Cause/Solution
Network diagnosis shows error icon	<p>Network connection error.</p> <p>The network connection test verifies that the camera has successfully connected to the LAN network. When the diagnosis result shows a red exclamation mark icon, it means that the camera fails to connect to the LAN network. Check if the LAN cable is securely connected to the Ethernet port of the camera and to your hub/router, or check if the LAN cable is functioning normally. Also check whether the gateway address your camera uses is identical to that of your router</p>
	<p>Internet connection error.</p> <p>The Internet connection test verifies if the camera is connected to the Internet. When the diagnosis result shows a red exclamation mark, it may represent a failed connection to the LAN network. It could also be caused by inappropriate settings on your router that makes your router unable to connect to the Internet, such as the wrong PPPoE user name/password, or wrong WAN IP settings (when your ISP provides you with fixed IP address). See if the PC connected to your router can also access the Internet. If not, consult your ISP/ router manufacturer for correct Internet setting. If your router can connect to the Internet but your camera connected to your router cannot, check whether the IP, subnet mask and gateway is correctly set on your camera.</p>
	<p>HTTP/RTSP port error.</p> <p>The HTTP port is used for transmitting web pages and commands over the Internet. The RTSP port is used for sending video/audio data. These two test items will fail whenever port forwarding is not enabled. Make sure you have enabled port forwarding on your router and have allowed traffic on ports your IP camera is using. Refer to the "Remote Viewing via Internet Explorer" section of this manual for more information</p>
Problem using DDNS service	<p>The user information is incorrect.</p> <p>Go to the main setup page. On the left menu, select [Network] &gt; [DDNS], and check if the ID and password is correct. Also check with your service provider to see if your service account is active.</p>
	<p>The entered address is incorrect.</p> <p>Go to the main setup page and select [Network] &gt; [DDNS] on the left menu, and then check if the DDNS service is enabled and if you have the correct address.</p>
	<p>Incoming traffic to the network camera is not allowed.</p> <p>Please refer to the "Remote Viewing via Internet Explorer" section in the troubleshooting chapter of this manual and look for instruction on enabling port forwarding.</p>
Problem using eaZy Wizard	<p>The IP camera's IP address is repeatedly displayed as "DHCP mode" in eaZy Wizard.</p> <p>This means the camera cannot obtain an IP address from DHCP Server or the IP address assigned to the camera is not on the same subnet as the LAN network. Please try to set the camera's IP address to a static one. Note that you have to set up the DNS server for your camera (in the advanced network settings) if your camera uses a static IP address.</p>



Symptom	Possible Cause/Solution
Part of the image becomes pixilated/Image artifacts appear	<p>Network bandwidth is insufficient. Without sufficient bandwidth, video quality will deteriorate and image errors like pixilation or frame-drop may occur. When you view your camera remotely from the Internet, your camera needs sufficient upload bandwidth to transmit video stream and you need sufficient download bandwidth to download video stream at the remote location.</p> <p>To gain satisfactory video quality, ensure there is sufficient upload bandwidth available to your network camera by taking the following actions:</p> <ol style="list-style-type: none"> <li>1. Contact your Internet Service Provider (ISP) to confirm the upload/download speed limit of your service. If the bit rate of the video stream is set at 512Kbps or higher but your Internet service only provides a max. of 512Kbps for upload bandwidth, then try to lower the bit rate setting in [Setup] &gt; [Video].</li> <li>2. Run a network speed diagnostics on WebVUer to determine the bandwidth level of the currently connected network. To do so, log in to your camera using WebVUer and go to [Setup] &gt; [Network] &gt; [Network Bandwidth]. When the speed diagnostics is done, the WebVUer will advise you of the appropriate setting.</li> </ol> <p>Consider the following actions to ensure sufficient download bandwidth at your remote viewing location:</p> <ol style="list-style-type: none"> <li>1. Contact your Internet Service Provider (ISP) to confirm the upload/download speed limit of your service. If the bit rate of the video stream is set at 3Mbps or higher but your Internet service only provides a max. of 2Mbps download bandwidth, then try to lower the bit rate setting in [Setup] &gt; [Video].</li> <li>2. Upgrade to a Gigabit network switch. Regular 10/100 Mbps network switches cannot handle multiple megapixel streams.</li> <li>3. While you are viewing the network camera remotely, shutting down any other applications that are also consuming network bandwidth in the background.</li> </ol>
Gray images are seen repeatedly	<p>Network quality is insufficient. Seeing lots of gray images in live view mode indicates that many data packets which carry video data are dropped during the transmission. This might be caused by network congestion, wireless congestion, or the limited upload/download bandwidth of your network. To measure the upload/download capability of your network, you can use either the “Network Bandwidth” testing tool in the network settings page, or visit speedtest.net (<a href="http://speedtest.net">http://speedtest.net</a>).</p> <p>When using wired connection: Test your bandwidth to determine whether this problem is the result of poor network quality. Alternatively, try connecting your camera to your viewing computer directly to see if there are any faulty devices on your network.</p> <p>When using wireless connection: Besides the possible network bandwidth issue, your wireless signal strength could also come into play. Low wireless signal strength can lead to the same problem. You can check your wireless signal strength in the camera’s network settings page. The wireless signal level seen in the network settings is measured in dBm. To gain the optimal wireless connection quality, a signal level greater than -60 dBm is recommended. When the signal level is too low, you may have to place your wireless Access Point in a different location, use a wireless repeater, or remove obstacles between the camera and the wireless AP.</p>
Ghost image is seen	<p>Network quality is too low. This is a common problem when the network’s quality is low or the video setting is too high. Lower your camera’s video bit rate and see if the problem continues.</p>

Symptom	Possible cause/solution
A warning message appears stating "Your video quality is too high for your Internet bandwidth."	<p>Network quality is not high enough.</p> <p>This means the camera's browser interface, WebVUer, could not receive a steady stream of video data from your camera. The loss of video data might also be caused by network congestion or insufficient bandwidth. Please refer to other related troubleshooting tips. Additionally, if the CPU usage on your viewing computer is too high, the same warning message will be showed. You can monitor the CPU usage by right clicking on your Windows taskbar and choose "task manager", and then click the Performance tab.</p>
Cannot store recordings on a microSD card	<p>The microSD card is not inserted firmly into position. Remove the memory card and re-insert it into the card slot. To verify if your SD card is properly installed, go to [Setup] &gt; [Recording Setup] &gt; [Micro SD], and check if [SD Card Status] and [SD Card Capacity] shows correct information. If "not detected" is shown, remove and re-insert the card again, refresh the WebVUer, and verify again.</p>
	<p>The microSD card is not properly formatted. Go to main setup page, and choose [Recording Setup] from the left menu. Choose [Micro SD] for the "Destination" field, and then press the [Format] button. If still not functioning properly, try storing still snapshots onto the SD card. Failure in storing snapshots often suggests a problem with the memory card.</p>
	<p>Your microSD card is not supported by the camera. Your IP camera may not fully support high capacity memory cards from all manufacturers. Contact ZyXEL if you think you've encountered an SD card compatibility problem.</p>
	<p>Your SD card does not meet writing speed requirements. You may experience minor issues in video recording when your SD card doesn't meet writing speed requirements. ZyXEL recommends using class 4 or above SD cards for video recording.</p>
	<p>A motion detection region has not been configured for recording triggered motion events. If you want to record video clips of detected motion to an SD card, you'll need to set at least one motion detection region before setting up event-based recording in Recording Setup.</p>

## Technical Support Information

In the event of problems that cannot be solved, please contact your vendor. If you cannot contact your vendor, contact a ZyXEL office in the region in which you bought the device. Regional offices are listed at [www.zyxel.com/web/contact\\_us.php](http://www.zyxel.com/web/contact_us.php)

ZyXEL communications Corporation – Worldwide Headquarters

[www.zyxel.com](http://www.zyxel.com)

Tel. +866-2-2912-3685 | Fax +866-2-2912-3656

11F., No. 223, Sec. 3 Beixin Rd., Xindian Dist., New Taipei City 231, Taiwan (R.O.C)

## 10 Technical Specifications

Category	IPC-2605N	
Camera	Image Sensor	1/7" CMOS Progressive Scan Sensor
	Lens	<ul style="list-style-type: none"> <li>• Focal Length: 2.0mm</li> <li>• Max Aperture Ratio: F2.8</li> <li>• Fixed Iris</li> </ul>
	Pan Range	-170° ~ +170°; total of 340 degrees
	Tilt Range	-10° ~ +90°; total of 100 degrees
	Max Speed	Pan 60°/sec., Tilt 50°/sec.
	Zoom	10x Digital zoom
	Angle of View	50° horizontal
	Focus Range	0.5m ~ INF
	Minimum Illumination	IR Mode: 0 lux with built in IR LEDs on (12 LEDs in total; effective distance up to 10m) Color mode: 1.0 lux
	Shutter Time	1/5 ~ 1/16000 Sec
Video	Video Compression	Motion JPEG
	Resolution	160x120, 320x240, 640x480
	Frame Rate	Up to 30 FPS at 640x480
	Image Settings	<ul style="list-style-type: none"> <li>• Adjustable image size and quality</li> <li>• ACG, AWB, AES</li> <li>• Configurable brightness, saturation, and sharpness</li> </ul>
Audio	Audio Communication	Two-way audio with built-in MIC
	Audio Compression	G.711 PCM 64Kbit/sec
	Audio input/output	MIC input / Audio out
Network	Security	User ID/Password protection
	Supported Protocols	TCP/IP, HTTP, UDP, FTP, ICMP, ARP, DHCP, NTP, DDNS, DynDNS, UPnP, RTP, RTSP, RTCP, SMTP, IGMP, 3GPP, IPv4
Firmware	Firmware	<ul style="list-style-type: none"> <li>• Supports UPnP</li> <li>• Supports online firmware update</li> </ul>

Category		IPC-2605N
Web Browser	Internet Explorer (ActiveX)	<ul style="list-style-type: none"> <li>• Remotely view and configure camera on Internet Explorer</li> <li>• Record video and capture snapshots on PC; download recordings from microSD card</li> <li>• Alarm and event management: FTP, I/O alarm, server notification, SMS/Email alert</li> </ul>
	Supported Devices	<ul style="list-style-type: none"> <li>• PC, Laptop, Tablet, Nettop, MID with IE/ActiveX support</li> <li>• Viewing in MJPEG mode on mobile phone, iPhone/iPad, BlackBerry, Android, Windows Mobile, PDA</li> </ul>
Mobile Phone	MJPEG Mode	Viewing of camera image via phone browsers
General	Operating Conditions	5°C ~40°C
	Power Supply	DC5V/2A
	System Requirements	<ul style="list-style-type: none"> <li>• Computer with 2.8GHz dual core processor and 2GB memory or above</li> <li>• Supported Operating Systems: Windows XP SP3, Vista SP1, Windows7 x86/x64</li> </ul>
	Included Accessories	<ul style="list-style-type: none"> <li>• Software CD (electronic manual included)</li> <li>• Quick Installation Guide</li> <li>• Power Adapter</li> <li>• Network Cable</li> <li>• Screws for ceiling mounting</li> <li>• Screw mount</li> </ul>
	Dimensions	105mm x 125.5mm x 128.6mm

\*Specifications are subject to change without prior notice.

## 11 Open-Sourced Components

3 <sup>rd</sup> Party Software	Version	License
Addgroup	V1.13.4	Busybox, GPLv2
Adduser	V1.13.4	Busybox, GPLv2
Ash	V1.13.4	Busybox, GPLv2
AVN-IPv4LL	V1.13.4	GPL
Busybox	V1.13.4	Busybox, GPLv2
Cat	V1.13.4	Busybox, GPLv2
Chattr	V1.13.4	Busybox, GPLv2
Chgrp	V1.13.4	Busybox, GPLv2
Chmod	V1.13.4	Busybox, GPLv2
Chown	V1.13.4	Busybox, GPLv2
ComproRTSP	V1.13.4	GPL, modified from live.2008.12.20
Cp	V1.13.4	Busybox, GPLv2
Cttyhack	V1.13.4	Busybox, GPLv2
Date	V1.13.4	Busybox, GPLv2
Dd	V1.13.4	Busybox, GPLv2
Delgroup	V1.13.4	Busybox, GPLv2
Deluser	V1.13.4	Busybox, GPLv2
Df	V1.13.4	Busybox, GPLv2
Dmesg	V1.13.4	Busybox, GPLv2
Echo	V1.13.4	Busybox, GPLv2
Egrep	V1.13.4	Busybox, GPLv2
Email	V3.1.2	GPL
Ethtool	V6	GPL
False	V1.13.4	Busybox, GPLv2
Fgrep	V1.13.4	Busybox, GPLv2
ftp	V0.16	GPL
Grep	V1.13.4	Busybox, GPLv2
Gnuzip	V1.13.4	Busybox, GPLv2
Gzip	V1.13.4	Busybox, GPLv2
Hostname	V1.13.4	Busybox, GPLv2
Htpasswd	V1.19	GPL
Ip	V1.13.4	Busybox, GPLv2
Ipaddr	V1.13.4	Busybox, GPLv2
Iplink	V1.13.4	Busybox, GPLv2
Iproute	V1.13.4	Busybox, GPLv2
Iptables	V1.4.10	GPL
Iptables-multi	V1.4.10	GPL
Iptables-restore	V1.4.10	GPL
Iptables-save	V1.4.10	GPL
iwconfig	V29	GPL

Iwlist	V29	GPL
Iwpriv	V29	GPL
Kill	V1.13.4	Busybox, GPLv2
Ln	V1.13.4	Busybox, GPLv2
Login	V1.13.4	Busybox, GPLv2
Ls	V1.13.4	Busybox, GPLv2
Lsattr	V1.13.4	Busybox, GPLv2
Mini_httpd	V1.19	GPL
Mkdir	V1.13.4	Busybox, GPLv2
Mkdosfs	V2.11	GPL
Mknod	V1.13.4	Busybox, GPLv2
Mktemp	V1.13.4	Busybox, GPLv2
More	V1.13.4	Busybox, GPLv2
Mount	V1.13.4	Busybox, GPLv2
Mountpoint	V1.13.4	Busybox, GPLv2
Mv	V1.13.4	Busybox, GPLv2
Netstat	V1.13.4	Busybox, GPLv2
Nice	V1.13.4	Busybox, GPLv2
Ping	V1.13.4	Busybox, GPLv2 Busybox, GPLv2
Ping6	V1.13.4	Busybox, GPLv2
Ps	V1.13.4	Busybox, GPLv2
Pwd	V1.13.4	Busybox, GPLv2
Rm	V1.13.4	Busybox, GPLv2
Sed	V1.13.4	Busybox, GPLv2
Sh	V1.13.4	Busybox, GPLv2
Sleep	V1.13.4	Busybox, GPLv2
Stat	V1.13.4	Busybox, GPLv2
Stty	V1.13.4	Busybox, GPLv2
Stunnel	V4.36	GPL
Su	V1.13.4	Busybox, GPLv2
Sync	V1.13.4	Busybox, GPLv2
Tar	V1.13.4	Busybox, GPLv2
Touch	V1.13.4	Busybox, GPLv2
True	V1.13.4	Busybox, GPLv2
Umount	V1.13.4	Busybox, GPLv2
Uname	V1.13.4	Busybox, GPLv2
Upnpc-static	V20071003	GPL
Vi	V1.13.4	Busybox, GPLv2
Watch	V1.13.4	Busybox, GPLv2
Zcat	V1.13.4	Busybox, GPLv2
Ld-2.11.so		GPLv3
Ld-linux.so.3		GPLv3
Libc.so	V2.11	GPLv3
Libc.so.6	V2.11	GPLv3

Libc-2.11.so	V2.11	GPLv3
Libcrypt.so	V2.11	GPLv3
Libcrypt.so.1	V2.11	GPLv3
Libcrypt-2.11.so	V2.11	GPLv3
Libcrypto.so	V0.98m	GPL
Libcrypto.so.0.9.8	V0.98m	GPL
Libdl.so	V2.11	GPLv3
Libdl.so.2	V2.11	GPLv3
Libdl-2.11.so	V2.11	GPLv3
Libgcc_s.so	V4.4.0	GPLv3
Libgcc_s.so.1	V4.4.0	GPLv3
Libip4tc.a	V1.4.10	GPL
Libip4tc.la	V1.4.10	GPL
Libip6tc.a	V1.4.10	GPL
Libip6tc.la	V1.4.10	GPL
Libiptc.a	V1.4.10	GPL
Libiptc.la	V1.4.10	GPL
Libiw.so.29	V29	
Libixml.so	V1.4.10	GPL
Libixml.so.2	V1.4.10	GPL
Libixml.so.2.0.2	V1.4.10	GPL
Libm.so	V2.11	GPLv3
Libm.so.6	V2.11	GPLv3
Libm-2.11.so	V2.11	GPLv3
Libnsl.so	V2.11	GPLv3
Libnsl.so.1	V2.11	GPLv3
Libnsl-2.11.so	V2.11	GPLv3
Libnss_dns.so	V2.11	GPLv3
Libnss_dns.so.2	V2.11	GPLv3
Libnss_dns-2.11.so	V2.11	GPLv3
Libnss_files.so	V2.11	GPLv3
Libnss_files.so.2	V2.11	GPLv3
libnss_files-2.11.so	V2.11	GPLv3
Libpthread.so	V2.11	GPLv3
Libpthread.so.0	V2.11	GPLv3
Libpthread-2.11.so	V2.11	GPLv3
Libresolv.so	V2.11	GPLv3
Libresolv.so.2	V2.11	GPLv3
Libresolv-2.11.so	V2.11	GPLv3
Librt.so	V2.11	GPLv3
Librt.so.1	V2.11	GPLv3
Librt-2.11.so	V2.11	GPLv3
Libsc.so	V2.11	GPLv3
Libsc.so.1.0.2	V2.11	GPLv3
Libsockipc.so	V2.11	GPLv3

Libsockipc.so.1.2	V2.11	GPLv3
Libssl.so	V0.98m	GPL
Libssl.so.0.9.8	V0.98m	GPL
Libstdc++.so	V4.4.0	GPLv3
Libstdc++.so.6.0.11	V4.4.0	GPLv3
Libthread_db.so	V4.4.0	GPLv3
Libthread_db.so.1	V2.11	GPLv3
Libthread_db-1.0.so	V2.11	GPLv3
Libthreadutil.so	V1.4.1	GPL
Libthreadutil.so.2	V1.4.1	GPL
Libthreadutil.so.2.0.2	V1.4.1	GPL
Libupnp.so	V1.4.1	GPL
Libupnp.so.2	V1.4.1	GPL
Libupnp.so.2.0.2	V1.4.1	GPL
Libutil.so	V2.11	GPLv3
Libutil.so.1	V2.11	GPLv3
Libutil-2.11.so	V2.11	GPLv3
Libxtables.a		GPLv3
Libxtables.la		GPLv3
Adjtimex	V1.13.4	Busybox, GPLv2
Arp	V1.13.4	Busybox, GPLv2
Blkid	V1.13.4	Busybox, GPLv2
Depmod	V1.13.4	Busybox, GPLv2
devmem	V1.13.4	Busybox, GPLv2
Fdisk	V1.13.4	Busybox, GPLv2
Freeramdisk	V1.13.4	Busybox, GPLv2
Fsck	V1.13.4	Busybox, GPLv2
Fsck.minix	V1.13.4	Busybox, GPLv2
Getty	V1.13.4	Busybox, GPLv2
Halt	V1.13.4	Busybox, GPLv2
Hwclock	V1.13.4	Busybox, GPLv2
Ifconfig	V1.13.4	Busybox, GPLv2
Ifdown	V1.13.4	Busybox, GPLv2
Ifup	V1.13.4	Busybox, GPLv2
Init	V1.13.4	Busybox, GPLv2
Insmod	V1.13.4	Busybox, GPLv2
Klogd	V1.13.4	Busybox, GPLv2
Logread	V1.13.4	Busybox, GPLv2
Losetup	V1.13.4	Busybox, GPLv2
Lsmod	V1.13.4	Busybox, GPLv2
makedevs	V1.13.4	Busybox, GPLv2
Mdev	V1.13.4	Busybox, GPLv2
Mkds.minix	V1.13.4	Busybox, GPLv2
Mkswap	V1.13.4	Busybox, GPLv2
Modprobe	V1.13.4	Busybox, GPLv2



Pivot_root	V1.13.4	Busybox, GPLv2
Poweroff	V1.13.4	Busybox, GPLv2
Reboot	V1.13.4	Busybox, GPLv2
Rmmod	V1.13.4	Busybox, GPLv2
Route	V1.13.4	Busybox, GPLv2
Runlevel	V1.13.4	Busybox, GPLv2
Start-stop-daemon	V1.13.4	Busybox, GPLv2
Sulogin	V1.13.4	Busybox, GPLv2
Swapoff	V1.13.4	Busybox, GPLv2
Swapon	V1.13.4	Busybox, GPLv2
Switch_root	V1.13.4	Busybox, GPLv2
Sysctl	V1.13.4	Busybox, GPLv2
Syslogd	V1.13.4	Busybox, GPLv2
Udhcpc	V1.13.4	Busybox, GPLv2
Watchdog	V1.13.4	Busybox, GPLv2
haserl	V0.9.26	GPL

This product contains AVN-IPv4LL, ComproRTSP, email, ethtool, ftp, htpasswd, iptables, iptables-multi, iptables-restore, iptables-save, iwconfig, iwlist, iwpriv, mini\_httpd, stunnel, upnpc-static, libcrypto.so, libcrypto.so.0.9.8, libip4tc.a, libip4tc.la, libip6tc.la, libip6tc.a, libiptc.la, libiw.so.29, libxml.so, libxml.so.2, libxml.so.2.0.2, libssl.so, libssl.so.0.9.8, libthreadutil.so, libthreadutil.so.2, libthreadutil.so.2.0.2, libupnp.so, libupnp.so.2, libupnp.so.2.0.2, libxtables.a, libxtables.la, and haserl under the following license.

## GNU GENERAL PUBLIC LICENSE

Version 2, June 1991

Copyright (C) 1989, 1991 Free Software Foundation, Inc.

59 Temple Place - Suite 330, Boston, MA 02111-1307, USA

Everyone is permitted to copy and distribute verbatim copies of this license document, but changing it is not allowed.

### Preamble

The licenses for most software are designed to take away your freedom to share and change it. By contrast, the GNU General Public License is intended to guarantee your freedom to share and change free software--to make sure the software is free for all its users. This General Public License applies to most of the Free Software Foundation's software and to any other program whose authors commit to using it. (Some other Free Software Foundation software is covered by the GNU Library General Public License instead.) You can apply it to your programs, too.

When we speak of free software, we are referring to freedom, not price. Our General Public Licenses are designed to make sure that you have the freedom to distribute copies of free software (and charge for this service if you wish), that you receive source code or can get it if you want it, that you can change the software or use pieces of it in new free programs; and that you know you can do these things.

To protect your rights, we need to make restrictions that forbid anyone to deny you these rights or to ask you to surrender the rights. These restrictions translate to certain responsibilities for you if you distribute copies of the software, or if you modify it. For example, if you distribute copies of such a program, whether

gratis or for a fee, you must give the recipients all the rights that you have. You must make sure that they, too, receive or can get the source code. And you must show them these terms so they know their rights.

We protect your rights with two steps: (1) copyright the software, and (2) offer you this license which gives you legal permission to copy, distribute and/or modify the software. Also, for each author's protection and ours, we want to make certain that everyone understands that there is no warranty for this free software. If the software is modified by someone else and passed on, we want its recipients to know that what they have is not the original, so that any problems introduced by others will not reflect on the original authors' reputations.

Finally, any free program is threatened constantly by software patents. We wish to avoid the danger that redistributors of a free program will individually obtain patent licenses, in effect making the program proprietary. To prevent this, we have made it clear that any patent must be licensed for everyone's free use or not licensed at all.

The precise terms and conditions for copying, distribution and modification follow.

#### TERMS AND CONDITIONS FOR COPYING, DISTRIBUTION AND MODIFICATION

0. This License applies to any program or other work which contains a notice placed by the copyright holder saying it may be distributed under the terms of this General Public License. The "Program", below, refers to any such program or work, and a "work based on the Program" means either the Program or any derivative work under copyright law: that is to say, a work containing the Program or a portion of it, either verbatim or with modifications and/or translated into another language. (Hereinafter, translation is included without limitation in the term "modification".) Each licensee is addressed as "you". Activities other than copying, distribution and modification are not covered by this License; they are outside its scope. The act of running the Program is not restricted, and the output from the Program is covered only if its contents constitute a work based on the Program (independent of having been made by running the Program). Whether that is true depends on what the Program does.

1. You may copy and distribute verbatim copies of the Program's source code as you receive it, in any medium, provided that you conspicuously and appropriately publish on each copy an appropriate copyright notice and disclaimer of warranty; keep intact all the notices that refer to this License and to the absence of any warranty; and give any other recipients of the Program a copy of this License along with the Program. You may charge a fee for the physical act of transferring a copy, and you may at your option offer warranty protection in exchange for a fee.

2. You may modify your copy or copies of the Program or any portion of it, thus forming a work based on the Program, and copy and distribute such modifications or work under the terms of Section 1 above, provided that you also meet all of these conditions:

a) You must cause the modified files to carry prominent notices stating that you changed the files and the date of any change.

b) You must cause any work that you distribute or publish, that in whole or in part contains or is derived from the Program or any part thereof, to be licensed as a whole at no charge to all third parties under the terms of this License.

c) If the modified program normally reads commands interactively when run, you must cause it, when started running for such interactive use in the most ordinary way, to print or display an announcement including an appropriate copyright notice and a notice that there is no warranty (or else, saying that you provide a warranty) and that users may redistribute the program under these conditions, and telling the user how to view a copy of this License. (Exception: if the Program itself is interactive but does not normally print such an announcement, your work based on the Program is not required to print an announcement.)

These requirements apply to the modified work as a whole. If identifiable sections of that work are not derived from the Program, and can be reasonably considered independent and separate works in themselves, then this License, and its terms, do not apply to those sections when you distribute them as separate works. But when you distribute the same sections as part of a whole which is a work based on the

Program, the distribution of the whole must be on the terms of this License, whose permissions for other licensees extend to the entire whole, and thus to each and every part regardless of who wrote it. Thus, it is not the intent of this section to claim rights or contest your rights to work written entirely by you; rather, the intent is to exercise the right to control the distribution of derivative or collective works based on the Program. In addition, mere aggregation of another work not based on the Program with the Program (or with a work based on the Program) on a volume of a storage or distribution medium does not bring the other work under the scope of this License.

3. You may copy and distribute the Program (or a work based on it, under Section 2) in object code or executable form under the terms of Sections 1 and 2 above provided that you also do one of the following:

a) Accompany it with the complete corresponding machine-readable source code, which must be distributed under the terms of Sections 1 and 2 above on a medium customarily used for software interchange; or,

b) Accompany it with a written offer, valid for at least three years, to give any third party, for a charge no more than your cost of physically performing source distribution, a complete machine-readable copy of the corresponding source code, to be distributed under the terms of Sections 1 and 2 above on a medium customarily used for software interchange; or, c) Accompany it with the information you received as to the offer to distribute corresponding source code. (This alternative is allowed only for noncommercial distribution and only if you received the program in object code or executable form with such an offer, in accord with Subsection b above.) The source code for a work means the preferred form of the work for making modifications to it. For an executable work, complete source code means all the source code for all modules it contains, plus any associated interface definition files, plus the

scripts used to control compilation and installation of the executable. However, as a special exception, the source code distributed need not include anything that is normally distributed (in either source or binary form) with the major components (compiler, kernel, and so on) of the operating system on which the executable runs, unless that component itself accompanies the executable. If distribution of executable or object code is made by offering access to copy from a designated place, then offering equivalent access to copy the source code from the same place counts as distribution of the source code, even though third parties are not compelled to copy the source along with the object code.

4. You may not copy, modify, sublicense, or distribute the Program except as expressly provided under this License. Any attempt otherwise to copy, modify, sublicense or distribute the Program is void, and will automatically terminate your rights under this License. However, parties who have received copies, or rights, from you under this License will not have their licenses terminated so long as such parties remain in full compliance.

5. You are not required to accept this License, since you have not signed it. However, nothing else grants you permission to modify or distribute the Program or its derivative works. These actions are prohibited by law if you do not accept this License. Therefore, by modifying or distributing the Program (or any work based on the Program), you indicate your acceptance of this License to do so, and all its terms and conditions for copying, distributing or modifying the Program or works based on it.

6. Each time you redistribute the Program (or any work based on the Program), the recipient automatically receives a license from the original licensor to copy, distribute or modify the Program subject to these terms and conditions. You may not impose any further restrictions on the recipients' exercise of the rights granted herein. You are not responsible for enforcing compliance by third parties to this License.

7. If, as a consequence of a court judgment or allegation of patent infringement or for any other reason (not limited to patent issues), conditions are imposed on you (whether by court order, agreement or otherwise) that contradict the conditions of this License, they do not excuse you from the conditions of this License. If you cannot distribute so as to satisfy simultaneously your obligations under this License and any other pertinent obligations, then as a consequence you may not distribute the Program at all. For example, if a patent license would not permit royalty-free redistribution of the Program by all those who receive copies directly or indirectly through you, then the only way you could satisfy both it and this License would be to

refrain entirely from distribution of the Program. If any portion of this section is held invalid or unenforceable under any particular circumstance, the balance of the section is intended to apply and the section as a whole is intended to apply in other circumstances. It is not the purpose of this section to induce you to infringe any patents or other property right claims or to contest validity of any such claims; this section has the sole purpose of protecting the integrity of the free software distribution system, which is implemented by public license practices. Many people have made generous contributions to the wide range of software distributed through that system in reliance on consistent application of that system; it is up to the author/donor to decide if he or she is willing to distribute software through any other system and a licensee cannot impose that choice. This section is intended to make thoroughly clear what is believed to be a consequence of the rest of this License.

8. If the distribution and/or use of the Program is restricted in certain countries either by patents or by copyrighted interfaces, the original copyright holder who places the Program under this License may add an explicit geographical distribution limitation excluding those countries, so that distribution is permitted only in or among countries not thus excluded. In such case, this License incorporates the limitation as if written in the body of this License.

9. The Free Software Foundation may publish revised and/or new versions of the General Public License from time to time. Such new versions will be similar in spirit to the present version, but may differ in detail to address new problems or concerns. Each version is given a distinguishing version number. If the Program specifies a version number of this License which applies to it and "any later version", you have the option of following the terms and conditions either of that version or of any later version published by the Free Software Foundation. If the Program does not specify a version number of this License, you may choose any version ever published by the Free Software Foundation.

10. If you wish to incorporate parts of the Program into other free programs whose distribution conditions are different, write to the author to ask for permission. For software which is copyrighted by the Free Software Foundation, write to the Free Software Foundation; we sometimes make exceptions for this. Our decision will be guided by the two goals of preserving the free status of all derivatives of our free software and of promoting the sharing and reuse of software generally.

#### NO WARRANTY

11. BECAUSE THE PROGRAM IS LICENSED FREE OF CHARGE, THERE IS NO WARRANTY FOR THE PROGRAM, TO THE EXTENT PERMITTED BY APPLICABLE LAW. EXCEPT WHEN OTHERWISE STATED IN WRITING THE COPYRIGHT HOLDERS AND/OR OTHER PARTIES PROVIDE THE PROGRAM "AS IS" WITHOUT WARRANTY OF ANY KIND, EITHER EXPRESSED OR IMPLIED, INCLUDING, BUT NOT LIMITED TO, THE IMPLIED WARRANTIES OF MERCHANTABILITY AND FITNESS FOR A PARTICULAR PURPOSE. THE ENTIRE RISK AS TO THE QUALITY AND PERFORMANCE OF THE PROGRAM IS WITH YOU. SHOULD THE PROGRAM PROVE DEFECTIVE, YOU ASSUME THE COST OF ALL NECESSARY SERVICING, REPAIR OR CORRECTION.

12. IN NO EVENT UNLESS REQUIRED BY APPLICABLE LAW OR AGREED TO IN WRITING WILL ANY COPYRIGHT HOLDER, OR ANY OTHER PARTY WHO MAY MODIFY AND/OR REDISTRIBUTE THE PROGRAM AS PERMITTED ABOVE, BE LIABLE TO YOU FOR DAMAGES, INCLUDING ANY GENERAL, SPECIAL, INCIDENTAL OR CONSEQUENTIAL DAMAGES ARISING OUT OF THE USE OR INABILITY TO USE THE PROGRAM (INCLUDING BUT NOT LIMITED TO LOSS OF DATA OR DATA BEING RENDERED INACCURATE OR LOSSES SUSTAINED BY YOU OR THIRD PARTIES OR A FAILURE OF THE PROGRAM TO OPERATE WITH ANY OTHER PROGRAMS), EVEN IF SUCH HOLDER OR OTHER PARTY HAS BEEN ADVISED OF THE POSSIBILITY OF SUCH DAMAGES.

#### END OF TERMS AND CONDITIONS

All other trademarks or trade names mentioned herein, if any, are the property of their respective owners.

This product contains addgroup, adduser, ash, busybox, cat, chatr, chgrp, chmod, chown, cp, cttyhack, date, dd, delgroup, deluser, df, dmesg, echo, egrep, false, fgrep, grep, gnuzip, gzip, hostname, ip, ipaddr, iplink, iproute, kill, ln, login, ls, lsattr, mkdir, mknod, mktemp, more, mount, mountpoint, mv, netstat, nice, ping, ping6, ps, pwd, rm, sed, sh, sleep, stat, sty, su, sync, tar, touch, true, umount, uname, usleep, vi, watch, zcat, adjtimex, arp, blkid, depmod, devmem, fdisk, freeramdisk, fsck, fsck.minix, getty, hatl, hwclock, ifconfig, ifdown, ifup, init, insmod, klogd, logread, losetup, lsmmod, makedevs, mdev, mkds.minix, mkswap, modprobe, pivot\_root, poweroff, reboot, rmod, route, runlevel, start-stop-daemon, sulogin, swapoff, swapon, switch\_root, sysctl, syslogd, udhcpc, and watchdog under the following license:

## GNU LIBRARY GENERAL PUBLIC LICENSE

Version 2, June 1991

Copyright (C) 1991 Free Software Foundation, Inc.  
51 Franklin St, Fifth Floor, Boston, MA 02110-1301, USA  
Everyone is permitted to copy and distribute verbatim copies  
of this license document, but changing it is not allowed.

[This is the first released version of the library GPL. It is  
numbered 2 because it goes with version 2 of the ordinary GPL.]

### Preamble

The licenses for most software are designed to take away your freedom to share and change it. By contrast, the GNU General Public Licenses are intended to guarantee your freedom to share and change free software--to make sure the software is free for all its users.

This license, the Library General Public License, applies to some specially designated Free Software Foundation software, and to any other libraries whose authors decide to use it. You can use it for your libraries, too.

When we speak of free software, we are referring to freedom, not price. Our General Public Licenses are designed to make sure that you have the freedom to distribute copies of free software (and charge for this service if you wish), that you receive source code or can get it if you want it, that you can change the software or use pieces of it in new free programs; and that you know you can do these things.

To protect your rights, we need to make restrictions that forbid anyone to deny you these rights or to ask you to surrender the rights. These restrictions translate to certain responsibilities for you if you distribute copies of the library, or if you modify it.

For example, if you distribute copies of the library, whether gratis or for a fee, you must give the recipients all the rights that we gave you. You must make sure that they, too, receive or can get the source code. If you link a program with the library, you must provide complete object files to the recipients so that they can relink them with the library, after making changes to the library and recompiling it. And you must show them these terms so they know their rights.

Our method of protecting your rights has two steps: (1) copyright the library, and (2) offer you this license which gives you legal permission to copy, distribute and/or modify the library.

Also, for each distributor's protection, we want to make certain that everyone understands that there is no warranty for this free library. If the library is modified by someone else and passed on, we want its recipients to know that what they have is not the original version, so that any problems introduced by others will not reflect on the original authors' reputations.

Finally, any free program is threatened constantly by software patents. We wish to avoid the danger that companies distributing free software will individually obtain patent licenses, thus in effect transforming the program into proprietary software. To prevent this, we have made it clear that any patent must be licensed for everyone's free use or not licensed at all.

Most GNU software, including some libraries, is covered by the ordinary GNU General Public License, which was designed for utility programs. This license, the GNU Library General Public License, applies to certain designated libraries. This license is quite different from the ordinary one; be sure to read it in full, and don't assume that anything in it is the same as in the ordinary license.

The reason we have a separate public license for some libraries is that they blur the distinction we usually make between modifying or adding to a program and simply using it. Linking a program with a library, without changing the library, is in some sense simply using the library, and is analogous to running a utility program or application program. However, in a textual and legal sense, the linked executable is a combined work, a derivative of the original library, and the ordinary General Public License treats it as such.

Because of this blurred distinction, using the ordinary General Public License for libraries did not effectively promote software sharing, because most developers did not use the libraries. We concluded that weaker conditions might promote sharing better.

However, unrestricted linking of non-free programs would deprive the users of those programs of all benefit from the free status of the libraries themselves. This Library General Public License is intended to permit developers of non-free programs to use free libraries, while preserving your freedom as a user of such programs to change the free libraries that are incorporated in them. (We have not seen how to achieve this as regards changes in header files, but we have achieved it as regards changes in the actual functions of the Library.) The hope is that this will lead to faster development of free libraries.

The precise terms and conditions for copying, distribution and modification follow. Pay close attention to the difference between a "work based on the library" and a "work that uses the library". The former contains code derived from the library, while the latter only works together with the library.

Note that it is possible for a library to be covered by the ordinary General Public License rather than by this special one.

#### TERMS AND CONDITIONS FOR COPYING, DISTRIBUTION AND MODIFICATION

0. This License Agreement applies to any software library which contains a notice placed by the copyright holder or other authorized party saying it may be distributed under the terms of this Library General Public License (also called "this License"). Each licensee is addressed as "you".

A "library" means a collection of software functions and/or data prepared so as to be conveniently linked with application programs (which use some of those functions and data) to form executables.

The "Library", below, refers to any such software library or work which has been distributed under these terms. A "work based on the Library" means either the Library or any derivative work under copyright law: that is to say, a work containing the Library or a portion of it, either verbatim or with modifications and/or translated straightforwardly into another language. (Hereinafter, translation is included without limitation in the term "modification".)

"Source code" for a work means the preferred form of the work for making modifications to it. For a library, complete source code means all the source code for all modules it contains, plus any associated interface definition files, plus the scripts used to control compilation and installation of the library.

Activities other than copying, distribution and modification are not covered by this License; they are outside its scope. The act of running a program using the Library is not restricted, and output from such a program is covered only if its contents constitute a work based on the Library (independent of the use of the Library in a tool for writing it). Whether that is true depends on what the Library does and what the program that uses the Library does.

1. You may copy and distribute verbatim copies of the Library's complete source code as you receive it, in any medium, provided that you conspicuously and appropriately publish on each copy an appropriate copyright notice and disclaimer of warranty; keep intact all the notices that refer to this License and to the absence of any warranty; and distribute a copy of this License along with the Library.

You may charge a fee for the physical act of transferring a copy, and you may at your option offer warranty protection in exchange for a fee.

2. You may modify your copy or copies of the Library or any portion of it, thus forming a work based on the Library, and copy and distribute such modifications or work under the terms of Section 1 above, provided that you also meet all of these conditions:

\* a) The modified work must itself be a software library.

\* b) You must cause the files modified to carry prominent notices stating that you changed the files and the date of any change.

\* c) You must cause the whole of the work to be licensed at no charge to all third parties under the terms of this License.

\* d) If a facility in the modified Library refers to a function or a table of data to be supplied by an application program that uses the facility, other than as an argument passed when the facility is invoked, then you must make a good faith effort to ensure that, in the event an application does not supply such function or table, the facility still operates, and performs whatever part of its purpose remains meaningful.

(For example, a function in a library to compute square roots has a purpose that is entirely well-defined independent of the application. Therefore, Subsection 2d requires that any application-supplied function or table used by this function must be optional: if the application does not supply it, the square root function must still compute square roots.)

These requirements apply to the modified work as a whole. If identifiable sections of that work are not derived from the Library, and can be reasonably considered independent and separate works in themselves, then this License, and its terms, do not apply to those sections when you distribute them as separate works. But when you distribute the same sections as part of a whole which is a work based on the Library, the distribution of the whole must be on the terms of this License, whose permissions for other licensees extend to the entire whole, and thus to each and every part regardless of who wrote it.

Thus, it is not the intent of this section to claim rights or contest your rights to work written entirely by you; rather, the intent is to exercise the right to control the distribution of derivative or collective works based on the Library.

In addition, mere aggregation of another work not based on the Library with the Library (or with a work based on the Library) on a volume of a storage or distribution medium does not bring the other work under the scope of this License.

3. You may opt to apply the terms of the ordinary GNU General Public License instead of this License to a given copy of the Library. To do this, you must alter all the notices that refer to this License, so that they refer to the ordinary GNU General Public License, version 2, instead of to this License. (If a newer version than version 2 of the ordinary GNU General Public License has appeared, then you can specify that version instead if you wish.) Do not make any other change in these notices.

Once this change is made in a given copy, it is irreversible for that copy, so the ordinary GNU General Public License applies to all subsequent copies and derivative works made from that copy.

This option is useful when you wish to copy part of the code of the Library into a program that is not a library.

4. You may copy and distribute the Library (or a portion or derivative of it, under Section 2) in object code or executable form under the terms of Sections 1 and 2 above provided that you accompany it with the complete corresponding machine-readable source code, which must be distributed under the terms of Sections 1 and 2 above on a medium customarily used for software interchange.

If distribution of object code is made by offering access to copy from a designated place, then offering equivalent access to copy the source code from the same place satisfies the requirement to distribute the source code, even though third parties are not compelled to copy the source along with the object code.

5. A program that contains no derivative of any portion of the Library, but is designed to work with the Library by being compiled or linked with it, is called a "work that uses the Library". Such a work, in isolation, is not a derivative work of the Library, and therefore falls outside the scope of this License.

However, linking a "work that uses the Library" with the Library creates an executable that is a derivative of the Library (because it contains portions of the Library), rather than a "work that uses the library". The executable is therefore covered by this License. Section 6 states terms for distribution of such executables.

When a "work that uses the Library" uses material from a header file that is part of the Library, the object code for the work may be a derivative work of the Library even though the source code is not. Whether this is true is especially significant if the work can be linked without the Library, or if the work is itself a library. The threshold for this to be true is not precisely defined by law.

If such an object file uses only numerical parameters, data structure layouts and accessors, and small macros and small inline functions (ten lines or less in length), then the use of the object file is unrestricted, regardless of whether it is legally a derivative work. (Executables containing this object code plus portions of the Library will still fall under Section 6.)



Otherwise, if the work is a derivative of the Library, you may distribute the object code for the work under the terms of Section 6. Any executables containing that work also fall under Section 6, whether or not they are linked directly with the Library itself.

6. As an exception to the Sections above, you may also compile or link a "work that uses the Library" with the Library to produce a work containing portions of the Library, and distribute that work under terms of your choice, provided that the terms permit modification of the work for the customer's own use and reverse engineering for debugging such modifications.

You must give prominent notice with each copy of the work that the Library is used in it and that the Library and its use are covered by this License. You must supply a copy of this License. If the work during execution displays copyright notices, you must include the copyright notice for the Library among them, as well as a reference directing the user to the copy of this License. Also, you must do one of these things:

- \* a) Accompany the work with the complete corresponding machine-readable source code for the Library including whatever changes were used in the work (which must be distributed under Sections 1 and 2 above); and, if the work is an executable linked with the Library, with the complete machine-readable "work that uses the Library", as object code and/or source code, so that the user can modify the Library and then relink to produce a modified executable containing the modified Library. (It is understood that the user who changes the contents of definitions files in the Library will not necessarily be able to recompile the application to use the modified definitions.)

- \* b) Accompany the work with a written offer, valid for at least three years, to give the same user the materials specified in Subsection 6a, above, for a charge no more than the cost of performing this distribution.

- \* c) If distribution of the work is made by offering access to copy from a designated place, offer equivalent access to copy the above specified materials from the same place.

- \* d) Verify that the user has already received a copy of these materials or that you have already sent this user a copy.

For an executable, the required form of the "work that uses the Library" must include any data and utility programs needed for reproducing the executable from it. However, as a special exception, the source code distributed need not include anything that is normally distributed (in either source or binary form) with the major components (compiler, kernel, and so on) of the operating system on which the executable runs, unless that component itself accompanies the executable.

It may happen that this requirement contradicts the license restrictions of other proprietary libraries that do not normally accompany the operating system. Such a contradiction means you cannot use both them and the Library together in an executable that you distribute.

7. You may place library facilities that are a work based on the Library side-by-side in a single library together with other library facilities not covered by this License, and distribute such a combined library, provided that the separate distribution of the work based on the Library and of the other library facilities is otherwise permitted, and provided that you do these two things:

- \* a) Accompany the combined library with a copy of the same work based on the Library, uncombined with any other library facilities. This must be distributed under the terms of the Sections above.

- \* b) Give prominent notice with the combined library of the fact that part of it is a work based on the Library, and explaining where to find the accompanying uncombined form of the same work.

8. You may not copy, modify, sublicense, link with, or distribute the Library except as expressly provided under this License. Any attempt otherwise to copy, modify, sublicense, link with, or distribute the Library is void, and will automatically terminate your rights under this License. However, parties who have received copies, or rights, from you under this License will not have their licenses terminated so long as such parties remain in full compliance.

9. You are not required to accept this License, since you have not signed it. However, nothing else grants you permission to modify or distribute the Library or its derivative works. These actions are prohibited by law if you do not accept this License. Therefore, by modifying or distributing the Library (or any work based on the Library), you indicate your acceptance of this License to do so, and all its terms and conditions for copying, distributing or modifying the Library or works based on it.

10. Each time you redistribute the Library (or any work based on the Library), the recipient automatically receives a license from the original licensor to copy, distribute, link with or modify the Library subject to these terms and conditions. You may not impose any further restrictions on the recipients' exercise of the rights granted herein. You are not responsible for enforcing compliance by third parties to this License.

11. If, as a consequence of a court judgment or allegation of patent infringement or for any other reason (not limited to patent issues), conditions are imposed on you (whether by court order, agreement or otherwise) that contradict the conditions of this License, they do not excuse you from the conditions of this License. If you cannot distribute so as to satisfy simultaneously your obligations under this License and any other pertinent obligations, then as a consequence you may not distribute the Library at all. For example, if a patent license would not permit royalty-free redistribution of the Library by all those who receive copies directly or indirectly through you, then the only way you could satisfy both it and this License would be to refrain entirely from distribution of the Library.

If any portion of this section is held invalid or unenforceable under any particular circumstance, the balance of the section is intended to apply, and the section as a whole is intended to apply in other circumstances.

It is not the purpose of this section to induce you to infringe any patents or other property right claims or to contest validity of any such claims; this section has the sole purpose of protecting the integrity of the free software distribution system which is implemented by public license practices. Many people have made generous contributions to the wide range of software distributed through that system in reliance on consistent application of that system; it is up to the author/donor to decide if he or she is willing to distribute software through any other system and a licensee cannot impose that choice.

This section is intended to make thoroughly clear what is believed to be a consequence of the rest of this License.

12. If the distribution and/or use of the Library is restricted in certain countries either by patents or by copyrighted interfaces, the original copyright holder who places the Library under this License may add an explicit geographical distribution limitation excluding those countries, so that distribution is permitted only in or among countries not thus excluded. In such case, this License incorporates the limitation as if written in the body of this License.

13. The Free Software Foundation may publish revised and/or new versions of the Library General Public License from time to time. Such new versions will be similar in spirit to the present version, but may differ in detail to address new problems or concerns.

Each version is given a distinguishing version number. If the Library specifies a version number of this License which applies to it and "any later version", you have the option of following the terms and conditions either of that version or of any later version published by the Free Software Foundation. If the Library does not specify a license version number, you may choose any version ever published by the Free Software Foundation.

14. If you wish to incorporate parts of the Library into other free programs whose distribution conditions are incompatible with these, write to the author to ask for permission. For software which is copyrighted by the Free Software Foundation, write to the Free Software Foundation; we sometimes make exceptions for this. Our decision will be guided by the two goals of preserving the free status of all derivatives of our free software and of promoting the sharing and reuse of software generally.

#### NO WARRANTY

15. BECAUSE THE LIBRARY IS LICENSED FREE OF CHARGE, THERE IS NO WARRANTY FOR THE LIBRARY, TO THE EXTENT PERMITTED BY APPLICABLE LAW. EXCEPT WHEN OTHERWISE STATED IN WRITING THE COPYRIGHT HOLDERS AND/OR OTHER PARTIES PROVIDE THE LIBRARY "AS IS" WITHOUT WARRANTY OF ANY KIND, EITHER EXPRESSED OR IMPLIED, INCLUDING, BUT NOT LIMITED TO, THE IMPLIED WARRANTIES OF MERCHANTABILITY AND FITNESS FOR A PARTICULAR PURPOSE. THE ENTIRE RISK AS TO THE QUALITY AND PERFORMANCE OF THE LIBRARY IS WITH YOU. SHOULD THE LIBRARY PROVE DEFECTIVE, YOU ASSUME THE COST OF ALL NECESSARY SERVICING, REPAIR OR CORRECTION.

16. IN NO EVENT UNLESS REQUIRED BY APPLICABLE LAW OR AGREED TO IN WRITING WILL ANY COPYRIGHT HOLDER, OR ANY OTHER PARTY WHO MAY MODIFY AND/OR REDISTRIBUTE THE LIBRARY AS PERMITTED ABOVE, BE LIABLE TO YOU FOR DAMAGES, INCLUDING ANY GENERAL, SPECIAL, INCIDENTAL OR CONSEQUENTIAL DAMAGES ARISING OUT OF THE USE OR INABILITY TO USE THE LIBRARY (INCLUDING BUT NOT LIMITED TO LOSS OF DATA OR DATA BEING RENDERED INACCURATE OR LOSSES SUSTAINED BY YOU OR THIRD PARTIES OR A FAILURE OF THE LIBRARY TO OPERATE WITH ANY OTHER SOFTWARE), EVEN IF SUCH HOLDER OR OTHER PARTY HAS BEEN ADVISED OF THE POSSIBILITY OF SUCH DAMAGES.

END OF TERMS AND CONDITIONS

How to Apply These Terms to Your New Libraries

If you develop a new library, and you want it to be of the greatest possible use to the public, we recommend making it free software that everyone can redistribute and change. You can do so by permitting redistribution under these terms (or, alternatively, under the terms of the ordinary General Public License).

To apply these terms, attach the following notices to the library. It is safest to attach them to the start of each source file to most effectively convey the exclusion of warranty; and each file should have at least the "copyright" line and a pointer to where the full notice is found.

one line to give the library's name and an idea of what it does.

Copyright (C) year name of author

This library is free software; you can redistribute it and/or modify it under the terms of the GNU Library General Public

License as published by the Free Software Foundation; either version 2 of the License, or (at your option) any later version.

This library is distributed in the hope that it will be useful, but WITHOUT ANY WARRANTY; without even the implied warranty of MERCHANTABILITY or FITNESS FOR A PARTICULAR PURPOSE. See the GNU Library General Public License for more details.

You should have received a copy of the GNU Library General Public License along with this library; if not, write to the Free Software Foundation, Inc., 51 Franklin St, Fifth Floor, Boston, MA 02110-1301, USA.

Also add information on how to contact you by electronic and paper mail.

You should also get your employer (if you work as a programmer) or your school, if any, to sign a "copyright disclaimer" for the library, if necessary. Here is a sample; alter the names:

Yoyodyne, Inc., hereby disclaims all copyright interest in the library `Frob' (a library for tweaking knobs) written by James Random Hacker.

signature of Ty Coon, 1 April 1990  
Ty Coon, President of Vice

That's all there is to it!

This product contains ld-2.11.so, ld-linux.so.3, libc.so, libc.so.6, libc-2.11.so, libcrypt.so, libcrypt.so.1, libcrypt-2.11.so, libdl.so, libdl.so.2, libdl-2.11.so, libgcc\_s.so, libgcc\_s.so.1, libm.so, libm.so.6, libm-2.11.so, libnsl.so, libnsl.so.1, libnsl-2.11.so, libnss\_dns.so, libnss\_dns.so.2, libnss\_dns-2.11.so, libnss\_files.so, libnss\_files.so.2, libnss\_files-2.11.so, libpthread.so, libpthread.so.0, libpthread-2.11.so, libresolv.so, libresolv.so.2, libresolv-2.11.so, librt.so, librt.so.1, librt-2.11.so, libstdc++.so, libstdc++.so.6, libstdc++.so.6.0.11, libthread\_db.so, libthread\_db.so.1, libthread\_db-1.0.so, libutil.so, libutil.so.1, and libutil-2.11.so under the following license:

## GNU GENERAL PUBLIC LICENSE

Version 3, 29 June 2007

Copyright © 2007 Free Software Foundation, Inc. <<http://fsf.org/>>

Everyone is permitted to copy and distribute verbatim copies of this license document, but changing it is not allowed.

### Preamble

The GNU General Public License is a free, copyleft license for software and other kinds of works.

The licenses for most software and other practical works are designed to take away your freedom to share and change the works. By contrast, the GNU General Public License is intended to guarantee your freedom to share and change all versions of a program--to make sure it remains free software for all its users. We, the Free Software Foundation, use the GNU General Public License for most of our software; it applies also to any other work released this way by its authors. You can apply it to your programs, too.

When we speak of free software, we are referring to freedom, not price. Our General Public Licenses are designed to make sure that you have the freedom to distribute copies of free software (and charge for them if you wish), that you receive source code or can get it if you want it, that you can change the software or use pieces of it in new free programs, and that you know you can do these things.

To protect your rights, we need to prevent others from denying you these rights or asking you to surrender the rights. Therefore, you have certain responsibilities if you distribute copies of the software, or if you modify it: responsibilities to respect the freedom of others.

For example, if you distribute copies of such a program, whether gratis or for a fee, you must pass on to the recipients the same freedoms that you received. You must make sure that they, too, receive or can get the source code. And you must show them these terms so they know their rights.

Developers that use the GNU GPL protect your rights with two steps: (1) assert copyright on the software, and (2) offer you this License giving you legal permission to copy, distribute and/or modify it.

For the developers' and authors' protection, the GPL clearly explains that there is no warranty for this free software. For both users' and authors' sake, the GPL requires that modified versions be marked as changed, so that their problems will not be attributed erroneously to authors of previous versions.

Some devices are designed to deny users access to install or run modified versions of the software inside them, although the manufacturer can do so. This is fundamentally incompatible with the aim of protecting users' freedom to change the software. The systematic pattern of such abuse occurs in the area of products for individuals to use, which is precisely where it is most unacceptable. Therefore, we have designed this version of the GPL to prohibit the practice for those products. If such problems arise substantially in other

domains, we stand ready to extend this provision to those domains in future versions of the GPL, as needed to protect the freedom of users.

Finally, every program is threatened constantly by software patents. States should not allow patents to restrict development and use of software on general-purpose computers, but in those that do, we wish to avoid the special danger that patents applied to a free program could make it effectively proprietary. To prevent this, the GPL assures that patents cannot be used to render the program non-free.

The precise terms and conditions for copying, distribution and modification follow.

## TERMS AND CONDITIONS

### **0. Definitions.**

“This License” refers to version 3 of the GNU General Public License.

“Copyright” also means copyright-like laws that apply to other kinds of works, such as semiconductor masks.

“The Program” refers to any copyrightable work licensed under this License. Each licensee is addressed as “you”. “Licensees” and “recipients” may be individuals or organizations.

To “modify” a work means to copy from or adapt all or part of the work in a fashion requiring copyright permission, other than the making of an exact copy. The resulting work is called a “modified version” of the earlier work or a work “based on” the earlier work.

A “covered work” means either the unmodified Program or a work based on the Program.

To “propagate” a work means to do anything with it that, without permission, would make you directly or secondarily liable for infringement under applicable copyright law, except executing it on a computer or modifying a private copy. Propagation includes copying, distribution (with or without modification), making available to the public, and in some countries other activities as well.

To “convey” a work means any kind of propagation that enables other parties to make or receive copies. Mere interaction with a user through a computer network, with no transfer of a copy, is not conveying.

An interactive user interface displays “Appropriate Legal Notices” to the extent that it includes a convenient and prominently visible feature that (1) displays an appropriate copyright notice, and (2) tells the user that there is no warranty for the work (except to the extent that warranties are provided), that licensees may convey the work under this License, and how to view a copy of this License. If the interface presents a list of user commands or options, such as a menu, a prominent item in the list meets this criterion.

### **1. Source Code.**

The “source code” for a work means the preferred form of the work for making modifications to it. “Object code” means any non-source form of a work.

A “Standard Interface” means an interface that either is an official standard defined by a recognized standards body, or, in the case of interfaces specified for a particular programming language, one that is widely used among developers working in that language.

The “System Libraries” of an executable work include anything, other than the work as a whole, that (a) is included in the normal form of packaging a Major Component, but which is not part of that Major Component, and (b) serves only to enable use of the work with that Major Component, or to implement a Standard Interface for which an implementation is available to the public in source code form. A “Major Component”, in this context, means a major essential component (kernel, window system, and so on) of the specific operating system (if any) on which the executable work runs, or a compiler used to produce the work, or an object code interpreter used to run it.

The “Corresponding Source” for a work in object code form means all the source code needed to generate, install, and (for an executable work) run the object code and to modify the work, including scripts to control those activities. However, it does not include the work's System Libraries, or general-purpose tools or generally available free programs which are used unmodified in performing those activities but which are not part of the work. For example, Corresponding Source includes interface definition files associated with source files for the work, and the source code for shared libraries and dynamically linked subprograms that the work is specifically designed to require, such as by intimate data communication or control flow between those subprograms and other parts of the work.

The Corresponding Source need not include anything that users can regenerate automatically from other parts of the Corresponding Source.

The Corresponding Source for a work in source code form is that same work.

## **2. Basic Permissions.**

All rights granted under this License are granted for the term of copyright on the Program, and are irrevocable provided the stated conditions are met. This License explicitly affirms your unlimited permission to run the unmodified Program. The output from running a covered work is covered by this License only if the output, given its content, constitutes a covered work. This License acknowledges your rights of fair use or other equivalent, as provided by copyright law.

You may make, run and propagate covered works that you do not convey, without conditions so long as your license otherwise remains in force. You may convey covered works to others for the sole purpose of having them make modifications exclusively for you, or provide you with facilities for running those works, provided that you comply with the terms of this License in conveying all material for which you do not control copyright. Those thus making or running the covered works for you must do so exclusively on your behalf, under your direction and control, on terms that prohibit them from making any copies of your copyrighted material outside their relationship with you.

Conveying under any other circumstances is permitted solely under the conditions stated below. Sublicensing is not allowed; section 10 makes it unnecessary.

## **3. Protecting Users' Legal Rights From Anti-Circumvention Law.**

No covered work shall be deemed part of an effective technological measure under any applicable law fulfilling obligations under article 11 of the WIPO copyright treaty adopted on 20 December 1996, or similar laws prohibiting or restricting circumvention of such measures.

When you convey a covered work, you waive any legal power to forbid circumvention of technological measures to the extent such circumvention is effected by exercising rights under this License with respect to the covered work, and you disclaim any intention to limit operation or modification of the work as a means of enforcing, against the work's users, your or third parties' legal rights to forbid circumvention of technological measures.

#### **4. Conveying Verbatim Copies.**

You may convey verbatim copies of the Program's source code as you receive it, in any medium, provided that you conspicuously and appropriately publish on each copy an appropriate copyright notice; keep intact all notices stating that this License and any non-permissive terms added in accord with section 7 apply to the code; keep intact all notices of the absence of any warranty; and give all recipients a copy of this License along with the Program.

You may charge any price or no price for each copy that you convey, and you may offer support or warranty protection for a fee.

#### **5. Conveying Modified Source Versions.**

You may convey a work based on the Program, or the modifications to produce it from the Program, in the form of source code under the terms of section 4, provided that you also meet all of these conditions:

- a) The work must carry prominent notices stating that you modified it, and giving a relevant date.
- b) The work must carry prominent notices stating that it is released under this License and any conditions added under section 7. This requirement modifies the requirement in section 4 to “keep intact all notices”.
- c) You must license the entire work, as a whole, under this License to anyone who comes into possession of a copy. This License will therefore apply, along with any applicable section 7 additional terms, to the whole of the work, and all its parts, regardless of how they are packaged. This License gives no permission to license the work in any other way, but it does not invalidate such permission if you have separately received it.
- d) If the work has interactive user interfaces, each must display Appropriate Legal Notices; however, if the Program has interactive interfaces that do not display Appropriate Legal Notices, your work need not make them do so.

A compilation of a covered work with other separate and independent works, which are not by their nature extensions of the covered work, and which are not combined with it such as to form a larger program, in or on a volume of a storage or distribution medium, is called an “aggregate” if the compilation and its resulting copyright are not used to limit the access or legal rights of the compilation's users beyond what the individual works permit. Inclusion of a covered work in an aggregate does not cause this License to apply to the other parts of the aggregate.

#### **6. Conveying Non-Source Forms.**

You may convey a covered work in object code form under the terms of sections 4 and 5, provided that you also convey the machine-readable Corresponding Source under the terms of this License, in one of these ways:

- a) Convey the object code in, or embodied in, a physical product (including a physical distribution medium), accompanied by the Corresponding Source fixed on a durable physical medium customarily used for software interchange.
- b) Convey the object code in, or embodied in, a physical product (including a physical distribution medium), accompanied by a written offer, valid for at least three years and valid for as long as you offer spare parts or customer support for that product model, to give anyone who possesses the object code either (1) a copy of the Corresponding Source for all the software in the product that is covered by this License, on a durable physical medium customarily used for software interchange, for a price no more than your reasonable cost of physically performing this conveying of source, or (2) access to copy the Corresponding Source from a network server at no charge.



- c) Convey individual copies of the object code with a copy of the written offer to provide the Corresponding Source. This alternative is allowed only occasionally and noncommercially, and only if you received the object code with such an offer, in accord with subsection 6b.
- d) Convey the object code by offering access from a designated place (gratis or for a charge), and offer equivalent access to the Corresponding Source in the same way through the same place at no further charge. You need not require recipients to copy the Corresponding Source along with the object code. If the place to copy the object code is a network server, the Corresponding Source may be on a different server (operated by you or a third party) that supports equivalent copying facilities, provided you maintain clear directions next to the object code saying where to find the Corresponding Source. Regardless of what server hosts the Corresponding Source, you remain obligated to ensure that it is available for as long as needed to satisfy these requirements.
- e) Convey the object code using peer-to-peer transmission, provided you inform other peers where the object code and Corresponding Source of the work are being offered to the general public at no charge under subsection 6d.

A separable portion of the object code, whose source code is excluded from the Corresponding Source as a System Library, need not be included in conveying the object code work.

A “User Product” is either (1) a “consumer product”, which means any tangible personal property which is normally used for personal, family, or household purposes, or (2) anything designed or sold for incorporation into a dwelling. In determining whether a product is a consumer product, doubtful cases shall be resolved in favor of coverage. For a particular product received by a particular user, “normally used” refers to a typical or common use of that class of product, regardless of the status of the particular user or of the way in which the particular user actually uses, or expects or is expected to use, the product. A product is a consumer product regardless of whether the product has substantial commercial, industrial or non-consumer uses, unless such uses represent the only significant mode of use of the product.

“Installation Information” for a User Product means any methods, procedures, authorization keys, or other information required to install and execute modified versions of a covered work in that User Product from a modified version of its Corresponding Source. The information must suffice to ensure that the continued functioning of the modified object code is in no case prevented or interfered with solely because modification has been made.

If you convey an object code work under this section in, or with, or specifically for use in, a User Product, and the conveying occurs as part of a transaction in which the right of possession and use of the User Product is transferred to the recipient in perpetuity or for a fixed term (regardless of how the transaction is characterized), the Corresponding Source conveyed under this section must be accompanied by the Installation Information. But this requirement does not apply if neither you nor any third party retains the ability to install modified object code on the User Product (for example, the work has been installed in ROM).

The requirement to provide Installation Information does not include a requirement to continue to provide support service, warranty, or updates for a work that has been modified or installed by the recipient, or for the User Product in which it has been modified or installed. Access to a network may be denied when the modification itself materially and adversely affects the operation of the network or violates the rules and protocols for communication across the network.

Corresponding Source conveyed, and Installation Information provided, in accord with this section must be in a format that is publicly documented (and with an implementation available to the public in source code form), and must require no special password or key for unpacking, reading or copying.

## **7. Additional Terms.**

“Additional permissions” are terms that supplement the terms of this License by making exceptions from one or more of its conditions. Additional permissions that are applicable to the entire Program shall be treated as though they were included in this License, to the extent that they are valid under applicable law. If additional permissions apply only to part of the Program, that part may be used separately under those permissions, but the entire Program remains governed by this License without regard to the additional permissions.

When you convey a copy of a covered work, you may at your option remove any additional permissions from that copy, or from any part of it. (Additional permissions may be written to require their own removal in certain cases when you modify the work.) You may place additional permissions on material, added by you to a covered work, for which you have or can give appropriate copyright permission.

Notwithstanding any other provision of this License, for material you add to a covered work, you may (if authorized by the copyright holders of that material) supplement the terms of this License with terms:

- a) Disclaiming warranty or limiting liability differently from the terms of sections 15 and 16 of this License; or
- b) Requiring preservation of specified reasonable legal notices or author attributions in that material or in the Appropriate Legal Notices displayed by works containing it; or
- c) Prohibiting misrepresentation of the origin of that material, or requiring that modified versions of such material be marked in reasonable ways as different from the original version; or
- d) Limiting the use for publicity purposes of names of licensors or authors of the material; or
- e) Declining to grant rights under trademark law for use of some trade names, trademarks, or service marks; or
- f) Requiring indemnification of licensors and authors of that material by anyone who conveys the material (or modified versions of it) with contractual assumptions of liability to the recipient, for any liability that these contractual assumptions directly impose on those licensors and authors.

All other non-permissive additional terms are considered “further restrictions” within the meaning of section 10. If the Program as you received it, or any part of it, contains a notice stating that it is governed by this License along with a term that is a further restriction, you may remove that term. If a license document contains a further restriction but permits relicensing or conveying under this License, you may add to a covered work material governed by the terms of that license document, provided that the further restriction does not survive such relicensing or conveying.

If you add terms to a covered work in accord with this section, you must place, in the relevant source files, a statement of the additional terms that apply to those files, or a notice indicating where to find the applicable terms.

Additional terms, permissive or non-permissive, may be stated in the form of a separately written license, or stated as exceptions; the above requirements apply either way.

## **8. Termination.**

You may not propagate or modify a covered work except as expressly provided under this License. Any attempt otherwise to propagate or modify it is void, and will automatically terminate your rights under this License (including any patent licenses granted under the third paragraph of section 11).

However, if you cease all violation of this License, then your license from a particular copyright holder is reinstated (a) provisionally, unless and until the copyright holder explicitly and finally terminates your

license, and (b) permanently, if the copyright holder fails to notify you of the violation by some reasonable means prior to 60 days after the cessation.

Moreover, your license from a particular copyright holder is reinstated permanently if the copyright holder notifies you of the violation by some reasonable means, this is the first time you have received notice of violation of this License (for any work) from that copyright holder, and you cure the violation prior to 30 days after your receipt of the notice.

Termination of your rights under this section does not terminate the licenses of parties who have received copies or rights from you under this License. If your rights have been terminated and not permanently reinstated, you do not qualify to receive new licenses for the same material under section 10.

### **9. Acceptance Not Required for Having Copies.**

You are not required to accept this License in order to receive or run a copy of the Program. Ancillary propagation of a covered work occurring solely as a consequence of using peer-to-peer transmission to receive a copy likewise does not require acceptance. However, nothing other than this License grants you permission to propagate or modify any covered work. These actions infringe copyright if you do not accept this License. Therefore, by modifying or propagating a covered work, you indicate your acceptance of this License to do so.

### **10. Automatic Licensing of Downstream Recipients.**

Each time you convey a covered work, the recipient automatically receives a license from the original licensors, to run, modify and propagate that work, subject to this License. You are not responsible for enforcing compliance by third parties with this License.

An “entity transaction” is a transaction transferring control of an organization, or substantially all assets of one, or subdividing an organization, or merging organizations. If propagation of a covered work results from an entity transaction, each party to that transaction who receives a copy of the work also receives whatever licenses to the work the party's predecessor in interest had or could give under the previous paragraph, plus a right to possession of the Corresponding Source of the work from the predecessor in interest, if the predecessor has it or can get it with reasonable efforts.

You may not impose any further restrictions on the exercise of the rights granted or affirmed under this License. For example, you may not impose a license fee, royalty, or other charge for exercise of rights granted under this License, and you may not initiate litigation (including a cross-claim or counterclaim in a lawsuit) alleging that any patent claim is infringed by making, using, selling, offering for sale, or importing the Program or any portion of it.

### **11. Patents.**

A “contributor” is a copyright holder who authorizes use under this License of the Program or a work on which the Program is based. The work thus licensed is called the contributor's “contributor version”.

A contributor's “essential patent claims” are all patent claims owned or controlled by the contributor, whether already acquired or hereafter acquired, that would be infringed by some manner, permitted by this License, of making, using, or selling its contributor version, but do not include claims that would be infringed only as a consequence of further modification of the contributor version. For purposes of this definition, “control” includes the right to grant patent sublicenses in a manner consistent with the requirements of this License.

Each contributor grants you a non-exclusive, worldwide, royalty-free patent license under the contributor's essential patent claims, to make, use, sell, offer for sale, import and otherwise run, modify and propagate the contents of its contributor version.

In the following three paragraphs, a “patent license” is any express agreement or commitment, however denominated, not to enforce a patent (such as an express permission to practice a patent or covenant not to sue for patent infringement). To “grant” such a patent license to a party means to make such an agreement or commitment not to enforce a patent against the party.

If you convey a covered work, knowingly relying on a patent license, and the Corresponding Source of the work is not available for anyone to copy, free of charge and under the terms of this License, through a publicly available network server or other readily accessible means, then you must either (1) cause the Corresponding Source to be so available, or (2) arrange to deprive yourself of the benefit of the patent license for this particular work, or (3) arrange, in a manner consistent with the requirements of this License, to extend the patent license to downstream recipients. “Knowingly relying” means you have actual knowledge that, but for the patent license, your conveying the covered work in a country, or your recipient's use of the covered work in a country, would infringe one or more identifiable patents in that country that you have reason to believe are valid.

If, pursuant to or in connection with a single transaction or arrangement, you convey, or propagate by procuring conveyance of, a covered work, and grant a patent license to some of the parties receiving the covered work authorizing them to use, propagate, modify or convey a specific copy of the covered work, then the patent license you grant is automatically extended to all recipients of the covered work and works based on it.

A patent license is “discriminatory” if it does not include within the scope of its coverage, prohibits the exercise of, or is conditioned on the non-exercise of one or more of the rights that are specifically granted under this License. You may not convey a covered work if you are a party to an arrangement with a third party that is in the business of distributing software, under which you make payment to the third party based on the extent of your activity of conveying the work, and under which the third party grants, to any of the parties who would receive the covered work from you, a discriminatory patent license (a) in connection with copies of the covered work conveyed by you (or copies made from those copies), or (b) primarily for and in connection with specific products or compilations that contain the covered work, unless you entered into that arrangement, or that patent license was granted, prior to 28 March 2007.

Nothing in this License shall be construed as excluding or limiting any implied license or other defenses to infringement that may otherwise be available to you under applicable patent law.

## **12. No Surrender of Others' Freedom.**

If conditions are imposed on you (whether by court order, agreement or otherwise) that contradict the conditions of this License, they do not excuse you from the conditions of this License. If you cannot convey a covered work so as to satisfy simultaneously your obligations under this License and any other pertinent obligations, then as a consequence you may not convey it at all. For example, if you agree to terms that obligate you to collect a royalty for further conveying from those to whom you convey the Program, the only way you could satisfy both those terms and this License would be to refrain entirely from conveying the Program.

## **13. Use with the GNU Affero General Public License.**

Notwithstanding any other provision of this License, you have permission to link or combine any covered work with a work licensed under version 3 of the GNU Affero General Public License into a single combined work, and to convey the resulting work. The terms of this License will continue to apply to the

part which is the covered work, but the special requirements of the GNU Affero General Public License, section 13, concerning interaction through a network will apply to the combination as such.

#### **14. Revised Versions of this License.**

The Free Software Foundation may publish revised and/or new versions of the GNU General Public License from time to time. Such new versions will be similar in spirit to the present version, but may differ in detail to address new problems or concerns.

Each version is given a distinguishing version number. If the Program specifies that a certain numbered version of the GNU General Public License “or any later version” applies to it, you have the option of following the terms and conditions either of that numbered version or of any later version published by the Free Software Foundation. If the Program does not specify a version number of the GNU General Public License, you may choose any version ever published by the Free Software Foundation.

If the Program specifies that a proxy can decide which future versions of the GNU General Public License can be used, that proxy's public statement of acceptance of a version permanently authorizes you to choose that version for the Program.

Later license versions may give you additional or different permissions. However, no additional obligations are imposed on any author or copyright holder as a result of your choosing to follow a later version.

#### **15. Disclaimer of Warranty.**

THERE IS NO WARRANTY FOR THE PROGRAM, TO THE EXTENT PERMITTED BY APPLICABLE LAW. EXCEPT WHEN OTHERWISE STATED IN WRITING THE COPYRIGHT HOLDERS AND/OR OTHER PARTIES PROVIDE THE PROGRAM “AS IS” WITHOUT WARRANTY OF ANY KIND, EITHER EXPRESSED OR IMPLIED, INCLUDING, BUT NOT LIMITED TO, THE IMPLIED WARRANTIES OF MERCHANTABILITY AND FITNESS FOR A PARTICULAR PURPOSE. THE ENTIRE RISK AS TO THE QUALITY AND PERFORMANCE OF THE PROGRAM IS WITH YOU. SHOULD THE PROGRAM PROVE DEFECTIVE, YOU ASSUME THE COST OF ALL NECESSARY SERVICING, REPAIR OR CORRECTION.

#### **16. Limitation of Liability.**

IN NO EVENT UNLESS REQUIRED BY APPLICABLE LAW OR AGREED TO IN WRITING WILL ANY COPYRIGHT HOLDER, OR ANY OTHER PARTY WHO MODIFIES AND/OR CONVEYS THE PROGRAM AS PERMITTED ABOVE, BE LIABLE TO YOU FOR DAMAGES, INCLUDING ANY GENERAL, SPECIAL, INCIDENTAL OR CONSEQUENTIAL DAMAGES ARISING OUT OF THE USE OR INABILITY TO USE THE PROGRAM (INCLUDING BUT NOT LIMITED TO LOSS OF DATA OR DATA BEING RENDERED INACCURATE OR LOSSES SUSTAINED BY YOU OR THIRD PARTIES OR A FAILURE OF THE PROGRAM TO OPERATE WITH ANY OTHER PROGRAMS), EVEN IF SUCH HOLDER OR OTHER PARTY HAS BEEN ADVISED OF THE POSSIBILITY OF SUCH DAMAGES.

#### **17. Interpretation of Sections 15 and 16.**

If the disclaimer of warranty and limitation of liability provided above cannot be given local legal effect according to their terms, reviewing courts shall apply local law that most closely approximates an absolute waiver of all civil liability in connection with the Program, unless a warranty or assumption of liability accompanies a copy of the Program in return for a fee.

END OF TERMS AND CONDITIONS

## How to Apply These Terms to Your New Programs

If you develop a new program, and you want it to be of the greatest possible use to the public, the best way to achieve this is to make it free software which everyone can redistribute and change under these terms.

To do so, attach the following notices to the program. It is safest to attach them to the start of each source file to most effectively state the exclusion of warranty; and each file should have at least the “copyright” line and a pointer to where the full notice is found.

```
<one line to give the program's name and a brief idea of what it does.>  
Copyright (C) <year> <name of author>
```

This program is free software: you can redistribute it and/or modify it under the terms of the GNU General Public License as published by the Free Software Foundation, either version 3 of the License, or (at your option) any later version.

This program is distributed in the hope that it will be useful, but WITHOUT ANY WARRANTY; without even the implied warranty of MERCHANTABILITY or FITNESS FOR A PARTICULAR PURPOSE. See the GNU General Public License for more details.

You should have received a copy of the GNU General Public License along with this program. If not, see <http://www.gnu.org/licenses/>.

Also add information on how to contact you by electronic and paper mail.

If the program does terminal interaction, make it output a short notice like this when it starts in an interactive mode:

```
<program> Copyright (C) <year> <name of author>  
This program comes with ABSOLUTELY NO WARRANTY; for details type `show w'.  
This is free software, and you are welcome to redistribute it  
under certain conditions; type `show c' for details.
```

The hypothetical commands `show w' and `show c' should show the appropriate parts of the General Public License. Of course, your program's commands might be different; for a GUI interface, you would use an “about box”.

You should also get your employer (if you work as a programmer) or school, if any, to sign a “copyright disclaimer” for the program, if necessary. For more information on this, and how to apply and follow the GNU GPL, see <http://www.gnu.org/licenses/>.

The GNU General Public License does not permit incorporating your program into proprietary programs. If your program is a subroutine library, you may consider it more useful to permit linking proprietary applications with the library. If this is what you want to do, use the GNU Lesser General Public License instead of this License. But first, please read <http://www.gnu.org/philosophy/why-not-lgpl.html>.

**Federal Communication Commission Interference Statement**

This equipment has been tested and found to comply with the limits for a Class B digital device, pursuant to Part 15 of the FCC Rules. These limits are designed to provide reasonable protection against harmful interference in a residential installation. This equipment generates, uses, and can radiate radio frequency energy and, if not installed and used in accordance with the instructions, may cause harmful interference to radio communications. However, there is no guarantee that interference will not occur in a particular installation. If this equipment does cause harmful interference to radio or television reception, which can be determined by turning the equipment off and on, the user is encouraged to try to correct the interference by one or more of the following measures:

- Reorient or relocate the receiving antenna.
- Increase the separation between the equipment and receiver.
- Connect the equipment into an outlet on a circuit different from that to which the receiver is connected.
- Consult the dealer or an experienced radio/TV technician for help.

This device complies with Part 15 of the FCC Rules. Operation is subject to the following two conditions: (1) This device may not cause harmful interference, and (2) this device must accept any interference received, including interference that may cause undesired operation.

**FCC Caution:**

Changes or modifications not expressly approved by the party responsible for compliance could void the user's authority to operate the equipment.

**FCC Radiation Exposure Statement:**

This equipment complies with FCC radiation exposure limits set forth for an uncontrolled environment. This equipment should be installed and operated with minimum distance 20cm between the radiator & your body.