

# User's Guide

## LTE Series

LTE Outdoor CPE

**DRAFT**

Version 2.00 Ed 2, 3/2019

### Default Login Details

|                |                            |
|----------------|----------------------------|
| LAN IP Address | http://192.168.1.1         |
| Login          | admin                      |
| Password       | See the Zyxel Device label |

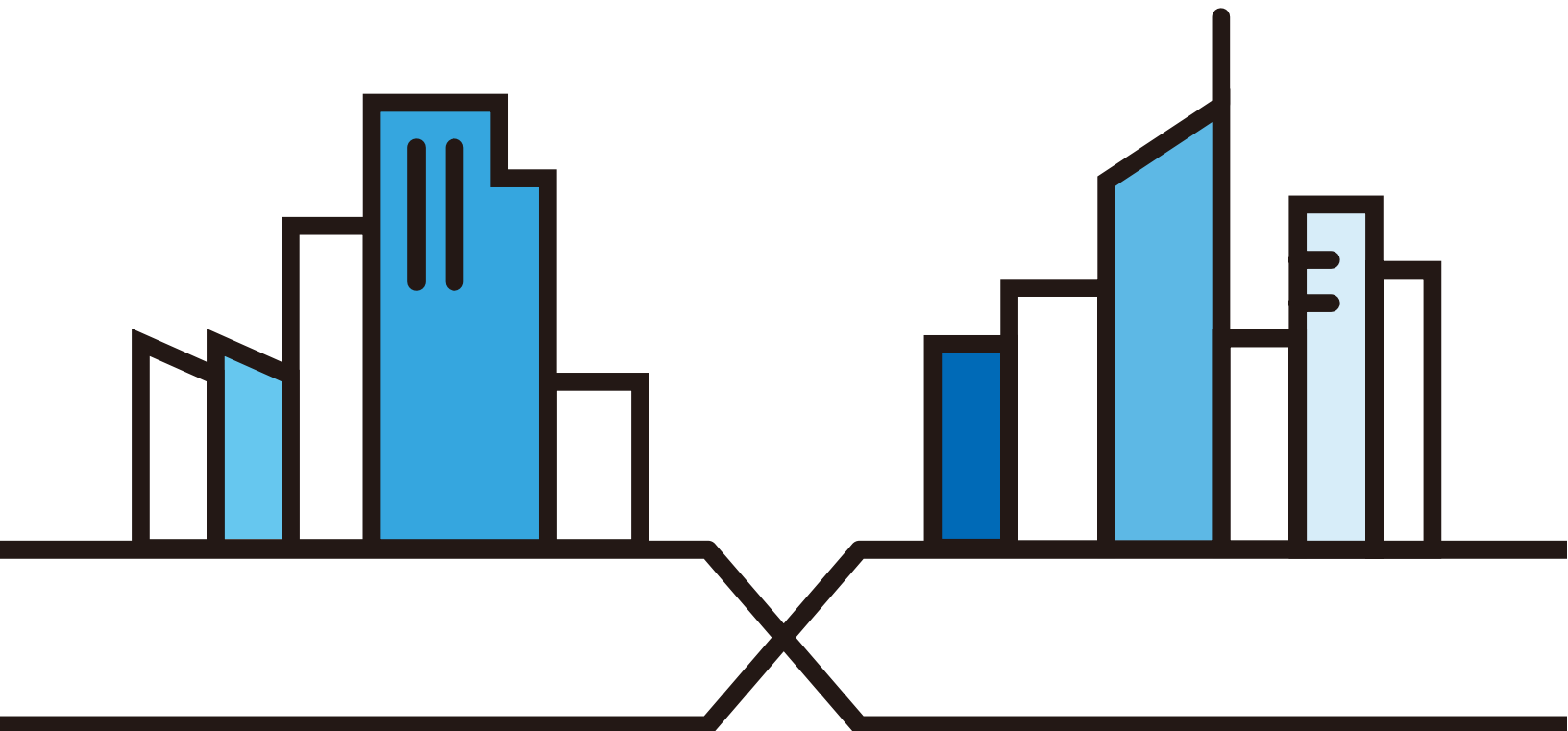

---

**IMPORTANT!**

**READ CAREFULLY BEFORE USE.**

**KEEP THIS GUIDE FOR FUTURE REFERENCE.**

This is a series User's Guide for the LTE7240-M403 / LTE7461-M602 / LTE7480-S905. Screenshots and graphics in this book may differ slightly from what you see due to differences in your product firmware or your computer operating system. Every effort has been made to ensure that the information in this manual is accurate.

### **Related Documentation**

- Quick Start Guide  
The Quick Start Guide shows how to connect the Zyxel Device.
- More Information  
Go to **support.zyxel.com** to find other information on the Zyxel Device.



# Document Conventions

## Warnings and Notes

These are how warnings and notes are shown in this guide.

**Warnings tell you about things that could harm you or your Zyxel Device.**







Note: Notes tell you other important information (for example, other things you may need to configure or helpful tips) or recommendations.

## Syntax Conventions

- The LTE7240-M403 / LTE7461-M602 / LTE7480-S905 in this user's guide may be referred to as the "Zyxel Device" in this guide.
- Product labels, screen names, field labels and field choices are all in **bold** font.
- A right angle bracket ( > ) within a screen name denotes a mouse click. For example, **Network Setting > Routing > DNS Route** means you first click **Network Setting** in the navigation panel, then the **Routing** sub menu and finally the **DNS Route** tab to get to that screen.

## Icons Used in Figures

Figures in this user guide may use the following generic icons. The Zyxel Device icon is not an exact representation of your Zyxel Device.

|   |   |  |
|---|---|--|
| Zyxel Device<br> | Generic Router<br> | Switch<br>             |
| Server<br>       | Firewall<br>       | USB Storage Device<br> |
| Printer<br>      |   |  |

# Contents Overview

|   |            |
|---|------------|
| <b>User's Guide</b> .....               | <b>12</b>  |
| Introduction .....                      | 13         |
| The Web Configurator .....              | 20         |
| Quick Start .....                       | 27         |
| <b>Technical Reference</b> .....        | <b>29</b>  |
| Connection Status .....                 | 30         |
| Broadband .....                         | 37         |
| Wireless .....                          | 46         |
| Home Networking .....                   | 70         |
| Routing .....                           | 92         |
| Network Address Translation (NAT) ..... | 100        |
| Dynamic DNS Setup .....                 | 110        |
| Firewall .....                          | 114        |
| MAC Filter .....                        | 125        |
| Certificates .....                      | 127        |
| Log .....                               | 136        |
| Traffic Status .....                    | 139        |
| ARP Table .....                         | 142        |
| Routing Table .....                     | 144        |
| Cellular WAN Status .....               | 147        |
| System .....                            | 152        |
| User Account .....                      | 153        |
| Remote Management .....                 | 156        |
| TR-069 Client .....                     | 160        |
| Time Settings .....                     | 163        |
| Email Notification .....                | 166        |
| Log Setting .....                       | 169        |
| Firmware Upgrade .....                  | 172        |
| Backup/Restore .....                    | 174        |
| Diagnostic .....                        | 177        |
| Troubleshooting .....                   | 179        |
| <b>Appendices</b> .....                 | <b>185</b> |

# Table of Contents

|   |           |
|---|-----------|
| <b>Document Conventions</b> .....                   | <b>3</b>  |
| <b>Contents Overview</b> .....                      | <b>4</b>  |
| <b>Table of Contents</b> .....                      | <b>5</b>  |
| <br>  |           |
| <b>Part I: User's Guide</b> .....                   | <b>12</b> |
| <br>  |           |
| <b>Chapter 1</b>                                    |           |
| <b>Introduction</b> .....                           | <b>13</b> |
| 1.1 Overview .....                                  | 13        |
| 1.2 Application for the Zyxel Device .....          | 14        |
| 1.3 Manage the Zyxel Device .....                   | 14        |
| 1.4 Good Habits for Managing the Zyxel Device ..... | 14        |
| 1.5 Front and Bottom Panels .....                   | 15        |
| 1.5.1 LEDs (Lights) .....                           | 16        |
| 1.5.2 Bottom Panels .....                           | 17        |
| 1.6 Using the WiFi Button .....                     | 17        |
| 1.7 The RESET Button .....                          | 19        |
| <br>  |           |
| <b>Chapter 2</b>                                    |           |
| <b>The Web Configurator</b> .....                   | <b>20</b> |
| 2.1 Overview .....                                  | 20        |
| 2.1.1 Access the Web Configurator .....             | 20        |
| 2.2 Web Configurator Layout .....                   | 22        |
| 2.2.1 Settings Icon .....                           | 22        |
| 2.2.2 Widget Icon .....                             | 26        |
| <br>  |           |
| <b>Chapter 3</b>                                    |           |
| <b>Quick Start</b> .....                            | <b>27</b> |
| 3.1 Overview .....                                  | 27        |
| 3.2 Quick Start Setup .....                         | 27        |
| 3.3 Time Zone .....                                 | 27        |
| 3.4 WiFi Setup .....                                | 28        |
| 3.5 Quick Start Setup-Finish .....                  | 28        |
| <br>  |           |
| <b>Part II: Technical Reference</b> .....           | <b>29</b> |

|   |           |
|---|-----------|
| <b>Chapter 4</b>                            |           |
| <b>Connection Status</b> .....              | <b>30</b> |
| 4.1 Connection Status Overview .....        | 30        |
| 4.1.1 Connectivity .....                    | 30        |
| 4.1.2 System Info .....                     | 31        |
| 4.1.3 WiFi Settings .....                   | 33        |
| 4.1.4 LAN .....                             | 35        |
| <b>Chapter 5</b>                            |           |
| <b>Broadband</b> .....                      | <b>37</b> |
| 5.1 Overview .....                          | 37        |
| 5.1.1 What You Can Do in this Chapter ..... | 37        |
| 5.1.2 What You Need to Know .....           | 37        |
| 5.1.3 Before You Begin .....                | 38        |
| 5.2 Cellular WAN .....                      | 38        |
| 5.3 Cellular SIM Configuration .....        | 40        |
| 5.4 Cellular Band Configuration .....       | 41        |
| 5.5 PLMN Configuration .....                | 42        |
| 5.6 IP Passthrough .....                    | 44        |
| <b>Chapter 6</b>                            |           |
| <b>Wireless</b> .....                       | <b>46</b> |
| 6.1 Overview .....                          | 46        |
| 6.1.1 What You Can Do in this Chapter ..... | 46        |
| 6.1.2 What You Need to Know .....           | 46        |
| 6.2 General Settings .....                  | 47        |
| 6.2.1 No Security .....                     | 48        |
| 6.2.2 More Secure (WPA2-PSK) .....          | 49        |
| 6.3 MAC Authentication .....                | 50        |
| 6.4 WPS .....                               | 52        |
| 6.5 WMM .....                               | 54        |
| 6.6 Others Settings .....                   | 55        |
| 6.7 Technical Reference .....               | 57        |
| 6.7.1 WiFi Network Overview .....           | 57        |
| 6.7.2 Additional Wireless Terms .....       | 59        |
| 6.7.3 WiFi Security Overview .....          | 59        |
| 6.7.4 Signal Problems .....                 | 61        |
| 6.7.5 BSS .....                             | 61        |
| 6.7.6 Preamble Type .....                   | 62        |
| 6.7.7 WiFi Protected Setup (WPS) .....      | 62        |
| <b>Chapter 7</b>                            |           |
| <b>Home Networking</b> .....                | <b>70</b> |

|  |            |
|--|------------|
| 7.1 Overview .....   | 70         |
| 7.1.1 What You Can Do in this Chapter .....                | 70         |
| 7.1.2 What You Need To Know .....                          | 70         |
| 7.2 LAN Setup .....  | 71         |
| 7.3 Static DHCP .....                                      | 75         |
| 7.3.1 Before You Begin .....                               | 75         |
| 7.4 UPnP .....   | 77         |
| 7.5 Technical Reference .....                              | 78         |
| 7.6 Turn on UPnP in Windows 7 Example .....                | 79         |
| 7.6.1 Auto-discover Your UPnP-enabled Network Device ..... | 80         |
| 7.7 Turn on UPnP in Windows 10 Example .....               | 82         |
| 7.7.1 Auto-discover Your UPnP-enabled Network Device ..... | 84         |
| 7.8 Web Configurator Easy Access in Windows 7 .....        | 87         |
| 7.9 Web Configurator Easy Access in Windows 10 .....       | 89         |
| <br>   |            |
| <b>Chapter 8</b>   |            |
| <b>Routing .....</b>                                       | <b>92</b>  |
| 8.1 Overview .....   | 92         |
| 8.2 Configure Static Route .....                           | 92         |
| 8.2.1 Add/Edit Static Route .....                          | 93         |
| 8.3 DNS Route .....  | 95         |
| 8.3.1 Add/Edit DNS Route .....                             | 95         |
| 8.4 Policy Route .....                                     | 96         |
| 8.4.1 Add/Edit Policy Route .....                          | 98         |
| 8.5 RIP Overview .....                                     | 99         |
| 8.5.1 RIP .....  | 99         |
| <br>   |            |
| <b>Chapter 9</b>   |            |
| <b>Network Address Translation (NAT) .....</b>             | <b>100</b> |
| 9.1 Overview .....   | 100        |
| 9.1.1 What You Can Do in this Chapter .....                | 100        |
| 9.1.2 What You Need To Know .....                          | 100        |
| 9.2 Port Forwarding Overview .....                         | 101        |
| 9.2.1 Port Forwarding .....                                | 102        |
| 9.2.2 Add/Edit Port Forwarding .....                       | 103        |
| 9.3 Port Triggering .....                                  | 104        |
| 9.3.1 Add/Edit Port Triggering Rule .....                  | 106        |
| 9.4 DMZ .....  | 107        |
| 9.5 ALG .....  | 108        |
| <br>   |            |
| <b>Chapter 10</b>  |            |
| <b>Dynamic DNS Setup .....</b>                             | <b>110</b> |
| 10.1 DNS Overview .....                                    | 110        |

|   |            |
|---|------------|
| 10.1.1 What You Can Do in this Chapter .....                        | 110        |
| 10.1.2 What You Need To Know .....                                  | 110        |
| 10.2 DNS Entry .....  | 111        |
| 10.2.1 Add/Edit DNS Entry .....                                     | 111        |
| 10.3 Dynamic DNS .....  | 112        |
| <b>Chapter 11</b>   |            |
| <b>Firewall .....</b>   | <b>114</b> |
| 11.1 Overview .....   | 114        |
| 11.1.1 What You Need to Know About Firewall .....                   | 114        |
| 11.2 Firewall .....   | 115        |
| 11.2.1 What You Can Do in this Chapter .....                        | 115        |
| 11.3 Firewall General Settings .....                                | 115        |
| 11.4 Protocol (Customized Services) .....                           | 117        |
| 11.4.1 Add Customized Service .....                                 | 117        |
| 11.5 Access Control (Rules) .....                                   | 118        |
| 11.5.1 Access Control Add New ACL Rule .....                        | 119        |
| 11.6 DoS .....  | 121        |
| 11.7 Firewall Technical Reference .....                             | 122        |
| 11.7.1 Firewall Rules Overview .....                                | 122        |
| 11.7.2 Guidelines For Security Enhancement With Your Firewall ..... | 123        |
| 11.7.3 Security Considerations .....                                | 123        |
| <b>Chapter 12</b>   |            |
| <b>MAC Filter .....</b>   | <b>125</b> |
| 12.1 MAC Filter Overview .....                                      | 125        |
| 12.2 MAC Filter .....   | 125        |
| <b>Chapter 13</b>   |            |
| <b>Certificates .....</b>   | <b>127</b> |
| 13.1 Overview .....   | 127        |
| 13.1.1 What You Can Do in this Chapter .....                        | 127        |
| 13.2 Local Certificates .....                                       | 127        |
| 13.2.1 Create Certificate Request .....                             | 128        |
| 13.2.2 View Certificate Request .....                               | 129        |
| 13.3 Trusted CA .....   | 131        |
| 13.4 Import Trusted CA Certificate .....                            | 132        |
| 13.5 View Trusted CA Certificate .....                              | 132        |
| 13.6 Certificates Technical Reference .....                         | 133        |
| 13.6.1 Verify a Certificate .....                                   | 134        |
| <b>Chapter 14</b>   |            |
| <b>Log .....</b>  | <b>136</b> |



|  |            |
|--|------------|
| 14.1 Log Overview .....                      | 136        |
| 14.1.1 What You Can Do in this Chapter ..... | 136        |
| 14.1.2 What You Need To Know .....           | 136        |
| 14.2 System Log .....                        | 137        |
| 14.3 Security Log .....                      | 137        |
| <b>Chapter 15</b>                            |            |
| <b>Traffic Status .....</b>                  | <b>139</b> |
| 15.1 Traffic Status Overview .....           | 139        |
| 15.1.1 What You Can Do in this Chapter ..... | 139        |
| 15.2 WAN Status .....                        | 139        |
| 15.3 LAN Status .....                        | 140        |
| <b>Chapter 16</b>                            |            |
| <b>ARP Table.....</b>                        | <b>142</b> |
| 16.1 ARP Table Overview .....                | 142        |
| 16.1.1 How ARP Works .....                   | 142        |
| 16.2 ARP Table .....                         | 143        |
| <b>Chapter 17</b>                            |            |
| <b>Routing Table.....</b>                    | <b>144</b> |
| 17.1 Routing Table Overview .....            | 144        |
| 17.2 Routing Table .....                     | 144        |
| <b>Chapter 18</b>                            |            |
| <b>Cellular WAN Status .....</b>             | <b>147</b> |
| 18.1 Cellular WAN Status Overview .....      | 147        |
| 18.2 Cellular WAN Status .....               | 147        |
| <b>Chapter 19</b>                            |            |
| <b>System.....</b>                           | <b>152</b> |
| 19.1 System Overview .....                   | 152        |
| 19.2 System .....                            | 152        |
| <b>Chapter 20</b>                            |            |
| <b>User Account.....</b>                     | <b>153</b> |
| 20.1 User Account Overview .....             | 153        |
| 20.2 User Account .....                      | 153        |
| 20.2.1 User Account Add/Edit .....           | 154        |
| <b>Chapter 21</b>                            |            |
| <b>Remote Management.....</b>                | <b>156</b> |
| 21.1 Overview .....                          | 156        |

---

|   |            |
|---|------------|
| 21.2 MGMT Services .....                    | 156        |
| 21.3 MGMT Services for IP Passthrough ..... | 157        |
| 21.4 Trust Domain .....                     | 158        |
| 21.5 Add Trust Domain .....                 | 158        |
| <b>Chapter 22</b>                           |            |
| <b>TR-069 Client.....</b>                   | <b>160</b> |
| 22.1 Overview .....                         | 160        |
| 22.2 TR-069 Client .....                    | 160        |
| <b>Chapter 23</b>                           |            |
| <b>Time Settings.....</b>                   | <b>163</b> |
| 23.1 Time Settings Overview .....           | 163        |
| 23.2 Time .....                             | 163        |
| <b>Chapter 24</b>                           |            |
| <b>Email Notification.....</b>              | <b>166</b> |
| 24.1 Email Notification Overview .....      | 166        |
| 24.2 Email Notification .....               | 166        |
| 24.2.1 Email Notification Edit .....        | 167        |
| <b>Chapter 25</b>                           |            |
| <b>Log Setting .....</b>                    | <b>169</b> |
| 25.1 Log Setting Overview .....             | 169        |
| 25.2 Log Setting .....                      | 169        |
| <b>Chapter 26</b>                           |            |
| <b>Firmware Upgrade .....</b>               | <b>172</b> |
| 26.1 Overview .....                         | 172        |
| 26.2 Firmware Upgrade .....                 | 172        |
| <b>Chapter 27</b>                           |            |
| <b>Backup/Restore .....</b>                 | <b>174</b> |
| 27.1 Backup/Restore Overview .....          | 174        |
| 27.2 Backup/Restore .....                   | 174        |
| 27.3 Reboot .....                           | 175        |
| <b>Chapter 28</b>                           |            |
| <b>Diagnostic.....</b>                      | <b>177</b> |
| 28.1 Diagnostic Overview .....              | 177        |
| 28.2 Ping/TraceRoute/Nslookup Test .....    | 177        |
| <b>Chapter 29</b>                           |            |
| <b>Troubleshooting.....</b>                 | <b>179</b> |

---

|   |            |
|---|------------|
| 29.1 Overview .....                       | 179        |
| 29.2 Power and Hardware Connections ..... | 179        |
| 29.3 Zyxel Device Access and Login .....  | 179        |
| 29.4 Internet Access .....                | 181        |
| 29.5 UPnP .....                           | 182        |
| 29.6 SIM Card .....                       | 183        |
| 29.7 Cellular Signal .....                | 183        |
| <br>                                      |            |
| <b>Part III: Appendices .....</b>         | <b>185</b> |
| <br>                                      |            |
| Appendix A Customer Support .....         | 186        |
| Appendix B IPv6.....                      | 192        |
| Appendix C Legal Information .....        | 199        |
| <br>                                      |            |
| <b>Index .....</b>                        | <b>212</b> |

---

# PART I

## User's Guide

---

# CHAPTER 1

## Introduction

### 1.1 Overview

Zyxel Device refers to these models as outlined below.

- LTE7240-M403
- LTE7461-M602
- LTE7480-S905

The following table describes the feature differences of the Zyxel Device by model.

|                       | LTE7240-M403          | LTE7461-M602           | LTE7480-S905            |
|-----------------------|-----------------------|------------------------|-------------------------|
| Gigabit Ethernet Port | √                     | √                      | √                       |
| 2.4G WLAN             | √                     | √                      | √                       |
| LTE Speed             | 150/50 Mbps (FDD-LTE) | 400/150 Mbps (FDD-LTE) | 573/15.1 Mbps (TDD-LTE) |
| Wall Mount            | √                     | √                      | √                       |
| Pole Mount            | -                     | √                      | √                       |
| Firmware Version      | 2.0                   | 2.0                    | 1.0                     |

The Zyxel Device is an outdoor LTE (Long Term Evolution) router that supports (but not limited to) the following:

- Gigabit Ethernet connection
- DHCP (Dynamic Host Configuration Protocol) server
- NAT (Network Address Translation)
- DMZ (Demilitarized Zone)
- Port Forwarding/Triggering
- ALG (Application Layer Gateway)
- Embedded Bridge/Router mode
- Dynamic DNS (Domain Name System) for the first APN (Access Point Name)
- Static/Dynamic Route setting for RIP (Routing Information Protocol)
- Remote Management under Bridge mode
- Address Resolution Protocol (ARP)
- Firewall that uses Stateful Packet Inspection (SPI) technology
- Protects against Denial of Service (DoS) attacks
- Filter of LAN MAC address, LAN IP address and URLs
- Local and remote device management

- Firmware upgrade via TR-069 and Web Configurator

The embedded Web-based Configurator enables straightforward management and maintenance. Just insert the SIM card (with an active data plan) and make the hardware connections. See the Quick Start Guide for how to do the hardware installation, wall mounting, Internet setup and turning on/off WiFi (optional).

## 1.2 Application for the Zyxel Device

### Wireless WAN

The Zyxel Device can connect to the Internet through a 2G/3G/4G LTE SIM card to access a wireless WAN connection. Just insert a SIM card into the SIM card slot at the bottom of the Zyxel Device.

Note: You must insert the SIM card into the card slot before turning on the Zyxel Device.

### Internet Access

Your Zyxel Device provides shared Internet access by connecting to an LTE network. A computer can connect to the Zyxel Device's PoE injector for configuration via the Web Configurator.

**Figure 1** Zyxel Device's Internet Access Application

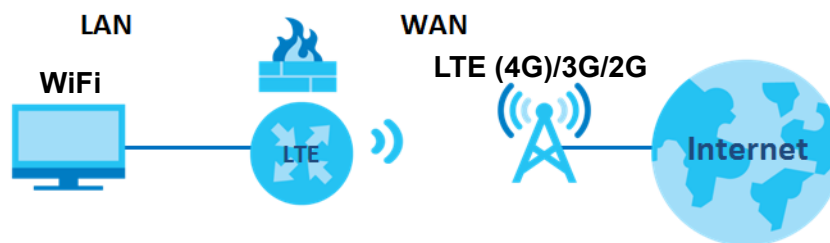

## 1.3 Manage the Zyxel Device

Use the Web Configurator for management of the Zyxel Device using a (supported) web browser.

## 1.4 Good Habits for Managing the Zyxel Device

Do the following things regularly to make the Zyxel Device more secure and to manage the Zyxel Device more effectively.

- Change the password. Use a password that's not easy to guess and that consists of different types of characters, such as numbers and letters.
- Write down the password and put it in a safe place.

- Back up the configuration (and make sure you know how to restore it). Refer to [Section 27.2 on page 174](#). Restoring an earlier working configuration may be useful if the Zyxel Device becomes unstable or even crashes. If you forget your password to access the Web Configurator, you will have to reset the Zyxel Device to its factory default settings. If you backed up an earlier configuration file, you would not have to totally re-configure the Zyxel Device. You could simply restore your last configuration. Write down any information your ISP provides you.

## 1.5 Front and Bottom Panels

The LED indicators are located on the front (LTE7240-M403) / bottom panel (LTE7461-M602 / LTE7480-S905).

**Figure 2** Front Panel (LTE7240-M403)



**Figure 3** Bottom Panel (LTE7461-M602 / LTE7480-S905)



## 1.5.1 LEDs (Lights)

None of the LEDs are on if the Zyxel Device is not receiving power.

Table 2 LTE7240-M403 LED Descriptions

| LED             | COLOR  | STATUS          | DESCRIPTION   |
|-----------------|--------|-----------------|---|
| POWER           | Green  | On              | The Zyxel Device is receiving power and ready for use.  |
|                 |        | Blinking        | The Zyxel Device is booting or self-testing.  |
|                 |        | Off             | The Zyxel Device is not receiving power.  |
| ETHERNET        | Green  | On              | The Zyxel Device has a successful 10/100/1000 Mbps Ethernet connection with a device on the Local Area Network (LAN). |
|                 |        | Off             | The Zyxel Device does not have an Ethernet connection with the LAN.   |
| LTE/3G/2G       | Green  | On              | The Zyxel Device is registered and successfully connected to a 4G network.  |
|                 |        | Blinking (slow) | The Zyxel Device is connected to a 3G/2G network.   |
|                 |        | Blinking (fast) | The Zyxel Device is trying to connect to a 4G/3G/2G network.  |
|                 |        | Off             | There is no service.  |
| WLAN            | Green  | On              | The wireless network is activated.  |
|                 |        | Off             | The wireless network is not activated.  |
| Signal Strength | Green  | On              | The signal strength is Excellent.   |
|                 | Orange | On              | The signal strength is Fair.  |
|                 | Red    | On              | The signal strength is Poor.  |
|                 |        | Blinking        | There is no SIM card inserted, the SIM card is invalid, the PIN code is not correct.                                  |
|                 |        | Off             | There is no signal or the signal strength is below the Poor level.  |

Note: Blinking (slow) means the LED blinks once per second. Blinking (fast) means the LED blinks once per 0.2 second.

LTE7461-M602 / LTE7480-S905 LED Descriptions

| COLOR | STATUS   | DESCRIPTION  |
|-------|----------|--|
| Red   | Blinking | The Zyxel Device is booting or self-testing.           |
|       | On       | The Zyxel Device encountered an error.                 |
| Green | Blinking | The Zyxel Device is trying to connect to the Internet. |
|       | On       | The Zyxel Device is connected to the Internet.         |
| Amber | Blinking | The Zyxel Device WiFi is on.                           |

## 1.5.2 Bottom Panels

The connection ports are located on the bottom panel.



The following table describes the items on the bottom panel.

| LABEL    | DESCRIPTION  |
|----------|--|
| LAN      | Connect a computer via the PoE injector for configuration.<br>Connect the PoE injector to a power outlet to start the device.  |
| WiFi     | Press the WLAN button for more than five seconds to enable the wireless function.  |
| WPS      | After the wireless function is enabled, press the WLAN button for more than one second but less than five seconds to quickly set up a secure wireless connection between the device and a WPS-compatible client. |
| Reset    | Press the button for more than five seconds to return the Zyxel Device to the factory defaults.  |
| Reboot   | Press the <b>RESET</b> button for more than 2 seconds but less than 5 seconds, it will cause the system to reboot.   |
| SIM card | Insert a micro-SIM card into the slot with the chip facing down and the beveled corner in the top left corner.   |

## 1.6 Using the WiFi Button

The wireless network is turned off by default.

**Figure 4** LTE7240-M403 WiFi Button

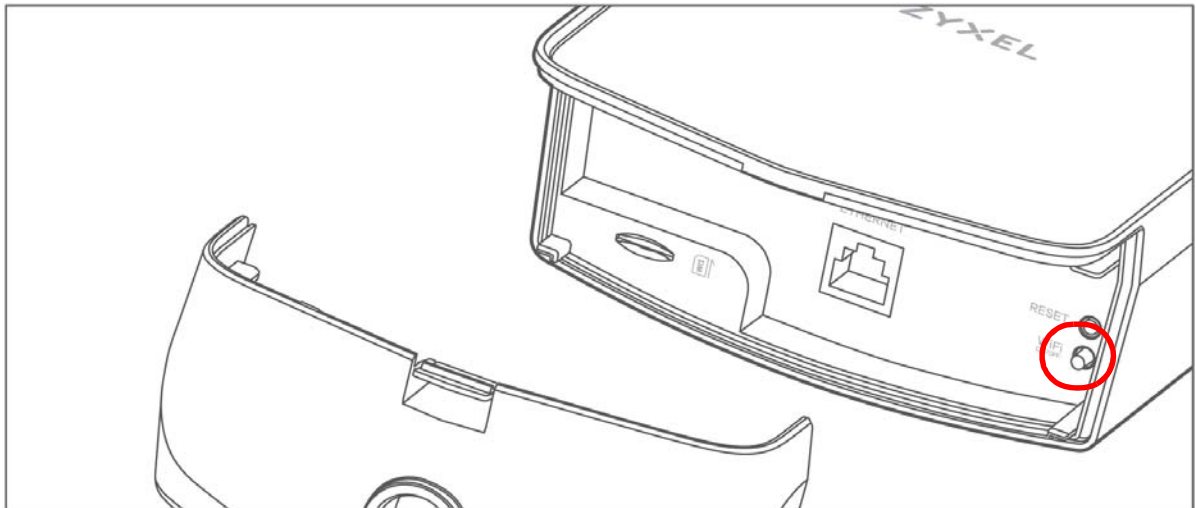

**Figure 5** LTE7461-M602 / LTE7480-S905 WiFi Button



To turn on WiFi:

- 1 Make sure the **POWER** LED is on and not blinking.
- 2 Press the **WiFi** button for more than 5 seconds and release it.

For LTE7240-M403:

Once WiFi is turned on, the **WLAN** LED shines green.

For LTE7461-M602 / LTE7480-S905:

Once WiFi is turned on, the LED blinks amber.

To activate WPS (WiFi must be already on):

- 1 Press the **WiFi** button for more than 1 second but less than 5 seconds and release it (pressing more than 5 seconds will turn off WiFi).
- 2 Press the WPS button on another WPS-enabled device within range of the Zyxel Device.

To turn off the wireless network, press the **WiFi** button for more than 5 seconds.

For LTE7240-M403:

The **WLAN** LED turns off when the wireless network is off.

For LTE7461-M602 / LTE7480-S905:

The amber LED turns off.

Note: Use the WiFi function of the LTE7461-M602 / LTE7480-S905 for configuration (for example, connect to the LTE Ally app of your mobile device to find the optimal LTE signal strength and manage your LTE7461-M602 / LTE7480-S905).

## 1.7 The RESET Button

If you forget your password or cannot access the Web Configurator, you will need to use the **RESET** button of the Zyxel Device as shown in the following figure to reload the factory-default configuration file. This means that you will lose all configurations that you had previously saved, the password will be reset to **1234** and the IP address will be reset to **192.168.1.1**.

**Figure 6** Reset Button (LTE7240-M403)

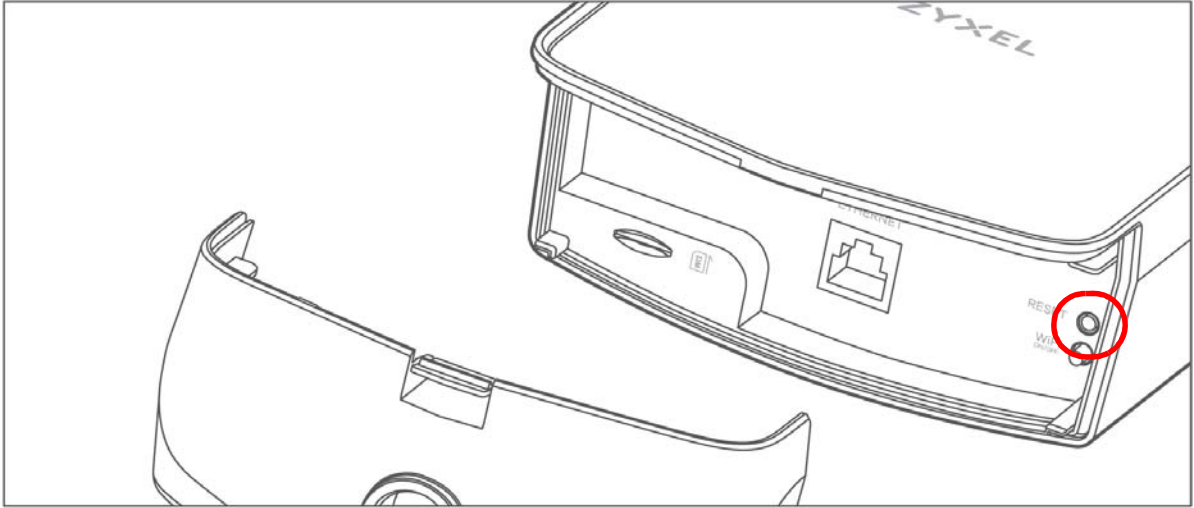

**Figure 7** Reset Button (LTE7461-M602 / LTE7480-S905)



- 1 Make sure the Zyxel Device is connected to power and **POWER** LED is on.
- 2 To set the Zyxel Device back to the factory default settings, press the **RESET** button for 5 seconds.

Note: If you press the **RESET** button for more than 2 seconds but less than 5 seconds, it will cause the system to reboot.

# CHAPTER 2

## The Web Configurator

### 2.1 Overview

The Web Configurator is an HTML-based management interface that allows easy Zyxel Device setup and management via Internet browser. Use Internet Explorer 8.0 and later versions or Mozilla Firefox 3 and later versions or Safari 2.0 and later versions. The recommended screen resolution is 1024 by 768 pixels.

In order to use the Web Configurator you need to allow:

- Web browser pop-up windows from your Zyxel Device. Web pop-up blocking is enabled by default in Windows 10.
- JavaScript (enabled by default).
- Java permissions (enabled by default).

#### 2.1.1 Access the Web Configurator

- 1 Make sure your Zyxel Device hardware is properly connected (refer to the Quick Start Guide).
- 2 Launch your web browser. If the Zyxel Device does not automatically re-direct you to the login screen, go to <http://192.168.1.1>.
- 3 A password screen displays. Select the language you prefer (upper right).
- 4 To access the Web Configurator and manage the Zyxel Device, type the default username **admin** and the randomly assigned default password (see the Zyxel Device label) in the **Login** screen and click **Login**. If you have changed the password, enter your password and click **Login**.

Figure 8 Password Screen

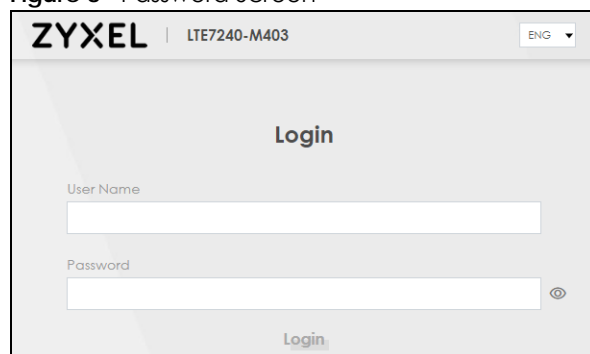

Note: The first time you enter the password, you will be asked to change it. Make sure the new password must contain at least one uppercase letter, one lowercase letter and one number.

- The **Connection Status** screen appears. Use this screen to configure basic Internet access, wireless settings, and parental control settings.

**Figure 9** Connection Status

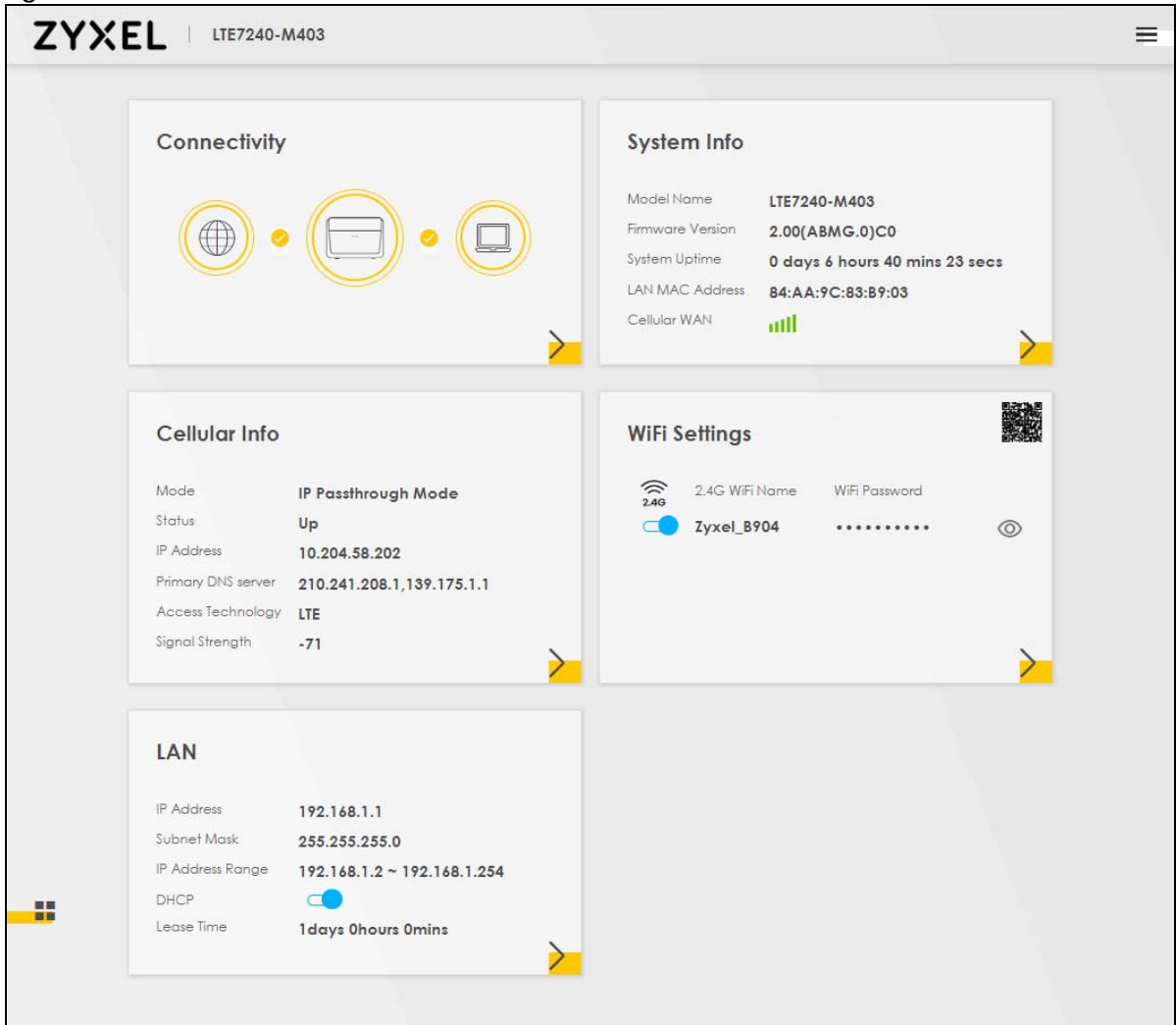

## 2.2 Web Configurator Layout

Figure 10 Screen Layout

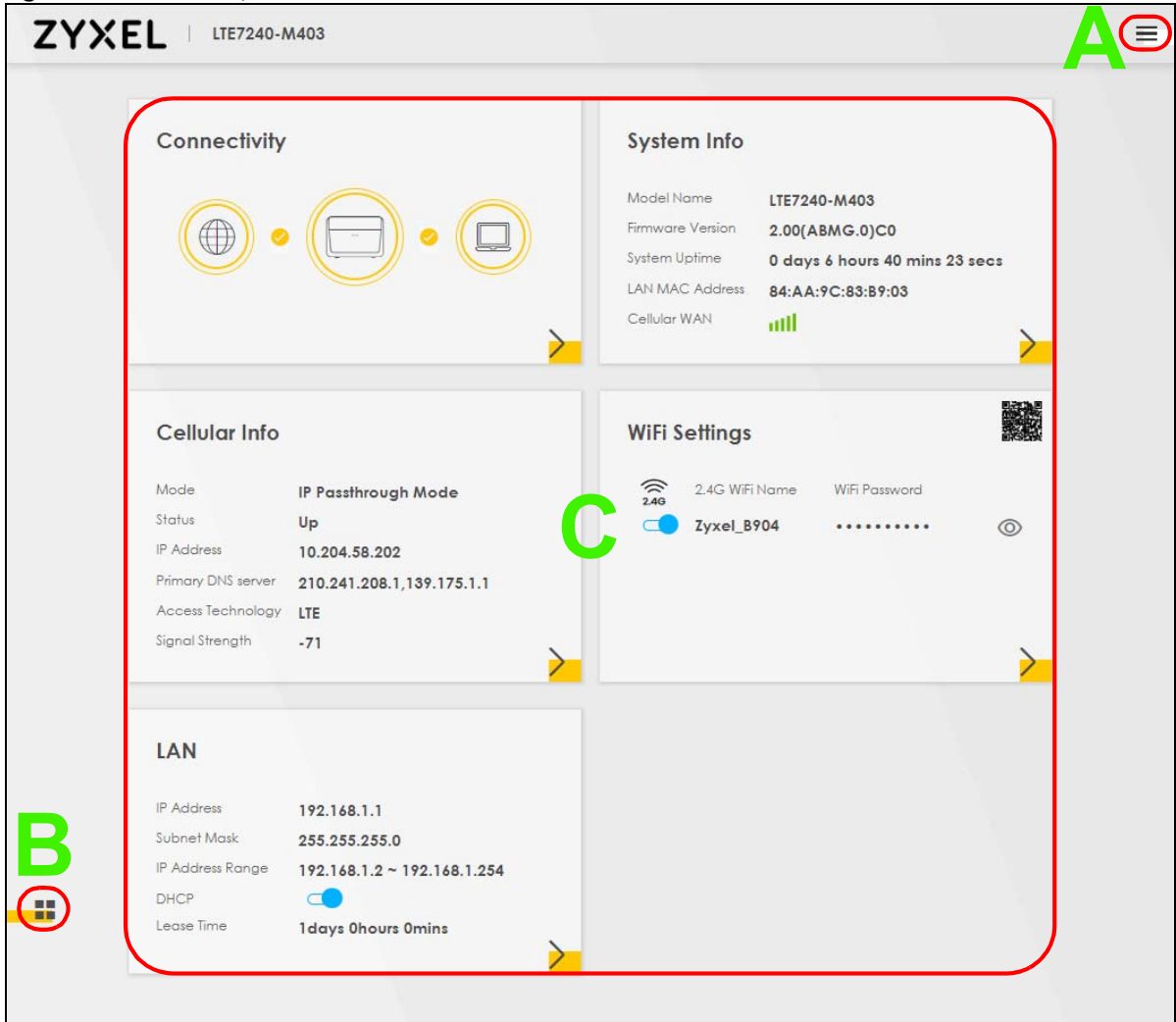

As illustrated above, the main screen is divided into these parts:

- A - Settings Icon (Navigation Panel & Side Bar)
- B - Widget Icon
- C - Main Window

### 2.2.1 Settings Icon

Click this icon (  ) to see the side bar and navigation panel.



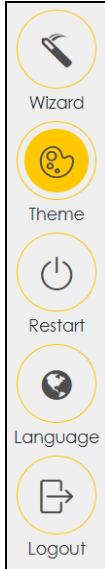

### 2.2.1.1 Side Bar

The side bar provides some icons on the right hand side.

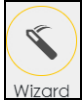
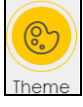

The icons provide the following functions.

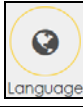
Table 4 Web Configurator Icons in the Title Bar

| ICON  | DESCRIPTION   |
|---|---|
| <br>Wizard   | <b>Wizard:</b> Click this icon to open screens where you can configure the Zyxel Device's time zone and wireless settings. See <a href="#">Chapter 3 on page 27</a> for more information about the <b>Wizard</b> screens. |
| <br>Theme    | <b>Theme:</b> Click this icon to select a color that you prefer and apply it to the Web Configurator.<br>                             |
| <br>Language | <b>Language:</b> Select the language you prefer.  |
| <br>Restart  | <b>Restart:</b> Click this icon to reboot the Zyxel Device without turning the power off.   |
| <br>Logout   | <b>Logout:</b> Click this icon to log out of the Web Configurator.  |

## 2.2.1.2 Navigation Panel

Use the menu items on the navigation panel to open screens to configure Zyxel Device features. The following tables describe each menu item.

Table 5 Navigation Panel Summary

| LINK            | TAB                     | FUNCTION   |
|-----------------|-------------------------|--|
| Home            |                         | Use this screen to configure basic Internet access and wireless settings. This screen also shows the network status of the Zyxel Device and computers/devices connected to it. |
| Network Setting |                         |  |
| Broadband       | Cellular WAN            | Use this screen to configure an LTE WAN connection that includes the Access Point Name (APN) provided by your service provider.  |
|                 | Cellular SIM            | Use this screen to enter a PIN for your SIM card to prevent others from using it.  |
|                 | Cellular Band           | Use this screen to configure the LTE frequency bands that can be used for Internet access as provided by your service provider.  |
|                 | Cellular PLMN           | Use this screen to view available PLMNs and select your preferred network.   |
|                 | Cellular IP Passthrough | Use this screen to enable IP Passthrough mode (bridge mode).   |
| Wireless        | General                 | Use this screen to configure the wireless LAN settings and WLAN authentication/security settings.  |
|                 | MAC Authentication      | Use this screen to block or allow wireless traffic from wireless devices of certain SSIDs and MAC addresses to the Zyxel Device.   |
|                 | WPS                     | Use this screen to configure and view your WPS (WiFi Protected Setup) settings.  |
|                 | WMM                     | Use this screen to enable or disable WiFi MultiMedia (WMM).  |
|                 | Others                  | Use this screen to configure advanced wireless settings.   |
| Home Networking | LAN Setup               | Use this screen to configure LAN TCP/IP settings, and other advanced properties.   |
|                 | Static DHCP             | Use this screen to assign specific IP addresses to individual MAC addresses.   |
|                 | UPnP                    | Use this screen to turn UPnP and UPnP NAT-T on or off.   |
| Routing         | Static Route            | Use this screen to view and set up static routes on the Zyxel Device.  |
|                 | DNS Route               | Use this screen to forward DNS queries for certain domain names through a specific WAN interface to its DNS server(s).   |
|                 | Policy Route            | Use this screen to configure policy routing on the Zyxel Device.   |
|                 | RIP                     | Use this screen to configure Routing Information Protocol to exchange routing information with other routers.  |
| NAT             | Port Forwarding         | Use this screen to make your local servers visible to the outside world.   |
|                 | Port Triggering         | Use this screen to change your Zyxel Device's port triggering settings.  |
|                 | DMZ                     | Use this screen to configure a default server which receives packets from ports that are not specified in the <b>Port Forwarding</b> screen.                                   |
|                 | ALG                     | Use this screen to enable or disable SIP ALG.  |
| DNS             | DNS Entry               | Use this screen to view and configure DNS routes.  |
|                 | Dynamic DNS             | Use this screen to allow a static hostname alias for a dynamic IP address.   |
| Security        |                         |  |





Table 5 Navigation Panel Summary (continued)

| LINK                | TAB                              | FUNCTION   |
|---------------------|----------------------------------|--|
| Firewall            | General                          | Use this screen to configure the security level of your firewall.  |
|                     | Protocol                         | Use this screen to add Internet services and configure firewall rules.   |
|                     | Access Control                   | Use this screen to enable specific traffic directions for network services.  |
|                     | DoS                              | Use this screen to activate protection against Denial of Service (DoS) attacks.  |
| MAC Filter          | MAC Filter                       | Use this screen to block or allow traffic from devices of certain MAC addresses to the Zyxel Device.   |
| Certificates        | Local Certificates               | Use this screen to view a summary list of certificates and manage certificates and certification requests.   |
|                     | Trusted CA                       | Use this screen to view and manage the list of the trusted CAs.  |
| System Monitor      |                                  |  |
| Log                 | System Log                       | Use this screen to view the status of events that occurred to the Zyxel Device. You can export or email the logs.  |
|                     | Security Log                     | Use this screen to view all security related events. You can select the level and category of the security events in their proper drop-down list window.<br><br>Levels include: <ul style="list-style-type: none"> <li>• Emergency</li> <li>• Alert</li> <li>• Critical</li> <li>• Error</li> <li>• Warning</li> <li>• Notice</li> <li>• Informational</li> <li>• Debugging</li> </ul> Categories include: <ul style="list-style-type: none"> <li>• Account</li> <li>• Attack</li> <li>• Firewall</li> <li>• MAC Filter</li> </ul> |
| Traffic Status      | WAN                              | Use this screen to view the status of all network traffic going through the WAN port of the Zyxel Device.  |
|                     | LAN                              | Use this screen to view the status of all network traffic going through the LAN ports of the Zyxel Device.   |
| ARP table           | ARP table                        | Use this screen to view the ARP table. It displays the IP and MAC address of each DHCP connection.   |
| Routing Table       | Routing Table                    | Use this screen to view the routing table on the Zyxel Device.   |
| Cellular WAN Status | Cellular Statistics              | Use this screen to look at the cellular Internet connection status.  |
| Maintenance         |                                  |  |
| System              | System                           | Use this screen to set the Zyxel Device name and Domain name.  |
| User Account        | User Account                     | Use this screen to change the user password on the Zyxel Device.   |
| Remote Management   | MGMT Services                    | Use this screen to enable specific traffic directions for network services.  |
|                     | MGMT Services for IP Passthrough | Use this screen to enable various approaches to access this Zyxel Device remotely from a WAN and/or LAN connection.  |
|                     | Trust Domain                     | Use this screen to view a list of public IP addresses which are allowed to access the Zyxel Device through the services configured in the <b>Maintenance &gt; Remote Management</b> screen.  |

Table 5 Navigation Panel Summary (continued)

| LINK               | TAB                       | FUNCTION   |
|--------------------|---------------------------|--|
| TR-069 Client      | TR-069 Client             | Use this screen to configure your Zyxel Device to be managed remotely by an Auto Configuration Server (ACS) using TR-069.              |
| Time               | Time                      | Use this screen to change your Zyxel Device's time and date.   |
| Email Notification | Email Notification        | Use this screen to configure up to two mail servers and sender addresses on the Zyxel Device.  |
| Log Setting        | Log Setting               | Use this screen to change your Zyxel Device's log settings.  |
| Firmware Upgrade   | Firmware Upgrade          | Use this screen to upload firmware to your Zyxel Device.   |
| Backup/Restore     | Backup/Restore            | Use this screen to backup and restore your Zyxel Device's configuration (settings) or reset the factory default settings.              |
| Reboot             | Reboot                    | Use this screen to reboot the Zyxel Device without turning the power off.  |
| Diagnostic         | Ping&Traceroute &Nslookup | Use this screen to identify problems with the DSL connection. You can use Ping, TraceRoute, or Nslookup to help you identify problems. |

## 2.2.2 Widget Icon

Click this icon () to arrange the screen order. Select a block and hold it to move around. Click the Check icon () in the lower left corner to save the changes.

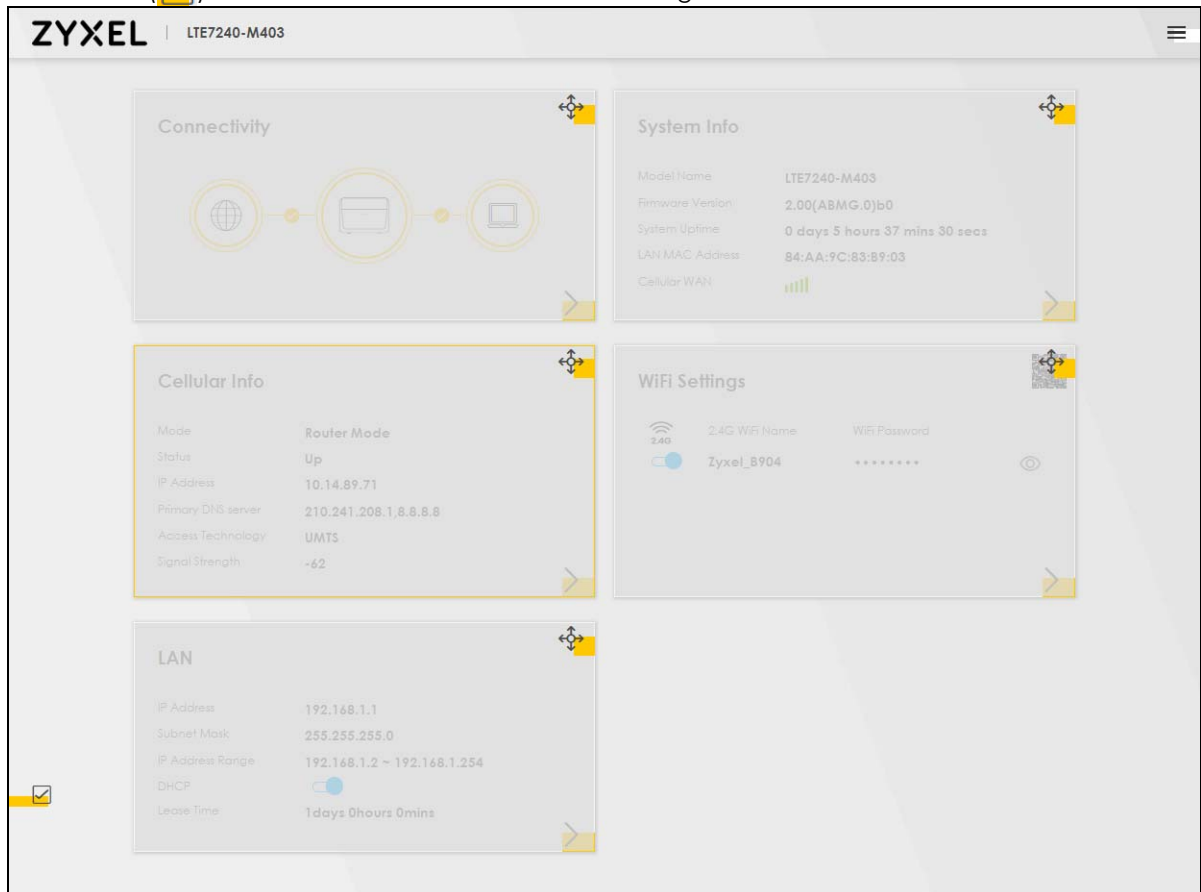

The screenshot displays the ZYXEL web configurator interface for device LTE7240-M403. The interface features several widgets with drag handles (four-way arrows) in their top-right corners, indicating they can be rearranged. A checkmark icon in the bottom-left corner is used to save changes.

**Connectivity** widget shows a network diagram with a globe, a server, and a laptop connected by lines.

**System Info** widget displays the following information:

- Model Name: LTE7240-M403
- Firmware Version: 2.00(ABMG-0)b0
- System Uptime: 0 days 5 hours 37 mins 30 secs
- LAN MAC Address: 94:AA:9C:83:B9:03
- Cellular WAN: 

**Cellular Info** widget displays the following information:

- Mode: Router Mode
- Status: Up
- IP Address: 10.14.89.71
- Primary DNS server: 210.241.208.1, 8.8.8.8
- Access Technology: UMTS
- Signal Strength: -62

**WiFi Settings** widget displays the following information:

- 2.4G WiFi Name: Zyxel\_B904
- WiFi Password: \*\*\*\*\*

**LAN** widget displays the following information:

- IP Address: 192.168.1.1
- Subnet Mask: 255.255.255.0
- IP Address Range: 192.168.1.2 ~ 192.168.1.254
- DHCP:
- Lease Time: 1 days 0 hours 0 mins

# CHAPTER 3

## Quick Start

### 3.1 Overview

Use the **Wizard** screens to configure the Zyxel Device's time zone and wireless settings.

Note: See the technical reference chapters (starting on [Chapter 4 on page 30](#)) for background information on the features in this chapter.

### 3.2 Quick Start Setup

You can click the **Wizard** icon in the side bar to open the **Wizard** screens. See [Section 2.2.1.1 on page 23](#) for more information about the side bar. After you click the **Wizard** icon, the following screen appears. Click **Let's Go** to proceed with settings on time zone and wireless networks. It will take you a few minutes to complete the settings on the **Wizard** screens. You can click **Skip** to leave the **Wizard** screens.

Figure 11 Wizard - Home

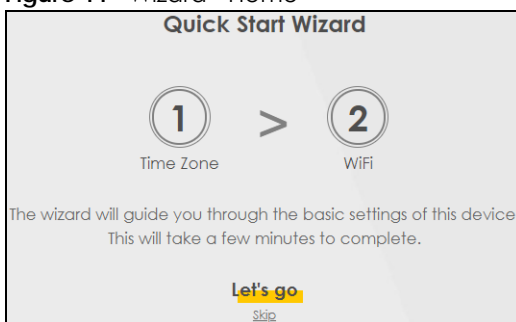

### 3.3 Time Zone

Select the time zone of your location. Click **Next**.

Figure 12 Wizard - Time Zone

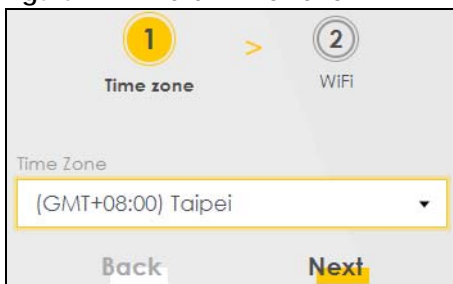

## 3.4 WiFi Setup

Turn WiFi on or off. If you keep it on, record the **WiFi Name** and **Password** in this screen so you can configure your wireless clients to connect to the Zyxel Device. If you want to show or hide your WiFi password, click the Eye icon (👁).  
Click **Done**.

**Figure 13** Wizard - Wireless

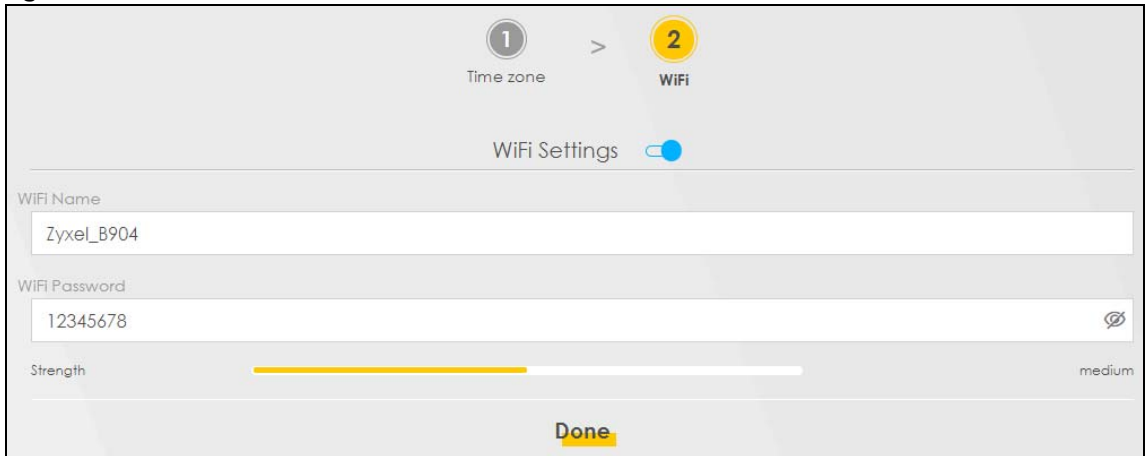

Note: You can also enable the wireless service using any of the following methods:  
Click **Network Setting** > **Wireless** to open the **General** screen. Then select **Enable** in the **Wireless** field. Or,  
Press the **WiFi** button located under the **RESET** button (see [Section 1.7 on page 19](#) for the location) for one second.

## 3.5 Quick Start Setup-Finish

Your Zyxel Device saves your settings and attempts to connect to the Internet.

---

# PART II

## Technical Reference

---

# CHAPTER 4

## Connection Status

### 4.1 Connection Status Overview

After you log into the Web Configurator, the **Connection Status** screen appears. You can configure basic Internet access and wireless settings in this screen. It also shows the network status of the Zyxel Device and computers/devices connected to it.

#### 4.1.1 Connectivity

Use this screen to view the network connection status of the Zyxel Device and its clients.

**Figure 14** Connectivity

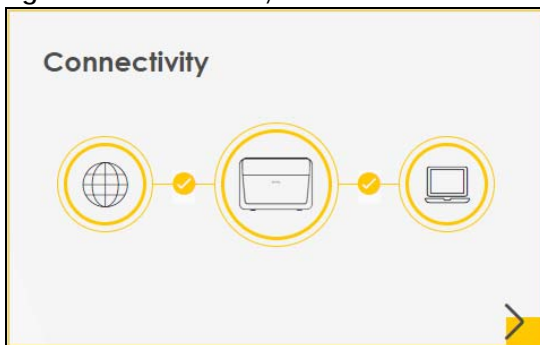

Click the Arrow icon (  ) to view IP addresses and MAC addresses of the wireless and wired devices connected to the Zyxel Device.

**Figure 15** Connectivity: Connected Devices

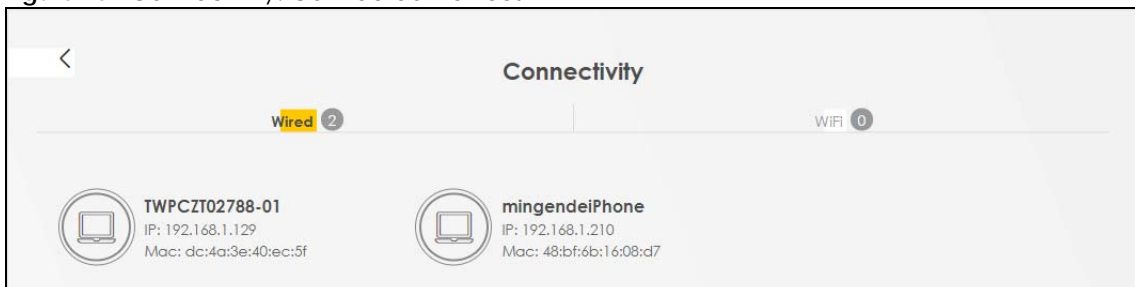

You can change the icon and name of a connected device. Place your mouse within the device block, and an Edit icon (  ) will appear. Click the Edit icon, and you'll see there are several icon choices for you to select. Enter a name in the **Device Name** field for a connected device. Click to enable (  ) **Internet Blocking** for a connected device. Click **Save** to save your changes.

Figure 16 Connectivity: Edit

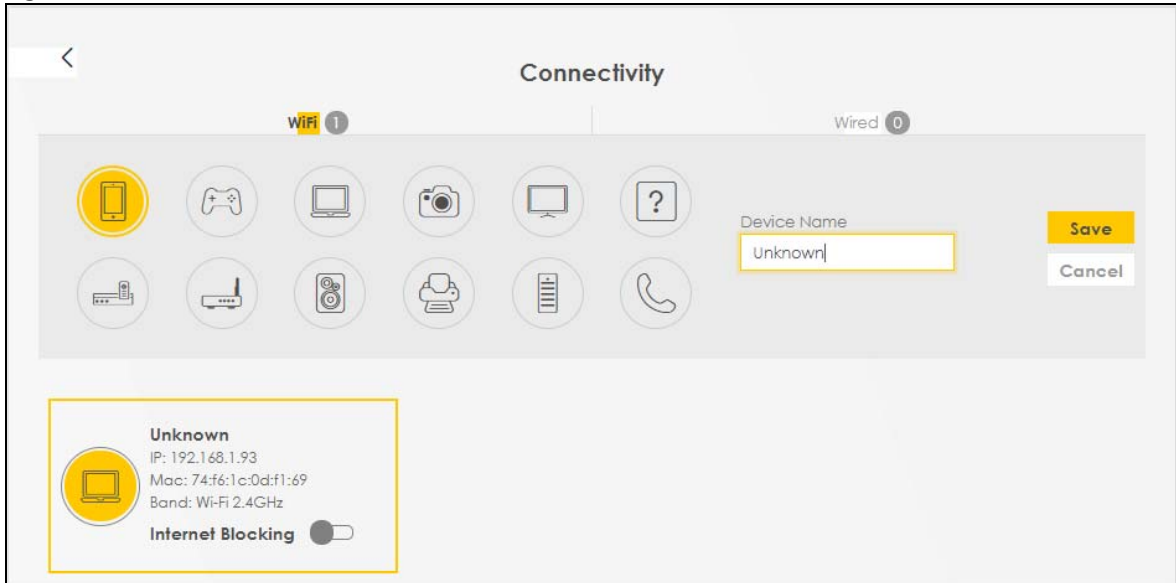

## 4.1.2 System Info

Use this screen to view the basic system information of the Zyxel Device.

Figure 17 System Info

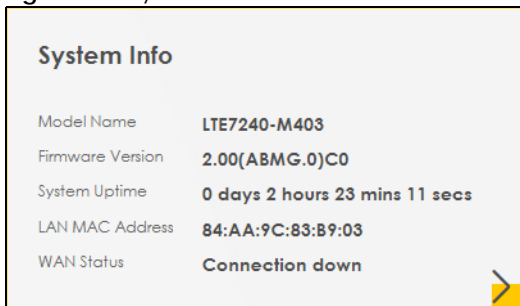

Click the Arrow icon (➤) to view the more information on the status of your firewall and interfaces (WAN, LAN, and WLAN).

Figure 18 System Info: Detailed Information

**System Info**

Host Name: LTE7240-M403  
 Model Name: LTE7240-M403  
 Serial number: S180Y06018918  
 Firmware Version: 2.00(ABMG.0)C0  
 System Uptime: 0 days 2 hours 26 mins 28 secs

**Interface Status**

LAN1: 1000M/Full  
 Cellular  
 WLAN: 2.4G, 300 Mbps

**WAN Information (Cellular WAN)**

Mode: IP Passthrough Mode  
 IP Address: 100.90.168.182  
 IP Subnet Mask: 255.255.255.252  
 IPv6 Address: N/A  
 Primary DNS server: 210.241.208.1  
 Secondary DNS server: 139.175.1.1  
 Primary DNSv6 server: N/A  
 Secondary DNSv6 server: N/A

**WLAN Information**

2.4GHz  
 MAC Address: 84:AA:9C:83:B9:04  
 Status: On  
 SSID: Zyxel\_B904  
 Channel: Auto(Current 11)  
 Security: WPA2-Personal  
 802.11 Mode: 802.11b/g/n Mixed  
 WPS: On

**LAN Information**

IP Address: 192.168.1.1  
 Subnet Mask: 255.255.255.0  
 DHCP: Server

**Security**

Firewall: Medium

Each field is described in the following table.

Table 6 System Info: Detailed Information

| LABEL   | DESCRIPTION  |
|---|--|
| Host Name   | This field displays the Zyxel Device system name. It is used for identification.   |
| Model Name  | This shows the model number of your Zyxel Device.  |
| Serial Number   | This field displays the serial number of the Zyxel Device.   |
| Firmware Version  | This is the current version of the firmware inside the Zyxel Device.   |
| System Up Time  | This field displays how long the Zyxel Device has been running since it last started up. The Zyxel Device starts up when you plug it in, when you restart it ( <b>Maintenance &gt; Reboot</b> ), or when you reset it. |
| Interface Status  |  |
| Virtual ports are shown here. You can see the ports in use and their transmission rate. |  |
| WAN Information (These fields display when you have a WAN connection.)                  |  |
| Mode  | This field displays the current mode of your Zyxel Device.   |
| IP Address  | This field displays the current IP address of the Zyxel Device in the WAN.   |
| IP Subnet Mask  | This field displays the current subnet mask in the WAN.  |
| IPv6 Address  | This field displays the current IPv6 address of the Zyxel Device in the WAN.   |
| Primary DNS server  | This field displays the first DNS server address assigned by the ISP.  |



Table 6 System Info: Detailed Information (continued)

| LABEL                  | DESCRIPTION   |
|------------------------|---|
| Secondary DNS server   | This field displays the second DNS server address assigned by the ISP.  |
| Primary DNSv6 server   | This field displays the first DNS server IPv6 address assigned by the ISP.  |
| Secondary DNSv6 server | This field displays the second DNS server IPv6 address assigned by the ISP.   |
| LAN Information        |   |
| IP Address             | This is the current IP address of the Zyxel Device in the LAN.  |
| Subnet Mask            | This is the current subnet mask in the LAN.   |
| DHCP                   | This field displays what DHCP services the Zyxel Device is providing to the LAN. The possible values are:<br><br><b>Server</b> - The Zyxel Device is a DHCP server in the LAN. It assigns IP addresses to other computers in the LAN.<br><br><b>Relay</b> - The Zyxel Device acts as a surrogate DHCP server and relays DHCP requests and responses between the remote server and the clients.<br><br><b>None</b> - The Zyxel Device is not providing any DHCP services to the LAN. |
| Security               |   |
| Firewall               | This displays the firewall's current security level.  |
| WLAN Information       |   |
| MAC Address            | This shows the wireless adapter MAC (Media Access Control) Address of the wireless interface.   |
| Status                 | This displays whether the WLAN is activated.  |
| SSID                   | This is the descriptive name used to identify the Zyxel Device in a wireless LAN.   |
| Channel                | This is the channel number currently used by the wireless interface.  |
| Security               | This displays the type of security mode the wireless interface is using in the wireless LAN.  |
| 802.11 Mode            | This displays the type of 802.11 mode the wireless interface is using in the wireless LAN.  |
| WPS                    | This displays whether WPS is activated on the wireless interface.   |

### 4.1.3 WiFi Settings



Use this screen to enable or disable the main 2.4 GHz wireless network. When the switch turns blue () , the function is enabled. Otherwise, it's not. You can use this screen or the QR code on the upper right corner to check the SSIDs (WiFi network name) and passwords of the main wireless networks. If you want to show or hide your WiFi passwords, click the Eye icon ().

Figure 19 WiFi Settings



Click the Arrow icon (➤) to configure the SSIDs and/or passwords for your main wireless networks. Click the Eye icon (👁) to display the characters as you enter the WiFi Password.

Figure 20 WiFi Settings: Configuration

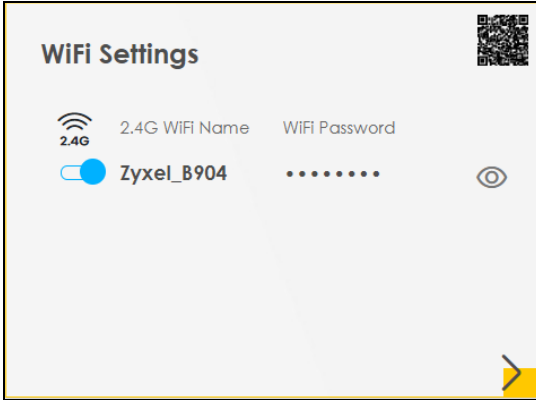
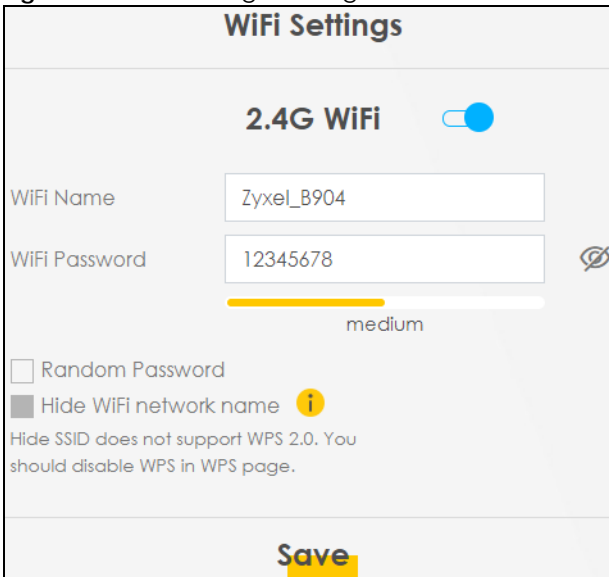

Each field is described in the following table.

Table 7 WiFi Settings: Configuration



| LABEL         | DESCRIPTION  |
|---------------|--|
| 2.4G WiFi     | Click this switch to enable or disable the 2.4 GHz wireless network. When the switch turns blue  , the function is enabled. Otherwise, it's not.  |
| WiFi Name     | The SSID (Service Set IDentity) identifies the service set with which a wireless device is associated. Wireless devices associating to the access point (AP) must have the same SSID.<br>Enter a descriptive name (up to 32 English keyboard characters) for the wireless LAN. |
| WiFi Password | If you selected <b>Random Password</b> , this field displays a pre-shared key generated by the Zyxel Device.<br>If you did not select <b>Random Password</b> , you can manually type a pre-shared key from 8 to 64 case-sensitive keyboard characters.                         |
|               | Click the Eye icon to show or hide the password for your wireless network. When the Eye icon is slashed  , you'll see the password in plain text. Otherwise, it's hidden.                   |

Table 7 WiFi Settings: Configuration (continued)

| LABEL                  | DESCRIPTION   |
|------------------------|---|
| Random Password        | Select this option to have the Zyxel Device automatically generate a password. The <b>WiFi Password</b> field will not be configurable when you select this option.   |
| Hide WiFi network name | Select this check box to hide the SSID in the outgoing beacon frame so a station cannot obtain the SSID through scanning using a site survey tool.<br><br>Note: Disable WPS in the <b>Network Setting &gt; Wireless &gt; WPS</b> screen to hide the SSID. |
| Save                   | Click <b>Save</b> to save your changes.   |

## 4.1.4 LAN

Use this screen to view the LAN IP address, subnet mask, and DHCP settings of your Zyxel Device.

Figure 21 LAN

**LAN**

IP Address **192.168.1.1**

Subnet Mask **255.255.255.0**

IP Address Range **192.168.1.2 ~ 192.168.1.254**

DHCP

Lease Time **1 days 0 hours 0 mins**

Click the Arrow icon (  ) to configure the LAN IP settings and DHCP setting for your Zyxel Device.

Figure 22 LAN Setup

**LAN**

**LAN IP Setup**

IP Address

Subnet Mask

**IP Addressing Values**

Beginning IP Address

Ending IP Address

**DHCP Server State**

DHCP Server Lease Time  days  hours  minutes

**Save**

Each field is described in the following table.

Table 8 Status Screen

| LABEL                  | DESCRIPTION   |
|------------------------|---|
| LAN IP Setup           |   |
| IP Address             | Enter the LAN IPv4 IP address you want to assign to your Zyxel Device in dotted decimal notation, for example, 192.168.1.1 (factory default).   |
| Subnet Mask            | Type the subnet mask of your network in dotted decimal notation, for example 255.255.255.0 (factory default). Your Zyxel Device automatically computes the subnet mask based on the IP Address you enter, so do not change this field unless you are instructed to do so.   |
| IP Addressing Values   |   |
| Beginning IP Address   | This field specifies the first of the contiguous addresses in the IP address pool.  |
| Ending IP Address      | This field specifies the last of the contiguous addresses in the IP address pool.   |
| DHCP Server State      |   |
| DHCP Server Lease Time | This is the period of time DHCP-assigned addresses is used. DHCP automatically assigns IP addresses to clients when they log in. DHCP centralizes IP address management on central computers that run the DHCP server program. DHCP leases addresses, for a period of time, which means that past addresses are "recycled" and made available for future reassignment to other systems. |
| Days/Hours/Minutes     | Enter the lease time of the DHCP server.  |
| Save                   | Click <b>Save</b> to save your changes.   |

# CHAPTER 5

## Broadband

### 5.1 Overview

This chapter discusses the Zyxel Device's **Broadband** screens. Use these screens to configure your Zyxel Device for Internet access.

A WAN (Wide Area Network) connection is an outside connection to another network or the Internet. It connects your private networks, such as a LAN (Local Area Network) and other networks, so that a computer in one location can communicate with computers in other locations.

Figure 23 LAN and WAN

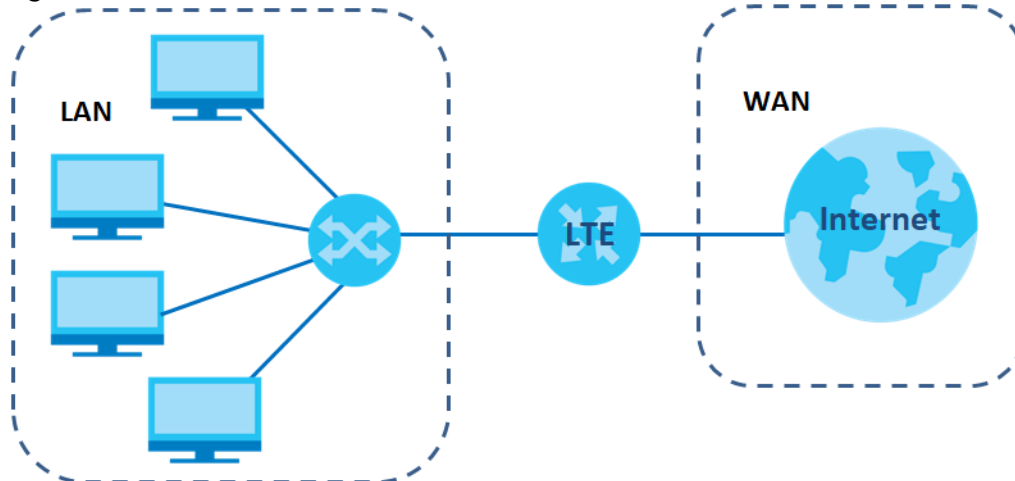

#### 5.1.1 What You Can Do in this Chapter

- Use the **Cellular WAN** screen to configure an LTE WAN connection ([Section 5.2 on page 38](#)).
- Use the **Cellular SIM** screen to enter the PIN of your SIM card ([Section 5.3 on page 40](#)).
- Use the **Cellular Band** screen to view or edit an LTE WAN interface. You can also configure the WAN settings on the Zyxel Device for Internet access ([Section 5.4 on page 41](#)).
- Use the **Cellular PLMN** screen to display available Public Land Mobile Networks ([Section 5.5 on page 42](#)).
- Use the **Cellular IP Passthrough** screen to configure an LTE WAN connection ([Section 5.6 on page 44](#)).

#### 5.1.2 What You Need to Know

The following terms and concepts may help as you read this chapter.

## WAN IP Address

The WAN IP address is an IP address for the Zyxel Device, which makes it accessible from an outside network. It is used by the Zyxel Device to communicate with other devices in other networks. The ISP dynamically assigns it each time the Zyxel Device tries to access the Internet.

## APN

Access Point Name (APN) is a unique string which indicates an LTE network. An APN is required for LTE stations to enter the LTE network and then the Internet.

### 5.1.3 Before You Begin

You may need to know your Internet access settings such as LTE APN, WAN IP address and SIM card's PIN code if the **INTERNET** light on your Zyxel Device is off. Get this information from your service provider.

## 5.2 Cellular WAN

Click **Network Setting > Broadband > Cellular WAN** to display the following screen. Configure an LTE connection, including the Access Point Name (APN) provided by your service provider.

Note: APN information can be obtained from the service provider.

Roaming charges may apply when **Data Roaming** is enabled.

**Automatic APN Mode** is not supported when operating in 3G only mode.

**Figure 24** Network Setting > Broadband > Cellular WAN

Configure an LTE connection, including the Access Point Name (APN) provided by your service provider.

### Roaming

Data Roaming

 Note  
Roaming charges may apply when **Data Roaming** is enabled.

### APN Settings

APN Manual Mode

APN

Username  (Optional)

Password   (Optional)

Authentication Type None ▼

PDP Type IPv4 ▼

 Note  
(1) APN information can be obtained from the service provider.  
(2) **Automatic APN Mode** is not supported when operating in 3G only mode.

Cancel Apply

The following table describes the fields in this screen.

**Table 9** Network Setting > Broadband > Cellular WAN

| LABEL           | DESCRIPTION   |
|-----------------|---|
| Roaming         |   |
| Data Roaming    | Click this to enable ( <input checked="" type="checkbox"/> ) data roaming on the Zyxel Device.<br><br>4G roaming is to use your mobile device in an area which is not covered by your service provider. Enable roaming to ensure that your Zyxel Device is kept connected to the Internet when you are traveling outside the geographical coverage area of the network to which you are registered. |
| APN Settings    |   |
| APN Manual Mode | Disable this to have the Zyxel Device configure the APN (Access Point Name) of an LTE network automatically. Otherwise, Click this to enable ( <input checked="" type="checkbox"/> ) and enter the APN manually in the field below.   |
| APN             | This field allows you to display the Access Point Name (APN) in the profile.<br><br>Enter the Access Point Name (APN) provided by your service provider. Connections with different APNs may provide different services (such as Internet access or MMS (Multi-Media Messaging Service)) and charging method.<br><br>You can enter up to 30 printable ASCII characters. Spaces are allowed.         |
| Username        | This field allows you to display the user name in the profile.<br><br>Type the user name (up to 31 printable ASCII characters) given to you by your service provider.   |
| Password        | This field allows you to set the password in the profile.<br><br>Type the password (up to 31 printable ASCII characters) associated with the user name above.   |

Table 9 Network Setting &gt; Broadband &gt; Cellular WAN (continued)

| LABEL               | DESCRIPTION  |
|---------------------|--|
| Authentication Type | Select the type of authentication method peers use to connect to the Zyxel Device in LTE connections.<br><br>In Password Authentication Protocol ( <b>PAP</b> ) peers identify themselves with a user name and password. In Challenge Handshake Authentication Protocol ( <b>CHAP</b> ) additionally to user name and password the Zyxel Device sends regular challenges to make sure an intruder has not replaced a peer. Otherwise select <b>PAP/CHAP</b> or <b>None</b> . |
| PDP Type            | Select <b>IPv4</b> if you want the Zyxel Device to run IPv4 (Internet Protocol version 4 addressing system) only.<br><br>Select <b>IPv4/IPv6</b> if you want the Zyxel Device to run both IPv4 and IPv6 (Internet Protocol version 4 and 6 addressing system) at the same time.  |
| Apply               | Click this to save your changes.   |
| Cancel              | Click this to exit this screen without saving.   |

## 5.3 Cellular SIM Configuration

Enter a PIN for your SIM card to prevent others from using it.

**Entering the wrong PIN code 3 consecutive times locks the SIM card after which you need a PUK (Personal Unlocking Key) from the service provider to unlock it.**

Click **Network Setting > Broadband > Cellular SIM**. The following screen opens.

Figure 25 Network Setting &gt; Broadband &gt; Cellular SIM

Enter a PIN for your SIM card to prevent others from using it.

**PIN Management**

PIN Protection

PIN

Attempts remaining: 2

Note

(1) The PIN is automatically saved in the Zyxel Device.  
(2) Entering the wrong PIN exceeding a set number of times will lock the SIM card.

Cancel Apply

Note: The PIN is automatically saved in the Zyxel Device.  
Entering the wrong PIN exceeding a set number of times will lock the SIM card.



The following table describes the fields in this screen.

Table 10 Network Setting > Broadband > Cellular SIM

| LABEL              | DESCRIPTION  |
|--------------------|--|
| PIN Management     |  |
| PIN Protection     | A PIN (Personal Identification Number) code is a key to a SIM card. Without the PIN code, you cannot use the SIM card.<br><br>Click to enable (  ) if the service provider requires you to enter a PIN to use the SIM card.<br><br>Click to disable if the service provider lets you use the SIM without inputting a PIN. |
| PIN                | If you enabled PIN verification, enter the 4-digit PIN code (0000 for example) provided by your ISP. If you enter the PIN code incorrectly too many times, the ISP may block your SIM card and not let you use the account to access the Internet.   |
| Attempts Remaining | This is how many more times you can try to enter the PIN code before the ISP blocks your SIM card.   |
| Apply              | Click <b>Apply</b> to save your changes.   |
| Cancel             | Click <b>Cancel</b> to return to the previous screen without saving.   |

## 5.4 Cellular Band Configuration

Either select **Auto** to have the Zyxel Device connect to an available network using the default settings on the SIM card or select the type of the network (**4G**, **3G**, or **2G**) to which you want the Zyxel Device to connect.

Click **Network Setting > Broadband > Cellular Band**. The following screen opens.

Figure 26 Network Setting > Broadband > Cellular Band

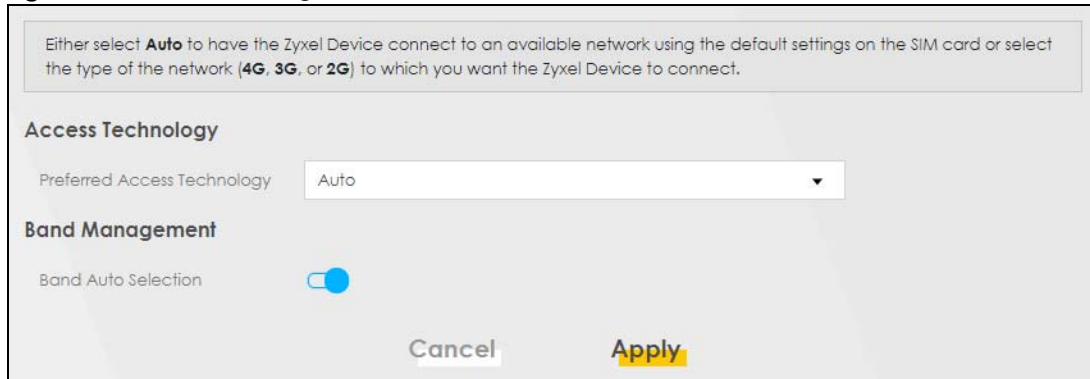

Either select **Auto** to have the Zyxel Device connect to an available network using the default settings on the SIM card or select the type of the network (**4G**, **3G**, or **2G**) to which you want the Zyxel Device to connect.

**Access Technology**

Preferred Access Technology: Auto

**Band Management**

Band Auto Selection:

Cancel Apply

The following table describes the fields in this screen.

Table 11 Network Setting > Broadband > Cellular Band

| LABEL                       | DESCRIPTION  |
|-----------------------------|--|
| Access Technology           |  |
| Preferred Access Technology | Select the type of the network ( <b>4G</b> , <b>3G</b> , or <b>2G</b> ) to which you want the Zyxel Device to connect and click <b>Apply</b> to save your settings.<br><br>Otherwise, select <b>Auto</b> to have the Zyxel Device connect to an available network using the default settings on the SIM card. If the currently registered mobile network is not available or the mobile network's signal strength is too low, the Zyxel Device switches to another available mobile network. |
| Band Management             |  |
| Band Auto Selection         | Select the LTE bands to use for the Zyxel Device's WAN connection. Click to enable (  ) automatic LTE frequency band selection as provided by your service provider. Otherwise, select disabled.  |
| Apply                       | Click this to save your changes.   |
| Cancel                      | Click this to exit this screen without saving.   |

## 5.5 PLMN Configuration

Each service provider has its own unique Public Land Mobile Network (PLMN) number. Either select **PLMN Auto Selection** to have the Zyxel Device connect to the service provider using the default settings on the SIM card or manually view available PLMNs and select your service provider.

Click **Network Setting > Broadband > Cellular PLMN**. The screen appears as shown next.

Figure 27 Network Setting > Broadband > Cellular PLMN

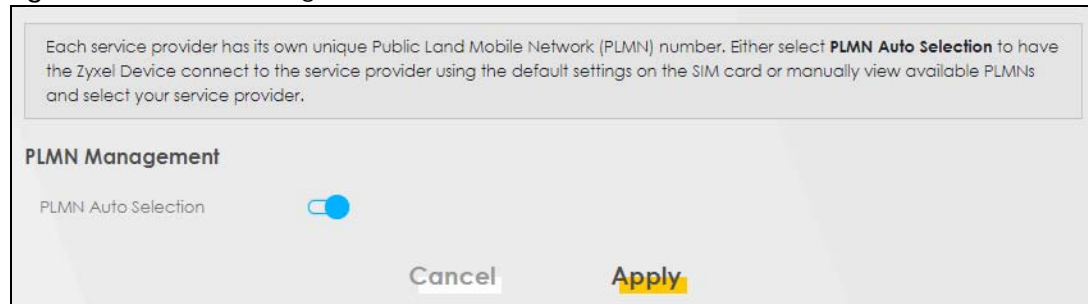

The following table describes the labels in this screen.

Table 12 Network Setting > Broadband > Cellular PLMN

| LABEL               | DESCRIPTION  |
|---------------------|--|
| PLMN Management     |  |
| PLMN Auto Selection | Click to enable (  ) and have the Zyxel Device automatically connect to the first available mobile network.<br><br>Select disabled to display the network list and manually select a preferred network. |
| Apply               | Click <b>Apply</b> to save your changes back to the Zyxel Device.  |
| Cancel              | Click <b>Cancel</b> to exit this screen without saving.  |

After selecting to disable the following warning appears. Click **OK** to continue.

**Figure 28** Network Setting > Broadband > Cellular PLMN > Manual Scan Warning

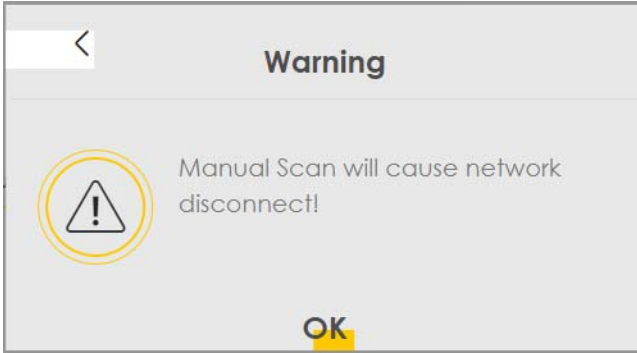

When the next screen appears, clicking **Scan** will allow the Zyxel Device to check for available PLMNs in its surroundings and display the network list.

**Figure 29** Network Setting > Broadband > Cellular PLMN > Manual Scan

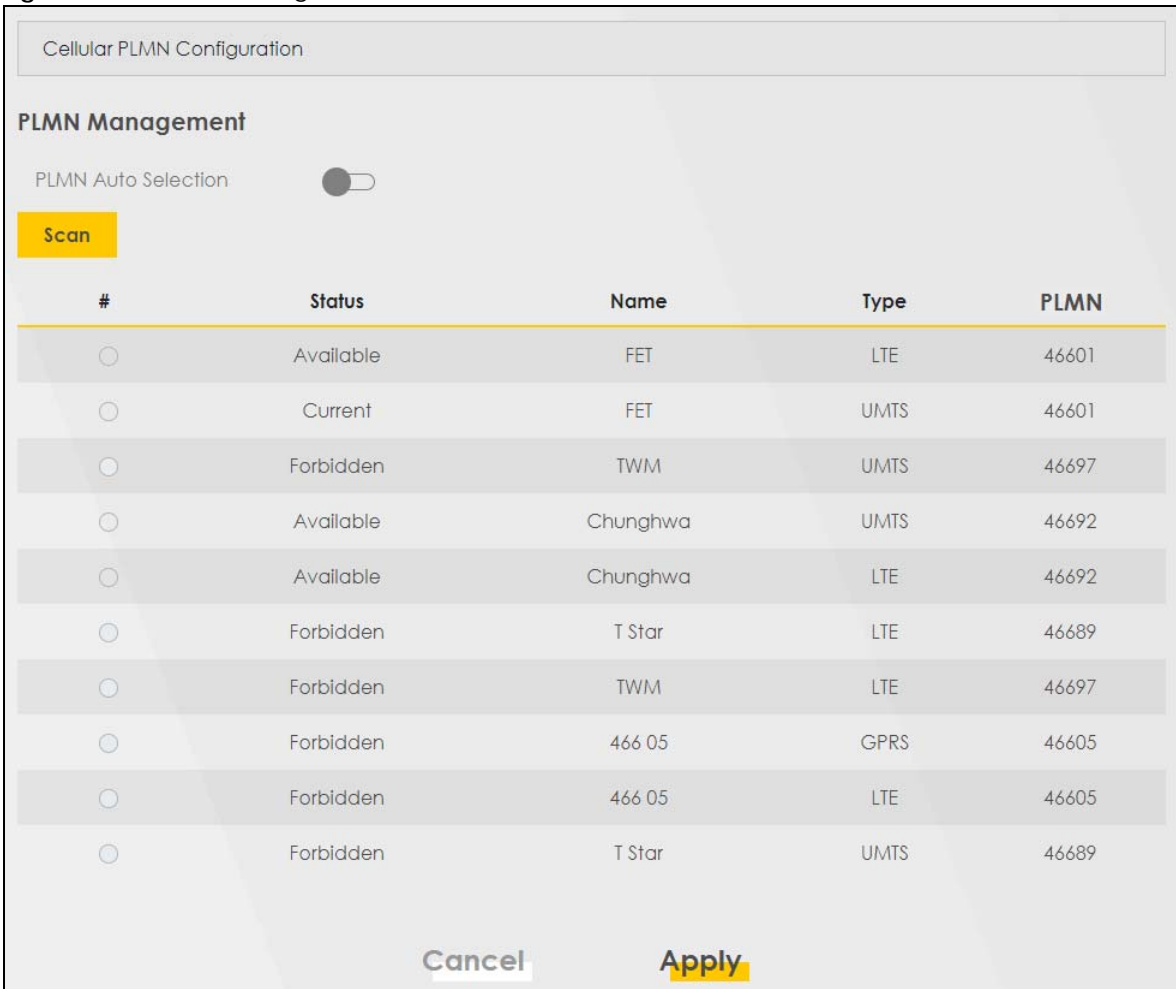

The following table describes the labels in this screen.

Table 13 Network Setting > Broadband > Cellular PLMN > Manual Scan

| LABEL  | DESCRIPTION   |
|--------|---|
| #      | Click the radio button so the Zyxel Device connects to this ISP.  |
| Status | This shows <b>Current</b> to show the ISP the Zyxel Device is currently connected to.<br>This shows <b>Forbidden</b> to indicate the Zyxel Device cannot connect to this ISP.<br>This shows <b>Available</b> to indicate an available ISP your Zyxel Device can connect to. |
| Name   | This shows the ISP name.  |
| Type   | This shows the type of network the ISP provides.  |
| PLMN   | This shows the PLMN number.   |
| Apply  | Click <b>Apply</b> to save your changes back to the Zyxel Device.   |
| Cancel | Click <b>Cancel</b> to exit this screen without saving.   |

Select from the network list and click **Apply**.

## 5.6 IP Passthrough

Enable **IP Passthrough** to allow Internet traffic to go to a LAN computer behind the Zyxel Device without going through NAT.

Click **Network Setting > Broadband > Cellular IP Passthrough** to display the following screen.

Figure 30 Network Setting > Broadband > Cellular IP Passthrough

Note: Changing the **IP Passthrough** settings may affect the network setting of client devices.

After selecting to enable the following warning appears. Click **OK** to continue.

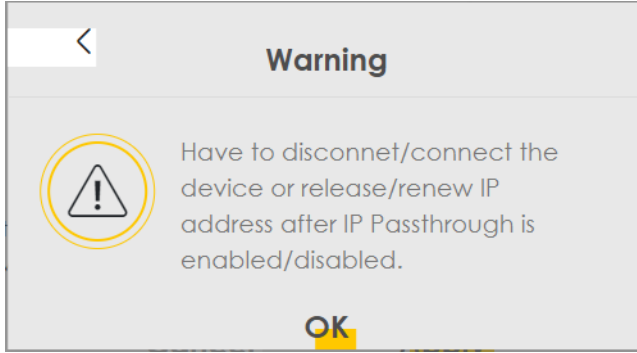
**Figure 31** Network Setting > Broadband > Cellular IP Passthrough > Enable Warning

The following table describes the fields in this screen.

**Table 14** Network Setting > Broadband > IP Passthrough

| LABEL                     | DESCRIPTION   |
|---------------------------|---|
| IP Passthrough Management |   |
| IP Passthrough            | IP Passthrough allows a LAN computer on the local network of the Zyxel Device to have access to web services using the public IP address. When IP Passthrough is configured, all traffic is forwarded to the LAN computer and will not go through NAT.  |
| Passthrough Mode          | Select <b>Dynamic</b> to allow traffic to be forwarded to any LAN computer on the local network of the Zyxel Device. Select <b>Fixed</b> to allow traffic to be forwarded to a specific LAN computer on the local network of the Zyxel Device.<br><br>Note: This field will show upon enabling <b>IP Passthrough</b> in the previous field. |
| Passthrough to fixed MAC  | Enter the MAC address of a LAN computer on the local network of the Zyxel Device upon selecting <b>Fixed</b> in the previous field.<br><br>Note: This field will show upon selecting <b>Fixed</b> in the previous field.  |
| Apply                     | Click this to save your changes.  |
| Cancel                    | Click this to exit this screen without saving.  |

# CHAPTER 6

## Wireless

### 6.1 Overview

This chapter describes the Zyxel Device's **Network Setting > Wireless** screens. Use these screens to set up your Zyxel Device's WiFi network and security settings.

#### 6.1.1 What You Can Do in this Chapter

This section describes the Zyxel Device's **Wireless** screens. Use these screens to set up your Zyxel Device's WiFi connection.

- Use the **General** screen to enable the Wireless LAN, enter the SSID and select the WiFi security mode ([Section 6.2 on page 47](#)).
- Use the **MAC Authentication** screen to allow or deny wireless clients based on their MAC addresses from connecting to the Zyxel Device ([Section 6.3 on page 50](#)).
- Use the **WPS** screen to enable or disable WPS, view or generate a security PIN (Personal Identification Number) ([Section 6.4 on page 52](#)).
- Use the **WMM** screen to enable WiFi MultiMedia (WMM) to ensure quality of service in WiFi networks for multimedia applications ([Section 6.5 on page 54](#)).
- Use the **Others** screen to configure WiFi advanced features, such as the RTS/CTS Threshold ([Section 6.6 on page 55](#)).

#### 6.1.2 What You Need to Know

##### Wireless Basics

"Wireless" is essentially radio communication. In the same way that walkie-talkie radios send and receive information over the airwaves, wireless networking devices exchange information with one another. A wireless networking device is just like a radio that lets your computer exchange information with radios attached to other computers. Like walkie-talkies, most wireless networking devices operate at radio frequency bands that are open to the public and do not require a license to use. However, wireless networking is different from that of most traditional radio communications in that there are a number of wireless networking standards available with different methods of data encryption.

##### Finding Out More

See [Section 6.7 on page 57](#) for advanced technical information on WiFi networks.

## 6.2 General Settings

A WiFi network name (also known as SSID) and a security level are basic elements of a WiFi network. Set a **Security Level** to protect your data from unauthorized access or damage via WiFi. Use this screen to enable WiFi, enter the SSID and select the WiFi security mode. It's recommended that you select **More Secure** to enable **WPA2-PSK** data encryption.

Note: If you are configuring the Zyxel Device from a computer connected to WiFi and you change the Zyxel Device's SSID, channel or security settings, you will lose your WiFi connection when you press **Apply** to confirm. You must then change the WiFi settings of your computer to match the Zyxel Device's new settings.

Click **Network Setting > Wireless** to open the **General** screen.

**Figure 32** Network Setting > Wireless > General

A network name (also known as SSID) and a security level are basic elements of a network. Set a **Security Level** to protect your data from unauthorized access or damage via WiFi. It's recommended that you select **More Secure** to enable **WPA2-PSK** data encryption.

### WiFi Network Setup

Band: 2.4GHz

WiFi:

Channel: Auto Current : 11 / 20 MHz

Bandwidth: 20/40MHz

Control Sideband: Lower

### WiFi Network Settings

WiFi Network Name: Zyxel\_B904

Max Clients: 32

Hide SSID ! Hide SSID does not support WPS 2.0. You should disable WPS in WPS page.

Multicast Forwarding

BSSID: 84:AA:9C:83:B9:04

### Security Level

No Security
More Secure (Recommended)

Cancel
Apply

The following table describes the general wireless LAN labels in this screen.

Table 15 Network Setting > Wireless > General

| LABEL                 | DESCRIPTION   |
|-----------------------|---|
| WiFi Network Setup    |   |
| Band                  | This shows the WiFi band which this radio profile is using. <b>2.4GHz</b> is the frequency used by IEEE 802.11b/g/n WiFi clients while <b>5GHz</b> is used by IEEE 802.11a/ac WiFi clients.   |
| WiFi                  | Click <b>Enable</b> to enable the wireless LAN in this field.   |
| Channel               | Use <b>Auto</b> to have the Zyxel Device automatically determine a channel to use.  |
| Bandwidth             | Select whether the Zyxel Device uses a WiFi channel width of <b>20MHz</b> , <b>40MHz</b> or <b>20/40MHz</b> .<br><br>A standard 20MHz channel offers transfer speeds of up to 150Mbps whereas a 40MHz channel uses two standard channels and offers speeds of up to 300Mbps.<br><br>40MHz (channel bonding or dual channel) bonds two adjacent radio channels to increase throughput. The WiFi clients must also support 40MHz. It is often better to use the 20MHz setting in a location where the environment hinders the WiFi signal.<br><br>Select <b>20MHz</b> if you want to lessen radio interference with other WiFi devices in your neighborhood or the WiFi clients do not support channel bonding. |
| Control Sideband      | This is available for some regions when you select a specific channel and set the Bandwidth field to <b>40MHz</b> . Set whether the control channel (set in the <b>Channel</b> field) should be in the <b>Lower</b> or <b>Upper</b> range of channel bands.   |
| WiFi Network Settings |   |
| WiFi Network Name     | The SSID (Service Set IDentity) identifies the service set with which a WiFi device is associated. WiFi devices associating to the access point (AP) must have the same SSID.<br><br>Enter a descriptive name (up to 32 English keyboard characters) for the wireless LAN.  |
| Max Clients           | Specify the maximum number of clients that can connect to this network at the same time.  |
| Hide SSID             | Select this check box to hide the SSID in the outgoing beacon frame so a station cannot obtain the SSID through scanning using a site survey tool.<br><br>This check box is grayed out if the WPS function is enabled in the <b>Network &gt; Wireless &gt; WPS</b> screen.  |
| Multicast Forwarding  | Select this check box to allow the Zyxel Device to convert wireless multicast traffic into wireless unicast traffic.  |
| BSSID                 | This shows the MAC address of the wireless interface on the Zyxel Device when wireless LAN is enabled.  |
| Security Level        |   |
| Security Mode         | Select <b>More Secure (WPA2-PSK)</b> to add security on this WiFi network. The WiFi clients which want to associate to this network must have the same WiFi security settings as the Zyxel Device. When you select to use a security, additional options appears in this screen.<br><br>Or you can select <b>No Security</b> to allow any client to associate with this network without any data encryption or authentication.<br><br>See the following sections for more details about this field.   |
| Cancel                | Click <b>Cancel</b> to restore your previously saved settings.  |
| Apply                 | Click <b>Apply</b> to save your changes.  |

## 6.2.1 No Security

Select **No Security** to allow wireless stations to communicate with the access points without any data encryption or authentication.



Note: If you do not enable any WiFi security on your Zyxel Device, your network is accessible to any wireless networking device that is within range.

**Figure 33** Wireless > General: No Security

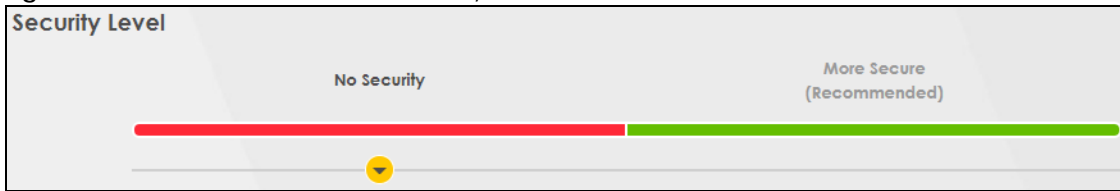

The following table describes the labels in this screen.

Table 16 Wireless > General: No Security

| LABEL          | DESCRIPTION  |
|----------------|--|
| Security Level | Choose <b>No Security</b> to allow all WiFi connections without data encryption or authentication. |

## 6.2.2 More Secure (WPA2-PSK)

The WPA2-PSK security mode is a newer, more robust version of the WPA encryption standard. It offers slightly better security, although the use of PSK makes it less robust than it could be. Using a Pre-Shared Key (PSK), both the Zyxel Device and the connecting client share a common password in order to validate the connection.

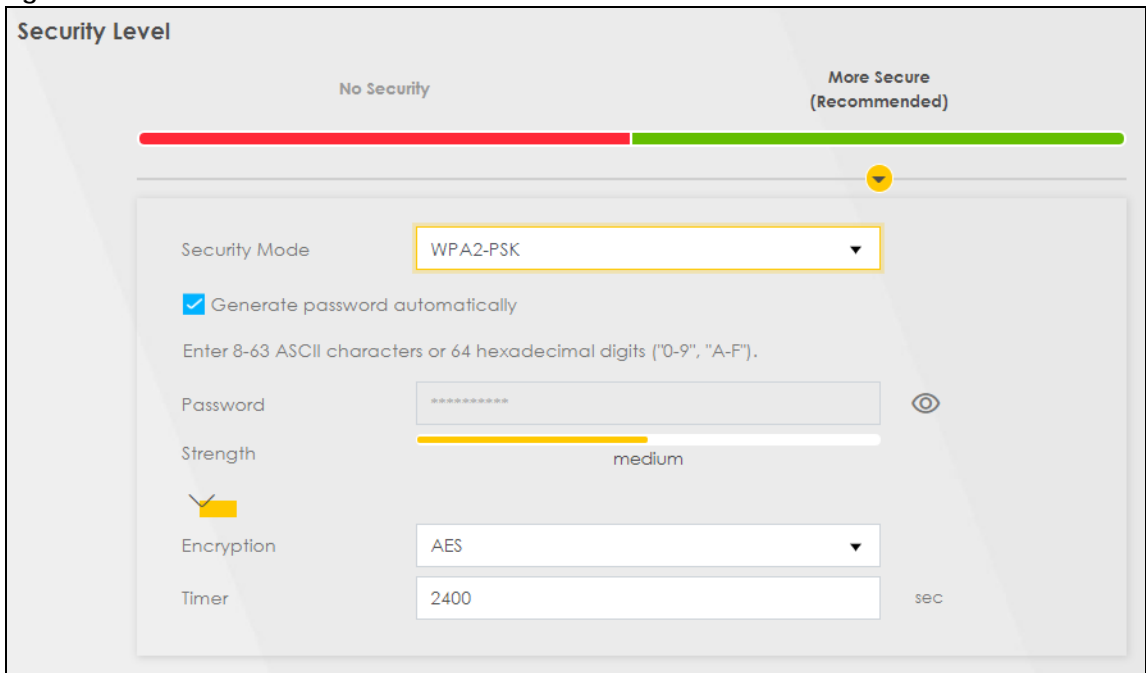

Click **Network Setting > Wireless** to display the **General** screen. Select **More Secure** as the security level. **WPA2-PSK** is the default **Security Mode**.

**Figure 34** Wireless > General: More Secure: WPA2-PSK



The following table describes the labels in this screen.

Table 17 Wireless > General: More Secure: WPA2-PSK

| LABEL                           | DESCRIPTION   |
|---------------------------------|---|
| Security Level                  | Select <b>More Secure</b> to enable WPA2-PSK data encryption.   |
| Security Mode                   | <b>WPA2-PSK</b> is the default security mode.   |
| Generate password automatically | Select this option to have the Zyxel Device automatically generate a password. The password field will not be configurable when you select this option.   |
| Password                        | Select <b>Generate password automatically</b> or enter a <b>Password</b> .<br>The password has two uses.<br><ol style="list-style-type: none"> <li>1. Manual. Manually enter the same password on the Zyxel Device and the client. Enter 8-63 ASCII characters or exactly 64 hexadecimal ('0-9', 'a-f') characters.</li> <li>2. WPS. When using WPS, the Zyxel Device sends this password to the client.</li> </ol> <p>Note: Enter 8-63 ASCII characters only. 64 hexadecimal characters are not accepted for WPS.</p> <p>Click the Eye icon to show or hide the password for your wireless network. When the Eye icon is slashed , you'll see the password in plain text. Otherwise, it's hidden.</p> |
| more...                         | Click this  to show more fields in this section. Click this  to hide them.  |
| Encryption                      | <b>AES</b> is the default data encryption type, which uses a 128-bit key.   |
| Timer                           | This is the rate at which the RADIUS server sends a new group key out to all clients.   |

## 6.3 MAC Authentication

Configure the Zyxel Device to give exclusive access to specific devices (**Allow**) or exclude specific devices from accessing the Zyxel Device (**Deny**) based on the device(s) MAC address. Every Ethernet device has a unique MAC (Media Access Control) address. It is assigned at the factory and consists of six pairs of hexadecimal characters; for example, 00:A0:C5:00:00:02. You need to know the MAC addresses of the device(s) you want to allow/deny to configure this screen. Edit the list in the table to decide the rule of access on device(s).

Use this screen to view your Zyxel Device's MAC filter settings and add new MAC filter rules. Click **Network Setting > Wireless > MAC Authentication**. The screen appears as shown.

**Figure 35** Network Setting> Wireless > MAC Authentication

Configure the Zyxel Device to give exclusive access to specific devices (**Allow**) or exclude specific devices from accessing the Zyxel Device (**Deny**) based on the device(s) MAC address. Every Ethernet device has a unique MAC (Media Access Control) address. It is assigned at the factory and consists of six pairs of hexadecimal characters; for example, 00:A0:C5:00:00:02. You need to know the MAC addresses of the device(s) you want to allow/deny to configure this screen. Edit the list in the table to decide the rule of access on device(s).

**General**

SSID: Zyxel\_B904

MAC Restrict Mode:  Disable  Deny  Allow

**MAC address List**

+ Add new MAC address

| # | MAC Address | Modify |
|---|-------------|--------|
|   |             |        |

Note  
A maximum of 25 MAC Authentication rules can be configured.

Cancel Apply

The following table describes the labels in this screen.

**Table 18** Network Setting> Wireless > MAC Authentication

| LABEL               | DESCRIPTION  |
|---------------------|--|
| General             |  |
| SSID                | Select the SSID for which you want to configure MAC filter settings.   |
| MAC Restrict Mode   | Define the filter action for the list of MAC addresses in the <b>MAC Address</b> table.<br>Select <b>Disable</b> to turn off MAC filtering.<br>Select <b>Deny</b> to block access to the Zyxel Device. MAC addresses not listed will be allowed to access the Zyxel Device.<br>Select <b>Allow</b> to permit access to the Zyxel Device. MAC addresses not listed will be denied access to the Zyxel Device.   |
| MAC address List    |  |
| Add new MAC address | This field is available when you select <b>Deny</b> or <b>Allow</b> in the <b>MAC Restrict Mode</b> field.<br>Click this if you want to add a new MAC address entry to the MAC filter list below.<br>Enter the MAC addresses of the WiFi devices that are allowed or denied access to the Zyxel Device in these address fields. Enter the MAC addresses in a valid MAC address format, that is, six hexadecimal character pairs, for example, 12:34:56:78:9a:bc. |
| #                   | This is the index number of the entry.   |
| MAC Address         | This is the MAC addresses of the WiFi devices that are allowed or denied access to the Zyxel Device.   |
| Modify              | Click the <b>Edit</b> icon and type the MAC address of the peer device in a valid MAC address format (six hexadecimal character pairs, for example 12:34:56:78:9a:bc).<br>Click the <b>Delete</b> icon to delete the entry.  |

Table 18 Network Setting &gt; Wireless &gt; MAC Authentication (continued)

| LABEL  | DESCRIPTION   |
|--------|---|
| Cancel | Click <b>Cancel</b> to exit this screen without saving. |
| Apply  | Click <b>Apply</b> to save your changes.                |

## 6.4 WPS

Use this screen to configure WiFi Protected Setup (WPS) on your Zyxel Device.

WiFi Protected Setup (WPS) allows you to quickly set up a WiFi network with strong security, without having to configure security settings manually. Select one of the WPS methods and follow the instructions to establish a WPS connection. To set up a WPS connection between two devices, both devices must support WPS. It is recommended to use the Push Button Configuration (**PBC**) method if your WiFi client supports it. See [Section 6.7.7.3 on page 65](#) for more information about WPS.

Note: The Zyxel Device uses the security settings of the **SSID1** profile (see [Section 6.2.2 on page 49](#)).

Note: The WPS button will gray-out when wireless LAN or WPS is disabled.  
If WPS is enabled, UPnP will automatically be turned on.

Click **Network Setting > Wireless > WPS**. The following screen displays. Click this switch and it will turn blue. Click **Apply** to activate the WPS function. Then you can configure the WPS settings in this screen.

Figure 36 Network Setting &gt; Wireless &gt; WPS

WiFi Protected Setup (WPS) allows you to quickly set up a WiFi network with strong security, without having to configure security settings manually. Select one of the WPS methods and follow the instructions to establish a WPS connection. To set up a WPS connection between two devices, both devices must support WPS. It is recommended to use the Push Button Configuration (PBC) method if your client supports it.

**General**

WPS

**Add a new device with WPS Method**

**Method 1 PBC**

**Step1.** Click WPS button **WPS**

**Step2.** Press the WPS button on your new WiFi client device within 120 seconds

**Method 2 PIN**

**Step1.** Enter the PIN of your new WiFi client device and then click Register

 Register

**Method 3**

**Enter AP's PIN Number in WiFi Client**

**Current state** Configured

1. Please release configuration if you want to configure the WiFi settings

Release Configuration

2. Enter current PIN number on your WiFi client

Generate New PIN

**Note**

(1) The Zyxel Device uses the security settings of the SSID1 profile.  
 (2) The WPS button will gray-out when wireless LAN or WPS is disabled.  
 If WPS is enabled, UPnP will automatically be turned on.

**Cancel** **Apply**

The following table describes the labels in this screen.

Table 19 Network Setting &gt; Wireless &gt; WPS

| LABEL                            | DESCRIPTION   |
|----------------------------------|---|
| General                          |   |
| WPS                              | Click to enable ( <input checked="" type="checkbox"/> ) and have the Zyxel Device activate WPS. Otherwise, it is disabled.  |
| Add a new device with WPS Method |   |
| Method 1 PBC                     | Use this section to set up a WPS WiFi network using Push Button Configuration (PBC). Click this switch to make it turn blue. Click <b>Apply</b> to activate WPS method 1 on the Zyxel Device.   |
| WPS                              | Click this button to add another WPS-enabled WiFi device (within WiFi range of the Zyxel Device) to your WiFi network. This button may either be a physical button on the outside of a device, or a menu button similar to the <b>WPS</b> button on this screen.<br><br>Note: You must press the other WiFi device's WPS button within two minutes of pressing this button. |
| Method 2 PIN                     | Use this section to set up a WPS WiFi network by entering the PIN of the client into the Zyxel Device. Click this switch to make it turn blue. Click <b>Apply</b> to activate WPS method 2 on the Zyxel Device.   |

Table 19 Network Setting &gt; Wireless &gt; WPS (continued)

| LABEL                 | DESCRIPTION  |
|-----------------------|--|
| Register              | Enter the PIN of the device that you are setting up a WPS connection with and click <b>Register</b> to authenticate and add the WiFi device to your WiFi network.<br><br>You can find the PIN either on the outside of the device, or by checking the device's settings.<br><br>Note: You must also activate WPS on that device within two minutes to have it present its PIN to the Zyxel Device. |
| Method 3              | Use this section to set up a WPS WiFi network by entering the PIN of the Zyxel Device into the client. Click this switch to make it turn blue. Click <b>Apply</b> to activate WPS method 3 on the Zyxel Device.  |
| Release Configuration | The default WPS status is configured.<br><br>Click this button to remove all configured WiFi and WiFi security settings for WPS connections on the Zyxel Device.   |
| Generate New PIN      | If this method has been enabled, the PIN (Personal Identification Number) of the Zyxel Device is shown here. Enter this PIN in the configuration utility of the device you want to connect to using WPS.<br><br>The PIN is not necessary when you use the WPS push-button method.<br><br>Click the <b>Generate New PIN</b> button to have the Zyxel Device create a new PIN.                       |
| Cancel                | Click <b>Cancel</b> to restore your previously saved settings.   |
| Apply                 | Click <b>Apply</b> to save your changes.   |

## 6.5 WMM

Enable WiFi MultiMedia (**WMM**) and **WMM Automatic Power Save (APSD)** in WiFi networks for delay-sensitive multimedia applications. **WMM** enhances data transmission quality which allows delay-sensitive applications, such as videos, to run more smoothly. **APSD** improves power management of WiFi mobile clients. **APSD** works only if the WiFi device to which the Zyxel Device is connected also supports this feature.

Click **Network Setting > Wireless > WMM** to display the following screen.

Figure 37 Network Setting &gt; Wireless &gt; WMM

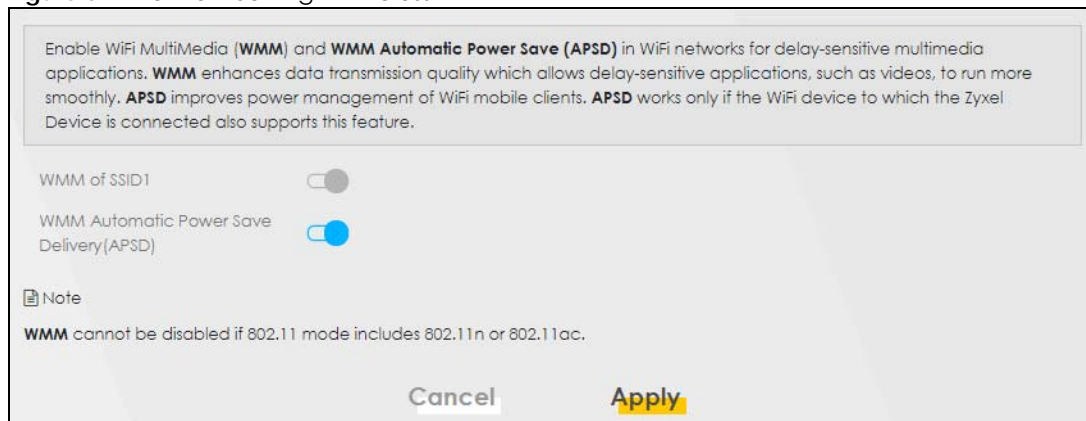

Note: **WMM** cannot be disabled if 802.11 mode includes 802.11n or 802.11ac.

The following table describes the labels in this screen.

Table 20 Network Setting > Wireless > WMM

| LABEL                                    | DESCRIPTION   |
|--|---|
| WMM of SSID1~4                           | Select <b>On</b> to have the Zyxel Device automatically give the WiFi network (SSIDx) a priority level according to the ToS value in the IP header of packets it sends. WMM QoS (WiFi MultiMedia Quality of Service) gives high priority to video, which makes them run more smoothly.<br><br>If the <b>802.11 Mode</b> in <b>Network Setting &gt; Wireless &gt; Others</b> is set to include 802.11n or 802.11ac, WMM cannot be disabled.  |
| WMM Automatic Power Save Delivery (APSD) | Select this option to extend the battery life of your mobile devices (especially useful for small devices that are running multimedia applications). The Zyxel Device goes to sleep mode to save power when it is not transmitting data. The AP buffers the packets sent to the Zyxel Device until the Zyxel Device "wakes up." The Zyxel Device wakes up periodically to check for incoming data.<br><br>Note: This works only if the WiFi device to which the Zyxel Device is connected also supports this feature. |
| Cancel                                   | Click <b>Cancel</b> to restore your previously saved settings.  |
| Apply                                    | Click <b>Apply</b> to save your changes.  |

## 6.6 Others Settings

Use this screen to change the default advanced WiFi settings. See the User's Guide for field details. Click **Network Setting > Wireless > Others**. The screen appears as shown.

See [Section 6.7.2 on page 59](#) for detailed definitions of the terms listed here.

Figure 38 Network Setting > Wireless > Others

Use this screen to change the default advanced WiFi settings. See the User's Guide for field details.

|                             |  |    |
|-----------------------------|--|----|
| RTS/CTS Threshold           | <input type="text" value="2347"/>              |    |
| Fragmentation Threshold     | <input type="text" value="2346"/>              |    |
| Output Power                | <input type="text" value="100%"/>              | ▼  |
| Beacon Interval             | <input type="text" value="100"/>               | ms |
| DTIM Interval               | <input type="text" value="1"/>                 | ms |
| 802.11 Mode                 | <input type="text" value="802.11b/g/n Mixed"/> | ▼  |
| 802.11 Protection           | <input type="text" value="Auto"/>              | ▼  |
| Preamble                    | <input type="text" value="Long"/>              |    |
| Protected Management Frames | <input type="text" value="Capable"/>           | ▼  |

The following table describes the labels in this screen.

Table 21 Network Setting > Wireless > Others

| LABEL                   | DESCRIPTION   |
|-------------------------|---|
| RTS/CTS Threshold       | Data with its frame size larger than this value will perform the RTS (Request To Send)/CTS (Clear To Send) handshake.<br><br>Enter a value between 0 and 2347.  |
| Fragmentation Threshold | This is the maximum data fragment size that can be sent. Enter a value between 256 and 2346.  |
| Output Power            | Set the output power of the Zyxel Device. If there is a high density of APs in an area, decrease the output power to reduce interference with other APs. Select one of the following: <b>20%</b> , <b>40%</b> , <b>60%</b> , <b>80%</b> or <b>100%</b> .  |
| Beacon Interval         | When a wirelessly networked device sends a beacon, it includes with it a beacon interval. This specifies the time period before the device sends the beacon again.<br><br>The interval tells receiving devices on the network how long they can wait in low power mode before waking up to handle the beacon. This value can be set from 50ms to 1000ms. A high value helps save current consumption of the access point.   |
| DTIM Interval           | Delivery Traffic Indication Message (DTIM) is the time period after which broadcast and multicast packets are transmitted to mobile clients in the Power Saving mode. A high DTIM value can cause clients to lose connectivity with the network. This value can be set from 1 to 255.   |
| 802.11 Mode             | <p>For 2.4GHz frequency WLAN devices:</p> <ul style="list-style-type: none"> <li>• Select <b>802.11b Only</b> to allow only IEEE 802.11b compliant WLAN devices to associate with the Zyxel Device.</li> <li>• Select <b>802.11g Only</b> to allow only IEEE 802.11g compliant WLAN devices to associate with the Zyxel Device.</li> <li>• Select <b>802.11n Only</b> to allow only IEEE 802.11n compliant WLAN devices to associate with the Zyxel Device.</li> <li>• Select <b>802.11b/g Mixed</b> to allow either IEEE 802.11b or IEEE 802.11g compliant WLAN devices to associate with the Zyxel Device. The transmission rate of your Zyxel Device might be reduced.</li> <li>• Select <b>802.11b/g/n Mixed</b> to allow IEEE 802.11b, IEEE 802.11g or IEEE802.11n compliant WLAN devices to associate with the Zyxel Device. The transmission rate of your Zyxel Device might be reduced.</li> </ul> <p>For 5GHz frequency WLAN devices:</p> <ul style="list-style-type: none"> <li>• Select <b>802.11a Only</b> to allow only IEEE 802.11a compliant WLAN devices to associate with the Zyxel Device.</li> <li>• Select <b>802.11n Only</b> to allow only IEEE 802.11n compliant WLAN devices to associate with the Zyxel Device.</li> <li>• Select <b>802.11ac Only</b> to allow only IEEE 802.11ac compliant WLAN devices to associate with the Zyxel Device.</li> <li>• Select <b>802.11a/n Mixed</b> to allow either IEEE 802.11a or IEEE 802.11n compliant WLAN devices to associate with the Zyxel Device. The transmission rate of your Zyxel Device might be reduced.</li> <li>• Select <b>802.11n/ac Mixed</b> to allow either IEEE 802.11n or IEEE 802.11ac compliant WLAN devices to associate with the Zyxel Device. The transmission rate of your Zyxel Device might be reduced.</li> <li>• Select <b>802.11a/n/ac Mixed</b> to allow IEEE 802.11a, IEEE 802.11n or IEEE802.11ac compliant WLAN devices to associate with the Zyxel Device. The transmission rate of your Zyxel Device might be reduced.</li> </ul> |
| 802.11 Protection       | <p>Enabling this feature can help prevent collisions in mixed-mode networks (networks with both IEEE 802.11b and IEEE 802.11g traffic).</p> <p>Select <b>Auto</b> to have the wireless devices transmit data after a RTS/CTS handshake. This helps improve IEEE 802.11g performance.</p> <p>Select <b>Off</b> to disable 802.11 protection. The transmission rate of your Zyxel Device might be reduced in a mixed-mode network.</p> <p>This field displays <b>Off</b> and is not configurable when you set <b>802.11 Mode</b> to <b>802.11b Only</b>.</p>  |



Table 21 Network Setting &gt; Wireless &gt; Others (continued)

| LABEL                       | DESCRIPTION   |
|-----------------------------|---|
| Preamble                    | Select a preamble type from the drop-down list box. Choices are <b>Long</b> or <b>Short</b> . See <a href="#">Section 6.7.6 on page 62</a> for more information.<br><br>This field is configurable only when you set 802.11 Mode to <b>802.11b</b> .  |
| Protected Management Frames | WiFi with Protected Management Frames (PMF) provides protection for unicast and multicast management action frames. Unicast management action frames are protected from both eavesdropping and forging, and multicast management action frames are protected from forging. Select <b>Capable</b> if the WiFi client supports PMF, then the management frames will be encrypted. Select <b>Required</b> to force the WiFi client to support PMF; otherwise the authentication cannot be performed by the Zyxel Device. Otherwise, select <b>Disabled</b> . |
| Cancel                      | Click <b>Cancel</b> to restore your previously saved settings.  |
| Apply                       | Click <b>Apply</b> to save your changes.  |

## 6.7 Technical Reference

This section discusses wireless LANs in depth.

### 6.7.1 WiFi Network Overview

WiFi networks consist of WiFi clients, access points and bridges.

- A WiFi client is a radio connected to a user's computer.
- An access point is a radio with a wired connection to a network, which can connect with numerous WiFi clients and let them access the network.
- A bridge is a radio that relays communications between access points and WiFi clients, extending a network's range.

Normally, a WiFi network operates in an "infrastructure" type of network. An "infrastructure" type of network has one or more access points and one or more WiFi clients. The WiFi clients connect to the access points.

The following figure provides an example of a WiFi network.

**Figure 39** Example of a WiFi Network

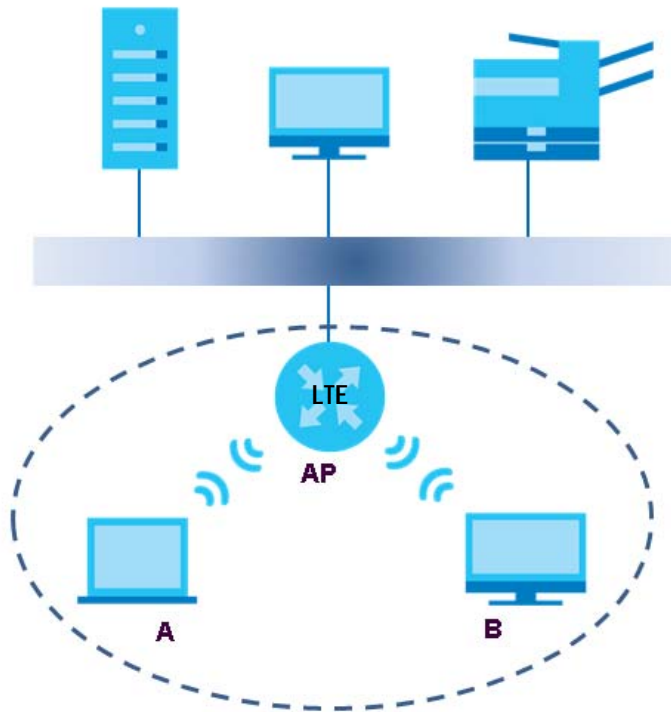

The WiFi network is the part in the blue circle. In this WiFi network, devices **A** and **B** use the access point (**AP**) to interact with the other devices (such as the printer) or with the Internet. Your Zyxel Device is the AP.

Every WiFi network must follow these basic guidelines.

- Every device in the same WiFi network must use the same SSID.  
The SSID is the name of the WiFi network. It stands for Service Set Identifier.
- If two WiFi networks overlap, they should use a different channel.  
Like radio stations or television channels, each WiFi network uses a specific channel, or frequency, to send and receive information.
- Every device in the same WiFi network must use security compatible with the AP.  
Security stops unauthorized devices from using the WiFi network. It can also protect the information that is sent in the WiFi network.

## Radio Channels

In the radio spectrum, there are certain frequency bands allocated for unlicensed, civilian use. For the purposes of WiFi networking, these bands are divided into numerous channels. This allows a variety of networks to exist in the same place without interfering with one another. When you create a network, you must select a channel to use.

Since the available unlicensed spectrum varies from one country to another, the number of available channels also varies.

## 6.7.2 Additional Wireless Terms

The following table describes some WiFi network terms and acronyms used in the Zyxel Device's Web Configurator.

Table 22 Additional WiFi Terms

| TERM                    | DESCRIPTION  |
|-------------------------|--|
| RTS/CTS Threshold       | <p>In a WiFi network which covers a large area, WiFi devices are sometimes not aware of each other's presence. This may cause them to send information to the AP at the same time and result in information colliding and not getting through.</p> <p>By setting this value lower than the default value, the WiFi devices must sometimes get permission to send information to the Zyxel Device. The lower the value, the more often the devices must get permission.</p> <p>If this value is greater than the fragmentation threshold value (see below), then WiFi devices never have to get permission to send information to the Zyxel Device.</p> |
| Preamble                | A preamble affects the timing in your WiFi network. There are two preamble modes: long and short. If a device uses a different preamble mode than the Zyxel Device does, it cannot communicate with the Zyxel Device.  |
| Authentication          | The process of verifying whether a WiFi device is allowed to use the WiFi network.   |
| Fragmentation Threshold | A small fragmentation threshold is recommended for busy networks, while a larger threshold provides faster performance if the network is not very busy.  |

## 6.7.3 WiFi Security Overview

By their nature, radio communications are simple to intercept. For WiFi data networks, this means that anyone within range of a WiFi network without security can not only read the data passing over the airwaves, but also join the network. Once an unauthorized person has access to the network, he or she can steal information or introduce malware (malicious software) intended to compromise the network. For these reasons, a variety of security systems have been developed to ensure that only authorized people can use a WiFi data network, or understand the data carried on it.

These security standards do two things. First, they authenticate. This means that only people presenting the right credentials (often a username and password, or a "key" phrase) can access the network. Second, they encrypt. This means that the information sent over the air is encoded. Only people with the code key can understand the information, and only people who have been authenticated are given the code key.

These security standards vary in effectiveness. Some can be broken, such as the old Wired Equivalent Protocol (WEP). Using WEP is better than using no security at all, but it will not keep a determined attacker out. Other security standards are secure in themselves but can be broken if a user does not use them properly. For example, the WPA-PSK security standard is very secure if you use a long key which is difficult for an attacker's software to guess - for example, a twenty-letter long string of apparently random numbers and letters - but it is not very secure if you use a short key which is very easy to guess - for example, a three-letter word from the dictionary.

Because of the damage that can be done by a malicious attacker, it's not just people who have sensitive information on their network who should use security. Everybody who uses any WiFi network should ensure that effective security is in place.

A good way to come up with effective security keys, passwords and so on is to use obscure information that you personally will easily remember, and to enter it in a way that appears random and does not include real words. For example, if your mother owns a 1970 Dodge Challenger and her favorite movie is

Vanishing Point (which you know was made in 1971) you could use "70dodchal71vanpoi" as your security key.

The following sections introduce different types of WiFi security you can set up in the WiFi network.

### 6.7.3.1 SSID

Normally, the Zyxel Device acts like a beacon and regularly broadcasts the SSID in the area. You can hide the SSID instead, in which case the Zyxel Device does not broadcast the SSID. In addition, you should change the default SSID to something that is difficult to guess.

This type of security is fairly weak, however, because there are ways for unauthorized WiFi devices to get the SSID. In addition, unauthorized WiFi devices can still see the information that is sent in the WiFi network.

### 6.7.3.2 MAC Address Filter

Every device that can use a WiFi network has a unique identification number, called a MAC address.<sup>1</sup> A MAC address is usually written using twelve hexadecimal characters<sup>2</sup>; for example, 00A0C5000002 or 00:A0:C5:00:00:02. To get the MAC address for each device in the WiFi network, see the device's User's Guide or other documentation.

You can use the MAC address filter to tell the Zyxel Device which devices are allowed or not allowed to use the WiFi network. If a device is allowed to use the WiFi network, it still has to have the correct information (SSID, channel, and security). If a device is not allowed to use the WiFi network, it does not matter if it has the correct information.

This type of security does not protect the information that is sent in the WiFi network. Furthermore, there are ways for unauthorized WiFi devices to get the MAC address of an authorized device. Then, they can use that MAC address to use the WiFi network.

### 6.7.3.3 User Authentication

Authentication is the process of verifying whether a WiFi device is allowed to use the WiFi network. You can make every user log in to the WiFi network before using it. However, every device in the WiFi network has to support IEEE 802.1x to do this.

For WiFi networks, you can store the user names and passwords for each user in a RADIUS server. This is a server used in businesses more than in homes. If you do not have a RADIUS server, you cannot set up user names and passwords for your users.

Unauthorized WiFi devices can still see the information that is sent in the WiFi network, even if they cannot use the WiFi network. Furthermore, there are ways for unauthorized WiFi users to get a valid user name and password. Then, they can use that user name and password to use the WiFi network.

### 6.7.3.4 Encryption

WiFi networks can use encryption to protect the information that is sent in the WiFi network. Encryption is like a secret code. If you do not know the secret code, you cannot understand the message.

- 
1. Some wireless devices, such as scanners, can detect WiFi networks but cannot use WiFi networks. These kinds of wireless devices might not have MAC addresses.
  2. Hexadecimal characters are 0, 1, 2, 3, 4, 5, 6, 7, 8, 9, A, B, C, D, E, and F.

The types of encryption you can choose depend on the type of authentication. (See [Section 6.7.3.3 on page 60](#) for information about this.)

Table 23 Types of Encryption for Each Type of Authentication

|           | NO AUTHENTICATION | RADIUS SERVER |
|-----------|-------------------|---------------|
| Weakest   | No Security       | WPA           |
| ↑↓        | WPA-PSK           |               |
| Strongest | WPA2-PSK          |               |

For example, if the WiFi network has a RADIUS server, you can choose **WPA** or **WPA2**. If users do not log in to the WiFi network, you can choose no encryption, **WPA-PSK**, or **WPA2-PSK**.

Note: It is recommended that WiFi networks use **WPA-PSK**, **WPA**, or stronger encryption. The other types of encryption are better than none at all, but it is still possible for unauthorized WiFi devices to figure out the original information pretty quickly.

Many types of encryption use a key to protect the information in the WiFi network. The longer the key, the stronger the encryption. Every device in the WiFi network must have the same key.

## 6.7.4 Signal Problems

Because WiFi networks are radio networks, their signals are subject to limitations of distance, interference and absorption.

Problems with distance occur when the two radios are too far apart. Problems with interference occur when other radio waves interrupt the data signal. Interference may come from other radio transmissions, such as military or air traffic control communications, or from machines that are coincidental emitters such as electric motors or microwaves. Problems with absorption occur when physical objects (such as thick walls) are between the two radios, muffling the signal.

## 6.7.5 BSS

A Basic Service Set (BSS) exists when all communications between wireless stations go through one access point (AP).

Intra-BSS traffic is traffic between wireless stations in the BSS. When Intra-BSS traffic blocking is disabled, wireless station A and B can access the wired network and communicate with each other. When Intra-BSS traffic blocking is enabled, wireless station A and B can still access the wired network but cannot communicate with each other.

Figure 40 Basic Service Set

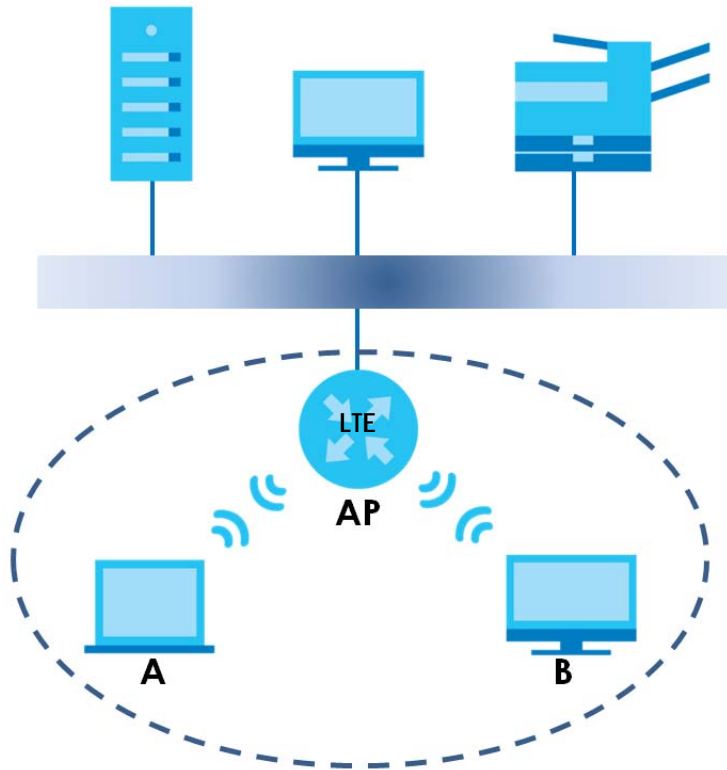

## 6.7.6 Preamble Type

Preamble is used to signal that data is coming to the receiver. Short and long refer to the length of the synchronization field in a packet.

Short preamble increases performance as less time sending preamble means more time for sending data. All IEEE 802.11 compliant wireless adapters support long preamble, but not all support short preamble.

Use long preamble if you are unsure what preamble mode other WiFi devices on the network support, and to provide more reliable communications in busy WiFi networks.

Use short preamble if you are sure all WiFi devices on the network support it, and to provide more efficient communications.

Use the dynamic setting to automatically use short preamble when all WiFi devices on the network support it, otherwise the Zyxel Device uses long preamble.

Note: The WiFi devices **MUST** use the same preamble mode in order to communicate.

## 6.7.7 WiFi Protected Setup (WPS)

Your Zyxel Device supports WiFi Protected Setup (WPS), which is an easy way to set up a secure WiFi network. WPS is an industry standard specification, defined by the WiFi Alliance.

WPS allows you to quickly set up a WiFi network with strong security, without having to configure security settings manually. Each WPS connection works between two devices. Both devices must support WPS (check each device's documentation to make sure).

Depending on the devices you have, you can either press a button (on the device itself, or in its configuration utility) or enter a PIN (a unique Personal Identification Number that allows one device to authenticate the other) in each of the two devices. When WPS is activated on a device, it has two minutes to find another device that also has WPS activated. Then, the two devices connect and set up a secure network by themselves.

### 6.7.7.1 Push Button Configuration

WPS Push Button Configuration (PBC) is initiated by pressing a button on each WPS-enabled device, and allowing them to connect automatically. You do not need to enter any information.

Not every WPS-enabled device has a physical WPS button. Some may have a WPS PBC button in their configuration utilities instead of or in addition to the physical button.

Take the following steps to set up WPS using the button.

- 1 Ensure that the two devices you want to set up are within wireless range of one another.
- 2 Look for a WPS button on each device. If the device does not have one, log into its configuration utility and locate the button (see the device's User's Guide for how to do this - for the Zyxel Device, see [Section 6.4 on page 52](#)).
- 3 Press the button on one of the devices (it doesn't matter which). For the Zyxel Device you must press the **WiFi** button for more than five seconds.
- 4 Within two minutes, press the button on the other device. The registrar sends the network name (SSID) and security key through a secure connection to the enrollee.

If you need to make sure that WPS worked, check the list of associated WiFi clients in the AP's configuration utility. If you see the WiFi client in the list, WPS was successful.

### 6.7.7.2 PIN Configuration

Each WPS-enabled device has its own PIN (Personal Identification Number). This may either be static (it cannot be changed) or dynamic (in some devices you can generate a new PIN by clicking on a button in the configuration interface).

Use the PIN method instead of the push-button configuration (PBC) method if you want to ensure that the connection is established between the devices you specify, not just the first two devices to activate WPS in range of each other. However, you need to log into the configuration interfaces of both devices to use the PIN method.

When you use the PIN method, you must enter the PIN from one device (usually the WiFi client) into the second device (usually the Access Point or wireless router). Then, when WPS is activated on the first device, it presents its PIN to the second device. If the PIN matches, one device sends the network and security information to the other, allowing it to join the network.

Take the following steps to set up a WPS connection between an access point or wireless router (referred to here as the AP) and a client device using the PIN method.

- 1** Ensure WPS is enabled on both devices.
- 2** Access the WPS section of the AP's configuration interface. See the device's User's Guide on how to do this.
- 3** Look for the client's WPS PIN; it will be displayed either on the device, or in the WPS section of the client's configuration interface (see the device's User's Guide on how to find the WPS PIN - for the Zyxel Device, see [Section 6.4 on page 52](#)).
- 4** Enter the client's PIN in the AP's configuration interface.
- 5** If the client device's configuration interface has an area for entering another device's PIN, you can either enter the client's PIN in the AP, or enter the AP's PIN in the client - it does not matter which.
- 6** Start WPS on both devices within two minutes.
- 7** Use the configuration utility to activate WPS, not the push-button on the device itself.
- 8** On a computer connected to the WiFi client, try to connect to the Internet. If you can connect, WPS was successful.

If you cannot connect, check the list of associated WiFi clients in the AP's configuration utility. If you see the WiFi client in the list, WPS was successful.

The following figure shows a WPS-enabled WiFi client (installed in a notebook computer) connecting to the WPS-enabled AP via the PIN method.



**Figure 41** Example WPS Process: PIN Method  
**ENROLLEE**

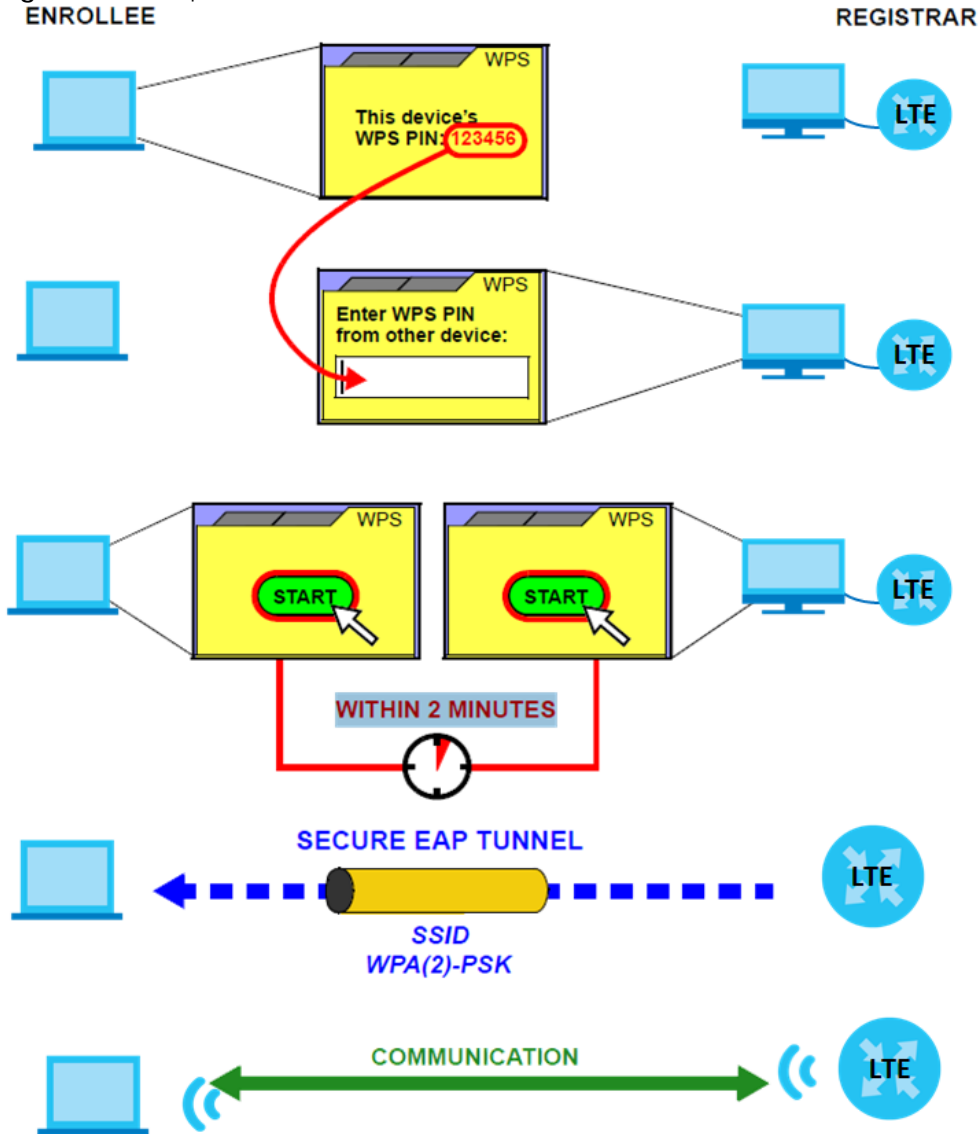

### 6.7.7.3 How WPS Works

When two WPS-enabled devices connect, each device must assume a specific role. One device acts as the registrar (the device that supplies network and security settings) and the other device acts as the enrollee (the device that receives network and security settings). The registrar creates a secure EAP (Extensible Authentication Protocol) tunnel and sends the network name (SSID) and the WPA-PSK or WPA2-PSK pre-shared key to the enrollee. Whether WPA-PSK or WPA2-PSK is used depends on the standards supported by the devices. If the registrar is already part of a network, it sends the existing information. If not, it generates the SSID and WPA(2)-PSK randomly.

The following figure shows a WPS-enabled client (installed in a notebook computer) connecting to a WPS-enabled access point.

Figure 42 How WPS works

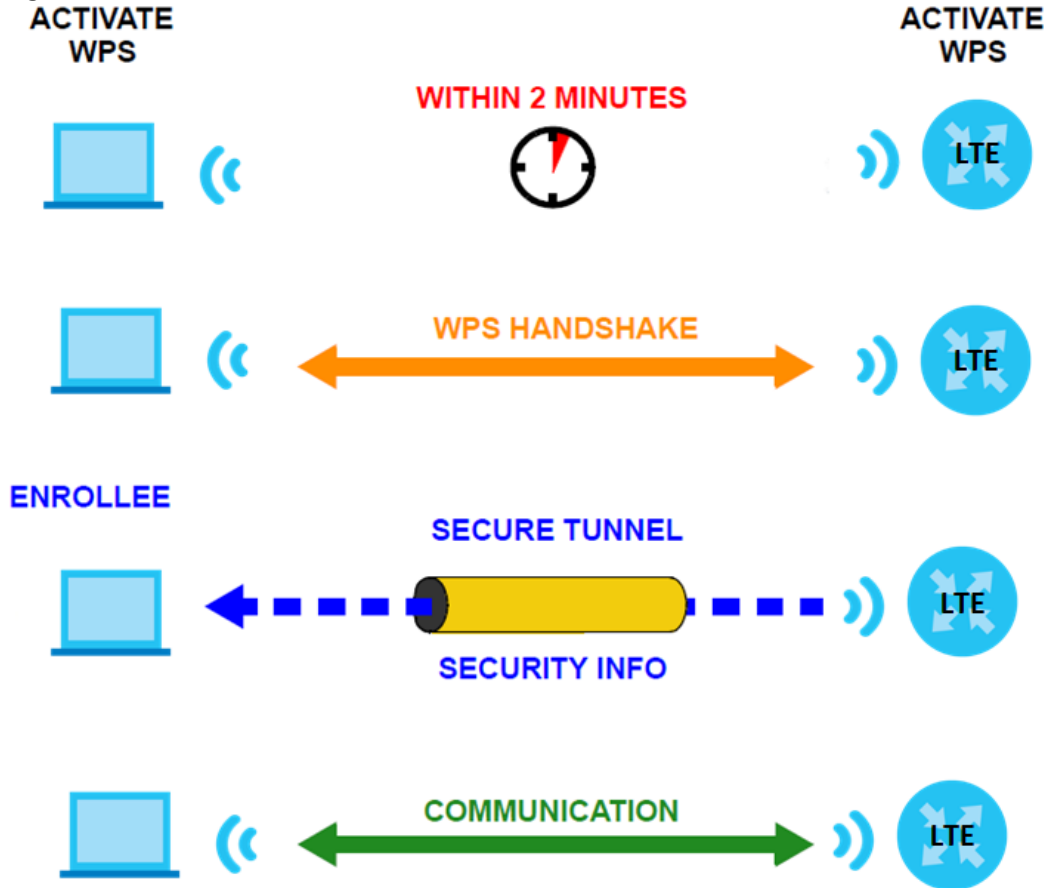

The roles of registrar and enrollee last only as long as the WPS setup process is active (two minutes). The next time you use WPS, a different device can be the registrar if necessary.

The WPS connection process is like a handshake; only two devices participate in each WPS transaction. If you want to add more devices you should repeat the process with one of the existing networked devices and the new device.

Note that the access point (AP) is not always the registrar, and the WiFi client is not always the enrollee. All WPS-certified APs can be a registrar, and so can some WPS-enabled WiFi clients.

By default, a WPS device is 'unconfigured'. This means that it is not part of an existing network and can act as either enrollee or registrar (if it supports both functions). If the registrar is unconfigured, the security settings it transmits to the enrollee are randomly-generated. Once a WPS-enabled device has connected to another device using WPS, it becomes 'configured'. A configured WiFi client can still act as enrollee or registrar in subsequent WPS connections, but a configured access point can no longer act as enrollee. It will be the registrar in all subsequent WPS connections in which it is involved. If you want a configured AP to act as an enrollee, you must reset it to its factory defaults.

#### 6.7.7.4 Example WPS Network Setup

This section shows how security settings are distributed in a sample WPS setup.

The following figure shows a sample network. In step 1, both **AP1** and **Client 1** are unconfigured. When WPS is activated on both, they perform the handshake. In this example, **AP1** is the registrar, and **Client 1**

is the enrollee. The registrar randomly generates the security information to set up the network, since it is unconfigured and has no existing information.

Figure 43 WPS: Example Network Step 1



In step 2, you add another WiFi client to the network. You know that **Client 1** supports registrar mode, but it is better to use **AP1** for the WPS handshake with the new client since you must connect to the access point anyway in order to use the network. In this case, **AP1** must be the registrar, since it is configured (it already has security information for the network). **AP1** supplies the existing security information to **Client 2**.

Figure 44 WPS: Example Network Step 2

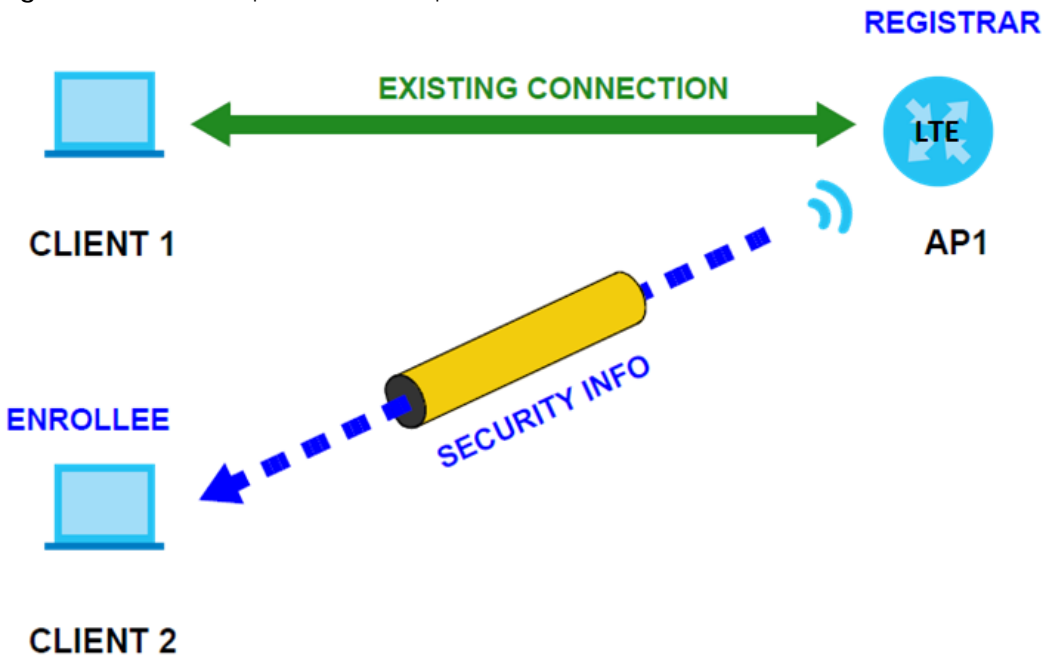

In step 3, you add another access point (**AP2**) to your network. **AP2** is out of range of **AP1**, so you cannot use **AP1** for the WPS handshake with the new access point. However, you know that **Client 2** supports the registrar function, so you use it to perform the WPS handshake instead.

Figure 45 WPS: Example Network Step 3

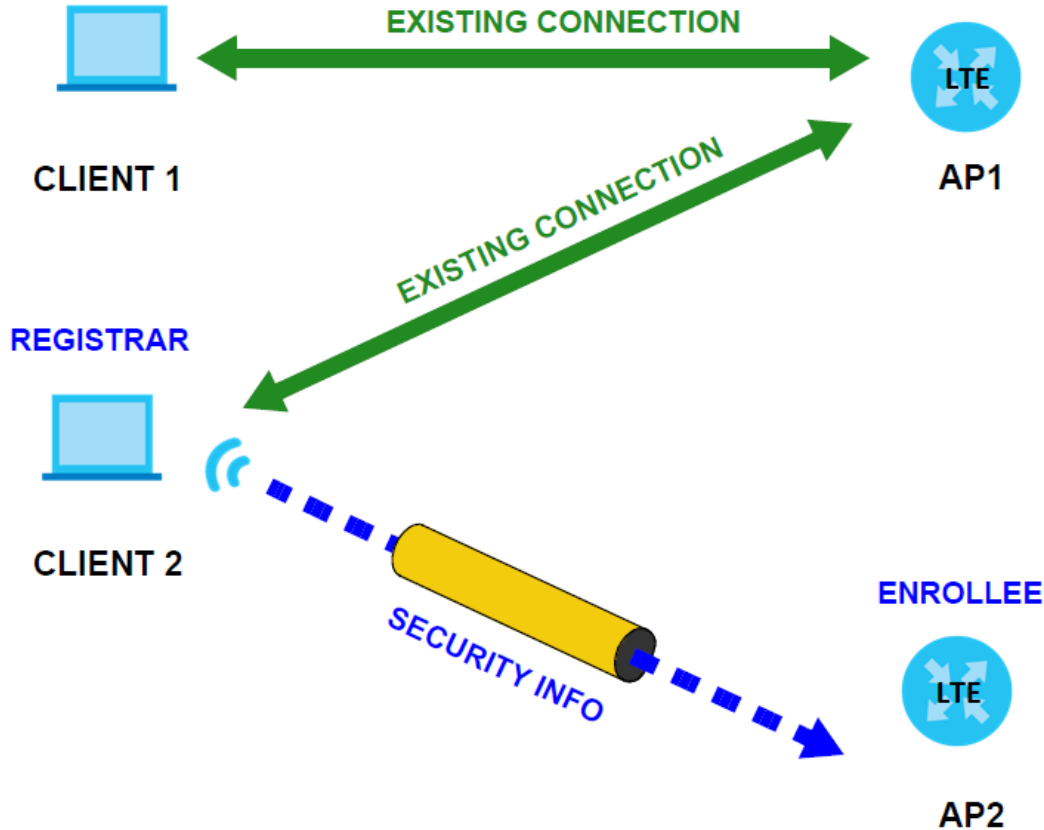

### 6.7.7.5 Limitations of WPS

WPS has some limitations of which you should be aware.

- When you use WPS, it works between two devices only. You cannot enroll multiple devices simultaneously, you must enroll one after the other.

For instance, if you have two enrollees and one registrar you must set up the first enrollee (by pressing the WPS button on the registrar and the first enrollee, for example), then check that it was successfully enrolled, then set up the second device in the same way.

- WPS works only with other WPS-enabled devices. However, you can still add non-WPS devices to a network you already set up using WPS.

WPS works by automatically issuing a randomly-generated WPA-PSK or WPA2-PSK pre-shared key from the registrar device to the enrollee devices. Whether the network uses WPA-PSK or WPA2-PSK depends on the device. You can check the configuration interface of the registrar device to discover the key the network is using (if the device supports this feature). Then, you can enter the key into the non-WPS device and join the network as normal (the non-WPS device must also support WPA-PSK or WPA2-PSK).

- When you use the PBC method, there is a short period (from the moment you press the button on one device to the moment you press the button on the other device) when any WPS-enabled device could join the network. This is because the registrar has no way of identifying the 'correct' enrollee, and cannot differentiate between your enrollee and a rogue device. This is a possible way for a hacker to gain access to a network.

You can easily check to see if this has happened. WPS only works simultaneously between two devices, so if another device has enrolled your device will be unable to enroll, and will not have access to the network. If this happens, open the access point's configuration interface and look at the list of associated clients (usually displayed by MAC address). It does not matter if the access point

is the WPS registrar, the enrollee, or was not involved in the WPS handshake; a rogue device must still associate with the access point to gain access to the network. Check the MAC addresses of your WiFi clients (usually printed on a label on the bottom of the device). If there is an unknown MAC address you can remove it or reset the AP.

# CHAPTER 7

## Home Networking

### 7.1 Overview

A Local Area Network (LAN) is a shared communication system to which many computers are attached. A LAN is usually located in one immediate area such as a building or floor of a building.

The LAN screens can help you configure a LAN DHCP server and manage IP addresses.

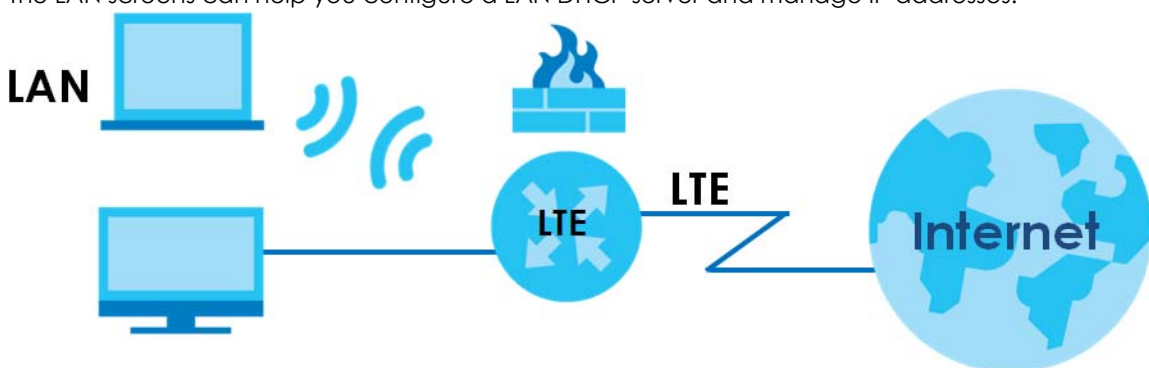

#### 7.1.1 What You Can Do in this Chapter

- Use the **LAN Setup** screen to set the LAN IP address, subnet mask, and DHCP settings ([Section 7.2 on page 71](#)).
- Use the **Static DHCP** screen to assign IP addresses on the LAN to specific individual computers based on their MAC addresses ([Section 7.3 on page 75](#)).
- Use the **UPnP** screen to enable UPnP ([Section 7.4 on page 77](#)).

#### 7.1.2 What You Need To Know

The following terms and concepts may help as you read this chapter.

##### 7.1.2.1 About LAN

###### IP Address

Similar to the way houses on a street share a common street name, so too do computers on a LAN share one common network number. This is known as an Internet Protocol address.

###### Subnet Mask

The subnet mask specifies the network number portion of an IP address. Your Zyxel Device will compute the subnet mask automatically based on the IP address that you entered. You don't need to change the subnet mask computed by the Zyxel Device unless you are instructed to do otherwise.

## DHCP

DHCP (Dynamic Host Configuration Protocol) allows clients to obtain TCP/IP configuration at start-up from a server. This Zyxel Device has a built-in DHCP server capability that assigns IP addresses and DNS servers to systems that support DHCP client capability.

## DNS

DNS (Domain Name System) maps a domain name to its corresponding IP address and vice versa. The DNS server is extremely important because without it, you must know the IP address of a computer before you can access it. The DNS server addresses you enter when you set up DHCP are passed to the client machines along with the assigned IP address and subnet mask.

### 7.1.2.2 About UPnP

#### How do I know if I'm using UPnP?

UPnP hardware is identified as an icon in the Network Connections folder (Windows 7). Each UPnP compatible device installed on your network will appear as a separate icon. Selecting the icon of a UPnP device will allow you to access the information and properties of that device.

#### Cautions with UPnP

The automated nature of NAT traversal applications in establishing their own services and opening firewall ports may present network security issues. Network information and configuration may also be obtained and modified by users in some network environments.

When a UPnP device joins a network, it announces its presence with a multicast message. For security reasons, the Zyxel Device allows multicast messages on the LAN only.

All UPnP-enabled devices may communicate freely with each other without additional configuration. Disable UPnP if this is not your intention.

#### UPnP and Zyxel

Zyxel has achieved UPnP certification from the Universal Plug and Play Forum UPnP™ Implementers Corp. (UIC). Zyxel's UPnP implementation supports Internet Gateway Device (IGD) 1.0.

See [Section 7.6 on page 79](#) for examples on installing and using UPnP.

## 7.2 LAN Setup

A LAN IP address is the IP address of a networking device in the LAN. You can use the Zyxel Device's LAN IP address to access its Web Configurator from the LAN. The DHCP server settings define the rules on assigning IP addresses to LAN clients on your network. Set the Local Area Network IP address and subnet mask of your Zyxel Device and configure the DNS server information that the Zyxel Device sends to the DHCP clients on the LAN in this screen. Click **Network Setting > Home Networking** to open the **LAN Setup** screen.

Figure 46 Network Setting &gt; Home Networking &gt; LAN Setup

The LAN IP address is the IP address you use to log into the web configurator. The DHCP server settings define the rules on how to assign IP addresses to the LAN clients on your network.

**Interface Group**  
Group Name:

**LAN IP Setup**  
IP Address:      
Subnet Mask:

**DHCP Server State**  
DHCP:  Enable  Disable  DHCP Relay

**IP Addressing Values**  
Beginning IP Address:      
Ending IP Address:      
Auto reserve IP for the same host:

**DHCP Server Lease Time**  
 days  hours  minutes

**DNS Values**  
DNS:  DNS Proxy  Static  From ISP

**LAN IPv6 Mode Setup**  
IPv6 Active:

**Link Local Address Type**  
 EUI64  
 Manual

**LAN Global Identifier Type**  
 EUI64  
 Manual

**LAN IPv6 Prefix Setup**  
 Delegate prefix from WAN   
 Static

**LAN IPv6 Address Assign Setup**

**LAN IPv6 DNS Assign Setup**

**DHCPv6 Configuration**  
DHCPv6 Active:  DHCPv6 Server:

**IPv6 Router Advertisement State**  
RA/DVD Active:  Enable:

**IPv6 DNS Values**  
IPv6 DNS Server 1:    
IPv6 DNS Server 2:    
IPv6 DNS Server 3:

**DNS Query Scenario**



The following table describes the fields in this screen.

Table 24 Network Setting > Home Networking > LAN Setup

| LABEL                             | DESCRIPTION   |
|-----------------------------------|---|
| Interface Group                   |   |
| Group Name                        | This displays the name of the group that your Zyxel Device belongs to.  |
| LAN IP Setup                      |   |
| IP Address                        | Enter the LAN IP address you want to assign to your Zyxel Device in dotted decimal notation, for example, 192.168.1.1 (factory default).  |
| Subnet Mask                       | Type the subnet mask of your network in dotted decimal notation, for example 255.255.255.0 (factory default). Your Zyxel Device automatically computes the subnet mask based on the IP address you enter, so do not change this field unless you are instructed to do so.   |
| DHCP Server State                 |   |
| DHCP                              | <p>Select <b>Enable</b> to have your Zyxel Device assign IP addresses, an IP default gateway and DNS servers to LAN computers and other devices that are DHCP clients.</p> <p>If you select <b>Disable</b>, you need to manually configure the IP addresses of the computers and other devices on your LAN.</p> <p>If you select <b>DHCP Relay</b>, the Zyxel Device acts as a surrogate DHCP server and relays DHCP requests and responses between the remote server and the clients.</p> <p>When DHCP is used, the following fields need to be set:</p>   |
| IP Addressing Values              |   |
| Beginning IP Address              | This field specifies the first of the contiguous addresses in the IP address pool.  |
| Ending IP Address                 | This field specifies the last of the contiguous addresses in the IP address pool.   |
| Auto reserve IP for the same host | Enable this if you want to reserve the IP address for the same host.  |
| DHCP Server Lease Time            |   |
| Days/Hours/Minutes                | DHCP server leases an address to a new device for a period of time, called the DHCP lease time. When the lease expires, the DHCP server might assign the IP address to a different device.  |
| DNS Values                        |   |
| DNS                               | <p>The Zyxel Device supports DNS proxy by default. The Zyxel Device sends out its own LAN IP address to the DHCP clients as the first DNS server address. DHCP clients use this first DNS server to send domain-name queries to the Zyxel Device. The Zyxel Device sends a response directly if it has a record of the domain-name to IP address mapping. If it does not, the Zyxel Device queries an outside DNS server and relays the response to the DHCP client.</p> <p>Select <b>From ISP</b> if your ISP dynamically assigns DNS server information (and the Zyxel Device's WAN IP address).</p> <p>Select <b>Static</b> if you have the IP address of a DNS server. Enter the DNS server's IP address in the field to the right.</p> <p>Select <b>DNS Proxy</b> to have the DHCP clients use the Zyxel Device's own LAN IP address. The Zyxel Device works as a DNS relay.</p> |
| LAN IPv6 Mode Setup               |   |
| IPv6 Active                       | <p>Use this field to <b>Enable</b> or <b>Disable</b> IPv6 activation on the Zyxel Device.</p> <p>When IPv6 activation is used, the following fields need to be set:</p>   |

Table 24 Network Setting &gt; Home Networking &gt; LAN Setup (continued)

| LABEL                           | DESCRIPTION   |              |   |              |         |         |         |
|---------------------------------|---|--------------|---|--------------|---------|---------|---------|
| Link Local Address Type         | <p>A link-local address uniquely identifies a device on the local network (the LAN). It is similar to a "private IP address" in IPv6. You can have the same link-local address on multiple interfaces on a device. A link-local unicast address has a predefined prefix of fe80::/10. The link-local unicast address format is as follows. Select <b>EUI64</b> to allow the Zyxel Device to generate an interface ID for the LAN interface's link-local address using the EUI-64 format. Otherwise, enter an interface ID for the LAN interface's link-local address if you select <b>Manual</b>.</p> <p>Link-local Unicast Address Format</p> <table border="1" data-bbox="532 491 1060 564"> <tr> <td data-bbox="532 491 732 527">1111 1110 10</td> <td data-bbox="732 491 862 527">0</td> <td data-bbox="862 491 1060 527">Interface ID</td> </tr> <tr> <td data-bbox="532 527 732 564">10 bits</td> <td data-bbox="732 527 862 564">54 bits</td> <td data-bbox="862 527 1060 564">64 bits</td> </tr> </table> | 1111 1110 10 | 0 | Interface ID | 10 bits | 54 bits | 64 bits |
| 1111 1110 10                    | 0   | Interface ID |   |              |         |         |         |
| 10 bits                         | 54 bits   | 64 bits      |   |              |         |         |         |
| LAN Global Identifier Type      | Select <b>EUI64</b> to have the Zyxel Device generate an interface ID using the EUI-64 format for its global address. Select <b>Manual</b> to manually enter an interface ID for the LAN interface's global IPv6 address.   |              |   |              |         |         |         |
| LAN IPv6 Prefix Setup           | Select <b>Delegate prefix from WAN</b> to automatically obtain an IPv6 network prefix from the service provider or an uplink router. Select <b>Static</b> to configure a fixed IPv6 address for the Zyxel Device's LAN IPv6 address.  |              |   |              |         |         |         |
| LAN IPv6 Address Assign Setup   | <p>Select how you want to obtain an IPv6 address:</p> <p><b>Stateless:</b> The Zyxel Device uses IPv6 stateless autoconfiguration. RADVD (Router Advertisement Daemon) is enabled to have the Zyxel Device send IPv6 prefix information in router advertisements periodically and in response to router solicitations. DHCPv6 server is disabled.</p> <p><b>Stateful:</b> The Zyxel Device uses IPv6 stateful autoconfiguration. The DHCPv6 server is enabled to have the Zyxel Device act as a DHCPv6 server and pass IPv6 addresses to DHCPv6 clients.</p>  |              |   |              |         |         |         |
| LAN IPv6 DNS Assign Setup       | <p>Select how the Zyxel Device provide DNS server and domain name information to the clients:</p> <p><b>From Router Advertisement:</b> The Zyxel Device provides DNS information through router advertisements.</p> <p><b>From DHCPv6 Server:</b> The Zyxel Device provides DNS information through DHCPv6.</p> <p><b>From RA &amp; DHCPv6 Server:</b> The Zyxel Device provides DNS information through both router advertisements and DHCPv6.</p>   |              |   |              |         |         |         |
| DHCPv6 Configuration            | <b>DHCPv6 Active</b> shows the status of the DHCPv6. <b>DHCPv6 Server</b> displays if you configured the Zyxel Device to act as a DHCPv6 server which assigns IPv6 addresses and/or DNS information to clients.   |              |   |              |         |         |         |
| IPv6 Router Advertisement State | <b>RADVD Active</b> shows whether RADVD is enabled or not.  |              |   |              |         |         |         |
| IPv6 DNS Values                 |   |              |   |              |         |         |         |
| IPv6 DNS Server 1~3             | <p>Specify the IP addresses up to three DNS servers for the DHCP clients to use. Use one of the following ways to specify these IP addresses.</p> <p><b>User Defined</b> - Select this if you have the IPv6 address of a DNS server. Enter the DNS server IPv6 addresses the Zyxel Device passes to the DHCP clients.</p> <p><b>From ISP</b> - Select this if your ISP dynamically assigns IPv6 DNS server information.</p> <p><b>Proxy</b> - Select this if the DHCP clients use the IP address of this interface and the Zyxel Device works as a DNS relay.</p> <p>Otherwise, select <b>None</b> if you do not want to configure IPv6 DNS servers.</p>  |              |   |              |         |         |         |

Table 24 Network Setting &gt; Home Networking &gt; LAN Setup (continued)

| LABEL              | DESCRIPTION   |
|--------------------|---|
| DNS Query Scenario | <p>Select how the Zyxel Device handles clients' DNS information requests.</p> <p><b>IPv4/IPv6 DNS Server:</b> The Zyxel Device forwards the requests to both the IPv4 and IPv6 DNS servers and sends clients the first DNS information it receives.</p> <p><b>IPv6 DNS Server Only:</b> The Zyxel Device forwards the requests to the IPv6 DNS server and sends clients the DNS information it receives.</p> <p><b>IPv4 DNS Server Only:</b> The Zyxel Device forwards the requests to the IPv4 DNS server and sends clients the DNS information it receives.</p> <p><b>IPv6 DNS Server First:</b> The Zyxel Device forwards the requests to the IPv6 DNS server first and then the IPv4 DNS server. Then it sends clients the first DNS information it receives.</p> <p><b>IPv4 DNS Server First:</b> The Zyxel Device forwards the requests to the IPv4 DNS server first and then the IPv6 DNS server. Then it sends clients the first DNS information it receives.</p> |
| Apply              | Click <b>Apply</b> to save your changes.  |
| Cancel             | Click <b>Cancel</b> to restore your previously saved settings.  |

## 7.3 Static DHCP

When any of the LAN clients in your network want an assigned fixed IP address, add a static lease for each LAN client. Knowing the LAN client's MAC addresses is necessary. Assign IP addresses on the LAN to specific individual computers based on their MAC addresses.

Every Ethernet device has a unique MAC (Media Access Control) address. The MAC address is assigned at the factory and consists of six pairs of hexadecimal characters, for example, 00:A0:C5:00:00:02.

### 7.3.1 Before You Begin

Find out the MAC addresses of your network devices if you intend to add them to the **Static DHCP** screen.

Use this screen to change your Zyxel Device's static DHCP settings. Click **Network Setting > Home Networking > Static DHCP** to open the following screen.

**Figure 47** Network Setting > Home Networking > Static DHCP

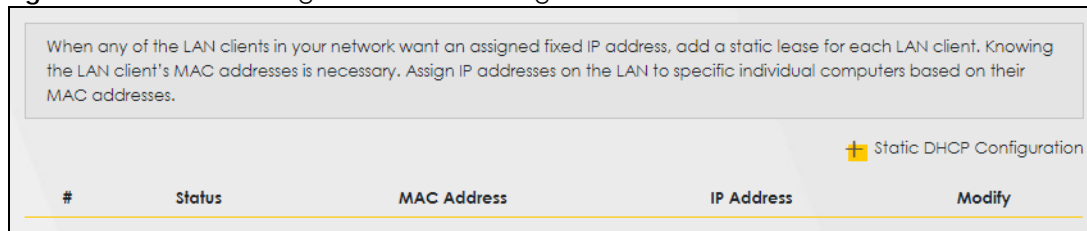

The following table describes the labels in this screen.

Table 25 Network Setting > Home Networking > Static DHCP

| LABEL                     | DESCRIPTION  |
|---------------------------|--|
| Static DHCP Configuration | Click this to configure a static DHCP entry.   |
| #                         | This is the index number of the entry.   |
| Status                    | Active   |
| MAC Address               | The MAC (Media Access Control) or Ethernet address on a LAN (Local Area Network) is unique to your computer (six pairs of hexadecimal notation).<br><br>A network interface card such as an Ethernet adapter has a hardwired address that is assigned at the factory. This address follows an industry standard that ensures no other adapter has a similar address. |
| IP Address                | This field displays the IP address relative to the # field listed above.   |
| Modify                    | Click the <b>Edit</b> icon to configure the connection.  |

If you click **Static DHCP Configuration** in the **Static DHCP** screen, the following screen displays.

Figure 48 Static DHCP: Static DHCP Configuration

The following table describes the labels in this screen.

Table 26 Static DHCP: Configuration

| LABEL              | DESCRIPTION   |
|--------------------|---|
| Active             | Enable static DHCP in your Zyxel Device.  |
| Group Name         | This displays the <b>Group Name</b> , usually <b>Default</b> .  |
| IP Type            | The <b>IP Type</b> is normally <b>IPv4</b> (non-configurable).  |
| Select Device Info | Select between <b>Manual Input</b> which allows you to enter the next two fields ( <b>MAC Address</b> and <b>IP Address</b> ); or selecting an existing device would show its MAC address and IP address. |
| MAC Address        | Enter the MAC address of a computer on your LAN if you select <b>Manual Input</b> in the previous field.  |
| IP Address         | Enter the IP address that you want to assign to the computer on your LAN with the MAC address that you will also specify if you select <b>Manual Input</b> in the previous field.                         |
| OK                 | Click <b>OK</b> to save your changes.   |
| Cancel             | Click <b>Cancel</b> to exit this screen without saving.   |

## 7.4 UPnP

Universal Plug and Play (UPnP) is a distributed, open networking standard that uses TCP/IP for simple peer-to-peer network connectivity between networking devices and software that also have UPnP enabled. A UPnP device can dynamically join a network, obtain an IP address, convey its capabilities and learn about other devices on the network. A device can leave a network smoothly and automatically when it is no longer in use.

See [Section 7.6 on page 79](#) for more information on UPnP.

Use the following screen to configure the UPnP settings on your Zyxel Device. Click **Network Setting > Home Networking > UPnP** to display the screen shown next.

**Figure 49** Network Setting > Home Networking > UPnP

Universal Plug and Play (UPnP) is a distributed, open networking standard that uses TCP/IP for simple peer-to-peer network connectivity between networking devices and software that also have UPnP enabled. A UPnP device can dynamically join a network, obtain an IP address, convey its capabilities and learn about other devices on the network. A device can leave a network smoothly and automatically when it is no longer in use.

**UPnP State**

UPnP

**UPnP NAT-T State**

UPnP NAT-T

Note

UPnP NAT-T only works when NAT is enable

| # | Description | Destination IP Address | External Port | Internal Port | Protocol |
|---|-------------|------------------------|---------------|---------------|----------|
|---|-------------|------------------------|---------------|---------------|----------|

Cancel Apply

The following table describes the labels in this screen.

**Table 27** Network Settings > Home Networking > UPnP

| LABEL                  | DESCRIPTION   |
|------------------------|---|
| UPnP State             |   |
| UPnP                   | Select <b>Enable</b> to activate UPnP. Be aware that anyone could use a UPnP application to open the Web Configurator's login screen without entering the Zyxel Device's IP address (although you must still enter the password to access the Web Configurator).  |
| UPnP NAT-T State       |   |
| UPnP NAT-T             | Select <b>Enable</b> to activate UPnP with NAT enabled. UPnP NAT traversal automates the process of allowing an application to operate through NAT. UPnP network devices can automatically configure network addressing, announce their presence in the network to other UPnP devices and enable exchange of simple product and service descriptions. |
| #                      | This field displays the index number of the entry.  |
| Description            | This field displays the description of the UPnP NAT-T connection.   |
| Destination IP Address | This field displays the IP address of the other connected UPnP-enabled device.  |
| External Port          | This field displays the external port number that identifies the service.   |

Table 27 Network Settings &gt; Home Networking &gt; UPnP

| LABEL         | DESCRIPTION   |
|---------------|---|
| Internal Port | This field displays the internal port number that identifies the service. |
| Protocol      | This field displays the protocol of the NAT mapping rule (TCP or UDP).    |
| Apply         | Click <b>Apply</b> to save your changes.                                  |
| Cancel        | Click <b>Cancel</b> to restore your previously saved settings.            |

## 7.5 Technical Reference

This section provides some technical background information about the topics covered in this chapter.

### LANs, WANs and the Zyxel Device

The actual physical connection determines whether the Zyxel Device ports are LAN or WAN ports. There are two separate IP networks, one inside the LAN network and the other outside the WAN network as shown next.

Figure 50 LAN and WAN IP Addresses

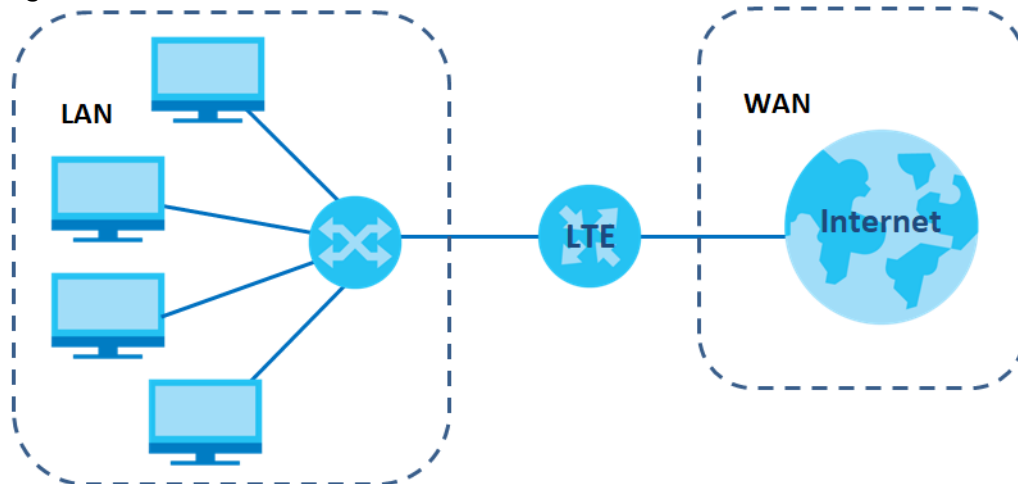

### Private IP Addresses

Every machine on the Internet must have a unique address. If your networks are isolated from the Internet, for example, only between your two branch offices, you can assign any IP addresses to the hosts without problems. However, the Internet Assigned Numbers Authority (IANA) has reserved the following three blocks of IP addresses specifically for private networks:

- 10.0.0.0 — 10.255.255.255
- 172.16.0.0 — 172.31.255.255
- 192.168.0.0 — 192.168.255.255

You can obtain your IP address from the IANA, from an ISP or it can be assigned from a private network. If you belong to a small organization and your Internet access is through an ISP, the ISP can provide you

with the Internet addresses for your local networks. On the other hand, if you are part of a much larger organization, you should consult your network administrator for the appropriate IP addresses.

Note: Regardless of your particular situation, do not create an arbitrary IP address; always follow the guidelines above. For more information on address assignment, please refer to RFC 1597, "Address Allocation for Private Internets" and RFC 1466, "Guidelines for Management of IP Address Space."

## 7.6 Turn on UPnP in Windows 7 Example

This section shows you how to use the UPnP feature in Windows 7. UPnP server is installed in Windows 7. Activate UPnP on the Zyxel Device by clicking **Network Setting > Home Networking > UPnP**.

Make sure the computer is connected to the LAN port of the Zyxel Device. Turn on your computer and the Zyxel Device.

- 1 Click the start icon, **Control Panel** and then the **Network and Sharing Center**.

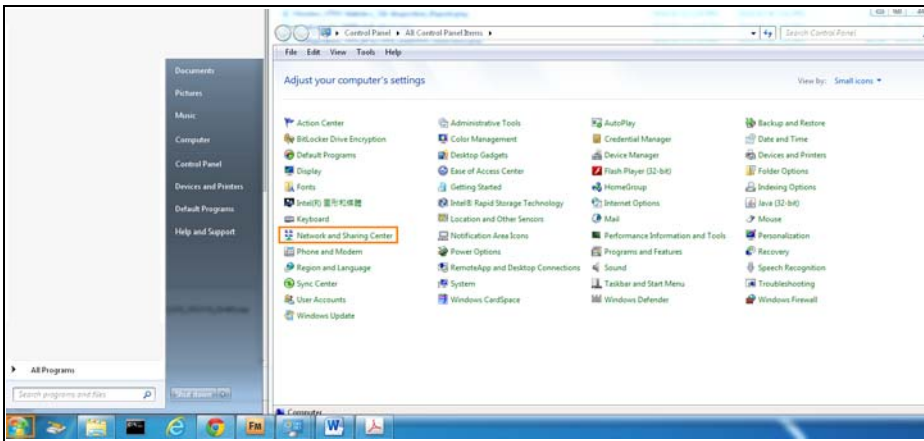

- 2 Click **Change Advanced Sharing Settings**.

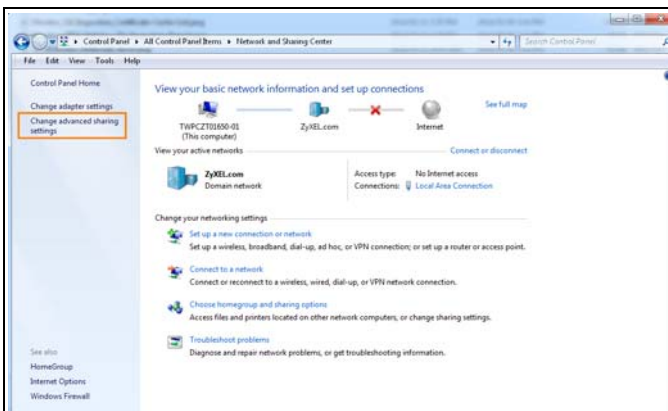

- 3 Select **Turn on network discovery** and click **Save Changes**. Network discovery allows your computer to find other computers and devices on the network and other computers on the network to find your computer. This makes it easier to share files and printers.

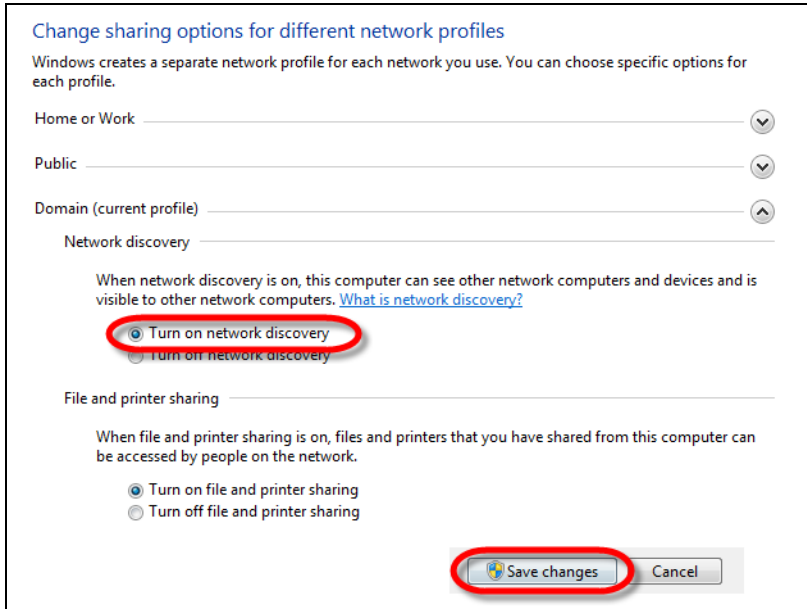

## 7.6.1 Auto-discover Your UPnP-enabled Network Device

Before you follow these steps, make sure you already have UPnP activated on the Zyxel Device and in your computer.

Make sure your computer is connected to the LAN port of the Zyxel Device.

- 1 Open **Windows Explorer** and click **Network**.
- 2 Right-click the Zyxel Device icon and select **Properties**.

**Figure 51** Network Connections

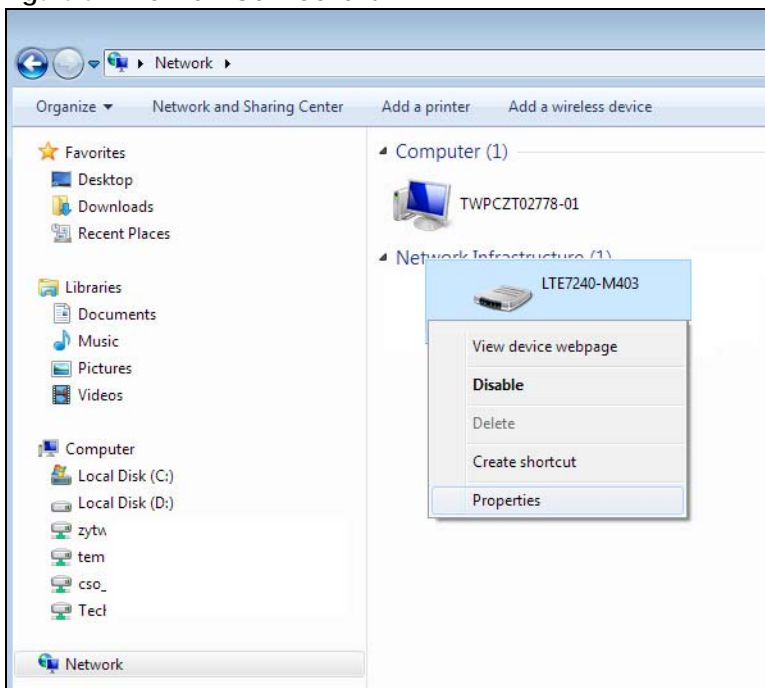



- 3 In the **Internet Connection Properties** window, click **Settings** to see port mappings.

**Figure 52** Internet Connection Properties

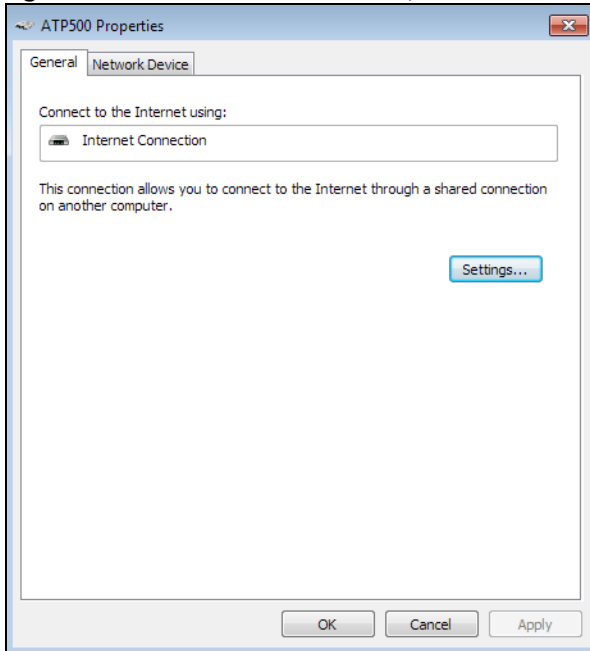

- 4 You may edit or delete the port mappings or click **Add** to manually add port mappings.

**Figure 53** Internet Connection Properties: Advanced Settings

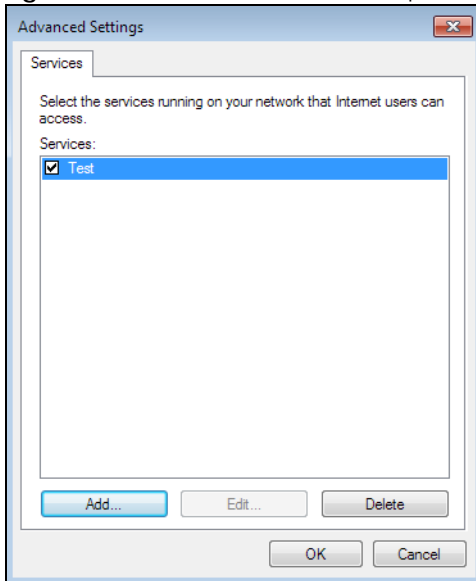

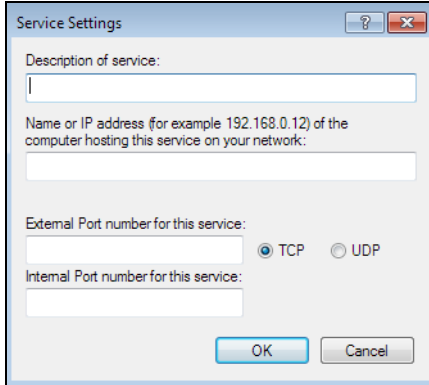
**Figure 54** Internet Connection Properties: Advanced Settings: Add

Note: When the UPnP-enabled device is disconnected from your computer, all port mappings will be deleted automatically.

- 5 Click **OK**. Check the network icon on the system tray to see your Internet connection status.

**Figure 55** System Tray Icon

- 6 To see more details about your current Internet connection status, right click the network icon in the system tray and click **Open Network and Sharing Center**. Click **Local Area Network**.

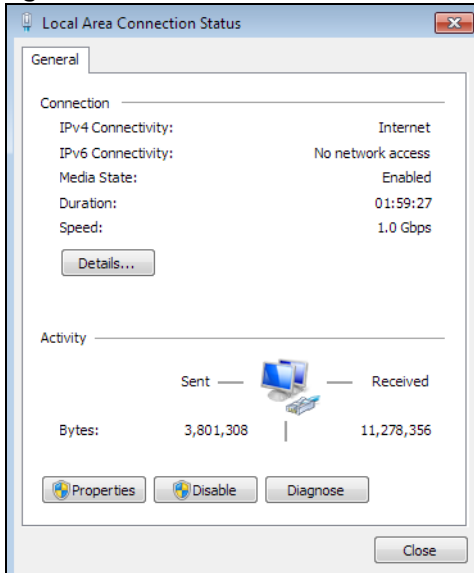
**Figure 56** Internet Connection Status

## 7.7 Turn on UPnP in Windows 10 Example

This section shows you how to use the UPnP feature in Windows 10. UPnP server is installed in Windows 10. Activate UPnP on the Zyxel Device by clicking **Network Setting > Home Networking > UPnP**.

Make sure the computer is connected to the LAN port of the Zyxel Device. Turn on your computer and the Zyxel Device.

- 1 Click the start icon, **Settings** and then **Network & Internet**.

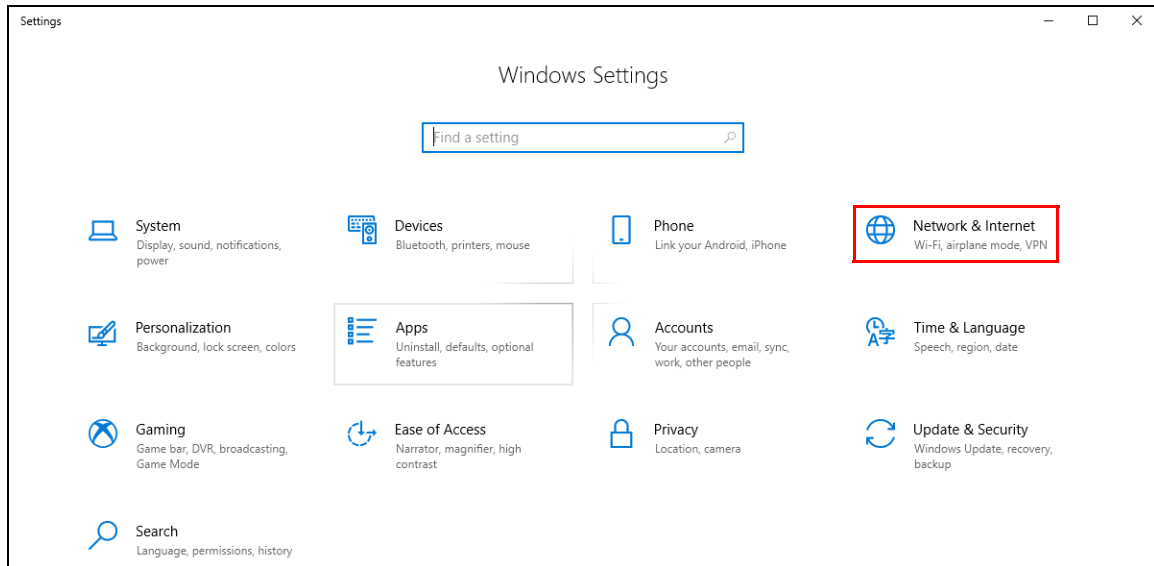

- 2 Click **Network and Sharing Center**.

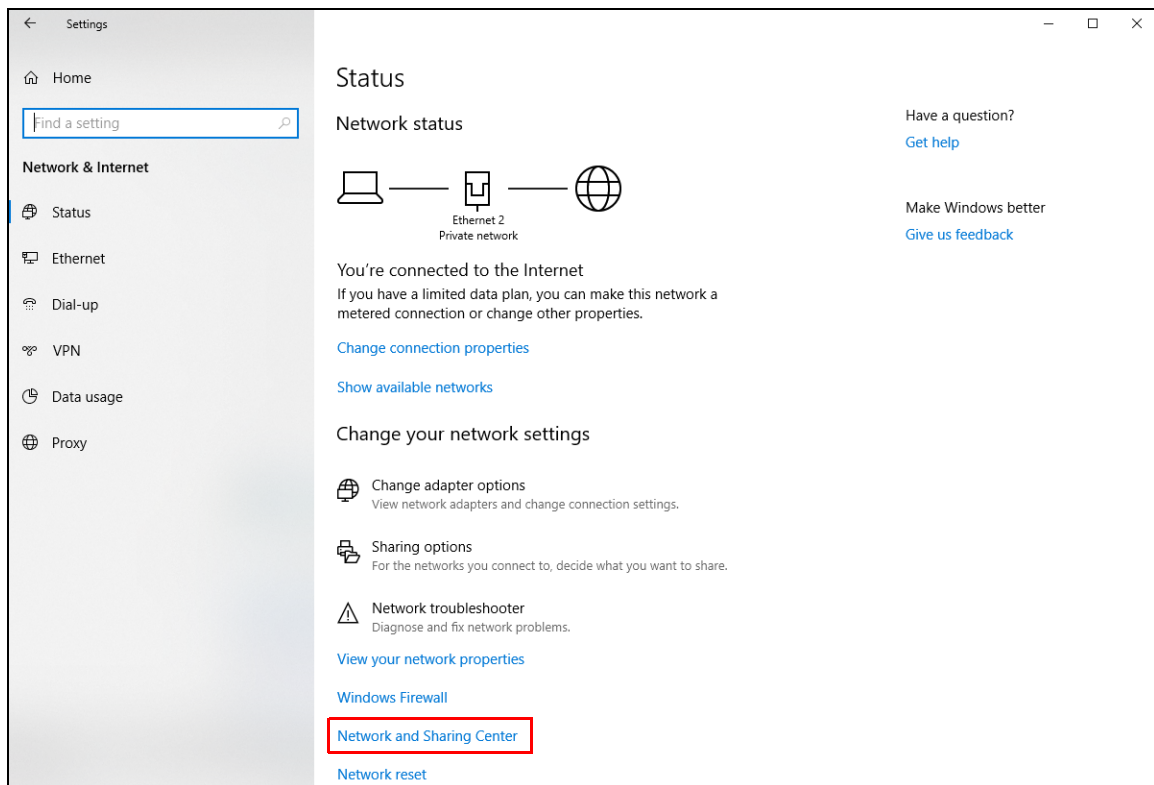

- 3 Click **Change advanced sharing settings**.

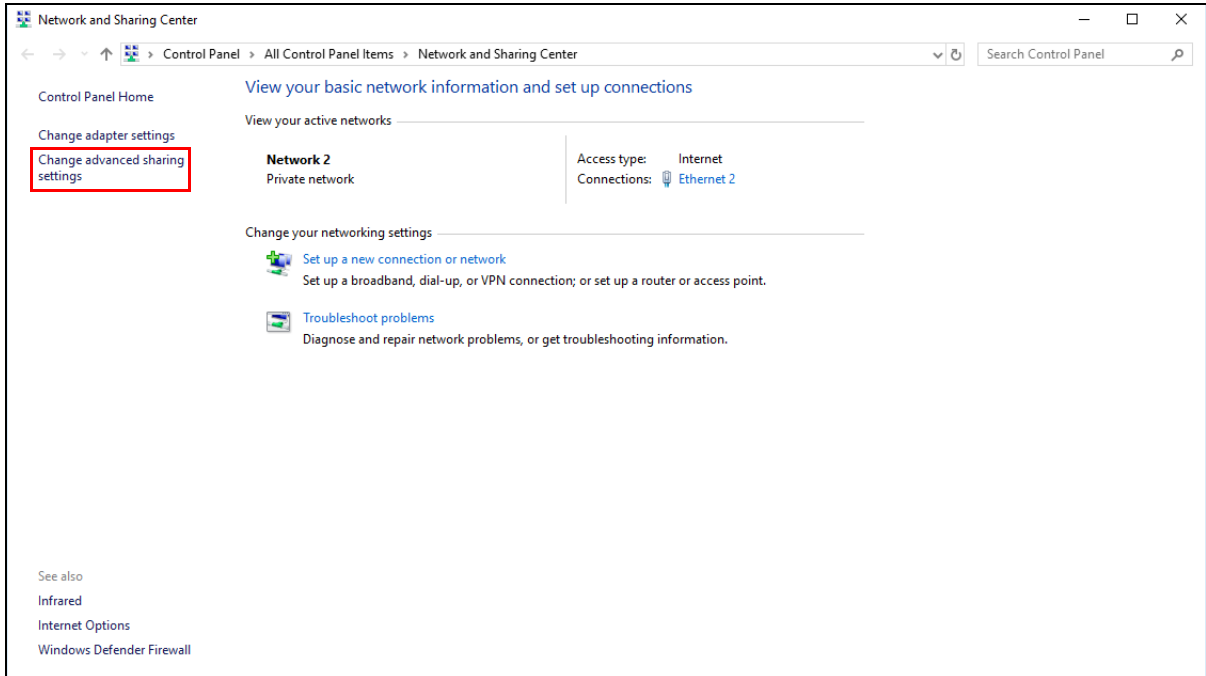

- 4 Under **Domain**, select **Turn on network discovery** and click **Save Changes**. Network discovery allows your computer to find other computers and devices on the network and other computers on the network to find your computer. This makes it easier to share files and printers.

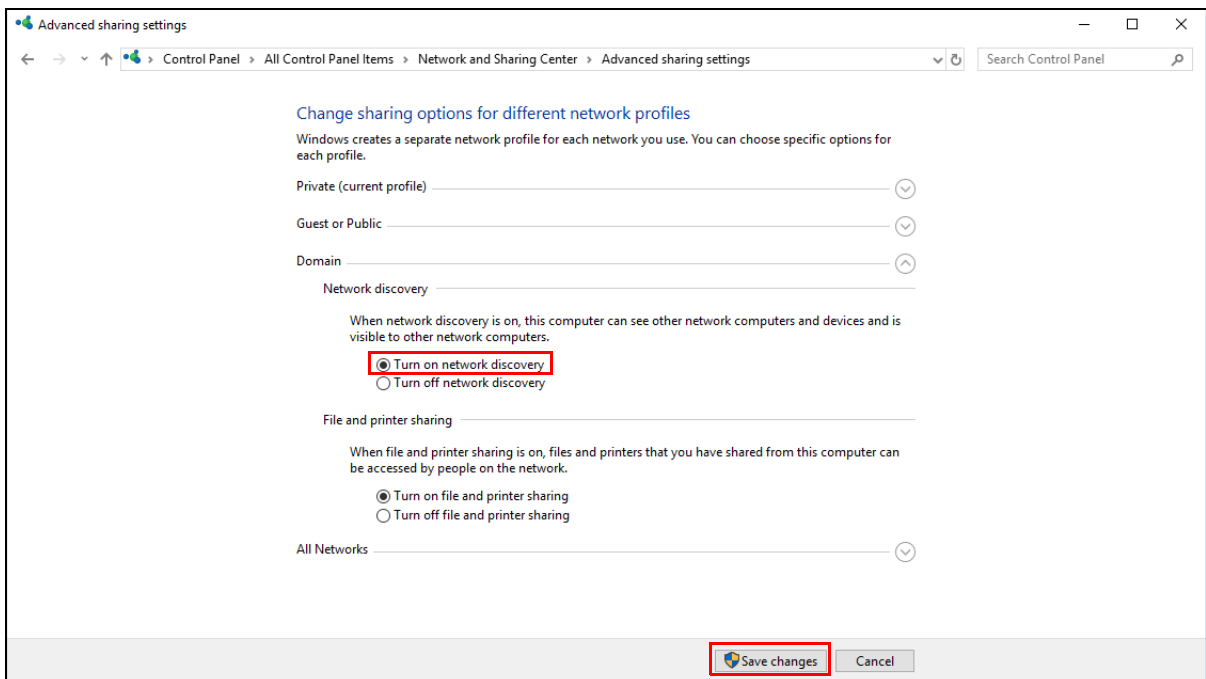

### 7.7.1 Auto-discover Your UPnP-enabled Network Device

Before you follow these steps, make sure you already have UPnP activated on the Zyxel Device and in your computer.

Make sure your computer is connected to the LAN port of the Zyxel Device.

- 1 Open **File Explorer** and click **Network**.
- 2 Right-click the Zyxel Device icon and select **Properties**.

**Figure 57** Network Connections

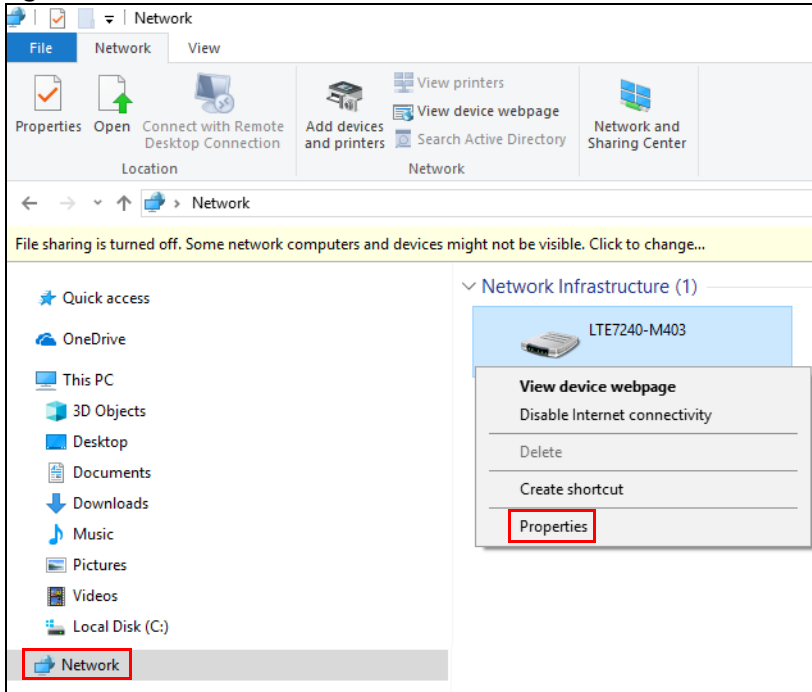

- 3 In the **Internet Connection Properties** window, click **Settings** to see port mappings.

**Figure 58** Internet Connection Properties

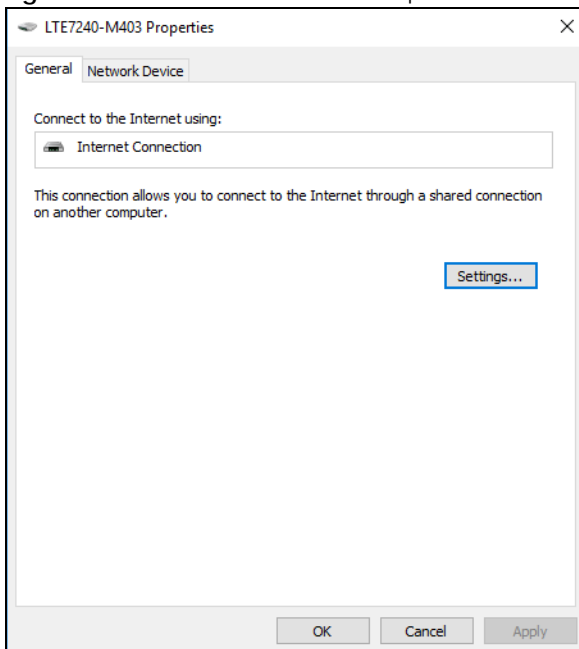

- 4 You may edit or delete the port mappings or click **Add** to manually add port mappings.

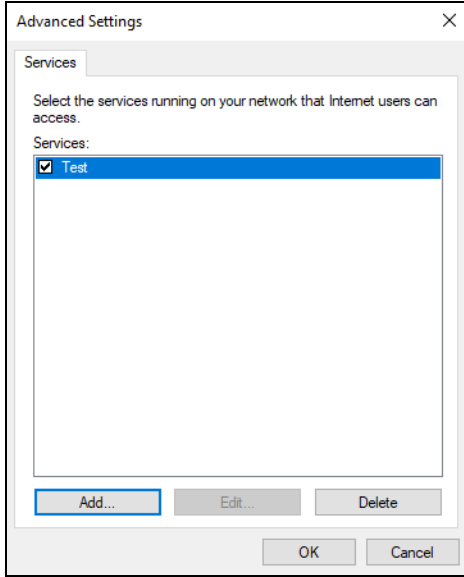
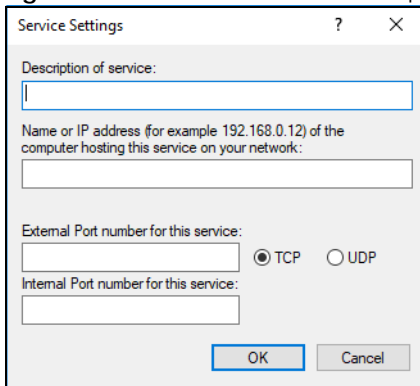
**Figure 59** Internet Connection Properties: Advanced Settings**Figure 60** Internet Connection Properties: Advanced Settings: Add

Note: When the UPnP-enabled device is disconnected from your computer, all port mappings will be deleted automatically.

- 5 Click **OK**. Check the network icon on the system tray to see your Internet connection status.

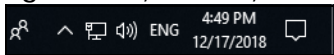
**Figure 61** System Tray Icon

- 6 To see more details about your current Internet connection status, right click the network icon in the system tray and click **Open Network & Internet settings**. Click **Network and Sharing Center** and click the **Connections**.

Figure 62 Internet Connection Status

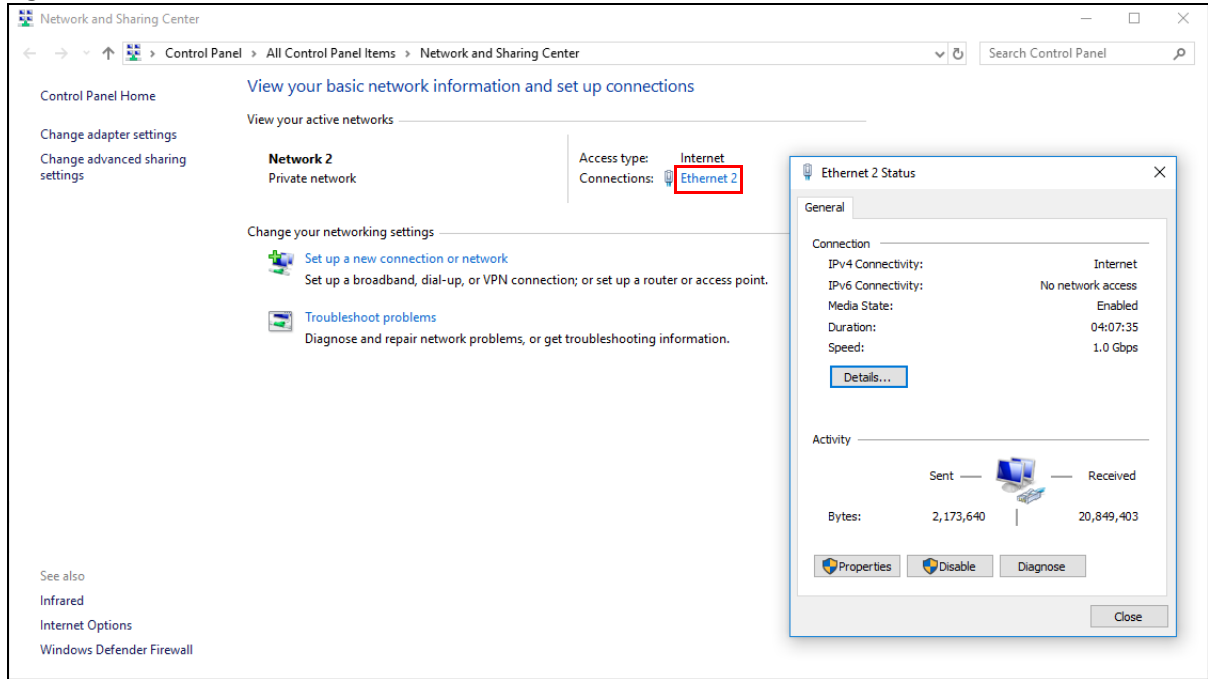

## 7.8 Web Configurator Easy Access in Windows 7

With UPnP, you can access the Web-based Configurator on the Zyxel Device without needing to find out the IP address of the Zyxel Device first. This comes helpful if you do not know the IP address of the Zyxel Device.

Follow the steps below to access the Web Configurator.

- 1 Open **Windows Explorer**.
- 2 Click **Network**.

Figure 63 Network Connections

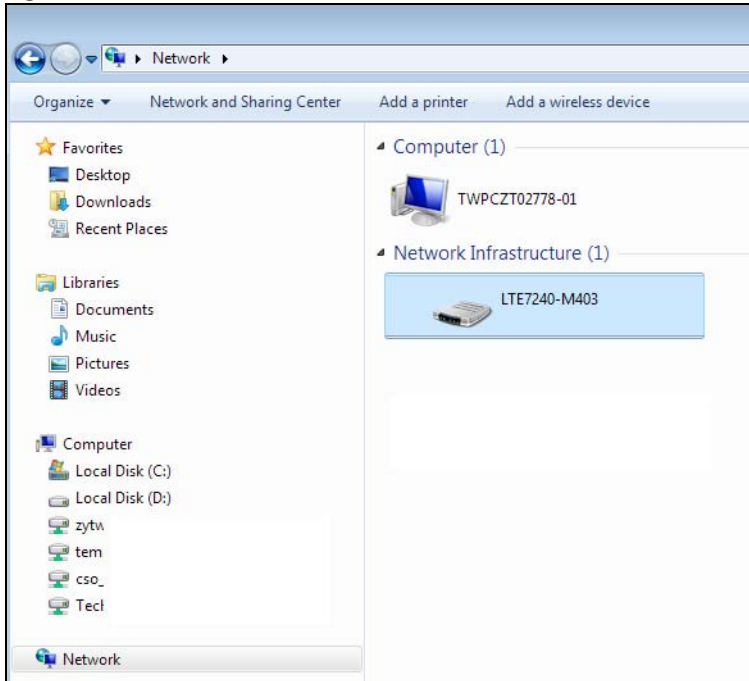

- 3 An icon with the description for each UPnP-enabled device displays under **Network Infrastructure**.
- 4 Right-click the icon for your Zyxel Device and select **View device webpage**. The Web Configurator login screen displays.

Figure 64 Network Connections: My Network Places

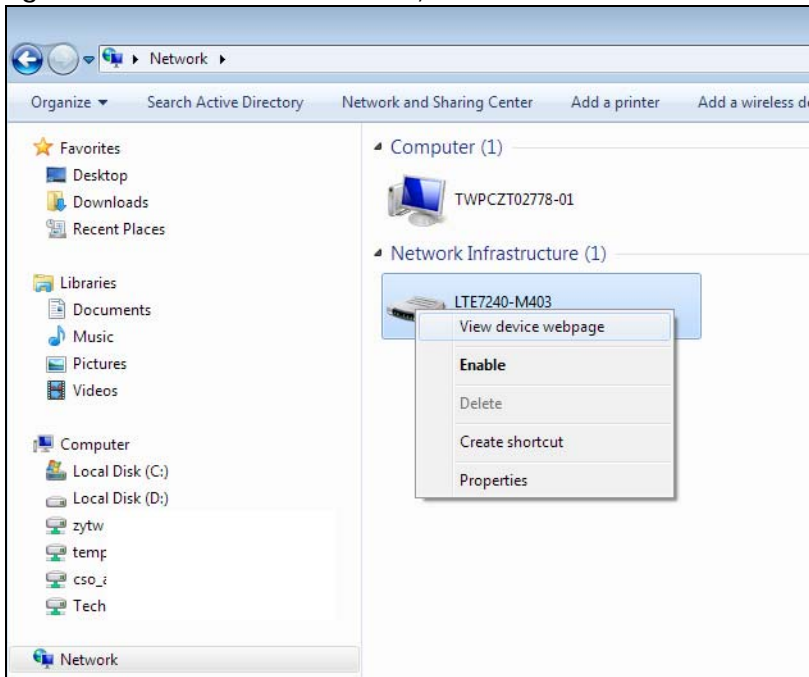

- 5 Right-click the icon for your Zyxel Device and select **Properties**. Click the **Network Device** tab. A window displays with information about the Zyxel Device.

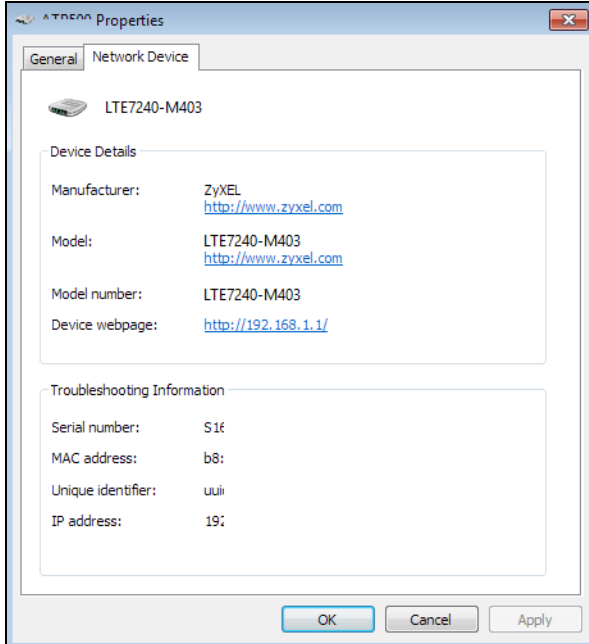

**Figure 65** Network Connections: My Network Places: Properties: Example

## 7.9 Web Configurator Easy Access in Windows 10

Follow the steps below to access the Web Configurator.

- 1 Open **File Explorer**.
- 2 Click **Network**.

Figure 66 Network Connections

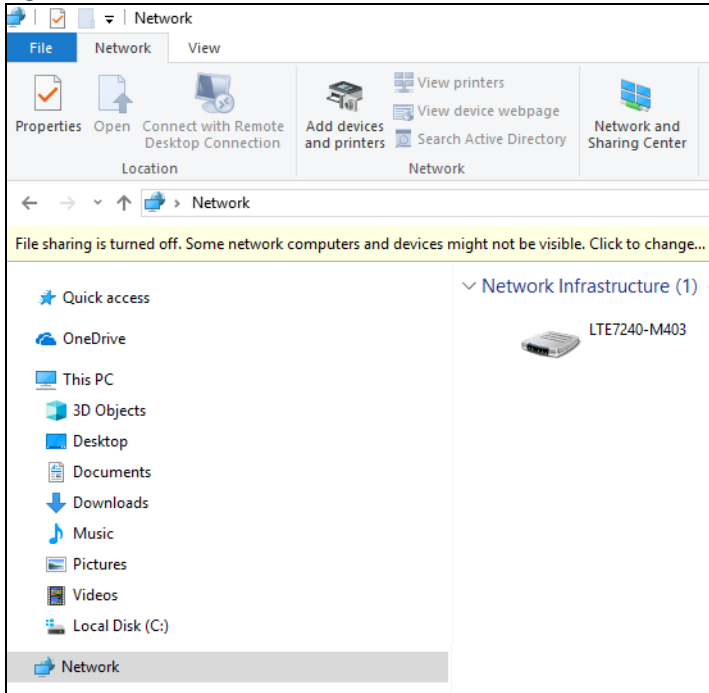

- 3 An icon with the description for each UPnP-enabled device displays under **Network Infrastructure**.
- 4 Right-click the icon for your Zyxel Device and select **View device webpage**. The Web Configurator login screen displays.

Figure 67 Network Connections: Network Infrastructure

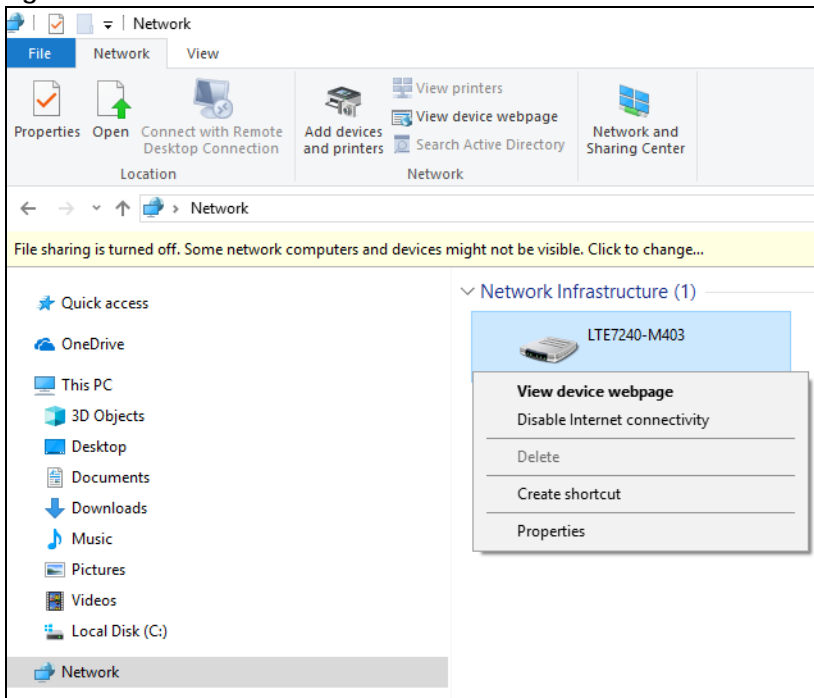

- 5 Right-click the icon for your Zyxel Device and select **Properties**. Click the **Network Device** tab. A window displays information about the Zyxel Device.

**Figure 68** Network Connections: Network Infrastructure: Properties: Example

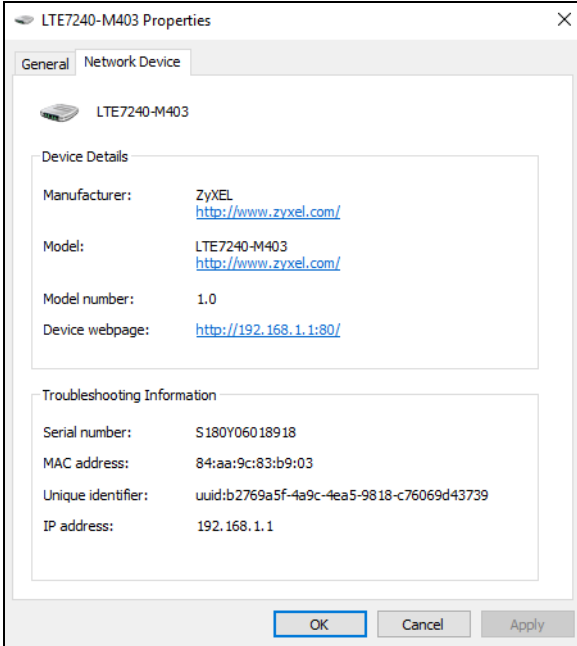

# CHAPTER 8

## Routing

### 8.1 Overview

The Zyxel Device usually uses the default gateway to route outbound traffic from computers on the LAN to the Internet. To have the Zyxel Device send data to devices not reachable through the default gateway, use static routes.

For example, the next figure shows a computer (**A**) connected to the Zyxel Device's LAN interface. The Zyxel Device routes most traffic from **A** to the Internet through the Zyxel Device's default gateway (**R1**). You create one static route to connect to services offered by your ISP behind router **R2**. You create another static route to communicate with a separate network behind a router **R3** connected to the LAN.

**Figure 69** Example of Static Routing Topology

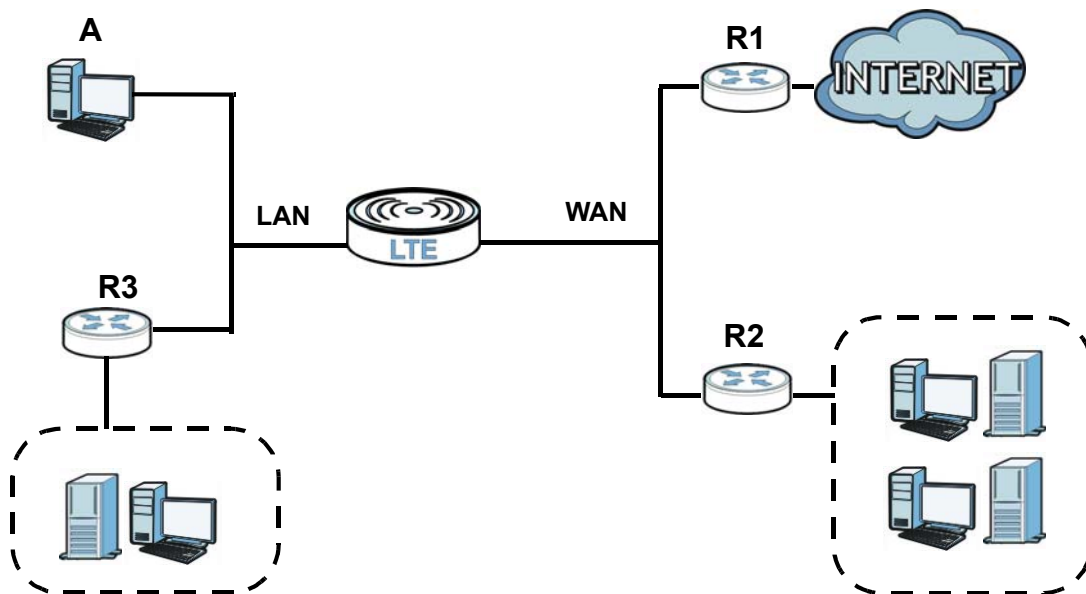

### 8.2 Configure Static Route

View and configure static route rules on the Zyxel Device. The purpose of a static route is to save time and bandwidth usage when LAN devices within an Intranet are transferring files or packets, especially when there are more than two Internet connections in your home or office network. Click **Network Setting > Routing** to open the **Static Route** screen.

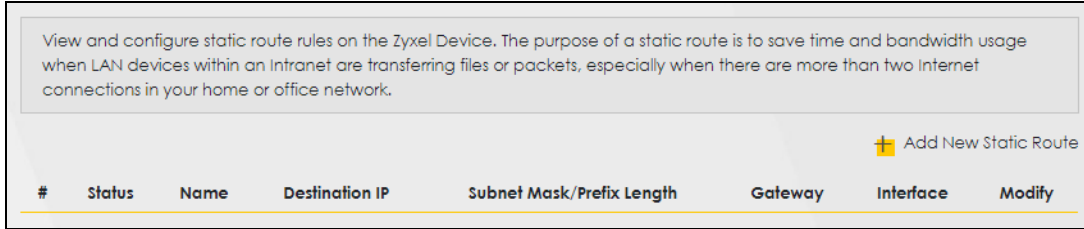
**Figure 70** Network Setting > Routing > Static Route

The following table describes the labels in this screen.

**Table 28** Network Setting > Routing > Static Route

| LABEL                     | DESCRIPTION  |
|---------------------------|--|
| Add New Static Route      | Click this to set up a new static route on the Zyxel Device.   |
| #                         | This is the number of an individual static route.  |
| Status                    | This field indicates whether the rule is active (yellow bulb) or not (gray bulb).  |
| Name                      | This is the name of the static route.  |
| Destination IP            | This parameter specifies the IP network address of the final destination. Routing is always based on network number.   |
| Subnet Mask/Prefix Length | This parameter specifies the IP network subnet mask of the final destination.  |
| Gateway                   | This is the IP address of the gateway. The gateway is a router or switch on the same network segment as the Zyxel Device's LAN or WAN port. The gateway helps forward packets to their destinations. |
| Interface                 | This is the WAN interface through which the traffic is routed.   |
| Modify                    | Click the <b>Edit</b> icon to go to the screen where you can set up a static route on the Zyxel Device.<br>Click the <b>Delete</b> icon to remove a static route from the Zyxel Device.              |

## 8.2.1 Add/Edit Static Route

Click **Add New Static Route** in the **Static Route** screen, the following screen appears. Configure the required information for a static route.

Note: The **Gateway IP Address** must be within the range of the selected interface in **Use Interface**.

Figure 71 Routing: Add New Static Route

The following table describes the labels in this screen.

Table 29 Routing: Add/Edit

| LABEL                  | DESCRIPTION  |
|------------------------|--|
| Active                 | Activates static route.  |
| Route Name             | Assign a name for your static route (up to 15 characters). Special characters are allowed except the following: double quote (") back quote (`) apostrophe or single quote (') less than (<) greater than (>) caret or circumflex accent (^) dollar sign (\$) vertical bar ( ) ampersand (&) semicolon (;)   |
| IP Type                | Select between <b>IPv4</b> or <b>IPv6</b> . Compared to <b>IPv4</b> , <b>IPv6</b> (Internet Protocol version 6), is designed to enhance IP address size and features. The increase in <b>IPv6</b> address size to 128 bits (from the 32-bit <b>IPv4</b> address) allows up to 3.4 x 10 <sup>38</sup> IP addresses. The Zyxel Device can use <b>IPv4/IPv6</b> dual stack to connect to <b>IPv4</b> and <b>IPv6</b> networks, and supports <b>IPv6</b> rapid deployment (6RD). |
| Destination IP Address | This parameter specifies the IP network address of the final destination. Routing is always based on network number. If you need to specify a route to a single host, use a subnet mask of 255.255.255.255 in the subnet mask field to force the network number to be identical to the host ID.  |
| IP Subnet Mask         | Enter the IP subnet mask here.   |
| Use Gateway IP Address | Enables forwarding packets to a gateway IP address or a bound interface.   |
| Gateway IP Address     | You can decide if you want to forward packets to a gateway IP address or a bound interface.<br><br>If you want to configure <b>Gateway IP Address</b> , enter the IP address of the next-hop gateway. The gateway is a router or switch on the same network segment as the Zyxel Device's LAN or WAN port. The gateway helps forward packets to their destinations.  |
| Use Interface          | You can decide if you want to forward packets to a gateway IP address ( <b>Default</b> ) or a bound interface ( <b>Cellular WAN</b> ).<br><br>If you want to configure bound interface, choose an interface through which the traffic is sent. You must have the WAN interfaces already configured in the <b>Broadband</b> screen.   |
| OK                     | Click this to save your changes.   |
| Cancel                 | Click this to exit this screen without saving.   |

## 8.3 DNS Route

Configure how domain name - IP address mapping queries are forwarded from the Zyxel Device to a DNS (Domain Name System) server if your Zyxel Device has multiple WAN interfaces. Click **Network Setting > Routing > DNS Route** to open the **DNS Route** screen.

**Figure 72** Network Setting > Routing > DNS Route

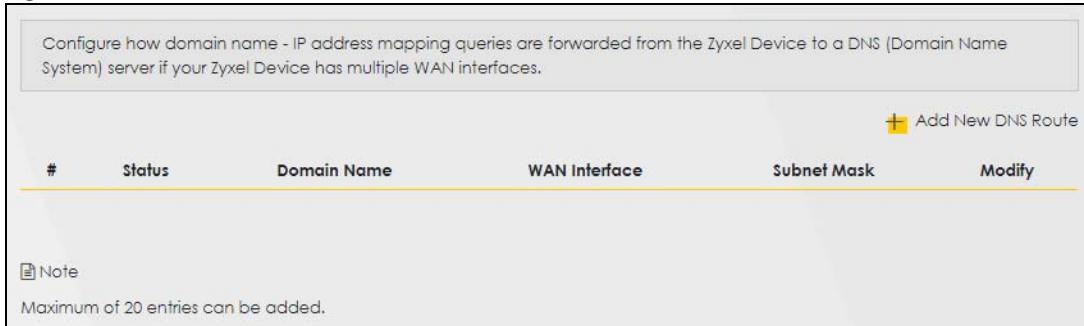

The following table describes the labels in this screen.

**Table 30** Network Setting > Routing > DNS Route

| LABEL             | DESCRIPTION   |
|-------------------|---|
| Add New DNS Route | Click this to create a new entry.   |
| #                 | This is the number of an individual DNS route.  |
| Status            | This field indicates whether the rule is active (yellow bulb) or not (gray bulb).   |
| Domain Name       | This is the domain name to which the DNS route applies.   |
| WAN Interface     | This is the WAN interface through which the matched DNS request is routed.  |
| Subnet Mask       | This parameter specifies the IP network subnet mask.  |
| Modify            | Click the <b>Edit</b> icon to configure a DNS route on the Zyxel Device.<br>Click the <b>Delete</b> icon to remove a DNS route from the Zyxel Device. |

### 8.3.1 Add/Edit DNS Route

Click **Add New DNS Route** in the **DNS Route** screen, use this screen to configure the required information for a DNS route.

Figure 73 Add New DNS Route

The following table describes the labels in this screen.

Table 31 DNS Route: Add/Edit

| LABEL         | DESCRIPTION  |
|---------------|--|
| Active        | Enable DNS route in your Zyxel Device.   |
| Domain Name   | Enter the domain name you want to resolve.<br><br>You can use the wildcard character, an "*" (asterisk) as the left most part of a domain name, such as *.example.com. The Zyxel Device forwards DNS queries for any domain name ending in example.com to the WAN interface specified in this route. |
| Subnet Mask   | Type the subnet mask of the network for which to use the DNS route in dotted decimal notation, for example 255.255.255.255.  |
| WAN Interface | Select a WAN interface through which the matched DNS query is sent. You must have the WAN interface(s) already configured in the <b>Broadband</b> screen.  |
| OK            | Click this to save your changes.   |
| Cancel        | Click this to exit this screen without saving.   |

## 8.4 Policy Route

Traditionally, routing is based on the destination address only and the Zyxel Device takes the shortest path to forward a packet. Policy routes allow you to override the default routing behavior. Policy-based routing is applied to outgoing packets, and is especially useful when there are more than two Internet connections available in your home or office network.

You can use source-based policy forwarding to direct traffic from different users through different connections or distribute traffic among multiple paths for load sharing.



The **Policy Route** screen let you view and configure routing policies on the Zyxel Device. Click **Network Setting > Routing > Policy Route** to open the following screen.

**Figure 74** Network Setting > Routing > Policy Route

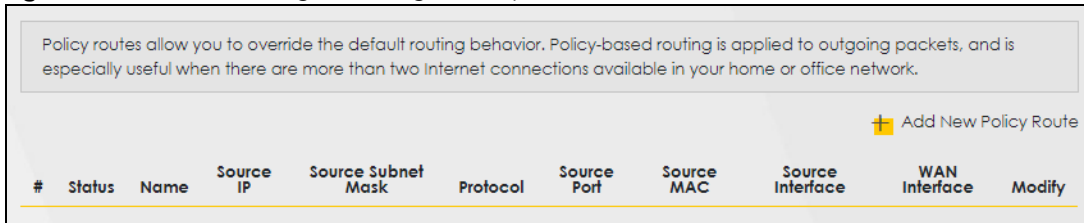

The following table describes the labels in this screen.

**Table 32** Network Setting > Routing > Policy Route

| LABEL                | DESCRIPTION   |
|----------------------|---|
| Add New Policy Route | Click this to create a new policy forwarding rule.  |
| #                    | This is the index number of the entry.  |
| Status               | This field displays whether the DNS route is active or not. A yellow bulb signifies that this DNS route is active. A gray bulb signifies that this DNS route is not active.                               |
| Name                 | This is the name of the rule.   |
| Source IP            | This is the source IP address.  |
| Source Subnet Mask   | This is the source subnet mask address.   |
| Protocol             | This is the transport layer protocol.   |
| Source Port          | This is the source port number.   |
| Source MAC           | This is the source MAC address.   |
| Source Interface     | This is the interface from which the matched traffic is sent.   |
| WAN Interface        | This is the WAN interface through which the traffic is routed.  |
| Modify               | Click the <b>Edit</b> icon to edit this policy.<br><br>Click the <b>Delete</b> icon to remove a policy from the Zyxel Device. A window displays asking you to confirm that you want to delete the policy. |

## 8.4.1 Add/Edit Policy Route

Click **Add New Policy Route** in the **Policy Route** screen or click the **Edit** icon next to a policy. Use this screen to configure the required information for a policy route.

**Figure 75** Policy Route: Add/Edit

The following table describes the labels in this screen.

**Table 33** Policy Route: Add/Edit

| LABEL                                   | DESCRIPTION  |
|---|--|
| Active                                  | Click this to enable (turns blue) activation of the policy route. Otherwise, click to disable (turns gray).                                      |
| Route Name                              | Enter a descriptive name of up to 8 printable English keyboard characters, not including spaces.   |
| Source IP Address                       | Enter the source IP address.   |
| Source Subnet Mask                      | Enter the source subnet mask address.  |
| Protocol                                | Select the transport layer protocol ( <b>TCP</b> or <b>UDP</b> ).  |
| Source Port                             | Enter the source port number.  |
| Source MAC                              | Enter the source MAC address.  |
| Source Interface (ex: br0 or LAN1~LAN4) | Type the name of the interface from which the matched traffic is sent.   |
| WAN Interface                           | Select a WAN interface through which the traffic is sent. You must have the WAN interface(s) already configured in the <b>Broadband</b> screens. |
| Cancel                                  | Click <b>Cancel</b> to exit this screen without saving.  |
| OK                                      | Click <b>OK</b> to save your changes.  |

## 8.5 RIP Overview

Routing Information Protocol (RIP, RFC 1058 and RFC 1389) allows a Zyxel Device to exchange routing information with other routers. To activate RIP for the WAN interface, select the supported RIP version and operation.

### 8.5.1 RIP

Click **Network Setting > Routing > RIP** to open the **RIP** screen. Select the desired RIP version and operation by clicking the check box. To stop RIP on the WAN interface, clear the check box. Click the **Apply** button to start/stop RIP and save the configuration.

**Figure 76** Network Setting > Routing > RIP

Routing Information Protocol (RIP, RFC 1058 and RFC 1389) allows a Zyxel Device to exchange routing information with other routers. Select the desired RIP version and operation by clicking the check box. To stop RIP on the WAN interface, clear the check box. Click the **Apply** button to start/stop RIP and save the configuration.

| # | Interface    | Version | Operation | Enable                   | Disable Default Gateway  |
|---|--------------|---------|-----------|--------------------------|--------------------------|
| 1 | Cellular WAN | RIPv2   | Active    | <input type="checkbox"/> | <input type="checkbox"/> |

Cancel Apply

The following table describes the labels in this screen.

**Table 34** Network Setting > Routing > RIP

| LABEL                   | DESCRIPTION   |
|-------------------------|---|
| #                       | This is the index of the interface in which the RIP setting is used.  |
| Interface               | This is the name of the interface in which the RIP setting is used.   |
| Version                 | The RIP version controls the format and the broadcasting method of the RIP packets that the Zyxel Device sends (it recognizes both formats when receiving). RIP version 1 is universally supported but RIP version 2 carries more information. RIP version 1 is probably adequate for most networks, unless you have an unusual network topology.   |
| Operation               | Select <b>Passive</b> to have the Zyxel Device update the routing table based on the RIP packets received from neighbors but not advertise its route information to other routers in this interface.<br>Select <b>Active</b> to have the Zyxel Device advertise its route information and also listen for routing updates from neighboring routers. |
| Enable                  | Select the check box to activate the settings.  |
| Disable Default Gateway | Select the check box to set the Zyxel Device to not send the route information to the default gateway.  |
| Cancel                  | Click <b>Cancel</b> to exit this screen without saving.   |
| Apply                   | Click <b>Apply</b> to save your changes back to the Zyxel Device.   |

# CHAPTER 9

# Network Address Translation (NAT)

## 9.1 Overview

NAT (Network Address Translation - NAT, RFC 1631) is the translation of the IP address of a host in a packet, for example, the source address of an outgoing packet, used within one network to a different IP address known within another network.

### 9.1.1 What You Can Do in this Chapter

- Use the **Port Forwarding** screen to configure forward incoming service requests to the servers on your local network ([Section 9.2 on page 101](#)).
- Use the **Port Triggering** screen to add and configure the Zyxel Device's trigger port settings ([Section 9.3 on page 104](#)).
- Use the **DMZ** screen to configure a default server ([Section 9.4 on page 107](#)).
- Use the **ALG** screen to enable or disable the SIP ALG ([Section 9.5 on page 108](#)).

### 9.1.2 What You Need To Know

The following terms and concepts may help as you read this chapter.

#### Inside/Outside and Global/Local

Inside/outside denotes where a host is located relative to the Zyxel Device, for example, the computers of your subscribers are the inside hosts, while the web servers on the Internet are the outside hosts.

Global/local denotes the IP address of a host in a packet as the packet traverses a router, for example, the local address refers to the IP address of a host when the packet is in the local network, while the global address refers to the IP address of the host when the same packet is traveling in the WAN side.

#### NAT

In the simplest form, NAT changes the source IP address in a packet received from a subscriber (the inside local address) to another (the inside global address) before forwarding the packet to the WAN side. When the response comes back, NAT translates the destination address (the inside global address) back to the inside local address before forwarding it to the original inside host.

## Port Forwarding

A port forwarding set is a list of inside (behind NAT on the LAN) servers, for example, web or FTP, that you can make visible to the outside world even though NAT makes your whole inside network appear as a single computer to the outside world.

### Find Out More

See [Section on page 109](#) for advanced technical information on NAT.

## 9.2 Port Forwarding Overview

Use **Port Forwarding** to forward incoming service requests from the Internet to the server(s) on your local network. Port forwarding is commonly used when you want to host online gaming, P2P file sharing, or other servers on your network.

You may enter a single port number or a range of port numbers to be forwarded, and the local IP address of the desired server. The port number identifies a service; for example, web service is on port 80 and FTP on port 21. In some cases, such as for unknown services or where one server can support more than one service (for example both FTP and web service), it might be better to specify a range of port numbers. You can allocate a server IP address that corresponds to a port or a range of ports. Please refer to RFC 1700 for further information about port numbers.

Note: Many residential broadband ISP accounts do not allow you to run any server processes (such as a Web or FTP server) from your location. Your ISP may periodically check for servers and may suspend your account if it discovers any active services at your location. If you are unsure, refer to your ISP.

### Configure Servers Behind Port Forwarding (Example)

Let's say you want to assign ports 21-25 to one FTP, Telnet and SMTP server (**A** in the example), port 80 to another (**B** in the example), a default server IP address of 192.168.1.35 to a third (**C** in the example), and a default server IP address of 192.168.1.36 to a fourth (**D** in the example). You assign the LAN IP addresses and the ISP assigns the WAN IP address. The NAT network appears as a single host on the Internet.

**Figure 77** Multiple Servers Behind NAT Example

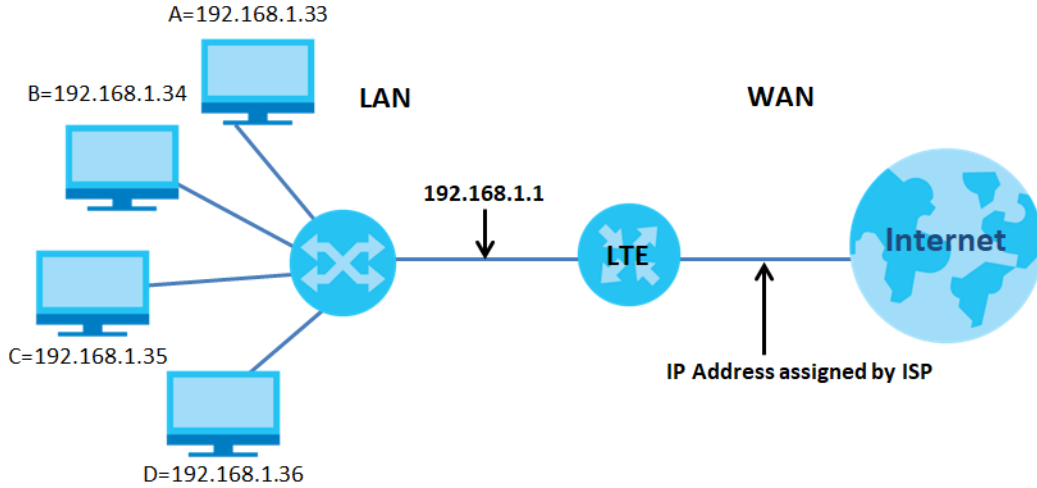

## 9.2.1 Port Forwarding

Click **Network Setting > NAT** to open the **Port Forwarding** screen.

Note: TCP port 7547 is reserved for TR-069 requests.

**Figure 78** Network Setting > NAT > Port Forwarding

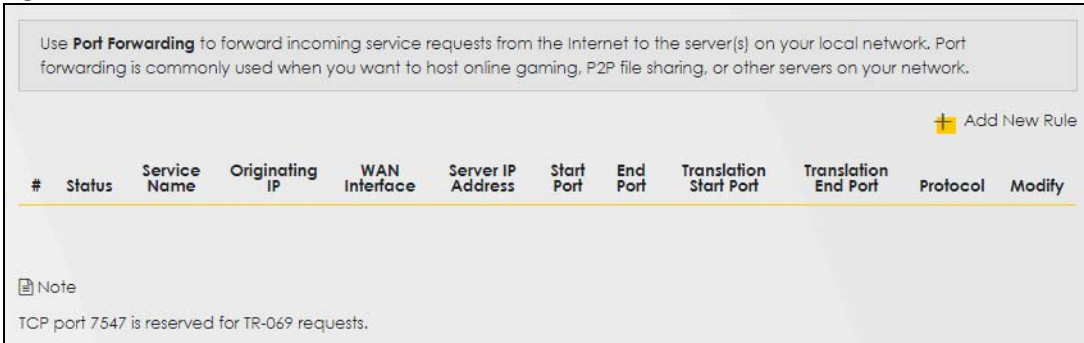

The following table describes the fields in this screen.

**Table 35** Network Setting > NAT > Port Forwarding

| LABEL             | DESCRIPTION  |
|-------------------|--|
| Add New Rule      | Click this to add a new port forwarding rule.  |
| #                 | This is the index number of the entry.   |
| Status            | This field indicates whether the rule is active or not.<br>A yellow bulb signifies that this rule is active. A gray bulb signifies that this rule is not active. |
| Service Name      | This is the service's name. This shows <b>User Defined</b> if you manually added a service. You can change this by clicking the edit icon.                       |
| Originating IP    | This is the source's IP address.   |
| WAN Interface     | Select the WAN interface for which to configure NAT port forwarding rules.   |
| Server IP Address | This is the server's IP address.   |
| Start Port        | This is the first external port number that identifies a service.  |
| End Port          | This is the last external port number that identifies a service.   |

Table 35 Network Setting &gt; NAT &gt; Port Forwarding (continued)

| LABEL                  | DESCRIPTION   |
|------------------------|---|
| Translation Start Port | This is the first internal port number that identifies a service.   |
| Translation End Port   | This is the last internal port number that identifies a service.  |
| Protocol               | This field displays the protocol (TCP, UDP, TCP+UDP) used to transport the packets for which you want to apply the rule.  |
| Modify                 | Click the <b>Edit</b> icon to edit the port forwarding rule.<br><br>Click the <b>Delete</b> icon to delete an existing port forwarding rule. Note that subsequent address mapping rules move up by one when you take this action. |

## 9.2.2 Add/Edit Port Forwarding

Create or edit a port forwarding rule. Specify either a port or a range of ports, a server IP address, and a protocol to configure a port forwarding rule. Click **Add New Rule** in the **Port Forwarding** screen or the **Edit** icon next to an existing rule to open the following screen.

Figure 79 Port Forwarding: Add/Edit

The screenshot shows the 'Add New Rule' configuration screen. It includes the following fields and options:

- Active:** A toggle switch that is currently turned on (blue).
- Service Name:** A text input field.
- WAN Interface:** A dropdown menu currently set to 'Default'.
- Start Port:** A text input field.
- End Port:** A text input field.
- Translation Start Port:** A text input field.
- Translation End Port:** A text input field.
- Server IP Address:** A text input field with a dotted separator.
- Configure Originating IP:** A checkbox that is checked, labeled 'Enable'.
- Originating IP:** A text input field with a dotted separator.
- Protocol:** A dropdown menu currently set to 'TCP'.

Below the fields is a **Note** section with the following instructions:

- (1) Create or edit a port forwarding rule. Specify either a port or a range of ports, a server IP address, and a protocol to configure a port forwarding rule.
- (2) To configure port forwarding, you need to have the same configurations in the **Start Port**, **End Port**, **Translation Start Port**, and **Translation End Port** fields.  
To configure port translation, you need to have different configurations in the **Start Port**, **End Port**, **Translation Start Port**, and **Translation End Port** fields.
- (3) TCP port 7547 is reserved for system use.

At the bottom of the screen are two buttons: **Cancel** and **OK**.

Note: To configure port forwarding, you need to have the same configurations in the **Start Port**, **End Port**, **Translation Start Port**, and **Translation End Port** fields.  
To configure port translation, you need to have different configurations in the **Start Port**, **End Port**, **Translation Start Port**, and **Translation End Port** fields.

Note: TCP port 7547 is reserved for system use.

The following table describes the labels in this screen.

Table 36 Port Forwarding: Add/Edit

| LABEL                    | DESCRIPTION  |
|--------------------------|--|
| Active                   | Select or clear this field to turn the port forwarding rule on or off.   |
| Service Name             | Select a service to forward or select <b>User Defined</b> and enter a name in the field to the right.  |
| WAN Interface            | Select the WAN interface for which to configure NAT port forwarding rules.   |
| Start Port               | Configure this for a user-defined entry. Enter the original destination port for the packets.<br><br>To forward only one port, enter the port number again in the <b>End Port</b> field.<br><br>To forward a series of ports, enter the start port number here and the end port number in the <b>End Port</b> field.   |
| End Port                 | Configure this for a user-defined entry. Enter the last port of the original destination port range.<br><br>To forward only one port, enter the port number in the <b>Start Port</b> field above and then enter it again in this field.<br><br>To forward a series of ports, enter the last port number in a series that begins with the port number in the <b>Start Port</b> field above. |
| Translation Start Port   | Configure this for a user-defined entry. This shows the port number to which you want the Zyxel Device to translate the incoming port. For a range of ports, enter the first number of the range to which you want the incoming ports translated.  |
| Translation End Port     | Configure this for a user-defined entry. This shows the last port of the translated port range.  |
| Server IP Address        | Enter the inside IP address of the virtual server here.  |
| Configure Originating IP | Click the <b>Enable</b> check box to enter the originating IP in the next field.   |
| Originating IP           | Enter the originating IP address here.   |
| Protocol                 | Select the protocol supported by this virtual server. Choices are <b>TCP</b> , <b>UDP</b> , or <b>TCP/UDP</b> .  |
| OK                       | Click this to save your changes.   |
| Cancel                   | Click this to exit this screen without saving.   |

## 9.3 Port Triggering

Some services use a dedicated range of ports on the client side and a dedicated range of ports on the server side. With regular port forwarding, you set a forwarding port in NAT to forward a service (coming in from the server on the WAN) to the IP address of a computer on the client side (LAN). The problem is that port forwarding only forwards a service to a single LAN IP address. In order to use the same service on a different LAN computer, you have to manually replace the LAN computer's IP address in the forwarding port with another LAN computer's IP address.



Unlike port forwarding that only forwards a service to a single LAN IP address, trigger port forwarding allows computers on the LAN to dynamically take turns using a service. Doing away the need to configure a new IP address each time you want a different LAN computer to use a service.

The Zyxel Device records the IP address of a LAN computer that sends traffic to the WAN to request a service with a specific port number and protocol (a "trigger" port). When the Zyxel Device's WAN port receives a response with a specific port number and protocol ("open" port), the Zyxel Device forwards the traffic to the LAN IP address of the computer that sent the request. After the computer's connection for that service closes, another computer on the LAN can use the service in the same manner.

For example:

**Figure 80** Trigger Port Forwarding Process: Example

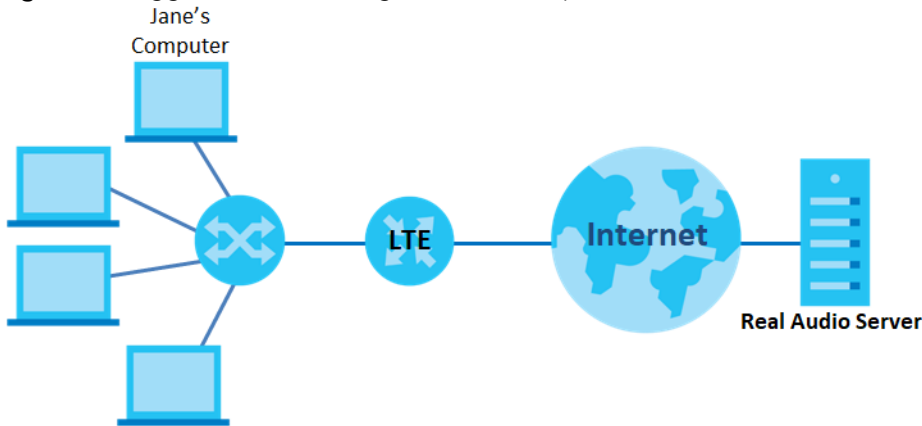

- 1 Jane requests a file from the Real Audio server (port 7070).
- 2 Port 7070 is a "trigger" port and causes the Zyxel Device to record Jane's computer IP address. The Zyxel Device associates Jane's computer IP address with the "open" port range of 6970-7170.
- 3 The Real Audio server responds using a port number ranging between 6970-7170.
- 4 The Zyxel Device forwards the traffic to Jane's computer IP address.
- 5 Only Jane can connect to the Real Audio server until the connection is closed or times out. The Zyxel Device times out in three minutes with UDP (User Datagram Protocol) or two hours with TCP/IP (Transfer Control Protocol/Internet Protocol).

Click **Network Setting > NAT > Port Triggering** to open the following screen. Use this screen to view your Zyxel Device's trigger port settings.

Note: TCP port 7547 is reserved for system use.

Note: The maximum number of trigger ports for a single rule or all rules is 999.  
The maximum number of open ports for a single rule or all rules is 999.

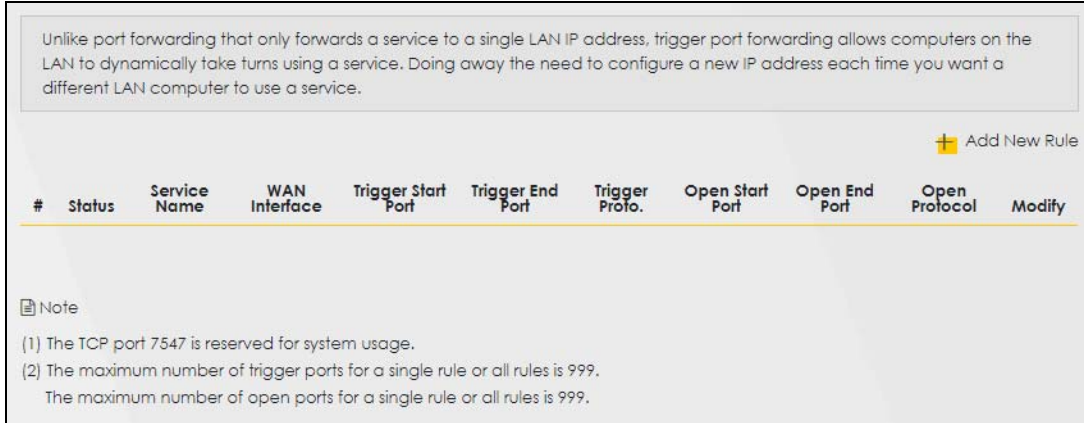
**Figure 81** Network Setting > NAT > Port Triggering

The following table describes the labels in this screen.

**Table 37** Network Setting > NAT > Port Triggering

| LABEL              | DESCRIPTION  |
|--------------------|--|
| Add New Rule       | Click this to create a new rule.   |
| #                  | This is the index number of the entry.   |
| Status             | This field displays whether the port triggering rule is active or not. A yellow bulb signifies that this rule is active. A gray bulb signifies that this rule is not active.   |
| Service Name       | This field displays the name of the service used by this rule.   |
| WAN Interface      | This field shows the WAN interface through which the service is forwarded.   |
| Trigger Start Port | The trigger port is a port (or a range of ports) that causes (or triggers) the Zyxel Device to record the IP address of the LAN computer that sent the traffic to a server on the WAN.<br><br>This is the first port number that identifies a service.   |
| Trigger End Port   | This is the last port number that identifies a service.  |
| Trigger Proto.     | This is the trigger transport layer protocol.  |
| Open Start Port    | The open port is a port (or a range of ports) that a server on the WAN uses when it sends out a particular service. The Zyxel Device forwards the traffic with this port (or range of ports) to the client computer on the LAN that requested the service.<br><br>This is the first port number that identifies a service. |
| Open End Port      | This is the last port number that identifies a service.  |
| Open Protocol      | This is the open transport layer protocol.   |
| Modify             | Click the <b>Edit</b> icon to edit this rule.<br><br>Click the <b>Delete</b> icon to delete an existing rule.  |

### 9.3.1 Add/Edit Port Triggering Rule

This screen lets you create new port triggering rules. Click **Add New Rule** in the **Port Triggering** screen or click a rule's **Edit** icon to open the following screen. Use this screen to configure a port or range of ports and protocols for sending out requests and for receiving responses.

Figure 82 Port Triggering: Add/Edit

The following table describes the labels in this screen.

Table 38 Port Triggering: Configuration Add/Edit

| LABEL              | DESCRIPTION  |
|--------------------|--|
| Active             | Click to enable (blue switch) or disable (gray switch) to activate or deactivate the rule.   |
| Service Name       | Enter a name to identify this rule using keyboard characters (A-Z, a-z, 1-2 and so on).  |
| WAN Interface      | Select a WAN interface for which you want to configure port triggering rules.  |
| Trigger Start Port | The trigger port is a port (or a range of ports) that causes (or triggers) the Zyxel Device to record the IP address of the LAN computer that sent the traffic to a server on the WAN.<br>Type a port number or the starting port number in a range of port numbers.   |
| Trigger End Port   | Type a port number or the ending port number in a range of port numbers.   |
| Trigger Protocol   | Select the transport layer protocol from <b>TCP</b> , <b>UDP</b> , or <b>TCP/UDP</b> .   |
| Open Start Port    | The open port is a port (or a range of ports) that a server on the WAN uses when it sends out a particular service. The Zyxel Device forwards the traffic with this port (or range of ports) to the client computer on the LAN that requested the service.<br>Type a port number or the starting port number in a range of port numbers. |
| Open End Port      | Type a port number or the ending port number in a range of port numbers.   |
| Open Protocol      | Select the transport layer protocol from <b>TCP</b> , <b>UDP</b> , or <b>TCP/UDP</b> .   |
| Cancel             | Click <b>Cancel</b> to exit this screen without saving.  |
| OK                 | Click <b>OK</b> to save your changes.  |

## 9.4 DMZ

A client in the Demilitarized Zone (DMZ) is no longer behind the Zyxel Device and can therefore run any Internet application such as video conferencing and Internet gaming without restrictions. This, however, may pose a security threat to the Zyxel Device. Use this screen to specify the IP address of a default

server to receive packets from ports not specified in the **Port Triggering** screen. Click **Network Setting > NAT > DMZ** to open the **DMZ** screen.

Note: Use an IPv4 address for the DMZ server.

Note: Enter the IP address and click **Apply** to activate the DMZ host.

Otherwise, clear the IP address field and click **Apply** to de-activate the DMZ host.

**Figure 83** Network Setting > NAT > DMZ

The following table describes the fields in this screen.

**Table 39** Network Setting > NAT > DMZ

| LABEL                  | DESCRIPTION   |
|------------------------|---|
| Default Server Address | Enter the IP address of the default server which receives packets from ports that are not specified in the <b>Port Forwarding</b> screen.<br><br>Note: If you do not assign a default server, the Zyxel Device discards all packets received for ports not specified in the virtual server configuration. |
| Apply                  | Click this to save your changes back to the Zyxel Device.   |
| Cancel                 | Click <b>Cancel</b> to restore your previously saved settings.  |

## 9.5 ALG

Click **Network Setting > NAT > ALG** to open the **ALG** screen. Use this screen to enable and disable the NAT Application Layer Gateway (ALG) in the Zyxel Device.

Application Layer Gateway (ALG) allows certain applications such as File Transfer Protocol (FTP), Session Initiation Protocol (SIP), or file transfer in Instant Messaging (IM) applications to pass through the Zyxel Device.

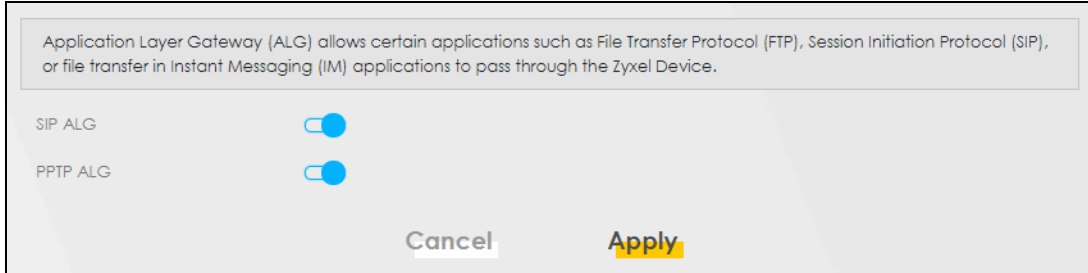
**Figure 84** Network Setting > NAT > ALG

The following table describes the fields in this screen.

**Table 40** Network Setting > NAT > ALG

| LABEL    | DESCRIPTION   |
|----------|---|
| SIP ALG  | Click this (switch turns blue) to make sure SIP (VoIP) works correctly with port-forwarding and address-mapping rules. Otherwise, click this to turn off (switch turns gray) the SIP ALG. |
| PPTP ALG | Click this to turn on (switch turns blue) the PPTP ALG on the Zyxel Device to detect PPTP traffic and help build PPTP sessions through the Zyxel Device's NAT.                            |
| Apply    | Click <b>Apply</b> to save your changes back to the Zyxel Device.   |
| Cancel   | Click <b>Cancel</b> to restore your previously saved settings.  |

# CHAPTER 10

## Dynamic DNS Setup

### 10.1 DNS Overview

#### DNS

DNS (Domain Name System) is for mapping a domain name to its corresponding IP address and vice versa. The DNS server is extremely important because without it, you must know the IP address of a machine before you can access it.

In addition to the system DNS server(s), each WAN interface (service) is set to have its own static or dynamic DNS server list. You can configure a DNS static route to forward DNS queries for certain domain names through a specific WAN interface to its DNS server(s). The Zyxel Device uses a system DNS server (in the order you specify in the **Broadband** screen) to resolve domain names that do not match any DNS routing entry. After the Zyxel Device receives a DNS reply from a DNS server, it creates a new entry for the resolved IP address in the routing table.

#### Dynamic DNS

Dynamic DNS allows you to use a dynamic IP address with one or many dynamic DNS services so that anyone can contact you (in NetMeeting, CU-SeeMe, etc.). You can also access your FTP server or Web site on your own computer using a domain name (for instance myhost.dhs.org, where myhost is a name of your choice) that will never change instead of using an IP address that changes each time you reconnect. Your friends or relatives will always be able to call you even if they don't know your IP address.

You first need to have registered a dynamic DNS account with [www.dyndns.org](http://www.dyndns.org). This is for people with a dynamic IP from their ISP or DHCP server that would still like to have a domain name. The Dynamic DNS service provider will give you a password or key.

#### 10.1.1 What You Can Do in this Chapter

- Use the **DNS Entry** screen to view, configure, or remove DNS routes ([Section 10.2 on page 111](#)).
- Use the **Dynamic DNS** screen to enable DDNS and configure the DDNS settings on the Zyxel Device ([Section 10.3 on page 112](#)).

#### 10.1.2 What You Need To Know

##### DYNDNS Wildcard

Enabling the wildcard feature for your host causes \*.yourhost.dyndns.org to be aliased to the same IP address as yourhost.dyndns.org. This feature is useful if you want to be able to use, for example, www.yourhost.dyndns.org and still reach your hostname.

If you have a private WAN IP address, then you cannot use Dynamic DNS.

## 10.2 DNS Entry

DNS (Domain Name System) is used for mapping a domain name to its corresponding IP address and vice versa. Use this screen to view and configure DNS routes on the Zyxel Device. Click **Network Setting > DNS** to open the **DNS Entry** screen.

Note: The host name should consist of the host's local name and the domain name. For example, Mycomputer.home is a host name where Mycomputer is the host's local name, and .home is the domain name.

**Figure 85** Network Setting > DNS > DNS Entry

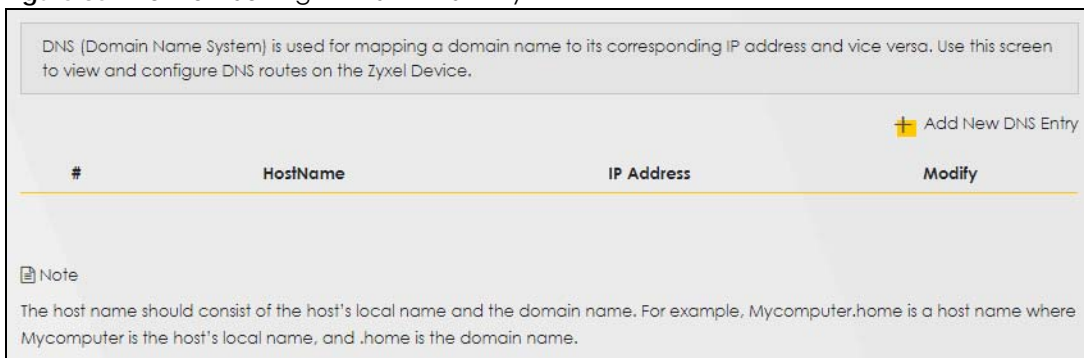

The following table describes the fields in this screen.

**Table 41** Network Setting > DNS > DNS Entry

| LABEL             | DESCRIPTION  |
|-------------------|--|
| Add New DNS Entry | Click this to create a new DNS entry.  |
| #                 | This is the index number of the entry.   |
| Hostname          | This indicates the host name or domain name.   |
| IP Address        | This indicates the IP address assigned to this computer.   |
| Modify            | Click the <b>Edit</b> icon to edit the rule.<br>Click the <b>Delete</b> icon to delete an existing rule. |

### 10.2.1 Add/Edit DNS Entry

You can manually add or edit the Zyxel Device's DNS name and IP address entry. Click **Add New DNS Entry** in the **DNS Entry** screen or the **Edit** icon next to the entry you want to edit. The screen shown next appears.

**Figure 86** DNS Entry: Add/Edit

The following table describes the labels in this screen.

Table 42 DNS Entry: Add/Edit

| LABEL        | DESCRIPTION   |
|--------------|---|
| Host Name    | Enter the host name of the DNS entry.                   |
| IPv4 Address | Enter the IPv4 address of the DNS entry.                |
| Cancel       | Click <b>Cancel</b> to exit this screen without saving. |
| OK           | Click <b>OK</b> to save your changes.                   |

## 10.3 Dynamic DNS

Dynamic DNS can update your current dynamic IP address mapping to a hostname. Configure a DDNS service provider on your Zyxel Device. Click **Network Setting > DNS > Dynamic DNS**. The screen appears as shown.



**Figure 87** Network Setting > DNS > Dynamic DNS

Dynamic DNS can update your current dynamic IP address mapping to a hostname. Configure a DDNS service provider on your Zyxel Device.

### Dynamic DNS Setup

Dynamic DNS  Enable  Disable (Settings are invalid when disable)

Service Provider

Host Name

Username

Password

Enable Wildcard Option

Enable Off Line Option (Only applies to custom DNS)

### Dynamic DNS Status

User Authentication Result

Last Updated Time

Current Dynamic IP

The following table describes the fields in this screen.

**Table 43** Network Setting > DNS > > Dynamic DNS

| LABEL   | DESCRIPTION  |
|---|--|
| Dynamic DNS Setup                                   |  |
| Dynamic DNS   | Select <b>Enable</b> to use dynamic DNS.   |
| Service Provider                                    | Select your Dynamic DNS service provider from the drop-down list box.  |
| Host Name   | Type the domain name assigned to your Zyxel Device by your Dynamic DNS provider. You can specify up to two host names in the field separated by a comma (","). |
| Username  | Type your user name.   |
| Password  | Type the password assigned to you.   |
| Enable Wildcard Option                              | Select the check box to enable DynDNS Wildcard.  |
| Enable Off Line Option (Only applies to custom DNS) | Check with your Dynamic DNS service provider to have traffic redirected to a URL (that you can specify) while you are off line.                                |
| Dynamic DNS Status                                  |  |
| User Authentication Result                          | This shows <b>Success</b> if the account is correctly set up with the Dynamic DNS provider account.  |
| Last Updated Time                                   | This shows the last time the IP address the Dynamic DNS provider has associated with the hostname was updated.   |
| Current Dynamic IP                                  | This shows the IP address your Dynamic DNS provider has currently associated with the hostname.  |
| Cancel  | Click <b>Cancel</b> to exit this screen without saving.  |
| Apply   | Click <b>Apply</b> to save your changes.   |

# CHAPTER 11

## Firewall

### 11.1 Overview

This chapter shows you how to enable the Zyxel Device firewall. Use the firewall to protect your Zyxel Device and network from attacks by hackers on the Internet and control access to it. The firewall:

- allows traffic that originates from your LAN computers to go to all other networks.
- blocks traffic that originates on other networks from going to the LAN.

By default, the Zyxel Device blocks DoS attacks whether the firewall is enabled or disabled.

The following figure illustrates the firewall action. User **A** can initiate an IM (Instant Messaging) session from the LAN to the WAN (1). Return traffic for this session is also allowed (2). However other traffic initiated from the WAN is blocked (3 and 4).

**Figure 88** Default Firewall Action

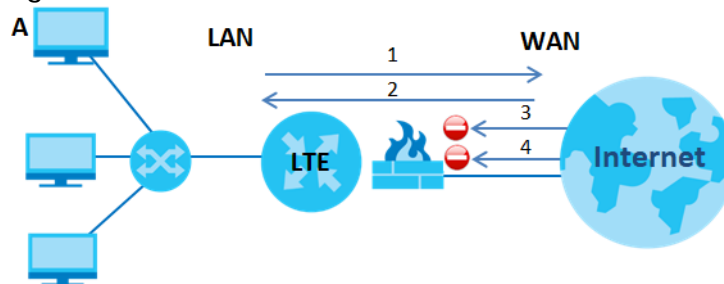

#### 11.1.1 What You Need to Know About Firewall

##### DoS

Denials of Service (DoS) attacks are aimed at devices and networks with a connection to the Internet. Their goal is not to steal information, but to disable a device or network so users no longer have access to network resources. The Zyxel Device is pre-configured to automatically detect and thwart all known DoS attacks.

##### ICMP

Internet Control Message Protocol (ICMP) is a message control and error-reporting protocol between a host server and a gateway to the Internet. ICMP uses Internet Protocol (IP) datagrams, but the messages are processed by the TCP/IP software and directly apparent to the application user.

## DoS Thresholds

For DoS attacks, the Zyxel Device uses thresholds to determine when to drop sessions that do not become fully established. These thresholds apply globally to all sessions. You can use the default threshold values, or you can change them to values more suitable to your security requirements.

# 11.2 Firewall

## 11.2.1 What You Can Do in this Chapter

- Use the **General** screen to configure the security level of the firewall on the Zyxel Device ([Section 11.3 on page 115](#)).
- Use the **Protocol** screen to add or remove predefined Internet services and configure firewall rules ([Section 11.4 on page 117](#)).
- Use the **Access Control** screen to view and configure incoming/outgoing filtering rules ([Section 11.5 on page 118](#)).
- Use the **DoS** screen to activate protection against Denial of Service (DoS) attacks ([Section 11.6 on page 121](#)).

## 11.3 Firewall General Settings

Use the firewall to protect your Zyxel Device and network from attacks by hackers on the Internet and control access to it. Use this screen to set the security level of the firewall on the Zyxel Device. Firewall rules are grouped based on the direction of travel of packets. A higher firewall level means more restrictions on the Internet activities you can perform. Click **Security > Firewall > General** to display the following screen. Use the slider to select the level of firewall protection.

Figure 89 Security &gt; Firewall &gt; General

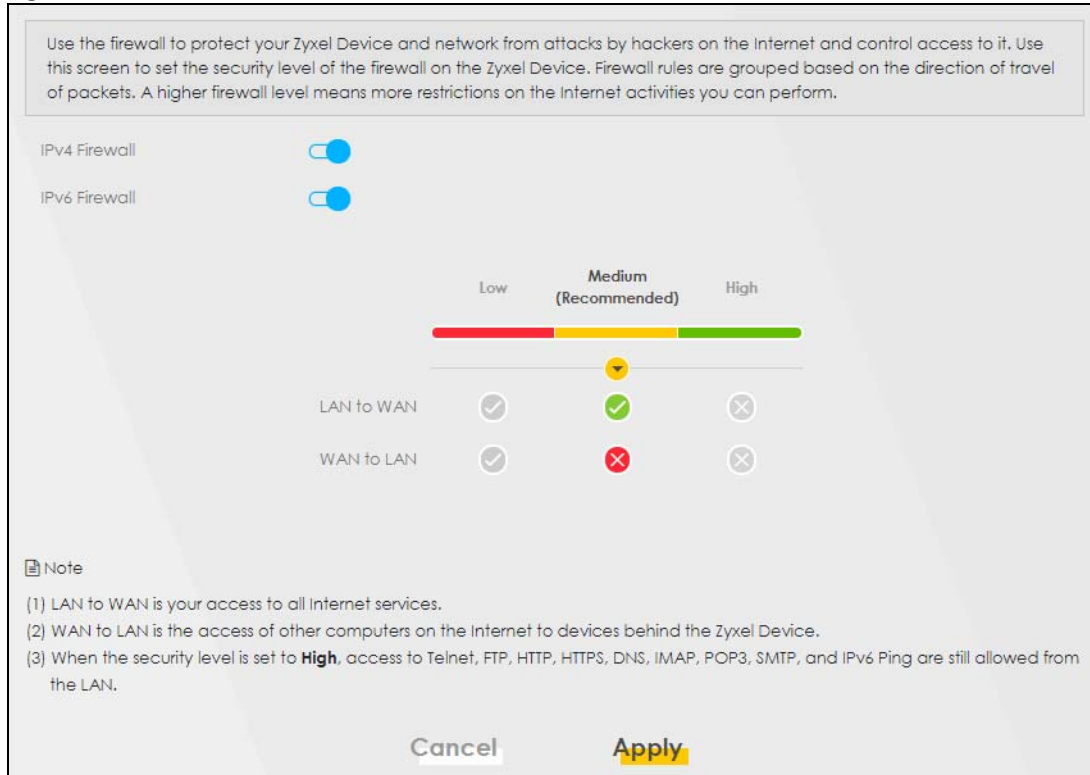

Note: LAN to WAN is your access to all Internet services. WAN to LAN is the access of other computers on the Internet to devices behind the Zyxel Device. When the security level is set to **High**, access to Telnet, FTP, HTTP, HTTPS, DNS, IMAP, POP3, SMTP, and IPv6 Ping are still allowed from the LAN.

The following table describes the labels in this screen.

Table 44 Security &gt; Firewall &gt; General

| LABEL         | DESCRIPTION  |
|---------------|--|
| IPv4 Firewall | Enable firewall protection when using <b>IPv4</b> (Internet Protocol version 4).   |
| IPv6 Firewall | Enable firewall protection when using <b>IPv6</b> (Internet Protocol version 6).   |
| High          | This setting blocks all traffic to and from the Internet. Only local network traffic and LAN to WAN service (Telnet, FTP, HTTP, HTTPS, DNS, POP3, SMTP) is permitted.                    |
| Medium        | This is the recommended setting. It allows traffic to the Internet but blocks anyone from the Internet from accessing any services on your local network.                                |
| Low           | This setting allows traffic to the Internet and also allows someone from the Internet to access services on your local network. This would be used with Port Forwarding, Default Server. |
| Apply         | Click this to save your changes.   |
| Cancel        | Click this to restore your previously saved settings.  |

## 11.4 Protocol (Customized Services)

A protocol is a port number rule which defines a service. Services include Email, File sharing, Instant messaging, Online games, Print servers, Voice over IP and so on. Define services in this screen that you want to apply access control rules to in the **Firewall > Access Control** screen. For a comprehensive list of port numbers and services, visit the IANA (Internet Assigned Number Authority) website. Click **Security > Firewall > Protocol** to display the following screen.

Note: Removing a protocol rule will also remove associated ACL rules.

**Figure 90** Security > Firewall > Protocol

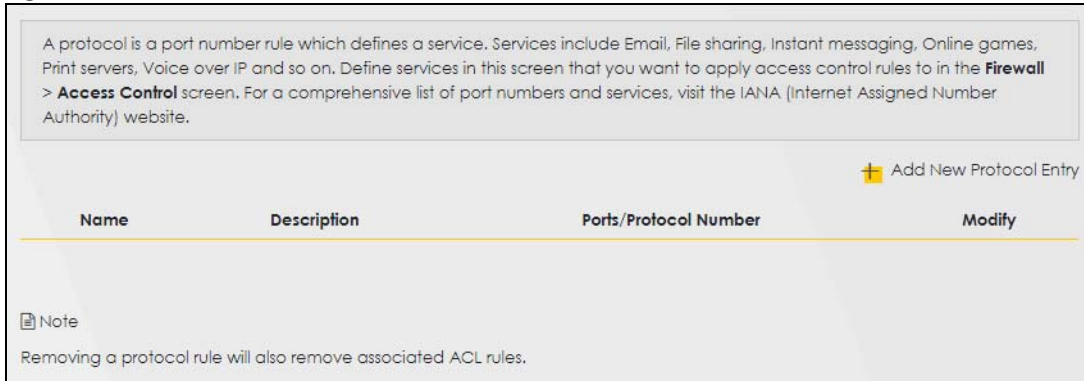

The following table describes the labels in this screen.

**Table 45** Security > Firewall > Protocol

| LABEL                  | DESCRIPTION  |
|------------------------|--|
| Add New Protocol Entry | Click this to configure a customized service.  |
| Name                   | This is the name of your customized service.   |
| Description            | This is a description of your customized service.  |
| Ports/Protocol Number  | This shows the port number or range and the IP protocol ( <b>TCP</b> or <b>UDP</b> ) that defines your customized service. |
| Modify                 | Click this to edit a customized service.   |

### 11.4.1 Add Customized Service

Add a customized rule or edit an existing rule by specifying the protocol and the port number(s). Click **Add New Protocol Entry** in the **Protocol** screen to display the following screen.

**Figure 91** Security > Firewall > Protocol: Add New Protocol Entry

The following table describes the labels in this screen.

**Table 46** Security > Firewall > Protocol: Add New Protocol Entry

| LABEL           | DESCRIPTION   |
|-----------------|---|
| Service Name    | Type a unique name for your custom port.  |
| Description     | Enter a description for your custom port.   |
| Protocol        | Choose the protocol ( <b>TCP</b> , <b>UDP</b> , <b>ICMP</b> , <b>ICMPv6</b> , <b>Other</b> ) that defines your customized port from the drop down list box. |
| Protocol Number | Type a single port number or the range of port numbers ( <b>0-255</b> ) that define your customized service.  |
| OK              | Click this to save your changes.  |
| Cancel          | Click this to exit this screen without saving.  |

## 11.5 Access Control (Rules)

An Access Control List (ACL) rule is a manually-defined rule that can accept, reject, or drop incoming or outgoing packets from your network based on the type of service. For example, you could block users using Instant Messaging in your network. This screen displays a list of the configured incoming or outgoing filtering rules. Note the order in which the rules are listed. Click **Security > Firewall > Access Control** to display the following screen.

Note: The ordering of your rules is very important as rules are applied in turn.

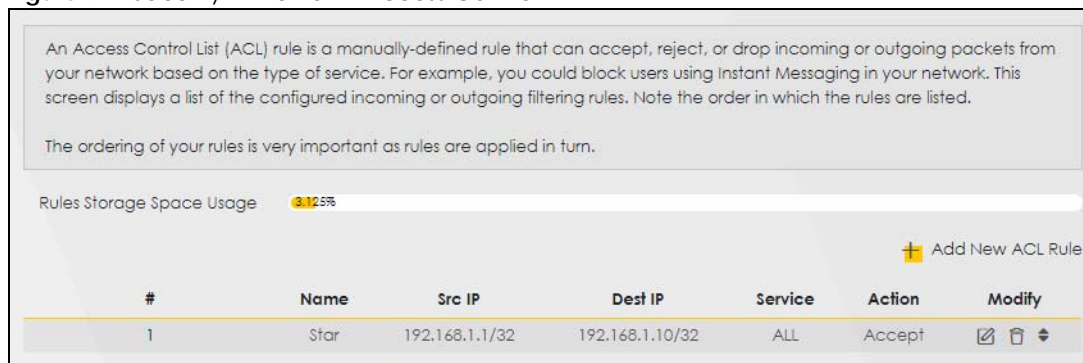
**Figure 92** Security > Firewall > Access Control

The following table describes the labels in this screen.

**Table 47** Security > Firewall > Rules

| LABEL                     | DESCRIPTION  |
|---------------------------|--|
| Rules Storage Space Usage | This read-only bar shows how much of the Zyxel Device's memory for recording firewall rules it is currently using. When you are using 80% or less of the storage space, the bar is green. When the amount of space used is over 80%, the bar is red.                       |
| Add New ACL Rule          | Select an index number and click <b>Add</b> to add a new firewall rule after the selected index number. For example, if you select "6", your new rule becomes number 7 and the previous rule 7 (if there is one) becomes rule 8.   |
| #                         | This field displays the rule index number. The ordering of your rules is important as rules are applied in turn.   |
| Name                      | This field displays the rule name.   |
| Src IP                    | This field displays the source IP addresses to which this rule applies.  |
| Dest IP                   | This field displays the destination IP addresses to which this rule applies.   |
| Service                   | This field displays the protocol (TCP, UDP, TCP+UDP or any) used to transport the packets for which you want to apply the rule.  |
| Action                    | Displays whether the firewall silently discards packets ( <b>Drop</b> ), discards packets and sends a TCP reset packet or an ICMP destination-unreachable message to the sender ( <b>Reject</b> ), or allow the passage of ( <b>Accept</b> ) packets that match this rule. |
| Modify                    | Click the <b>Edit</b> icon to edit the firewall rule.<br>Click the <b>Delete</b> icon to delete an existing firewall rule.   |

### 11.5.1 Access Control Add New ACL Rule

Use this screen to configure firewall rules. In the **Access Control** screen, select an index number and click **Add New ACL Rule** or click a rule's **Edit** icon to display this screen and refer to the following table for information on the labels.

**Figure 93** Security > Firewall > Access Control > Add New ACL Rule

The screenshot shows the 'Add New ACL Rule' configuration interface. It includes the following fields and options:

- Filter Name:** Text input field.
- Order:** Dropdown menu with '1' selected.
- Select Source IP Address:** Dropdown menu with 'Specific IP Address' selected.
- Source IP Address:** Text input field with a placeholder '[]/prefix length'.
- Select Destination Device:** Dropdown menu with 'Specific IP Address' selected.
- Destination IP Address:** Text input field with a placeholder '[]/prefix length'.
- IP Type:** Dropdown menu with 'IPv4' selected.
- Select Service:** Dropdown menu with 'Specific Service' selected.
- Protocol:** Dropdown menu with 'ALL' selected.
- Custom Source Port:** Range selector with 'Range', '1', and '1'.
- Custom Destination Port:** Range selector with 'Range', '1', and '1'.
- Policy:** Dropdown menu with 'ACCEPT' selected.
- Direction:** Dropdown menu with 'WAN to LAN' selected.
- Enable Rate Limit:** Toggle switch (turned on).
- Scheduler Rules:** Fields for 'packet(s) per Minute' and '(1-512)'. Includes a dropdown menu and an 'Add New Rule' button.

At the bottom, there are 'Cancel' and 'OK' buttons.

The following table describes the labels in this screen.

**Table 48** Security > Firewall > Access Control > Add New ACL Rule

| LABEL                     | DESCRIPTION  |
|---------------------------|--|
| Filter Name               | Type a unique name for your filter rule.   |
| Order                     | Assign the order of your rules as rules are applied in turn.   |
| Select Source IP Address  | If you want the source to come from a particular (single) IP, select <b>Specific IP Address</b> . If not, select from a detected device.   |
| Source IP Address         | If you selected <b>Specific IP Address</b> in the previous item, enter the source device's IP address here. Otherwise this field will be hidden if you select the detected device.   |
| Select Destination Device | If you want your rule to apply to packets with a particular (single) IP, select <b>Specific IP Address</b> . If not, select a detected device.   |
| Destination IP Address    | If you selected <b>Specific IP Address</b> in the previous item, enter the destination device's IP address here. Otherwise this field will be hidden if you select the detected device.  |
| IP Type                   | Select between <b>IPv4</b> or <b>IPv6</b> . Compared to <b>IPv4</b> , <b>IPv6</b> (Internet Protocol version 6), is designed to enhance IP address size and features. The increase in <b>IPv6</b> address size to 128 bits (from the 32-bit <b>IPv4</b> address) allows up to 3.4 x 1038 IP addresses. The Zyxel Device can use <b>IPv4/IPv6</b> dual stack to connect to <b>IPv4</b> and <b>IPv6</b> networks, and supports <b>IPv6</b> rapid deployment (6RD). |
| Select Service            | Select a service from the <b>Select Service</b> box.   |
| Protocol                  | Select the protocol ( <b>ALL</b> , <b>TCP/UDP</b> , <b>TCP</b> , <b>UDP</b> , <b>ICMP</b> , <b>ICMPv6</b> ) used to transport the packets for which you want to apply the rule.  |



Table 48 Security &gt; Firewall &gt; Access Control &gt; Add New ACL Rule (continued)

| LABEL                   | DESCRIPTION   |
|-------------------------|---|
| Custom Source Port      | This is a single port number or the starting port number of a range that defines your rule.   |
| Custom Destination Port | This is a single port number or the ending port number of a range that defines your rule.   |
| Policy                  | Use the drop-down list box to select whether to discard ( <b>Drop</b> ), deny and send an ICMP destination-unreachable message to the sender ( <b>Reject</b> ), or allow the passage of ( <b>Accept</b> ) packets that match this rule.   |
| Direction               | Select <b>WAN to LAN</b> to apply the rule to traffic from WAN to LAN. Select <b>LAN to WAN</b> to apply the rule to traffic from LAN to WAN. Select <b>WAN to Router</b> to apply the rule to traffic from WAN to router. Select <b>LAN to Router</b> to apply the rule to traffic from LAN to router. |
| Enable Rate Limit       | Click to enable (switch turns blue) the setting of maximum number of packets per maximum number of minute/second to limit the throughput of traffic that matches this rule. If not, the next item will be disabled.   |
| Scheduler Rules         |   |
| packet(s) per (1-512)   | Enter the maximum number of <b>packets (1-512) per minute/second</b> .  |
| Add New Rule            | Select a schedule rule for this ACL rule form the drop-down list box. You can configure a new schedule rule by clicking <b>Add New Rule</b> .   |
| OK                      | Click this to save your changes.  |
| Cancel                  | Click this to exit this screen without saving.  |

## 11.6 DoS

Activate protection against DoS attacks. DoS (Denial of Service) attacks can flood your Internet connection with invalid packets and connection requests, using so much bandwidth and so many resources that Internet access becomes unavailable.

Click **Security > Firewall > DoS** to display the following screen.

Figure 94 Security &gt; Firewall &gt; DoS

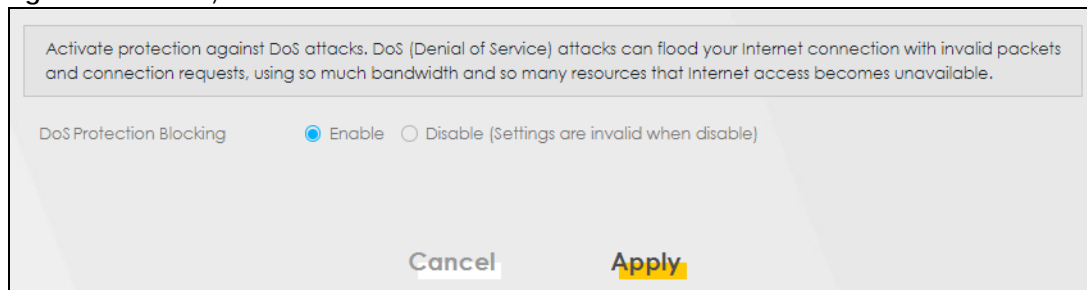

The following table describes the labels in this screen.

Table 49 Security &gt; Firewall &gt; DoS

| LABEL                   | DESCRIPTION  |
|-------------------------|--|
| DoS Protection Blocking | Enable this to protect against DoS attacks. The Zyxel Device will drop sessions that surpass maximum thresholds. |
| Apply                   | Click this to save your changes.   |
| Cancel                  | Click this to restore your previously saved settings.  |

## 11.7 Firewall Technical Reference

This section provides some technical background information about the topics covered in this chapter.

### 11.7.1 Firewall Rules Overview

Your customized rules take precedence and override the Zyxel Device's default settings. The Zyxel Device checks the source IP address, destination IP address and IP protocol type of network traffic against the firewall rules (in the order you list them). When the traffic matches a rule, the Zyxel Device takes the action specified in the rule.

Firewall rules are grouped based on the direction of travel of packets to which they apply:

- LAN to Router
- LAN to WAN
- WAN to LAN
- WAN to Router

By default, the Zyxel Device's stateful packet inspection allows packets traveling in the following directions:

- LAN to Router

These rules specify which computers on the LAN can manage the Zyxel Device (remote management).

Note: You can also configure the remote management settings to allow only a specific computer to manage the Zyxel Device.

- LAN to WAN

These rules specify which computers on the LAN can access which computers or services on the WAN.

By default, the Zyxel Device's stateful packet inspection drops packets traveling in the following directions:

- WAN to LAN

These rules specify which computers on the WAN can access which computers or services on the LAN.

Note: You also need to configure NAT port forwarding (or full featured NAT address mapping rules) to allow computers on the WAN to access devices on the LAN.

- WAN to Router

By default the Zyxel Device stops computers on the WAN from managing the Zyxel Device. You could configure one of these rules to allow a WAN computer to manage the Zyxel Device.

Note: You also need to configure the remote management settings to allow a WAN computer to manage the Zyxel Device.

You may define additional rules and sets or modify existing ones but please exercise extreme caution in doing so.

For example, you may create rules to:

- Block certain types of traffic, such as IRC (Internet Relay Chat), from the LAN to the Internet.
- Allow certain types of traffic, such as Lotus Notes database synchronization, from specific hosts on the Internet to specific hosts on the LAN.
- Allow everyone except your competitors to access a web server.
- Restrict use of certain protocols, such as Telnet, to authorized users on the LAN.

These custom rules work by comparing the source IP address, destination IP address and IP protocol type of network traffic to rules set by the administrator. Your customized rules take precedence and override the Zyxel Device's default rules.

## 11.7.2 Guidelines For Security Enhancement With Your Firewall

- 1 Change the default password via the Web Configurator.
- 2 Think about access control before you connect to the network in any way.
- 3 Limit who can access your router.
- 4 Don't enable any local service (such as telnet or FTP) that you don't use. Any enabled service could present a potential security risk. A determined hacker might be able to find creative ways to misuse the enabled services to access the firewall or the network.
- 5 For local services that are enabled, protect against misuse. Protect by configuring the services to communicate only with specific peers, and protect by configuring rules to block packets for the services at specific interfaces.
- 6 Protect against IP spoofing by making sure the firewall is active.
- 7 Keep the firewall in a secured (locked) room.

## 11.7.3 Security Considerations

Note: Incorrectly configuring the firewall may block valid access or introduce security risks to the Zyxel Device and your protected network. Use caution when creating or deleting firewall rules and test your rules after you configure them.

Consider these security ramifications before creating a rule:

- 1 Does this rule stop LAN users from accessing critical resources on the Internet? For example, if IRC (Internet Relay Chat) is blocked, are there users that require this service?
- 2 Is it possible to modify the rule to be more specific? For example, if IRC is blocked for all users, will a rule that blocks just certain users be more effective?
- 3 Does a rule that allows Internet users access to resources on the LAN create a security vulnerability? For example, if FTP ports (TCP 20, 21) are allowed from the Internet to the LAN, Internet users may be able to connect to computers with running FTP servers.
- 4 Does this rule conflict with any existing rules?

Once these questions have been answered, adding rules is simply a matter of entering the information into the correct fields in the Web Configurator screens.

# CHAPTER 12

## MAC Filter

### 12.1 MAC Filter Overview

You can configure the Zyxel Device to permit access to clients based on their MAC addresses in the **MAC Filter** screen. This applies to wired and wireless connections. Every Ethernet device has a unique MAC (Media Access Control) address. The MAC address is assigned at the factory and consists of six pairs of hexadecimal characters, for example, 00:A0:C5:00:00:02. You need to know the MAC addresses of the LAN client to configure this screen.

### 12.2 MAC Filter

Enable **MAC Address Filter** and add the host name and MAC address of a LAN client to the table if you wish to allow or deny them access to your network. Select **Security > MAC Filter**. The screen appears as shown.

Figure 95 Security > MAC Filter

**MAC Filter**

You can configure the Zyxel Device to permit access to clients based on their MAC addresses in the **MAC Filter** screen. This applies to wired and wireless connections. Every Ethernet device has a unique MAC (Media Access Control) address. The MAC address is assigned at the factory and consists of six pairs of hexadecimal characters, for example, 00:A0:C5:00:00:02. You need to know the MAC addresses of the LAN client to configure this screen.

MAC Address Filter  Enable  Disable (Settings are invalid when disable)

MAC Restrict Mode  Allow  Deny

[+](#) Add New Rule

| Set | Active | Host Name | MAC Address | Delete |
|-----|--------|-----------|-------------|--------|
|-----|--------|-----------|-------------|--------|



Note

Enable **MAC Address Filter** and add the host name and MAC address of a LAN client to the table if you wish to allow or deny them access to your network.

Cancel **Apply**

You can choose to enable or disable the filters per entry; make sure that the check box under **Active** is selected if you want to use a filter, as shown in the example below.

**Figure 96** Enabling individual MAC filters

| Set | Active                              | Host Name | MAC Address                 | Delete  |
|-----|-------------------------------------|-----------|-----------------------------|---|
| 1   | <input checked="" type="checkbox"/> | test      | BC - 22 - 33 - 11 - 66 - AA |  |
| 2   | <input checked="" type="checkbox"/> | Test      | BC - 88 - 99 - 00 - 11 - 22 |  |

The following table describes the labels in this screen.

Table 50 Security &gt; MAC Filter

| LABEL              | DESCRIPTION  |
|--------------------|--|
| MAC Address Filter | Select <b>Enable</b> to activate the MAC filter function.  |
| MAC Restrict Mode  | Select <b>Allow</b> to only permit the listed MAC addresses access to the Zyxel Device. Select <b>Deny</b> to permit anyone access to the Zyxel Device except the listed MAC addresses.  |
| Add New Rule       | Click this button to create a new entry.   |
| Set                | This is the index number of the MAC address.   |
| Active             | Select <b>Active</b> to enable the MAC filter rule. The rule will not be applied if <b>Allow</b> is not selected under <b>MAC Restrict Mode</b> .  |
| Host Name          | Enter the host name of the wireless or LAN clients that are allowed access to the Zyxel Device.  |
| MAC Address        | Enter the MAC addresses of the wireless or LAN clients that are allowed access to the Zyxel Device in these address fields. Enter the MAC addresses in a valid MAC address format, that is, six hexadecimal character pairs, for example, 12:34:56:78:9a:bc. |
| Delete             | Click the <b>Delete</b> icon to delete an existing rule.   |
| Cancel             | Click <b>Cancel</b> to restore your previously saved settings.   |
| Apply              | Click <b>Apply</b> to save your changes.   |

# CHAPTER 13

## Certificates

### 13.1 Overview

The Zyxel Device can use certificates (also called digital IDs) to authenticate users. Certificates are based on public-private key pairs. A certificate contains the certificate owner's identity and public key. Certificates provide a way to exchange public keys for use in authentication.

#### 13.1.1 What You Can Do in this Chapter

- Use the **Local Certificates** screen to view and import the Zyxel Device's CA-signed (Certification Authority) certificates ([Section 13.2 on page 127](#)).
- Use the **Trusted CA** screen to save the certificates of trusted CAs to the Zyxel Device. You can also export the certificates to a computer ([Section 13.3 on page 131](#)).

### 13.2 Local Certificates

View the Zyxel Device's summary list of certificates, generate certification requests, and import the signed certificates. You can import the following certificates to your Zyxel Device:

- Web Server - This certificate secures HTTP connections.
- SSH- This certificate secures remote connections.

Click **Security > Certificates** to open the **Local Certificates** screen.

**Figure 97** Security > Certificates > Local Certificates

View the Zyxel Device's summary list of certificates, generate certification requests, and import the signed certificates.

Replace PrivateKey/Certificate file in PEM format

Private Key is protected by password

No file chosen

| Current File | Subject | Issuer | Valid From | Valid To | Modify |
|--------------|---------|--------|------------|----------|--------|
|--------------|---------|--------|------------|----------|--------|

The following table describes the labels in this screen.

Table 51 Security > Certificates > Local Certificates

| LABEL                                | DESCRIPTION  |
|--------------------------------------|--|
|                                      | Replace Private Key/Certificate file in PEM format   |
| Private Key is protected by password | Select the check box and enter the private key into the text box to store it on the Zyxel Device. The private key should not exceed 63 ASCII characters (not including spaces).  |
| Choose File                          | Click this button to find the certificate file you want to upload.   |
| Import Certificate                   | Click this button to save the certificate that you have enrolled from a certification authority from your computer to the Zyxel Device.  |
| Create Certificate Request           | Click this button to go to the screen where you can have the Zyxel Device generate a certification request.  |
| Current File                         | This field displays the name used to identify this certificate. It is recommended that you give each certificate a unique name.  |
| Subject                              | This field displays identifying information about the certificate's owner, such as <b>CN</b> (Common Name), <b>OU</b> (Organizational Unit or department), <b>O</b> (Organization or company) and <b>C</b> (Country). It is recommended that each certificate have a unique subject information.   |
| Issuer                               | This field displays identifying information about the certificate's issuing certification authority, such as a common name, organizational unit or department, organization or company and country.  |
| Valid From                           | This field displays the date that the certificate becomes applicable. The text displays in red and includes a <b>Not Yet Valid!</b> message if the certificate has not yet become applicable.  |
| Valid To                             | This field displays the date that the certificate expires. The text displays in red and includes an <b>Expiring!</b> or <b>Expired!</b> message if the certificate is about to expire or has already expired.  |
| Modify                               | <p>Click the <b>View</b> icon to open a screen with an in-depth list of information about the certificate.</p> <p>For a certification request, click <b>Load Signed</b> to import the signed certificate.</p> <p>Click the <b>Remove</b> icon to remove the certificate (or certification request). A window displays asking you to confirm that you want to delete the certificate. Note that subsequent certificates move up by one when you take this action.</p> |

### 13.2.1 Create Certificate Request

Click **Security > Certificates > Local Certificates** and then **Create Certificate Request** to open the following screen. Have the Zyxel Device generate a certification request. To create a certificate signing request, you need to enter a common name, organization name, state/province name, and the two-letter country code for the certificate.



Figure 98 Create Certificate Request

The following table describes the labels in this screen.

Table 52 Create Certificate Request

| LABEL               | DESCRIPTION  |
|---------------------|--|
| Certificate Name    | Type up to 63 ASCII characters (not including spaces) to identify this certificate.  |
| Common Name         | Select <b>Auto</b> to have the Zyxel Device configure this field automatically. Or select <b>Customize</b> to enter it manually.<br><br>Type the IP address (in dotted decimal notation), domain name or email address in the field provided. The domain name or email address can be up to 63 ASCII characters. The domain name or email address is for identification purposes only and can be any string. |
| Organization Name   | Type up to 63 characters to identify the company or group to which the certificate owner belongs. You may use any character, including spaces, but the Zyxel Device drops trailing spaces.   |
| State/Province Name | Type up to 32 characters to identify the state or province where the certificate owner is located. You may use any character, including spaces, but the Zyxel Device drops trailing spaces.  |
| Country/Region Name | Select a country to identify the nation where the certificate owner is located.  |
| Cancel              | Click <b>Cancel</b> to exit this screen without saving.  |
| OK                  | Click <b>OK</b> to save your changes.  |

## 13.2.2 View Certificate Request

View in-depth information about the certificate request. The **Certificate** is used to verify the authenticity of the certification authority. The **Private Key** serves as your digital signature for authentication and must be safely stored. The **Signing Request** contains the certificate signing request value that you will copy upon submitting the certificate request to the CA (certificate authority).

Click the **View** icon in the **Local Certificates** screen to open the following screen.

Figure 99 Certificate Request: View

**View Certificate**

**Certificate Details**

Name: Test

Type: none

Subject: /CN=588BF3-VMG8825-B50B-S172V48000015/O=Zyxel/ST=Hsinchu/C=TW

Certificate

Private Key

```
hGEzXjrKpeJHmKBehzvdv
KGLNbx22N1C0qtl++BwFFzOK8xTshyNxGW27goeOY
1QpuD2RQy1FB+Ky9zVNCRuP
6C1korOCNOwp2Mds4udfazEzEefm7ysyC0P2etwd7
AbLBM49P1qUsWbGWR9snO74
Myqhf+kCc2R801HUQvWX7XbHzTG+8RKTpV/oCkLZy
cUBlyq0IY2f6FkWBxp9C2H
xteLLgB6SXDfK5vTyQTcj0spmPNcj4ZkxkhtuLwM8E3
bzHGdujBwvzZXnf6NxAZ
fAdmacFCaYFA+SIZJoWxoB90BopN1JP3t//IOLPznbS
```

Signing Request

```
-----BEGIN CERTIFICATE REQUEST-----
MIICoDCCAYgCAQAwWzEqMCgGA1UEAwwhNTg4
QkYzLVZNRzg4MjU0MjUwQl1TMTcy
VjQ4MDAwMDE1MQ4wDAYDVGQKDAVaeXhibDEQ
MA4GA1UECAwHSHNpbmNodTElMAkG
A1UEBHMCMVFcwggEiMA0GCSqGSIb3DQEBAQUAA4
BDwAwggEKAoIBAQDMCB3HK+Su
PeKUpWid2QkPL4qsQsYXhL7chHWxCYAFw9QQYXP
NDQm4I3bs9rfwLqUMFck3F4HQ
```

**Back**

The following table describes the fields in this screen.

Table 53 Certificate Request: View

| LABEL       | DESCRIPTION  |
|-------------|--|
| Name        | This field displays the identifying name of this certificate.  |
| Type        | This field displays general information about the certificate. <b>ca</b> means that a Certification Authority signed the certificate.  |
| Subject     | This field displays information that identifies the owner of the certificate, such as Common Name (CN), Organizational Unit (OU), Organization (O) and Country (C).  |
| Certificate | This read-only text box displays the certificate in Privacy Enhanced Mail (PEM) format. PEM uses base 64 to convert the binary certificate into a printable form.<br><br>You can copy and paste the certificate into an email to send to friends or colleagues or you can copy and paste the certificate into a text editor and save the file on a management computer for later distribution. |
| Private Key | This field displays the private key of this certificate.   |

Table 53 Certificate Request: View (continued)

| LABEL           | DESCRIPTION  |
|-----------------|--|
| Signing Request | This field displays the CSR (Certificate Signing Request) information of this certificate. The CSR will be provided to a certificate authority, and it includes information about the public key, organization name, domain name, location, and country of this certificate. |
| Back            | Click <b>Back</b> to return to the previous screen.  |

## 13.3 Trusted CA

Click **Security > Certificates > Trusted CA** to open the following screen. A summary list of certificates of the certification authorities that you have set the Zyxel Device to accept as trusted is listed below. The Zyxel Device accepts any valid certificate signed by a certification authority on this list as being trustworthy; thus you do not need to import any certificate that is signed by one of these certification authorities.

Note: A maximum of 4 certificates can be stored.

Figure 100 Security &gt; Certificates &gt; Trusted CA



The following table describes the labels in this screen.

Table 54 Security &gt; Certificates &gt; Trusted CA

| LABEL              | DESCRIPTION  |
|--------------------|--|
| Import Certificate | Click this button to open a screen where you can save the certificate of a certification authority that you trust to the Zyxel Device.   |
| #                  | This is the index number of the entry.   |
| Name               | This field displays the name used to identify this certificate.  |
| Subject            | This field displays information that identifies the owner of the certificate, such as Common Name (CN), OU (Organizational Unit or department), Organization (O), State (ST) and Country (C). It is recommended that each certificate have a unique subject information.                                     |
| Type               | This field displays general information about the certificate. <b>ca</b> means that a Certification Authority signed the certificate.  |
| Modify             | Click the <b>View</b> icon to open a screen with an in-depth list of information about the certificate (or certification request).<br><br>Click the <b>Remove</b> icon to delete the certificate (or certification request). You cannot delete a certificate that one or more features is configured to use. |

## 13.4 Import Trusted CA Certificate

Click **Import Certificate** in the **Trusted CA** screen to open the **Import Certificate** screen. The Zyxel Device trusts any valid certificate signed by any of the imported trusted CA certificates. Certificates should be in one of the following formats: Binary X.509, PEM (base-64) encoded, Binary PKCS#7, or PEM (base-64) encoded PKCS#7. You can save a trusted certification authority's certificate to the Zyxel Device.

Note: You must remove any spaces from the certificate's filename before you can import the certificate.

Figure 101 Trusted CA > Import

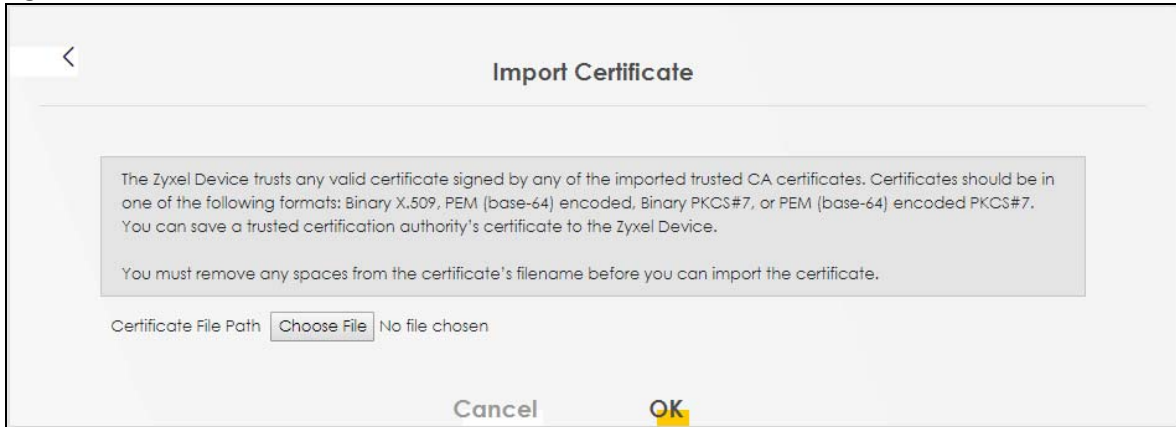

The following table describes the labels in this screen.

Table 55 Security > Certificates > Trusted CA > Import

| LABEL                 | DESCRIPTION   |
|-----------------------|---|
| Certificate File Path | Type in the location of the file you want to upload in this field or click <b>Choose File</b> to find it. |
| Choose File           | Click this button to find the certificate file you want to upload.  |
| OK                    | Click this to save the certificate on the Zyxel Device.   |
| Cancel                | Click this to exit this screen without saving.  |

## 13.5 View Trusted CA Certificate

View in-depth information about the certification authority's certificate. The certificate text box is read-only and can be distributed to others.

Click **Security > Certificates > Trusted CA** to open the **Trusted CA** screen. Click the **View** icon to open the **View Certificate** screen.

Figure 102 Trusted CA: View

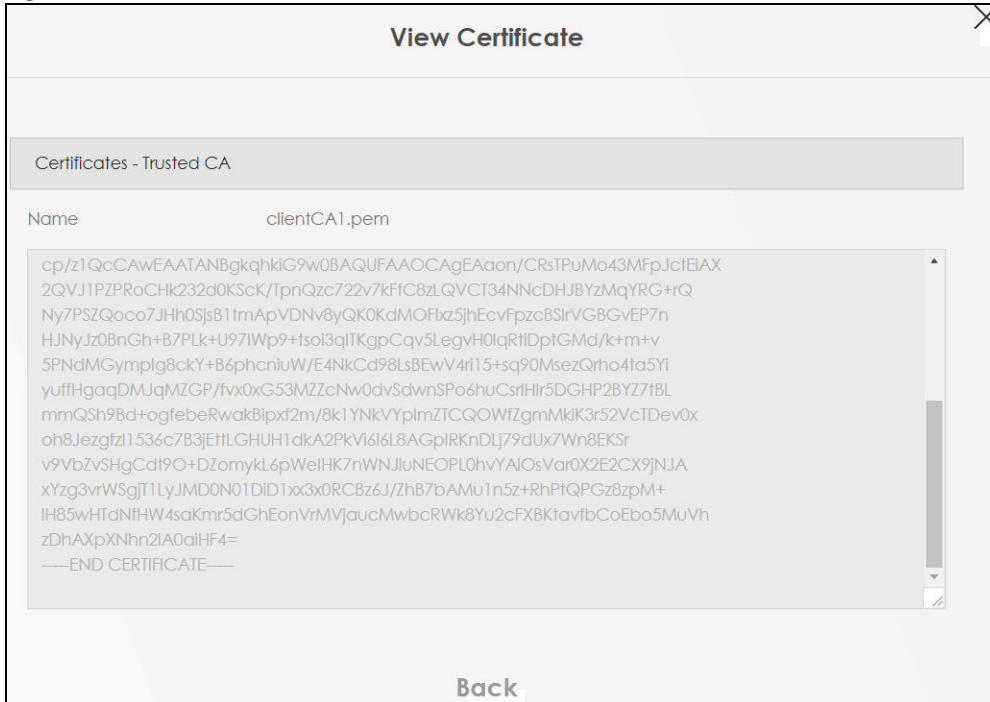

The following table describes the labels in this screen.

Table 56 Trusted CA: View

| LABEL | DESCRIPTION   |
|-------|---|
| Name  | This field displays the identifying name of this certificate.   |
|       | This read-only text box displays the certificate or certification request in Privacy Enhanced Mail (PEM) format. PEM uses 64 ASCII characters to convert the binary certificate into a printable form.<br><br>You can copy and paste the certificate into an email to send to friends or colleagues or you can copy and paste the certificate into a text editor and save the file on a management computer for later distribution (via USB thumb drive for example). |
| Back  | Click this to return to the previous screen.  |

## 13.6 Certificates Technical Reference

This section provides some technical background information about the topics covered in this chapter.

### Certification Authorities

A Certification Authority (CA) issues certificates and guarantees the identity of each certificate owner. There are commercial certification authorities like CyberTrust or VeriSign and government certification authorities.

## Public and Private Keys

When using public-key cryptology for authentication, each host has two keys. One key is public and can be made openly available; the other key is private and must be kept secure. Public-key encryption in general works as follows.

- 1 Tim wants to send a private message to Jenny. Tim generates a public-private key pair. What is encrypted with one key can only be decrypted using the other.
- 2 Tim keeps the private key and makes the public key openly available.
- 3 Tim uses his private key to encrypt the message and sends it to Jenny.
- 4 Jenny receives the message and uses Tim's public key to decrypt it.
- 5 Additionally, Jenny uses her own private key to encrypt a message and Tim uses Jenny's public key to decrypt the message.

The Zyxel Device uses certificates based on public-key cryptology to authenticate users attempting to establish a connection. The method used to secure the data that you send through an established connection depends on the type of connection. For example, a VPN tunnel might use the triple DES encryption algorithm.

The certification authority uses its private key to sign certificates. Anyone can then use the certification authority's public key to verify the certificates.

## Advantages of Certificates

Certificates offer the following benefits.

- The Zyxel Device only has to store the certificates of the certification authorities that you decide to trust, no matter how many devices you need to authenticate.
- Key distribution is simple and very secure since you can freely distribute public keys and you never need to transmit private keys.

## Certificate File Format

The certification authority certificate that you want to import has to be in PEM (Base-64) encoded X.509 file format. This Privacy Enhanced Mail format uses 64 ASCII characters to convert a binary X.509 certificate into a printable form.

### 13.6.1 Verify a Certificate

Before you import a trusted CA or trusted remote host certificate into the Zyxel Device, you should verify that you have the actual certificate. This is especially true of trusted CA certificates since the Zyxel Device also trusts any valid certificate signed by any of the imported trusted CA certificates.

You can use a certificate's fingerprint to verify it. A certificate's fingerprint is a message digest calculated using the MD5 or SHA1 algorithms. The following procedure describes how to check a certificate's fingerprint to verify that you have the actual certificate.

- 1 Browse to where you have the certificate saved on your computer.

- 2 Make sure that the certificate has a ".cer" or ".crt" file name extension.

**Figure 103** Certificates on Your Computer

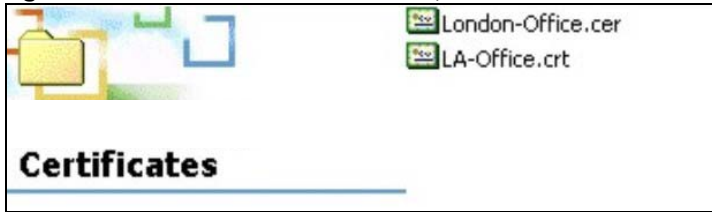

- 3 Double-click the certificate's icon to open the **Certificate** window. Click the **Details** tab and scroll down to the **Thumbprint Algorithm** and **Thumbprint** fields.

**Figure 104** Certificate Details

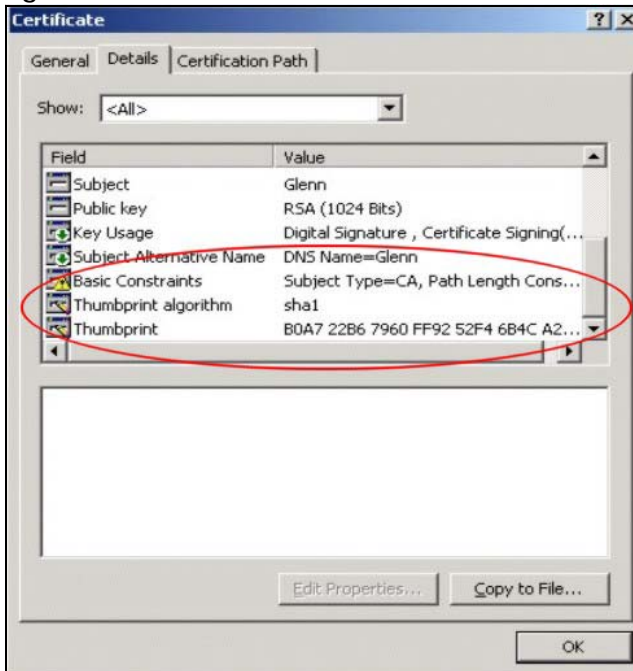

Use a secure method to verify that the certificate owner has the same information in the **Thumbprint Algorithm** and **Thumbprint** fields. The secure method may vary based on your situation. Possible examples would be over the telephone or through an HTTPS connection.

# CHAPTER 14

# Log

## 14.1 Log Overview

These screens allow you to determine the categories of events and/or alerts that the Zyxel Device logs and then display these logs or have the Zyxel Device send them to an administrator (through email) or to a syslog server.

### 14.1.1 What You Can Do in this Chapter

- Use the **System Log** screen to see the system logs ([Section 14.2 on page 137](#)).
- Use the **Security Log** screen to see the security-related logs for the categories that you select ([Section 14.3 on page 137](#)).

### 14.1.2 What You Need To Know

The following terms and concepts may help as you read this chapter.

#### Alerts and Logs

An alert is a type of log that warrants more serious attention. They include system errors, attacks (access control) and attempted access to blocked web sites. Some categories such as **System Errors** consist of both logs and alerts. You may differentiate them by their color in the **View Log** screen. Alerts display in red and logs display in black.

#### Syslog Overview

The syslog protocol allows devices to send event notification messages across an IP network to syslog servers that collect the event messages. A syslog-enabled device can generate a syslog message and send it to a syslog server.

Syslog is defined in RFC 3164. The RFC defines the packet format, content and system log related information of syslog messages. Each syslog message has a facility and severity level. The syslog facility identifies a file in the syslog server. Refer to the documentation of your syslog program for details. The following table describes the syslog severity levels.

Table 57 Syslog Severity Levels

| CODE | SEVERITY   |
|------|--|
| 0    | Emergency: The system is unusable.                   |
| 1    | Alert: Action must be taken immediately.             |
| 2    | Critical: The system condition is critical.          |
| 3    | Error: There is an error condition on the system.    |
| 4    | Warning: There is a warning condition on the system. |



Table 57 Syslog Severity Levels

| CODE | SEVERITY   |
|------|--|
| 5    | Notice: There is a normal but significant condition on the system. |
| 6    | Informational: The syslog contains an informational message.       |
| 7    | Debug: The message is intended for debug-level purposes.           |

## 14.2 System Log

Export or email the system logs. You can filter the entries by clicking the **Level** and/or **Category** drop-down list boxes. Click **System Monitor > Log** to open the **System Log** screen.

Figure 105 System Monitor &gt; Log &gt; System Log

Export or email the system logs. You can filter the entries by clicking the **Level** and/or **Category** drop-down list boxes.

Level:  Category:  [Clear Log](#) [Refresh](#) [Export Log](#) [E-mail Log Now](#)

| # | Time | Facility | Level | Category | Messages |
|---|------|----------|-------|----------|----------|
|---|------|----------|-------|----------|----------|

The following table describes the fields in this screen.

Table 58 System Monitor &gt; Log &gt; System Log

| LABEL         | DESCRIPTION  |
|---------------|--|
| Level         | Select a severity level from the drop-down list box. This filters search results according to the severity level you have selected. When you select a severity, the Zyxel Device searches through all logs of that severity or higher. |
| Category      | Select the type of logs to display.  |
| Clear Log     | Click this to delete all the logs.   |
| Refresh       | Click this to renew the log screen.  |
| Export Log    | Click this to export the selected log(s).  |
| Email Log Now | Click this to send the log file(s) to the email address you specify in the <b>Maintenance &gt; Logs Setting</b> screen.  |
| #             | This field is a sequential value and is not associated with a specific entry.  |
| Time          | This field displays the time the log was recorded.   |
| Facility      | The log facility allows you to send logs to different files in the syslog server. Refer to the documentation of your syslog program for more details.  |
| Level         | This field displays the severity level of the log that the device is to send to this syslog server.  |
| Category      | This field displays the type of the log.   |
| Messages      | This field states the reason for the log.  |

## 14.3 Security Log

View the security-related logs for the categories that you select. You can filter the entries by clicking the **Level** and/or **Category** drop-down list boxes. Click **System Monitor > Log > Security Log** to open the following screen.

**Figure 106** System Monitor > Log > Security Log

View the security-related logs for the categories that you select. You can filter the entries by clicking the **Level** and/or **Category** drop-down list boxes.

Level:  Category:

[Clear Log](#) [Refresh](#) [Export Log](#) [E-mail Log Now](#)

| # | Time | Facility | Level | Category | Messages |
|---|------|----------|-------|----------|----------|
|---|------|----------|-------|----------|----------|

The following table describes the fields in this screen.

**Table 59** System Monitor > Log > Security Log

| LABEL         | DESCRIPTION  |
|---------------|--|
| Level         | Select a severity level from the drop-down list box. This filters search results according to the severity level you have selected. When you select a severity, the Zyxel Device searches through all logs of that severity or higher. |
| Category      | Select the type of logs to display.  |
| Clear Log     | Click this to delete all the logs.   |
| Refresh       | Click this to renew the log screen.  |
| Export Log    | Click this to export the selected log(s).  |
| Email Log Now | Click this to send the log file(s) to the email address you specify in the <b>Maintenance &gt; Logs Setting</b> screen.  |
| #             | This field is a sequential value and is not associated with a specific entry.  |
| Time          | This field displays the time the log was recorded.   |
| Facility      | The log facility allows you to send logs to different files in the syslog server. Refer to the documentation of your syslog program for more details.  |
| Level         | This field displays the severity level of the log that the device is to send to this syslog server.  |
| Category      | This field displays the type of the log.   |
| Messages      | This field states the reason for the log.  |

# CHAPTER 15

## Traffic Status

### 15.1 Traffic Status Overview

View the network traffic status and statistics of the WAN/LAN interfaces.

#### 15.1.1 What You Can Do in this Chapter

- Use the **WAN** screen to view the WAN traffic statistics (Section 15.2 on page 139).
- Use the **LAN** screen to view the LAN traffic statistics (Section 15.3 on page 140).

### 15.2 WAN Status

Click **System Monitor > Traffic Status** to open the **WAN** screen. The figures in this screen show the number of bytes received and sent through the Zyxel Device. Detailed information about each interface are listed in the tables below.

**Figure 107** System Monitor > Traffic Status > WAN

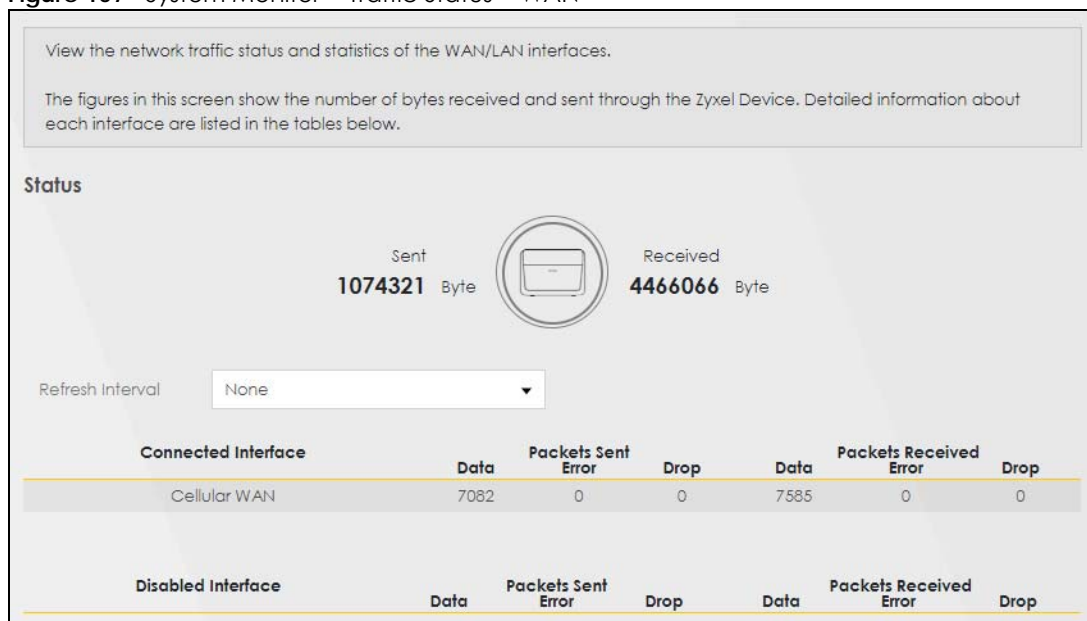

The following table describes the fields in this screen.

Table 60 System Monitor > Traffic Status > WAN

| LABEL               | DESCRIPTION  |
|---------------------|--|
| Refresh Interval    | Select how often you want the Zyxel Device to update this screen.              |
| Connected Interface | This shows the name of the WAN interface that is currently connected.          |
| Packets Sent        |  |
| Data                | This indicates the number of transmitted packets on this interface.            |
| Error               | This indicates the number of frames with errors transmitted on this interface. |
| Drop                | This indicates the number of outgoing packets dropped on this interface.       |
| Packets Received    |  |
| Data                | This indicates the number of received packets on this interface.               |
| Error               | This indicates the number of frames with errors received on this interface.    |
| Drop                | This indicates the number of received packets dropped on this interface.       |
| Disabled Interface  | This shows the name of the WAN interface that is currently disabled.           |
| Packets Sent        |  |
| Data                | This indicates the number of transmitted packets on this interface.            |
| Error               | This indicates the number of frames with errors transmitted on this interface. |
| Drop                | This indicates the number of outgoing packets dropped on this interface.       |
| Packets Received    |  |
| Data                | This indicates the number of received packets on this interface.               |
| Error               | This indicates the number of frames with errors received on this interface.    |
| Drop                | This indicates the number of received packets dropped on this interface.       |

## 15.3 LAN Status

Click **System Monitor > Traffic Status > LAN** to open the following screen. The figures in this screen show the number of bytes received and sent from each LAN port and wireless network.

**Figure 108** System Monitor > Traffic Status > LAN

The figures in this screen show the number of bytes received and sent from each LAN port and wireless network.

Refresh Interval: 60 seconds

| Interface      | LAN1     | 2.4G WLAN |
|----------------|----------|-----------|
| Bytes Sent     | 5355261  | 779962    |
| Bytes Received | 14252259 | 438458    |

| Interface         | LAN1  | 2.4G WLAN |
|-------------------|-------|-----------|
| Sent (Packet)     | Data  | 12006     |
|                   | Error | 0         |
|                   | Drop  | 0         |
| Received (Packet) | Data  | 17579     |
|                   | Error | 0         |
|                   | Drop  | 10        |

The following table describes the fields in this screen.

**Table 61** System Monitor > Traffic Status > LAN

| LABEL              | DESCRIPTION  |
|--------------------|--|
| Refresh Interval   | Select how often you want the Zyxel Device to update this screen.              |
| Interface          | This shows the LAN or WLAN interface.  |
| Bytes Sent         | This indicates the number of bytes transmitted on this interface.              |
| Bytes Received     | This indicates the number of bytes received on this interface.                 |
| Interface          | This shows the LAN or WLAN interfaces.   |
| Sent (Packets)     |  |
| Data               | This indicates the number of transmitted packets on this interface.            |
| Error              | This indicates the number of frames with errors transmitted on this interface. |
| Drop               | This indicates the number of outgoing packets dropped on this interface.       |
| Received (Packets) |  |
| Data               | This indicates the number of received packets on this interface.               |
| Error              | This indicates the number of frames with errors received on this interface.    |
| Drop               | This indicates the number of received packets dropped on this interface.       |

# CHAPTER 16

## ARP Table

### 16.1 ARP Table Overview

Address Resolution Protocol (ARP) is a protocol for mapping an Internet Protocol address (IP address) to a physical machine address, also known as a Media Access Control or MAC address, on the local area network.

An IP (version 4) address is 32 bits long. In an Ethernet LAN, MAC addresses are 48 bits long. The ARP table maintains an association between each MAC address and its corresponding IP address.

#### 16.1.1 How ARP Works

When an incoming packet destined for a host device on a local area network arrives at the device, the device's ARP program looks in the ARP table and, if it finds the address, sends it to the device.

If no entry is found for the IP address, ARP broadcasts the request to all the devices on the LAN. The device fills in its own MAC and IP address in the sender address fields, and puts the known IP address of the target in the target IP address field. In addition, the device puts all ones in the target MAC field (FF.FF.FF.FF.FF.FF is the Ethernet broadcast address). The replying device (which is either the IP address of the device being sought or the router that knows the way) replaces the broadcast address with the target's MAC address, swaps the sender and target pairs, and unicasts the answer directly back to the requesting machine. ARP updates the ARP table for future reference and then sends the packet to the MAC address that replied.

## 16.2 ARP Table

Use the ARP table to view the IPv4-to-MAC address mapping(s) for the LAN. The neighbor table shows the IPv6-to-MAC address mapping(s) of each neighbor. To open this screen, click **System Monitor > ARP Table**.

**Figure 109** System Monitor > ARP Table

| ARP Table  |                           |                   |        |
|--|---------------------------|-------------------|--------|
| Address Resolution Protocol (ARP) is a protocol for mapping an Internet Protocol address (IP address) to a physical machine address, also known as a Media Access Control or MAC address, on the local area network. |                           |                   |        |
| The ARP table maintains an association between each MAC address and its corresponding IP address.  |                           |                   |        |
| Use the ARP table to view the IPv4-to-MAC address mapping(s) for the LAN. The neighbor table shows the IPv6-to-MAC address mapping(s) of each neighbor.  |                           |                   |        |
| IPv4 ARP Table   |                           |                   |        |
| #  | IPv4 Address              | MAC Address       | Device |
| 1  | 192.168.1.129             | dc:4a:3e:40:ec:5f | br0    |
| 2  | 192.168.1.93              | 74:f6:1c:0d:f1:69 | br0    |
| IPv6 Neighbour Table   |                           |                   |        |
| #  | IPv6 Address              | MAC Address       | Device |
| 1  | fe80::ecad:ab45:c530:cc3f | dc:4a:3e:40:ec:5f | br0    |
| 2  | fe80::2d8d:742c:122d:59ae | 74:f6:1c:0d:f1:69 | br0    |

The following table describes the labels in this screen.

**Table 62** System Monitor > ARP Table

| LABEL             | DESCRIPTION  |
|-------------------|--|
| #                 | This is the ARP table entry number.  |
| IPv4/IPv6 Address | This is the learned IPv4 or IPv6 IP address of a device connected to a port.                                       |
| MAC Address       | This is the MAC address of the device with the listed IP address.  |
| Device            | This is the type of interface used by the device. You can click the device type to go to its configuration screen. |

# CHAPTER 17

## Routing Table

### 17.1 Routing Table Overview

Routing is based on the destination address only and the Zyxel Device takes the shortest path to forward a packet.

### 17.2 Routing Table

The table below shows IPv4 and IPv6 routing information. The destination can be a network or host. The IPv4 subnet mask is '255.255.255.255' for a host destination and '0.0.0.0' for the default route. The gateway address is written as '\*' (IPv4) / '::' (IPv6) if none is set. Flags can be U - up, ! - reject, G - gateway, C - cache, H - host, R - reinstate, D - dynamic (redirect), or M - modified (redirect). Metric is the distance to the target (usually counted in hops). Interface is how the packets for this route will be sent.



Click **System Monitor > Routing Table** to open the following screen.

**Figure 110** System Monitor > Routing Table

| Routing Table  |              |                 |        |           |           |
|--|--------------|-----------------|--------|-----------|-----------|
| Routing is based on the destination address only and the Zyxel Device takes the shortest path to forward a packet.   |              |                 |        |           |           |
| The table below shows IPv4 and IPv6 routing information. The destination can be a network or host. The IPv4 subnet mask is '255.255.255.255' for a host destination and '0.0.0.0' for the default route. The gateway address is written as '**' (IPv4) / '::' (IPv6) if none is set. Flags can be U - up, ! - reject, G - gateway, C - cache, H - host, R - reinstate, D - dynamic (redirect), or M - modified (redirect). Metric is the distance to the target (usually counted in hops). Interface is how the packets for this route will be sent. |              |                 |        |           |           |
| IPv4 Routing Table   |              |                 |        |           |           |
| Destination  | Gateway      | Subnet Mask     | Flag   | Metric    | Interface |
| 0.0.0.0  | 10.60.62.158 | 0.0.0.0         | UG     | 0         | wwan0     |
| 10.60.62.156   | 0.0.0.0      | 255.255.255.252 | U      | 0         | wwan0     |
| 127.0.0.0  | 0.0.0.0      | 255.255.0.0     | U      | 0         | lo        |
| 192.168.1.0  | 0.0.0.0      | 255.255.255.0   | U      | 0         | br0       |
| 239.0.0.0  | 0.0.0.0      | 255.0.0.0       | U      | 0         | br0       |
| IPv6 Routing Table   |              |                 |        |           |           |
| Destination  | Gateway      | Flag            | Metric | Interface |           |
| fe80::/64  | ::           | U               | 256    | eth2      |           |
| fe80::/64  | ::           | U               | 256    | br0       |           |
| fe80::/64  | ::           | U               | 256    | ra0       |           |
| fe80::/64  | ::           | U               | 256    | wwan0     |           |
| ::1/128  | ::           | U               | 0      | lo        |           |
| fe80::/128   | ::           | U               | 0      | lo        |           |
| fe80::/128   | ::           | U               | 0      | lo        |           |
| fe80::/128   | ::           | U               | 0      | lo        |           |
| fe80::/128   | ::           | U               | 0      | lo        |           |
| fe80::3065:f9ff:fe8c:186/128   | ::           | U               | 0      | lo        |           |
| fe80::86aa:9cff:fe83:b903/128  | ::           | U               | 0      | lo        |           |
| fe80::86aa:9cff:fe83:b903/128  | ::           | U               | 0      | lo        |           |
| fe80::86aa:9cff:fe83:b904/128  | ::           | U               | 0      | lo        |           |
| ff02::1/128  | ::           | UC              | 0      | br0       |           |
| ff00::/8   | ::           | U               | 256    | eth2      |           |
| ff00::/8   | ::           | U               | 256    | br0       |           |
| ff00::/8   | ::           | U               | 256    | ra0       |           |
| ff00::/8   | ::           | U               | 256    | wwan0     |           |

The following table describes the labels in this screen.

**Table 63** System Monitor > Routing Table

| LABEL                   | DESCRIPTION   |
|-------------------------|---|
| IPv4/IPv6 Routing Table |   |
| Destination             | This indicates the destination IPv4 address or IPv6 address and prefix of this route.                   |
| Gateway                 | This indicates the IPv4 address or IPv6 address of the gateway that helps forward this route's traffic. |
| Subnet Mask             | This indicates the destination subnet mask of the IPv4 route.   |

Table 63 System Monitor &gt; Routing Table (continued)

| LABEL     | DESCRIPTION   |
|-----------|---|
| Flag      | <p>This indicates the route status.</p> <p><b>U-Up:</b> The route is up.</p> <p><b>!-Reject:</b> The route is blocked and will force a route lookup to fail.</p> <p><b>G-Gateway:</b> The route uses a gateway to forward traffic.</p> <p><b>H-Host:</b> The target of the route is a host.</p> <p><b>R-Reinstate:</b> The route is reinstated for dynamic routing.</p> <p><b>D-Dynamic (redirect):</b> The route is dynamically installed by a routing daemon or redirect.</p> <p><b>M-Modified (redirect):</b> The route is modified from a routing daemon or redirect.</p> |
| Metric    | <p>The metric represents the "cost of transmission." A router determines the best route for transmission by choosing a path with the lowest "cost." The smaller the number, the lower the "cost."</p>   |
| Interface | <p>This indicates the name of the interface through which the route is forwarded.</p>   |

# CHAPTER 18

## Cellular WAN Status

### 18.1 Cellular WAN Status Overview

View the LTE connection details and WiFi signal strength value that you can use as reference for positioning the Zyxel Device, as well as SIM card and module information.

### 18.2 Cellular WAN Status

To open this screen, click **System Monitor > Cellular WAN Status**. Cellular information is available on this screen only when you insert a valid SIM card in the Zyxel Device.

Figure 111 System Monitor > Cellular WAN Status

| Module Information           |                              | Service Information    |          |
|------------------------------|------------------------------|------------------------|----------|
| IMEI                         | 869257030005710              | Access Technology      | LTE-A    |
| Module SW Version            | EG06ALAR02A05M4G_BETA1228    | Band                   | LTE_BC2  |
| <b>SIM Status</b>            |                              | RSSI                   | -34      |
| SIM Card Status              | Available                    | Cell ID                | 11       |
| IMSI                         | 001010123456782              | RFCN                   | 900      |
| ICCID                        | 89861411140951919824         | RSRP                   | -63      |
| PIN Protection               | Disable                      | RSRQ                   | -9       |
| PIN Remaining Attempts       | 3                            | RSCP                   | N/A      |
| <b>IP Passthrough Status</b> |                              | EcNo                   | N/A      |
| IP Passthrough Enable        | Disable                      | TAC                    | 11       |
| <b>Cellular Status</b>       |                              | LAC                    | N/A      |
| Cellular Status              | Up                           | RAC                    | N/A      |
| Data Roaming                 | Enable                       | BSIC                   | N/A      |
| Operator                     | MD8475A SmartStudio MAI TEST | SINR                   | 25       |
| PLMN                         | 101                          | CQI                    | 0        |
|                              |                              | MCS                    | 28       |
|                              |                              | RI                     | 1        |
|                              |                              | <b>SCC Information</b> |          |
|                              |                              | Cell ID                | 22       |
|                              |                              | RFCN                   | 8865     |
|                              |                              | Band                   | LTE_BC26 |
|                              |                              | RSSI                   | -31      |
|                              |                              | RSRP                   | -61      |
|                              |                              | RSRQ                   | -10      |
|                              |                              | SINR                   | 30       |

The following table describes the labels in this screen.

Table 64 System Monitor > Cellular WAN Status

| LABEL              | DESCRIPTION   |
|--------------------|---|
| Refresh Interval   | Select the time interval the Zyxel Device will check and refresh the fields shown on this screen. Select <b>None</b> to stop detection. |
| Module Information |   |
| IMEI               | This shows the International Mobile Equipment Identity of the Zyxel Device.   |
| Module SW Version  | This shows the software version of the Zyxel Device.  |
| SIM Status         |   |

Table 64 System Monitor &gt; Cellular WAN Status (continued)

| LABEL                  | DESCRIPTION   |
|------------------------|---|
| SIM Card Status        | This displays the SIM card status:<br><br><b>None</b> - the Zyxel Device does not detect that there is a SIM card inserted.<br><br><b>Available</b> - the SIM card could either have or doesn't have PIN code security.<br><br><b>Locked</b> - the SIM card has PIN code security, but you did not enter the PIN code yet.<br><br><b>Blocked</b> - you entered an incorrect PIN code too many times, so the SIM card has been locked; call the ISP for a PUK (Pin Unlock Key) to unlock the SIM card.<br><br><b>Error</b> - the Zyxel Device detected that the SIM card has errors.                   |
| IMSI                   | This displays the International Mobile Subscriber Identity (IMSI) of the installed SIM card. An IMSI is a unique ID used to identify a mobile subscriber in a mobile network.   |
| ICCID                  | Integrated Circuit Card Identifier ( <b>ICCID</b> ). This is the serial number of the SIM card.   |
| PIN Protection         | A PIN (Personal Identification Number) code is a key to a SIM card. Without the PIN code, you cannot use the SIM card.<br><br>Shows <b>Enable</b> if the service provider requires you to enter a PIN to use the SIM card.<br><br>Shows <b>Disable</b> if the service provider lets you use the SIM without inputting a PIN.  |
| PIN Remaining Attempts | This is how many more times you can try to enter the PIN code before the ISP blocks your SIM card.  |
| IP Passthrough Status  |   |
| Cellular Status        | This displays the status of the cellular Internet connection.   |
| Data Roaming           | This displays if data roaming is enabled on the Zyxel Device.<br><br>4G roaming is to use your Zyxel Device in an area which is not covered by your service provider. Enable roaming to ensure that your Zyxel Device is kept connected to the Internet when you are traveling outside the geographical coverage area of the network to which you are registered.   |
| Operator               | This displays the name of the service provider.   |
| PLMN                   | This displays the PLMN number.  |
| Access Technology      | This displays the type of the mobile network (such as LTE, UMTS, GSM) to which the Zyxel Device is connecting.  |
| Band                   | This displays the current LTE band of your Zyxel Device (WCDMA2100).  |
| RSSI                   | This displays the strength of the WiFi signal between an associated wireless station and an AP.<br><br>The normal range is -30dBm to -79dBm. If the value drops below -80dBm, try moving the associated wireless station closer to the Zyxel Device to get better signal strength.  |
| Cell ID                | This shows the cell ID, which is a unique number used to identify the Base Transceiver Station to which the Zyxel Device is connecting.<br><br>The value depends on the Current Access Technology: <ul style="list-style-type: none"> <li>• For GPRS, it is the Cell Identity as specified in 3GPP-TS.25.331.</li> <li>• For UMTS, it is the Cell Identity as defined in SIB3 3GPP-TS.25.331, 3GPP-TS.24.008.</li> <li>• For LTE, it is the 28-bit binary number Cell Identity as specified in SIB1 in 3GPP-TS.36.331.</li> </ul> The value is '0' (zero) or 'N/A' if there is no network connection. |

Table 64 System Monitor &gt; Cellular WAN Status (continued)

| LABEL | DESCRIPTION  |
|-------|--|
| RFCN  | <p>This displays the Radio Frequency Channel Number of DL carrier frequency used by the mobile network to which the Zyxel Device is connecting.</p> <p>The value depends on the Current Access Technology:</p> <ul style="list-style-type: none"> <li>For GPRS, it is the ARFCN (Absolute Radio-Frequency Channel Number) as specified in 3GPP-TS.45.005.</li> <li>For UMTS, it is the UARFCN (UTRA Absolute Radio-Frequency Channel Number) as specified in 3GPP-TS.25.101.</li> <li>For LTE, it is the EARFCN (E-UTRA Absolute Radio-Frequency Channel Number) as specified in 3GPP-TS.36.101.</li> </ul> <p>The value is '0' (zero) or 'N/A' if there is no network connection.</p> |
| RSRP  | <p>This displays the Reference Signal Receive Power (RSRP), which is the average received power of all Resource Element (RE) that carry cell-specific Reference Signals (RS) within the specified bandwidth.</p> <p>The received RSRP level of the connected E-UTRA cell, in dBm, is as specified in 3GPP-TS.36.214. The reporting range is specified in 3GPP-TS.36.133.</p> <p>An undetectable signal is indicated by the lower limit, example -140 dBm.</p> <p>This parameter is for LTE only. The normal range is -30 to -140. The value is -140 if the Current Access Technology is not LTE. The value is 'N/A' if there is no network connection.</p>                             |
| RSRQ  | <p>This displays the Reference Signal Receive Quality (RSRQ), which is the ratio of RSRP to the E-UTRA carrier RSSI and indicates the quality of the received reference signal.</p> <p>The received RSRQ level of the connected E-UTRA cell, in 0.1 dB, is as specified in 3GPP-TS.36.214. An undetectable signal is indicated by the lower limit, example -240.</p> <p>This parameter is for LTE only. The normal range is -30 to -240. The value is -240 if the Current Access Technology is not LTE. The value is 'N/A' if there is no network connection.</p>  |
| RSCP  | <p>This displays the Received Signal Code Power, which measures the power of channel used by the Zyxel Device.</p> <p>The received signal level, in dBm, is of the CPICH channel (Ref. 3GPP TS 25.133). An undetectable signal is indicated by the lower limit, example -120 dBm.</p> <p>This parameter is for UMTS only. The normal range is -30 to -120. The value is -120 if the Current Access Technology is not UMTS. The value is 'N/A' if there is no network connection.</p>   |
| EcNo  | <p>This displays the ratio (in dB) of the received energy per chip and the interference level.</p> <p>The measured EcNo is in 0.1 dB and is received in the downlink pilot channel. An undetectable signal is indicated by the lower limit, example -240 dB.</p> <p>This parameter is for UMTS only. The normal range is -30 to -240. The value is -240 if the Current Access Technology is not UMTS or there is no network connection.</p>  |
| TAC   | <p>This displays the Tracking Area Code (TAC), which is used to identify the country of a mobile subscriber.</p> <p>The physical cell ID of the connected E-UTRAN cell, is as specified in 3GPP-TS.36.101.</p> <p>This parameter is for LTE only. The value is '0' (zero) or 'N/A' if the Current Access Technology is not LTE or there is no network connection.</p>  |
| LAC   | <p>This displays the 2-octet Location Area Code (LAC), which is used to identify a location area within a PLMN.</p> <p>The LAC of the connected cell is as defined in SIB 1 [3GPP-TS.25.331]. The concatenation of PLMN ID (MCC+MNC) and LAC uniquely identifies the LAI (Location Area ID) [3GPP-TS.23.003].</p> <p>This parameter is for UMTS or GPRS. The value is '0' (zero) if the Current Access Technology is not UMTS or GPRS. The value is 'N/A' if there is no network connection.</p>   |

Table 64 System Monitor &gt; Cellular WAN Status (continued)

| LABEL | DESCRIPTION   |
|-------|---|
| RAC   | <p>This displays the RAC (Routing Area Code), which is used in mobile network "packet domain service" (PS) to identify a routing area within a location area.</p> <p>In a mobile network, it uses LAC (Location Area Code) to identify the geographical location for the old 3G voice only service, and use RAC to identify the location of data service like HSDPA or LTE.</p> <p>The RAC of the connected UTRAN cell is as defined in SIB 1 [3GPP-TS.25.331]. The concatenation of PLMN ID (MCC+MNC), LAC, and RAC uniquely identifies the RAI (Routing Area ID) [3GPP-TS.23.003].</p> <p>This parameter is for UMTS or GPRS. The value is '0' (zero) if the Current Access Technology is not UMTS or GPRS. The value is 'N/A' if there is no network connection.</p> |
| BSIC  | <p>The Base Station Identity Code (BSIC), which is a code used in GSM to uniquely identify a base station.</p> <p>This parameter is for GPRS only. The value is '0' (zero) if the Current Access Technology is not GPRS. The value is 'N/A' if there is no network connection.</p>  |
| SINR  | <p>This displays the Signal to Interference plus Noise Ratio (SINR) in dB. This is also a measure of signal quality and used by the UE (User Equipment) to calculate the Channel Quality Indicator (CQI) that it reports to the network. A negative value means more noise than signal.</p>   |
| CQI   | <p>This displays the Channel Quality Indicator (CQI). It is an indicator carrying the information on how good/bad the communication channel quality is.</p>   |
| MCS   | <p>MCS stands for Modulation and Coding Scheme. This is an 802.11n feature that increases the wireless network performance in terms of throughput.</p>  |
| RI    | <p>This displays the Rank Indication, one of the control information that a UE will report to eNodeB (Evolved Node-B) on either PUCCH (Physical Uplink Control Channel) or PUSCH (Physical Uplink Shared Channel) based on uplink scheduling.</p>   |

# CHAPTER 19

## System

### 19.1 System Overview

Give a name to your Zyxel Device (host) and an associated domain name for identification purposes.

### 19.2 System

Click **Maintenance > System** to open the following screen. Assign a unique name so it can be easily recognized on your network. You can use up to 30 characters, including spaces.

**Figure 112** Maintenance > System

**System**

Give a name to your Zyxel Device (host) and an associated domain name for identification purposes.  
Assign a unique name so it can be easily recognized on your network. You can use up to 30 characters, including spaces.

Host Name: LTE7240-M403

Domain Name: home

Cancel Apply

The following table describes the labels in this screen.

**Table 65** Maintenance > System

| LABEL       | DESCRIPTION  |
|-------------|--|
| Host Name   | Type a host name for your Zyxel Device. Enter a descriptive name of up to 16 alphanumeric characters, not including spaces, underscores, and dashes. |
| Domain Name | Type a Domain name for your host Zyxel Device.   |
| Cancel      | Click <b>Cancel</b> to abandon this screen without saving.   |
| Apply       | Click <b>Apply</b> to save your changes.   |



# CHAPTER 20

## User Account

### 20.1 User Account Overview

View the settings of the "admin" and other user accounts that you use to log into the Zyxel Device.

### 20.2 User Account

Click **Maintenance > User Account** to open the following screen. Create or manage user accounts and their privileges on the Zyxel Device.

**Figure 113** Maintenance > User Account

| # | Active                              | User Name | Retry Times | Idle Timeout | Lock Period | Group         | Modify |
|---|-------------------------------------|-----------|-------------|--------------|-------------|---------------|--------|
| 1 | <input checked="" type="checkbox"/> | admin     | 0           | 60           | 5           | Administrator |        |
| 2 | <input checked="" type="checkbox"/> | User-S    | 0           | 60           | 5           | User          |        |

The following table describes the labels in this screen.

**Table 66** Maintenance > User Account

| LABEL           | DESCRIPTION   |
|-----------------|---|
| Add New Account | Click this button to add a new user account (up to 4 <b>Administrator</b> accounts and 4 <b>User</b> accounts).   |
| #               | This is the index number.   |
| Active          | This indicates whether the user account is active or not.<br>The check box is selected when the user account is enabled. It is cleared when it is disabled. |
| User Name       | This displays the name of the account used to log into the Zyxel Device Web Configurator.   |
| Retry Times     | This displays the number of times consecutive wrong passwords can be entered for this account. 0 means there is no limit.                                   |
| Idle Timeout    | This displays the length of inactive time before the Zyxel Device will automatically log the user out of the Web Configurator.                              |

Table 66 Maintenance &gt; User Account (continued)

| LABEL       | DESCRIPTION  |
|-------------|--|
| Lock Period | This field displays the length of time a user must wait before attempting to log in again after a number of consecutive wrong passwords have been entered as defined in <b>Retry Times</b> . |
| Group       | This field displays whether this user has <b>Administrator</b> or <b>User</b> privileges.  |
| Modify      | Click the <b>Edit</b> icon to configure the entry.<br>Click the <b>Delete</b> icon to remove the entry.  |
| Cancel      | Click <b>Cancel</b> to restore your previously saved settings.   |
| Apply       | Click <b>Apply</b> to save your changes.   |

## 20.2.1 User Account Add/Edit

Add or change the name of the user account, set the security password and the retry times, and whether this user will have **Administrator** or **User** privileges. Click **Add New Account** or the **Edit** icon of an existing account in the **Maintenance > User Account** to open the following screen.

Figure 114 Maintenance &gt; User Account &gt; Add/Edit

The following table describes the labels in this screen.

Table 67 Maintenance &gt; User Account &gt; Add/Edit

| LABEL           | DESCRIPTION   |
|-----------------|---|
| Active          | Click to enable (switch turns blue) or disable (switch turns gray) to activate or deactivate the user account.  |
| User Name       | Enter a new name for the account (up to 15 characters). Special characters are allowed except the following: double quote (") back quote (`) apostrophe or single quote (') less than (<) greater than (>) caret or circumflex accent (^) dollar sign (\$) vertical bar ( ) ampersand (&) semicolon (;) |
| Password        | Type your new system password (up to 256 characters). Note that as you type a password, the screen displays a (*) for each character you type. After you change the password, use the new password to access the Zyxel Device.  |
| Verify Password | Type the new password again for confirmation.   |

Table 67 Maintenance &gt; User Account &gt; Add/Edit (continued) (continued)

| LABEL        | DESCRIPTION  |
|--------------|--|
| Retry Times  | Enter the number of times consecutive wrong passwords can be entered for this account. 0 means there is no limit.  |
| Idle Timeout | Enter the length of inactive time before the Zyxel Device will automatically log the user out of the Web Configurator.   |
| Lock Period  | Enter the length of time a user must wait before attempting to log in again after a number of consecutive wrong passwords have been entered as defined in <b>Retry Times</b> .   |
| Group        | <p>Specify whether this user will have <b>Administrator</b> or <b>User</b> privileges.</p> <p>The <b>Administrator</b> privileges are the following:</p> <ul style="list-style-type: none"> <li>• <b>Quick Start</b> setup.</li> <li>• The following screens are visible for setup:<br/><b>Broadband, Wireless, Home Networking, Routing, NAT, DNS, Firewall, MAC Filter, Certificates, Log, Traffic Status, ARP Table, Routing Table, Cellular WAN Status, System, User Account, Remote Management, TR-069 Client, Time, Email Notification, Log Setting, Firmware Upgrade, Backup/Restore, Reboot, Diagnostic.</b></li> </ul> <p>The <b>User</b> privileges are the following:</p> <ul style="list-style-type: none"> <li>• The following screens are visible for setup:<br/><b>Log, Traffic Status, ARP Table, Routing Table, Cellular WAN Status, User Account, Remote Management, Time, Email Notification, Log Setting, Firmware Upgrade, Backup/Restore, Reboot, Diagnostic.</b></li> </ul> |
| Cancel       | Click <b>Cancel</b> to restore your previously saved settings.   |
| OK           | Click <b>OK</b> to save your changes.  |

# CHAPTER 21

## Remote Management

### 21.1 Overview

Remote management controls through which interface(s), which web services (such as HTTP, HTTPS, FTP, Telnet, SSH and Ping) can access the Zyxel Device.

Note: The Zyxel Device is managed using the Web Configurator.

### 21.2 MGMT Services

Note: The **MGMT Services** screen will be hidden if you enable the **IP Passthrough** function in **Network Setting > Broadband > Cellular IP Passthrough** screen.

Configure which interface(s) you can use to access the Zyxel Device for a given service. You can also specify the service port numbers computers must use to connect to the Zyxel Device. Click **Maintenance > Remote Management** to open the following screen.

Figure 115 Maintenance > Remote Management

Configure which interface(s) you can use to access the Zyxel Device for a given service. You can also specify the service port numbers computers must use to connect to the Zyxel Device.

**Service Control**

WAN Interface used for services:  Any\_WAN  Multi\_WAN

Cellular WAN

| Service | LAN/WLAN                                   | WAN                             | Trust Domain                    | Port |
|---------|--|---------------------------------|---------------------------------|------|
| HTTP    | <input checked="" type="checkbox"/> Enable | <input type="checkbox"/> Enable | <input type="checkbox"/> Enable | 80   |
| HTTPS   | <input checked="" type="checkbox"/> Enable | <input type="checkbox"/> Enable | <input type="checkbox"/> Enable | 443  |
| FTP     | <input checked="" type="checkbox"/> Enable | <input type="checkbox"/> Enable | <input type="checkbox"/> Enable | 21   |
| TELNET  | <input checked="" type="checkbox"/> Enable | <input type="checkbox"/> Enable | <input type="checkbox"/> Enable | 23   |
| SSH     | <input checked="" type="checkbox"/> Enable | <input type="checkbox"/> Enable | <input type="checkbox"/> Enable | 22   |
| PING    | <input checked="" type="checkbox"/> Enable | <input type="checkbox"/> Enable | <input type="checkbox"/> Enable |      |

Cancel Apply

The following table describes the fields in this screen.

Table 68 Maintenance > Remote Management

| LABEL                           | DESCRIPTION   |
|---------------------------------|---|
| WAN Interface used for services | Select <b>Any_WAN</b> to have the Zyxel Device automatically activate the remote management service when any WAN connection is up.<br><br>Select <b>Multi_WAN</b> and then select one or more WAN connections to have the Zyxel Device activate the remote management service when the selected WAN connections are up. |
| Cellular WAN                    | Enable the LTE WAN connection configured in <b>Network Setting &gt; Broadband &gt; Cellular WAN</b> to access the service on the Zyxel Device.  |
| Service                         | This is the service you may use to access the Zyxel Device.   |
| LAN/WLAN                        | Select the <b>Enable</b> check box for the corresponding services that you want to allow access to the Zyxel Device from the LAN/WLAN.  |
| WAN                             | Select the <b>Enable</b> check box for the corresponding services that you want to allow access to the Zyxel Device from all WAN connections.   |
| Trust Domain                    | Select the <b>Enable</b> check box for the corresponding services that you want to allow access to the Zyxel Device from the trusted host IP address.   |
| Port                            | You may change the server port number for a service if needed, however you must use the same port number in order to use that service for remote management.  |
| Apply                           | Click <b>Apply</b> to save your changes back to the Zyxel Device.   |
| Cancel                          | Click <b>Cancel</b> to restore your previously saved settings.  |

## 21.3 MGMT Services for IP Passthrough

Configure which interface(s) you can use to access the Zyxel Device in **IP Passthrough** mode (bridge mode) for a given service. You can also specify the service port numbers computers must use to connect to the Zyxel Device. IP Passthrough allows Internet traffic to go to a LAN computer behind the Zyxel Device without going through NAT. Make sure to enable IP Passthrough in **Network Setting > Broadband > Cellular IP Passthrough**. See [Section 5.6 on page 44](#) for details.

Click **Maintenance > Remote Management > MGMT Services for IP Passthrough** to open the following screen.

Figure 116 Maintenance > Remote Management > MGMT Services for IP Passthrough

Configure which interface(s) you can use to access the Zyxel Device in **IP Passthrough** mode (bridge mode) for a given service. You can also specify the service port numbers computers must use to connect to the Zyxel Device. IP Passthrough allows Internet traffic to go to a LAN computer behind the Zyxel Device without going through NAT. Make sure to enable IP Passthrough in **Network Setting > Broadband > Cellular IP Passthrough**.

**Service Control**

| Service   | WAN  | Port  |
|-----------|--|-------|
| PT_HTTP   | <input checked="" type="checkbox"/> Enable | 20080 |
| PT_HTTPS  | <input checked="" type="checkbox"/> Enable | 20443 |
| PT_FTP    | <input type="checkbox"/> Enable            | 20021 |
| PT_TELNET | <input type="checkbox"/> Enable            | 20023 |
| PT_SSH    | <input type="checkbox"/> Enable            | 20022 |

The following table describes the fields in this screen.

Table 69 Maintenance > Remote Management > MGMT Services for IP Passthrough

| LABEL   | DESCRIPTION  |
|---------|--|
| Service | This is the service you may use to access the Zyxel Device.  |
| WAN     | Select the <b>Enable</b> check box for the corresponding services that you want to allow access to the Zyxel Device from all WAN connections.                |
| Port    | You may change the server port number for a service if needed, however you must use the same port number in order to use that service for remote management. |
| Apply   | Click <b>Apply</b> to save your changes back to the Zyxel Device.  |
| Cancel  | Click <b>Cancel</b> to restore your previously saved settings.   |

## 21.4 Trust Domain

View a list of public IP addresses which you want to allow access to the Zyxel Device through the services configured in this screen. Click **Maintenance > Remote Management > Trust Domain** to open the following screen.

Note: If this list is empty, all public IP addresses can access the Zyxel Device from the WAN through the specified services.

Figure 117 Maintenance > Remote Management > Trust Domain

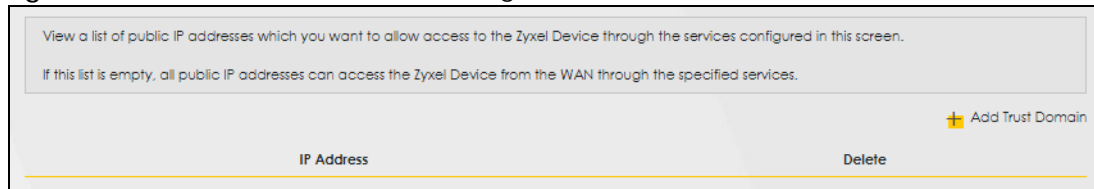

The following table describes the fields in this screen.

Table 70 Maintenance > Remote Management > Trust Domain

| LABEL            | DESCRIPTION   |
|------------------|---|
| Add Trust Domain | Click this to add a trusted host IP address.                        |
| IP Address       | This field shows a trusted host IP address.                         |
| Delete           | Click the <b>Delete</b> icon to remove the trusted host IP address. |

## 21.5 Add Trust Domain

Configure a public IP address which you want to allow access to the Zyxel Device. Click the **Add Trust Domain** button in the **Maintenance > Remote Management > Trust Domain** screen to open the following screen.

**Figure 118** Maintenance > Remote Management > Trust Domain > Add Trust Domain

The following table describes the fields in this screen.

**Table 71** Maintenance > Remote Management > Trust Domain > Add Trust Domain

| LABEL      | DESCRIPTION  |
|------------|--|
| IP Address | Enter a public IPv4/IPv6 IP address which is allowed to access the service on the Zyxel Device from the WAN. |
| OK         | Click <b>OK</b> to save your changes back to the Zyxel Device.   |
| Cancel     | Click <b>Cancel</b> to restore your previously saved settings.   |

# CHAPTER 22

## TR-069 Client

### 22.1 Overview

This chapter explains how to configure the Zyxel Device's TR-069 auto-configuration settings.

### 22.2 TR-069 Client

TR-069 defines how Customer Premise Equipment (CPE), for example your Zyxel Device, can be managed over the WAN by an Auto Configuration Server (ACS). TR-069 is based on sending Remote Procedure Calls (RPCs) between an ACS and a client device. RPCs are sent in Extensible Markup Language (XML) format over HTTP or HTTPS.

An administrator can use an ACS to remotely set up the Zyxel Device, modify settings, perform firmware upgrades as well as monitor and diagnose the Zyxel Device. You have to enable the device to be managed by the ACS and specify the ACS IP address or domain name and username and password.

Allow your Zyxel Device to be managed remotely by an Auto Configuration Server (ACS) using TR-069.

Click **Maintenance > TR-069 Client** to open the following screen.



Figure 119 Maintenance &gt; TR-069 Client

The following table describes the fields in this screen.

Table 72 Maintenance &gt; TR-069 Client

| LABEL           | DESCRIPTION   |
|-----------------|---|
| CWMP Active     | CPE WAN Management Protocol (CWMP) enables the Zyxel Device to be remotely configured via a WAN link. Communication between the Zyxel Device and the management server is conducted via SOAP/HTTP(S) in the form of remote procedure calls (RPC).<br><br>Click to enable (switch turns blue) to allow the Zyxel Device to be managed by a management server. Otherwise, click to disable (switch turns gray) to disallow the Zyxel Device to be managed by a management server. |
| Inform          | Click to enable (switch turns blue) the Zyxel Device to send periodic inform via TR-069 on the WAN. Otherwise, click to disable (switch turns gray).  |
| Inform Interval | Enter the time interval (in seconds) at which the Zyxel Device sends information to the auto-configuration server.  |
| IP Protocol     | Select the type of IP protocol to allow TR-069 to operate on.   |
| ACS URL         | Enter the URL or IP address of the auto-configuration server.   |
| ACS User Name   | Enter the TR-069 user name for authentication with the auto-configuration server.   |
| ACS Password    | Enter the TR-069 password for authentication with the auto-configuration server.  |

Table 72 Maintenance &gt; TR-069 Client (continued)

| LABEL                                   | DESCRIPTION  |
|---|--|
| WAN Interface used by TR-069 client     | <p>Select a WAN interface through which the TR-069 traffic passes.</p> <p>If you select <b>Any_WAN</b>, the Zyxel Device automatically passes the TR-069 traffic when any WAN connection is up.</p> <p>If you select <b>Multi_WAN</b>, you also need to select two or more pre-configured WAN interfaces. The Zyxel Device automatically passes the TR-069 traffic when one of the selected WAN connections is up.</p> |
| Cellular WAN                            | The Zyxel Device automatically passes the TR-069 traffic when cellular WAN connection is up.   |
| Display SOAP messages on serial console | Click to enable (switch turns blue) the dumping of all SOAP messages during the ACS server communication with the CPE.   |
| Connection Request Authentication       | Select this option to enable authentication when there is a connection request from the ACS.   |
| Connection Request User Name            | <p>Enter the connection request user name.</p> <p>When the ACS makes a connection request to the Zyxel Device, this user name is used to authenticate the ACS.</p>   |
| Connection Request Password             | <p>Enter the connection request password.</p> <p>When the ACS makes a connection request to the Zyxel Device, this password is used to authenticate the ACS.</p>   |
| Connection Request URL                  | <p>This shows the connection request URL.</p> <p>The ACS can use this URL to make a connection request to the Zyxel Device.</p>  |
| Validate ACS Certificate                | Click to enable (switch turns blue) the validation of a local certificate used by TR-069 client.   |
| Local certificate used by TR-069 client | You can choose a local certificate used by TR-069 client. The local certificate should be imported in the <b>Security &gt; Certificates &gt; Local Certificates</b> screen.  |
| Apply                                   | Click <b>Apply</b> to save your changes.   |
| Cancel                                  | Click <b>Cancel</b> to restore the screen's last saved settings.   |

# CHAPTER 23

## Time Settings

### 23.1 Time Settings Overview

This chapter shows you how to configure system related settings, such as system time, password, name, the domain name and the inactivity timeout interval.

### 23.2 Time

Configure the Zyxel Device's time based on your local time zone. You can add a time server address, select your time zone, and configure Daylight Savings if your location uses it.

To change your Zyxel Device's time and date, click **Maintenance > Time**. The screen appears as shown.

Figure 120 Maintenance &gt; Time

Configure the Zyxel Device's time based on your local time zone. You can add a time server address, select your time zone, and configure Daylight Savings if your location uses it.

**Current Date/Time**

Current Time 14:21:53  
Current Date 2019-02-27

**Time and Date Setup**

Time Protocol SNTP (RFC-1769)

First Time Server Address pool.ntp.org  
Second Time Server Address clock.nyc.he.net  
Third Time Server Address clock.sjc.he.net  
Fourth Time Server Address None  
Fifth Time Server Address None

**Time Zone**

Time Zone (GMT+08:00) Taipei

**Daylight Savings**

Active

**Start Rule**

Day  1 in  
 Last Sunday in

Month March  
Hour 2 0

**End Rule**

Day  1 in  
 Last Sunday in

Month October  
Hour 3 0

Cancel Apply

The following table describes the fields in this screen.

Table 73 Maintenance &gt; Time

| LABEL               | DESCRIPTION  |
|---------------------|--|
| Current Date/Time   |  |
| Current Time        | This displays the time of your Zyxel Device.<br>Each time you reload this screen, the Zyxel Device synchronizes the time with the time server. |
| Current Date        | This displays the date of your Zyxel Device.<br>Each time you reload this screen, the Zyxel Device synchronizes the date with the time server. |
| Time and Date Setup |  |
| Time Protocol       | This displays the time protocol used by your Zyxel Device.   |

Table 73 Maintenance &gt; Time (continued)

| LABEL                             | DESCRIPTION  |
|-----------------------------------|--|
| First ~ Fifth Time Server Address | <p>Select an NTP time server from the drop-down list box.</p> <p>Otherwise, select <b>Other</b> and enter the IP address or URL (up to 29 extended ASCII characters in length) of your time server.</p> <p>Select <b>None</b> if you don't want to configure the time server.</p> <p>Check with your ISP/network administrator if you are unsure of this information.</p>  |
| Time Zone                         |  |
| Time zone                         | Choose the time zone of your location. This will set the time difference between your time zone and Greenwich Mean Time (GMT).   |
| Daylight Savings                  | Daylight Saving Time is a period from late spring to early fall when many countries set their clocks ahead of normal local time by one hour to give more daytime light in the evening.   |
| Active                            | Click this switch to enable or disable Daylight Saving Time. When the switch turns blue  , the function is enabled. Otherwise, it's not.  |
| Start Rule                        | <p>Configure the day and time when Daylight Saving Time starts if you enabled Daylight Saving. You can select a specific date in a particular month or a specific day of a specific week in a particular month. The <b>Time</b> field uses the 24 hour format. Here are a couple of examples:</p> <p>Daylight Saving Time starts in most parts of the United States on the second Sunday of March. Each time zone in the United States starts using Daylight Saving Time at 2 A.M. local time. So in the United States, set the day to <b>Second, Sunday</b>, the month to <b>March</b> and the time to <b>2</b> in the <b>Hour</b> field.</p> <p>Daylight Saving Time starts in the European Union on the last Sunday of March. All of the time zones in the European Union start using Daylight Saving Time at the same moment (1 A.M. GMT or UTC). So in the European Union you would set the day to <b>Last, Sunday</b> and the month to <b>March</b>. The time you select in the <b>o'clock</b> field depends on your time zone. In Germany for instance, you would select <b>2</b> in the <b>Hour</b> field because Germany's time zone is one hour ahead of GMT or UTC (GMT+1).</p> |
| End Rule                          | <p>Configure the day and time when Daylight Saving Time ends if you enabled Daylight Saving. You can select a specific date in a particular month or a specific day of a specific week in a particular month. The <b>Time</b> field uses the 24 hour format. Here are a couple of examples:</p> <p>Daylight Saving Time ends in the United States on the first Sunday of November. Each time zone in the United States stops using Daylight Saving Time at 2 A.M. local time. So in the United States you would set the day to <b>First, Sunday</b>, the month to <b>November</b> and the time to <b>2</b> in the <b>Hour</b> field.</p> <p>Daylight Saving Time ends in the European Union on the last Sunday of October. All of the time zones in the European Union stop using Daylight Saving Time at the same moment (1 A.M. GMT or UTC). So in the European Union you would set the day to <b>Last, Sunday</b>, and the month to <b>October</b>. The time you select in the <b>o'clock</b> field depends on your time zone. In Germany for instance, you would select <b>2</b> in the <b>Hour</b> field because Germany's time zone is one hour ahead of GMT or UTC (GMT+1).</p>     |
| Cancel                            | Click <b>Cancel</b> to exit this screen without saving.  |
| Apply                             | Click <b>Apply</b> to save your changes.   |

# CHAPTER 24

## Email Notification

### 24.1 Email Notification Overview

A mail server is an application or a computer that can receive, forward and deliver email messages.

To have the Zyxel Device send reports, logs or notifications via email, you must specify an email server and the email addresses of the sender and receiver.

### 24.2 Email Notification

View, remove and add email account information on the Zyxel Device. This account can be set to send email notifications for logs.

Click **Maintenance > Email Notification** to open the **Email Notification** screen.

Note: The default port number of the mail server is 25.

**Figure 121** Maintenance > Email Notification

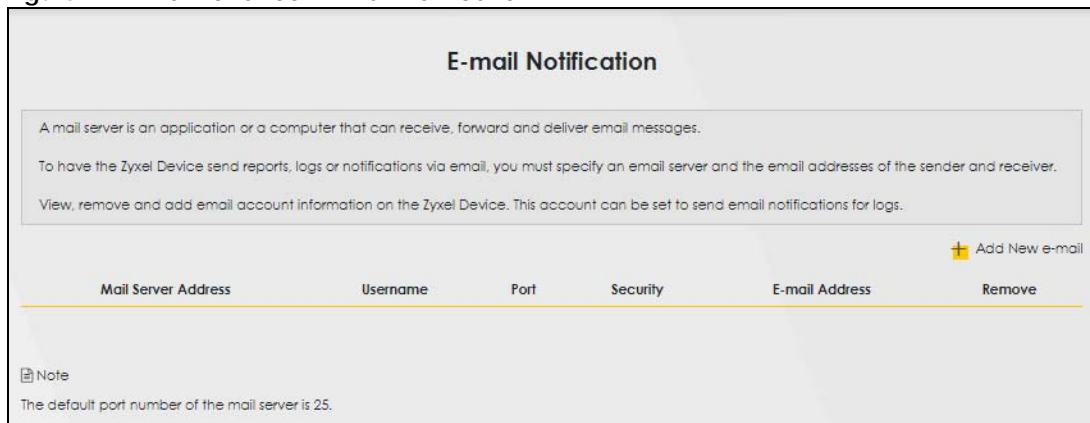

The following table describes the labels in this screen.

Table 74 Maintenance > Email Notification

| LABEL               | DESCRIPTION   |
|---------------------|---|
| Add New email       | Click this button to create a new entry (up to 32 can be created).  |
| Mail Server Address | This displays the server name or the IP address of the mail server. |
| User name           | This displays the user name of the sender's mail account.           |
| Port                | This field displays the port number of the mail server.             |
| Security            | This field displays the protocol used for encryption.               |

Table 74 Maintenance &gt; Email Notification (continued)

| LABEL         | DESCRIPTION   |
|---------------|---|
| Email Address | This field displays the email address that you want to be in the from/sender line of the email that the Zyxel Device sends. |
| Remove        | Click this button to delete the selected entry(ies).  |

## 24.2.1 Email Notification Edit

Click the **Add** button in the **Email Notification** screen. Use this screen to configure the required information for sending email via a mail server.

Figure 122 Email Notification &gt; Add

The following table describes the labels in this screen.

Table 75 Email Notification &gt; Add

| LABEL                    | DESCRIPTION  |
|--------------------------|--|
| Mail Server Address      | Enter the server name or the IP address of the mail server for the email address specified in the <b>Account email Address</b> field.<br>If this field is left blank, reports, logs or notifications will not be sent via email.                     |
| Port                     | Enter the same port number here as is on the mail server for mail traffic.   |
| Authentication User name | Enter the user name (up to 32 characters). This is usually the user name of a mail account you specified in the <b>Account email Address</b> field.  |
| Authentication Password  | Enter the password associated with the user name above.  |
| Account email Address    | Enter the email address that you want to be in the from/sender line of the email notification that the Zyxel Device sends.<br>If you activate SSL/TLS authentication, the email address must be able to be authenticated by the mail server as well. |

Table 75 Email Notification &gt; Add (continued)

| LABEL               | DESCRIPTION   |
|---------------------|---|
| Connection Security | Select <b>SSL</b> to use Secure Sockets Layer (SSL) or Transport Layer Security (TLS) if you want encrypted communications between the mail server and the Zyxel Device.<br>Select <b>STARTTLS</b> to upgrade a plain text connection to a secure connection using SSL/TLS. |
| Cancel              | Click this button to begin configuring this screen afresh.  |
| OK                  | Click this button to save your changes and return to the previous screen.   |



# CHAPTER 25

## Log Setting

### 25.1 Log Setting Overview

You can configure where the Zyxel Device sends logs and which logs and/or immediate alerts the Zyxel Device records.

### 25.2 Log Setting

If there is a LAN client on your network or a remote server that is running a syslog utility, you can save log files from LAN computers to it by enabling **Syslog Logging**, selecting **Remote** or **Local File and Remote** in the **Mode** field, and entering the IP address of the syslog server in the **Syslog Server** field. **Remote** allows you to store logs on a syslog server, while **Local File** allows you to store them on the Zyxel Device. **Local File and Remote** means your logs are stored both on the Zyxel Device and on a syslog server. To change your Zyxel Device's log settings, click **Maintenance > Log Setting**. The screen appears as shown.

Figure 123 Maintenance > Log Setting

### Log Setting

You can configure where the Zyxel Device sends logs and which logs and/or immediate alerts the Zyxel Device records.

If there is a LAN client on your network or a remote server that is running a syslog utility, you can save log files from LAN computers to it by enabling **Syslog Logging**, selecting **Remote** or **Local File and Remote** in the **Mode** field, and entering the IP address of the syslog server in the **Syslog Server** field. **Remote** allows you to store logs on a syslog server, while **Local File** allows you to store them on the Zyxel Device. **Local File and Remote** means your logs are stored both on the Zyxel Device and on a syslog server.

---

#### Syslog Setting

Syslog Logging

Mode: Local File

Syslog Server: 0 . 0 . 0 . 0 (Server NAME or IPv4/IPv6 Address)

UDP Port: 514 (Server Port)

---

#### E-mail Log Settings

E-mail Log Settings

Mail Account: Select one account

System Log Mail Subject:

Security Log Mail Subject:

Send Log to:  (E-Mail Address)

Send Alarm to:  (E-Mail Address)

Alarm Interval: 60 (seconds)

---

#### Active Log

**System Log**

WAN-DHCP

DHCP Server

TR-069

HTP

UPNP

System

ACL

Wireless

Cellular WAN

**Security Log**

Account

Attack

Firewall

MAC Filter

The following table describes the fields in this screen.

Table 76 Maintenance > Log Setting

| LABEL           | DESCRIPTION   |
|-----------------|---|
| Syslog Settings |   |
| Syslog Logging  | Click the switch (it will turn blue) to enable syslog logging.  |
| Mode            | <p>Select <b>Remote</b> to have the Zyxel Device send it to an external syslog server.</p> <p>Select <b>Local File</b> to have the Zyxel Device save the log file on the Zyxel Device itself.</p> <p>Select <b>Local File and Remote</b> to have the Zyxel Device save the log file on the Zyxel Device itself and send it to an external syslog server.</p> <p>Note: A warning appears upon selecting <b>Remote</b> or <b>Local File and Remote</b>. Just click <b>OK</b> to continue.</p> |

Table 76 Maintenance &gt; Log Setting (continued)

| LABEL                     | DESCRIPTION   |
|---------------------------|---|
| Syslog Server             | Enter the server name or IP address of the syslog server that will log the selected categories of logs.   |
| UDP Port                  | Enter the port number used by the syslog server.  |
| Email Log Settings        |   |
| Email Log Setting         | Click the switch (it will turn blue) to allow the sending via email the system and security logs to the email address specified in <b>Send Log to</b> .<br><br>Note: Make sure that the <b>Mail Server Address</b> field is not left blank in the <b>Maintenance &gt; Email Notifications</b> screen. |
| Mail Account              | Select a server specified in <b>Maintenance &gt; Email Notifications</b> to send the logs to.   |
| System Log Mail Subject   | This field allows you to enter a descriptive name for the system log email (for example Zyxel System Log). Up to 127 characters are allowed for the <b>System Log Mail Subject</b> including special characters inside the square brackets [!#%()*+,-./:=?@[{}~].                                     |
| Security Log Mail Subject | This field allows you to enter a descriptive name for the security log email (for example Zyxel Security Log). Up to 127 characters are allowed for the <b>Security Log Mail Subject</b> including special characters inside the square brackets [!#%()*+,-./:=?@[{}~].                               |
| Send Log to               | This field allows you to enter the log's designated email recipient. The log's format is plain text file sent as an email attachment.   |
| Send Alarm to             | This field allows you to enter the alarm's designated email recipient. The alarm's format is plain text file sent as an email attachment.   |
| Alarm Interval            | Select the frequency of showing of the alarm.   |
| Active Log                |   |
| System Log                | Select the categories of <b>System Logs</b> that you want to record.  |
| Security Log              | Select the categories of <b>Security Logs</b> that you want to record.  |
| Apply                     | Click <b>Apply</b> to save your changes.  |
| Cancel                    | Click <b>Cancel</b> to restore your previously saved settings.  |

# CHAPTER 26

## Firmware Upgrade

### 26.1 Overview

This chapter explains how to upload new firmware to your Zyxel Device. You can download new firmware releases from your nearest Zyxel FTP site (or [www.zyxel.com](http://www.zyxel.com)) to use to upgrade your Zyxel Device's performance.

**Only use firmware for your Zyxel Device's specific model. Refer to the label on the bottom of your Zyxel Device.**

### 26.2 Firmware Upgrade

Upload new firmware to your Zyxel Device by downloading the latest firmware file from the Zyxel website. Then, use this screen to upload it to your Zyxel Device. The upload process uses HTTP (Hypertext Transfer Protocol) and may take up to three minutes. After a successful upload, the Zyxel Device will reboot.

Click **Maintenance > Firmware Upgrade** to open the following screen.

**Do NOT turn off the Zyxel Device while firmware upload is in progress!**

**Figure 124** Maintenance > Firmware Upgrade

The screenshot shows a web interface titled "Firmware Upgrade". At the top, there is a heading "Firmware Upgrade". Below the heading is a text box containing instructions: "Upload new firmware to your Zyxel Device by downloading the latest firmware file from the Zyxel website. Then, use this screen to upload it to your Zyxel Device. The upload process uses HTTP (Hypertext Transfer Protocol) and may take up to three minutes. After a successful upload, the Zyxel Device will reboot." Below this text box, there are two sections. The first section is titled "Upgrade Firmware" and contains a checkbox labeled "Restore Default Settings After Firmware Upgrade" which is checked. Below the checkbox, it says "Current Firmware Version: 2.00(ABMG.0)C0". There is a "File Path" label, a "Choose File" button, and the text "No file chosen". To the right of these elements is a yellow "Upload" button. The second section is titled "Online Firmware Upgrade" and contains a yellow button labeled "Check for Latest Firmware Now".

The following table describes the labels in this screen.

Table 77 Maintenance > Firmware Upgrade

| LABEL   | DESCRIPTION  |
|---|--|
| Upgrade Firmware                                | Use these fields to upload firmware to the Zyxel Device.   |
| Restore Default Settings After Firmware Upgrade | Click to enable this option that restores the factory-default to the Zyxel Device after upgrading the firmware.<br><br>Note: Make sure to backup the Zyxel Device's configuration settings first in case the restore to factory-default process is not successful. Refer to <a href="#">Section 27.2 on page 174</a> . |
| Current Firmware Version                        | This is the present firmware version.  |
| File Path                                       | Type in the location of the file you want to upload in this field or click <b>Choose File</b> to find it.  |
| Choose File                                     | Click this to find the .bin file you want to upload. Remember that you must decompress compressed (.zip) files before you can upload them.   |
| Upload  | Click this to begin the upload process. This process may take up to three minutes.   |

After you see the firmware updating screen, wait a few minutes before logging into the Zyxel Device again.

The Zyxel Device automatically restarts in this time causing a temporary network disconnect. In some operating systems, you may see the following icon on your desktop.

Figure 125 Network Temporarily Disconnected

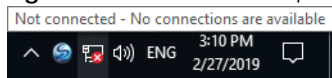

After two minutes, log in again and check your new firmware version in the **Status** screen.

If the upload was not successful, an error screen will appear. Click **OK** to go back to the **Firmware Upgrade** screen.

# CHAPTER 27

## Backup/Restore

### 27.1 Backup/Restore Overview

Back up and restore your Zyxel Device configurations. You can also reset your Zyxel Device settings back to the factory default.

### 27.2 Backup/Restore

Click **Maintenance > Backup/Restore**. Information related to factory defaults, backup configuration, and restoring configuration appears in this screen, as shown next.

**Figure 126** Maintenance > Backup/Restore

The screenshot shows a web interface titled "Backup/Restore". At the top, there is a header "Backup/Restore". Below the header, there is a text box containing the following information:

Back up and restore your Zyxel Device configurations. You can also reset your Zyxel Device settings back to the factory default.

**Backup Configuration** allows you to back up (save) the Zyxel Device's current configuration to a file on your computer. Once the Zyxel Device is configured and functioning properly, it is highly recommended that you back up your configuration file before making configuration changes. The backup configuration file will be useful in case you need to return to your previous settings.

**Restore Configuration** allows you to upload a new or previously saved configuration file from your computer to your Zyxel Device.

Below this text box, there are three sections:

- Backup Configuration**: Click Backup to save the current configuration of your system to your computer. A yellow "Backup" button is visible.
- Restore Configuration**: To restore a previously saved configuration file to your system, browse to the location of the configuration file and click Upload. A "File Path" input field is present, followed by a "Choose File" button, the text "No file chosen", and a yellow "Upload" button.
- Back to Factory Default Settings**: Click Reset to clear all user-entered configuration information and return to factory default settings. After resetting, the following settings will be reset:
  - Password will be 1234
  - LAN IP address will be 192.168.1.1
  - DHCP will be reset to default settingA yellow "Reset" button is visible.

#### Backup Configuration

**Backup Configuration** allows you to back up (save) the Zyxel Device's current configuration to a file on your computer. Once the Zyxel Device is configured and functioning properly, it is highly recommended

that you back up your configuration file before making configuration changes. The backup configuration file will be useful in case you need to return to your previous settings.

Click **Backup** to save the Zyxel Device's current configuration to your computer.

## Restore Configuration

**Restore Configuration** allows you to upload a new or previously saved configuration file from your computer to your Zyxel Device.

Table 78 Restore Configuration

| LABEL       | DESCRIPTION   |
|-------------|---|
| File Path   | Type in the location of the file you want to upload in this field or click <b>Choose File</b> to find it.                             |
| Choose File | Click this to find the file you want to upload. Remember that you must decompress compressed (.ZIP) files before you can upload them. |
| Upload      | Click this to begin the upload process.   |
| Reset       | Click this to reset your Zyxel Device settings back to the factory default.   |

**Do not turn off the Zyxel Device while configuration file upload is in progress.**

After the Zyxel Device configuration has been restored successfully, the login screen appears. Login again to restart the Zyxel Device.

The Zyxel Device automatically restarts in this time causing a temporary network disconnect. In some operating systems, you may see the following icon on your desktop.

**Figure 127** Network Temporarily Disconnected

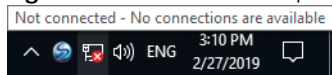

If you restore the default configuration, you may need to change the IP address of your computer to be in the same subnet as that of the default Zyxel Device IP address (192.168.1.1).

If the upload was not successful, an error screen will appear. Click **OK** to go back to the **Configuration** screen.

## 27.3 Reboot

Reboot the Zyxel Device remotely without turning the power off. You may need to do this if the Zyxel Device hangs, for example. This does not affect the Zyxel Device's configuration.

Click **Maintenance > Reboot**. Click **Reboot** to have the Zyxel Device reboot.

**Figure 128** Maintenance > Reboot

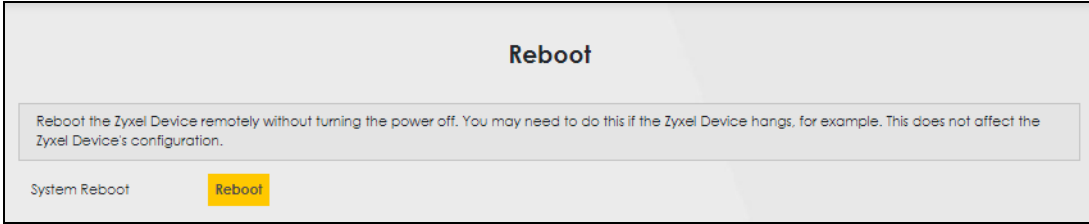



# CHAPTER 28

## Diagnostic

### 28.1 Diagnostic Overview

You can use different diagnostic methods to test a connection and see its detailed information. The **Diagnostic** screens display information to help you identify problems with the Zyxel Device.

### 28.2 Ping/TraceRoute/Nslookup Test

Perform ping, traceroute, or nslookup for troubleshooting. Ping and traceroute are used to test whether a particular host is reachable. After entering an IP address and clicking one of the buttons to start a test, the results will be shown in the Ping/Traceroute Test area. Use nslookup to find the IP address for a host name and vice versa. Click **Maintenance > Diagnostic** to open the **Ping/TraceRoute/Nslookup** screen shown next.

**Figure 129** Maintenance > Diagnostic > Ping/Trace Route/Nslookup

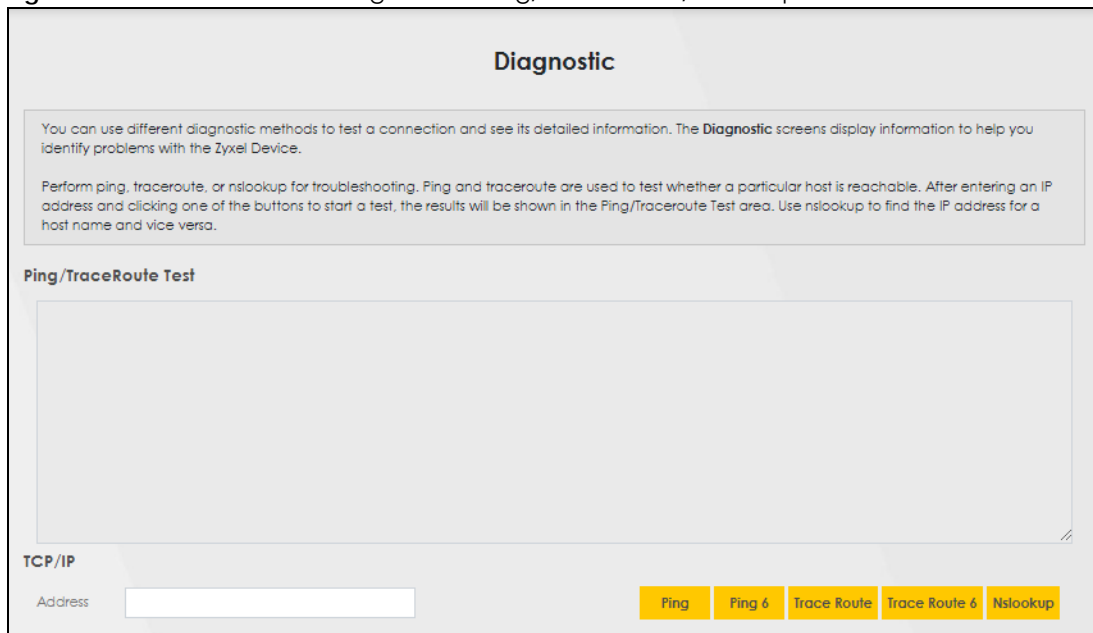

The screenshot shows the 'Diagnostic' screen with the following elements:

- Diagnostic** (Section Header)
- Introductory text: "You can use different diagnostic methods to test a connection and see its detailed information. The **Diagnostic** screens display information to help you identify problems with the Zyxel Device."
- Instructional text: "Perform ping, traceroute, or nslookup for troubleshooting. Ping and traceroute are used to test whether a particular host is reachable. After entering an IP address and clicking one of the buttons to start a test, the results will be shown in the Ping/Traceroute Test area. Use nslookup to find the IP address for a host name and vice versa."
- Ping/TraceRoute Test** (Section Header)
- A large empty rectangular area for test results.
- TCP/IP** (Section Header)
- An "Address" input field.
- Five yellow buttons: **Ping**, **Ping 6**, **Trace Route**, **Trace Route 6**, and **Nslookup**.

The following table describes the fields in this screen.

Table 79 Maintenance > Diagnostic

| LABEL                       | DESCRIPTION  |
|-----------------------------|--|
| Ping/<br>TraceRoute<br>Test | The result of tests is shown here in the info area.  |
| TCP/IP                      |  |
| Address                     | Enter either an IP address or a host name to start a test.   |
| Ping                        | Click this button to perform a ping test on the IPv4 address or host name in order to test a connection. The ping statistics will show in the info area. |
| Ping 6                      | Click this button to perform a ping test on the IPv6 address or host name in order to test a connection. The ping statistics will show in the info area. |
| Trace Route                 | Click this button to perform the IPv4 trace route function. This determines the path a packet takes to the specified host.                               |
| Trace Route 6               | Click this button to perform the IPv6 trace route function. This determines the path a packet takes to the specified host.                               |
| Nslookup                    | Click this button to perform a DNS lookup on the IP address or host name.  |

# CHAPTER 29

## Troubleshooting

### 29.1 Overview

This chapter offers some suggestions to solve problems you might encounter. The potential problems are divided into the following categories.

- [Power and Hardware Connections](#)
- [Zyxel Device Access and Login](#)
- [Internet Access](#)
- [UPnP](#)
- [SIM Card](#)
- [Cellular Signal](#)

### 29.2 Power and Hardware Connections

---

[The Zyxel Device does not turn on.](#)

---

- 1 Make sure the Zyxel Device is turned on.
- 2 Make sure you are using the power adapter and cable (Power over Ethernet, PoE) included with the Zyxel Device.
- 3 Make sure the PoE is connected to the Zyxel Device and plugged in to an appropriate power source. Make sure the power source is turned on.
- 4 Turn the Zyxel Device off and on.
- 5 If the problem continues, contact the vendor.

### 29.3 Zyxel Device Access and Login

---

[I forgot the IP address for the Zyxel Device.](#)

---

- 1 The default IP address is 192.168.1.1.
- 2 If you changed the IP address and have forgotten it, you might get the IP address of the Zyxel Device by looking up the IP address of the default gateway for your computer. To do this in most Windows computers, click **Start > Run**, enter **cmd**, and then enter **ipconfig**. The IP address of the **Default Gateway** might be the IP address of the Zyxel Device (it depends on the network), so enter this IP address in your Internet browser.
- 3 If this does not work, you have to reset the Zyxel Device to its factory defaults. Refer to [Section 27.2 on page 174](#).

---

### I forgot the password.

---

- 1 The default admin password is **1234**.
- 2 If you can't remember the password, you have to reset the Zyxel Device to its factory defaults. Refer to [Section 27.2 on page 174](#).

---

### I cannot see or access the **Login** screen in the Web Configurator.

---

- 1 Make sure you are using the correct IP address.
  - The default IP address is 192.168.1.1.
  - If you changed the IP address ([Section 7.2 on page 71](#)), use the new IP address.
  - If you changed the IP address and have forgotten it, see the troubleshooting suggestions for [I forgot the IP address for the Zyxel Device](#).
- 2 Check the hardware connections, see the Quick Start Guide.
- 3 Make sure your Internet browser does not block pop-up windows and has JavaScript and Java enabled.
- 4 Reset the Zyxel Device to its factory default, and try to access the Zyxel Device with the default IP address. Refer to [Section 27.2 on page 174](#).
- 5 If the problem continues, contact the network administrator or vendor, or try the advanced suggestion.

#### Advanced Suggestion

- Try to access the Zyxel Device using another service, such as Telnet. If you can access the Zyxel Device, check the remote management settings and firewall rules to find out why the Zyxel Device does not respond to HTTP.

---

### I can see the **Login** screen, but I cannot log in to the Zyxel Device.

---

- 1 Make sure you have entered the user name and password correctly. The default user name is **admin**. These fields are case-sensitive, so make sure [Caps Lock] is not on.
- 2 You cannot log in to the Web Configurator while someone is using Telnet to access the Zyxel Device. Log out of the Zyxel Device in the other session, or ask the person who is logged in to log out.
- 3 Turn the Zyxel Device off and on.
- 4 If this does not work, you have to reset the Zyxel Device to its factory default. See [Section 27.2 on page 174](#).

---

[I cannot use FTP, Telnet, SSH or Ping to access the Zyxel Device.](#)

---

See the Remote Management [Section on page 156](#) for details on allowing web services (such as HTTP, HTTPS, FTP, Telnet, SSH and Ping) to access the Zyxel Device.

Check the server **Port** number field for the web service in the **Maintenance > Remote Management** screen. You must use the same port number in order to use that web service for remote management.

## 29.4 Internet Access

---

[I cannot access the Internet.](#)

---

- 1 Check the hardware connections and make sure the LEDs are behaving as expected. See the **Quick Start Guide** and [Section 1.5.1 on page 16](#).
- 2 Check the SIM card. Maybe it has wrong settings (refer to [Section 5.3 on page 40](#)), the account has expired, it became loose (remove and reinsert it - refer to the Quick Start Guide) or it's missing (stolen). See [Section 29.6 on page 183](#) for possible SIM card problems.
- 3 Make sure you entered your ISP account information correctly. These fields are case-sensitive, so make sure [Caps Lock] is not on.
- 4 If the problem continues, contact your ISP.

---

[I cannot access the Internet anymore. I had access to the Internet \(with the Zyxel Device\), but my Internet connection is not available anymore.](#)

---

- 1 Check the hardware connections (refer to the Quick Start Guide).
- 2 Turn the Zyxel Device off and on.
- 3 If the problem continues, contact your ISP.

---

The Internet connection is slow or intermittent.

---

- 1 There might be a lot of traffic on the network. If the Zyxel Device is sending or receiving a lot of information, try closing some programs that use the Internet, especially peer-to-peer applications.
- 2 Turn the Zyxel Device off and on.
- 3 If the problem continues, contact the network administrator or vendor, or try the advanced suggestion (refer to [I cannot see or access the Login screen in the Web Configurator](#) in this chapter).

Note: Since your Zyxel Device is an outdoor-type, inclement weather like rain and hot weather may affect LTE signals.

## 29.5 UPnP

---

When using UPnP and the Zyxel Device reboots, my computer cannot detect UPnP and refresh [My Network Places > Local Network](#).

---

- 1 Make sure that UPnP is enabled in your computer. For Windows 7, see [Section 7.6 on page 79](#). For Windows 10, see [Section 7.7 on page 82](#).
- 2 Make sure that UPnP is enabled in the **Network Settings > Home Networking > UPnP** screen. See [Section 7.4 on page 77](#) for details.
- 3 Disconnect the Ethernet cable from the Zyxel Device's Ethernet port or from your computer.
- 4 Re-connect the Ethernet cable.

---

The **Local Area Connection** icon for UPnP disappears in the screen.

---

Restart your computer.

---

I cannot open special applications such as white board, file transfer and video when I use the [MSN Messenger](#).

---

- 1 Wait more than three minutes.
- 2 Restart the applications.

## 29.6 SIM Card

---

The SIM card cannot be detected.

---

- 1 Disconnect the Zyxel Device from the power supply.
  - 2 Remove the SIM card from its slot.
  - 3 Clean the SIM card slot of any loose debris using compressed air.
  - 4 Clean the gold connectors on the SIM card with a clean lint-free cloth.
  - 5 Insert the SIM card into its slot and connect the Zyxel Device to the power supply to restart it.
- 

I get an **Invalid** SIM card alert.

---

- 1 Make sure you have an active plan with your ISP.
  - 2 Make sure that the Zyxel Device is in the coverage area of a cellular network.
- 

## 29.7 Cellular Signal

---

How should I position the Zyxel Device to get a strong cellular signal?

---

- 1 Find the location of your nearest cellular base station(s), then install the Zyxel Device towards the direction of those sites. The nearest site or site with a direct line-of-sight is usually preferred.

Note: It is best to test towards more than one cellular site, as the nearest site / line-of-sight is not always the best due to the terrain, interference, density of usage, etc. All of these factors influence the stability, availability and throughput of the link to the Zyxel Device.

- 2 Position the Zyxel Device towards a direction where coverage is expected (example the nearest town).
- 3 Conduct test measurements using the Web Configurator's **System Monitor > Cellular WAN Status** screen to obtain a report of the cellular network signal strength and quality at various test positions.

Note: It is best to reboot the Zyxel Device before each test measurement is taken to ensure that it is not camping on the previous cellular site. This is because the Zyxel Device can 'lock' onto the previous cellular site even when the new cellular site is at a much better signal level and quality.

---

Although installing the Zyxel Device as high as possible is the usual rule of thumb, it is sometimes possible that the Zyxel Device is in a weak coverage spot at that specific height. Adjust the height to achieve the best service possible.

Note: Cellular network signals and quality can fluctuate. A measurement taken now and a few moments later can differ substantially even if nothing apparent has changed – this can be due to many aspects, such as fading, reflections, interference, capacity due to high network traffic, etc.

It is possible that the network topology and usage changes over time, even from one minute to the next as network utilization increases. If poor performance is experienced at a later stage, re-test different installation locations again. It is possible that the current serving cellular site has become over utilized or is out-of-service. As the network design and topology changes, so will the experience change, either for the better or for the worse.



---

# PART III

# Appendices

---

Appendices contain general information. Some information may not apply to your Zyxel Device.

# APPENDIX A

## Customer Support

In the event of problems that cannot be solved by using this manual, you should contact your vendor. If you cannot contact your vendor, then contact a Zyxel office for the region in which you bought the device.

See <https://www.zyxel.com/homepage.shtml> and also [https://www.zyxel.com/about\\_zyxel/zyxel\\_worldwide.shtml](https://www.zyxel.com/about_zyxel/zyxel_worldwide.shtml) for the latest information.

Please have the following information ready when you contact an office.

### Required Information

- Product model and serial number.
- Warranty Information.
- Date that you received your device.
- Brief description of the problem and the steps you took to solve it.

### Corporate Headquarters (Worldwide)

#### Taiwan

- Zyxel Communications Corporation
- <https://www.zyxel.com>

### Asia

#### China

- Zyxel Communications (Shanghai) Corp.
- Zyxel Communications (Beijing) Corp.
- Zyxel Communications (Tianjin) Corp.
- <https://www.zyxel.com/cn/zh/>

#### India

- Zyxel Technology India Pvt Ltd
- <https://www.zyxel.com/in/en/>

#### Kazakhstan

- Zyxel Kazakhstan
- <https://www.zyxel.kz>

## **Korea**

- Zyxel Korea Corp.
- <http://www.zyxel.kr>

## **Malaysia**

- Zyxel Malaysia Sdn Bhd.
- <http://www.zyxel.com.my>

## **Pakistan**

- Zyxel Pakistan (Pvt.) Ltd.
- <http://www.zyxel.com.pk>

## **Philippines**

- Zyxel Philippines
- <http://www.zyxel.com.ph>

## **Singapore**

- Zyxel Singapore Pte Ltd.
- <http://www.zyxel.com.sg>

## **Taiwan**

- Zyxel Communications Corporation
- <https://www.zyxel.com/tw/zh/>

## **Thailand**

- Zyxel Thailand Co., Ltd
- <https://www.zyxel.com/th/th/>

## **Vietnam**

- Zyxel Communications Corporation-Vietnam Office
- <https://www.zyxel.com/vn/vi>

## **Europe**

### **Belarus**

- Zyxel BY
- <https://www.zyxel.by>

### **Belgium**

- Zyxel Communications B.V.
- <https://www.zyxel.com/be/nl/>

- <https://www.zyxel.com/be/fr/>

## **Bulgaria**

- Zyxel България
- <https://www.zyxel.com/bg/bg/>

## **Czech Republic**

- Zyxel Communications Czech s.r.o
- <https://www.zyxel.com/cz/cs/>

## **Denmark**

- Zyxel Communications A/S
- <https://www.zyxel.com/dk/da/>

## **Estonia**

- Zyxel Estonia
- <https://www.zyxel.com/ee/et/>

## **Finland**

- Zyxel Communications
- <https://www.zyxel.com/fi/fi/>

## **France**

- Zyxel France
- <https://www.zyxel.fr>

## **Germany**

- Zyxel Deutschland GmbH
- <https://www.zyxel.com/de/de/>

## **Hungary**

- Zyxel Hungary & SEE
- <https://www.zyxel.com/hu/hu/>

## **Italy**

- Zyxel Communications Italy
- <https://www.zyxel.com/it/it/>

## **Latvia**

- Zyxel Latvia
- <https://www.zyxel.com/lv/lv/>

## **Lithuania**

- Zyxel Lithuania
- <https://www.zyxel.com/lt/lt/>

## **Netherlands**

- Zyxel Benelux
- <https://www.zyxel.com/nl/nl/>

## **Norway**

- Zyxel Communications
- <https://www.zyxel.com/no/no/>

## **Poland**

- Zyxel Communications Poland
- <https://www.zyxel.com/pl/pl/>

## **Romania**

- Zyxel Romania
- <https://www.zyxel.com/ro/ro/>

## **Russia**

- Zyxel Russia
- <https://www.zyxel.com/ru/ru/>

## **Slovakia**

- Zyxel Communications Czech s.r.o. organizacna zlozka
- <https://www.zyxel.com/sk/sk/>

## **Spain**

- Zyxel Communications ES Ltd
- <https://www.zyxel.com/es/es/>

## **Sweden**

- Zyxel Communications
- <https://www.zyxel.com/se/sv/>

## **Switzerland**

- Studerus AG
- <https://www.zyxel.ch/de>
- <https://www.zyxel.ch/fr>

## **Turkey**

- Zyxel Turkey A.S.
- <https://www.zyxel.com/tr/tr/>

## **UK**

- Zyxel Communications UK Ltd.
- <https://www.zyxel.com/uk/en/>

## **Ukraine**

- Zyxel Ukraine
- <http://www.ua.zyxel.com>

## **South America**

### **Argentina**

- Zyxel Communications Corporation
- <https://www.zyxel.com/co/es/>

### **Brazil**

- Zyxel Communications Brasil Ltda.
- <https://www.zyxel.com/br/pt/>

### **Colombia**

- Zyxel Communications Corporation
- <https://www.zyxel.com/co/es/>

### **Ecuador**

- Zyxel Communications Corporation
- <https://www.zyxel.com/co/es/>

### **South America**

- Zyxel Communications Corporation
- <https://www.zyxel.com/co/es/>

## **Middle East**

### **Israel**

- Zyxel Communications Corporation
- <http://il.zyxel.com/>

## **Middle East**

- Zyxel Communications Corporation
- <https://www.zyxel.com/me/en/>

## **North America**

### **USA**

- Zyxel Communications, Inc. - North America Headquarters
- <https://www.zyxel.com/us/en/>

## **Oceania**

### **Australia**

- Zyxel Communications Corporation
- <https://www.zyxel.com/au/en/>

## **Africa**

### **South Africa**

- Nology (Pty) Ltd.
- <https://www.zyxel.com/za/en/>

# APPENDIX B

## IPv6

### Overview

IPv6 (Internet Protocol version 6), is designed to enhance IP address size and features. The increase in IPv6 address size to 128 bits (from the 32-bit IPv4 address) allows up to  $3.4 \times 10^{38}$  IP addresses.

### IPv6 Addressing

The 128-bit IPv6 address is written as eight 16-bit hexadecimal blocks separated by colons (:). This is an example IPv6 address `2001:0db8:1a2b:0015:0000:0000:1a2f:0000`.

IPv6 addresses can be abbreviated in two ways:

- Leading zeros in a block can be omitted. So `2001:0db8:1a2b:0015:0000:0000:1a2f:0000` can be written as `2001:db8:1a2b:15:0:0:1a2f:0`.
- Any number of consecutive blocks of zeros can be replaced by a double colon. A double colon can only appear once in an IPv6 address. So `2001:0db8:0000:0000:1a2f:0000:0000:0015` can be written as `2001:0db8::1a2f:0000:0000:0015`, `2001:0db8:0000:0000:1a2f::0015`, `2001:db8::1a2f:0:0:15` or `2001:db8:0:0:1a2f::15`.

### Prefix and Prefix Length

Similar to an IPv4 subnet mask, IPv6 uses an address prefix to represent the network address. An IPv6 prefix length specifies how many most significant bits (start from the left) in the address compose the network address. The prefix length is written as “/x” where x is a number. For example,

`2001:db8:1a2b:15::1a2f:0/32`

means that the first 32 bits (`2001:db8`) is the subnet prefix.

### Link-local Address

A link-local address uniquely identifies a device on the local network (the LAN). It is similar to a “private IP address” in IPv4. You can have the same link-local address on multiple interfaces on a device. A link-local unicast address has a predefined prefix of `fe80::/10`. The link-local unicast address format is as follows.

Table 80 Link-local Unicast Address Format

|              |         |              |
|--------------|---------|--------------|
| 1111 1110 10 | 0       | Interface ID |
| 10 bits      | 54 bits | 64 bits      |

### Global Address

A global address uniquely identifies a device on the Internet. It is similar to a “public IP address” in IPv4. A global unicast address starts with a 2 or 3.



## Unspecified Address

An unspecified address (0:0:0:0:0:0 or ::) is used as the source address when a device does not have its own address. It is similar to "0.0.0.0" in IPv4.

## Loopback Address

A loopback address (0:0:0:0:0:1 or ::1) allows a host to send packets to itself. It is similar to "127.0.0.1" in IPv4.

## Multicast Address

In IPv6, multicast addresses provide the same functionality as IPv4 broadcast addresses. Broadcasting is not supported in IPv6. A multicast address allows a host to send packets to all hosts in a multicast group.

Multicast scope allows you to determine the size of the multicast group. A multicast address has a predefined prefix of ff00::/8. The following table describes some of the predefined multicast addresses.

Table 81 Predefined Multicast Address

| MULTICAST ADDRESS  | DESCRIPTION                            |
|--------------------|--|
| FF01:0:0:0:0:0:0:1 | All hosts on a local node.             |
| FF01:0:0:0:0:0:0:2 | All routers on a local node.           |
| FF02:0:0:0:0:0:0:1 | All hosts on a local connected link.   |
| FF02:0:0:0:0:0:0:2 | All routers on a local connected link. |
| FF05:0:0:0:0:0:0:2 | All routers on a local site.           |
| FF05:0:0:0:0:0:1:3 | All DHCP servers on a local site.      |

The following table describes the multicast addresses which are reserved and cannot be assigned to a multicast group.

Table 82 Reserved Multicast Address

| MULTICAST ADDRESS  |
|--------------------|
| FF00:0:0:0:0:0:0:0 |
| FF01:0:0:0:0:0:0:0 |
| FF02:0:0:0:0:0:0:0 |
| FF03:0:0:0:0:0:0:0 |
| FF04:0:0:0:0:0:0:0 |
| FF05:0:0:0:0:0:0:0 |
| FF06:0:0:0:0:0:0:0 |
| FF07:0:0:0:0:0:0:0 |
| FF08:0:0:0:0:0:0:0 |
| FF09:0:0:0:0:0:0:0 |
| FF0A:0:0:0:0:0:0:0 |
| FF0B:0:0:0:0:0:0:0 |
| FF0C:0:0:0:0:0:0:0 |
| FF0D:0:0:0:0:0:0:0 |

Table 82 Reserved Multicast Address (continued)

| MULTICAST ADDRESS  |
|--------------------|
| FF0E:0:0:0:0:0:0:0 |
| FF0F:0:0:0:0:0:0:0 |

## Subnet Masking

Both an IPv6 address and IPv6 subnet mask compose of 128-bit binary digits, which are divided into eight 16-bit blocks and written in hexadecimal notation. Hexadecimal uses four bits for each character (1 ~ 10, A ~ F). Each block's 16 bits are then represented by four hexadecimal characters. For example, FFFF:FFFF:FFFF:FFFF:FC00:0000:0000:0000.

## Interface ID

In IPv6, an interface ID is a 64-bit identifier. It identifies a physical interface (for example, an Ethernet port) or a virtual interface (for example, the management IP address for a VLAN). One interface should have a unique interface ID.

## EUI-64

The EUI-64 (Extended Unique Identifier) defined by the IEEE (Institute of Electrical and Electronics Engineers) is an interface ID format designed to adapt with IPv6. It is derived from the 48-bit (6-byte) Ethernet MAC address as shown next. EUI-64 inserts the hex digits ffe between the third and fourth bytes of the MAC address and complements the seventh bit of the first byte of the MAC address. See the following example.

|        |                                       |
|--------|---------------------------------------|
| MAC    | 00 : 13 : 49 : 12 : 34 : 56           |
| EUI-64 | 02 : 13 : 49 : FF : FE : 12 : 34 : 56 |

## Identity Association

An Identity Association (IA) is a collection of addresses assigned to a DHCP client, through which the server and client can manage a set of related IP addresses. Each IA must be associated with exactly one interface. The DHCP client uses the IA assigned to an interface to obtain configuration from a DHCP server for that interface. Each IA consists of a unique IAID and associated IP information.

The IA type is the type of address in the IA. Each IA holds one type of address. IA\_NA means an identity association for non-temporary addresses and IA\_TA is an identity association for temporary addresses.

An IA\_NA option contains the T1 and T2 fields, but an IA\_TA option does not. The DHCPv6 server uses T1 and T2 to control the time at which the client contacts with the server to extend the lifetimes on any addresses in the IA\_NA before the lifetimes expire. After T1, the client sends the server (S1) (from which the addresses in the IA\_NA were obtained) a Renew message. If the time T2 is reached and the server

does not respond, the client sends a Rebind message to any available server (**S2**). For an IA\_TA, the client may send a Renew or Rebind message at the client's discretion.

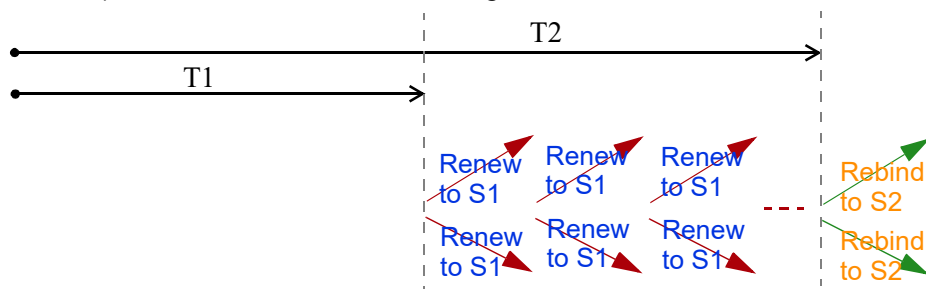

## DHCP Relay Agent

A DHCP relay agent is on the same network as the DHCP clients and helps forward messages between the DHCP server and clients. When a client cannot use its link-local address and a well-known multicast address to locate a DHCP server on its network, it then needs a DHCP relay agent to send a message to a DHCP server that is not attached to the same network.

The DHCP relay agent can add the remote identification (remote-ID) option and the interface-ID option to the Relay-Forward DHCPv6 messages. The remote-ID option carries a user-defined string, such as the system name. The interface-ID option provides slot number, port information and the VLAN ID to the DHCPv6 server. The remote-ID option (if any) is stripped from the Relay-Reply messages before the relay agent sends the packets to the clients. The DHCP server copies the interface-ID option from the Relay-Forward message into the Relay-Reply message and sends it to the relay agent. The interface-ID should not change even after the relay agent restarts.

## Prefix Delegation

Prefix delegation enables an IPv6 router to use the IPv6 prefix (network address) received from the ISP (or a connected uplink router) for its LAN. The Zyxel Device uses the received IPv6 prefix (for example, 2001:db2::/48) to generate its LAN IP address. Through sending Router Advertisements (RAs) regularly by multicast, the Zyxel Device passes the IPv6 prefix information to its LAN hosts. The hosts then can use the prefix to generate their IPv6 addresses.

## ICMPv6

Internet Control Message Protocol for IPv6 (ICMPv6 or ICMP for IPv6) is defined in RFC 4443. ICMPv6 has a preceding Next Header value of 58, which is different from the value used to identify ICMP for IPv4. ICMPv6 is an integral part of IPv6. IPv6 nodes use ICMPv6 to report errors encountered in packet processing and perform other diagnostic functions, such as "ping".

## Neighbor Discovery Protocol (NDP)

The Neighbor Discovery Protocol (NDP) is a protocol used to discover other IPv6 devices and track neighbor's reachability in a network. An IPv6 device uses the following ICMPv6 messages types:

- Neighbor solicitation: A request from a host to determine a neighbor's link-layer address (MAC address) and detect if the neighbor is still reachable. A neighbor being "reachable" means it responds to a neighbor solicitation message (from the host) with a neighbor advertisement message.
- Neighbor advertisement: A response from a node to announce its link-layer address.

- Router solicitation: A request from a host to locate a router that can act as the default router and forward packets.
- Router advertisement: A response to a router solicitation or a periodical multicast advertisement from a router to advertise its presence and other parameters.

## IPv6 Cache

An IPv6 host is required to have a neighbor cache, destination cache, prefix list and default router list. The Zyxel Device maintains and updates its IPv6 caches constantly using the information from response messages. In IPv6, the Zyxel Device configures a link-local address automatically, and then sends a neighbor solicitation message to check if the address is unique. If there is an address to be resolved or verified, the Zyxel Device also sends out a neighbor solicitation message. When the Zyxel Device receives a neighbor advertisement in response, it stores the neighbor's link-layer address in the neighbor cache. When the Zyxel Device uses a router solicitation message to query for a router and receives a router advertisement message, it adds the router's information to the neighbor cache, prefix list and destination cache. The Zyxel Device creates an entry in the default router list cache if the router can be used as a default router.

When the Zyxel Device needs to send a packet, it first consults the destination cache to determine the next hop. If there is no matching entry in the destination cache, the Zyxel Device uses the prefix list to determine whether the destination address is on-link and can be reached directly without passing through a router. If the address is un-link, the address is considered as the next hop. Otherwise, the Zyxel Device determines the next-hop from the default router list or routing table. Once the next hop IP address is known, the Zyxel Device looks into the neighbor cache to get the link-layer address and sends the packet when the neighbor is reachable. If the Zyxel Device cannot find an entry in the neighbor cache or the state for the neighbor is not reachable, it starts the address resolution process. This helps reduce the number of IPv6 solicitation and advertisement messages.

## Multicast Listener Discovery

The Multicast Listener Discovery (MLD) protocol (defined in RFC 2710) is derived from IPv4's Internet Group Management Protocol version 2 (IGMPv2). MLD uses ICMPv6 message types, rather than IGMP message types. MLDv1 is equivalent to IGMPv2 and MLDv2 is equivalent to IGMPv3.

MLD allows an IPv6 switch or router to discover the presence of MLD listeners who wish to receive multicast packets and the IP addresses of multicast groups the hosts want to join on its network.

MLD snooping and MLD proxy are analogous to IGMP snooping and IGMP proxy in IPv4.

MLD filtering controls which multicast groups a port can join.

## MLD Messages

A multicast router or switch periodically sends general queries to MLD hosts to update the multicast forwarding table. When an MLD host wants to join a multicast group, it sends an MLD Report message for that address.

An MLD Done message is equivalent to an IGMP Leave message. When an MLD host wants to leave a multicast group, it can send a Done message to the router or switch. The router or switch then sends a group-specific query to the port on which the Done message is received to determine if other devices connected to this port should remain in the group.

## Example - Enabling IPv6 on Windows 7

Windows 7 supports IPv6 by default. DHCPv6 is also enabled when you enable IPv6 on a Windows 7 computer.

To enable IPv6 in Windows 7:

- 1 Select **Control Panel > Network and Sharing Center > Local Area Connection**.
- 2 Select the **Internet Protocol Version 6 (TCP/IPv6)** checkbox to enable it.
- 3 Click **OK** to save the change.

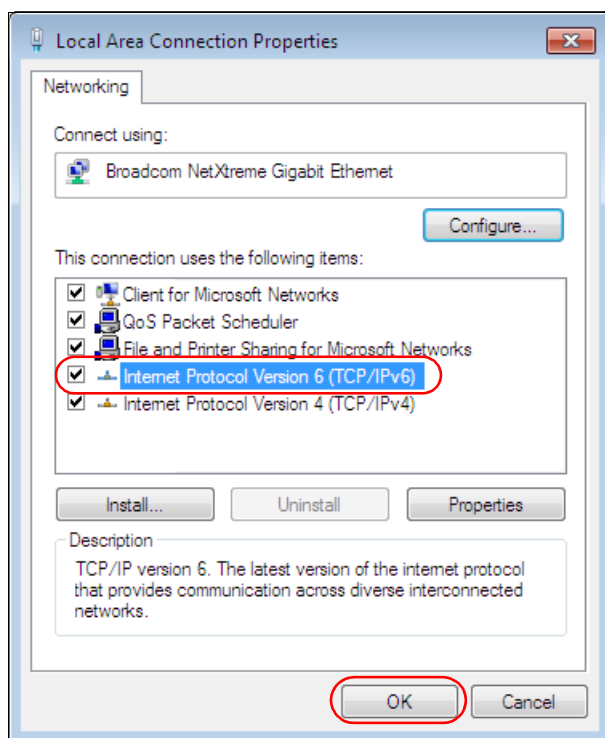

- 4 Click **Close** to exit the **Local Area Connection Status** screen.
- 5 Select **Start > All Programs > Accessories > Command Prompt**.
- 6 Use the `ipconfig` command to check your dynamic IPv6 address. This example shows a global address (2001:b021:2d::1000) obtained from a DHCP server.

```
C:\>ipconfig

Windows IP Configuration

Ethernet adapter Local Area Connection:

    Connection-specific DNS Suffix . . :
    IPv6 Address. . . . . : 2001:b021:2d::1000
    Link-local IPv6 Address . . . . . : fe80::25d8:dcab:c80a:5189%11
    IPv4 Address. . . . . : 172.16.100.61
    Subnet Mask . . . . . : 255.255.255.0
    Default Gateway . . . . . : fe80::213:49ff:feaa:7125%11
                                172.16.100.254
```

# APPENDIX C

## Legal Information

### Copyright

Copyright © 2019 by Zyxel Communications Corporation.

The contents of this publication may not be reproduced in any part or as a whole, transcribed, stored in a retrieval system, translated into any language, or transmitted in any form or by any means, electronic, mechanical, magnetic, optical, chemical, photocopying, manual, or otherwise, without the prior written permission of Zyxel Communications Corporation.

Published by Zyxel Communications Corporation. All rights reserved.

### Disclaimer

Zyxel does not assume any liability arising out of the application or use of any products, or software described herein. Neither does it convey any license under its patent rights nor the patent rights of others. Zyxel further reserves the right to make changes in any products described herein without notice. This publication is subject to change without notice.

### Regulatory Notice and Statement

Model: LTE7240-M403

### EUROPEAN UNION



The following information applies if you use the product within the European Union.

#### Declaration of Conformity with Regard to EU Directive 2014/53/EU (Radio Equipment Directive, RED)

- Compliance information for wireless products relevant to the EU and other Countries following the EU Directive 2014/53/EU (RED). And this product may be used in all EU countries (and other countries following the EU Directive 2014/53/EU) without any limitation except for the countries mentioned below table:
- In the majority of the EU and other European countries, the 5GHz bands have been made available for the use of wireless local area networks (LANs). Later in this document you will find an overview of countries in which additional restrictions or requirements or both are applicable. The requirements for any country may evolve. Zyxel recommends that you check with the local authorities for the latest status of their national regulations for the 5GHz wireless LANs.
- If this device for operation in the band 5150-5350 MHz, it is for indoor use only.
- This equipment should be installed and operated with a minimum distance of 20 cm between the radio equipment and your body.
- The maximum RF power operating for each band as follows:
- WiFi
  - the band 2,400 to 2,483.5 MHz is 88.51 mW
- GSM
  - the GSM 900 is 1967.89 mW
  - the DCS 1800 is 968.28 mW
- WCDMA
  - the WCDMA Band I is 213.8 mW
  - the WCDMA Band VIII is 208.93 mW
- LTE
  - the LTE Band 1 is 204.17 mW
  - the LTE Band 3 is 199.53 mW
  - the LTE Band 7 is 190.55 mW
  - the LTE Band 8 is 208.93 mW
  - the LTE Band 20 is 223.87 mW
  - the LTE Band 38 is 147.91 mW
  - the LTE Band 40 is 141.25 mW

|                                |  |
|--------------------------------|--|
| Български<br>(Bulgarian)       | <p>С настоящото Zyxel декларира, че това оборудване е в съответствие със съществените изисквания и другите приложими разпоредбите на Директива 2014/53/ЕС.</p> <p><b>National Restrictions</b></p> <ul style="list-style-type: none"> <li>The Belgian Institute for Postal Services and Telecommunications (BIPT) must be notified of any outdoor wireless link having a range exceeding 300 meters. Please check <a href="http://www.bipt.be">http://www.bipt.be</a> for more details.</li> <li>Draadloze verbindingen voor buitengebruik en met een reikwijdte van meer dan 300 meter dienen aangemeld te worden bij het Belgisch Instituut voor postdiensten en telecommunicatie (BIPT). Zie <a href="http://www.bipt.be">http://www.bipt.be</a> voor meer gegevens.</li> <li>Les liaisons sans fil pour une utilisation en extérieur d'une distance supérieure à 300 mètres doivent être notifiées à l'Institut Belge des services Postaux et des Télécommunications (IBPT). Visitez <a href="http://www.ibpt.be">http://www.ibpt.be</a> pour de plus amples détails.</li> </ul>             |
| Español<br>(Spanish)           | Por medio de la presente Zyxel declara que el equipo cumple con los requisitos esenciales y cualesquiera otras disposiciones aplicables o exigibles de la Directiva 2014/53/UE..   |
| Čeština<br>(Czech)             | Zyxel tímto prohlašuje, že tento zařízení je ve shodě se základními požadavky a dalšími příslušnými ustanoveními směrnice 2014/53/EU.  |
| Dansk (Danish)                 | <p>Undertegnede Zyxel erklærer herved, at følgende udstyr overholder de væsentlige krav og øvrige relevante krav i direktiv 2014/53/EU.</p> <p><b>National Restrictions</b></p> <ul style="list-style-type: none"> <li>In Denmark, the band 5150 - 5350 MHz is also allowed for outdoor usage.</li> <li>I Danmark må frekvensbåndet 5150 - 5350 også anvendes udendørs.</li> </ul>   |
| Deutsch<br>(German)            | Hiermit erkläre Zyxel, dass sich das Gerät Ausstattung in Übereinstimmung mit den grundlegenden Anforderungen und den übrigen einschlägigen Bestimmungen der Richtlinie 2014/53/EU befindet.   |
| Eesti keel<br>(Estonian)       | Käesolevaga kinnitab Zyxel seadme seadme vastavust direktiivi 2014/53/EL põhinõuetele ja nimetatud direktiivist tulenevatele teistele asjakohastele sätetele.  |
| Ελληνικά<br>(Greek)            | ΜΕ ΤΗΝ ΠΑΡΟΥΣΑ Zyxel ΔΗΛΩΝΕΙ ΟΤΙ ΕΞΟΠΛΙΣΜΟΣ ΣΥΜΜΟΡΦΩΝΕΤΑΙ ΠΡΟΣ ΤΙΣ ΟΥΣΙΩΔΕΙΣ ΑΠΑΙΤΗΣΕΙΣ ΚΑΙ ΤΙΣ ΛΟΙΠΕΣ ΣΧΕΤΙΚΕΣ ΔΙΑΤΑΞΕΙΣ ΤΗΣ ΟΔΗΓΙΑΣ 2014/53/ΕΕ.  |
| English                        | Hereby, Zyxel declares that this device is in compliance with the essential requirements and other relevant provisions of Directive 2014/53/EU.  |
| Français<br>(French)           | Par la présente Zyxel déclare que l'appareil équipements est conforme aux exigences essentielles et aux autres dispositions pertinentes de la directive 2014/53/UE.  |
| Hrvatski<br>(Croatian)         | Zyxel ovime izjavljuje da je radijska oprema tipa u skladu s Direktivom 2014/53/UE.  |
| Íslenska<br>(Icelandic)        | Hér með lýsir, Zyxel því yfir að þessi búnaður er í samræmi við grunnkröfur og önnur viðeigandi ákvæði tilskipunar 2014/53/UE.   |
| Italiano (Italian)             | <p>Con la presente Zyxel dichiara che questo attrezzatura è conforme ai requisiti essenziali ed alle altre disposizioni pertinenti stabilite dalla direttiva 2014/53/UE.</p> <p><b>National Restrictions</b></p> <ul style="list-style-type: none"> <li>This product meets the National Radio Interface and the requirements specified in the National Frequency Allocation Table for Italy. Unless this wireless LAN product is operating within the boundaries of the owner's property, its use requires a "general authorization." Please check <a href="http://www.sviluppoeconomico.gov.it/">http://www.sviluppoeconomico.gov.it/</a> for more details.</li> <li>Questo prodotto è conforme alle specifiche di Interfaccia Radio Nazionali e rispetta il Piano Nazionale di ripartizione delle frequenze in Italia. Se non viene installato all'interno del proprio fondo, l'utilizzo di prodotti Wireless LAN richiede una "Autorizzazione Generale". Consultare <a href="http://www.sviluppoeconomico.gov.it/">http://www.sviluppoeconomico.gov.it/</a> per maggiori dettagli.</li> </ul> |
| Latviešu valoda<br>(Latvian)   | <p>Ar šo Zyxel deklarē, ka iekārtas atbilst Direktīvas 2014/53/ES būtiskajām prasībām un citiem ar to saistītajiem noteikumiem.</p> <p><b>National Restrictions</b></p> <ul style="list-style-type: none"> <li>The outdoor usage of the 2.4 GHz band requires an authorization from the Electronic Communications Office. Please check <a href="http://www.esd.lv">http://www.esd.lv</a> for more details.</li> <li>2.4 GHz frekvenču joslas izmantošanai ārpus telpām nepieciešama atļauja no Elektronisko sakaru direkcijas. Vairāk informācijas: <a href="http://www.esd.lv">http://www.esd.lv</a>.</li> </ul>  |
| Lietuvių kalba<br>(Lithuanian) | Šiuo Zyxel deklaruoja, kad šis įranga atitinka esminius reikalavimus ir kitas 2014/53/ES Direktyvos nuostatas.   |
| Magyar<br>(Hungarian)          | Alulírott, Zyxel nyilatkozom, hogy a berendezés megfelel a vonatkozó alapvető követelményeknek és az 2014/53/EU irányelv egyéb előírásainak.   |
| Malti (Maltese)                | Hawnhekk, Zyxel, jiddikjara li dan tagħmir jikkonforma mal-htigijiet essenzjali u ma provvedimenti oħrajn rilevanti li hemm fid-Dirrettiva 2014/53/UE.   |
| Nederlands<br>(Dutch)          | Hierbij verklaart Zyxel dat het toestel uitrusting in overeenstemming is met de essentiële eisen en de andere relevante bepalingen van richtlijn 2014/53/EU.   |
| Polski (Polish)                | Niniejszym Zyxel oświadcza, że sprzęt jest zgodny z zasadniczymi wymogami oraz pozostałymi stosownymi postanowieniami Dyrektywy 2014/53/UE.  |
| Português<br>(Portuguese)      | Zyxel declara que este equipamento está conforme com os requisitos essenciais e outras disposições da Directiva 2014/53/UE.  |



|                       |   |
|-----------------------|---|
| Română (Romanian)     | Prin prezenta, Zyxel declară că acest echipament este în conformitate cu cerințele esențiale și alte prevederi relevante ale Directivei 2014/53/UE.                     |
| Slovenčina (Slovak)   | Zyxel týmto vyhlasuje, že zariadenia spĺňa základné požiadavky a všetky príslušné ustanovenia Smernice 2014/53/EÚ.  |
| Slovenščina (Slovene) | Zyxel izjavlja, da je ta oprema v skladu z bistvenimi zahtevami in ostalimi relevantnimi določili direktive 2014/53/EU.   |
| Suomi (Finnish)       | Zyxel vakuuttaa täten että laitteet tyyppinen laite on direktiivin 2014/53/EU oleellisten vaatimusten ja sitä koskevien direktiivin muiden ehtojen mukainen.            |
| Svenska (Swedish)     | Härmed intygar Zyxel att denna utrustning står i överensstämmelse med de väsentliga egenskapskrav och övriga relevanta bestämmelser som framgår av direktiv 2014/53/EU. |
| Norsk (Norwegian)     | Erklærer herved Zyxel at dette utstyret er i samsvar med de grunnleggende kravene og andre relevante bestemmelser i direktiv 2014/53/EU.                                |

**Notes:**

- Although Norway, Switzerland and Liechtenstein are not EU member states, the EU Directive 2014/53/EU has also been implemented in those countries.
- The regulatory limits for maximum output power are specified in EIRP. The EIRP level (in dBm) of a device can be calculated by adding the gain of the antenna used (specified in dBi) to the output power available at the connector (specified in dBm).

**List of national codes**

| COUNTRY        | ISO 3166 2 LETTER CODE | COUNTRY        | ISO 3166 2 LETTER CODE |
|----------------|------------------------|----------------|------------------------|
| Austria        | AT                     | Liechtenstein  | LI                     |
| Belgium        | BE                     | Lithuania      | LT                     |
| Bulgaria       | BG                     | Luxembourg     | LU                     |
| Croatia        | HR                     | Malta          | MT                     |
| Cyprus         | CY                     | Netherlands    | NL                     |
| Czech Republic | CZ                     | Norway         | NO                     |
| Denmark        | DK                     | Poland         | PL                     |
| Estonia        | EE                     | Portugal       | PT                     |
| Finland        | FI                     | Romania        | RO                     |
| France         | FR                     | Serbia         | RS                     |
| Germany        | DE                     | Slovakia       | SK                     |
| Greece         | GR                     | Slovenia       | SI                     |
| Hungary        | HU                     | Spain          | ES                     |
| Iceland        | IS                     | Switzerland    | CH                     |
| Ireland        | IE                     | Sweden         | SE                     |
| Italy          | IT                     | Turkey         | TR                     |
| Latvia         | LV                     | United Kingdom | GB                     |

**Safety Warnings**

- Do not use this product near water, for example, in a wet basement or near a swimming pool.
- Do not expose your Zyxel Device to dampness, dust or corrosive liquids.
- Do not store things on the device.
- Do not obstruct the Zyxel Device ventilation slots as insufficient airflow may harm your Zyxel Device. For example, do not place the Zyxel Device in an enclosed space such as a box or on a very soft surface such as a bed or sofa.
- Do not install, use, or service this Zyxel Device during a thunderstorm. There is a remote risk of electric shock from lightning.
- Connect ONLY suitable accessories to the Zyxel Device.
- Do not open the Zyxel Device or unit. Opening or removing covers can expose you to dangerous high voltage points or other risks.
- Only qualified service personnel should service or disassemble this Zyxel Device. Please contact your vendor for further information.
- Make sure to connect the cables to the correct ports.
- Place connecting cables carefully so that no one will step on them or stumble over them.
- Always disconnect all cables from this Zyxel Device before servicing or disassembling.
- Do not remove the plug and connect it to a power outlet by itself; always attach the plug to the power adapter first before connecting it to a power outlet.
- Do not allow anything to rest on the power adapter or cord and do NOT place the product where anyone can walk on the power adapter or cord.
- Please use the provided or designated connection cables/power cables/adapters. Connect it to the right supply voltage (for example, 110V AC in North America or 230V AC in Europe). If the power adapter or cord is damaged, it might cause electrocution. Remove it from the Zyxel Device and the power source, repairing the power adapter or cord is prohibited. Contact your local vendor to order a new one.

- The following warning statements apply, where the disconnect device is not incorporated in the Zyxel Device or where the plug on the power supply cord is intended to serve as the disconnect device,
  - For permanently connected Zyxel Device, a readily accessible disconnect device shall be incorporated external to the Zyxel Device;
  - For pluggable devices, the socket-outlet shall be installed near the Zyxel Device and shall be easily accessible.

## Environment Statement

### European Union - Disposal and Recycling Information

The symbol below means that according to local regulations your product and/or its battery shall be disposed of separately from domestic waste. If this product is end of life, take it to a recycling station designated by local authorities. At the time of disposal, the separate collection of your product and/or its battery will help save natural resources and ensure that the environment is sustainable development.

Die folgende Symbol bedeutet, dass Ihr Produkt und/oder seine Batterie gemäß den örtlichen Bestimmungen getrennt vom Hausmüll entsorgt werden muss. Wenden Sie sich an eine Recyclingstation, wenn dieses Produkt das Ende seiner Lebensdauer erreicht hat. Zum Zeitpunkt der Entsorgung wird die getrennte Sammlung von Produkt und/oder seiner Batterie dazu beitragen, natürliche Ressourcen zu sparen und die Umwelt und die menschliche Gesundheit zu schützen.

El símbolo de abajo indica que según las regulaciones locales, su producto y/o su batería deberán depositarse como basura separada de la doméstica. Cuando este producto alcance el final de su vida útil, llévelo a un punto limpio. Cuando llegue el momento de desechar el producto, la recogida por separado éste y/o su batería ayudará a salvar los recursos naturales y a proteger la salud humana y medioambiental.

Le symbole ci-dessous signifie que selon les réglementations locales votre produit et/ou sa batterie doivent être éliminés séparément des ordures ménagères. Lorsque ce produit atteint sa fin de vie, amenez-le à un centre de recyclage. Au moment de la mise au rebut, la collecte séparée de votre produit et/ou de sa batterie aidera à économiser les ressources naturelles et protéger l'environnement et la santé humaine.

Il simbolo sotto significa che secondo i regolamenti locali il vostro prodotto e/o batteria deve essere smaltito separatamente dai rifiuti domestici. Quando questo prodotto raggiunge la fine della vita di servizio portarlo a una stazione di riciclaggio. Al momento dello smaltimento, la raccolta separata del vostro prodotto e/o della sua batteria aiuta a risparmiare risorse naturali e a proteggere l'ambiente e la salute umana.

Symbolen innebär att enligt lokal lagstiftning ska produkten och/eller dess batteri kastas separat från hushållsavfallet. När den här produkten når slutet av sin livslängd ska du ta den till en återvinningsstation. Vid tiden för kasseringen bidrar du till en bättre miljö och mänsklig hälsa genom att göra dig av med den på ett återvinningsställe.



台灣



以下訊息僅適用於產品具有無線功能且銷售至台灣地區

- 第十二條 經型式認證合格之低功率射頻電機，非經許可，公司，商號或使用者均不得擅自變更頻率、加大功率或變更原設計之特性及功能。
- 第十四條 低功率射頻電機之使用不得影響飛航安全及干擾合法通信；經發現有干擾現象時，應立即停用，並改善至無干擾時方得繼續使用。前項合法通信，指依電信法規定作業之無線電通信。低功率射頻電機須忍受合法通信或工業、科學及醫療用電波輻射性電機設備之干擾。
- 無線資訊傳輸設備應受合法通信之干擾且不得干擾合法通信；如造成干擾，應立即停用，俟無干擾之虞，始得繼續使用。
- 無線資訊傳輸設備的製造廠商應確保頻率穩定性，如依製造廠商使用手冊上所述正常操作，發射的信號應維持於操作頻帶中
- 使用無線產品時，應避免影響附近雷達系統之操作。
- 高增益指向性天線只得應用於固定式點對點系統。

以下訊息僅適用於產品屬於專業安裝並銷售至台灣地區

- 本器材須經專業工程人員安裝及設定，始得設置使用，且不得直接販售給一般消費者。

安全警告 - 為了您的安全，請先閱讀以下警告及指示：





- 請勿將此產品接近水、火焰或放置在高溫的環境。
- 避免設備接觸：
  - 任何液體 - 切勿讓設備接觸水、雨水、高濕度、污水腐蝕性的液體或其他水份。
  - 灰塵及污物 - 切勿接觸灰塵、污物、沙土、食物或其他不合適的材料。

- 雷雨天氣時，不要安裝，使用或維修此設備。有遭受電擊的風險。
- 切勿重摔或撞擊設備，並勿使用不正確的電源變壓器。
- 若接上不正確的電源變壓器會有爆炸的風險。
- 請勿隨意更換產品內的電池。
- 如果更換不正確之電池型式，會有爆炸的風險，請依製造商說明書處理使用過之電池。
- 請將廢電池丟棄在適當的電器或電子設備回收處。
- 請勿將設備解體。
- 請勿阻礙設備的散熱孔，空氣對流不足將會造成設備損害。
- 請插在正確的電壓供給插座（如：北美 / 台灣電壓 110V AC，歐洲是 230V AC）。
- 假若電源變壓器或電源變壓器的纜線損壞，請從插座拔除，若您還繼續插電使用，會有觸電死亡的風險。
- 請勿試圖修理電源變壓器或電源變壓器的纜線，若有毀損，請直接聯絡您購買的店家，購買一個新的電源變壓器。
- 請勿將此設備安裝於室外，此設備僅適合放置於室內。
- 請勿隨一般垃圾丟棄。
- 請參閱產品背貼上的設備額定功率。
- 請參考產品型錄或是彩盒上的作業溫度。
- 產品沒有斷電裝置或者採用電源線的插頭視為斷電裝置的一部分，以下警語將適用：
  - 對永久連接之設備，在設備外部須安裝可觸及之斷電裝置；
  - 對插接式之設備，插座必須接近安裝之地點而且是易於觸及的。

## About the Symbols

Various symbols are used in this product to ensure correct usage, to prevent danger to the user and others, and to prevent property damage. The meaning of these symbols are described below. It is important that you read these descriptions thoroughly and fully understand the contents.

### Explanation of the Symbols

| SYMBOL  | EXPLANATION  |
|---|--|
|    | Alternating current (AC):<br>AC is an electric current in which the flow of electric charge periodically reverses direction.                                   |
|  | Direct current (DC):<br>DC is the unidirectional flow or movement of electric charge carriers.   |
|  | Earth; ground:<br>A wiring terminal intended for connection of a Protective Earthing Conductor.  |
|  | Class II equipment:<br>The method of protection against electric shock in the case of class II equipment is either double insulation or reinforced insulation. |

## Viewing Certifications

Go to <http://www.zyxel.com> to view this product's documentation and certifications.

## Zyxel Limited Warranty

Zyxel warrants to the original end user (purchaser) that this product is free from any defects in material or workmanship for a specific period (the Warranty Period) from the date of purchase. The Warranty Period varies by region. Check with your vendor and/or the authorized Zyxel local distributor for details about the Warranty Period of this product. During the warranty period, and upon proof of purchase, should the product have indications of failure due to faulty workmanship and/or materials, Zyxel will, at its discretion, repair or replace the defective products or components without charge for either parts or labor, and to whatever extent it shall deem necessary to restore the product or components to proper operating condition. Any replacement will consist of a new or re-manufactured functionally equivalent product of equal or higher value, and will be solely at the discretion of Zyxel. This warranty shall not apply if the product has been modified, misused, tampered with, damaged by an act of God, or subjected to abnormal working conditions.

### Note

Repair or replacement, as provided under this warranty, is the exclusive remedy of the purchaser. This warranty is in lieu of all other warranties, express or implied, including any implied warranty of merchantability or fitness for a particular use or purpose. Zyxel shall in no event be held liable for indirect or consequential damages of any kind to the purchaser.

To obtain the services of this warranty, contact your vendor. You may also refer to the warranty policy for the region in which you bought the Zyxel Device at [http://www.zyxel.com/web/support\\_warranty\\_info.php](http://www.zyxel.com/web/support_warranty_info.php).

## Registration

Register your product online to receive email notices of firmware upgrades and information at [www.zyxel.com](http://www.zyxel.com) for global products, or at [www.us.zyxel.com](http://www.us.zyxel.com) for North American products.

## Open Source Licenses

This product contains in part some free software distributed under GPL license terms and/or GPL like licenses. Open source licenses are provided with the firmware package. You can download the latest firmware at [www.zyxel.com](http://www.zyxel.com). To obtain the source code covered under those Licenses, please contact [support@zyxel.com.tw](mailto:support@zyxel.com.tw) to get it.

## Regulatory Notice and Statement

Model: LTE7461-M602

### United States of America



The following information applies if you use the product within USA area.

#### FCC EMC Statement

- This device complies with part 15 of the FCC Rules. Operation is subject to the following two conditions:
  - (1) This device may not cause harmful interference, and
  - (2) This device must accept any interference received, including interference that may cause undesired operation.
- Changes or modifications not expressly approved by the party responsible for compliance could void the user's authority to operate the equipment.
- This product has been tested and complies with the specifications for a Class B digital device, pursuant to part 15 of the FCC Rules. These limits are designed to provide reasonable protection against harmful interference in a residential installation. This equipment generates, uses, and can radiate radio frequency energy and, if not installed and used according to the instructions, may cause harmful interference to radio communications. However, there is no guarantee that interference will not occur in a particular installation.
- If this device does cause harmful interference to radio or television reception, which is found by turning the equipment off and on, the user is encouraged to try to correct the interference by one or more of the following measures:
  - Reorient or relocate the receiving antenna.
  - Increase the separation between the equipment or devices
  - Connect the equipment to an outlet other than the receiver's
  - Consult a dealer or an experienced radio/TV technician for assistance

The following information applies if you use the product with RF function within USA area.

#### FCC Radiation exposure statement

- This equipment complies with FCC RF radiation exposure limits set forth for an uncontrolled environment.
- This transmitter must be at least 30 cm from the user and must not be co-located or operating in conjunction with any other antenna or transmitter.

### CANADA

The following information applies if you use the product within Canada area.

#### Innovation, Science and Economic Development Canada ICES Statement

CAN ICES-3 (B)/NMB-3(B)

#### Innovation, Science and Economic Development Canada RSS-GEN & RSS-247 Statement

- This device contains licence-exempt transmitter(s)/receiver(s) that comply with Innovation, Science and Economic Development Canada's licence-exempt RSS(s). Operation is subject to the following two conditions: (1) this device may not cause interference, and (2) this device must accept any interference, including interference that may cause undesired operation of the device.
- This radio transmitter (2468C-LTE7461M602) has been approved by Innovation, Science and Economic Development Canada to operate with the antenna types listed below with the maximum permissible gain indicated. Antenna types not included in this list that have a gain greater than the maximum gain indicated for any type listed, are strictly prohibited for use with this device.

## Antenna Information

| Chain No. | Antenna Type | Frequency Range  | WiFi Gain (dBi) | LTE Gain (dBi) | Connector |
|-----------|--------------|------------------|-----------------|----------------|-----------|
| WLAN-ANT0 | PIFA         | 2.4 ~ 2.4835 GHz | 6               | N.A.           | iPEX      |
| WLAN-ANT1 | PIFA         | 2.4 ~ 2.4835 GHz | 5               | N.A.           | iPEX      |
| WWAN      | Dipole       | 2500 ~ 2570 MHz  | N.A.            | 9              | iPEX      |
|           |              | 698 ~ 716 MHz    | N.A.            | 3.5            | iPEX      |
|           |              | 777 ~ 787 MHz    | N.A.            | 3              | iPEX      |
|           |              | 1850 ~ 1915 MHz  | N.A.            | 8              | iPEX      |
|           |              | 814 ~ 849 MHz    | N.A.            | 3.6            | iPEX      |
|           |              | 2305 ~ 2315 MHz  | N.A.            | 9              | iPEX      |
|           |              | 1710 ~ 1780 MHz  | N.A.            | 6              | iPEX      |

If the product with 5G wireless function operating in 5150-5250 MHz and 5725-5850 MHz, the following attention must be paid,

- The device for operation in the band 5150-5250 MHz is only for indoor use to reduce the potential for harmful interference to co-channel mobile satellite systems.
- For devices with detachable antenna(s), the maximum antenna gain permitted for devices in the band 5725-5850 MHz shall be such that the equipment still complies with the e.i.r.p. limits as appropriate; and
- Where applicable, antenna type(s), antenna model(s), and the worst-case tilt angle(s) necessary to remain compliant with the e.i.r.p. elevation mask requirement set forth in Section 6.2.2.3 of RSS 247 shall be clearly indicated.

If the product with 5G wireless function operating in 5250-5350 MHz and 5470-5725 MHz, the following attention must be paid.

- For devices with detachable antenna(s), the maximum antenna gain permitted for devices in the bands 5250-5350 MHz and 5470-5725 MHz shall be such that the equipment still complies with the e.i.r.p. limit.
- L'émetteur/récepteur exempt de licence contenu dans le présent appareil est conforme aux CNR d'Innovation, Sciences et Développement économique Canada applicables aux appareils radio exempts de licence. L'exploitation est autorisée aux deux conditions suivantes : (1) l'appareil ne doit pas produire de brouillage; (2) l'appareil doit accepter tout brouillage radioélectrique subi, même si le brouillage est susceptible d'en compromettre le fonctionnement.
- Le présent émetteur radio (2468C-LTE7461M602) a été approuvé par Innovation, Sciences et Développement économique Canada pour fonctionner avec les types d'antenne énumérés ci-dessous et ayant un gain admissible maximal. Les types d'antenne non inclus dans cette liste, et dont le gain est supérieur au gain maximal indiqué pour tout type figurant sur la liste, sont strictement interdits pour l'exploitation de l'émetteur.

## Informations antenne

| Chaîne NB. | Antenne Type | Gamme de fréquences | WiFi Gain (dBi) | LTE Gain (dBi) | Connecteur |
|------------|--------------|---------------------|-----------------|----------------|------------|
| WLAN-ANT0  | PIFA         | 2.4 ~ 2.4835 GHz    | 6               | N.A.           | iPEX       |
| WLAN-ANT1  | PIFA         | 2.4 ~ 2.4835 GHz    | 5               | N.A.           | iPEX       |
| WWAN       | Dipole       | 2500 ~ 2570 MHz     | N.A.            | 9              | iPEX       |
|            |              | 698 ~ 716 MHz       | N.A.            | 3.5            | iPEX       |
|            |              | 777 ~ 787 MHz       | N.A.            | 3              | iPEX       |
|            |              | 1850 ~ 1915 MHz     | N.A.            | 8              | iPEX       |
|            |              | 814 ~ 849 MHz       | N.A.            | 3.6            | iPEX       |
|            |              | 2305 ~ 2315 MHz     | N.A.            | 9              | iPEX       |
|            |              | 1710 ~ 1780 MHz     | N.A.            | 6              | iPEX       |

Lorsque la fonction sans fil 5G fonctionnant en 5150-5250 MHz and 5725-5850 MHz est activée pour ce produit, il est nécessaire de porter une attention particulière aux choses suivantes

- Les dispositifs fonctionnant dans la bande de 5 150 à 5 250 MHz sont réservés uniquement pour une utilisation à l'intérieur afin de réduire les risques de brouillage préjudiciable aux systèmes de satellites mobiles utilisant les mêmes canaux;
- Pour les dispositifs munis d'antennes amovibles, le gain maximal d'antenne permis (pour les dispositifs utilisant la bande de 5 725 à 5 850 MHz) doit être conforme à la limite de la p.i.r.e. spécifiée, selon le cas;
- Lorsqu'il y a lieu, les types d'antennes (s'il y en a plusieurs), les numéros de modèle de l'antenne et les pires angles d'inclinaison nécessaires pour rester conforme à l'exigence de la p.i.r.e. applicable au masque d'élévation, énoncée à la section 6.2.2.3 du CNR-247, doivent être clairement indiqués.

Lorsque la fonction sans fil 5G fonctionnant en 5250-5350 MHz et 5470-5725 MHz est activée pour ce produit, il est nécessaire de porter une attention particulière aux choses suivantes.

- Pour les dispositifs munis d'antennes amovibles, le gain maximal d'antenne permis pour les dispositifs utilisant les bandes de 5 250 à 5 350 MHz et de 5 470 à 5 725 MHz doit être conforme à la limite de la p.i.r.e.

## Industry Canada radiation exposure statement

This equipment complies with ISED radiation exposure limits set forth for an uncontrolled environment. This equipment should be installed and operated with a minimum distance of 30 cm between the radiator and your body.

### Déclaration d'exposition aux radiations:

Cet équipement est conforme aux limites d'exposition aux rayonnements ISED établies pour un environnement non contrôlé. Cet équipement doit être installé et utilisé avec un minimum de 30 cm de distance entre la source de rayonnement et votre corps.

### Safety Warnings

- Do not use this product near water, for example, in a wet basement or near a swimming pool.
- Do not expose your Zyxel Device to dampness, dust or corrosive liquids.
- Do not store things on the device.
- Do not obstruct the Zyxel Device ventilation slots as insufficient airflow may harm your Zyxel Device. For example, do not place the Zyxel Device in an enclosed space such as a box or on a very soft surface such as a bed or sofa.
- Do not install, use, or service this Zyxel Device during a thunderstorm. There is a remote risk of electric shock from lightning.
- Connect ONLY suitable accessories to the Zyxel Device.
- Do not open the Zyxel Device or unit. Opening or removing covers can expose you to dangerous high voltage points or other risks.
- Only qualified service personnel should service or disassemble this Zyxel Device. Please contact your vendor for further information.
- Make sure to connect the cables to the correct ports.
- Place connecting cables carefully so that no one will step on them or stumble over them.
- Always disconnect all cables from this Zyxel Device before servicing or disassembling.
- Do not remove the plug and connect it to a power outlet by itself; always attach the plug to the power adapter first before connecting it to a power outlet.
- Do not allow anything to rest on the power adapter or cord and do NOT place the product where anyone can walk on the power adapter or cord.
- Please use the provided or designated connection cables/power cables/adapters. Connect it to the right supply voltage (for example, 110V AC in North America or 230V AC in Europe). If the power adapter or cord is damaged, it might cause electrocution. Remove it from the Zyxel Device and the power source, repairing the power adapter or cord is prohibited. Contact your local vendor to order a new one.
- The following warning statements apply, where the disconnect device is not incorporated in the Zyxel Device or where the plug on the power supply cord is intended to serve as the disconnect device.
  - For permanently connected Zyxel Devices, a readily accessible disconnect device shall be incorporated external to the Zyxel Device;
  - For pluggable devices, the socket-outlet shall be installed near the Zyxel Device and shall be easily accessible.

### Environment Statement

#### European Union - Disposal and Recycling Information

The symbol below means that according to local regulations your product and/or its battery shall be disposed of separately from domestic waste. If this product is end of life, take it to a recycling station designated by local authorities. At the time of disposal, the separate collection of your product and/or its battery will help save natural resources and ensure that the environment is sustainable development.

Die folgende Symbol bedeutet, dass Ihr Produkt und/oder seine Batterie gemäß den örtlichen Bestimmungen getrennt vom Hausmüll entsorgt werden muss. Wenden Sie sich an eine Recyclingstation, wenn dieses Produkt das Ende seiner Lebensdauer erreicht hat. Zum Zeitpunkt der Entsorgung wird die getrennte Sammlung von Produkt und/oder seiner Batterie dazu beitragen, natürliche Ressourcen zu sparen und die Umwelt und die menschliche Gesundheit zu schützen.

El símbolo de abajo indica que según las regulaciones locales, su producto y/o su batería deberán depositarse como basura separada de la doméstica. Cuando este producto alcance el final de su vida útil, llévelo a un punto limpio. Cuando llegue el momento de desechar el producto, la recogida por separado éste y/o su batería ayudará a salvar los recursos naturales y a proteger la salud humana y medioambiental.

Le symbole ci-dessous signifie que selon les réglementations locales votre produit et/ou sa batterie doivent être éliminés séparément des ordures ménagères. Lorsque ce produit atteint sa fin de vie, amenez-le à un centre de recyclage. Au moment de la mise au rebut, la collecte séparée de votre produit et/ou de sa batterie aidera à économiser les ressources naturelles et protéger l'environnement et la santé humaine.

Il simbolo sotto significa che secondo i regolamenti locali il vostro prodotto e/o batteria deve essere smaltito separatamente dai rifiuti domestici. Quando questo prodotto raggiunge la fine della vita di servizio portarlo a una stazione di riciclaggio. Al momento dello smaltimento, la raccolta separata del vostro prodotto e/o della sua batteria aiuta a risparmiare risorse naturali e a proteggere l'ambiente e la salute umana.

Symbolen innebär att enligt lokal lagstiftning ska produkten och/eller dess batteri kastas separat från hushållsavfallet. När den här produkten når slutet av sin livslängd ska du ta den till en återvinningsstation. Vid tiden för kasseringen bidrar du till en bättre miljö och mänsklig hälsa genom att göra dig av med den på ett återvinningsställe.



## 台灣



以下訊息僅適用於產品具有無線功能且銷售至台灣地區

- 第十二條 經型式認證合格之低功率射頻電機，非經許可，公司，商號或使用者均不得擅自變更頻率、加大功率或變更原設計之特性及功能。
- 第十四條 低功率射頻電機之使用不得影響飛航安全及干擾合法通信；經發現有干擾現象時，應立即停用，並改善至無干擾時方得繼續使用。前項合法通信，指依電信法規定作業之無線電通信。低功率射頻電機須忍受合法通信或工業、科學及醫療用電波輻射性電機設備之干擾。
- 無線資訊傳輸設備忍受合法通信之干擾且不得干擾合法通信；如造成干擾，應立即停用，俟無干擾之虞，始得繼續使用。
- 無線資訊傳輸設備的製造廠商應確保頻率穩定性，如依製造廠商使用手冊上所述正常操作，發射的信號應維持於操作頻帶中
- 使用無線產品時，應避免影響附近雷達系統之操作。
- 高增益指向性天線只得應用於固定式點對點系統。

以下訊息僅適用於產品屬於專業安裝並銷售至台灣地區

- 本器材須經專業工程人員安裝及設定，始得設置使用，且不得直接販售給一般消費者。





安全警告 - 為了您的安全，請先閱讀以下警告及指示：

- 請勿將此產品接近水、火焰或放置在高溫的環境。
- 避免設備接觸：
  - 任何液體 - 切勿讓設備接觸水、雨水、高濕度、污水腐蝕性的液體或其他水份。
  - 灰塵及污物 - 切勿接觸灰塵、污物、沙土、食物或其他不適合的材料。
- 雷雨天氣時，不要安裝，使用或維修此設備。有遭受電擊的風險。
- 切勿重摔或撞擊設備，並勿使用不正確的電源變壓器。
- 若接上不正確的電源變壓器會有爆炸的風險。
- 請勿隨意更換產品內的電池。
- 如果更換不正確之電池型式，會有爆炸的風險，請依製造商說明書處理使用過之電池。
- 請將廢電池丟棄在適當的電器或電子設備回收處。
- 請勿將設備解體。
- 請勿阻礙設備的散熱孔，空氣對流不足將會造成設備損害。
- 請插在正確的電壓供給插座（如：北美 / 台灣電壓 110V AC，歐洲是 230V AC）。
- 假若電源變壓器或電源變壓器的纜線損壞，請從插座拔除，若您繼續插電使用，會有觸電死亡的風險。
- 請勿試圖修理電源變壓器或電源變壓器的纜線，若有毀損，請直接聯絡您購買的店家，購買一個新的電源變壓器。
- 請勿將此設備安裝於室外，此設備僅適合放置於室內。
- 請勿隨一般垃圾丟棄。
- 請參閱產品背貼上的設備額定功率。
- 請參考產品型錄或是彩盒上的作業溫度。
- 產品沒有斷電裝置或者採用電源線的插頭視為斷電裝置的一部分，以下警語將適用：
  - 對永久連接之設備，在設備外部須安裝可觸及之斷電裝置；
  - 對插接式之設備，插座必須接近安裝之地點而且是易於觸及的。

## About the Symbols

Various symbols are used in this product to ensure correct usage, to prevent danger to the user and others, and to prevent property damage. The meaning of these symbols are described below. It is important that you read these descriptions thoroughly and fully understand the contents.

### Explanation of the Symbols

| SYMBOL  | EXPLANATION  |
|---|--|
|  | Alternating current (AC):<br>AC is an electric current in which the flow of electric charge periodically reverses direction.                                   |
|  | Direct current (DC):<br>DC is the unidirectional flow or movement of electric charge carriers.   |
|  | Earth; ground:<br>A wiring terminal intended for connection of a Protective Earthing Conductor.  |
|  | Class II equipment:<br>The method of protection against electric shock in the case of class II equipment is either double insulation or reinforced insulation. |

### Viewing Certifications

Go to <http://www.zyxel.com> to view this product's documentation and certifications.

### Zyxel Limited Warranty

Zyxel warrants to the original end user (purchaser) that this product is free from any defects in material or workmanship for a specific period (the Warranty Period) from the date of purchase. The Warranty Period varies by region. Check with your vendor and/or the authorized Zyxel local distributor for details about the Warranty Period of this product. During the warranty period, and upon proof of purchase, should the product have indications of failure due to faulty workmanship and/or materials, Zyxel will, at its discretion, repair or replace the defective products or components without charge for either parts or labor, and to whatever extent it shall deem necessary to restore the product or components to proper operating condition. Any replacement will consist of a new or re-manufactured functionally equivalent product of equal or higher value, and will be solely at the discretion of Zyxel. This warranty shall not apply if the product has been modified, misused, tampered with, damaged by an act of God, or subjected to abnormal working conditions.

#### Note

Repair or replacement, as provided under this warranty, is the exclusive remedy of the purchaser. This warranty is in lieu of all other warranties, express or implied, including any implied warranty of merchantability or fitness for a particular use or purpose. Zyxel shall in no event be held liable for indirect or consequential damages of any kind to the purchaser.

To obtain the services of this warranty, contact your vendor. You may also refer to the warranty policy for the region in which you bought the Zyxel Device at [http://www.zyxel.com/web/support\\_warranty\\_info.php](http://www.zyxel.com/web/support_warranty_info.php).

### Registration

Register your product online to receive email notices of firmware upgrades and information at [www.zyxel.com](http://www.zyxel.com) for global products, or at [www.us.zyxel.com](http://www.us.zyxel.com) for North American products.

### Open Source Licenses

This product contains in part some free software distributed under GPL license terms and/or GPL like licenses. Open source licenses are provided with the firmware package. You can download the latest firmware at [www.zyxel.com](http://www.zyxel.com). To obtain the source code covered under those Licenses, please contact [support@zyxel.com.tw](mailto:support@zyxel.com.tw) to get it.

### Regulatory Notice and Statement

Model: LTE7480-S905

#### United States of America



The following information applies if you use the product within USA area.

#### FCC EMC Statement

- This device complies with part 15 of the FCC Rules. Operation is subject to the following two conditions:
  - (1) This device may not cause harmful interference, and
  - (2) This device must accept any interference received, including interference that may cause undesired operation.



- Changes or modifications not expressly approved by the party responsible for compliance could void the user's authority to operate the equipment.
- This product has been tested and complies with the specifications for a Class B digital device, pursuant to part 15 of the FCC Rules. These limits are designed to provide reasonable protection against harmful interference in a residential installation. This equipment generates, uses, and can radiate radio frequency energy and, if not installed and used according to the instructions, may cause harmful interference to radio communications. However, there is no guarantee that interference will not occur in a particular installation.
- If this device does cause harmful interference to radio or television reception, which is found by turning the equipment off and on, the user is encouraged to try to correct the interference by one or more of the following measures:
  - Reorient or relocate the receiving antenna.
  - Increase the separation between the equipment or devices
  - Connect the equipment to an outlet other than the receiver's
  - Consult a dealer or an experienced radio/TV technician for assistance

The following information applies if you use the product with RF function within USA area.

### FCC Radiation exposure statement

- This equipment complies with FCC RF radiation exposure limits set forth for an uncontrolled environment.
- This transmitter must be at least 20 cm from the user and must not be co-located or operating in conjunction with any other antenna or transmitter.

### Safety Warnings

- Do not use this product near water, for example, in a wet basement or near a swimming pool.
- Do not expose your Zyxel Device to dampness, dust or corrosive liquids.
- Do not store things on the device.
- Do not obstruct the Zyxel Device ventilation slots as insufficient airflow may harm your Zyxel Device. For example, do not place the Zyxel Device in an enclosed space such as a box or on a very soft surface such as a bed or sofa.
- Do not install, use, or service this Zyxel Device during a thunderstorm. There is a remote risk of electric shock from lightning.
- Connect ONLY suitable accessories to the Zyxel Device.
- Do not open the Zyxel Device or unit. Opening or removing covers can expose you to dangerous high voltage points or other risks.
- Only qualified service personnel should service or disassemble this Zyxel Device. Please contact your vendor for further information.
- Make sure to connect the cables to the correct ports.
- Place connecting cables carefully so that no one will step on them or stumble over them.
- Always disconnect all cables from this Zyxel Device before servicing or disassembling.
- Do not remove the plug and connect it to a power outlet by itself; always attach the plug to the power adapter first before connecting it to a power outlet.
- Do not allow anything to rest on the power adapter or cord and do NOT place the product where anyone can walk on the power adapter or cord.
- Please use the provided or designated connection cables/power cables/adapters. Connect it to the right supply voltage (for example, 110V AC in North America or 230V AC in Europe). If the power adapter or cord is damaged, it might cause electrocution. Remove it from the Zyxel Device and the power source, repairing the power adapter or cord is prohibited. Contact your local vendor to order a new one.
- The following warning statements apply, where the disconnect device is not incorporated in the Zyxel Device or where the plug on the power supply cord is intended to serve as the disconnect device,
  - For permanently connected Zyxel Devices, a readily accessible disconnect device shall be incorporated external to the Zyxel Device;
  - For pluggable devices, the socket-outlet shall be installed near the Zyxel Device and shall be easily accessible.

### Environment Statement

#### European Union - Disposal and Recycling Information

The symbol below means that according to local regulations your product and/or its battery shall be disposed of separately from domestic waste. If this product is end of life, take it to a recycling station designated by local authorities. At the time of disposal, the separate collection of your product and/or its battery will help save natural resources and ensure that the environment is sustainable development.

Die folgende Symbol bedeutet, dass Ihr Produkt und/oder seine Batterie gemäß den örtlichen Bestimmungen getrennt vom Hausmüll entsorgt werden muss. Wenden Sie sich an eine Recyclingstation, wenn dieses Produkt das Ende seiner Lebensdauer erreicht hat. Zum Zeitpunkt der Entsorgung wird die getrennte Sammlung von Produkt und/oder seiner Batterie dazu beitragen, natürliche Ressourcen zu sparen und die Umwelt und die menschliche Gesundheit zu schützen.

El símbolo de abajo indica que según las regulaciones locales, su producto y/o su batería deberán depositarse como basura separada de la doméstica. Cuando este producto alcance el final de su vida útil, llévelo a un punto limpio. Cuando llegue el momento de desechar el producto, la recogida por separado éste y/o su batería ayudará a salvar los recursos naturales y a proteger la salud humana y medioambiental.

Le symbole ci-dessous signifie que selon les réglementations locales votre produit et/ou sa batterie doivent être éliminés séparément des ordures ménagères. Lorsque ce produit atteint sa fin de vie, amenez-le à un centre de recyclage. Au moment de la mise au rebut, la collecte séparée de votre produit et/ou de sa batterie aidera à économiser les ressources naturelles et protéger l'environnement et la santé humaine.

Il simbolo sotto significa che secondo i regolamenti locali il vostro prodotto e/o batteria deve essere smaltito separatamente dai rifiuti domestici. Quando questo prodotto raggiunge la fine della vita di servizio portarlo a una stazione di riciclaggio. Al momento dello smaltimento, la raccolta separata del vostro prodotto e/o della sua batteria aiuta a risparmiare risorse naturali e a proteggere l'ambiente e la salute umana.

Symbolen innebär att enligt lokal lagstiftning ska produkten och/eller dess batteri kastas separat från hushållsavfallet. När den här produkten når slutet av sin livslängd ska du ta den till en återvinningsstation. Vid tiden för kasseringen bidrar du till en bättre miljö och mänsklig hälsa genom att göra dig av med den på ett återvinningsställe.



台灣



以下訊息僅適用於產品具有無線功能且銷售至台灣地區

- 第十二條 經型式認證合格之低功率射頻電機，非經許可，公司、商號或使用者均不得擅自變更頻率、加大功率或變更原設計之特性及功能。
- 第十四條 低功率射頻電機之使用不得影響飛航安全及干擾合法通信；經發現有干擾現象時，應立即停用，並改善至無干擾時方得繼續使用。前項合法通信，指依電信法規定作業之無線電通信。低功率射頻電機須忍受合法通信或工業、科學及醫療用電波輻射性電機設備之干擾。
- 無線資訊傳輸設備忍受合法通信之干擾且不得干擾合法通信；如造成干擾，應立即停用，俟無干擾之虞，始得繼續使用。
- 無線資訊傳輸設備的製造廠商應確保頻率穩定性，如依製造廠商使用手冊上所述正常操作，發射的信號應維持於操作頻帶中
- 使用無線產品時，應避免影響附近雷達系統之操作。
- 高增益指向性天線只得應用於固定式點對點系統。

以下訊息僅適用於產品屬於專業安裝並銷售至台灣地區

- 本器材須經專業工程人員安裝及設定，始得設置使用，且不得直接販售給一般消費者。





安全警告 - 為了您的安全，請先閱讀以下警告及指示：

- 請勿將此產品接近水、火焰或放置在高溫的環境。
- 避免設備接觸：
  - 任何液體 - 切勿讓設備接觸水、雨水、高濕度、污水腐蝕性的液體或其他水份。
  - 灰塵及污物 - 切勿接觸灰塵、污物、沙土、食物或其他不合適的材料。
- 雷雨天氣時，不要安裝，使用或維修此設備。有遭受電擊的風險。
- 切勿重摔或撞擊設備，並勿使用不正確的電源變壓器。
- 若接上不正確的電源變壓器會有爆炸的風險。
- 請勿隨意更換產品內的電池。
- 如果更換不正確之電池型式，會有爆炸的風險，請依製造商說明書處理使用過之電池。
- 請將廢電池丟棄在適當的電器或電子設備回收處。
- 請勿將設備解體。
- 請勿阻礙設備的散熱孔，空氣對流不足將會造成設備損害。
- 請插在正確的電壓供給插座（如：北美 / 台灣電壓 110V AC，歐洲是 230V AC）。
- 假若電源變壓器或電源變壓器的纜線損壞，請從插座拔除，若您還繼續插電使用，會有觸電死亡的風險。
- 請勿試圖修理電源變壓器或電源變壓器的纜線，若有毀損，請直接聯絡您購買的店家，購買一個新的電源變壓器。
- 請勿將此設備安裝於室外，此設備僅適合放置於室內。
- 請勿隨一般垃圾丟棄。
- 請參閱產品背貼上的設備額定功率。
- 請參考產品型錄或是彩盒上的作業溫度。
- 產品沒有斷電裝置或者採用電源線的插頭視為斷電裝置的一部分，以下警語將適用：
  - 對永久連接之設備，在設備外部須安裝可觸及之斷電裝置；
  - 對插接式之設備，插座必須接近安裝之地點而且是易於觸及的。

## About the Symbols

Various symbols are used in this product to ensure correct usage, to prevent danger to the user and others, and to prevent property damage. The meaning of these symbols are described below. It is important that you read these descriptions thoroughly and fully understand the contents.

### Explanation of the Symbols

| SYMBOL  | EXPLANATION  |
|---|--|
|  | Alternating current (AC):<br>AC is an electric current in which the flow of electric charge periodically reverses direction.                                   |
|  | Direct current (DC):<br>DC is the unidirectional flow or movement of electric charge carriers.   |
|  | Earth; ground:<br>A wiring terminal intended for connection of a Protective Earthing Conductor.  |
|  | Class II equipment:<br>The method of protection against electric shock in the case of class II equipment is either double insulation or reinforced insulation. |

### Viewing Certifications

Go to <http://www.zyxel.com> to view this product's documentation and certifications.

### Zyxel Limited Warranty

Zyxel warrants to the original end user (purchaser) that this product is free from any defects in material or workmanship for a specific period (the Warranty Period) from the date of purchase. The Warranty Period varies by region. Check with your vendor and/or the authorized Zyxel local distributor for details about the Warranty Period of this product. During the warranty period, and upon proof of purchase, should the product have indications of failure due to faulty workmanship and/or materials, Zyxel will, at its discretion, repair or replace the defective products or components without charge for either parts or labor, and to whatever extent it shall deem necessary to restore the product or components to proper operating condition. Any replacement will consist of a new or re-manufactured functionally equivalent product of equal or higher value, and will be solely at the discretion of Zyxel. This warranty shall not apply if the product has been modified, misused, tampered with, damaged by an act of God, or subjected to abnormal working conditions.

#### Note

Repair or replacement, as provided under this warranty, is the exclusive remedy of the purchaser. This warranty is in lieu of all other warranties, express or implied, including any implied warranty of merchantability or fitness for a particular use or purpose. Zyxel shall in no event be held liable for indirect or consequential damages of any kind to the purchaser.

To obtain the services of this warranty, contact your vendor. You may also refer to the warranty policy for the region in which you bought the Zyxel Device at [http://www.zyxel.com/web/support\\_warranty\\_info.php](http://www.zyxel.com/web/support_warranty_info.php).

### Registration

Register your product online to receive email notices of firmware upgrades and information at [www.zyxel.com](http://www.zyxel.com) for global products, or at [www.us.zyxel.com](http://www.us.zyxel.com) for North American products.

### Open Source Licenses

This product contains in part some free software distributed under GPL license terms and/or GPL like licenses. Open source licenses are provided with the firmware package. You can download the latest firmware at [www.zyxel.com](http://www.zyxel.com). To obtain the source code covered under those Licenses, please contact [support@zyxel.com.tw](mailto:support@zyxel.com.tw) to get it.

**A**

access  
     troubleshooting [179](#)

Access Control (Rules) screen [118](#)

ACS [160](#)

activation  
     firewalls [115](#)

Add New ACL Rule screen [119](#)

Address Resolution Protocol [142](#)

Any\_WAN  
     Remote Management [157](#)  
     TR-069 traffic [162](#)

APN information  
     obtain [38](#)

APN Settings [39](#)

Application Layer Gateway (ALG) [108](#)

applications  
     Internet access [14](#)  
     wireless WAN [14](#)

ARP Table [142, 144](#)

ARP Table screen [143](#)

authentication [59, 60](#)  
     RADIUS server [60](#)

Authentication Type  
     APN [40](#)

Auto Configuration Server, see ACS [160](#)

**B**

backup  
     configuration [174](#)

backup configuration [174](#)

Backup/Restore screen [174](#)

Band Configuration Screen [41](#)

Basic Service Set, see BSS

blinking LEDs [16](#)

Broadband [37](#)

BSS [61](#)

example [62](#)

**C**

CA [133](#)

Cellular Band screen [41](#)

Cellular SIM screen [40](#)

Cellular WAN [157](#)  
     TR-069 traffic [162](#)

Cellular WAN Screen [38](#)

Cellular WAN screen [38](#)

certificate  
     details [135](#)  
     factory default [128](#)  
     file format [134](#)  
     file path [132](#)  
     import [128, 131](#)  
     public and private keys [134](#)  
     verification [134](#)

certificate request  
     create [128](#)  
     view [129](#)

certificates [127](#)  
     advantages [134](#)  
     authentication [127](#)  
     CA [133](#)  
     creating [128](#)  
     public key [127](#)  
     replacing [128](#)  
     storage space [128](#)  
     thumbprint algorithms [135](#)  
     thumbprints [135](#)  
     trusted CAs [132](#)  
     verifying fingerprints [134](#)

Certification Authority, see CA

certifications [201](#)  
     viewing [203, 208, 211](#)

channel, wireless LAN [58](#)

client list [75](#)

configuration

- backup [174](#)
- firewalls [115](#)
- restoring [175](#)
- static route [111](#)
- contact information [186](#)
- copyright [199](#)
- Create Certificate Request screen [128](#)
- creating certificates [128](#)
- CTS threshold [56, 59](#)
- customer support [186](#)
- customized service
  - add [117](#)
- customized services [117, 118](#)

**D**

- data fragment threshold [56, 59](#)
- Data Roaming
  - enable [39](#)
- Denials of Service, see DoS
- DHCP [71](#)
- DHCP Server Lease Time [73](#)
- DHCP Server State [73](#)
- diagnostic [177](#)
- diagnostic screens [177](#)
- digital IDs [127](#)
- disclaimer [199](#)
- DMZ screen [108](#)
- DNS [71](#)
- DNS Values [73](#)
- domain name system, see DNS
- DoS [114](#)
  - thresholds [115](#)
- DoS protection blocking
  - enable [121](#)
- dynamic DNS [110](#)
  - wildcard [110](#)
- Dynamic Host Configuration Protocol, see DHCP
- DYNDNS wildcard [110](#)

**E**

- e-mail
  - log setting [171](#)
- Extended Service Set IDentification [48](#)

**F**

- factory-default
  - RESET button [19](#)
- filters
  - MAC address [50, 60](#)
- firewall
  - enhancing security [123](#)
  - security considerations [123](#)
  - traffic rule direction [121](#)
- Firewall DoS screen [121](#)
- Firewall General screen [116](#)
- firewall rules
  - direction of travel [122](#)
- firewalls [114, 115](#)
  - actions [121](#)
  - configuration [115](#)
  - customized services [117, 118](#)
  - DoS [114](#)
    - thresholds [115](#)
  - ICMP [114](#)
  - rules [122](#)
  - security [123](#)
- firmware [172](#)
  - version [32](#)
- Firmware Upgrade screen [172](#)
- firmware upload [172](#)
- firmware version
  - check [173](#)
- fragmentation threshold [56, 59](#)
- FTP [101](#)
  - unusable [181](#)

**G**

- General wireless LAN screen [47](#)

**H**

hardware connections  
troubleshooting [179](#)

**I**

IANA [78](#)  
 ICMP [114](#)  
 Import Certificate screen [132](#)  
 importing trusted CAs [132](#)  
 Internet  
   no access [181](#)  
   wizard setup [27](#)  
 Internet access [14](#)  
   wizard setup [27](#)  
 Internet Assigned Numbers Authority  
   See IANA  
 Internet Blocking [30](#)  
 Internet connection  
   slow or erratic [182](#)  
 Internet Control Message Protocol, see ICMP  
 Internet Protocol version 6, see IPv6  
 IP address  
   WAN [38](#)  
 IP Passthrough mode [45](#)  
 IP Passthrough screen [24, 44](#)  
 IPv4 firewall [116](#)  
 IPv6 [192](#)  
   addressing [192](#)  
   EUI-64 [194](#)  
   global address [192](#)  
   interface ID [194](#)  
   link-local address [192](#)  
   Neighbor Discovery Protocol [192](#)  
   ping [192](#)  
   prefix [192](#)  
   prefix length [192](#)  
   unspecified address [193](#)  
 IPv6 firewall [116](#)

**L**

LAN [70](#)  
   client list [75](#)  
   MAC address [76](#)  
   status [33, 36](#)  
 LAN IP address [73](#)  
 LAN IPv6 Mode Setup [73](#)  
 LAN Setup screen [71](#)  
 LAN subnet mask [73](#)  
 limitations  
   wireless LAN [61](#)  
   WPS [68](#)  
 Local Area Network, see LAN  
 local certificate  
   TR-069 client [162](#)  
 Local Certificates screen [127](#)  
 Log Setting screen [169](#)  
 login [20](#)  
   passwords [20](#)  
   troubleshooting [179](#)  
 Login screen  
   no access [180](#)  
 logs [136, 139, 147, 169](#)

**M**

MAC Address  
   LAN [76](#)  
 MAC address [51, 76](#)  
   filter [50, 60](#)  
 MAC authentication [50](#)  
 MAC Authentication screen [51](#)  
 Mac filter [125](#)  
 managing the device  
   good habits [14](#)  
   using FTP. See FTP.  
 MGMT Services screen [156, 157](#)  
 MSN Messenger  
   problem [182](#)  
 Multi\_WAN  
   Remote Management [157](#)  
   TR-069 traffic [162](#)

**N**

NAT  
 default server [108](#)  
 DMZ host [108](#)  
 multiple server example [102](#)  
 NAT ALG screen [108](#)  
 Network Address Translation, see NAT  
 network disconnect  
 temporary [173](#)  
 Network Map [30](#)  
 network map [24](#)  
 network type  
 select [42](#)  
 Nslookup test [178](#)

**O**

Others screen [55](#)

**P**

password  
 admin [180](#)  
 good habit [14](#)  
 lost [180](#)  
 user [180](#)  
 passwords [20](#)  
 PBC [63](#)  
 PIN Protection [41](#)  
 PIN, WPS [63](#)  
 example [65](#)  
 Ping  
 unusable [181](#)  
 Ping test [178](#)  
 Ping/TraceRoute/Nslookup screen [177](#)  
 PLMN Configuration Screen [42](#)  
 PoE injector [14](#)  
 port forwarding rule  
 add/edit [103](#)  
 Port Forwarding screen [102, 103](#)  
 Port Triggering  
 add new rule [106](#)

Port Triggering screen [104](#)  
 ports [16](#)  
 power  
 troubleshooting [179](#)  
 preamble [57, 59](#)  
 preamble mode [62](#)  
 problem  
 troubleshooting [179](#)  
 Protocol (Customized Services) screen [117](#)  
 Protocol Entry  
 add [117](#)  
 Push Button Configuration, see PBC  
 push button, WPS [63](#)

**R**

RADIUS server [60](#)  
 Reboot screen [175](#)  
 remote management  
 TR-069 [160](#)  
 Remote Procedure Calls, see RPCs [160](#)  
 RESET Button [19](#)  
 restart system [175](#)  
 restore default settings  
 after firmware upgrade [173](#)  
 restoring configuration [175](#)  
 RFC 1058. See RIP.  
 RFC 1389. See RIP.  
 RFC 1631 [100](#)  
 RFC 3164 [136](#)  
 RIP [99](#)  
 router features [14](#)  
 Routing Information Protocol. See RIP  
 Routing Table screen [145](#)  
 RPPCs [160](#)  
 RTS threshold [56, 59](#)

**S**

security  
 network [123](#)  
 wireless LAN [59](#)

- Security Log [137](#)
  - service access control [156, 157, 158](#)
  - Service Set [48](#)
  - setup
    - firewalls [115](#)
    - static route [111](#)
  - SIM card
    - status [149](#)
  - SIM configuration [40](#)
  - SSH
    - unusable [181](#)
  - SSID [60](#)
  - Static DHCP [75](#)
    - Configuration [76](#)
  - Static DHCP screen [75](#)
  - static route [92, 99](#)
    - configuration [111](#)
  - status [30](#)
    - firmware version [32](#)
    - LAN [33, 36](#)
    - WAN [32](#)
    - wireless LAN [33](#)
  - status indicators [16](#)
  - syslog
    - protocol [136](#)
    - severity levels [136](#)
  - syslog logging
    - enable [170](#)
  - syslog server
    - name or IP address [171](#)
  - system
    - firmware [172](#)
      - version [32](#)
    - passwords [20](#)
    - status [30](#)
      - LAN [33, 36](#)
      - WAN [32](#)
      - wireless LAN [33](#)
    - time [163](#)
- T**
- Telnet
    - unusable [181](#)
  - The [38](#)
- thresholds
    - data fragment [56, 59](#)
    - DoS [115](#)
    - RTS/CTS [56, 59](#)
  - time [163](#)
  - TR-069 [160](#)
    - ACS setup [160](#)
    - authentication [162](#)
  - TR-069 Client screen [160](#)
  - Trace Route test [178](#)
  - troubleshooting [179](#)
  - Trust Domain
    - add [158](#)
  - Trust Domain screen [158](#)
  - Trusted CA certificate
    - view [132](#)
  - Trusted CA screen [131](#)
  - Turning on UPnP
    - Windows 7 example [79](#)
- U**
- Universal Plug and Play, see UPnP
  - upgrading firmware [172](#)
  - UPnP [77](#)
    - forum [71](#)
    - security issues [71](#)
    - State [77](#)
    - undetectable [182](#)
    - usage confirmation [71](#)
  - UPnP screen [77](#)
  - UPnP-enabled Network Device
    - auto-discover [80, 84](#)
- W**
- WAN
    - status [32](#)
    - Wide Area Network, see WAN [37](#)
  - warranty [203, 208, 211](#)
    - note [203, 208, 211](#)
  - Web Configurator
    - easy access [87](#)



- web configurator
  - login [20](#)
  - passwords [20](#)
- WEP Encryption [50](#)
- Wireless General screen [47](#)
- wireless LAN [46](#)
  - authentication [59, 60](#)
  - BSS [61](#)
    - example [62](#)
  - channel [58](#)
  - example [57](#)
  - fragmentation threshold [56, 59](#)
  - limitations [61](#)
  - MAC address filter [50, 60](#)
  - preamble [57, 59](#)
  - RADIUS server [60](#)
  - RTS/CTS threshold [56, 59](#)
  - security [59](#)
  - SSID [60](#)
  - status [33](#)
  - WPS [62, 65](#)
    - example [66](#)
    - limitations [68](#)
    - PIN [63](#)
    - push button [63](#)
- wizard setup
  - Internet [27](#)
- WMM screen [54](#)
- WPS [62, 65](#)
  - example [66](#)
  - limitations [68](#)
  - PIN [63](#)
    - example [65](#)
  - push button [63](#)
- WPS screen [52](#)