

# User's Guide

## PLA5236

1000 Mbps Powerline AC900 Wireless Extender

### Default Login Details

|                |   |
|----------------|---|
| Web Address    | <a href="http://zyxelsetup">http://zyxelsetup</a>   |
| LAN IP Address | <a href="http://192.168.1.3">http://192.168.1.3</a> |
| Password       | 1234  |

Version 1.10 Edition 1, 01/2017

**DRAFT**



---

## **IMPORTANT!**

### **READ CAREFULLY BEFORE USE**

### **KEEP THIS GUIDE FOR FUTURE REFERENCE**

This is a User's Guide for a system managing a series of products. Not all products support all features. Menu shots and graphics in this book may differ slightly from what you see due to differences in release versions or your computer operating system. Every effort has been made to ensure that the information in this manual is accurate.

#### **Related Documentation**

- Quick Start Guide

The Quick Start Guide shows how to connect PLA and access the web configurator.

- Online Help

Click the help link for a description of the fields in the PLA menus.

- More Information

Go to **support.zyxel.com** to find other information on the PLA.



# Table of Contents

|  |           |
|--|-----------|
| <b>Table of Contents</b> .....                       | <b>3</b>  |
| <br>   |           |
| <b>Part I: Introduction</b> .....                    | <b>6</b>  |
| <br>   |           |
| <b>Chapter 1</b>                                     |           |
| <b>Introducing the PLA</b> .....                     | <b>7</b>  |
| 1.1 Overview .....                                   | 7         |
| 1.2 LEDs .....                                       | 7         |
| 1.3 Ways to Manage the PLA .....                     | 9         |
| 1.4 Expand Your Network with the PLA .....           | 9         |
| 1.5 Security .....                                   | 10        |
| 1.5.1 Passwords .....                                | 10        |
| 1.5.2 Setting Up Security .....                      | 10        |
| 1.6 Multiple Networks .....                          | 11        |
| <br>   |           |
| <b>Chapter 2</b>                                     |           |
| <b>The RESET/ ENCRYPT Button</b> .....               | <b>12</b> |
| 2.1 RESET/ENCRYPT Button Overview .....              | 12        |
| 2.2 Adding Devices to a Powerline Network .....      | 12        |
| 2.3 Removing a Device from a Powerline Network ..... | 14        |
| 2.4 Multiple Separate Powerline Networks .....       | 15        |
| 2.5 One Combination RESET/ENCRYPT Button .....       | 16        |
| <br>   |           |
| <b>Part II: Web Configurator</b> .....               | <b>17</b> |
| <br>   |           |
| <b>Chapter 3</b>                                     |           |
| <b>Introducing the Web Configurator</b> .....        | <b>18</b> |
| 3.1 Overview .....                                   | 18        |
| 3.2 Accessing the Web Configurator .....             | 18        |
| 3.2.1 Login Screen .....                             | 18        |
| 3.2.2 Password Screen .....                          | 19        |
| 3.3 Navigating the Web Configurator .....            | 20        |
| 3.3.1 Title Bar .....                                | 20        |
| 3.3.2 Navigation Panel .....                         | 21        |

|   |           |
|---|-----------|
| <b>Chapter 4</b>                            |           |
| <b>Dashboard</b> .....                      | <b>23</b> |
| 4.1 The Dashboard Screen .....              | 23        |
| <b>Chapter 5</b>                            |           |
| <b>Connection Wizard</b> .....              | <b>26</b> |
| 5.1 Overview .....                          | 26        |
| 5.2 Using the Web Configurator Wizard ..... | 26        |
| <b>Chapter 6</b>                            |           |
| <b>Monitor</b> .....                        | <b>28</b> |
| 6.1 Overview .....                          | 28        |
| 6.2 What You Can Do .....                   | 28        |
| 6.3 Log .....                               | 28        |
| 6.4 Packet Statistics .....                 | 29        |
| 6.5 WLAN 2.4G Station Status .....          | 30        |
| 6.6 WLAN 5G Station Status .....            | 31        |
| <b>Chapter 7</b>                            |           |
| <b>Wireless LAN</b> .....                   | <b>32</b> |
| 7.1 Overview .....                          | 32        |
| 7.1.1 Powerline Extended Wireless LAN ..... | 32        |
| 7.2 What You Can Do .....                   | 33        |
| 7.3 What You Should Know .....              | 34        |
| 7.3.1 Wireless Security Overview .....      | 34        |
| 7.4 General Wireless LAN Screen .....       | 35        |
| 7.5 Wireless Security .....                 | 37        |
| 7.5.1 No Security .....                     | 37        |
| 7.5.2 WEP Encryption .....                  | 38        |
| 7.5.3 WPA-PSK/WPA2-PSK .....                | 40        |
| 7.6 MAC Filter .....                        | 41        |
| 7.7 Wireless LAN Advanced Screen .....      | 42        |
| 7.8 Quality of Service (QoS) Screen .....   | 43        |
| 7.9 WPS Screen .....                        | 44        |
| 7.10 WPS Station Screen .....               | 45        |
| 7.11 Scheduling Screen .....                | 46        |
| <b>Chapter 8</b>                            |           |
| <b>LAN</b> .....                            | <b>48</b> |
| 8.1 Overview .....                          | 48        |
| 8.2 What You Can Do .....                   | 48        |
| 8.3 What You Need To Know .....             | 48        |
| 8.3.1 LAN TCP/IP .....                      | 49        |

|  |           |
|--|-----------|
| 8.3.2 IP Alias .....                           | 49        |
| 8.4 LAN IP Screen .....                        | 49        |
| 8.5 IP Alias Screen .....                      | 50        |
| <b>Chapter 9</b>                               |           |
| <b>Home Plug .....</b>                         | <b>52</b> |
| 9.1 Overview .....                             | 52        |
| 9.2 What You Can Do .....                      | 52        |
| 9.3 HomePlug Screen .....                      | 52        |
| <b>Chapter 10</b>                              |           |
| <b>One Connect.....</b>                        | <b>55</b> |
| 10.1 Overview .....                            | 55        |
| 10.2 What You Can Do .....                     | 55        |
| 10.3 One Connect Screen .....                  | 55        |
| <b>Chapter 11</b>                              |           |
| <b>Maintenance .....</b>                       | <b>56</b> |
| 11.1 Overview .....                            | 56        |
| 11.2 What You Can Do .....                     | 56        |
| 11.3 General Screen .....                      | 56        |
| 11.4 Password Screen .....                     | 57        |
| 11.5 Time Setting Screen .....                 | 57        |
| 11.6 Firmware Upgrade Screen .....             | 59        |
| 11.7 Configuration Backup/Restore Screen ..... | 61        |
| 11.8 Restart Screen .....                      | 62        |
| 11.9 Language Screen .....                     | 62        |
| 11.10 Wi-Fi Mode Screen .....                  | 62        |
| <b>Chapter 12</b>                              |           |
| <b>Troubleshooting.....</b>                    | <b>64</b> |
| 12.1 Power and Light Problems .....            | 64        |
| 12.2 Powerline Problems .....                  | 65        |
| 12.3 RESET/ENCRYPT Button Problems .....       | 65        |
| Appendix A Customer Support .....              | 68        |
| Appendix B Legal Information.....              | 74        |
| <b>Index .....</b>                             | <b>82</b> |

---

# **PART I**

## **Introduction**

---

# CHAPTER 1

## Introducing the PLA

### 1.1 Overview

This chapter introduces the main applications and features of your Zyxel Powerline Wireless 11ac Dual Band Extender with 1000Mbps PHY rate, which is called "PLA" in this guide. The following generic icon is used to represent the PLA.



This User's Guide helps you understand more about how your PLA works and how to configure your network. The PLA plugs into an ordinary power outlet to easily extend a cable or DSL broadband connection or existing Ethernet (LAN) network to any other electrical outlet in any room of a house. The PLA provides a hybrid powerline transmission and Wi-Fi solution, enabling a larger transmission capacity, all without the need for any new cabling, since power sockets are available everywhere in your home.

With the PLA you can easily set up a wireless network with both IEEE 802.11 b/g/n and IEEE 802.11 a/n/ac compatible devices. Multiple HD videos can be streamed over an interference-free 5GHz radio band across the network with no frame loss.

In this User's Guide the electrical wiring network is referred to as the "powerline network". You can directly plug an electrical device (such as a router or computer) into PLA with an AC power pass-through socket to supply power to the device.

### 1.2 LEDs

The following sections describes the lights on the PLA.

The following figure is the front panel of the PLA. Use the lights to determine if the PLA is behaving normally or if there are some problems on your powerline network.

Figure 1 Front Panel

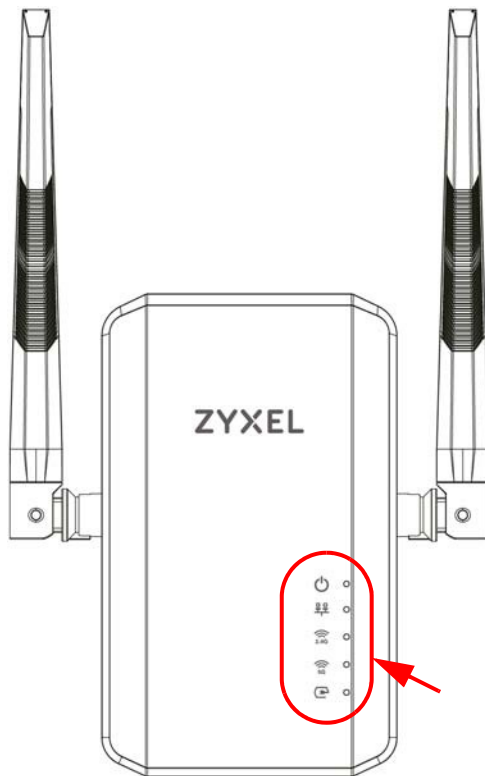

The following table describes the behavior of the lights on the PLA.

Table 1 Front Panel LEDs





| LIGHTS                 | ICON   | COLOR | STATUS        | DESCRIPTION  |
|------------------------|--|-------|---------------|--|
| POWER                  |   | Green | On            | The PLA is on and receiving power.<br>It also indicates a successful connection using the <b>RESET/ENCRYPT</b> button.                           |
|                        |  |       | Blinking      | <b>Blinking during 10 seconds:</b> The ENCRYPT function has been active.<br><b>Blinking during 120 seconds:</b> The ENCRYPT function has failed. |
|                        |  |       | Off           | The PLA is not receiving power.  |
| ETHERNET               |   | Green | On            | The ETHERNET port is on and ready and the PLA detects a device connected to it.  |
|                        |  |       | Blinking      | The PLA is communicating with a networking device connected to it.   |
|                        |  |       | Off           | The PLA does not detect any devices connected to its ETHERNET port.  |
| Wi-Fi 2.4G<br>Wi-Fi 5G | <br> | Green | On            | The PLA's wireless signal is ready.<br>Wi-Fi protected security is enabled.  |
|                        |  |       | Slow Blinking | The WPS is syncing the PLA with another device.  |
|                        |  |       | Fast Blinking | The PLA is transmitting and/or receiving wireless traffic.<br>The WPS syncing has failed.  |
|                        |  |       | Off           | The wireless signal is disabled.   |



Table 1 Front Panel LEDs

| LIGHTS   | ICON  | COLOR | STATUS   | DESCRIPTION   |
|----------|---|-------|----------|---|
| HomePlug |  | Green | On       | The PLA detects another powerline adapter. The data transfer rate is greater than 80 Mbps.          |
|          |   |       | Blinking | The PLA is communicating with another powerline adapter. Data is being transmitted and/or received. |
|          |   |       | Off      | The HomePlug port does not detect another powerline adapter.  |

## 1.3 Ways to Manage the PLA

Use the **RESET ENCRYPT** button to add powerline devices to your powerline network if they have this button. See [Chapter 2 on page 12](#) for instructions on using the ENCRYPT feature.

Use the **Home Plug** screen to manage the PLA. See [Section 9.3 on page 52](#) for instructions on installing the utility.

## 1.4 Expand Your Network with the PLA

The PLA plugs into an ordinary power outlet to easily extend a cable or DSL broadband connection or existing Ethernet (LAN) network to any other electrical outlet in any room of a house, all without the need for any new cabling. Devices can securely communicate with each other at high data transfer rates. The PLA uses 128-bit Advanced Encryption Standard (AES) to ensure safe transfer of information.

**Figure 2** Expand Your Network with the PLA

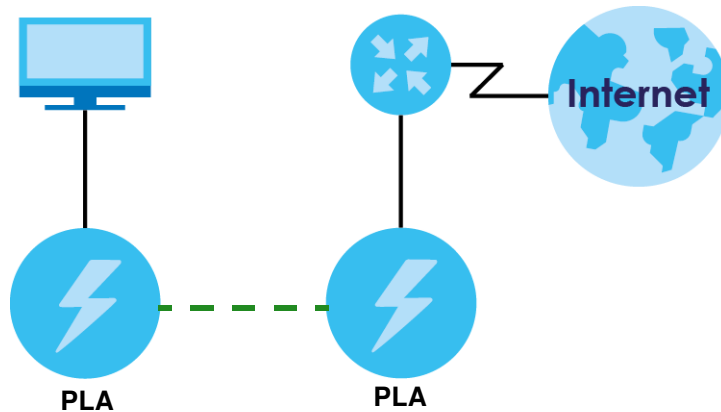

Connect your PLA to an Internet gateway such as a modem and plug it into an ordinary power outlet in your home. Plug a second PLA into another power outlet and connect a computer to the PLA for Internet access. Your network can be further expanded by plugging additional PLAs into other outlets in your home and connecting other computers or network devices (for example, a printer) to them.

Refer to your Quick Start Guide for hardware connection information.

## 1.5 Security

Since your powerline network may extend outside your premises, it is important to set up security on your PLA.

### 1.5.1 Passwords

You use two types of passwords in the Home Plug AV powerline network. The following table describes the differences between the passwords.

Table 2 Password Summary

| PASSWORD                       | DESCRIPTION  |
|--------------------------------|--|
| Network Name                   | All powerline adapters that follow the HomePlug AV standard are shipped with the same powerline network name "HomePlugAV".   |
| DAK (Data Access Key) Password | In order to manage the powerline adapters on your powerline network you must enter the adapters' DAK password in the Home Plug Screen ( <a href="#">Section 9.3 on page 52</a> ). This password is printed on the powerline adapter itself.<br><br>You don't need to add the password for the powerline adapter directly connected to the computer running the web configurator (local powerline adapter), you only have to add the remote powerline adapters' passwords (those on your circuit, but not directly connected to your computer). |

### 1.5.2 Setting Up Security

The ENCRYPT feature automatically sets up security on your powerline network. Use this feature if your powerline devices have the **RESET/ ENCRYPT** button.

Alternatively, use the Zyxel **Home Plug** screen ([Section 9.3 on page 52](#)) to set up security on the PLA. Although the PLA is a "plug-and-play" network expanding solution there are several reasons for enabling security on the powerline network in your home.

- 1 It's easy and only requires you to change a network name.
- 2 It's a good idea to ensure privacy of your communication. When you use the PLA and other powerline adapters, the electrical wiring in your home becomes an extension of your Ethernet network. Your network traffic flows freely within the electrical circuit of your home and is bounded in most cases by a power meter.

Without security (encryption) your information is accessible to anyone using a powerline adapter on the same electrical circuit. In some cases, a circuit can be shared by more than one household.

To prevent compromising your network security, you can create a private network. A private network uses a secret password (**Network Name**) to make sure that only permitted powerline adapters can communicate in your network.

- 3 You may need to change the **Network Name** to create multiple powerline networks. See the next section for more information on how to set up a multiple network.

## 1.6 Multiple Networks

Multiple powerline networks can coexist on a single powerline circuit. You might want to implement multiple powerline networks in a small office environment where you have two separate Ethernet networks.

- 1 Connect one powerline adapter to a router or switch on the first Ethernet network and assign a **Network Name** (for example "Password1") to this powerline adapter. Add additional powerline adapters to your network by plugging them into your powerline outlets and assigning them "Password1". This completes the configuration of your first powerline network.
- 2 Connect another powerline adapter to a router or switch on the second Ethernet network and assign a different **Network Name** (for example "Password2") to this powerline adapter. Again, add additional powerline adapters and assign them "Password2".

You now have two private networks on your powerline circuit. Information is not shared between the two networks as only powerline adapters with the same **Network Name** can communicate with each other.

# CHAPTER 2

## The RESET/ ENCRYPT Button

Use the **RESET/ ENCRYPT** button to automatically set up a secure powerline connection between your powerline devices.

### 2.1 RESET/ ENCRYPT Button Overview

The **RESET/ ENCRYPT** button allows you to set up a secure powerline connection with other HomePlug AV compliant powerline devices which also support the ENCRYPT feature. No other powerline setting changes are required to connect.

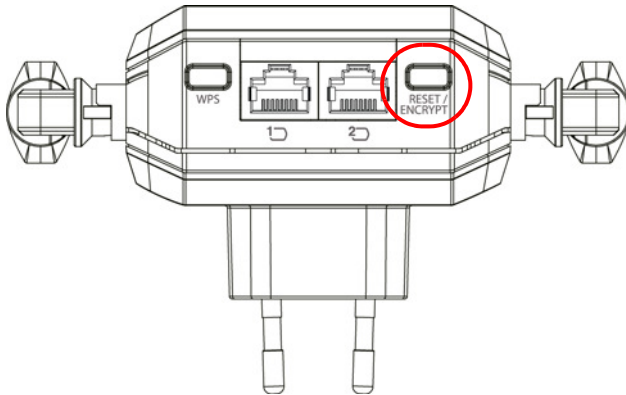

You can use the **RESET/ ENCRYPT** button to:

- set up a new powerline network.
- separate an existing powerline network into multiple networks.
- reset the PLA to the factory defaults.

### 2.2 Adding Devices to a Powerline Network

You can connect a number of PLAs on a powerline network, but you can use the **RESET/ ENCRYPT** button on only two PLAs at a time.

Place a powerline device close to another powerline device so you have time to set up each one. After you set up the first powerline device, you have 120 seconds to set up the second powerline device.

Note: Your PLA must be connected to a networking equipment for the **RESET/ ENCRYPT** button to work. Refer to [Section 1.3 on page 9](#) for more details.

Follow the steps below to set up your HomePlug AV Network:

- 1 Press the **RESET/ENCRYPT** button at the side of your powerline device for 0.5 to 3 seconds. The power (⏻) light will blink as the powerline device tries to set up a connection with a new random network name.

**Figure 3** ENCRYPT Connection Procedure

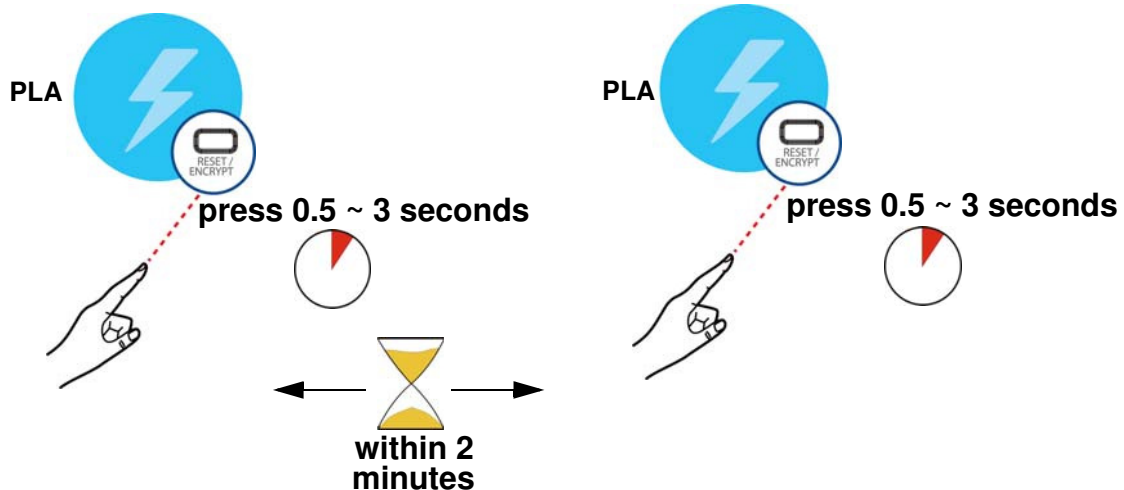

Note: The **RESET/ENCRYPT** button's location varies for each Powerline model.

Note: Check the lights on the two powerline devices. The power (⏻) and HomePlug (🔌) lights should be on while the devices are connecting. Wait for about two minutes while your powerline devices connect.

---

If the power (⏻) light does not blink when you press **RESET/ENCRYPT**, you have probably pressed the **RESET/ENCRYPT** button for too long. Try again, pressing the **RESET/ENCRYPT** button for 0.5 to 3 seconds.

---



---

If the HomePlug (🔌) lights on both powerline devices do not light up, the powerline devices are not connected. Repeat step 1 in this section. If that doesn't work, see the Troubleshooting in Section 12.3 on page 65 for suggestions.

---

- 2 To add more powerline devices to your network, use any powerline device (**A** or **B**) you have connected to set up a connection with the powerline devices you want to connect (**C** and **D**).
- 3 Press the **RESET/ENCRYPT** button on both powerline devices (**A** and **C**, or **B** and **C**) for 0.5 to 3 seconds to add powerline device **C**. This must be done within 2 minutes (120 seconds) of pressing the **RESET/ENCRYPT** button on the PLA.
- 4 Press the **RESET/ENCRYPT** button on both powerline devices (**A** and **D**, **B** and **D** or **C** and **D**) for 0.5 to 3 seconds to add powerline device **D**. This must be done within 2 minutes (120 seconds) of pressing the **RESET/ENCRYPT** button on the PLA.

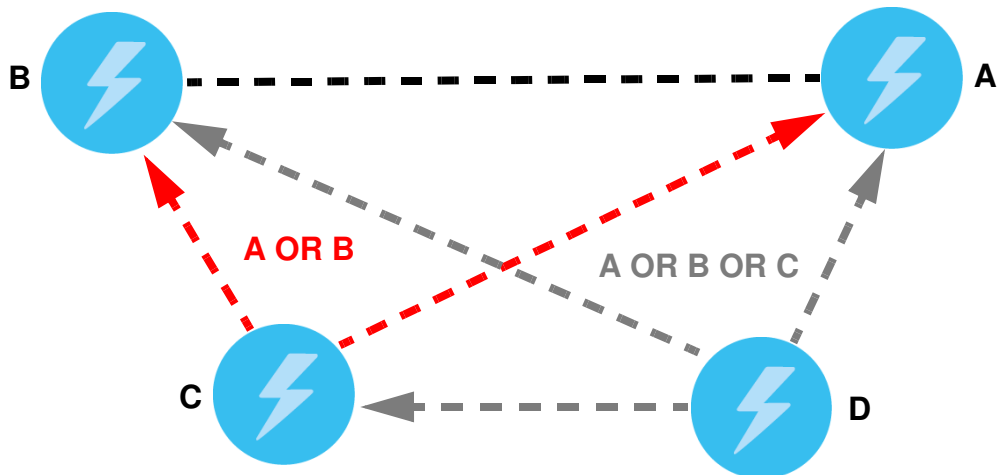
**Figure 4** Adding More Powerline Adapters to Your Network

This sets up your powerline network between your powerline devices.

## 2.3 Removing a Device from a Powerline Network

Suppose you want to remove PLAs (C) and (D) from the following powerline network.

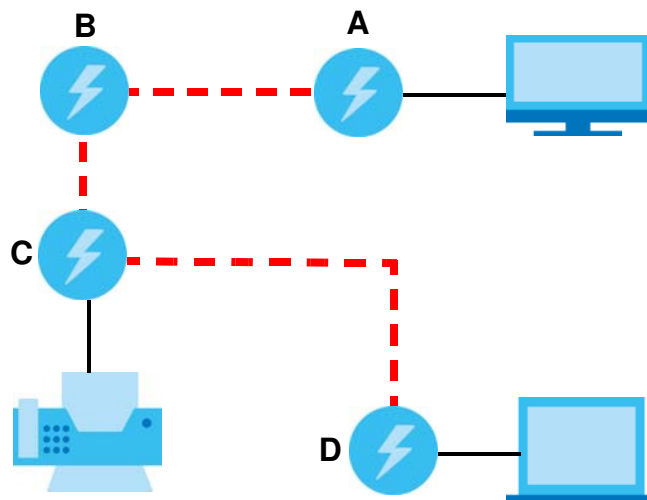
**Figure 5** Removing Devices From an Existing Powerline Network

- 1 Press the **RESET/ENCRYPT** button on powerline device **C** for 5 to 8 seconds and then release it. This disconnects **C** from the current network.
- 2 Press the **RESET/ENCRYPT** button on powerline device **D** for 5 to 8 seconds and then release it. This disconnects **D** from the current network.

## 2.4 Multiple Separate Powerline Networks

You can use the **RESET/ENCRYPT** button to create multiple separate powerline networks. Use the **RESET/ENCRYPT** button on only two PLAs at a time.

- 1 Press the **RESET/ENCRYPT** button on powerline devices **E** and **F** for 0.5 to 3 seconds. This must be done within 2 minutes (120 seconds) of pressing the **RESET/ENCRYPT** button on the first PLA.
- 2 Wait for about one minute while powerline devices **E** and **F** connect.
- 3 Now pair two different PLAs. Press the **RESET/ENCRYPT** button on powerline devices **G** and **H** for 0.5 to 3 seconds and within two minutes of each other.
- 4 Wait for about one minute while powerline devices **G** and **H** connect.
- 5 When the power (🔌) and HomePlug (📶) lights shine steadily, the devices are connected.

**Figure 6** Two Separate Powerline Networks

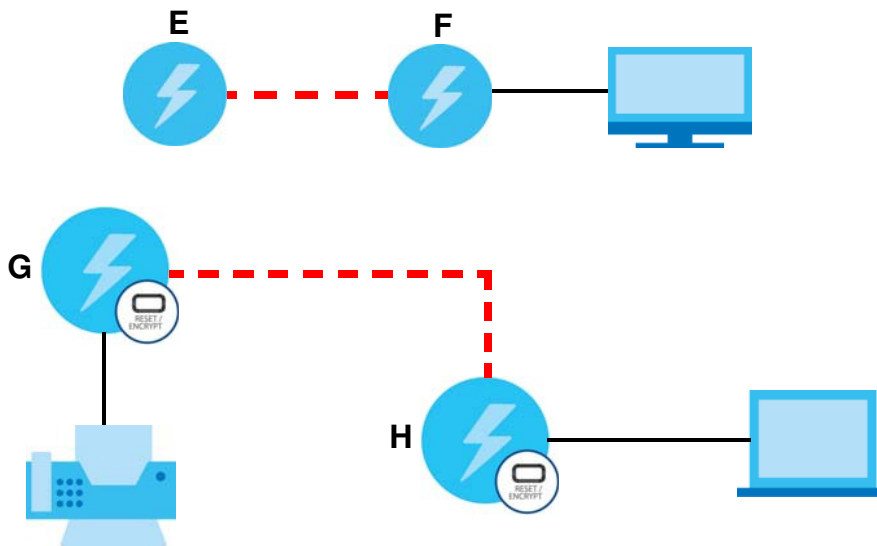

If the HomePlug (📶) lights on both powerline devices do not light up, the powerline devices are not connected. Repeat the connection process, making certain you press the **RESET/ENCRYPT** buttons for the correct time and within two minutes of each other. If that does not work see Section 12.3 on page 65 for suggestions.

## 2.5 One Combination RESET/ENCRYPT Button

The following table summarizes the actions that occur when the **RESET/ENCRYPT** button is pressed for specific lengths of time.

Table 3 **RESET/ENCRYPT**

| TIME             | ACTION   | POWER LIGHT BEHAVIOR  | HOMEPLUG LIGHT BEHAVIOR   |
|------------------|--|---|---|
| 0.5 to 3 seconds | Create a powerline network with a new random network name.<br><br>Join an existing powerline network by sharing the same network name as other devices on the network. | The power (⏻) light blinks until the device is connected. This may take a minute. | The HomePlug (🔌) light turns on if your device is connected to another powerline device or a powerline network. |
| 5 to 8 seconds   | Remove the device from any network it is associated with and its network name assumes a random value.  | The power (⏻) light blinks and then shines steadily.                              | The HomePlug (🔌) light turns off when it disconnects from the powerline network.                                |
| 10 to 15 seconds | Clear all user-entered configuration information and return the device to its factory defaults.  | The power (⏻) light blinks and then shines steadily.                              | The HomePlug (🔌) light turns off when it disconnects from the powerline network.                                |

Note: The network name is unknown when you use the **RESET/ENCRYPT** button.



---

# **PART II**

## **Web Configurator**

---

# CHAPTER 3

## Introducing the Web Configurator

### 3.1 Overview

This chapter describes how to access the PLA Web Configurator and provides an overview of its screens.

The Web Configurator is an HTML-based management interface that allows easy setup and management of the PLA via Internet browser. Use Internet Explorer 8.0 and later or Safari 2.0 or later versions. The recommended screen resolution is 1024 by 768 pixels.

In order to use the Web Configurator you need to allow:

- Web browser pop-up windows from your device. Web pop-up blocking is enabled by default in Windows XP SP (Service Pack) 2.
- JavaScripts (enabled by default).
- Java permissions (enabled by default).

Refer to the Troubleshooting chapter ([Chapter 12 on page 64](#)) to see how to make sure these functions are allowed in the Internet Explorer.

### 3.2 Accessing the Web Configurator

- 1 Connect your computer to the LAN port of the PLA.
- 2 The default IP address of the PLA is "192.168.1.3". In this case, your computer must have an IP address in the range between "192.168.1.4" and "192.168.1.254".  
Click **Start > Run** on your computer in Windows. Type "cmd" in the dialog box. Enter "ipconfig" to show your computer's IP address. If your computer's IP address is not in the correct range then change your computer's IP address.
- 3 After you've set your computer's IP address, open a web browser such as Internet Explorer and type "http://192.168.1.3" as the web address in your web browser.

#### 3.2.1 Login Screen

The Web Configurator initially displays the following login screen.

**Figure 7** Login screen

Type "1234" (default) as the password.

### 3.2.2 Password Screen

You should see a screen asking you to change your password (highly recommended) as shown next.

**Figure 8** Change Password Screen

The following table describes the labels in this screen.

Table 4 Change Password Screen

| IA BEL                       | DESC RIPTION   |
|------------------------------|--|
| Enter Your New Password Here | Type a new password.   |
| Confirm Password             | Retype the password for confirmation.                                  |
| Change                       | Click <b>Change</b> to save your changes back to the PLA.              |
| Skip                         | Click <b>Skip</b> if you do not want to change the password this time. |

Note: The management session automatically times out when the time period set in the **Administrator Inactivity Timer** field expires (default five minutes; go to [Chapter 11 on page 56](#) to change this). Simply log back into the PLA if this happens.

Right after you log in, the **Dashboard** screen is displayed. See [Chapter 4 on page 23](#) for more information about the **Dashboard** screen.

## 3.3 Navigating the Web Configurator

The following summarizes how to navigate the web configurator from the **Dashboard** screen.

**Figure 9** Status Screen of the Web Configurator

The screenshot shows the ZyXEL PLA5236 Status screen. The title bar (A) displays 'ZyXEL PLA5236' and user options. The navigation panel (B) is on the left. The main window (C) contains three sections: Device Information, System Status, and Interface Status. Device Information lists various system parameters. System Status shows up time and resource usage. Interface Status provides a table of network interfaces.

| Item                 | Data                         |
|----------------------|------------------------------|
| Host Name:           | PLA5236                      |
| Firmware Version:    | V1.00(ABFB.0)b2_160629_R7632 |
| Sys OP Mode:         | AP Mode                      |
| LAN Information:     |                              |
| - MAC Address:       | 00:11:22:00:CC:00            |
| - IP Address:        | 192.168.1.3                  |
| - IP Subnet Mask:    | 255.255.255.0                |
| - Default Gateway:   |                              |
| - DHCP:              | DHCP Client                  |
| WLAN Information:    |                              |
| - WLAN OP Mode:      | Access Point Mode            |
| - MAC Address:       | 00:11:22:00:CC:02            |
| - SSID:              | ZyXEL00cc02                  |
| - Channel:           | 5                            |
| - Security:          | WPA2-PSK                     |
| - WPS Status:        | Unconfigured                 |
| WLAN_SG Information: |                              |
| - WLAN OP Mode:      | Access Point Mode            |
| - MAC Address:       | 00:11:22:00:CC:03            |
| - SSID:              | ZyXEL00cc02 speed            |
| - Channel:           | 40                           |
| - Security:          | WPA2-PSK                     |
| - WPS Status:        | Unconfigured                 |

| Item               | Data                 |
|--------------------|----------------------|
| System Up Time:    | 1day 3hr 51min 36sec |
| Current Date/Time: | 2016-06-30/11:31:38  |
| System Resource:   |                      |
| - CPU Usage:       | 15%                  |
| - Memory Usage:    | 84%                  |

| Interface | Status | Rate |
|-----------|--------|------|
| LAN1      | UP     | 100M |
| LAN2      | Down   |      |
| WLAN      | UP     | 150M |
| WLAN_SG   | UP     | 433M |

As illustrated above, the Web Configurator screen is divided into these parts:

- **A** - title bar
- **B** - navigation panel
- **C** - main window

### 3.3.1 Title Bar

Click **Logout** at any time to exit the Web Configurator.

Click **About** to open the about window, which provides information of the boot module and driver versions.

Click **Easy 123** to select the PLA Wi-Fi mode and give a name and password to identify your PLA in the Wi-Fi network.

### 3.3.2 Navigation Panel

Use the menu items on the navigation panel to open screens to configure PLA features. The following tables describe each menu item.

Table 5 Navigation Panel: Access Point Mode

| LINK                                 | TAB               | FUNCTION   |
|--------------------------------------|-------------------|--|
| Dashboard                            |                   | This screen shows the PLA's general device, system and interface status information. Use this screen to access the summary statistics tables.  |
| <b>MONITOR</b>                       |                   |  |
| Log                                  |                   | Use this screen to view the list of activities recorded by your PLA.   |
| Packet Statistics                    |                   | Use this screen to view port status and packet specific statistics.  |
| WLAN 2.4G Station Status             |                   | Use this screen to view the details about the devices connected to your PLA, using the 2.5G wireless connection.   |
| WLAN 5G Station Status               |                   | Use this screen to view the details about the devices connected to your PLA, using the 5G wireless connection.   |
| <b>CONFIGURATION</b>                 |                   |  |
| Network                              |                   |  |
| Wireless LAN 2.4 and Wireless LAN 5G | General           | Use this screen to configure general wireless LAN and wireless security settings.  |
|                                      | MAC Filter        | Use the MAC filter screen to configure the PLA to block access to devices or block the devices from accessing the PLA.   |
|                                      | Advanced          | This screen allows you to configure advanced wireless settings.  |
|                                      | QoS               | Use this screen to configure Wi-Fi Multimedia Quality of Service (WMM QoS). WMM QoS allows you to prioritize wireless traffic according to the delivery requirements of individual services. |
|                                      | WPS               | Use this screen to configure WPS.  |
|                                      | WPS Station       | Use this screen to add a wireless station using WPS.   |
|                                      | Scheduling        | Use this screen to schedule the times the Wireless LAN is enabled.   |
| LAN                                  | IP                | Use this screen to configure LAN IP address and subnet mask.   |
|                                      | IP Alias          | Use this screen to have the PLA apply IP alias to create LAN subnets.  |
| HomePlug                             | Powerline Setting | Use this screen to view and change powerline settings.   |
| One Connect                          |                   | Use this screen to enable the One Connect feature. <b>One Connect</b> uses an app that allows you to easily integrate the PLA and other devices to your home network.                        |
| <b>MAINTENANCE</b>                   |                   |  |
| General                              |                   | Use this screen to view and change administrative settings such as system and domain names.  |
| Password                             | Password Setup    | Use this screen to change the password of your PLA.  |
| Time                                 | Time Setting      | Use this screen to change your PLA's time and date.  |
| Firmware Upgrade                     |                   | Use this screen to upload firmware to your PLA.  |

Table 5 Navigation Panel: Access Point Mode

| <b>LINK</b>        | <b>TAB</b>     | <b>FUNCTION</b>  |
|--------------------|----------------|--|
| Backup/<br>Restore |                | Use this screen to backup and restore the configuration or reset your PLA to the factory defaults.                         |
| Restart            | System Restart | This screen allows you to reboot the PLA without turning the power off.  |
| Language           | Language       | This screen allows you to select the language you prefer.  |
| WiFi Mode          |                | This screen allows you to select the device Wi-Fi mode: <b>Range Mode</b> , <b>Performance Mode</b> or <b>Mixed Mode</b> . |

# CHAPTER 4

## Dashboard

The **Dashboard** screens display when you log into the PLA, or click **Dashboard** in the navigation menu.

Use the **Dashboard** screen to look at the current status of the device, system resources, and interfaces. The **Dashboard** screens also provide detailed information about system statistics, associated wireless clients, and logs.

### 4.1 The Dashboard Screen

Use this screen to get a quick view of system, Ethernet, WLAN and other information regarding your PLA.

Click **Dashboard**. The following screen displays.

**Figure 10** The Dashboard Screen

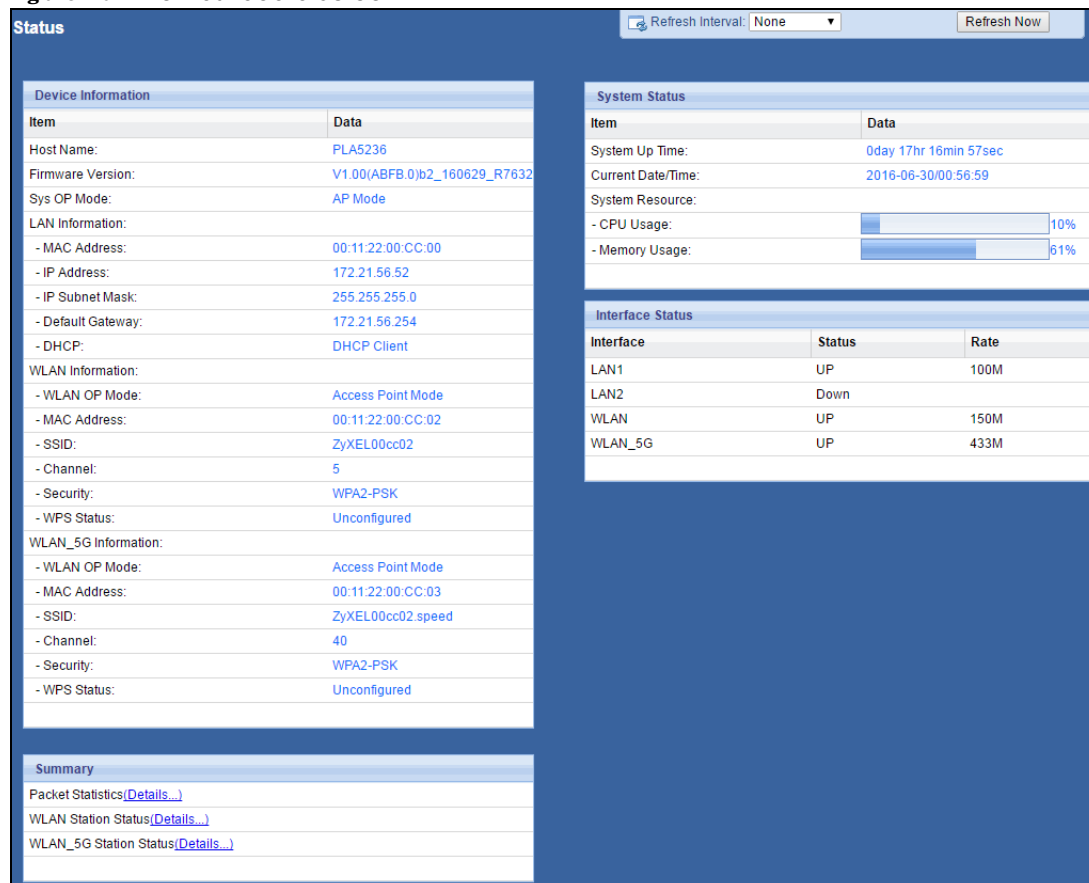

The following table describes the labels in this screen.

Table 6 The Dashboard Screen

| LABEL                  | DESCRIPTION  |
|------------------------|--|
| Refresh Interval       | Select a number of seconds or <b>None</b> from the drop-down list box to refresh all screen statistics automatically at the end of every time interval or to not refresh the screen statistics.                                |
| Refresh Now            | Click this button to refresh the status screen statistics.   |
| Device Information     |  |
| Host Name              | This is the PLA's model name.  |
| Firmware Version       | This is the firmware version and the date created.   |
| Sys OP Mode            | This is the device mode, the PLA works as an Access Point (AP).  |
| LAN Information        |  |
| MAC Address            | This shows the LAN Ethernet adapter MAC Address of your device.  |
| IP Address             | This shows the LAN port's IP address.  |
| IP Subnet Mask         | This shows the LAN port's subnet mask.   |
| Default Gateway        | This shows the gateway IP address.   |
| DHCP                   | This shows the LAN port's DHCP role - <b>Client</b> or <b>None</b> .   |
| WLAN Information       |  |
| WLAN OP Mode           | This is the device mode to which the PLA's 2.4GHz wireless LAN is set - <b>Access Point Mode</b> .   |
| MAC Address            | This shows the wireless adapter MAC Address of your device.  |
| SSID                   | This shows a descriptive name used to identify the PLA in the wireless LAN.  |
| Channel                | This shows the channel number which the PLA is currently using over the wireless LAN.  |
| Security               | This shows the level of wireless security the PLA is using.  |
| WPS Status             | This displays <b>Configured</b> when the WPS has been set up.<br>This displays <b>Unconfigured</b> if the WPS has not been set up.   |
| WLAN_5G Information    |  |
| WLAN OP Mode           | This is the device mode to which the PLA's 5GHz wireless LAN is set - <b>Access Point Mode</b> .   |
| MAC Address            | This shows the wireless adapter MAC Address of your device.  |
| SSID                   | This shows a descriptive name used to identify the PLA in the wireless LAN.  |
| Channel                | This shows the channel number which the PLA is currently using over the wireless LAN.  |
| Security               | This shows the level of wireless security the PLA is using.  |
| WPS Status             | This displays <b>Configured</b> when the WPS has been set up.<br>This displays <b>Unconfigured</b> if the WPS has not been set up.   |
| Summary                |  |
| Packet Statistics      | Click <b>Details...</b> to go to the <b>Monitor &gt; Packet Statistics</b> screen ( <a href="#">Section 6.4 on page 29</a> ). Use this screen to view port status and packet specific statistics.                              |
| WLAN Station Status    | Click <b>Details...</b> to go to the <b>Monitor &gt; WLAN Station Status</b> screen ( <a href="#">Section 6.5 on page 30</a> ). Use this screen to view the 2.4Ghz wireless stations that are currently associated to the PLA. |
| WLAN_5G Station Status | Click <b>Details...</b> to go to the <b>Monitor &gt; WLAN Station Status</b> screen ( <a href="#">Section 6.6 on page 31</a> ). Use this screen to view the 5Ghz wireless stations that are currently associated to the PLA.   |
| System Status          |  |
| Item                   | This column shows the type of data the PLA is recording.   |
| Data                   | This column shows the actual data recorded by the PLA.   |
| System Up Time         | This is the total time the PLA has been on.  |



Table 6 The Dashboard Screen

| LABEL             | DESCRIPTION   |
|-------------------|---|
| Current Date/Time | This field displays your PLA's present date and time.   |
| System Resource   |   |
| CPU Usage         | This displays what percentage of the PLA's processing ability is currently used. When this percentage is close to 100%, the PLA is running at full load, and the throughput is not going to improve anymore. If you want some applications to have more throughput, you should turn off other applications (for example, using bandwidth management). |
| Memory Usage      | This shows what percentage of the heap memory the PLA is using.   |
| Interface Status  |   |
| Interface         | This displays the PLA port types. The port types are: <b>LAN</b> and <b>WLAN</b> .  |
| Status            | For the LAN ports, this field displays <b>Down</b> (line is down) or <b>Up</b> (line is up or connected).<br>For the WLAN, it displays <b>Up</b> when the WLAN is enabled or <b>Down</b> when the WLAN is disabled.   |
| Rate              | For the LAN ports, this displays the port speed or <b>N/A</b> when the line is disconnected.<br>For the WLAN, it displays the maximum transmission rate when the WLAN is enabled and <b>N/A</b> when the WLAN is disabled.  |

# CHAPTER 5

## Connection Wizard

### 5.1 Overview

This Chapter provides information on the Wizard setup screens in the Web Configurator. The Web Configurator Wizard setup helps you configure your device.

### 5.2 Using the Web Configurator Wizard

After you access the PLA Web Configurator, click  to begin the Wizard setup, located in the Title Bar on the Dashboard Screen.

**Figure 11** Wizard Setup Screen

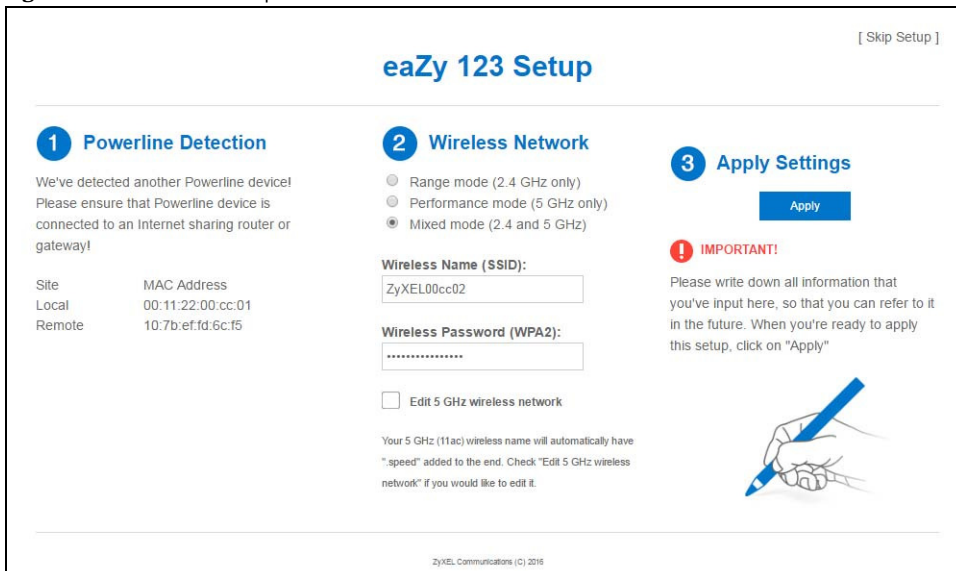

The following table describes the labels in this screen.

Table 7 Wizard Setup Screen

| LABEL               | DESCRIPTION   |
|---------------------|---|
| Powerline Detection | This shows details of the connection between other powerline adapters and your PLA.               |
| Detect Again        | Click <b>Detect Again</b> to refresh your PLA and connect with other powerline Ethernet adapters. |

Table 7 Wizard Setup Screen

| LABEL                      | DESCRIPTION  |
|----------------------------|--|
| Wireless Network           | <p>Use this step to configure your PLA wireless network. Choose one of the Wi-Fi modes.</p> <p><b>Range Mode</b> enables a 2.4GHz Wi-Fi, with a wider range for your Wi-Fi devices. Choose this mode if all your Wi-Fi devices are IEEE 802.11 b/g/n compatible.</p> <p><b>Performance Mode</b> enables a 5GHz Wi-Fi, with a better performance than 2.4Ghz, but a shorter range for your Wi-Fi devices. Choose this mode if all your Wi-Fi devices are IEEE 802.11 a/n/ac compatible.</p> <p><b>Mixed Mode</b> enables both 2.5GHz and 5GHz Wi-Fi for all devices to connect. Choose this mode if you have IEEE 802.11 a/n/ac and IEEE802.11 b/g/n Wi-Fi devices connecting to your wireless network.</p> |
| Wireless Name (SSID)       | Enter a descriptive name used to identify your PLA in the wireless network.  |
| Wireless Password (WPA2)   | Enter the password that lets you connect to the PLA wireless network. Your password should be in a string of ASCII characters between 8 and 63 or hexadecimal characters between 8 and 64.   |
| Edit 5GHz wireless network | <p>For <b>Mixed Mode</b> an additional SSID and password field appear for your 5Ghz wireless network.</p> <p>Click this to view and/or change your 5Ghz wireless network SSID and password.</p>  |
| Apply Settings             | Click <b>Apply</b> to save your settings to the PLA.   |
| Skip Setup                 | Click this to skip the Wizard setup and go to the Dashboard screen.  |

# CHAPTER 6

## Monitor

### 6.1 Overview

This chapter discusses read-only information related to the device state of the PLA.

Note: To access the Monitor screens, you can also click the links in the Summary table of the Status screen to view the packets sent/received as well as the status of clients connected to the PLA.

### 6.2 What You Can Do

- Use the **Log** screen (Section 6.3 on page 28) to view the logs for the categories such as system maintenance, system errors, and so on.
- use the **Packet Statistics** screen (Section 6.4 on page 29) to view port status, packet specific statistics, the "system up time" and so on.
- Use the **WLAN Station Status** screen (Section 6.5 on page 30) to view the wireless stations that are currently associated to the PLA.
- Use the **WLAN\_5G Station Status** screen (Section 6.6 on page 31) to view the wireless stations that are currently associated to the PLA.

### 6.3 Log

Use the **View Log** screen to see the logged messages for the PLA.

Log entries in red indicate system error logs. The log wraps around and deletes the old entries after it fills.

Click **Monitor > Log**.

**Figure 12** Monitor > View Log

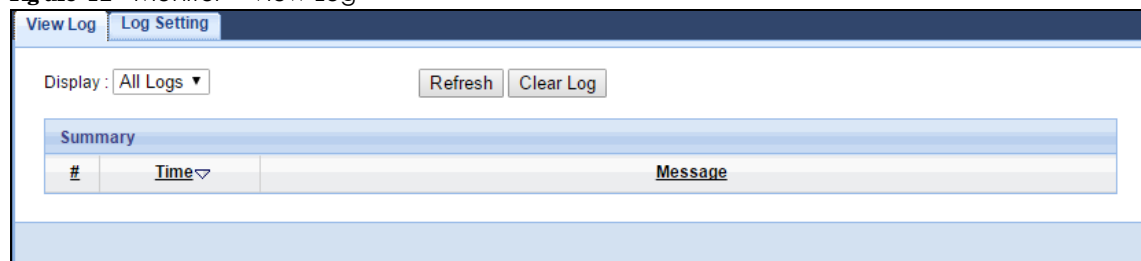

The following table describes the labels in this screen.

Table 8 Monitor > Log

| LABEL     | DESCRIPTION   |
|-----------|---|
| Display   | Select what logs you want to see from the <b>Display</b> drop list. The log choices depend on your settings in the <b>Log Setting</b> screen. |
| Refresh   | Click <b>Refresh</b> to renew the log screen.   |
| Clear Log | Click <b>Clear Log</b> to delete all the logs.  |
| #         | This field is a sequential value and is not associated with a specific entry.   |
| Time      | This field displays the time the log was recorded.  |
| Message   | This field states the reason for the log.   |

You can configure which logs to display in the **View Log** screen. Go to the **Log Setting** screen and select the logs you wish to display. Click **Apply** to save your settings. Click **Cancel** to start the screen afresh.

Figure 13 Monitor > Log Setting

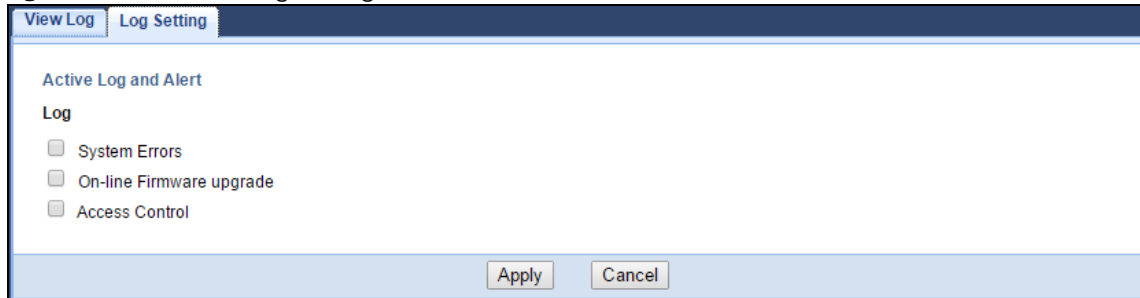

## 6.4 Packet Statistics

Click the **Packet Statistics (Details...)** hyperlink in the **Dashboard** screen or **Monitor > Packet Statistics**. Read-only information here includes port status, packet specific statistics and the "system up time". The **Poll Interval(s)** field is configurable and is used for refreshing the screen.

Figure 14 Monitor > Packet Statistics

| Port    | Status | TxPkts | RxPkts | Collisions | Tx B/s | Rx B/s | Up Time  |
|---------|--------|--------|--------|------------|--------|--------|----------|
| LAN     | 100M   | 149992 | 535449 | 0          | 175    | 879    | 17:56:03 |
| WLAN    | 150M   | 0      | 0      | 0          | 0      | 0      | 17:56:03 |
| WLAN_5G | 433M   | 0      | 0      | 0          | 0      | 0      | 17:56:03 |

System Up Time : 17:56:03  
 Poll Interval(s): None Set Interval Stop Refresh Now

The following table describes the labels in this screen.

Table 9 Monitor > Packet Statistics

| LABEL            | DESCRIPTION   |
|------------------|---|
| Port             | This is the PLA's interface type.   |
| Status           | For the LAN port, this displays the port speed or <b>Down</b> when the line is disconnected.<br>For the WLAN, it displays the maximum transmission rate when the WLAN is enabled and <b>Down</b> when the WLAN is disabled. |
| TxPkts           | This is the number of transmitted packets on this port.   |
| RxPkts           | This is the number of received packets on this port.  |
| Collisions       | This is the number of collisions on this port.  |
| Tx B/s           | This displays the transmission speed in bytes per second on this port.  |
| Rx B/s           | This displays the reception speed in bytes per second on this port.   |
| Up Time          | This is the total time the PLA has been for each session.   |
| System Up Time   | This is the total time the PLA has been on.   |
| Poll Interval(s) | Enter the time interval in seconds for refreshing statistics in this field.   |
| Set Interval     | Click this button to apply the new poll interval you entered in the <b>Poll Interval(s)</b> field.  |
| Stop             | Click <b>Stop</b> to stop refreshing statistics.  |
| Refresh Now      | Click this button to refresh the Packet Statistics screen.  |

## 6.5 WLAN 2.4G Station Status

Click the **WLAN Station Status (Details...)** hyperlink in the **Dashboard** screen or **Monitor > WLAN 2.4G Station Status**. View the 2.4G wireless stations that are currently associated to the PLA in the **Association List**. Association means that a wireless client (for example, your network or computer with a wireless network card) has connected successfully to the PLA using the same SSID, channel and security settings.

Figure 15 Monitor > WLAN Station Status

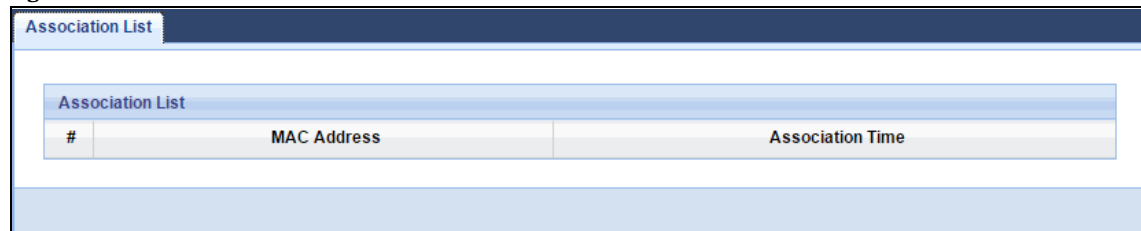

The screenshot shows a web interface titled "Association List". Below the title is a table with three columns: "#", "MAC Address", and "Association Time". The table is currently empty.

The following table describes the labels in this screen.

Table 10 Monitor > WLAN Station Status

| LABEL            | DESCRIPTION   |
|------------------|---|
| #                | This is the index number of an associated wireless station.                                   |
| MAC Address      | This field displays the MAC address of an associated wireless station.                        |
| Association Time | This field displays the time a wireless station first associated with the PLA's WLAN network. |

## 6.6 WLAN 5G Station Status

Click the **WLAN\_5G Station Status (Details...)** hyperlink in the **Dashboard** screen or **Monitor > WLAN 5G Station Status**. View the 5G wireless stations that are currently associated to the PLA in the **Association List**. Association means that a wireless client (for example, your network or computer with a wireless network card) has connected successfully to the PLA using the same SSID, channel and security settings.

**Figure 16** Monitor > WLAN 5G Station Status

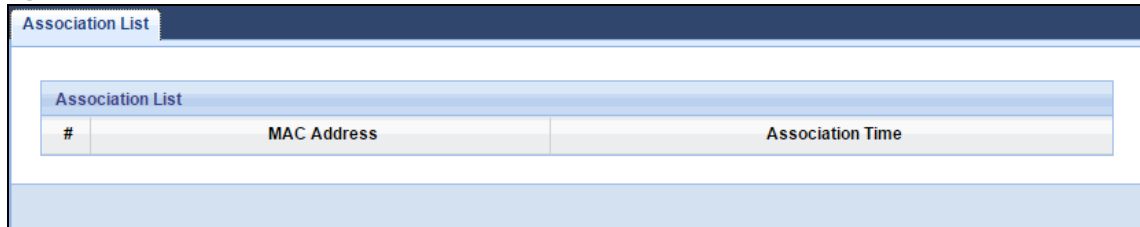

| Association List |             |                  |
|------------------|-------------|------------------|
| #                | MAC Address | Association Time |
|                  |             |                  |

The following table describes the labels in this screen.

Table 11 Monitor > WLAN 5G Station Status

| LABEL            | DESCRIPTION   |
|------------------|---|
| #                | This is the index number of an associated wireless station.                                   |
| MAC Address      | This field displays the MAC address of an associated wireless station.                        |
| Association Time | This field displays the time a wireless station first associated with the PLA's WLAN network. |

# CHAPTER 7

## Wireless LAN

### 7.1 Overview

This chapter discusses how to configure the wireless network settings in your PLA. See the appendices for more detailed information about wireless networks.

The following figure provides an example of a wireless network.

**Figure 17** Example of a Wireless Network

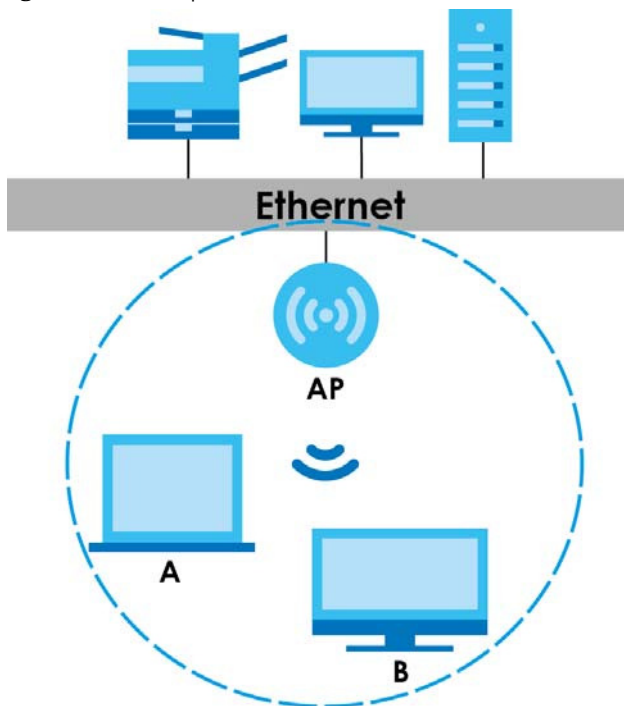

The wireless network is the part in the blue circle. In this wireless network, devices **A** and **B** are called wireless clients. The wireless clients use the access point (AP) to interact with other devices (such as the printer) or with the Internet. Your PLA is the AP.

#### 7.1.1 Powerline Extended Wireless LAN

The PLA is a wireless Powerline Extender (PE) that allows you to extend your original wireless network, connected to a compatible Powerline Adapter (PA) over a power cable. This is the key for items in [Figure 18 on page 33](#):

- PE = Powerline Extender (= PLA here)
- PEN = PE wireless Network





- Use the **Scheduling** screen ([Section 7.11 on page 46](#)) to set the times your wireless LAN is turned on and off.

## 7.3 What You Should Know

Every wireless network must follow these basic guidelines.

- Every wireless client in the same wireless network must use the same SSID.  
The SSID is the name of the wireless network. It stands for Service Set Identity.
- If two wireless networks overlap, they should use different channels.  
Like radio stations or television channels, each wireless network uses a specific channel, or frequency, to send and receive information.
- Every wireless client in the same wireless network must use security compatible with the AP.  
Security stops unauthorized devices from using the wireless network. It can also protect the information that is sent in the wireless network.

### 7.3.1 Wireless Security Overview

The following sections introduce different types of wireless security you can set up in the wireless network.

#### 7.3.1.1 SSID

Normally, the AP acts like a beacon and regularly broadcasts the SSID in the area. You can hide the SSID instead, in which case the AP does not broadcast the SSID. In addition, you should change the default SSID to something that is difficult to guess.

This type of security is fairly weak, however, because there are ways for unauthorized devices to get the SSID. In addition, unauthorized devices can still see the information that is sent in the wireless network.

#### 7.3.1.2 MAC Address Filter

Every wireless client has a unique identification number, called a MAC address.<sup>1</sup> A MAC address is usually written using twelve hexadecimal characters<sup>2</sup>; for example, 00A0C5000002 or 00:A0:C5:00:00:02. To get the MAC address for each wireless client, see the appropriate User's Guide or other documentation.

You can use the MAC address filter to tell the AP which wireless clients are allowed or not allowed to use the wireless network. If a wireless client is allowed to use the wireless network, it still has to have the correct settings (SSID, channel, and security). If a wireless client is not allowed to use the wireless network, it does not matter if it has the correct settings.

This type of security does not protect the information that is sent in the wireless network. Furthermore, there are ways for unauthorized devices to get the MAC address of an authorized wireless client. Then, they can use that MAC address to use the wireless network.

---

1. Some wireless devices, such as scanners, can detect wireless networks but cannot use wireless networks. These kinds of wireless devices might not have MAC addresses.

2. Hexadecimal characters are 0, 1, 2, 3, 4, 5, 6, 7, 8, 9, A, B, C, D, E, and F.

## Encryption

Wireless networks can use encryption to protect the information that is sent in the wireless network. Encryption is like a secret code. If you do not know the secret code, you cannot understand the message.

Table 12 Types of Encryption

|                  |             |
|------------------|-------------|
| <b>Weakest</b>   | No Security |
| ↑<br>↓           | Static WEP  |
|                  | WPA-PSK     |
| <b>Strongest</b> | WPA2-PSK    |

Usually, you should set up the strongest encryption that every wireless client in the wireless network supports. For example, suppose the AP does not have a local user database, and you do not have a RADIUS server. Therefore, there is no user authentication. Suppose the wireless network has two wireless clients. Device A only supports WEP, and device B supports WEP and WPA. Therefore, you should set up **Static WEP** in the wireless network.

Note: It is recommended that wireless networks use **WPA-PSK** or stronger encryption. WEP encryption are better than none at all, but it is still possible for unauthorized devices to figure out the original information pretty quickly.

When you select **WPA2-PSK** in your PLA, you can also select an option (**WPA-PSK Compatible**) to support WPA as well. In this case, if some wireless clients support WPA and some support WPA2, you should set up **WPA2-PSK** and select the **WPA-PSK Compatible** option in the PLA.

Many types of encryption use a key to protect the information in the wireless network. The longer the key, the stronger the encryption. Every wireless client in the wireless network must have the same key.

### 7.3.1.3 WPS

Wi-Fi Protected Setup (WPS) is an industry standard specification, defined by the Wi-Fi Alliance. WPS allows you to quickly set up a wireless network with strong security, without having to configure security settings manually. Depending on the devices in your network, you can either press a button (on the device itself) or enter a PIN (Personal Identification Number) in the devices. Then, they connect and set up a secure network by themselves.

## 7.4 General Wireless LAN Screen

Use this screen to enable or disable the WLAN, enter the SSID, select the channel and configure wireless security settings.

Note: If you are configuring the PLA from a computer connected to the wireless LAN and you change the PLA's SSID, channel or security settings, you will lose your wireless connection when you press **Apply** to confirm. You must then change the wireless settings of your computer to match the PLA's new settings.

Click **Network > Wireless LAN 2.4G or 5G** to open the **General** screen.

**Figure 19** Network > Wireless LAN 2.4G or 5G> General

The following table describes the general wireless LAN labels in this screen.

Table 13 Network &gt; Wireless LAN 2.4G or 5G&gt; General

| IA BEL                 | DESC RIPTION   |
|------------------------|--|
| Wireless Setup         |  |
| Wireless LAN           | Select to enable or disable the wireless LAN. This is turned on by default.  |
| Name (SSID)            | The SSID (Service Set IDentity) identifies the Service Set with which a wireless client is associated. Enter a descriptive name (up to 32 printable characters found on a typical English language keyboard) for the wireless LAN.   |
| Hide SSID              | Select this check box to hide the SSID in the outgoing beacon frame so a wireless client cannot obtain the SSID through scanning using a site survey tool.   |
| Channel Selection      | Set the operating frequency/channel depending on your particular region.<br>Select a channel from the drop-down list box. The options vary depending on the frequency band and the country you are in.<br>This option is only available if <b>Auto Channel Selection</b> is disabled.  |
| Auto Channel Selection | Select the check box to have the PLA automatically scan for and select a channel which is not used by another device.  |
| Operating Channel      | This displays the channel the PLA is currently using.  |
| Channel Width          | Select the wireless channel width used by PLA.<br>A standard 20 MHz channel offers transfer speeds of up to 150Mbps whereas a 40 MHz channel uses two standard channels and offers speeds of up to 300Mbps.<br>Because not all devices support 40 MHz channels, select <b>Auto 20/40 MHz</b> to allow the PLA to adjust the channel bandwidth automatically.<br><b>40 MHz</b> (channel bonding or dual channel) bonds two adjacent radio channels to increase throughput. The wireless clients must also support <b>40 MHz</b> . It is often better to use the 20 MHz setting in a location where the environment hinders the wireless signal.<br>Select <b>20 MHz</b> if you want to lessen radio interference with other wireless devices in your neighborhood or the wireless clients do not support channel bonding. |

Table 13 Network &gt; Wireless LAN 2.4G or 5G&gt; General

| LABEL         | DESCRIPTION  |
|---------------|--|
| 802.11 Mode   | <p>You can select from the following:</p> <ul style="list-style-type: none"> <li>• <b>802.11b</b>: allows either IEEE 802.11b or IEEE 802.11g compliant WLAN devices to associate with the PLA. In this mode, all wireless devices can only transmit at the data rates supported by IEEE 802.11b.</li> <li>• <b>802.11g</b>: allows IEEE 802.11g compliant WLAN devices to associate with the Device. IEEE 802.11b compliant WLAN devices can associate with the PLA only when they use the short preamble type.</li> <li>• <b>802.11bg</b>: allows either IEEE 802.11b or IEEE 802.11g compliant WLAN devices to associate with the PLA. The PLA adjusts the transmission rate automatically according to the wireless standard supported by the wireless devices.</li> <li>• <b>802.11n</b>: allows IEEE 802.11n compliant WLAN devices to associate with the PLA. This can increase transmission rates, although IEEE 802.11b or IEEE 802.11g clients will not be able to connect to the PLA. I</li> <li>• <b>802.11gn</b>: allows either IEEE 802.11g or IEEE 802.11n compliant WLAN devices to associate with the PLA. The transmission rate of your PLA might be reduced.</li> <li>• <b>802.11 bgn</b>: allows IEEE802.11b, IEEE802.11g and IEEE802.11n compliant WLAN devices to associate with the PLA. The transmission rate of your PLA might be reduced.</li> </ul> |
| Security      |  |
| Security Mode | <p>Select <b>Static WEP</b>, <b>WPA-PSK</b>, or <b>WPA2-PSK</b> to add security on this wireless network. The wireless clients which want to associate to this network must have same wireless security settings as this device. After you select to use a security, additional options appears in this screen. See <a href="#">Section 7.5 on page 37</a> for detailed information on different security modes. Or you can select <b>No Security</b> to allow any client to associate this network without authentication.</p> <p>Note: If the WPS function is enabled (default), only <b>No Security</b> and <b>WPA2-PSK</b> are available in this field.</p>  |
| Apply         | Click <b>Apply</b> to save your changes back to the PLA.   |
| Cancel        | Click <b>Cancel</b> to reload the previous configuration for this screen.  |

## 7.5 Wireless Security

The screen varies depending on what you select in the **Security Mode** field.

### 7.5.1 No Security

Select **No Security** to allow wireless clients to communicate with the access points without any data encryption.

Note: If you do not enable any wireless security on your PLA, your network is accessible to any wireless networking device that is within range.

**Figure 20** Network > Wireless LAN 2.4G or 5G > Security: No Security

The following table describes the labels in this screen.

Table 14 Network &gt; Wireless LAN 2.4G or 5G &gt; Security: No Security

| LABEL         | DESCRIPTION   |
|---------------|---|
| Security Mode | Choose <b>No Security</b> from the drop-down list box.                    |
| Apply         | Click <b>Apply</b> to save your changes back to the PLA.                  |
| Cancel        | Click <b>Cancel</b> to reload the previous configuration for this screen. |

## 7.5.2 WEP Encryption

WEP encryption scrambles the data transmitted between the wireless stations and the access points to keep network communications private. It encrypts unicast and multicast communications in a network. Both the wireless stations and the access points must use the same WEP key.

Your PLA allows you to configure up to four 64-bit or 128-bit WEP keys but only one key can be enabled at any one time.

Select **Static WEP** from the **Security Mode** list.

**Figure 21** Network > Wireless LAN 2.4G or 5G > Security: Static WEP

**Wireless Setup**

Wireless LAN :  Enable  Disable

Name (SSID) :

Hide SSID

Channel Selection :   Auto Channel Selection

Operating Channel :

Channel Width :

Channel Mode :

---

**Security**

Security Mode :

---

PassPhrase :

WEP Encryption :

Authentication Method :

**Note:**

64-bit WEP: Enter 5 ASCII characters or 10 hexadecimal characters ("0-9", "A-F") for each Key (1-4).  
 128-bit WEP: Enter 13 ASCII characters or 26 hexadecimal characters ("0-9", "A-F") for each Key (1-4).  
 (Select one WEP key as an active key to encrypt wireless data transmission.)

ASCII  Hex

Key 1

Key 2

Key 3

Key 4

**Note:** No Security and WPA2-PSK can be configured when WPS enabled.

The following table describes the wireless LAN security labels in this screen.

Table 15 Network &gt; Wireless LAN 2.4G or 5G &gt; Security: Static WEP

| LABEL                 | DESCRIPTION  |
|-----------------------|--|
| Security Mode         | Select <b>Static WEP</b> to enable data encryption.  |
| PassPhrase            | Enter a passphrase (up to 26 printable characters) and click <b>Generate</b> .<br><br>A passphrase functions like a password. In WEP security mode, it is further converted by the PLA into a complicated string that is referred to as the "key". This key is requested from all devices wishing to connect to a wireless network.  |
| WEP Encryption        | Select <b>64-bits</b> or <b>128-bits</b> .<br><br>This dictates the length of the security key that the network is going to use.   |
| Authentication Method | Select <b>Auto</b> or <b>Shared Key</b> from the drop-down list box.<br><br>This field specifies whether the wireless clients have to provide the WEP key to login to the wireless client. Keep this setting at <b>Auto</b> unless you want to force a key verification before communication between the wireless client and the PLA occurs.<br><br>Select <b>Shared Key</b> to force the clients to provide the WEP key prior to communication. |
| ASCII                 | Select this option in order to enter ASCII characters as WEP key.  |

Table 15 Network &gt; Wireless LAN 2.4G or 5G &gt; Security: Static WEP

| LABEL          | DESCRIPTION   |
|----------------|---|
| Hex            | Select this option in order to enter hexadecimal characters as a WEP key.<br>The preceding "0x", that identifies a hexadecimal key, is entered automatically.   |
| Key 1 to Key 4 | The WEP keys are used to encrypt data. Both the PLA and the wireless stations must use the same WEP key for data transmission.<br><br>If you chose <b>64-bit WEP</b> , then enter any 5 ASCII characters or 10 hexadecimal characters ("0-9", "A-F").<br><br>If you chose <b>128-bit WEP</b> , then enter 13 ASCII characters or 26 hexadecimal characters ("0-9", "A-F").<br><br>You must configure at least one key, only one key can be activated at any one time. The default key is key 1. |
| Apply          | Click <b>Apply</b> to save your changes back to the PLA.  |
| Cancel         | Click <b>Cancel</b> to reload the previous configuration for this screen.   |

### 7.5.3 WPA-PSK/ WPA2-PSK

Select **WPA-PSK** or **WPA2-PSK** from the **Security Mode** list.

Figure 22 Network &gt; Wireless LAN 2.4G or 5G &gt; Security: WPA2-PSK

The screenshot shows the configuration page for Wireless LAN Security, specifically for WPA2-PSK. The page is divided into several sections:

- Wireless Setup:**
  - Wireless LAN:  Enable  Disable
  - Name (SSID):
  - Hide SSID
  - Channel Selection:   Auto Channel Selection
  - Operating Channel:
  - Channel Width:
  - Channel Mode:
- Security:**
  - Security Mode:
  - WPA-PSK Compatible
  - Pre-Shared Key:
  - Group Key Update Timer:  seconds
- Note:** No Security and WPA2-PSK can be configured when WPS enabled.

At the bottom of the page, there are two buttons: **Apply** and **Cancel**.



The following table describes the labels in this screen.

Table 16 Network > Wireless LAN 2.4G or 5G > Security: WPA-PSK/WPA2-PSK

| LABEL                  | DESCRIPTION   |
|------------------------|---|
| Security Mode          | Select <b>WPA-PSK</b> or <b>WPA2-PSK</b> to enable data encryption.   |
| WPA-PSK Compatible     | This field appears when you choose <b>WPA2-PSK</b> as the <b>Security Mode</b> .<br>Check this field to allow wireless devices using <b>WPA-PSK</b> security mode to connect to your PLA. |
| Pre-Shared Key         | <b>WPA-PSK/ WPA2-PSK</b> uses a simple common password for authentication.<br>Type a pre-shared key from 8 to 63 case-sensitive keyboard characters.                                      |
| Group Key Update Timer | The <b>Group Key Update Timer</b> is the rate at which the AP sends a new group key out to all clients.<br>The default is <b>3600</b> seconds (60 minutes).                               |
| Apply                  | Click <b>Apply</b> to save your changes back to the PLA.  |
| Cancel                 | Click <b>Cancel</b> to reload the previous configuration for this screen.   |

## 7.6 MAC Filter

The MAC filter screen allows you to configure the PLA to give exclusive access to devices (Allow) or exclude devices from accessing the PLA (Deny). Every Ethernet device has a unique MAC (Media Access Control) address. The MAC address is assigned at the factory and consists of six pairs of hexadecimal characters, for example, 00:A0:C5:00:00:02. You need to know the MAC address of the devices to configure this screen.

To change your PLA's MAC filter settings, click **Network > Wireless LAN 2.4G or 5G > MAC Filter**. The screen appears as shown.

**Figure 23** Network > Wireless LAN 2.4G or 5G > MAC Filter

General | **MAC Filter** | Advanced | QoS | WPS | WPS Station | Scheduling

MAC Address Filter :  Enable  Disable

Filter Action :  Allow  Deny

| MAC Filter Summary |                   |     |                   |
|--------------------|-------------------|-----|-------------------|
| Set                | MAC Address       | Set | MAC Address       |
| 1                  | 00:00:00:00:00:00 | 17  | 00:00:00:00:00:00 |
| 2                  | 00:00:00:00:00:00 | 18  | 00:00:00:00:00:00 |
| 3                  | 00:00:00:00:00:00 | 19  | 00:00:00:00:00:00 |
| 4                  | 00:00:00:00:00:00 | 20  | 00:00:00:00:00:00 |
| 5                  | 00:00:00:00:00:00 | 21  | 00:00:00:00:00:00 |
| 6                  | 00:00:00:00:00:00 | 22  | 00:00:00:00:00:00 |
| 7                  | 00:00:00:00:00:00 | 23  | 00:00:00:00:00:00 |
| 8                  | 00:00:00:00:00:00 | 24  | 00:00:00:00:00:00 |
| 9                  | 00:00:00:00:00:00 | 25  | 00:00:00:00:00:00 |
| 10                 | 00:00:00:00:00:00 | 26  | 00:00:00:00:00:00 |
| 11                 | 00:00:00:00:00:00 | 27  | 00:00:00:00:00:00 |
| 12                 | 00:00:00:00:00:00 | 28  | 00:00:00:00:00:00 |
| 13                 | 00:00:00:00:00:00 | 29  | 00:00:00:00:00:00 |
| 14                 | 00:00:00:00:00:00 | 30  | 00:00:00:00:00:00 |
| 15                 | 00:00:00:00:00:00 | 31  | 00:00:00:00:00:00 |
| 16                 | 00:00:00:00:00:00 | 32  | 00:00:00:00:00:00 |

Apply Cancel

The following table describes the labels in this menu.

Table 17 Network &gt; Wireless LAN 2.4G or 5G &gt; MAC Filter

| LABEL              | DESCRIPTION   |
|--------------------|---|
| MAC Address Filter | Select to turn on ( <b>Enable</b> ) or off ( <b>Disable</b> ) MAC address filtering.  |
| Filter Action      | Define the filter action for the list of MAC addresses in the <b>MAC Filter Summary</b> table.<br>Select <b>Allow</b> to permit access to the PLA, MAC addresses not listed will be denied access to the PLA.<br>Select <b>Deny</b> to block access to the PLA, MAC addresses not listed will be allowed to access the PLA. |
| MAC Filter Summary |   |
| Set                | This is the index number of the MAC address.  |
| MAC Address        | Enter the MAC address of the wireless station that are allowed or denied access to the PLA.   |
| Apply              | Click <b>Apply</b> to save your changes back to the PLA.  |
| Cancel             | Click <b>Cancel</b> to reload the previous configuration for this screen.   |

## 7.7 Wireless LAN Advanced Screen

Use this screen to allow wireless advanced features, such as the output power, and RTS/CTS Threshold.

Click **Network > Wireless LAN 2.4G or 5G > Advanced**. The screen appears as shown.

**Figure 24** Network > Wireless LAN 2.4G or 5G > Advanced

The following table describes the labels in this screen.

Table 18 Network > Wireless LAN 2.4G or 5G > Advanced

| LABEL                   | DESCRIPTION  |
|-------------------------|--|
| RTS/CTS Threshold       | Data with its frame size larger than this value will perform the RTS (Request To Send)/CTS (Clear To Send) handshake.<br><br>Note: If you select <b>802.11n</b> , <b>802.11gn</b> or <b>802.11bgn</b> in the <b>Wireless LAN 2.4G or 5G &gt; General</b> screen, this field is not configurable and the PLA automatically changes to use the maximum value.  |
| Fragmentation Threshold | The threshold (number of bytes) for the fragmentation boundary for directed messages. It is the maximum data fragment size that can be sent.<br><br>Note: If you select <b>802.11n</b> , <b>802.11gn</b> or <b>802.11bgn</b> in the <b>Wireless LAN 2.4G or 5G &gt; General</b> screen, this field is not configurable and the PLA automatically changes to use the maximum value.   |
| Intra-BSS Traffic       | A Basic Service Set (BSS) exists when all communications between wireless clients or between a wireless client and a wired network client go through one access point (AP).<br><br>Intra-BSS traffic is traffic between wireless clients in the BSS. When Intra-BSS traffic is enabled, wireless clients can access the wired network and communicate with each other. When Intra-BSS traffic is disabled, wireless clients can still access the wired network but cannot communicate with each other. |
| Tx Power                | Set the output power of the PLA in this field. If there is a high density of APs in an area, decrease the output power of the PLA to reduce interference with other APs. Select one of the following <b>100%</b> , <b>90%</b> , <b>75%</b> , <b>50%</b> , <b>25%</b> or <b>10%</b> .   |
| Apply                   | Click <b>Apply</b> to save your changes back to the PLA.   |
| Cancel                  | Click <b>Cancel</b> to reload the previous configuration for this screen.  |

## 7.8 Quality of Service (QoS) Screen

The QoS screen allows you to automatically give a service (such as VoIP and video) a priority level.

Click **Network > Wireless LAN 2.4G or 5G > QoS**. The following screen appears.

**Figure 25** Network > Wireless LAN 2.4G or 5G > QoS

WMM QoS:  Enable  Disable

**Note:**  
When the wireless mode contains N mode, wmm support will be enabled automatically.

Apply Cancel

The following table describes the labels in this screen.

Table 19 Network &gt; Wireless LAN 2.4G or 5G &gt; QoS

| LABEL   | DESCRIPTION   |
|---------|---|
| WMM QoS | Select <b>Enable</b> to have the PLA automatically give a service a priority level according to the ToS value in the IP header of packets it sends. WMM QoS (Wifi MultiMedia Quality of Service) gives high priority to voice and video, which makes them run more smoothly.<br><br>Note: If you select <b>802.11n</b> , <b>802.11gn</b> or <b>802.11bgn</b> in the <b>Wireless LAN 2.4G or 5G &gt; General</b> screen, this field is not configurable and the PLA automatically enables WMM QoS. |
| Apply   | Click <b>Apply</b> to save your changes to the PLA.   |
| Cancel  | Click <b>Cancel</b> to reload the previous configuration for this screen.   |

## 7.9 WPS Screen

Use this screen to enable/disable WPS, view or generate a new PIN number and check current WPS status. To open this screen, click **Network > Wireless LAN 2.4G or 5G > WPS** tab.

**Figure 26** Network > Wireless LAN 2.4G or 5G > WPS

**WPS Setup**

WPS:  Enable  Disable

PIN Code:  Enable  Disable

PIN Number:

---

**WPS Status**

Status: Configured

802.11 Mode: 802.11bgn

SSID: ZyXEL00cc02

Security: WPA2-PSK

Apply Cancel

The following table describes the labels in this screen.

Table 20 Network > Wireless LAN 2.4G or 5G > WPS

| LABEL                 | DESCRIPTION   |
|-----------------------|---|
| WPS Setup             |   |
| WPS                   | Select <b>Enable</b> to turn on the WPS feature. Otherwise, select <b>Disable</b> .   |
| PIN Code              | Select <b>Enable</b> and click <b>Apply</b> to allow the PIN Configuration method. If you select <b>Disable</b> , you cannot create a new PIN number.   |
| PIN Number            | This is the WPS PIN (Personal Identification Number) of the PLA.<br><br>The PIN is not necessary when you use WPS push-button method.<br><br>Click <b>Generate</b> to generate a new PIN number.  |
| WPS Status            |   |
| Status                | This displays <b>Configured</b> when the PLA has connected to a wireless network using WPS or when <b>Enable WPS</b> is selected and wireless or wireless security settings have been changed. The current wireless and wireless security settings also appear in the screen.<br><br>This displays <b>Unconfigured</b> if WPS is disabled and there are no wireless or wireless security changes on the PLA or you click <b>Release_Configuration</b> to remove the configured wireless and wireless security settings. |
| Release Configuration | This button is only available when the WPS status displays <b>Configured</b> .<br><br>Click this button to remove all configured wireless and wireless security settings for WPS connections on the PLA.  |
| 802.11 Mode           | This is the 802.11 mode used. Only compliant WLAN devices can associate with the PLA.   |
| SSID                  | This is the name of the wireless network (the PLA's first SSID).  |
| Security              | This is the type of wireless security employed by the network.  |
| Apply                 | Click <b>Apply</b> to save your changes back to the PLA.  |
| Cancel                | Click <b>Cancel</b> to reload the previous configuration for this screen.   |

## 7.10 WPS Station Screen

Use this screen when you want to add a wireless station using WPS. To open this screen, click **Network > Wireless LAN 2.4G or 5G > WPS Station** tab.

Figure 27 Network > Wireless LAN 2.4G or 5G > WPS Station

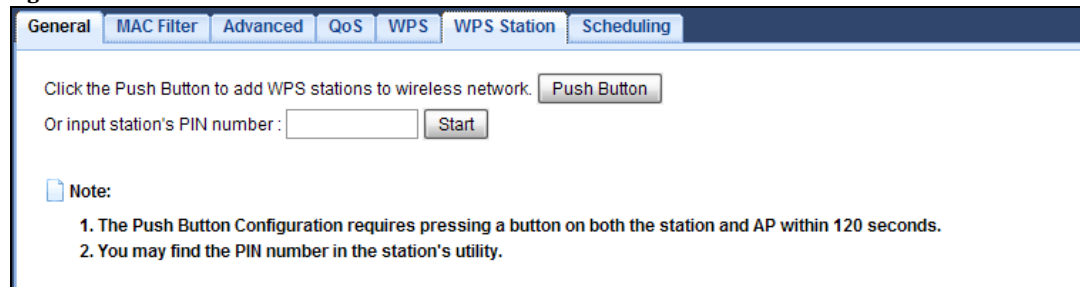

The following table describes the labels in this screen.

Table 21 Network > Wireless LAN 2.4G or 5G > WPS Station

| LABEL                         | DESCRIPTION   |
|-------------------------------|---|
| Push Button                   | Use this button when you use the PBC (Push Button Configuration) method to configure wireless station's wireless settings.<br><br>Click this to start WPS-aware wireless station scanning and the wireless security information synchronization.  |
| Or input station's PIN number | Use this button when you use the PIN Configuration method to configure wireless station's wireless settings.<br><br>Type the same PIN number generated in the wireless station's utility. Then click <b>Start</b> to associate to each other and perform the wireless security information synchronization. |

## 7.11 Scheduling Screen

Use this screen to set the times your wireless LAN is turned on and off. Wireless LAN scheduling is disabled by default. The wireless LAN can be scheduled to turn on or off on certain days and at certain times. To open this screen, click **Network > Wireless LAN 2.4G or 5G > Scheduling** tab.

Figure 28 Network > Wireless LAN 2.4G or 5G > Scheduling

Wireless LAN Scheduling :  Enable  Disable

| Scheduling  |   |  |                    |
|---|---|--|--------------------|
| WLAN status   | Day                                     | For the following times (24-Hour Format) |                    |
| <input checked="" type="radio"/> On <input type="radio"/> Off | <input type="checkbox"/> Everyday       | 00 (hour) 00 (min) ~                     | 00 (hour) 00 (min) |
| <input type="radio"/> On <input checked="" type="radio"/> Off | <input checked="" type="checkbox"/> Mon | 00 (hour) 00 (min) ~                     | 00 (hour) 00 (min) |
| <input type="radio"/> On <input checked="" type="radio"/> Off | <input checked="" type="checkbox"/> Tue | 00 (hour) 00 (min) ~                     | 00 (hour) 00 (min) |
| <input type="radio"/> On <input checked="" type="radio"/> Off | <input checked="" type="checkbox"/> Wed | 00 (hour) 00 (min) ~                     | 00 (hour) 00 (min) |
| <input type="radio"/> On <input checked="" type="radio"/> Off | <input checked="" type="checkbox"/> Thu | 00 (hour) 00 (min) ~                     | 00 (hour) 00 (min) |
| <input type="radio"/> On <input checked="" type="radio"/> Off | <input checked="" type="checkbox"/> Fri | 00 (hour) 00 (min) ~                     | 00 (hour) 00 (min) |
| <input type="radio"/> On <input checked="" type="radio"/> Off | <input type="checkbox"/> Sat            | 00 (hour) 00 (min) ~                     | 00 (hour) 00 (min) |
| <input type="radio"/> On <input checked="" type="radio"/> Off | <input type="checkbox"/> Sun            | 00 (hour) 00 (min) ~                     | 00 (hour) 00 (min) |

Note:  
Specify the same begin time and end time means the whole day schedule.

Apply Cancel

The following table describes the labels in this screen.

Table 22 Network > Wireless LAN 2.4G or 5G > Scheduling

| LABEL                   | DESCRIPTION  |
|-------------------------|--|
| Wireless LAN Scheduling | Select <b>Enable</b> to activate the wireless LAN scheduling feature. Select <b>Disable</b> to turn it off.  |
| Scheduling              |  |
| WLAN Status             | Select <b>On</b> or <b>Off</b> to specify whether the Wireless LAN is turned on or off. This field works in conjunction with the <b>Day</b> and <b>For the following times</b> fields. |

Table 22 Network &gt; Wireless LAN 2.4G or 5G &gt; Scheduling

| LABEL                                    | DESCRIPTION  |
|--|--|
| Day                                      | Select <b>Everyday</b> or the specific days to turn the Wireless LAN on or off. If you select <b>Everyday</b> you can not select any specific days. This field works in conjunction with the <b>For the following times</b> field.   |
| For the following times (24-Hour Format) | Select a begin time using the first set of <b>hour</b> and minute ( <b>min</b> ) drop down boxes and select an end time using the second set of <b>hour</b> and minute ( <b>min</b> ) drop down boxes. If you have chosen <b>On</b> earlier for the WLAN Status the Wireless LAN will turn on between the two times you enter in these fields. If you have chosen <b>Off</b> earlier for the WLAN Status the Wireless LAN will turn off between the two times you enter in these fields. |
| Apply                                    | Click <b>Apply</b> to save your changes back to the PLA.   |
| Cancel                                   | Click <b>Cancel</b> to reload the previous configuration for this screen.  |

# CHAPTER 8

# LAN

## 8.1 Overview

This chapter describes how to configure LAN settings.

A Local Area Network (LAN) is a shared communication system to which many computers are attached. A LAN is a computer network limited to the immediate area, usually the same building or floor of a building. The LAN screens can help you configure the manage IP address, and partition your physical network into logical networks.

**Figure 29** LAN Example

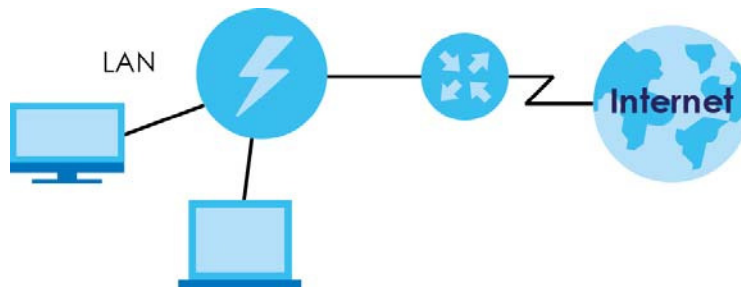

The LAN screens can help you manage IP addresses.

## 8.2 What You Can Do

- Use the **IP** screen ([Section 8.4 on page 49](#)) to change the IP address for your PLA and DNS server information.
- Use the **IP Alias** screen ([Section 8.5 on page 50](#)) to have the PLA apply IP alias to create LAN subnets.

## 8.3 What You Need To Know

There are two separate IP networks, one inside the LAN network and the other outside the WAN network as shown next.

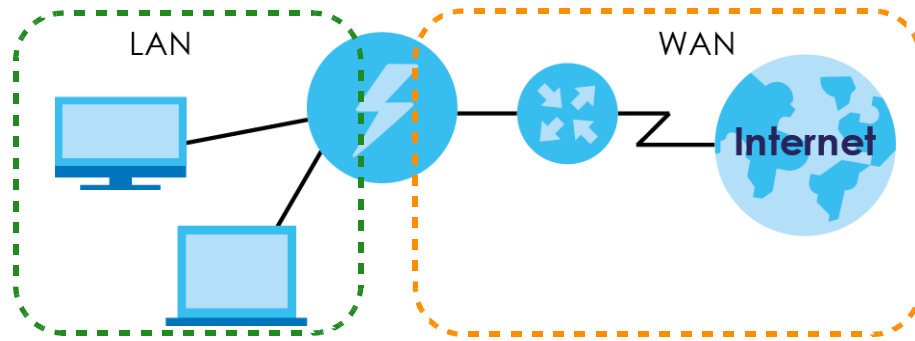

**Figure 30** LAN and WAN IP Addresses

The LAN parameters of the PLA are preset in the factory with the following values:

- IP address of 192.168.1.2 with subnet mask of 255.255.255.0 (24 bits)

### 8.3.1 LAN TCP/IP

The PLA has built-in DHCP server capability that assigns IP addresses and DNS servers to systems that support DHCP client capability.

### 8.3.2 IP Alias

IP alias allows you to partition a physical network into different logical networks over the same Ethernet interface. The PLA supports three logical LAN interfaces via its single physical Ethernet interface with the PLA itself as the gateway for each LAN network.

## 8.4 LAN IP Screen

Use this screen to change the IP address for your PLA. Click **Network > LAN > IP**.

**Figure 31** Network > LAN > IP (Access Point or Universal Repeater)

The following table describes the labels in this screen.

Table 23 Network > LAN > IP

| LABEL                                 | DESCRIPTION  |
|---------------------------------------|--|
| Obtain an IP Address Automatically    | Click this to deploy the PLA as a DHCP client in the network.<br><br>When you enable this, the PLA gets its IP address from the network's DHCP server (for example, your ISP or router). Users connected to the PLA can now access the network (i.e., the Internet if the IP address is given by the ISP or a router with Internet access).<br><br>The Web Configurator may no longer be accessible unless you know the IP address assigned by the DHCP server to the PLA. Otherwise, you need to reset the PLA to be able to access the Web Configurator again (see <a href="#">Section 11.7 on page 61</a> for details on how to reset the PLA).<br><br>Also when you select this, you cannot enter an IP address for your PLA in the field below. |
| Static IP Address                     | Click this if you want to specify the IP address of your PLA. Or if your ISP or network administrator gave you a static IP address to access the network or the Internet.  |
| IP Address                            | Type the IP address in dotted decimal notation. The default setting is 192.168.1.2. If you change the IP address you will have to log in again with the new IP address.  |
| Subnet Mask                           | The subnet mask specifies the network number portion of an IP address.   |
| Gateway IP Address                    | Enter a gateway IP address (if your ISP or network administrator gave you one) in this field.  |
| DNS Server                            |  |
| First DNS Server<br>Second DNS Server | Select <b>Obtained From ISP</b> if your ISP or router to which the PLA connects dynamically assigns DNS server information (and the PLA's WAN IP address). The field to the right displays the (read-only) DNS server IP address that the ISP assigns.<br><br>Select <b>User-Defined</b> if you have the IP address of a DNS server. Enter the DNS server's IP address in the field to the right.<br><br>Select <b>None</b> if you do not want to configure DNS servers. If you do not configure a DNS server, you must know the IP address of a computer in order to access it.   |
| Apply                                 | Click <b>Apply</b> to save your changes back to the PLA.   |
| Cancel                                | Click <b>Cancel</b> to reload the previous configuration for this screen.  |

## 8.5 IP Alias Screen

Use this screen to have the PLA apply IP alias to create LAN subnets. Click **LAN > IP Alias**.

Figure 32 Network > LAN > IP Alias

The following table describes the labels in this screen.

Table 24 Network > LAN > IP Alias

| <b>LABEL</b>   | <b>DESCRIPTION</b>  |
|----------------|---|
| IP Alias       | Check this to enable IP alias.  |
| IP Address     | Type the IP alias address of your PLA in dotted decimal notation.         |
| IP Subnet Mask | The subnet mask specifies the network number portion of an IP address.    |
| Apply          | Click <b>Apply</b> to save your changes back to the PLA.                  |
| Cancel         | Click <b>Cancel</b> to reload the previous configuration for this screen. |

# CHAPTER 9

## Home Plug

### 9.1 Overview

This chapter describes how to configure powerline settings. See [Chapter 4 on page 23](#) for more information about powerline network security.

### 9.2 What You Can Do

Use the **Home Plug** screen ([Section 9.3 on page 52](#)) to secure, manage and set up Quality of Service (QoS) on your powerline network.

### 9.3 Home Plug Screen

Use this screen to change the powerline settings for your PLA. Click **Network > Home Plug**.

**Figure 33** Network > HomePlug

The screenshot shows the 'Powerline Setting' configuration page. It includes a 'Network Name' field, a 'Network Topology' dropdown, and a 'Refresh Interval' dropdown set to 'None'. A table lists the 'Local' site with MAC address '00:12:0E:11:13:1A'. There is a 'Scan' button, a 'DAK Password' field with a 'Save' button, and a note about password format. Below that is a 'Network Name(NMK)' field set to 'HomePlugAV' with radio buttons for 'Set NMK to this device' and 'Set NMK to all devices', and a 'Write' button. At the bottom, a 'Network Information' section shows the 'Central Coordinator MAC' as '00:12:0E:11:13:1A' and a table with columns for 'Site', 'MAC Address', 'Transmit Rate(Mbps)', and 'Receive Rate(Mbps)'.

| Site                        | MAC Address       | DAK Password |
|-----------------------------|-------------------|--------------|
| <input type="radio"/> Local | 00:12:0E:11:13:1A |              |

DAK Password:  Save

Note: You can find your MAC Address and DAK Password on your device's back label, and the password format should be "XXXX-XXXX-XXXX-XXXX-XXXX-XXXX".

Network Name(NMK):

Set NMK to this device  
 Set NMK to all devices

Write

Network Information

Central Coordinator MAC: 00:12:0E:11:13:1A

| Site | MAC Address | Transmit Rate(Mbps) | Receive Rate(Mbps) |
|------|-------------|---------------------|--------------------|
|------|-------------|---------------------|--------------------|

The following table describes the labels in this screen.

Table 25 Configuration Screen

| LABEL   | DESCRIPTION   |
|---|---|
| Network   |   |
| Refresh Interval  | Select a number of seconds or <b>None</b> from the drop-down list box to update the powerline network information automatically at the end of every time interval or to not refresh the powerline network information.  |
| <p>The fields described below are used to identify the powerline adapters recognized on the powerline network. Click <b>Scan</b> to refresh the information in these fields (immediately).</p> <p>Note: Only devices which share the same network name are displayed in this table.</p> |   |
| Site  | <p>This field displays</p> <ul style="list-style-type: none"> <li>• <b>Local</b>, if it is identifying the powerline adapter directly connected to the computer running the Web Configurator.</li> <li>• <b>Remote</b>, if it is a powerline adapter in your powerline network but not directly connected to the computer running the Web Configurator.</li> </ul>  |
| MAC Address   | This is a read-only field which shows the MAC address of the powerline adapter you are configuring. You can find the MAC address of your PLA displayed on a sticker on the bottom of your device.   |
| DAK Password  | <p>DAK (Device Access Key) password is used to verify that you are authorized to perform changes on a remote device. You can find the DAK password printed on a sticker on the bottom of your PLA.</p> <p>Select the remote powerline adapter you want to manage by clicking the MAC address which corresponds to it in the <b>MAC Address</b> column. Enter the <b>DAK Password</b> value and click <b>Save</b>.</p> <p>Note: You must enter the DAK Password value exactly as it is printed on the label (all caps and with dashes "-").</p>  |
| Network Name (NMK)  | <p>The default network name (sometimes called a network password or network membership key (NMK)) of the PLA is "<b>HomePlugAV</b>". HomePlug compatible devices use the same network name to recognize and communicate with each other over the powerline network. If you change the network name of one device on the network, it will no longer be recognized as part of that network.</p> <p>If you change the network name, make sure you change the network name for all of the powerline adapters that you want to be part of your powerline network.</p> <p>The network name can be from 8 to 64 characters in length, using "A"~"Z", "a"~"z", "0"~"9"; spaces are not allowed.</p> |
| Set NMK to this device  | Select this to apply the NMK (entered in the field above) as the network name for the powerline adapter directly connected to the computer running the Web Configurator.  |
| Set NMK to all devices  | Select this to apply the NMK (entered in the field above) as the network name for all powerline adapter detected by the Web Configurator.   |
| Write   | <p>Click this to apply your changes. The new <b>Network Name</b> is applied to the selected powerline adapter.</p> <p>Note: You must enter the correct DAK password for the selected powerline adapter before you can make changes to it.</p>   |
| Network Information   |   |
| Central Coordinator MAC   | The Central Coordinator of the powerline network is the powerline adapter which keeps track of which devices are part of the network as well as synchronizes communication within the powerline network. If the Central Coordinator is removed from the powerline network then another powerline adapter takes its place. This field displays the MAC address of the PLA which is the Central Coordinator of the powerline network. The powerline adapters in your powerline network automatically select the Central Coordinator.  |

Table 25 Configuration Screen (continued)

| LABEL   | DESCRIPTION   |
|---|---|
| <p>The information provided in the following table reflects transmission rate information about the powerline adapters which communicate in your powerline network.</p> <p>The powerline adapters listed in this table are all the powerline adapters in your powerline network except the powerline adapter selected in the table of the <b>Network Name</b> section. In other words, if the <b>Local</b> powerline adapter is selected in the table of the <b>Network Name</b> section, then this table will display the rates of transmission from the powerline adapter connected to the computer running the Web Configurator to all the <b>Remote</b> powerline adapters.</p> |   |
| Site  | <p>This field displays:</p> <ul style="list-style-type: none"> <li>• <b>Local</b>, if it is the PLA directly connected to the computer running the Web Configurator.</li> <li>• <b>Remote</b>, if it is a PLA in your powerline network but not directly connected to the computer running the Web Configurator.</li> </ul>   |
| MAC Address   | <p>This field displays the MAC address of your powerline adapter. The MAC address of your powerline adapter can be found by looking at the label on your device. It consists of six pairs of hexadecimal characters (hexadecimal characters are "0-9" and "a-f"). In the case of the PLA, this label is on the bottom of the device.</p>  |
| Transmit Rate (Mbps)  | <p>This field displays how fast information is sent from the powerline adapter selected in the table of the <b>Network Name</b> section to this powerline adapter. The rate is given in the following format: "application data transmission rate / raw data transmission rate". Application data reflects more accurately how fast devices are transmitting application relevant traffic (for example Internet Protocol (IP) traffic). Raw data refers to the whole payload of the packets transmitted across the powerline network.</p>     |
| Receive Rate (Mbps)   | <p>This field displays how fast information is received from the powerline adapter selected in the table of the <b>Network Name</b> section to this powerline adapter. The rate is given in the following format: "application data transmission rate / raw data transmission rate". Application data reflects more accurately how fast devices are transmitting application relevant traffic (for example Internet Protocol (IP) traffic). Raw data refers to the whole payload of the packets transmitted across the powerline network.</p> |

# CHAPTER 10

## One Connect

### 10.1 Overview

This chapter describes the One Connect feature. This feature uses an app that allows you to easily integrate the PLA and other devices to your home network. Through the app you can view a neighbor device list, along with detailed information, such as each device's address, firmware version and description of its physical location previously noted by the administrator. One Connect can be used to remotely turn the power of a neighboring powered device (PD), on or off from a distance. And most importantly, you can easily set up notifications, customize and control all the devices in your network using your smart phone or tablet.

### 10.2 What You Can Do

Use the **One Connect** screen ([Section 10.3 on page 55](#)) to enable this One Connect feature and access your PLA through the Zyxel app.

### 10.3 One Connect Screen

The One Connect screen has a QR code to help you download the app. Use this screen to **Enable** or **Disable** the One Connect feature in your PLA.

**Figure 34** Network > One Connect> Auto-Configuration

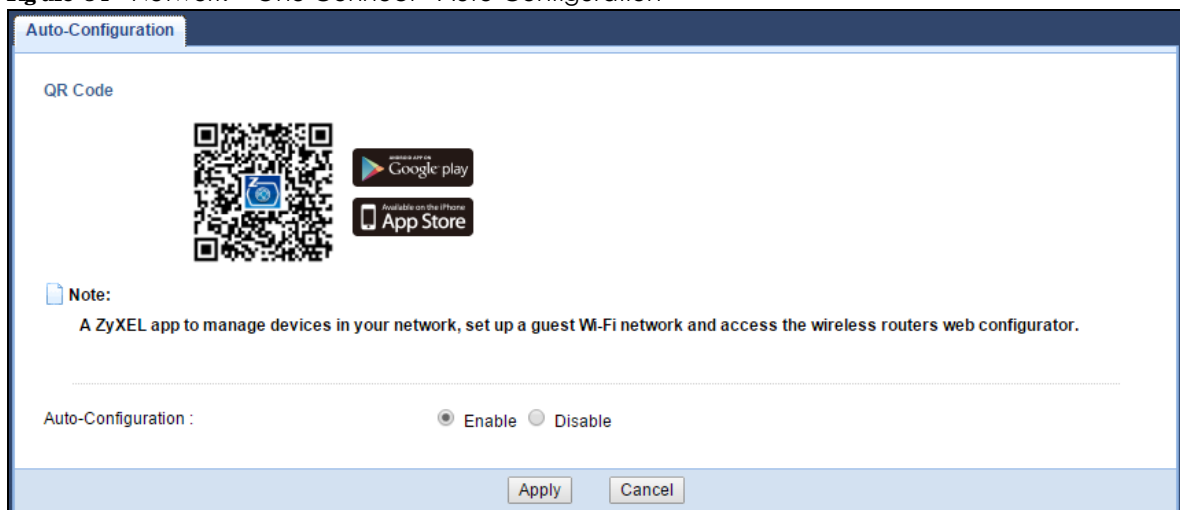

# CHAPTER 11

## Maintenance

### 11.1 Overview

This chapter provides information on the **Maintenance** screens.

### 11.2 What You Can Do

- Use the **General** screen (Section 11.3 on page 56) to set the timeout period of the management session.
- Use the **Password** screen (Section 11.4 on page 57) to change your PLA's system password.
- Use the **Time** screen (Section 11.5 on page 57) to change your PLA's time and date.
- Use the **Firmware Upgrade** screen (Section 11.6 on page 59) to upload firmware to your PLA.
- Use the **Backup/Restore** screen (Section 11.8 on page 62) to view information related to factory defaults, backup configuration, and restoring configuration.
- Use the **Restart** screen (Section 11.8 on page 62) to reboot the PLA without turning the power off.
- Use the **Language** screen (Section 11.9 on page 62) to change the language for the Web Configurator.
- Use the **WiFi Mode** screen (Section 11.10 on page 62) to change the Wi-Fi mode on your PLA.

### 11.3 General Screen

Use this screen to set the management session timeout period. Click **Maintenance > General**. The following screen displays.

**Figure 35** Maintenance > General

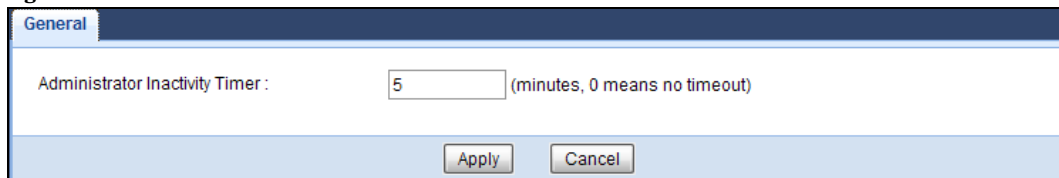

The screenshot shows a web interface for the 'General' settings. At the top, there is a dark blue header with the word 'General' in white. Below the header, the main content area has a light blue background. It contains the text 'Administrator Inactivity Timer:' followed by a text input field containing the number '5'. To the right of the input field is the text '(minutes, 0 means no timeout)'. At the bottom of the form, there are two buttons: 'Apply' and 'Cancel'.



The following table describes the labels in this screen.

Table 26 Maintenance > General

| LABEL                          | DESCRIPTION   |
|--------------------------------|---|
| Administrator Inactivity Timer | Type how many minutes a management session can be left idle before the session times out. The default is 5 minutes. After it times out you have to log in with your password again. Very long idle timeouts may have security risks. A value of "0" means a management session never times out, no matter how long it has been left idle (not recommended). |
| Apply                          | Click <b>Apply</b> to save your changes back to the PLA.  |
| Cancel                         | Click <b>Cancel</b> to reload the previous configuration for this screen.   |

## 11.4 Password Screen

It is strongly recommended that you change your PLA's password.

If you forget your PLA's password (or IP address), you will need to reset the device. See [Section 11.8 on page 62](#) for details

Click **Maintenance > Password**.

Figure 36 Maintenance > Password

The following table describes the labels in this screen.

Table 27 Maintenance > Password

| LABEL             | DESCRIPTION   |
|-------------------|---|
| Old Password      | Type the default password or the existing password you use to access the system in this field.  |
| New Password      | Type your new system password (up to 30 characters). Note that as you type a password, the screen displays an asterisk (*) for each character you type. |
| Retype to Confirm | Type the new password again in this field.  |
| Apply             | Click <b>Apply</b> to save your changes back to the PLA.  |
| Cancel            | Click <b>Cancel</b> to reload the previous configuration for this screen.   |

## 11.5 Time Setting Screen

Use this screen to configure the PLA's time based on your local time zone. To change your PLA's time and date, click **Maintenance > Time**. The screen appears as shown.

**Figure 37** Maintenance > Time

The following table describes the labels in this screen.

Table 28 Maintenance > Time

| LABEL                            | DESCRIPTION   |
|----------------------------------|---|
| Current Time and Date            |   |
| Current Time                     | This field displays the time of your PLA.<br>Each time you reload this page, the PLA synchronizes the time with the time server.  |
| Current Date                     | This field displays the date of your PLA.<br>Each time you reload this page, the PLA synchronizes the date with the time server.  |
| Time and Date Setup              |   |
| Manual                           | Select this radio button to enter the time and date manually. If you configure a new time and date, Time Zone and Daylight Saving at the same time, the new time and date you entered has priority and the Time Zone and Daylight Saving settings do not affect it. |
| New Time (hh:mm:ss)              | This field displays the last updated time from the time server or the last time configured manually.<br>When you select <b>Manual</b> , enter the new time in this field and then click <b>Apply</b> .  |
| New Date (yyyy/mm/dd)            | This field displays the last updated date from the time server or the last date configured manually.<br>When you select <b>Manual</b> , enter the new date in this field and then click <b>Apply</b> .  |
| Get from Time Server             | Select this radio button to have the PLA get the time and date from the time server you specified below.  |
| User Defined Time Server Address | Enter the IP address or URL (up to 20 extended ASCII characters in length) of your time server. Check with your ISP/network administrator if you are unsure of this information.  |
| Time Zone Setup                  |   |
| Time Zone                        | Choose the time zone of your location. This will set the time difference between your time zone and Greenwich Mean Time (GMT).  |

Table 28 Maintenance &gt; Time

| LABEL            | DESCRIPTION  |
|------------------|--|
| Daylight Savings | <p>Daylight saving is a period from late spring to fall when many countries set their clocks ahead of normal local time by one hour to give more daytime light in the evening.</p> <p>Select this option if you use Daylight Saving Time.</p>  |
| Start Date       | <p>Configure the day and time when Daylight Saving Time starts if you selected <b>Daylight Savings</b>. The <b>o'clock</b> field uses the 24 hour format. Here are a couple of examples:</p> <p>Daylight Saving Time starts in most parts of the United States on the second Sunday of March. Each time zone in the United States starts using Daylight Saving Time at 2 A.M. local time. So in the United States you would select <b>Second, Sunday, March</b> and type 2 in the <b>o'clock</b> field.</p> <p>Daylight Saving Time starts in the European Union on the last Sunday of March. All of the time zones in the European Union start using Daylight Saving Time at the same moment (1 A.M. GMT or UTC). So in the European Union you would select <b>Last, Sunday, March</b>. The time you type in the <b>o'clock</b> field depends on your time zone. In Germany for instance, you would type 2 because Germany's time zone is one hour ahead of GMT or UTC (GMT+1).</p> |
| End Date         | <p>Configure the day and time when Daylight Saving Time ends if you selected <b>Daylight Savings</b>. The <b>o'clock</b> field uses the 24 hour format. Here are a couple of examples:</p> <p>Daylight Saving Time ends in the United States on the first Sunday of November. Each time zone in the United States stops using Daylight Saving Time at 2 A.M. local time. So in the United States you would select <b>First, Sunday, November</b> and type 2 in the <b>o'clock</b> field.</p> <p>Daylight Saving Time ends in the European Union on the last Sunday of October. All of the time zones in the European Union stop using Daylight Saving Time at the same moment (1 A.M. GMT or UTC). So in the European Union you would select <b>Last, Sunday, October</b>. The time you type in the <b>o'clock</b> field depends on your time zone. In Germany for instance, you would type 2 because Germany's time zone is one hour ahead of GMT or UTC (GMT+1).</p>               |
| Apply            | Click <b>Apply</b> to save your changes back to the PLA.   |
| Cancel           | Click <b>Cancel</b> to reload the previous configuration for this screen.  |

## 11.6 Firmware Upgrade Screen

Find firmware at [www.zyxel.com](http://www.zyxel.com) in a file that (usually) uses the system model name with a ".bin" extension, e.g., "PLA.bin". The upload process uses HTTP (Hypertext Transfer Protocol) and may take up to two minutes. After a successful upload, the system will reboot.

Click **Maintenance > Firmware Upgrade**. Follow the instructions in this screen to upload firmware to your PLA.

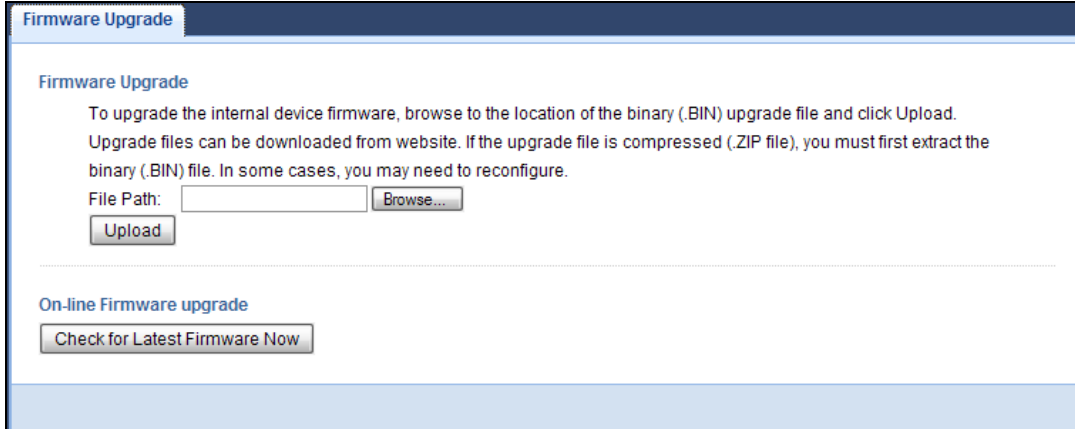
**Figure 38** Maintenance > Firmware Upgrade

The following table describes the labels in this screen.

Table 29 Maintenance &gt; Firmware Upgrade

| IA BEL                        | DESC RITION  |
|-------------------------------|--|
| Firmware Upgrade              |  |
| File Path                     | Type in the location of the file you want to upload in this field or click <b>Browse...</b> to find it.  |
| Browse...                     | Click <b>Browse...</b> to find the .bin file you want to upload. Remember that you must decompress compressed (.zip) files before you can upload them.   |
| Upload                        | Click <b>Upload</b> to begin the upload process. This process may take up to two minutes.  |
| On-line Firmware Upgrade      |  |
| Check for Latest Firmware Now | Click this button to get the latest firmware information, such as the version number, release date, release note and file size from the ZyXEL website. Make sure your PLA has Internet access. |
| Do-Firmware_Upgr<br>ade       | Click this button to download and install the latest firmware in your PLA.   |

Note: Do not turn off the PLA while firmware upload is in progress!

After you click **Upload**, wait two minutes before logging into the PLA again.

The PLA automatically restarts in this time causing a temporary network disconnect. In some operating systems, you may see the following icon on your desktop.

**Figure 39** Network Temporarily Disconnected

After two minutes, log in again and check your new firmware version in the **Dashboard** screen.

## 11.7 Configuration Backup/Restore Screen

Backup configuration allows you to back up (save) the PLA's current configuration to a file on your computer. Once your PLA is configured and functioning properly, it is highly recommended that you back up your configuration file before making configuration changes. The backup configuration file will be useful in case you need to return to your previous settings.

Restore configuration allows you to upload a new or previously saved configuration file from your computer to your PLA.

Click **Maintenance > Backup/Restore**. Information related to factory defaults, backup configuration, and restoring configuration appears as shown next.

**Figure 40** Maintenance > Backup/Restore

**Backup/Restore**

**Backup Configuration**  
Click Backup to save the current configuration of your system to your computer.

---

**Restore Configuration**  
To restore a previously saved configuration file to your system, browse to the location of the configuration file and click Upload.  
File Path :

---

**Back to Factory Defaults**  
Click Reset to clear all user-entered configuration information and return to factory defaults. After resetting, the  
- Password will be 1234  
- LAN IP address will be 192.168.1.2

The following table describes the labels in this screen.

Table 30 Maintenance > Backup/Restore

| IA BEL    | DESC RIPTION  |
|-----------|---|
| Backup    | Click <b>Backup</b> to save the PLA's current configuration to your computer.   |
| File Path | Type in the location of the file you want to upload in this field or click <b>Browse...</b> to find it.   |
| Browse... | Click <b>Browse...</b> to find the file you want to upload. Remember that you must decompress compressed (.ZIP) files before you can upload them.   |
| Upload    | Click <b>Upload</b> to begin the upload process.<br><br>Note: Do not turn off the PLA while configuration file upload is in progress.<br><br>After you click <b>Upload</b> , you must then wait one minute before logging into the PLA again. The PLA automatically restarts in this time causing a temporary network disconnect.   |
| Reset     | Pressing the <b>Reset</b> button in this section clears all user-entered configuration information and returns the PLA to its factory defaults.<br><br>You can also press the <b>RESET</b> button on the rear panel to reset the factory defaults of your PLA. Refer to the chapter about introducing the Web Configurator for more information on the <b>RESET</b> button. |

Note: If you uploaded the default configuration file you may need to change the IP address of your computer to be in the same subnet as that of the default PLA IP address (192.168.1.2).

## 11.8 Restart Screen

System restart allows you to reboot the PLA without turning the power off.

Click **Maintenance > Restart** to open the following screen.

**Figure 41** Maintenance > Restart

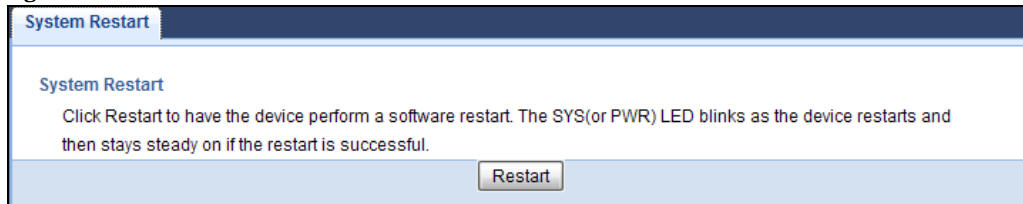

Click **Restart** to have the PLA reboot. This does not affect the PLA's configuration.

## 11.9 Language Screen

Use this screen to change the language for the Web Configurator.

Select the language you prefer and click **Apply**. The Web Configurator language changes after a while without restarting the PLA.

**Figure 42** Maintenance > Language

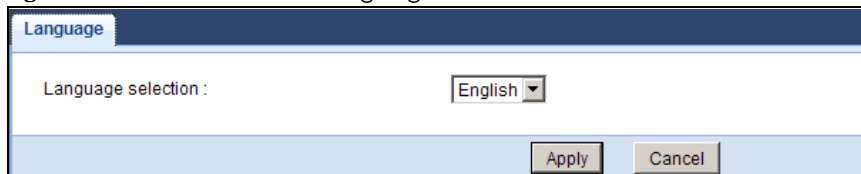

## 11.10 Wi-Fi Mode Screen

The PLA offers three different Wi-Fi modes: Range Mode, Performance Mode and Mixed Mode. Use this screen to change the Wi-Fi Mode on your PLA.

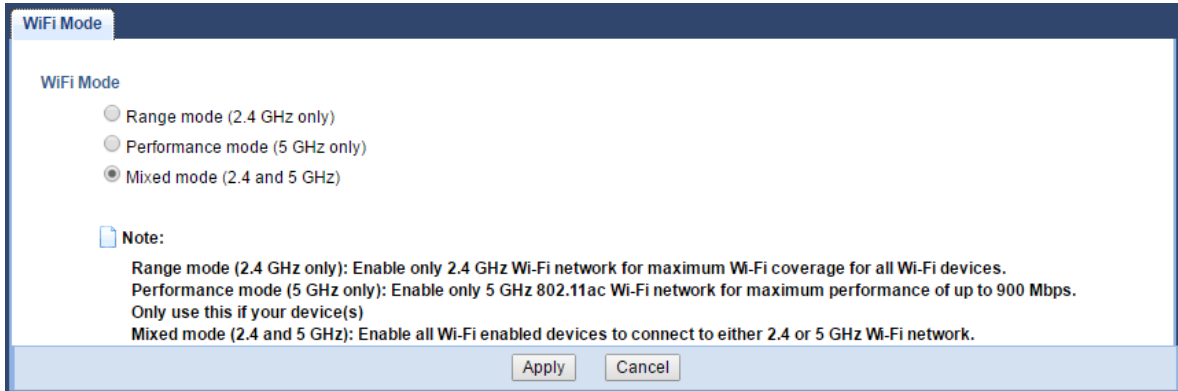
**Figure 43** Maintenance > WiFi Mode

The following table describes the labels in this screen.

Table 31 Maintenance &gt; WiFi Mode

| LABEL            | DESCRIPTION  |
|------------------|--|
| Range Mode       | This mode enables a 2.4GHz Wi-Fi, with a wider range for your Wi-Fi devices. Choose this mode if all your Wi-Fi devices are IEEE 802.11 b/g/n compatible.  |
| Performance Mode | This mode enables a 5Ghz Wi-Fi, with a better performance than 2.4Ghz, but a shorter range for your Wi-Fi devices. Choose this mode if all your Wi-Fi devices are IEEE 802.11 a/n/ac compatible. |
| Mixed Mode       | This mode enables both 2.5GHz and 5GHz Wi-Fi for all devices to connect. Choose this mode if you have IEEE 802.11 a/n/ac and IEEE802.11 b/g/n Wi-Fi devices connecting to your wireless network. |
| Apply            | Click <b>Apply</b> to save your settings to the PLA.   |
| Cancel           | Click <b>Cancel</b> to reload the previous configuration for this screen.  |

# CHAPTER 12

## Troubleshooting

This chapter offers some suggestions to solve problems you might encounter.

### 12.1 Power and Light Problems

---

The PLA does not turn on. None of the lights turn on.

---

- 1 Disconnect and re-connect the PLA.
- 2 Remove the powerline adapter from the outlet. Then connect an electrical device that you know works into the same power outlet. This checks the status of the power outlet.
- 3 If the problem continues, contact the vendor.

---

The ETHERNET light does not turn on.

---

- 1 Check the hardware connections. See the Quick Start Guide.
- 2 Inspect your cables for damage. Contact the vendor to replace any damaged cables.
- 3 Check the Ethernet adapter on your computer and make sure it's enabled and working properly.
- 4 If the PLA is connected to an Ethernet switch or router, make sure the device is working correctly, and that the LAN network is working and configured correctly as well.

---

The HomePlug light does not turn on.

---

- 1 Make sure that the network name (sometimes called the network password) is the same on all of your powerline adapters.
- 2 Make sure that all your powerline adapters are HomePlug AV compliant. Check the package it came in or ask your vendor. This PLA can not detect earlier versions of HomePlug powerline adapters such as HomePlug 1.0 or 1.0.1. (Although they can coexist on the same electrical wiring without interfering with each other.)



- 3 Make sure that the powerline adapters on your network are all on the same electrical wiring. Connect another powerline adapter into an outlet close to your PLA's power outlet. They are probably now on the same electrical wiring. Check the HomePlug (🔌) light. If it now lights up your powerline adapter was probably previously on separate electrical wiring. Ask an electrician for more information on the electrical wiring in your building.
- 4 Make sure that you do not have a power meter between powerline adapters. Powerline signals cannot pass this.

---

The POWER and HomePlug light blink at the same time.

---

- You have pressed the **RESET/ ENCRYPT** button for more than three seconds. Try setting up a connection again, this time pressing the **RESET/ ENCRYPT** buttons on both devices for less than three seconds.

## 12.2 Powerline Problems

---

The signal on my powerline network is weak.

---

- 1 Your powerline adapters may be connected to electrical surge protectors. Connect them to standard power outlets.
- 2 Your powerline adapters may be located close to large appliances such as refrigerators or air-conditioners that cause interference with the powerline signal. Move the adapters further away from such appliances to reduce interference.
- 3 Your powerline adapters may be placed close to electrical devices such as electrical insect-killers which produce radio waves. These may interfere with the powerline signals. Move the adapters further away from such electrical devices.
- 4 Your wiring may be old and/or low quality or with a long wiring path.

## 12.3 RESET/ ENCRYPT Button Problems

This section applies only to PLAs with the **RESET/ ENCRYPT** button.

---

The HomePlug light is already on, but I haven't pressed the **RESET/ ENCRYPT** button yet.

---

Your device has already connected to another powerline device. Press the **RESET/ ENCRYPT** button for 5 to 8 seconds to release the connection.

---

The POWER light does not blink when I press the **RESET/ ENCRYPT** button.

---

- Check the device is on.
- Press the **RESET/ ENCRYPT** button again, making certain you have pressed the button for 0.5 to 3 seconds.
- The POWER light on some powerline devices do not blink as part of the ENCRYPT process. Check your powerline device is a PLA.

---

The POWER light blinks two times quickly then pauses, before repeating.

---

The ENCRYPT process has failed. Press the **RESET/ ENCRYPT** button on both devices for 5 to 8 seconds, then try to reconnect.

---

The POWER lights on both devices blink when I press the **RESET/ ENCRYPT** buttons, but the HomePlug light does not turn on.

---

- Ensure you have pressed the **RESET/ ENCRYPT** button on both devices.
- Wait for about a minute while the devices set up a connection.
- If that does not work, try again with both devices connected to a power strip next to each other. If they now connect, then the devices were not on the same electrical circuit before.

---

The POWER lights on both devices blink, then many lights blink and the HomePlug light blinks red.

---

Do not worry, the connection process is proceeding normally.

---

The POWER lights on both devices finished blinking, but only one device's HomePlug light is on.

---

One device may have connected to a third powerline device. To check device A is connected to device B and not another device, disconnect device B from its power source. Device A's HomePlug (🔌) light will turn off if the connection is with Device B. Press the **RESET/ ENCRYPT** button on both devices for 5 to 8 seconds, then try to reconnect, pressing the **RESET/ ENCRYPT** button for 0.5 to 3 seconds on both devices.

---

I pressed the RESET/ENCRYPT button for 5 to 8 seconds, but the HomePlug light is still on.

---

The HomePlug light is on, indicating it is still connected to another powerline device. Try again, pressing the **RESET/ ENCRYPT** button for 5 to 8 seconds.

# APPENDIX A

## Customer Support

In the event of problems that cannot be solved by using this manual, you should contact your vendor. If you cannot contact your vendor, then contact a Zyxel office for the region in which you bought the device.

See <http://www.zyxel.com/homepage.shtml> and also [http://www.zyxel.com/about\\_zyxel/zyxel\\_worldwide.shtml](http://www.zyxel.com/about_zyxel/zyxel_worldwide.shtml) for the latest information.

Please have the following information ready when you contact an office.

### Required Information

- Product model and serial number.
- Warranty Information.
- Date that you received your device.
- Brief description of the problem and the steps you took to solve it.

### Corporate Headquarters (Worldwide)

#### Taiwan

- Zyxel Communications Corporation
- <http://www.zyxel.com>

### Asia

#### China

- Zyxel Communications (Shanghai) Corp.
- Zyxel Communications (Beijing) Corp.
- Zyxel Communications (Tianjin) Corp.
- <http://www.zyxel.cn>

#### India

- Zyxel Technology India Pvt Ltd
- <http://www.zyxel.in>

#### Kazakhstan

- Zyxel Kazakhstan
- <http://www.zyxel.kz>

### **Korea**

- Zyxel Korea Corp.
- <http://www.zyxel.kr>

### **Malaysia**

- Zyxel Malaysia Sdn Bhd.
- <http://www.zyxel.com.my>

### **Pakistan**

- Zyxel Pakistan (Pvt.) Ltd.
- <http://www.zyxel.com.pk>

### **Philippines**

- Zyxel Philippines
- <http://www.zyxel.com.ph>

### **Singapore**

- Zyxel Singapore Pte Ltd.
- <http://www.zyxel.com.sg>

### **Taiwan**

- Zyxel Communications Corporation
- <http://www.zyxel.com/tw/zh/>

### **Thailand**

- Zyxel Thailand Co., Ltd
- <http://www.zyxel.co.th>

### **Vietnam**

- Zyxel Communications Corporation-Vietnam Office
- <http://www.zyxel.com/vn/vi>

## **Europe**

### **Austria**

- Zyxel Deutschland GmbH
- <http://www.zyxel.de>

### **Belarus**

- Zyxel BY
- <http://www.zyxel.by>

### **Belgium**

- Zyxel Communications B.V.
- <http://www.zyxel.com/be/nl/>
- <http://www.zyxel.com/be/fr/>

### **Bulgaria**

- Zyxel България
- <http://www.zyxel.com/bg/bg/>

### **Czech Republic**

- Zyxel Communications Czech s.r.o
- <http://www.zyxel.cz>

### **Denmark**

- Zyxel Communications A/S
- <http://www.zyxel.dk>

### **Estonia**

- Zyxel Estonia
- <http://www.zyxel.com/ee/et/>

### **Finland**

- Zyxel Communications
- <http://www.zyxel.fi>

### **France**

- Zyxel France
- <http://www.zyxel.fr>

### **Germany**

- Zyxel Deutschland GmbH
- <http://www.zyxel.de>

### **Hungary**

- Zyxel Hungary & SEE
- <http://www.zyxel.hu>

### **Italy**

- Zyxel Communications Italy
- <http://www.zyxel.it/>

### **Latvia**

- Zyxel Latvia
- <http://www.zyxel.com/lv/lv/homepage.shtml>

### **Lithuania**

- Zyxel Lithuania
- <http://www.zyxel.com/lt/lt/homepage.shtml>

### **Netherlands**

- Zyxel Benelux
- <http://www.zyxel.nl>

### **Norway**

- Zyxel Communications
- <http://www.zyxel.no>

### **Poland**

- Zyxel Communications Poland
- <http://www.zyxel.pl>

### **Romania**

- Zyxel Romania
- <http://www.zyxel.com/ro/ro>

### **Russia**

- Zyxel Russia
- <http://www.zyxel.ru>

### **Slovakia**

- Zyxel Communications Czech s.r.o. organizacna zlozka
- <http://www.zyxel.sk>

### **Spain**

- Zyxel Communications ES Ltd
- <http://www.zyxel.es>

### **Sweden**

- Zyxel Communications
- <http://www.zyxel.se>

### **Switzerland**

- Studerus AG

- <http://www.zyxel.ch/>

### **Turkey**

- Zyxel Turkey A.S.
- <http://www.zyxel.com.tr>

### **UK**

- Zyxel Communications UK Ltd.
- <http://www.zyxel.co.uk>

### **Ukraine**

- Zyxel Ukraine
- <http://www.ua.zyxel.com>

## **Latin America**

### **Argentina**

- Zyxel Communication Corporation
- <http://www.zyxel.com/ec/es/>

### **Brazil**

- Zyxel Communications Brasil Ltda.
- <https://www.zyxel.com/br/pt/>

### **Ecuador**

- Zyxel Communication Corporation
- <http://www.zyxel.com/ec/es/>

## **Middle East**

### **Israel**

- Zyxel Communication Corporation
- <http://il.zyxel.com/homepage.shtml>

### **Middle East**

- Zyxel Communication Corporation
- <http://www.zyxel.com/me/en/>



## **North America**

### **USA**

- Zyxel Communications, Inc. - North America Headquarters
- <http://www.zyxel.com/us/en/>

## **Oceania**

### **Australia**

- Zyxel Communications Corporation
- <http://www.zyxel.com/au/en/>

## **Africa**

### **South Africa**

- Nology (Pty) Ltd.
- <http://www.zyxel.co.za>

# APPENDIX B

## Legal Information

### Copyright

Copyright © 2017 by Zyxel Communications Corporation.

The contents of this publication may not be reproduced in any part or as a whole, transcribed, stored in a retrieval system, translated into any language, or transmitted in any form or by any means, electronic, mechanical, magnetic, optical, chemical, photocopying, manual, or otherwise, without the prior written permission of Zyxel Communications Corporation.

Published by Zyxel Communications Corporation. All rights reserved.

### Disclaimer

Zyxel does not assume any liability arising out of the application or use of any products, or software described herein. Neither does it convey any license under its patent rights nor the patent rights of others. Zyxel further reserves the right to make changes in any products described herein without notice. This publication is subject to change without notice.

### Regulatory Notice and Statement

#### United States of America



The following information applies if you use the product within USA area.

#### FCC EMC Statement

- The device complies with Part 15 of FCC rules. Operation is subject to the following two conditions:
  - (1) This device may not cause harmful interference, and
  - (2) This device must accept any interference received, including interference that may cause undesired operation.
- Changes or modifications not expressly approved by the party responsible for compliance could void the user's authority to operate the device.
- This product has been tested and complies with the specifications for a Class B digital device, pursuant to Part 15 of the FCC Rules. These limits are designed to provide reasonable protection against harmful interference in a residential installation. This device generates, uses, and can radiate radio frequency energy and, if not installed and used according to the instructions, may cause harmful interference to radio communications. However, there is no guarantee that interference will not occur in a particular installation.
- If this device does cause harmful interference to radio or television reception, which is found by turning the device off and on, the user is encouraged to try to correct the interference by one or more of the following measures:
  - Reorient or relocate the receiving antenna
  - Increase the separation between the devices
  - Connect the equipment to an outlet other than the receiver's
  - Consult a dealer or an experienced radio/TV technician for assistance

The following information applies if you use the product with RF function within USA area.

#### FCC Radiation Exposure Statement

- [This equipment complies with FCC RF radiation exposure limits set forth for an uncontrolled environment.](#)
- This transmitter must be at least 20 cm from the user and must not be co-located or operating in conjunction with any other antenna or transmitter.

#### Canada

The following information applies if you use the product within Canada area

#### Industry Canada ICES statement

[CAN ICES-3 \(B\)/NMB-3\(B\)](#)

[CAN ICES-6/NMB-6](#)

**Industry Canada RSS-GEN & RSS-247 statement**

- This device complies with Industry Canada license-exempt RSS standard(s). Operation is subject to the following two conditions: (1) this device may not cause interference, and (2) this device must accept any interference, including interference that may cause undesired operation of the device.
- This radio transmitter [\[2468C-PLA5236\]](#) has been approved by Industry Canada to operate with the antenna types listed below with the maximum permissible gain and required antenna impedance for each antenna type indicated. Antenna types not included in this list, having a gain greater than the maximum gain indicated for that type, are strictly prohibited for use with this device.

**Antenna Information**

| TYPE                   | MANUFACTURER               | GAIN   | CONNECTOR            |
|------------------------|----------------------------|--|----------------------|
| <a href="#">Dipole</a> | <a href="#">ARISTOTILE</a> | <a href="#">1.61 dBi (2.4G)</a><br><a href="#">2.78 dBi (5G)</a> | <a href="#">IPEX</a> |

If the product with 5G wireless function operating in 5150-5250 MHz and 5725-5850 MHz, the following attention must be paid,

- The device for operation in the band 5150-5250 MHz is only for indoor use to reduce the potential for harmful interference to co-channel mobile satellite systems.
- For devices with detachable antenna(s), the maximum antenna gain permitted for devices in the band 5725-5850 MHz shall be such that the equipment still complies with the e.i.r.p. limits specified for point-to-point and non-point-to-point operation as appropriate; and
- The worst-case tilt angle(s) necessary to remain compliant with the e.i.r.p. elevation mask requirement set forth in Section 6.2.2(3) of RSS 247 shall be clearly indicated.

If the product with 5G wireless function operating in 5250-5350 MHz and 5470-5725 MHz, the following attention must be paid.

- For devices with detachable antenna(s), the maximum antenna gain permitted for devices in the bands 5250-5350 MHz and 5470-5725 MHz shall be such that the equipment still complies with the e.i.r.p. limit
- Le présent appareil est conforme aux CNR d'Industrie Canada applicables aux appareils radio exempts de licence. L'exploitation est autorisée aux deux conditions suivantes: (1) l'appareil ne doit pas produire de brouillage, et (2) l'utilisateur de l'appareil doit accepter tout brouillage radioélectrique subi, même si le brouillage est susceptible d'en compromettre le fonctionnement.
- Le présent émetteur radio [\[2468C-PLA5236\]](#) de modèle s'il fait partie du matériel de catégorie) a été approuvé par Industrie Canada pour fonctionner avec les types d'antenne énumérés ci-dessous et ayant un gain admissible maximal et l'impédance requise pour chaque type d'antenne. Les types d'antenne non inclus dans cette liste, ou dont le gain est supérieur au gain maximal indiqué, sont strictement interdits pour l'exploitation de l'émetteur.

**Informations Antenne**

| TYPE                   | FABRICANT                  | GAIN   | CONNECTEUR           |
|------------------------|----------------------------|--|----------------------|
| <a href="#">Dipole</a> | <a href="#">ARISTOTILE</a> | <a href="#">1.61 dBi (2.4G)</a><br><a href="#">2.78 dBi (5G)</a> | <a href="#">IPEX</a> |

Lorsque la fonction sans fil 5G fonctionnant en 5150-5250 MHz and 5725-5850 MHz est activée pour ce produit, il est nécessaire de porter une attention particulière aux choses suivantes

- Les dispositifs fonctionnant dans la bande 5150-5250 MHz sont réservés uniquement pour une utilisation à l'intérieur afin de réduire les risques de brouillage préjudiciable aux systèmes de satellites mobiles utilisant les mêmes canaux;
- Pour les dispositifs munis d'antennes amovibles, le gain maximal d'antenne permis (pour les dispositifs utilisant la bande de 5 725 à 5 850 MHz) doit être conforme à la limite de la p.i.r.e. spécifiée pour l'exploitation point à point et l'exploitation non point à point, selon le cas;
- Les pires angles d'inclinaison nécessaires pour rester conforme à l'exigence de la p.i.r.e. applicable au masque d'élévation, et énoncée à la section 6.2.2.3) du CNR-247, doivent être clairement indiqués.

Lorsque la fonction sans fil 5G fonctionnant en 5250-5350 MHz et 5470-5725 MHz est activée pour ce produit, il est nécessaire de porter une attention particulière aux choses suivantes

- Pour les dispositifs munis d'antennes amovibles, le gain maximal d'antenne permis pour les dispositifs utilisant les bandes de 5 250 à 5 350 MHz et de 5 470 à 5 725 MHz doit être conforme à la limite de la p.i.r.e.

**Industry Canada radiation exposure statement**

[The equipment](#) complies with IC radiation exposure limits set forth for an uncontrolled environment. This device should be installed and operated with a minimum distance of 20 cm between the radiator and your body.

**Déclaration d'exposition aux radiations:**

Cet équipement est conforme aux limites d'exposition aux rayonnements IC établies pour un environnement non contrôlé. Cet équipement doit être installé et utilisé avec un minimum de 20 cm de distance entre la source de rayonnement et votre corps.

**EUROPEAN UNION**



The following information applies if you use the product within the European Union.

**Declaration of Conformity with Regard to EU Directive 1999/5/EC (R&TTE Directive)**

- Compliance information for 2.4GHz and/or 5GHz wireless products relevant to the EU and other Countries following the EU Directive 1999/5/EC (R&TTE)
- This device is restricted to indoor use only when operating in the 5150 to 5350 MHz frequency range.

|                             |   |
|-----------------------------|---|
| Български (Bulgarian)       | С настоящото Zyxel декларира, че това оборудване е в съответствие със съществените изисквания и другите приложими разпоредбите на Директива 1999/5/EC.                                      |
| Español (Spanish)           | Por medio de la presente Zyxel declara que el equipo cumple con los requisitos esenciales y cualesquiera otras disposiciones aplicables o exigibles de la Directiva 1999/5/CE.              |
| Čeština (Czech)             | Zyxel tímto prohlašuje, že tento zařazení je ve shodě se základními požadavky a dalšími příslušnými ustanoveními směrnice 1999/5/EC.  |
| Dansk (Danish)              | Undertegnede Zyxel erklærer herved, at følgende udstyr overholder de væsentlige krav og øvrige relevante krav i direktiv 1999/5/EF.   |
| Deutsch (German)            | Hiermit erklärt Zyxel, dass sich das Gerät Ausstattung in Übereinstimmung mit den grundlegenden Anforderungen und den übrigen einschlägigen Bestimmungen der Richtlinie 1999/5/EU befindet. |
| Eesti keel (Estonian)       | Käesolevaga kinnitab Zyxel seadme vastavust direktiivi 1999/5/EÜ põhinõuetele ja nimetatud direktiivist tulenevatele teistele asjakohastele sätetele.                                       |
| Ελληνικά (Greek)            | ΜΕ ΤΗΝ ΠΑΡΟΥΣΙΑ Ζyxel ΔΗΛΩΝΕΙ ΟΤΙ ΕΞΟΠΛΙΣΜΟΣ ΣΥΜΜΟΡΦΩΝΕΤΑΙ ΠΡΟΣ ΤΙΣ ΟΥΣΙΩΔΕΙΣ ΑΠΑΙΤΗΣΕΙΣ ΚΑΙ ΤΙΣ ΛΟΙΠΕΣ ΣΧΕΤΙΚΕΣ ΔΙΑΤΑΞΕΙΣ ΤΗΣ ΟΔΗΓΙΑΣ 1999/5/EC.   |
| English                     | Hereby, Zyxel declares that this device is in compliance with the essential requirements and other relevant provisions of Directive 1999/5/EC.  |
| Français (French)           | Par la présente Zyxel déclare que l'appareil équipements est conforme aux exigences essentielles et aux autres dispositions pertinentes de la directive 1999/5/EC.                          |
| Hrvatski (Croatian)         | Zyxel ovime izjavljuje da je radijska oprema tipa u skladu s Direktivom 1999/5/EC.  |
| Íslenska (Icelandic)        | Hér með lýsir, Zyxel því yfir að þessi búnaður er í samræmi við grunnkröfur og önnur viðeigandi ákvæði tilskipunar 1999/5/EC.   |
| Italiano (Italian)          | Con la presente Zyxel dichiara che questo attrezzatura è conforme ai requisiti essenziali ed alle altre disposizioni pertinenti stabilite dalla direttiva 1999/5/CE.                        |
| Latviešu valoda (Latvian)   | Ar šo Zyxel deklarē, ka iekārtas atbilst Direktīvas 1999/5/EK būtiskajām prasībām un citiem ar to saistītajiem noteikumiem.   |
| Lietuvių kalba (Lithuanian) | Šiuo Zyxel deklaruoja, kad šis įranga atitinka esminius reikalavimus ir kitas 1999/5/EB Direktyvos nuostatas.   |
| Magyar (Hungarian)          | Alulírott, Zyxel nyilatkozom, hogy a berendezés megfelel a vonatkozó alapvető követelményeknek és az 1999/5/EK irányelv egyéb előírásainak.   |
| Malti (Maltese)             | Hawnhekk, Zyxel, jiddikjara li dan tagħmir jikkonforma mal-htgijiet essenzjali u ma provvedimenti oħrajn rilevanti li hemm fid-Direttiva 1999/5/EC.   |
| Nederlands (Dutch)          | Hierbij verklaart Zyxel dat het toestel uitrusting in overeenstemming is met de essentiële eisen en de andere relevante bepalingen van richtlijn 1999/5/EC.                                 |
| Polski (Polish)             | Niniejszym Zyxel oświadcza, że sprzęt jest zgodny z zasadniczymi wymogami oraz pozostałymi stosownymi postanowieniami Dyrektywy 1999/5/EC.  |
| Português (Portuguese)      | Zyxel declara que este equipamento está conforme com os requisitos essenciais e outras disposições da Directiva 1999/5/EC.  |
| Română (Romanian)           | Prin prezenta, Zyxel declară că acest echipament este în conformitate cu cerințele esențiale și alte prevederi relevante ale Directivei 1999/5/EC.  |
| Slovenčina (Slovak)         | Zyxel týmto vyhlasuje, že zariadenia spĺňa základné požiadavky a všetky príslušné ustanovenia Smernice 1999/5/EC.   |
| Slovenščina (Slovene)       | Zyxel izjavlja, da je ta oprema v skladu z bistvenimi zahtevami in ostalimi relevantnimi določili direktive 1999/5/EC.  |
| Suomi (Finnish)             | Zyxel vakuuttaa täten että laitteen tyyppinen laite on direktiivin 1999/5/EY oleellisten vaatimusten ja sitä koskevien direktiivin muiden ehtojen mukainen.                                 |
| Svenska (Swedish)           | Härmed intygar Zyxel att denna utrustning står i överensstämmelse med de väsentliga egenskapskrav och övriga relevanta bestämmelser som framgår av direktiv 1999/5/EC.                      |
| Norsk (Norwegian)           | Erklærer herved Zyxel at dette utstyret er i samsvar med de grunnleggende kravene og andre relevante bestemmelser i direktiv 1999/5/EF.   |

**National Restrictions**

- This product may be used in all EU countries (and other countries following the EU Directive 1999/5/EC) without any limitation except for the countries mentioned below:
- Ce produit peut être utilisé dans tous les pays de l'UE (et dans tous les pays ayant transposés la directive 1999/5/CE) sans aucune limitation, excepté pour les pays mentionnés ci-dessous:
- Questo prodotto è utilizzabile in tutte i paesi EU (ed in tutti gli altri paesi che seguono le direttiva 1999/5/EC) senza nessuna limitazione, eccetto per i paesi menzionati di seguito:

- Das Produkt kann in allen EU Staaten ohne Einschränkungen eingesetzt werden (sowie in anderen Staaten die der Richtlinie 1999/5/CE folgen) mit Ausnahme der folgenden aufgeführten Staaten:  
 In the majority of the EU and other European countries, the 2.4GHz and 5GHz bands have been made available for the use of wireless local area networks (LANs). Later in this document you will find an overview of countries in which additional restrictions or requirements or both are applicable. The requirements for any country may evolve. Zyxel recommends that you check with the local authorities for the latest status of their national regulations for both the 2.4GHz and 5GHz wireless LANs. The following countries have restrictions and/or requirements in addition to those given in the table labeled "Overview of Regulatory Requirements for Wireless LANs".
- Belgium**
- The Belgian Institute for Postal Services and Telecommunications (BIPT) must be notified of any outdoor wireless link having a range exceeding 300 meters. Please check <http://www.bipt.be> for more details.
  - Dragadloze verbindingen voor buitengebruik en met een reikwijdte van meer dan 300 meter dienen aangemeld te worden bij het Belgisch Instituut voor postdiensten en telecommunicatie (BIPT). Zie <http://www.bipt.be> voor meer gegevens.
  - Les liaisons sans fil pour une utilisation en extérieur d'une distance supérieure à 300 mètres doivent être notifiées à l'Institut Belge des services Postaux et des Télécommunications (IBPT). Visitez <http://www.ibpt.be> pour de plus amples détails.
- Denmark**
- In Denmark, the band 5150 - 5350 MHz is also allowed for outdoor usage.
  - I Danmark må frekvensbåndet 5150 - 5350 også anvendes udendørs.
- Italy**
- This product meets the National Radio Interface and the requirements specified in the National Frequency Allocation Table for Italy. Unless this wireless LAN product is operating within the boundaries of the owner's property, its use requires a "general authorization." Please check <http://www.sviluppoeconomico.gov.it/> for more details.
  - Questo prodotto è conforme alla specifiche di Interfaccia Radio Nazionali e rispetta il Piano Nazionale di ripartizione delle frequenze in Italia. Se non viene installato all'interno del proprio fondo, l'utilizzo di prodotti Wireless LAN richiede una "Autorizzazione Generale". Consultare <http://www.sviluppoeconomico.gov.it/> per maggiori dettagli.
- Latvia**
- The outdoor usage of the 2.4 GHz band requires an authorization from the Electronic Communications Office. Please check <http://www.esd.lv> for more details.
  - 2.4 GHz frekvenču joslas izmantošanai ārpus telpām nepieciešama atļauja no Elektronisko sakaru direkcijas. Vairāk informācijas: <http://www.esd.lv>.
- Notes:
- Although Norway, Switzerland and Liechtenstein are not EU member states, the EU Directive 1999/5/EC has also been implemented in those countries.
  - The regulatory limits for maximum output power are specified in EIRP. The EIRP level (in dBm) of a device can be calculated by adding the gain of the antenna used (specified in dBi) to the output power available at the connector (specified in dBm).

**List of national codes**

| COUNTRY        | ISO 3166 2 LETTER CODE | COUNTRY        | ISO 3166 2 LETTER CODE |
|----------------|------------------------|----------------|------------------------|
| Austria        | AT                     | Liechtenstein  | LI                     |
| Belgium        | BE                     | Lithuania      | LT                     |
| Bulgaria       | BG                     | Luxembourg     | LU                     |
| Croatia        | HR                     | Malta          | MT                     |
| Cyprus         | CY                     | Netherlands    | NL                     |
| Czech Republic | CZ                     | Norway         | NO                     |
| Denmark        | DK                     | Poland         | PL                     |
| Estonia        | EE                     | Portugal       | PT                     |
| Finland        | FI                     | Romania        | RO                     |
| France         | FR                     | Serbia         | RS                     |
| Germany        | DE                     | Slovakia       | SK                     |
| Greece         | GR                     | Slovenia       | SI                     |
| Hungary        | HU                     | Spain          | ES                     |
| Iceland        | IS                     | Switzerland    | CH                     |
| Ireland        | IE                     | Sweden         | SE                     |
| Italy          | IT                     | Turkey         | TR                     |
| Latvia         | LV                     | United Kingdom | GB                     |

**Safety Warnings**

- Do not use this product near water, for example, in a wet basement or near a swimming pool.
- Do not expose your device to dampness, dust or corrosive liquids.
- Do not store things on the device.
- Do not install, use, or service this device during a thunderstorm. There is a remote risk of electric shock from lightning.
- Connect ONLY suitable accessories to the device.

- Do not open the device or unit. Opening or removing covers can expose you to dangerous high voltage points or other risks. ONLY qualified service personnel should service or disassemble this device. Please contact your vendor for further information.
- Make sure to connect the cables to the correct ports.
- Place connecting cables carefully so that no one will step on them or stumble over them.
- Always disconnect all cables from this device before servicing or disassembling.
- Do not remove the plug and connect it to a power outlet by itself; always attach the plug to the power adaptor first before connecting it to a power outlet.
- Do not allow anything to rest on the power adaptor or cord and do NOT place the product where anyone can walk on the power adaptor or cord.
- Please use the provided or designated connection cables/power cables/ adaptors. Connect it to the right supply voltage (for example, 110V AC in North America or 230V AC in Europe). If the power adaptor or cord is damaged, it might cause electrocution. Remove it from the device and the power source, repairing the power adapter or cord is prohibited. Contact your local vendor to order a new one.
- Do not use the device outside, and make sure all the connections are indoors. There is a remote risk of electric shock from lightning.
- CAUTION: Risk of explosion if battery is replaced by an incorrect type, dispose of used batteries according to the instruction. Dispose them at the applicable collection point for the recycling of electrical and electronic devices. For detailed information about recycling of this product, please contact your local city office, your household waste disposal service or the store where you purchased the product.
- Do not obstruct the device ventilation slots, as insufficient airflow may harm your device. For example, do not place the device in an enclosed space such as a box or on a very soft surface such as a bed or sofa.
- The following warning statements apply, where the disconnect device is not incorporated in the device or where the plug on the power supply cord is intended to serve as the disconnect device,
  - For permanently connected devices, a readily accessible disconnect device shall be incorporated external to the device;
  - For pluggable devices, the socket-outlet shall be installed near the device and shall be easily accessible.

## Environment Statement

### ErP (Energy-related Products)

Zyxel products put on the EU market in compliance with the requirement of the European Parliament and the Council published Directive 2009/125/EC establishing a framework for the setting of ecodesign requirements for energy-related products (recast), so called as "ErP Directive (Energy-related Products directive)" as well as ecodesign requirement laid down in applicable implementing measures, power consumption has satisfied regulation requirements which are:

- Network standby power consumption < 8W, and/or
- Off mode power consumption < 0.5W, and/or
- Standby mode power consumption < 0.5W.

*(Wireless setting, please refer to "Wireless" chapter for more detail.)*

### European Union - Disposal and Recycling Information

The symbol below means that according to local regulations your product and/or its battery shall be disposed of separately from domestic waste. If this product is end of life, take it to a recycling station designated by local authorities. At the time of disposal, the separate collection of your product and/or its battery will help save natural resources and ensure that the environment is sustainable development.

Die folgende Symbol bedeutet, dass Ihr Produkt und/oder seine Batterie gemäß den örtlichen Bestimmungen getrennt vom Hausmüll entsorgt werden muss. Wenden Sie sich an eine Recyclingstation, wenn dieses Produkt das Ende seiner Lebensdauer erreicht hat. Zum Zeitpunkt der Entsorgung wird die getrennte Sammlung von Produkt und/oder seiner Batterie dazu beitragen, natürliche Ressourcen zu sparen und die Umwelt und die menschliche Gesundheit zu schützen.

El símbolo de abajo indica que según las regulaciones locales, su producto y/o su batería deberán depositarse como basura separada de la doméstica. Cuando este producto alcance el final de su vida útil, llévelo a un punto limpio. Cuando llegue el momento de desechar el producto, la recogida por separado éste y/o su batería ayudará a salvar los recursos naturales y a proteger la salud humana y medioambiental.

Le symbole ci-dessous signifie que selon les réglementations locales votre produit et/ou sa batterie doivent être éliminés séparément des ordures ménagères. Lorsque ce produit atteint sa fin de vie, amenez-le à un centre de recyclage. Au moment de la mise au rebut, la collecte séparée de votre produit et/ou de sa batterie aidera à économiser les ressources naturelles et protéger l'environnement et la santé humaine.

Il simbolo sotto significa che secondo i regolamenti locali il vostro prodotto e/o batteria deve essere smaltito separatamente dai rifiuti domestici. Quando questo prodotto raggiunge la fine della vita di servizio portarlo a una stazione di riciclaggio. Al momento dello smaltimento, la raccolta separata del vostro prodotto e/o della sua batteria aiuta a risparmiare risorse naturali e a proteggere l'ambiente e la salute umana.

Symbolen innebär att enligt lokal lagstiftning ska produkten och/eller dess batteri kastas separat från hushållsavfallet. När den här produkten när slutet av sin livslängd ska du ta den till en återvinningsstation. Vid tiden för kasseringen bidrar du till en bättre miljö och mänsklig hälsa genom att göra dig av med den på ett återvinningsställe.



Environmental Product Declaration

| Български (Bulgarian)  | Čeština (Czech)   | Dansk (Danish)  | Deutsch (German)  |
|--|---|---|---|
| <p>Екологична продуктова декларация</p> <p>RoHS Директива 2011/65/EC<br/>WEEE Директива 2012/19/EC<br/>PPW Директива 94/62/EC<br/>REACH REGULATION (EC) n° 1907/2006<br/>ErP Директива 2009/125/EC</p> <p>Име/ титла : Richard Hsu / Quality Management<br/>Division Senior Manager<br/>Подпис : Дата (dd/mm/yyyy): 01/10/2014</p>                              | <p>Environmentální prohlášení o produktu</p> <p>RoHS Směrnice 2011/65/EU<br/>WEEE Směrnice 2012/19/EU<br/>PPW Směrnice 94/62/EC<br/>REACH Nařízení (ES) č. 1907/2006<br/>ErP Směrnice 2009/125/ES</p> <p>Jméno/ titul : Richard Hsu / Quality Management<br/>Division Senior Manager<br/>Podpis : Datum (dd/mm/yyyy): 01/10/2014</p>                     | <p>Miljøvaredeklaration</p> <p>RoHS Direktiv 2011/65/EU<br/>WEEE Direktiv 2012/19/EC<br/>PPW Direktiv 94/62/EF<br/>REACH Forordning (EF) nr. 1907/2006<br/>ErP Direktiv 2009/125/EF</p> <p>Navn/ titel : Richard Hsu / Quality Management<br/>Division Senior Manager<br/>Underskrift : Dato (dd/mm/åååå): 01/10/2014</p>                                | <p>Produkt-Umweltdeklaration</p> <p>RoHS Richtlinie 2011/65/EU<br/>WEEE Richtlinie 2012/19/EC<br/>PPW Richtlinie 94/62/EG<br/>REACH VERORDNUNG (EG) Nr. 1907/2006<br/>ErP Richtlinie 2009/125/EG</p> <p>Name/ titel : Richard Hsu / Quality Management<br/>Division Senior Manager<br/>Unterschrift : Datum (dd/mm/jj): 2014/10/01</p>               |
| Eesti keel (Estonian)  | English   | Español (Spanish)   | Français (French)   |
| <p>Toote keskkonnadeklaratsioon</p> <p>RoHS Direktiiv 2011/65/EU<br/>WEEE Direktiiv 2012/19/EC<br/>PPW Direktiiv 94/62/EÜ<br/>REACH MÄÄRÄKYS (EY) nr 1907/2006<br/>ErP Direktiiv 2009/125/EÜ</p> <p>Nimi/ ametikoht : Richard Hsu / Quality Management<br/>Division Senior Manager<br/>Allkiri : Kuupäev (pp/kk/aaaa): 01/10/2014</p>                           | <p>Environmental product declaration</p> <p>RoHS Directive 2011/65/EU<br/>WEEE Directive 2012/19/EC<br/>PPW Directive 94/62/EC<br/>REACH Regulation (EC) No 1907/2006<br/>ErP Directive 2009/125/EC</p> <p>Name/ title : Richard Hsu / Quality Management<br/>Division Senior Manager<br/>Signature : Date (dd/mm/yyyy) : 01/10/2014</p>                 | <p>Declaraciones Ambientales de Producto</p> <p>RoHS Directiva 2011/65/UE<br/>WEEE Directiva 2012/19/UE<br/>PPW Directiva 94/62/CE<br/>REACH Reglamento (CE) n° 1907/2006<br/>ErP Directiva 2009/125/CE</p> <p>Nombre/ título : Richard Hsu / Quality Management<br/>Division Senior Manager<br/>Firma : Fecha (aaaa/mm/dd): 2014/10/01</p>              | <p>Profil environnemental de produit</p> <p>RoHS Directive 2011/65/UE<br/>WEEE Directive 2012/19/UE<br/>PPW Directive 94/62/CE<br/>REACH REGLEMENT (CE) n° 1907/2006<br/>ErP Directive 2009/125/CE</p> <p>Nom/ titre : Richard Hsu / Quality Management<br/>Division Senior Manager<br/>Signature : Date (aaaa/mm/jj): 2014/10/01</p>                |
| Hrvatski (Croatian)  | Italiano (Italian)  | Latviešu valoda (Latvian)   | Lietuvių kalba (Lithuanian)   |
| <p>Deklaraciju o zbrinjavanju proizvoda</p> <p>RoHS Direktiva 2011/65/EU<br/>WEEE Direktiva 2012/19/EC<br/>PPW Direktiva 94/62/EZ<br/>REACH Uredba (EZ) br. 1907/2006<br/>ErP Direktiva 2009/125/EZ</p> <p>Ime/ naslov : Richard Hsu / Quality Management<br/>Division Senior Manager<br/>Podpis : Datum (dd/mm/yyyy): 01/10/2014</p>                      | <p>Dichiarazione ambientale di prodotto</p> <p>RoHS Direttiva 2011/65/UE<br/>WEEE Direttiva 2012/19/UE<br/>PPW Direttiva 94/62/CE<br/>REACH REGOLAMENTO (CE) n. 1907/2006<br/>ErP Direttiva 2009/125/CE</p> <p>Nome/ titolo : Richard Hsu / Quality Management<br/>Division Senior Manager<br/>Firma : Data (aaaa/mm/gg): 2014/10/01</p>            | <p>Produkta vides ietekmējuma deklarācija</p> <p>RoHS Direktīva 2011/65/ES<br/>WEEE Direktīva 2012/19/ES<br/>PPW Direktīva 94/62/EK<br/>REACH Regula (EK) Nr. 1907/2006<br/>ErP Direktīva 2009/125/EK</p> <p>Nosaukums/ tituls : Richard Hsu / Quality Management<br/>Division Senior Manager<br/>Paraksts : Datums (dd/mm/yyyy): 01/10/2014</p>    | <p>Apinkosaušingų gaminių deklaraciją</p> <p>RoHS Direktyva 2011/65/ES<br/>WEEE Direktyva 2012/19/ES<br/>PPW Direktyva 94/62/EB<br/>REACH REGLAMENTAS (EB) nr 1907/2006<br/>ErP Direktyva 2009/125/EB</p> <p>Vardas/ titulas : Richard Hsu / Quality Management<br/>Division Senior Manager<br/>Parašas : Data (aaaa/mm/mm): 01/10/2014</p>     |
| Magyar (Hungarian)   | Malti (Maltese)   | Nederlands (Dutch)  | Polski (Polish)   |
| <p>Környezetvédelmi terméknyilatkozatot</p> <p>RoHS 2011/65/EU irányelv<br/>WEEE 2012/19/EU irányelv<br/>PPW 94/62/EK irányelv<br/>REACH 1907/2006/EK rendelet<br/>ErP 2009/125/EK irányelv</p> <p>Név/ cím : Richard Hsu / Quality Management<br/>Division Senior Manager<br/>Aláírás : Dátum (dd/mm/yyyy): 2014/10/01</p>                               | <p>Dikjarazzjoni Ambientali dwar il-Prodott</p> <p>RoHS Direttiva 2011/65/UE<br/>WEEE Direttiva 2012/19/UE<br/>PPW Direttiva 94/62/CE<br/>REACH REGOLAMENTO (CE) NR 1907/2006<br/>ErP Direttiva 2009/125/CE</p> <p>Isim/ titolu : Richard Hsu / Quality Management<br/>Division Senior Manager<br/>Firma : Data (aaaa/jj): 2014/10/01</p>          | <p>Milieuproductverklaring</p> <p>RoHS Richtlijn 2011/65/EU<br/>WEEE Richtlijn 2012/19/EC<br/>PPW Richtlijn 94/62/EG<br/>REACH Verordening (EG) nr 1907/2006<br/>ErP Richtlijn 2009/125/EG</p> <p>Naam/ titel : Richard Hsu / Quality Management<br/>Division Senior Manager<br/>Handtekening : Datum (dd/mm/jaar): 01/10/2014</p>                 | <p>Deklaracja środowiskowa produktu</p> <p>RoHS Dyrektywa 2011/65/UE<br/>WEEE Dyrektywa 2012/19/UE<br/>PPW Dyrektywa 94/62/WE<br/>REACH Rozporządzenie (WE) nr 1907/2006<br/>ErP Dyrektywa 2009/125/WE</p> <p>Nazwisko/ tytuł : Richard Hsu / Quality Management<br/>Division Senior Manager<br/>Podpis : Data (dd/mm/rrrr): 2014/10/01</p>    |
| Português (Portuguese)   | Română (Romanian)   | Slovenčina (Slovak)   | Slovenščina (Slovene)   |
| <p>Declaração ambiental do produto</p> <p>RoHS Diretiva 2011/65/UE<br/>WEEE Diretiva 2012/19/UE<br/>PPW Diretiva 94/62/CE<br/>REACH Regulamento (CE) n° 1907/2006<br/>ErP Diretiva 2009/125/CE</p> <p>Nome/ título : Richard Hsu / Quality Management<br/>Division Senior Manager<br/>Assinatura : Data (dd/mm/aaaa): 01/10/2014</p>                      | <p>Declarație de mediu privind produsele</p> <p>RoHS Directivă 2011/65/UE<br/>WEEE Directivă 2012/19/UE<br/>PPW Directivă 94/62/CE<br/>REACH REGULAMENTUL (CE) NR 1907/2006<br/>ErP Directivă 2009/125/CE</p> <p>Numele/ titlu : Richard Hsu / Quality Management<br/>Division Senior Manager<br/>Semnătura : Data (dd/mm/aaaa): 01/10/2014</p>    | <p>Vyhľadzenie o environmentálnom výrobu</p> <p>RoHS Smernica 2011/65/EU<br/>WEEE Smernica 2012/19/EC<br/>PPW Smernica 94/62/ES<br/>REACH Nařízení (ES) č. 1907/2006<br/>ErP Smernica 2009/125/ES</p> <p>Menor/ titul : Richard Hsu / Quality Management<br/>Division Senior Manager<br/>Podpis : Datum (dd/mm/yyyy): 01/10/2014</p>               | <p>Okoljsko deklaracija izdelka</p> <p>RoHS Direktiva 2011/65/UE<br/>WEEE Direktiva 2012/19/UE<br/>PPW Direktiva 94/62/ES<br/>REACH Uredba (ES) č. 1907/2006<br/>ErP Direktiva 2009/125/ES</p> <p>Ime/ naziv : Richard Hsu / Quality Management<br/>Division Senior Manager<br/>Podpis : Datum (dd/mm/jj): 01/10/2014</p>                      |
| Suomi (Finnish)  | Svenska (Swedish)   | Ελληνικά (Greek)  | Norsk (Norwegian)   |
| <p>Standardin perustava ympäristötuoteilmoitus</p> <p>RoHS Direktiiv 2011/65/EU<br/>WEEE Direktiiv 2012/19/EC<br/>PPW Direktiiv 94/62/EY<br/>REACH ASETUS (EY) N:o 1907/2006<br/>ErP Direktiiv 2009/125/EY</p> <p>Nimi/ osasto : Richard Hsu / Quality Management<br/>Division Senior Manager<br/>Alaenkirja : Päivämäärä (pp/kk/vvvv): 01/10/2014</p>    | <p>Miljöproduktdeklaration</p> <p>RoHS Direktiv 2011/65/EU<br/>WEEE Direktiv 2012/19/EC<br/>PPW Direktiv 94/62/EG<br/>REACH Förordning (EG) nr 1907/2006<br/>ErP Direktiv 2009/125/EG</p> <p>Navn/ titel : Richard Hsu / Quality Management<br/>Division Senior Manager<br/>Namnteckning : Datum (dd/mm/åååå): 01/10/2014</p>                      | <p>Περιβαλλοντική δήλωση προϊόντος</p> <p>RoHS Οδηγία 2011/65/ΕΕ<br/>WEEE Οδηγία 2012/19/ΕΕ<br/>PPW Οδηγία 94/62/ΕΚ<br/>REACH Λειτουργικό (ΕΚ) αριθ. 1907/2006<br/>ErP Οδηγία 2009/125/ΕΚ</p> <p>Όνομα/ τίτλος : Richard Hsu / Quality Management<br/>Division Senior Manager<br/>Υπογραφή : Ημερομηνία (pp/mm/åååå): 01/10/2014</p>               | <p>Miljødeklarasjon</p> <p>RoHS Direktiv 2011/65/UE<br/>WEEE Direktiv 2012/19/UE<br/>PPW Direktiv 94/62/EF<br/>REACH Forordning (EF) nr. 1907/2006<br/>ErP Direktiv 2009/125/EF</p> <p>Navn/ titel : Richard Hsu / Quality Management<br/>Division Senior Manager<br/>Signatur : Dato (dd/mm/åååå): 01/10/2014</p>                             |

## 台灣



以下訊息僅適用於產品具有無線功能且銷售至台灣地區

- 第十二條 經型式認證合格之低功率射頻電機，非經許可，公司，商號或使用者均不得擅自變更頻率、加大功率或變更原設計之特性及功能。
- 第十四條 低功率射頻電機之使用不得影響飛航安全及干擾合法通信；經發現有干擾現象時，應立即停用，並改善至無干擾時方得繼續使用。前項合法通信，指依電信法規定作業之無線電通信。低功率射頻電機須忍受合法通信或工業、科學及醫療用電波輻射性電機設備之干擾。
- 電磁波曝露量 MPE 標準值  $1\text{mW}/\text{cm}^2$ ，送測產品實測值為：0.282  $\text{mW}/\text{cm}^2$ 。本產品使用時建議應距離人體 20  $\text{cm}$ 。
- 無線資訊傳輸設備忍受合法通信之干擾且不得干擾合法通信；如造成干擾，應立即停用，俟無干擾之虞，始得繼續使用。
- 無線資訊傳輸設備的製造廠商應確保頻率穩定性，如依製造廠商使用手冊上所述正常操作，發射的信號應維持於操作頻帶中

以下訊息僅適用於產品操作於 5.25-5.35 兆赫頻帶內並銷售至台灣地區

- 在 5.25-5.35 兆赫頻帶內操作之無線資訊傳輸設備，限於室內使用。

以下訊息僅適用於產品屬於專業安裝並銷售至台灣地區

- 本器材須經專業工程人員安裝及設定，始得 設置使用，且不得直接販售給一般消費者

安全警告 - 為了您的安全，請先閱讀以下警告及指示：



- 請勿將此產品接近水、火焰或放置在高溫的環境。
- 避免設備接觸
  - 任何液體 - 切勿讓設備接觸水、雨水、高濕度、污水腐蝕性的液體或其他水份。
  - 灰塵及污物 - 切勿接觸灰塵、污物、沙土、食物或其他不合適的材料。
- 雷雨天氣時，不要安裝，使用或維修此設備。有遭受電擊的風險。
- 切勿重摔或撞擊設備，並勿使用不正確的電源變壓器。
- 若接上不正確的電源變壓器會有爆炸的風險。
- 請勿隨意更換產品內的電池。
- 如果更換不正確之電池型式，會有爆炸的風險，請依製造商說明書處理使用過之電池。
- 請將廢電池丟棄在適當的電器或電子設備回收處。
- 請勿將設備解體。
- 請勿阻礙設備的散熱孔，空氣對流不足將會造成設備損害。
- 請插在正確的電壓供給插座（如：北美 / 台灣電壓 110V AC，歐洲是 230V AC）。
- 假若電源變壓器或電源變壓器的纜線損壞，請從插座拔除，若您還繼續插電使用，會有觸電死亡的風險。
- 請勿試圖修理電源變壓器或電源變壓器的纜線，若有毀損，請直接聯絡您購買的店家，購買一個新的電源變壓器。
- 請勿將此設備安裝於室外，此設備僅適合放置於室內。
- 請勿隨一般垃圾丟棄。
- 請參閱產品背貼上的設備額定功率。
- 請參考產品型錄或是彩盒上的作業溫度。
- 產品沒有斷電裝置或者採用電源線的插頭視為斷電裝置的一部分，以下警語將適用：
  - 對永久連接之設備，在設備外部須安裝可觸及之斷電裝置；
  - 對插接式之設備，插座必須接近安裝之地點而且是易於觸及的。

## About the Symbols

Various symbols are used in this product to ensure correct usage, to prevent danger to the user and others, and to prevent property damage. The meaning of these symbols are described below. It is important that you read these descriptions thoroughly and fully understand the contents.

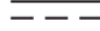

**Explanation of the Symbols**

| SYMBOL  | EXPLANATION  |
|---|--|
|  | Alternating current (AC):<br>AC is an electric current in which the flow of electric charge periodically reverses direction.                                   |
|  | Direct current (DC):<br>DC is the unidirectional flow or movement of electric charge carriers.   |
|  | Earth; ground:<br>A wiring terminal intended for connection of a Protective Earthing Conductor.  |
|  | Class II equipment:<br>The method of protection against electric shock in the case of class II equipment is either double insulation or reinforced insulation. |

**Viewing Certifications**

Go to <http://www.zyxel.com> to view this product's documentation and certifications.

**Zyxel Limited Warranty**

Zyxel warrants to the original end user (purchaser) that this product is free from any defects in material or workmanship for a specific period (the Warranty Period) from the date of purchase. The Warranty Period varies by region. Check with your vendor and/or the authorized Zyxel local distributor for details about the Warranty Period of this product. During the warranty period, and upon proof of purchase, should the product have indications of failure due to faulty workmanship and/or materials, Zyxel will, at its discretion, repair or replace the defective products or components without charge for either parts or labor, and to whatever extent it shall deem necessary to restore the product or components to proper operating condition. Any replacement will consist of a new or re-manufactured functionally equivalent product of equal or higher value, and will be solely at the discretion of Zyxel. This warranty shall not apply if the product has been modified, misused, tampered with, damaged by an act of God, or subjected to abnormal working conditions.

**Note**

Repair or replacement, as provided under this warranty, is the exclusive remedy of the purchaser. This warranty is in lieu of all other warranties, express or implied, including any implied warranty of merchantability or fitness for a particular use or purpose. Zyxel shall in no event be held liable for indirect or consequential damages of any kind to the purchaser.

To obtain the services of this warranty, contact your vendor. You may also refer to the warranty policy for the region in which you bought the device at [http://www.zyxel.com/web/support\\_warranty\\_info.php](http://www.zyxel.com/web/support_warranty_info.php).

**Registration**

Register your product online to receive e-mail notices of firmware upgrades and information at [www.zyxel.com](http://www.zyxel.com) for global products, or at [www.us.zyxel.com](http://www.us.zyxel.com) for North American products.

**Open Source Licenses**

This product contains in part some free software distributed under GPL license terms and/or GPL like licenses. Open source licenses are provided with the firmware package. You can download the latest firmware at [www.zyxel.com](http://www.zyxel.com). To obtain the source code covered under those Licenses, please contact [support@zyxel.com.tw](mailto:support@zyxel.com.tw) to get it.

# Index

## A

Advanced Encryption Standard, see AES [9](#)  
AES (Advanced Encryption Standard) [9](#)  
applications [7](#)

## C

certifications [77](#)  
    viewing [81](#)  
channel [34](#)  
Configuration  
    restore [61](#)  
connections overview [9](#)  
contact information [68](#)  
copyright [74](#)  
CPU usage [25](#)  
customer support [68](#)

## D

Daylight saving [59](#)  
disclaimer [74](#)

## E

encryption [9, 35](#)  
    key [35](#)  
    WPA compatible [35](#)

## F

Firmware upload [59](#)  
    file extension  
    using HTTP

firmware version [24](#)

## G

General wireless LAN screen [35](#)

## H

HomePlug [52](#)  
HomePlug AV standard [7](#)

## I

introduction [7](#)  
IP Address [51](#)  
IP alias [49](#)

## L

LAN [48](#)  
LAN overview [48](#)  
LAN setup [48](#)  
LAN TCP/IP [49](#)  
Language [62](#)  
LED [64](#)  
    ETHERNET [8](#)  
    HomePlug [9](#)  
    POWER [8](#)  
Link type [25](#)  
Local Area Network [48](#)  
Log [28](#)

**M**

MAC [41](#)  
MAC address [34](#)  
MAC address filter [34](#)  
MAC address filtering [41](#)  
MAC filter [41](#)  
management  
    multiple networks [10](#)  
Media access control [41](#)  
Memory usage [25](#)  
multiple networks [11](#)

**N**

network name [16](#)

**O**

One Connect [55](#)  
Operating Channel [24](#)

**P**

passwords [53](#)  
PLA Comparison [7](#)  
port speed [25](#)  
Powerline Network  
    Adding Devices [12](#)  
    Creating multiple networks [15](#)  
    Removing Devices [14](#)  
powerline setting [52](#)  
problems and solutions [64](#)

**Q**

Quality of Service (QoS) [43](#)

**R**

RESET/ENCRYPT Button  
    Manage [9](#)  
Restore configuration [61](#)  
Roaming [42](#)  
RTS/CTS Threshold [33, 42, 43](#)

**S**

Scheduling [46](#)  
security [10](#)  
Service Set [36](#)  
Service Set IDentification [36](#)  
Service Set IDentity. See SSID.  
SSID [24, 34, 36](#)  
Status Screens  
    Ethernet [23](#)  
    system statistics [23](#)  
    WLAN [23](#)  
Subnet Mask [51](#)  
Summary  
    Packet statistics [29](#)  
    Wireless station status [30](#)  
System General Setup [56](#)  
System restart [62](#)

**T**

Time setting [57](#)  
transfer rates [9](#)  
troubleshooting [64](#)

**W**

warranty [81](#)  
    note [81](#)  
Web Configurator  
    how to access [18](#)  
    Overview [18](#)  
WEP Encryption [39, 41](#)

- WEP encryption [38](#)
- WEP key [38](#)
- Wireless association list [30](#)
- wireless LAN scheduling [46](#)
- Wireless network
  - basic guidelines [33](#)
  - channel [34](#)
  - encryption [35](#)
  - example [32](#)
  - MAC address filter [34](#)
  - overview [32](#)
  - security [34](#)
  - SSID [34](#)
- Wireless security [34](#)
  - overview [34](#)
  - type [34](#)
- Wizard setup [26](#)
- WPA compatible [35](#)