

# Prestige 310

## *User's Guide*

Version 1.0

**ZyXEL**

TOTAL INTERNET ACCESS SOLUTION

---

The declarations of CE marking:



The Prestige 310 has been approved for connection to the Public Switched Telecommunication Network using interfaces compatible with ITU-TSS recommendation I.420 (Basic Rate ISDN user access). The Prestige 310 complies with the following directives:

1. The Council Directive 89/336/EEC of 3 May 1992 on the approximation of the laws of the member states relation to Electro Magnetic Compatibility. (EMC Directive).
2. Council Directive 91/263/EEC of 29 April 1991 on the approximation of the laws of the Member States concerning telecommunication terminal equipment. (The Telecom Terminal Equipment Directive).
3. 93/68/EEC of 22 July 1993 amending the Directives 89/336/EEC, 91/263 /EEC and 92/31/EEC. (Marking Directive).
4. The Council Directive 92/31/EEC of 28 April 1992 amending directive on the approximation of the laws of the member states relating to Electro Magnetic Compatibility

## Customer Support

If you have questions about your ZyXEL product or desire assistance, contact ZyXEL Communications Corporation offices worldwide, in one of the following ways:

Method	International	North America	Scandinavia
E-Mail-Tech Support	<a href="mailto:support@zyxel.com.tw">support@zyxel.com.tw</a> <a href="mailto:support@zyxel.co.at">support@zyxel.co.at</a> (Europe)	<a href="mailto:support@zyxel.com">support@zyxel.com</a>	<a href="mailto:support@zyxel.dk">support@zyxel.dk</a>
E-Mail-Sales	<a href="mailto:sales@zyxel.com.tw">sales@zyxel.com.tw</a>	<a href="mailto:sales@zyxel.com">sales@zyxel.com</a>	<a href="mailto:sales@zyxel.dk">sales@zyxel.dk</a>
Web Site	<a href="http://www.zyxel.com">www.zyxel.com</a>	<a href="http://www.zyxel.com">www.zyxel.com</a>	<a href="http://www.zyxel.dk">www.zyxel.dk</a>
Phone	+886-3-5783942 Ext.266	+1-714-632-0882 800-255-4101	+45-3955-0700
Fax	+886-3-5782439	+1-714-632-0858	+45-3955-0707
FTP - Software and ROM upgrades	<a href="ftp://ftp.zyxel.dk">ftp.zyxel.dk</a>	<a href="ftp://ftp.zyxel.com">ftp.zyxel.com</a>	<a href="ftp://ftp.zyxel.dk">ftp.zyxel.dk</a>
Regular Mail	ZyXEL Communications Corp., 6 Innovation Road II, Science-Based Industrial Park, Hsin-chu, Taiwan 300, R.O.C.	ZyXEL Communications Inc., 1650 Miraloma Avenue, Placentia, CA 92870, U.S.A.	ZyXEL A/S Columbusvej 5, 2860 Soeborg, Copenhagen, Denmark

# Table of Contents

<b>Table of Contents</b> .....	vii
<b>List of Figures</b> .....	xi
<b>List of Tables</b> .....	xiii
<b>Preface</b> .....	xiv
<b>Chapter 1</b> .....	1-1
<b>Getting to Know Your Router</b> .....	1-1
1.1 Prestige 310 Broadband Router.....	1-1
1.2 Features of Prestige 310.....	1-1
1.3 Applications for Prestige 310 .....	1-3
1.3.1 Internet Access.....	1-3
<b>Chapter 2</b> .....	2-1
<b>Hardware Installation &amp; Initial Setup</b> .....	2-1
2.1 Front Panel LEDs and Back Panel Ports .....	2-1
2.1.1 Front Panel LEDs .....	2-1
2.2 Prestige 310 Rear Panel and Connections .....	2-2
2.3 Additional Installation Requirements.....	2-3
2.4 Stacking ZyXEL Routers .....	2-4
2.5 Power On Your Prestige.....	2-4
2.6 Navigating the SMT Interface.....	2-6
2.6.1 Main Menu.....	2-7
2.6.2 System Management Terminal Interface Summary.....	2-7
2.7 Changing the System Password.....	2-8
2.8 General Setup .....	2-9
2.9 WAN Setup.....	2-10
2.10 LAN Setup.....	2-11

---

6.2.3	TCP/IP Filter Rule .....	6-6
6.2.4	Generic Filter Rule.....	6-9
6.3	Applying a Filter.....	6-11
6.3.1	Ethernet traffic .....	6-11
6.3.2	Remote Node Filters .....	6-12
<b>Chapter 7</b>	.....	<b>7-1</b>
<b>System Maintenance</b>	.....	<b>7-1</b>
7.1	System Status .....	7-2
7.2	Console Port Speed .....	7-4
7.3	Log and Trace .....	7-4
7.3.1	Viewing Error Log .....	7-4
7.3.2	Unix Syslog.....	7-6
7.4	Diagnostic.....	7-7
7.5	Backup Configuration .....	7-8
7.6	Restore Configuration .....	7-9
7.7	Firmware Update.....	7-9
7.7.1	Uploading the RAS Code.....	7-10
7.7.2	Uploading ROM File .....	7-10
7.7.3	TFTP Transfer.....	7-11
7.8	Command Interpreter Mode .....	7-13
7.8.1	Boot commands.....	7-14
<b>Chapter 8</b>	.....	<b>8-1</b>
<b>Telnet Configuration and Capabilities</b>	.....	<b>8-1</b>
8.1	About Telnet Configuration.....	8-1
8.2	Telnet Under SUA.....	8-2
8.3	Telnet Capabilities .....	8-2
8.3.1	Single Administrator .....	8-2

# List of Figures

Figure 1-1 Internet Access Application .....	1-3
Figure 2-1 Front Panel .....	2-1
Figure 2-2 Prestige 310 Rear Panel and Connections .....	2-2
Figure 2-3 Initial Screen.....	2-4
Figure 2-4 Login Screen.....	2-5
Figure 2-5 Prestige 310 Main Menu .....	2-7
Figure 2-6 Menu 23 - System Security .....	2-8
Figure 2-7 Menu 1 – General Setup.....	2-9
Figure 2-8 Menu 2 – WAN Setup.....	2-10
Figure 2-9 Menu 3 - LAN Setup .....	2-11
Figure 2-10 Menu 3.1 - General LAN Setup.....	2-11
Figure 3-1 Menu 3 - LAN (10/100Mbps Ethernet) Setup.....	3-4
Figure 3-2 Menu 3.2 – TCP/IP and DHCP LAN Setup .....	3-4
Figure 3-3 Menu 4 – Internet Access Setup .....	3-7
Figure 3-4 Single User Account Topology.....	3-9
Figure 3-5 Menu 4 – Internet Access Setup for Single User Account .....	3-11
Figure 4-1 Example of Static Routing Topology .....	4-1
Figure 4-2 Menu 12.1 - Edit IP Static Route.....	4-2
Figure 4-3 Menu 12. Edit IP Static Route .....	4-2
Figure 5-1 Multiple Server Configuration.....	5-2
Figure 6-1 Outgoing Packet Filtering Process .....	6-1
Figure 6-2 Menu 21 - Filter Set Configuration .....	6-2
Figure 6-3 Menu 21.1 - Filter Rules Summary .....	6-3
Figure 6-4 Menu 21.2 - Filter Rules Summary .....	6-3
Figure 6-5 Menu 21.1.1 - TCP/IP Filter Rule .....	6-6
Figure 6-6 Menu 21.1.2 - Generic Filter Rule.....	6-9

# List of Tables

Table 2-1 LED functions .....	2-1
Table 2-2 Main Menu Commands.....	2-6
Table 2-3 Main Menu Summary .....	2-7
Table 2-4 General Setup Menu Fields.....	2-9
Table 3-1 DHCP LAN Setup Menu Fields.....	3-5
Table 3-2 TCP/IP LAN Setup Menu Fields .....	3-6
Table 3-3 Internet Access Setup Menu Fields.....	3-8
Table 3-4 Single User Account Menu Fields .....	3-11
Table 4-1 IP Static Route Menu Fields .....	4-3
Table 5-1 Services vs. Port number.....	5-2
Table 6-1 Abbreviations Used in the Filter Rules Summary Menu.....	6-4
Table 7-1 System Maintenance - Status Menu Fields .....	7-3
Table 7-2 System Maintenance Menu Syslog Parameters.....	7-6
Table 7-3 System Maintenance Menu Diagnostic.....	7-8
Table 9-1 Troubleshooting the Start-Up of your Prestige .....	9-1
Table 9-2 Troubleshooting the LAN Interface .....	9-2
Table 9-3 Troubleshooting the WAN interface.....	9-2

## **Syntax Conventions**

For brevity's sake, we will use "e.g." as a shorthand for "for instance" and "i.e." for "that is" or "in other words" throughout this manual.



# Chapter 1

## Getting to Know Your Router

This chapter describes the key features and applications of your Prestige.

### **1.1 Prestige 310 Broadband Router**

The Prestige 310 is a high bandwidth Internet access router that connects your LAN to the Internet using the existing television cable. It is ideal for cable users with more than one PC and as an alternative to the more expensive leased lines.

### **1.2 Features of Prestige 310**

The following are the key features of the Prestige 310.

#### ***Auto-negotiating 10/100Mbps Ethernet***

The LAN interface automatically detects if it's on a 10/100 Mbps Ethernet.

#### ***Single User Account (SUA)***

The SUA™ (Single User Account) features allows multiple users to share a single ISP account.

#### ***Packet Filter***

The Packet Filter blocks unwanted traffic from entering your network.

#### ***DHCP Server***

The Prestige's DHCP (Dynamic Host Configuration Protocol) server capability allows you to automatically assign TCP/IP settings to a workstation on your network.

#### ***DHCP Client***

The Prestige's DHCP client capability allows it to get automatically its IP address from the ISP on the WAN.

#### ***Full Network Management***

Accessing SMT (System Management Terminal) through the console port or telnet connection.

## 1.3 Applications for Prestige 310

The following sections show you the possible applications for your Prestige.

### 1.3.1 Internet Access

The Prestige is the ideal high-speed Internet access solution. Your Prestige supports the TCP/IP protocol, which the Internet uses exclusively. A typical Internet Access application is shown below.

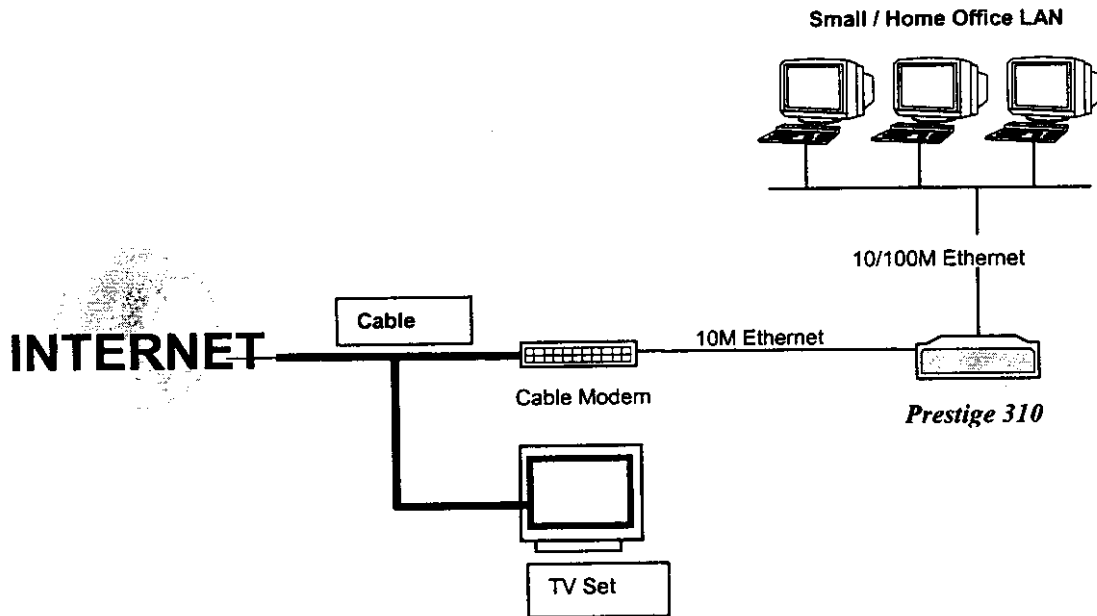

Figure 1-1 Internet Access Application

#### Internet Single User Account

For a SOHO (small office/Home Office) environment, your Prestige offers a Single User Account (SUA) feature that allows multiple users on the LAN (Local Area Network) to access the Internet concurrently for the cost of a single user.

# Chapter 2

## Hardware Installation & Initial Setup

This chapter shows you how to connect the hardware and to perform the initial setup.

### 2.1 Front Panel LEDs and Back Panel Ports

#### 2.1.1 Front Panel LEDs

The LED indicators on the front panel indicate the functional status of the Prestige.

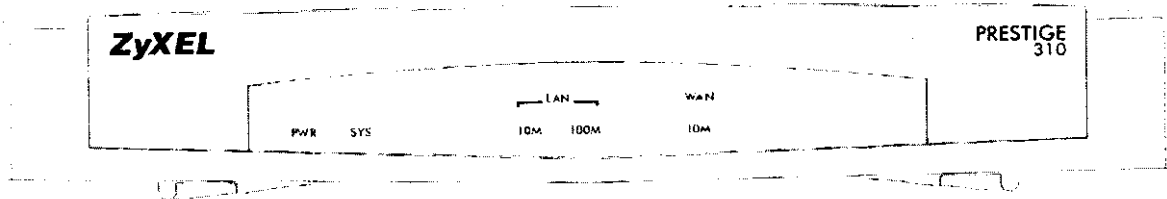

**Figure 2-1 Front Panel**

The following table describes the LED functions:

**Table 2-1 LED functions**

LEDs	Function	Indicator Status	Active	Description
PWR	Power	Green	On	The power adapter is connected to the <i>Prestige</i> .
SYS	System		Off	The system is not ready or failed.
			On	The system is ready and running.
			Flashing	The system is rebooting.
10M LAN	LAN	Green	On	The Prestige is connected to a 10Mbps LAN.
			Flashing	The 10M LAN is sending/receiving packets.
			Off	The 10M LAN is not connected.
100M LAN		Orange	On	The Prestige is connected to a 100Mbps LAN.
			Flashing	The 100M LAN is sending/receiving packets.

This section outlines how to connect your Prestige 310 to the LAN and the WAN.

**Step 1.** Connecting the Cable Modem

Connect the coaxial cable from your cable service to the threaded coaxial CABLE connector on the back of the cable modem.

**Step 2.** Connecting the Prestige to Cable Modem

Connect the WAN port (silver) on the Prestige to the LAN port on the cable modem using a straight through Ethernet cable. The Ethernet port on the cable modem is sometimes labeled "PC" or "Workstation".

**Step 3.** Connecting the Prestige to the LAN

If you have more than one PC, you must use an external hub. Connect the 10/100M LAN port (gold) on the Prestige to a port on the hub using a straight through Ethernet cable. If you only have one PC, you can connect the Prestige to the PC directly without a hub. For a single PC, connect the 10/100M LAN port on the Prestige to the Network Adapter on the PC using a crossover cable (red tag).

**Step 4.** Connecting the Power Adapter to your Prestige

Connect the power adapter to the port labeled **POWER** on the rear panel of your Prestige.

**Step 5.** Connecting the Console Port

For the initial configuration of your Prestige, you need to use terminal emulator software on a workstation and connect it to the Prestige through the console port. Connect the 9-pin (smaller) end of the console cable to the console port of the Prestige and the 25-pin (bigger) end to a serial port (COM1, COM2 or other COM port) of your workstation. You can use an extension RS-232 cable if the enclosed one is too short.

After the initial setup, you can modify the configuration remotely through telnet connections.

### 2.3 Additional Installation Requirements

In addition to the contents of your package, there are other hardware and software requirements you need before you can install and use your Prestige. These requirements include:

• A computer with an Ethernet NIC (Network Interface Card) installed.

• A computer equipped with communications software configured to the following parameters:

- ◆ VT100 terminal emulation.
- ◆ 9600 Baud.
- ◆ No parity, 8 Data bits, 1 Stop bit.

**Step 2. Entering Password**

The login screen appears after you press [Enter], prompting you to enter the password, as shown below.

For your first login, enter the default password **1234**. As you type the password, the screen displays an (X) for each character you type.

Please note that if there is no activity for longer than 5 minutes after you log in, your Prestige will automatically log you out and will display a blank screen. If you see a blank screen, press [Enter] to bring up the login screen again.

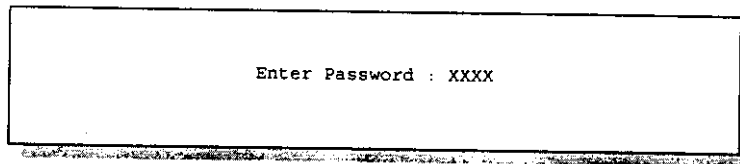

**Figure 2-4 Login Screen**

## 2.6.1 Main Menu

After you enter the password, the SMT displays the **Prestige 310 Main Menu**, as shown below.

```

Prestige 310 Main Menu

Getting Started
 1. General Setup
 2. WAN Setup
 3. LAN Setup

Advanced Applications
11. Static Routing Setup
12. SUA Server Setup

Advanced Management
21. Filter Set Configuration
23. System Password
24. System Maintenance
99. Exit

Enter Menu Selection Number:

```

Figure 2-5 Prestige 310 Main Menu

## 2.6.2 System Management Terminal Interface Summary

Table 2-3 Main Menu Summary

#	Menu Title	Description
1	General Setup	Use this menu to setup general information.
2	WAN Setup	Use this menu to setup the WAN.
3	LAN Setup	Use this menu to setup the LAN.
4	Internet Access Setup	A quick and easy way to setup Internet connection.
12	Static Routing Setup	Use this menu to setup static route for different protocols.
15	SUA Server Setup	Use this menu to specify inside servers when SUA is enabled.
21	Filter Set Configuration	Use this menu to setup filters to provide security.
23	System Password	Use this menu to setup a new password.
24	System Maintenance	This menu provides system status, diagnostics, firmware upload, etc.
99	Exit	To exit from SMT and return to the blank screen.

## 2.7 Changing the System Password

The first thing you should do before anything else is to change the default system password by following the steps below.

**Step 1.** Enter 23 in the Main Menu to open **Menu 23 - System Password** as shown below.

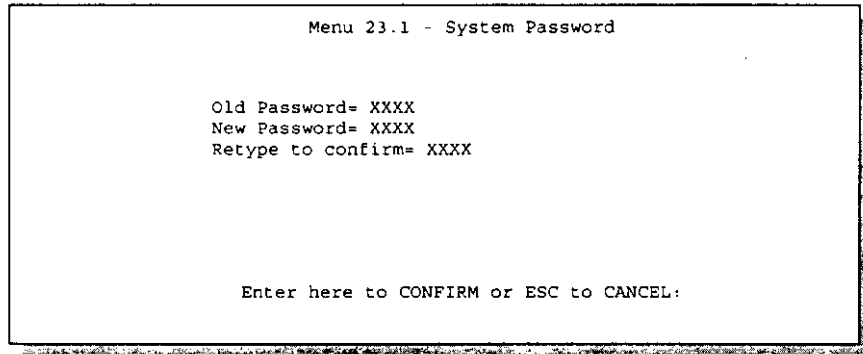

**Figure 2-6 Menu 23 - System Security**

**Step 2.** Enter your existing password and press [Enter].

**Step 3.** Enter your new system password and press [Enter].

**Step 4.** Re-type your new system password for confirmation and press [Enter].

Note that as you type a password, the screen displays a (X) for each character you type.

## 2.6 Navigating the SMT Interface

The SMT (System Management Terminal) is the interface that you use to configure your Prestige.

Several operations that you should be familiar with before you attempt to modify the configuration are listed in the table below.

**Table 2-2 Main Menu Commands**

Operation	Press/<read>	Description
Move forward to another menu	[Enter]	To move forward to a sub-menu, type in the number of the desired sub-menu and press [Enter].
Move backward to a previous menu	[Esc]	Press the [Esc] key to move back to the previous menu.
Move the cursor	[Enter] or [Up]/[Down] arrow keys	Within a menu, press [Enter] to move to the next field. You can also use the [Up]/[Down] arrow keys to move to the previous and the next field, respectively.
Enter information	Fill in, or Press the [Space bar] to toggle	You need to fill in two types of fields. The first requires you to type in the appropriate information. The second allows you to cycle through the available choices by pressing the [Space] bar.
Required fields	<?>	All fields with the symbol <?> must be filled in order to be able to save the new configuration.
N/A fields	<N/A>	Some of the fields in the SMT will show a <N/A>. This symbol refers to an option that is Not Applicable.
Save your configuration	[Enter]	Save your configuration by pressing [Enter] at the message [Press ENTER to confirm or ESC to cancel]. Saving the data on the screen will take you, in most cases to the previous menu.
Exit the SMT	Type 99, then press [Enter].	Type 99 at the Main Menu prompt and press [Enter] to exit the SMT interface.



A cable modem and an ISP account.

After the Prestige is properly set up, you can make future changes to the configuration through telnet connections.

## **2.4 Stacking ZyXEL Routers**

Your Prestige's has legs that fit together for sturdy stacking. You should not stack more than four routers for maximum stack stability.

## **2.5 Power On Your Prestige**

At this point, you should have connected the console port, the LAN port, the WAN port and the power port to the appropriate devices or lines. Plug the power adapter into a wall outlet. The Power LED should be on. The SYS LED will come on after the system tests are complete. The WAN LED and one of the LAN LED's come on immediately after the SYS LED comes on, if connections have been made to the LAN and WAN ports.

### **Step 1. Initial Screen**

When you power on your Prestige, it performs several internal tests as well as line initialization. After the tests, the Prestige asks you to press **[Enter]** to continue, as shown.

```
ZyXEL BIOS: Build at Fri Mar 05 13:25:20 1999
RAM: Size = 4096 Kbytes
DRAM POST: Testing: 4096K OK
FLASH: intel 8M

rom=0x06008000
ZyXEL BootExtension Version ba0.01, Build at Wed Mar 10 11:48:21 1999

Press any key to enter debug mode within 3 seconds.

Enter Debug mode.
```

**Figure 2-3 Initial Screen**

			Off	The 100M LAN is not connected.
WAN	WAN	Green	Off	The WAN Link is not ready, or failed.
			On	The WAN Link is ok.
			Flashing	The 100M LAN link is sending/receiving packets.

## 2.2 Prestige 310 Rear Panel and Connections

The figure below shows the rear panel of your Prestige 310 and the connection diagram.

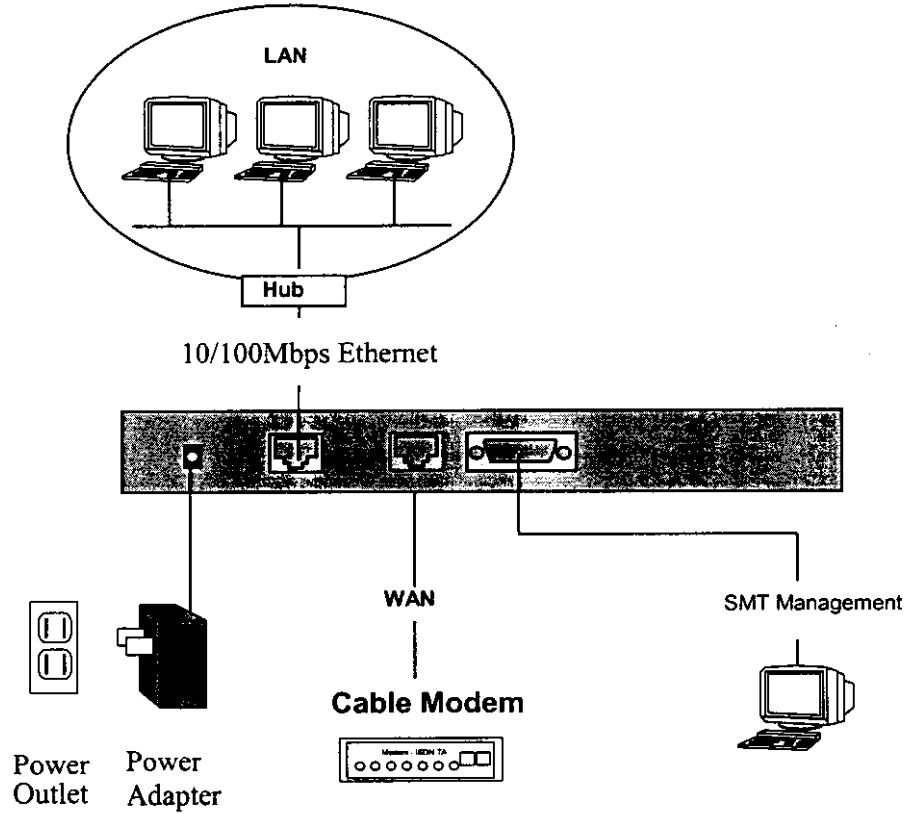

Figure 2-2 Prestige 310 Rear Panel and Connections



### **RoadRunner Support**

In addition to standard cable modem services, the Prestige supports Time Warner's RoadRunner Service.

### **Logging and Tracing**

- ◆ Built-in message logging and packet tracing.
- ◆ Unix syslog facility support.

### **Upgrade P310 Firmware via LAN**

The firmware of the Prestige 310 can be upgraded via the LAN.



# Preface

## About Your Router

Congratulations on your purchase of the Prestige 310 Broadband Router.

The Prestige 310 router connects your 10/100Mbps LAN to the Internet through your a cable modem.

Your Prestige 310 is easy to install and to configure since you do not need to set any switches.

The Prestige Network Commander (PNC) is a GUI based utility that allows you to access the Prestige's management settings. Moreover, all functions of the Prestige 310 are software configurable via the SMT (System Management Terminal) Interface. The SMT is a menu-driven interface that you can access from either a terminal emulator or Telnet on a PC.

## About This User's Manual

The nine chapters of this manual are designed to guide you through the configuration of your Prestige 310 for its various applications.

## Structure of this Manual

This manual is divided into five parts:

1. *Getting Started* (Chapters 1-2) is structured as a step-by-step guide to help you connect, install and setup your Prestige to operate on your network.
2. *The Internet* (Chapter 3) describes how to configure your Prestige for Internet access.
3. *Management & Maintenance* (Chapters 4-7) provides information on management and maintenance facilities for network administrators.
4. *Telnet Configuration and Capabilities* (Chapter 8) provides information configuring using Telnet.
5. *Troubleshooting* (Chapter 9), provides information about solving common problems.

Regardless of your particular application, it is important that you follow the steps outlined in *Chapters 1-2* to connect your Prestige to your LAN. You can then refer to the appropriate chapters of the manual, depending on your applications.

Figure 6-7 Filtering Ethernet traffic.....	6-11
Figure 6-8 Filtering Remote Node traffic .....	6-12
Figure 7-1 Menu 24 - System Maintenance.....	7-1
Figure 7-2 Menu 24.1 - System Maintenance – Status .....	7-2
Figure 7-3 Menu 24.2 – System Maintenance – Change Console Port Speed .....	7-4
Figure 7-4 Examples of Error and Information Messages .....	7-5
Figure 7-5 Menu 24.3.2 - System Maintenance - Syslog and Accounting .....	7-6
Figure 7-6 Menu 24.4 - System Maintenance - Diagnostic .....	7-7
Figure 7-7 Menu 24.7 - System Maintenance - Backup Configuration .....	7-8
Figure 7-8 Menu 24.5 - System Maintenance - Backup Configuration .....	7-9
Figure 7-9 Menu 24.7 - System Maintenance - Upload Firmware .....	7-9
Figure 7-10 Menu 24.7.1 - System Maintenance - Upload RAS Code.....	7-10
Figure 7-11 Menu 24.7.2 - System Maintenance - Upload ROM File.....	7-11
Figure 7-12 Command mode .....	7-13
Figure 7-13 Boot module commands.....	7-14
Figure 8-1 Telnet Configuration on a TCP/IP Network.....	8-1

8.3.2 System Timeout .....	8-2
<b>Chapter 9</b> .....	<b>9-1</b>
<b>Troubleshooting</b> .....	<b>9-1</b>
9.1 Problems Starting Up the Prestige .....	9-1
9.2 Problems with the LAN Interface .....	9-2
9.3 Problems with the WAN interface .....	9-2
<b>Appendix A</b> .....	<b>1</b>
<b>Acronyms and Abbreviations</b> .....	<b>1</b>
<b>Index</b> .....	<b>1</b>



2.10.1	General LAN Setup.....	2-11
2.11	Protocol Dependent LAN Setup .....	2-12
<b>Chapter 3</b>	.....	<b>3-1</b>
<b>Internet Access</b>	.....	<b>3-1</b>
3.1	TCP/IP and DHCP for LAN .....	3-1
3.1.1	Factory LAN Defaults.....	3-1
3.1.2	IP Address and Subnet Mask .....	3-1
3.1.3	RIP Setup .....	3-2
3.1.4	DHCP Configuration.....	3-2
3.2	TCP/IP LAN Setup and DHCP .....	3-4
3.3	Internet Access Setup .....	3-7
3.4	Single User Account.....	3-9
3.4.1	Advantages of SUA.....	3-10
3.4.2	Single User Account Configuration .....	3-11
<b>Chapter 4</b>	.....	<b>4-1</b>
<b>IP Static Route Setup</b>	.....	<b>4-1</b>
4.1	IP Static Route Setup .....	4-2
<b>Chapter 5</b>	.....	<b>5-</b>
<b>Multiple SUA Servers</b>	.....	<b>5-</b>
5.1	Multiple Servers behind SUA .....	5-
5.1.1	Configuring a Server behind SUA .....	5-
<b>Chapter 6</b>	.....	<b>6-</b>
<b>Filter Configuration</b>	.....	<b>6</b>
6.1	About Filtering .....	6
6.2	Configuring a Filter Set.....	6
6.2.1	Filter Rules Summary Menu .....	6
6.2.2	Configuring a Filter Rule .....	6



## ZyXEL Limited Warranty

ZyXEL warrants to the original end user (purchaser) that this product is free from any defects in materials or workmanship for a period of up to two (2) years from the date of purchase. During the warranty period, and upon proof of purchase, should the product have indications of failure due to faulty workmanship and/or materials, ZyXEL will, at its discretion, repair or replace the defective products or components without charge for either parts or labor, and to whatever extent it shall deem necessary to restore the product or components to proper operating condition. Any replacement will consist of a new or re-manufactured functionally equivalent product of equal value, and will be solely at the discretion of ZyXEL. This warranty shall not apply if the product is modified, misused, tampered with, damaged by an act of God, or subjected to abnormal working conditions.

### Note

Repair or replacement, as provided under this warranty, is the exclusive remedy of the purchaser. This warranty is in lieu of all other warranties, express or implied, including any implied warranty of merchantability or fitness for a particular use or purpose. ZyXEL shall in no event be held liable for indirect or consequential damages of any kind of character to the purchaser.

To obtain the services of this warranty, contact ZyXEL's Service Center; refer to the separate Warranty Card for your Return Material Authorization number (RMA). Products must be returned Postage Prepaid. It is recommended that the unit be insured when shipped. Any returned products without proof of purchase or those with an out-dated warranty will be repaired or replaced (at the discretion of ZyXEL) and the customer will be billed for parts and labor. All repaired or replaced products will be shipped by ZyXEL to the corresponding return address, Postage Paid (USA and territories only). If the customer desires some other return destination beyond the U.S. borders, the customer shall bear the cost of the return shipment. This warranty gives you specific legal rights, and you may also have other rights which vary from state to state.

**This equipment has been tested and found to comply with the limits for a Class B digital device, pursuant to Part 15 of the FCC Rules. These limits are designed to provide reasonable protection against harmful interference in a residential installation. This equipment generates, uses and can radiate radio frequency energy and, if not installed and used in accordance with the instructions, may cause harmful interference to radio communications. However, there is no guarantee that interference will not occur in a particular installation. If this equipment does cause harmful interference to radio or television reception, which can be determined by turning the equipment off and on, the user is encouraged to try to correct the interference by one of the following measures:**

- Reorient or relocate the receiving antenna.
- Increase the separation between the equipment and receiver.
- Connect the equipment into an outlet on a circuit different from that to which the receiver is connected.
- Consult the dealer or an experienced radio/TV technician for help.

**FCC Caution: To assure continued compliance, use only shielded twisted interface cables when connecting LAN and WAN network connections. Any changes or modifications not expressly approved by the party responsible for compliance could void the user's authority to operate this equipment.**

# **Prestige 310**

## **Broadband Internet Access Router**

### **Copyright**

Copyright © 1999 by ZyXEL Communications Corporation.

The contents of this publication may not be reproduced in any part or as a whole, transcribed, stored in a retrieval system, translated into any language, or transmitted in any form or by any means, electronic, mechanical, magnetic, optical, chemical, photocopying, manual, or otherwise, without the prior written permission of ZyXEL Communications Corporation.

Published by ZyXEL Communications Corporation. All rights reserved.

### **Disclaimer**

ZyXEL does not assume any liability arising out of the application or use of any products, or software described herein. Neither does it convey any license under its patent rights nor the patent rights of others. ZyXEL further reserves the right to make changes in any products described herein without notice. This publication is subject to change without notice.

### **Trademarks**

Trademarks mentioned in this publication are used for identification purposes only and may be properties of their respective owners.

## 2.8 General Setup

**Menu 1 - General Setup** contains administrative and system-related information.

To enter Menu 1 and fill in the required information, follow these steps:

- Step 1.** Enter 1 in the Main Menu to open **Menu 1 – General Setup**.
- Step 2.** The Menu 1 - General Setup screen appears, as shown below. Fill in the required field marked [?].

```

Menu 1 - General Setup

System Name= ?

Press ENTER to Confirm or ESC to Cancel:
  
```

**Figure 2-7 Menu 1 – General Setup**

The fields for General Setup as shown below

**Table 2-4 General Setup Menu Fields**

Field	Description	Example
System Name	Choose a descriptive name for identification purposes. This name can be up to 30 alphanumeric characters long. Spaces are not allowed, but dashes "-" and underscores "_" are accepted.	P310

## 2.10 LAN Setup

This section describes how to configure the LAN using **Menu 3 – LAN Setup (10/100Mbps Ethernet)**. From the Main Menu, enter 3 to open Menu 3.

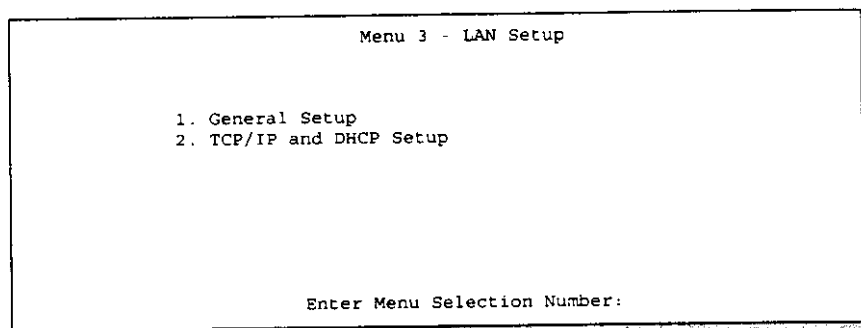

**Figure2-9 Menu 3 - LAN Setup**

### 2.10.1 General LAN Setup

This menu allows you to specify the filter sets that you wish to apply to the LAN traffic. You seldom need to filter the LAN traffic, however, the filter sets may be useful to block certain packets, reduce traffic and prevent security breaches.

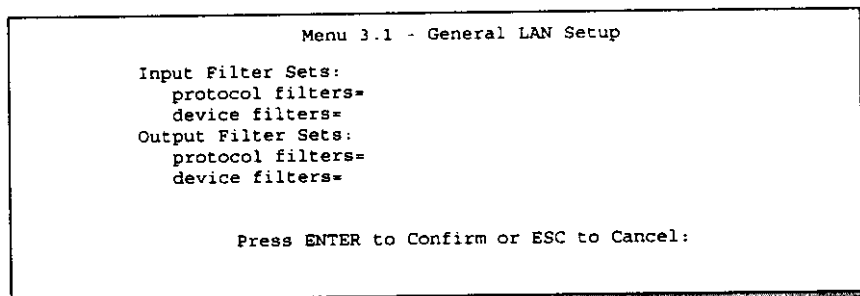

**Figure 2-10 Menu 3.1 - General LAN Setup**

If you need to define filters, please read *Chapter 7- Filter Set Configuration*, then return to this menu to apply the filter sets.

# Chapter 3

## Internet Access

This chapter shows you how to configure the LAN as well as the WAN of your Prestige for Internet access.

### 3.1 TCP/IP and DHCP for LAN

The Prestige has built-in DHCP server capability that assigns IP addresses and DNS servers to systems that support DHCP client capability.

#### 3.1.1 Factory LAN Defaults

The LAN parameters of the Prestige are preset in the factory with the following values:

- .. IP address of 192.168.1.1 with subnet mask of 255.255.255.0 (24 bits)
  - .. DHCP server enabled with 32 client IP addresses starting from 192.168.1.33.
- These parameters should work for the majority of installations. If the parameters are satisfactory, you can skip to section 3.2 **TCP/IP LAN Setup and DHCP** to enter the DNS server address(es) if your ISP gives you explicit DNS server address(es). If you wish to change the factory defaults or to learn more about TCP/IP, please read on.

#### 3.1.2 IP Address and Subnet Mask

Similar to the houses on a street that share a common street name, the machines on a LAN share a common network number, also.

Where you obtain your network number depends on your particular situation. If the ISP or your network administrator assigns you a block of registered IP addresses, follow their instructions in selecting the IP addresses and the subnet mask.

If the ISP did not explicitly give you an IP network number, then most likely you have a single user account and the ISP will assign you a dynamic IP address when the connection is established. If this is the case, it is recommended that you select a network number from 192.168.0.0 to 192.168.255.0 (ignoring the trailing zero) and you must enable the Single User Account feature of the Prestige. The Internet Assigned Number Authority (IANA) reserved this block of addresses specifically for private use; please do *not* use any other number unless you are told otherwise.

When configured as a relay, the Prestige relays the requests and responses between the clients and the real DHCP sever.

### **IP Pool Setup**

The Prestige is pre-configured with a pool of 32 IP addresses starting from 192.168.1.33 to 192.168.1.64. This configuration leaves 31 IP addresses (excluding the Prestige itself) in the lower range for other server machines, e.g., server for mail, FTP, telnet, web, etc., that you may have.

### **DNS Server Address**

DNS (Domain Name System) is for mapping a domain name to its corresponding IP address and vice versa, e.g., the IP address of *www.zyxel.com* is 204.217.0.2. The DNS server is extremely important because without it, you must know the IP address of a machine before you can access it. The DNS server addresses that you enter in the DHCP setup are passed to the client machines along with the assigned IP address and subnet mask.

There are two ways that an ISP disseminates the DNS server addresses. The first is for an ISP to tell a customer the DNS server addresses, usually in the form of an information sheet, when you sign up. If your ISP does give you the DNS server addresses, enter them in the **DNS Server** fields in **DHCP Setup**, otherwise leave this field blank.

### **Relay Server Address**

When the DHCP is set to **Relay**, the Prestige will request IP addresses from a real DHCP server and relay the address to the workstation making the request.



Follow the instructions in the following table on how to configure the DHCP fields.

**Table 3-1 DHCP LAN Setup Menu Fields**

Field	Description	Example
DHCP Setup		
DHCP=	This field enables/disabled the DHCP server/relay. If it is set to <b>Server</b> , your Prestige will act as a DHCP server. If set to <b>None</b> , DHCP service will be disabled and you must have another DHCP sever or relay on your LAN, or else the workstation must be manually configured.  When DHCP is set to <b>Server</b> , the following five items need to be set. If set to <b>Relay</b> , you must specify the Remote DHCP server.	<b>None</b> <b>Server</b> (default) <b>Relay</b>
Client IP Pool Starting Address	This field specifies the first of the contiguous addresses in the IP address pool.	192.168.1.33
Size of Client IP Pool	This field specifies the size, or count, of the IP address pool.	32
Primary DNS Server	Enter the IP addresses of the DNS servers. The DNS servers are passed to the DHCP clients along with the IP address and the subnet mask.	
Secondary DNS Server		
Remote DHCP Server =	Enter the IP address of the true DHCP server when the Prestige is configured as a DHCP <b>Relay</b> .	

### 3.3 Internet Access Setup

Menu 4 allows you to enter the Internet Access information in one screen.

From the Main Menu, enter 4 to go to **Menu 4 - Internet Access Setup**, as displayed below.

```
Menu 4 - Internet Access Setup

ISP's Name=
Service Type= Standard
Server IP= N/A
My Login= N/A
My Password= N/A

IP Address Assignment= Dynamic
IP Address= N/A
IP Subnet Mask= N/A
Gateway=0.0.0.0
RIP Direction= None
Version= RIP-1
Single User Account= Yes

Enter here to CONFIRM or ESC to CANCEL:
```

**Figure 3-3 Menu 4 – Internet Access Setup**

### 3.4 Single User Account

Typically, if there are multiple users on the LAN wanting to concurrently access the Internet, you will have to lease a block of legal, or globally unique, IP addresses from the ISP.

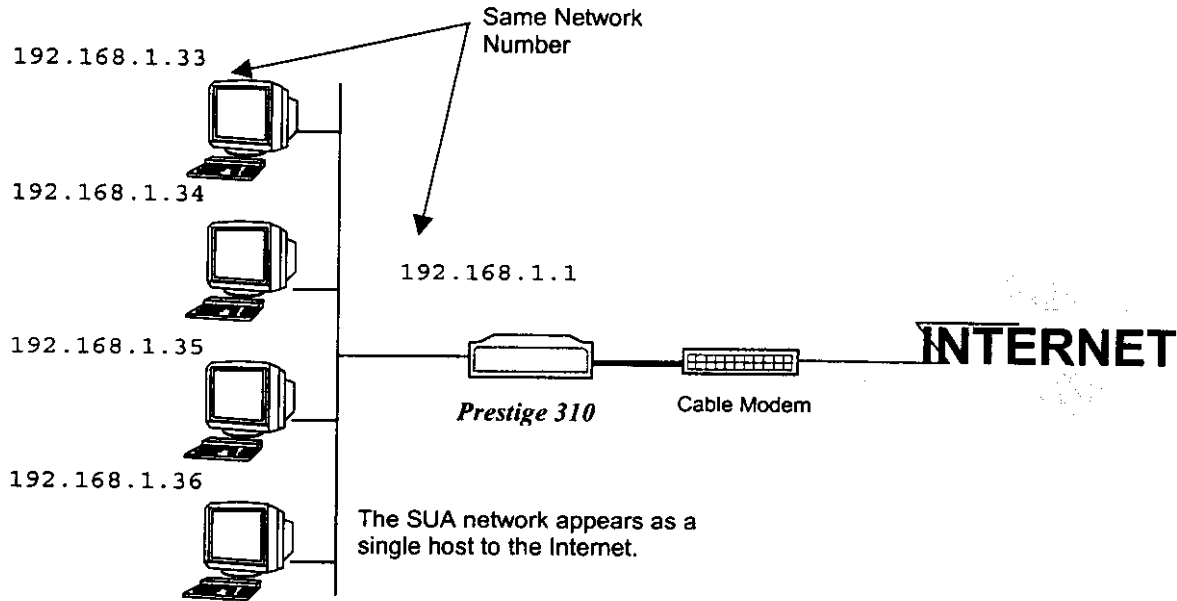

**Figure 3-4 Single User Account Topology**

The IP address for the SUA can be either fixed or dynamically assigned. In addition, you can designate servers, e.g., a web server and a telnet server, on your local network and make them accessible to the outside world.

If you do not define any server, SUA offers the additional benefit of firewall protection. If no server is defined, incoming inquiries will be filtered out by your Prestige thus preventing intruders from probing your network.

Your Prestige accomplishes this address sharing by translating the internal LAN IP addresses to a single address that is globally unique on the Internet. For more information on IP address translation, refer to RFC 1631, *The IP Network Address Translator (NAT)*.

### 3.4.2 Single User Account Configuration

The steps for configuring your Prestige for Single User Account are identical to the conventional Internet access with the exception that you need to fill in one extra fields in **Menu 4 - Internet Access Setup**, as shown below;

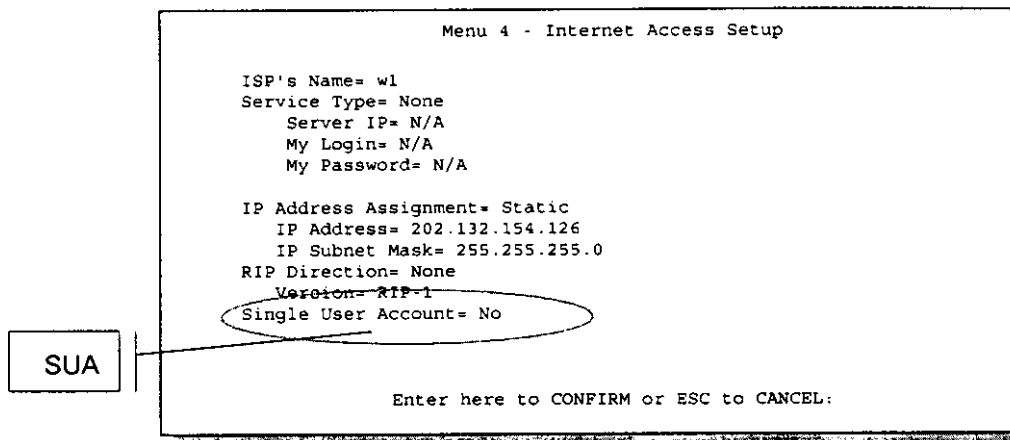

**Figure 3-5 Menu 4 – Internet Access Setup for Single User Account**

To enable the SUA feature in **Menu 4**, move the cursor to the **Single User Account** field and elect **Yes** (or **No** to disable SUA). Then follow the instructions on how to configure the SUA fields.

**Table 3-4 Single User Account Menu Fields**

Field	Description
Single User Account	Select <b>Yes</b> to enable SUA.

Press [Enter] at the message [Press ENTER to Confirm ...] to save your configuration, or press [Esc] at any time to cancel.

## Chapter 4

# IP Static Route Setup

This chapter shows you how to configure Static routes of your Prestige.

Static routes tell the Prestige routing information that it cannot learn automatically through other means. This can arise in cases where RIP is disabled on the LAN.

Each remote node specifies only the network to which the gateway is directly connected, and the Prestige has no knowledge of the networks beyond. For instance, the Prestige knows about network N2 in the following diagram through remote node Router 1. However, the Prestige is unable to route a packet to network N3 because it doesn't know that there is a route through remote node Router 2. The static routes are for you to tell the Prestige about the networks beyond the remote nodes.

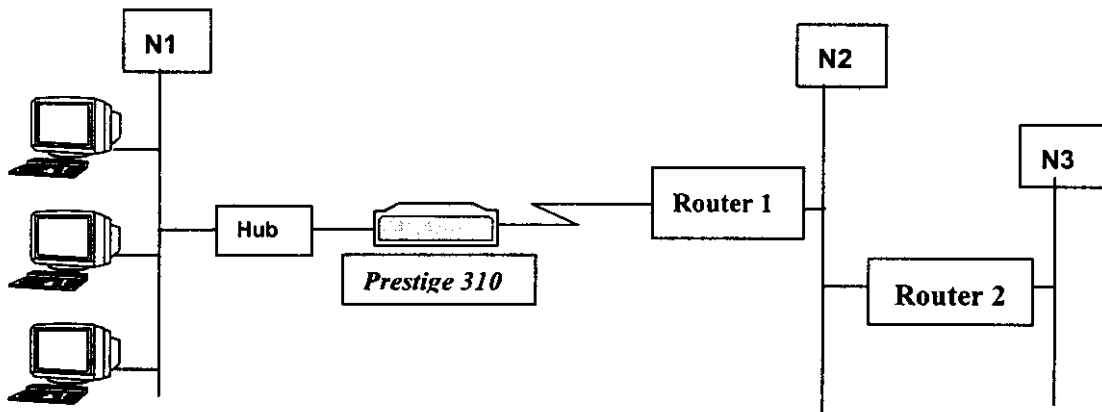

Figure 4-1 Example of Static Routing Topology

The following table describes the IP Static Route Menu.

**Table 4-1 IP Static Route Menu Fields**

Field	Description
Route #	The static route. (1~8)
Route Name	Enter a name for the IP static route for identification purposes.
Active	Activate/deactivate the static route.
Destination IP Address	Enter the Destination IP Address
IP Subnet Mast	Enter the IP subnet mast.
Gateway IP Address	Enter the number of the remote node that is the gateway of this static route. When a packet's destination LAN (MAC) address matches the value entered above.
Metric	Metric represents the "cost" of transmission for routing purposes. IP routing uses hop count as the measurement of cost, with a minimum of 1 for directly connected networks. Enter a number that approximates the cost for this link. The number need not be precise, but it must be between 1 and 15. In practice, 2 or 3 is usually a good number. 1 to 15
Private	This parameter determines if the Prestige will include the route to this remote node in its RIP broadcasts. If set to Yes, this route is kept private and not included in RIP broadcast. If No, the route to this remote node will be propagated to other hosts through RIP broadcasts. Yes/No
Once you have completed filling in this menu, press [Enter] at the message [Press ENTER to Confirm...] to save your configuration, or press [Esc] to cancel.	

# Chapter 5

## Multiple SUA Servers

The Chapter describes how to set-up multiple servers when SUA is enabled.

### 5.1 Multiple Servers behind SUA

If you wish, you can make inside servers for different services, e.g., web or FTP, visible to the outside users, even though SUA makes your whole inside network appear as a single machine to the outside world. A service is identified by the port number, e.g., web service is on port 80 and FTP on port 21.

As an example, if you have a web server at 192.168.1.2 and an FTP server 192.168.1.3, then you need to specify for port 80 (web) the server at IP address 192.168.1.2 and for port 21 (FTP) another at IP address 192.168.1.3.

Please note that a server can support more than one service, e.g., a server can provide both FTP and DNS service, while another provides only web service. Also, since you need to specify the IP address of a server in the Prestige, a server must have a fixed IP address and not be a DHCP client whose IP address potentially changes each time it is powered-on.

In addition to the servers for specific services, SUA supports a default server. A service request that does not have a server explicitly designated for it is forwarded to the default server. If the default server is not defined, the service request is simply discarded.

To make a server visible to the outside world, specify the port number of the service and the inside IP address of the server in **Menu 15 - SUA Server Setup**.

#### 5.1.1 Configuring a Server behind SUA

Follow the steps below to configure a server behind SUA:

1. Enter **15** in the main menu to go to **Menu 15 - Multiple Server Configuration**.
2. Enter the service port number in the **Port #** field and the inside IP address of the server in the **IP Address** field.

# Chapter 6

## Filter Configuration

### 6.1 About Filtering

Your Prestige uses filters to decide whether to allow passage of a data packet.

Data filters screen the data to determine if the packet should be allowed to pass. Data filters are further divided into incoming and outgoing filters, depending on the direction of the packet relative to a port.

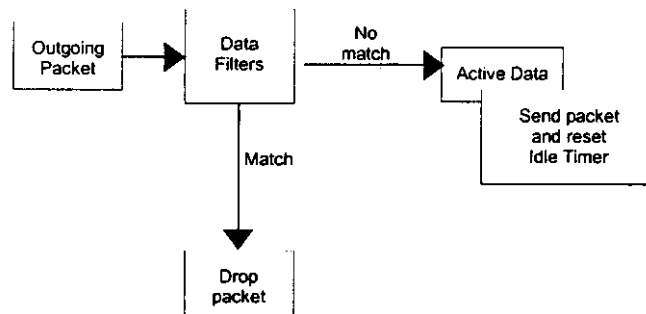

Figure 6-1 Simplified Outgoing Packet Filtering Process

#### The Filter Structure of the Prestige

A filter set consists of one or more filter rules. Usually, you would group related rules, e.g., all the rules for NetBIOS, into a single set and give it a descriptive name. The Prestige allows you to configure up to twelve filter sets with six rules in each set, for a total of 72 filter rules in the system.

You can apply up to four filter sets to a particular port to block multiple types of packets. With each filter set having up to six rules, you can have a maximum of 24 rules active for a single port.



```

Menu 21.1 - Filter Rules Summary

# A Type                Filter Rules                M m n
-----
1 Y IP Pr=6, SA=0.0.0.0, DA=0.0.0.0, DP=137      N D N
2 Y IP Pr=6, SA=0.0.0.0, DA=0.0.0.0, DP=138      N D N
3 Y IP Pr=6, SA=0.0.0.0, DA=0.0.0.0, DP=139      N D N
4 Y IP Pr=17, SA=0.0.0.0, DA=0.0.0.0, DP=137     N D N
5 Y IP Pr=17, SA=0.0.0.0, DA=0.0.0.0, DP=138     N D N
6 Y IP Pr=17, SA=0.0.0.0, DA=0.0.0.0, DP=139     N D F

Enter Filter Rule Number (1-6) to Configure: 1

Edit Comments= NetBIOS_WAN
    
```

**Figure 6-3 Menu 21.1 - Filter Rules Summary**

```

Menu 21.2 - Filter Rules Summary

# A Type                Filter Rules                M m
-----
1 Y IP Pr=17, SA=0.0.0.0, SP=137, DA=0.0.0.0, DP=53  N D
2 Y
3 Y
4 Y
5 Y
6 Y

Enter Filter Rule Number (1-6) to Configure: 1
    
```

**Figure 6-4 Menu 21.2 - Filter Rules Summary**

The protocol dependent filter rules abbreviation are listed as follows:

- If the filter type is IP, the following abbreviations listed in the following table will be used.

**Table 6-2 Abbreviations Used If Filter Type Is IP**

Abbreviation	Description
Pr	Protocol
SA	Source Address
SP	Source Port number
DA	Destination Address
DP	Destination Port number

- If the filter type is GEN (generic), the following abbreviations listed in the following table will be used.

**Table 6-3 Abbreviations Used If Filter Type Is GEN**

Abbreviation	Description
Off	Offset
Len	Length

Refer to the next section for information on configuring the filter rules.

## 3.2.2 Configuring a Filter Rule

To configure a filter rule, enter its number in Menu 21.1 - Filter Rules Summary and press Enter to open Menu 21.1.1 for the rule.

There are two types of filter rules: TCP/IP and Generic. Depending on the type of rule, the parameters below the type will be different. Use the space bar to select the type of rule that you wish to create in the Filter Type field and press Enter to open the respective menu.

The network layer filters are collectively called protocol filters. When NAT/SUA (Network Address Translation/Single User Account) is enabled, the inside IP address and port number are replaced on a connection-by-connection basis, which makes it impossible to know the exact address and port on the wire. Therefore, the Prestige applies the protocol filters to the "native" IP address and port number before NAT/SUA for outgoing packets and after NAT/SUA for

incoming packets. On the other hand, the generic, or device, filters are applied to the raw packets that appear on the wire.

To speed up filtering, all rules in a filter set must be of the same class, i.e., protocol filters or generic filters. The class of a filter set is determined by the first rule that you create. When applying the filter sets to a port, separate menu fields are provided for protocol and device filter sets. If you include a protocol filter set in a device filters field or vice versa, the Prestige will warn you and will not allow you to save.

### 6.2.3 TCP/IP Filter Rule

This section shows you how to configure a TCP/IP filter rule. TCP/IP rules allow you to base the rule on the fields in the IP and the upper layer protocol, e.g., UDP and TCP, headers.

To configure a TCP/IP rules, select TCP/IP Filter Rule from the Filter Type field and press Enter to open Menu 21.1.1 - TCP/IP Filter Rule, as shown below.

```
Menu 21.1.1 - TCP/IP Filter Rule
Filter #: 1,1
Filter Type= TCP/IP Filter Rule
Active= Yes
IP Protocol= 6      IP Source Route= No
Destination: IP Addr= 0.0.0.0
              IP Mask= 0.0.0.0
              Port #= 137
              Port # Comp= Equal
Source: IP Addr= 0.0.0.0
        IP Mask= 0.0.0.0
        Port #= 0
        Port # Comp= None
TCP Estab= No
More= No      Log= None
Action Matched= Check Next Rule
Action Not Matched= Check Next Rule

Press ENTER to Confirm or ESC to Cancel:
Press Space Bar to Toggle.
```

**Figure 6-5 Menu 21.1.1 - TCP/IP Filter Rule**

## 6.2.1 Filter Rules Summary Menu

This screen shows the summary of the existing rules in the filter set. The following tables contain a brief description of the abbreviations used in Menu 21.1.

**Table 6-1 Abbreviations Used in the Filter Rules Summary Menu**

Abbreviations	Description	Display
#	Refers to the filter rule number (1-6).	
A	Refers to Active.	[Y] means the filter rule is active. [N] means the filter rule is inactive.
Type	Refers to the type of filter rule. This shows GEN for generic, IP for TCP/IP	[GEN] for Generic [IP] for TCP/IP
Filter Rules	The filter rule parameters will be displayed here (see below).	
M	Refers to More.	[Y] means there are more rules to check. [N] means there are no more rules to check.
m	Refers to Action Matched.	[F] means to forward the packet. [D] means to drop the packet. [N] means check the next rule.
n	Refers to Action Not Matched	[F] means to forward the packet. [D] means to drop the packet. [N] means check the next rule.

## 6.2 Configuring a Filter Set

To configure a filter sets, follow the procedure below:

**Step 1.** Select option **21. Filter Set Configuration** from the Main Menu to open Menu 21.

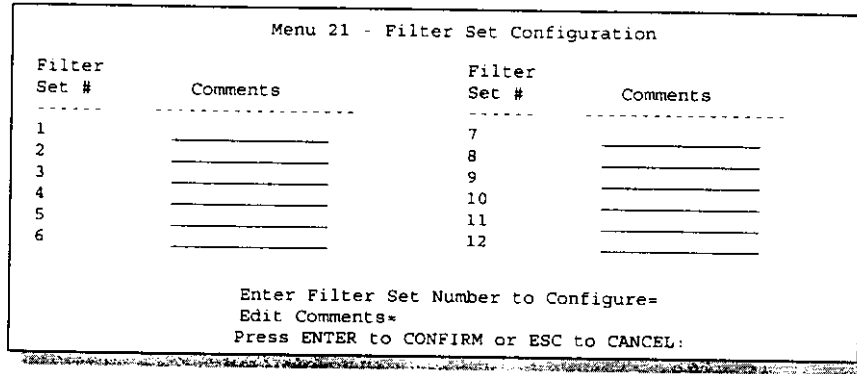

Menu 21 - Filter Set Configuration

Filter Set #	Comments	Filter Set #	Comments
1	_____	7	_____
2	_____	8	_____
3	_____	9	_____
4	_____	10	_____
5	_____	11	_____
6	_____	12	_____

Enter Filter Set Number to Configure=  
Edit Comments\*  
Press ENTER to CONFIRM or ESC to CANCEL:

**Figure 6-2 Menu 21 - Filter Set Configuration**

- Step 2.** Select the filter set you wish to configure (no. 1-12) and press [Enter].
- Step 3.** Enter a descriptive name or comment in the Edit Comments field and press Enter.
- Step 4.** Press [Enter] at the message: [Press ENTER to confirm] to open Menu 21.1 - Filter Rules Summary.

3. Press **[ENTER]** at the "Press ENTER to confirm ..." prompt to save your configuration after you define all the servers or press **ESC** at any time to cancel.

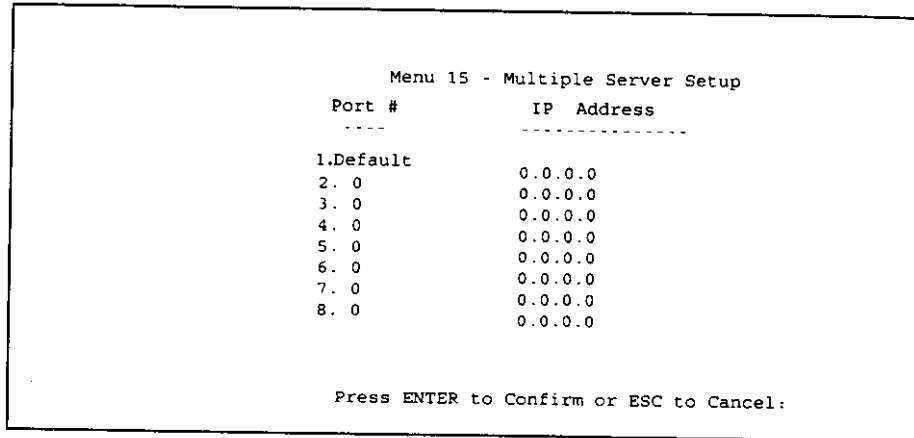

**Figure 5-1 Multiple Server Configuration**

The most often used port numbers are:

**Table 5-1 Services vs. Port number**

Services	Port Number
FTP (File Transfer Protocol)	21
Telnet	23
POP3 (Post Office Protocol, version 3)	110
SMTP (Simple Mail Transfer Protocol)	25
DNS (Domain Name System)	53
HTTP (Hyper Text Transfer protocol or WWW, Web)	80
PPTP (Point-to-Point Tunneling Protocol)	1723



## 4.1 IP Static Route Setup

Similar to network layer static routes, an IP static route tells the Prestige about the route to a node before a connection is established. You configure IP static routes in **Menu 12. 1**, by pressing selecting one of the IP static routes as shown below.

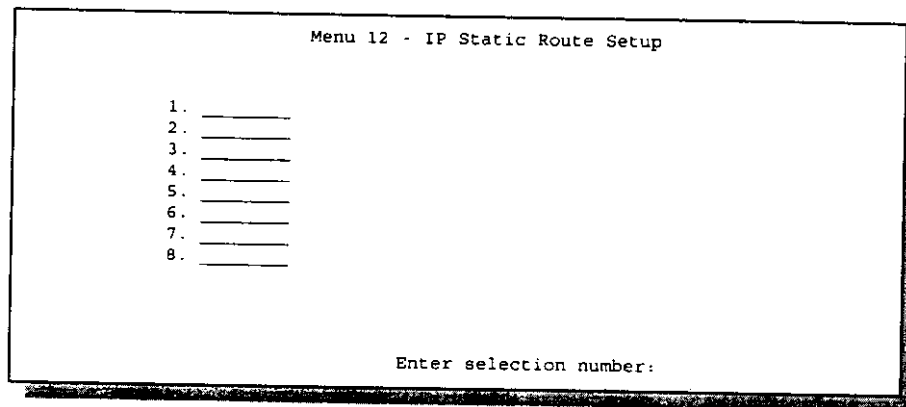

```
Menu 12 - IP Static Route Setup

1. _____
2. _____
3. _____
4. _____
5. _____
6. _____
7. _____
8. _____

Enter selection number:
```

**Figure 4-2 Menu 12.1 - Edit IP Static Route**

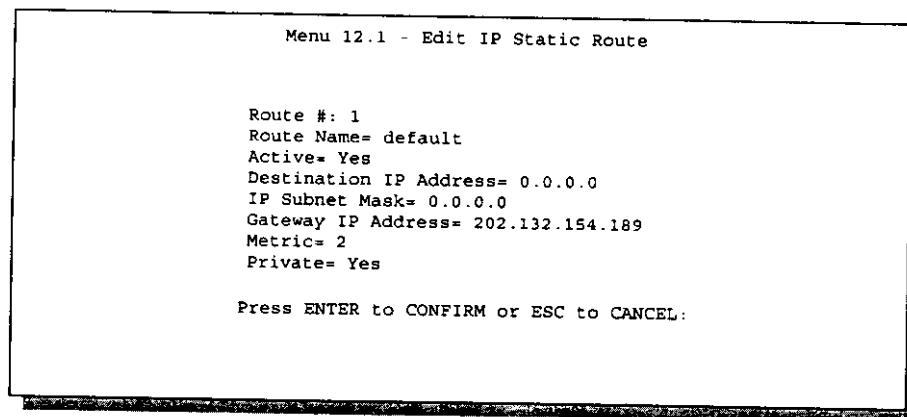

```
Menu 12.1 - Edit IP Static Route

Route #: 1
Route Name= default
Active= Yes
Destination IP Address= 0.0.0.0
IP Subnet Mask= 0.0.0.0
Gateway IP Address= 202.132.154.189
Metric= 2
Private= Yes

Press ENTER to CONFIRM or ESC to CANCEL:
```

**Figure 4-3 Menu 12. Edit IP Static Route**



---

### **3.4.1 Advantages of SUA**

In summary:

- SUA is a cost-effective solution for small offices with less than 64 hosts to access the Internet.
- SUA supports servers to be accessible to the outside world.
- SUA can provide firewall protection if you do not specify a server. All incoming inquiries will be filtered out by your Prestige.
- UDP and TCP packets can be routed. In addition, partial ICMP, including echo and trace route, is supported.

The following table contains instructions on how to configure your Prestige for Internet access. Time Warner

**Table 3-3 Internet Access Setup Menu Fields**

<b>Field</b>	<b>Description</b>
<b>ISP's Name</b>	Enter the name of your Internet Service Provider, e.g., myISP. This information is for identification purposes only.
<b>Service Type</b>	Toggle between Standard and RoadRunner, the Time Warner's RoadRunner Service.
<b>Server IP</b>	Enter the IP Address of the remote gateway at the ISP's site. If you don't have this data, just leave it blank.
<b>My Login Name</b>	Enter the login name given to you by your ISP.
<b>My Password</b>	Enter the password associated with the login name above.
<b>IP Address Assignment</b>	If your ISP did not assign you an explicit ip address, select <b>Dynamic</b> , otherwise select <b>Static</b> and enter the IP address & subnet mask in the following fields.
<b>IP Address</b>	Enter the IP address assigned to you when Static Assignment is selected.
<b>IP Subnet Mask</b>	Enter the subnet mask you assign when Static Assignment is selected.
<b>Gateway</b>	Enter the default gateway
<b>RIP Direction</b>	Select the RIP Direction.
<b>Version</b>	Select the RIP Version.
<b>Single User Account</b>	Please see the following section for a more detailed discussion on the Single User Account feature. The default is <b>Yes</b> .

Follow the instructions in the following table to configure TCP/IP parameters for the LAN port.

**Table 3-2 TCP/IP LAN Setup Menu Fields**

Field	Description	Example
TCP/IP Setup		
IP Address	Enter the IP address of your Prestige in dotted decimal notation	192.168.1.1 (default)
IP Subnet Mask	Your Prestige will automatically calculate the subnet mask based on the IP address that you assign. Unless you are implementing subnetting, use the subnet mask computed by the Prestige	255.255.255.0
RIP Direction	Press the space bar to select the RIP direction from <b>Both/In Only/Out Only/None</b> .	<b>None</b> (default)
Version	Press the space bar to select the RIP version from <b>RIP-1/RIP-2B/RIP-2M</b> .	<b>RIP-1</b> (default)

When you have completed this menu, press [Enter] at the prompt [Press ENTER to Confirm...] to save your configuration, or press [Esc] at any time to cancel.

## 3.2 TCP/IP LAN Setup and DHCP

From the Main Menu, enter 3 to open **Menu 3 - LAN (10/00Mbps Ethernet) Setup** to configure TCP/IP LAN and DHCP.

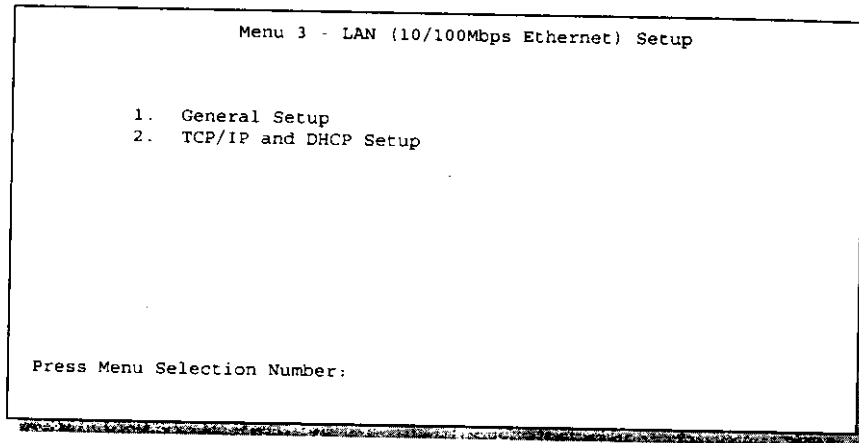

**Figure 3-1 Menu 3 - LAN (10/100Mbps Ethernet) Setup**

To edit the TCP/IP and DHCP configuration, enter 2 to open **Menu 3.2 - TCP/IP and DHCP LAN Setup**, as shown below.

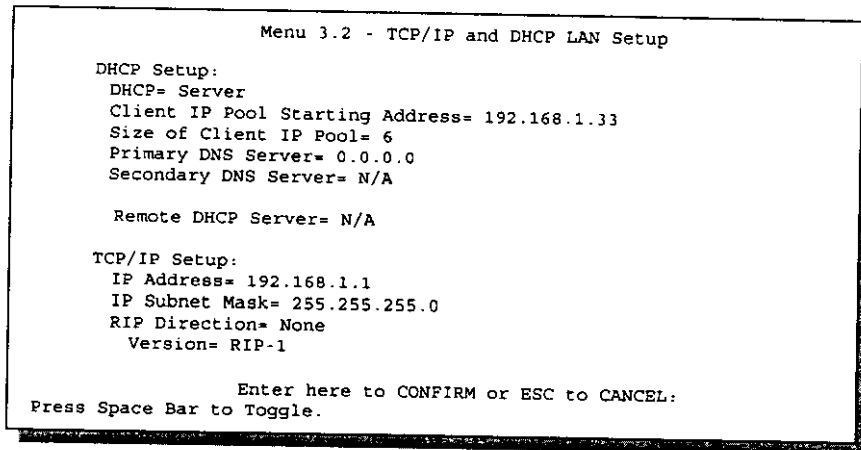

**Figure 3-2 Menu 3.2 – TCP/IP and DHCP LAN Setup**

Let's say you select 192.168.1.0 as the network number; which covers 254 individual addresses, from 192.168.1.1 to 192.168.1.254 (zero and 255 are reserved). In other words, the first 3 numbers specify the network number while the last number identifies an individual workstation on that network.

Once you have decided on the network number, pick an IP address that is easy to remember, e.g., 192.168.1.1, for your Prestige.

The subnet mask specifies the network number portion of an IP address. Your Prestige will compute the subnet mask automatically based on the IP address that you entered. You don't need to change the subnet mask computed by the Prestige unless you are instructed to do otherwise.

### **3.1.3 RIP Setup**

RIP (Routing Information Protocol) allows a router to exchange routing information with other routers. The **RIP Direction** field controls the sending and receiving of RIP packets. When set to **Both** or **Out Only**, the Prestige will broadcast its routing table periodically. When set to **Both In Only**, it will incorporate the RIP information that it receives; when set to **None**, it will not send any RIP packets and will ignore any RIP packets received. The default is **None**, i.e., RIP is disabled.

The **Version** field controls the format and the broadcasting method of the RIP packets that the Prestige sends (it recognizes both formats when receiving). **RIP-1** is universally supported; but **RIP-2** carries more information. **RIP-1** is probably adequate for most networks, unless you have an unusual network topology.

Both **RIP-2B** and **RIP-2M** sends the routing data in **RIP-2** format; the difference being that **RIP-2B** uses subnet broadcasting while **RIP-2M** uses multicasting. Multicasting can reduce the load on non-router machines since they generally do not listen to the **RIP** multicast address and so do not receive the **RIP** packets. However, if one router uses multicasting, then all routers on your network must use multicasting, also.

By default, **RIP direction** is set to **None** and the **Version** set to **RIP-1**.

### **3.1.4 DHCP Configuration**

DHCP (Dynamic Host Configuration Protocol) allows the individual clients (workstations) to obtain the TCP/IP configuration at start-up from a server. Unless you are instructed by your ISP, leave the DHCP at the **Server**, the default. You can configure the Prestige as a DHCP server or relay. When configured as a server, the Prestige provides the TCP/IP configuration for the client.

## **2.11 Protocol Dependent LAN Setup**

For TCP/IP LAN Setup, refer to **Chapter 3 - Internet Access**.

## 2.9 WAN Setup

This section describes how to configure the WAN using **Menu 2 – WAN (10Mbps Ethernet) Setup**. From the Main Menu, enter 2 to open menu 2.

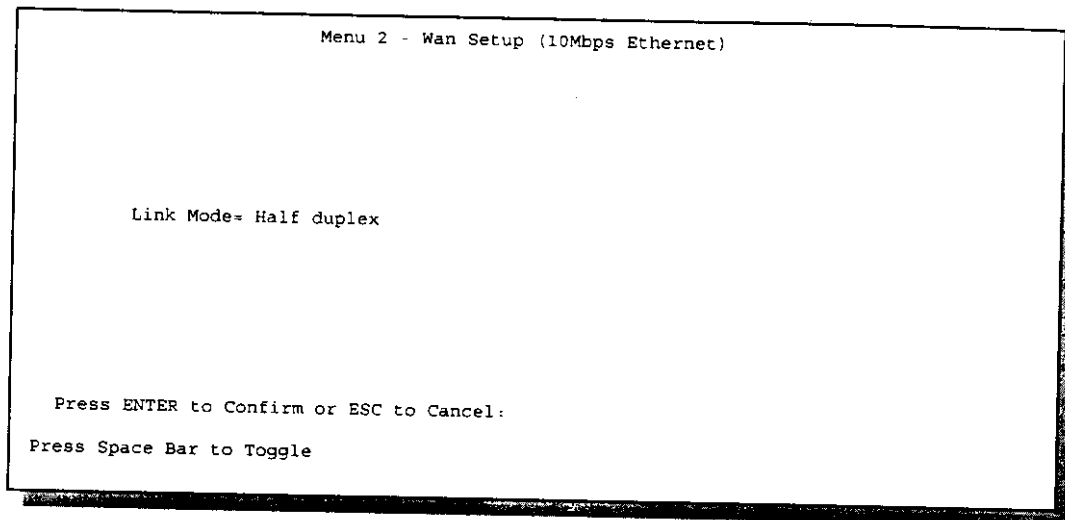

**Figure2-8 Menu 2 – WAN Setup**

Use the space bar to toggle between half and full duplex. Half-duplex means the link is used to transmit or to receive exclusively at any given time, while full duplex means it can transmit and receive at the same time. Half duplex will always work. While full duplex is obviously faster, it requires the modem to support it in order to work. You can try full duplex first; if it works, leave it at full duplex; otherwise, change it back to half duplex.



The following table describes how to configure your TCP/IP filter rule.

**Table 6-4 TCP/IP Filter Rule Menu Fields**

<b>Field</b>	<b>Description</b>	<b>Option</b>
Active	This field activates/deactivates the filter rule.	<b>Yes/No</b>
IP Protocol	Protocol refers to the upper layer protocol, e.g., TCP is 6, UDP is 17 and ICMP is 1. This value must be between 0 and 255. 0 means IP protocol is a don't-care.	0-255
IP Source Route	If Yes, the rule applies to packet with IP source route option; else the packet must not have source route option. The majority of IP packets do not have source route.	<b>Yes/No</b>
Destination: IP Addr	Enter the destination IP Address of the packet you wish to filter. This field is a don't-care if it is 0.0.0.0.	IP address
Destination: IP Mask	Enter the IP subnet mask to apply to the Destination: IP Addr. If you wish to filter a single host, enter 255.255.255.255.	Subnet mask
Destination: Port #	Enter the destination port of the packets that you wish to filter. The range of this field is 0 to 65535. This field is a don't-care if it is 0.	0-65535
Destination: Port # Comp	Select the comparison to apply to the destination port in the packet against the value given in Destination: Port #.	<b>None/Less/Greater/Equal/Not Equal]</b>
Source: IP Addr	Enter the source IP Address of the packet you wish to filter. This field is a don't-care if it is 0.0.0.0.	IP Address
Source: IP Mask	Enter the IP subnet mask to apply to the Source: IP Addr. If you wish to filter a single host, enter 255.255.255.255.	IP Mask
Source: Port #	Enter the source port of the packets that you wish to filter. The range of this field is 0 to 65535. This field is a don't-care if it is 0.	0-65535
Source: Port # Comp	Select the comparison to apply to the source port in the packet against the value given in Source: Port #.	<b>None/Less/Greater/Equal/Not Equal]</b>
TCP Estab	This field is applicable only when IP Protocol field is 6, TCP. If yes, the rule matches only established TCP connections; else the rule matches all TCP packets.	<b>Yes/No</b>

## 6.2.4 Generic Filter Rule

This section shows you how to configure a generic filter rule. The purpose of generic rules is to allow you to filter non-IP packets. For IP, it is generally easier to use the IP rules directly.

For generic rules, the Prestige treats a packet as a byte stream as opposed to an IP or IPX packet. You specify the portion of the packet to check with the Offset (from 0) and the Length fields, both in bytes. The Prestige applies the Mask (bit-wise ANDing) to the data portion before comparing the result against the Value to determine a match. The Mask and Value are specified in hexadecimal numbers. Note that it takes two hexadecimal digits to represent a byte, so if the length is 4, the value in either field will take 8 digits, e.g., FFFFFFFF.

To configure a generic rule, select Generic Filter Rule in the Filter Type field and press Enter to open Menu 21.1.2 - Generic Filter Rule, as shown below.

```
Menu 21.1.2 - Generic Filter Rule

Filter #: 1,1
Filter Type= Generic Filter Rule
Active= No
Offset= 0
Length= 0
Mask= N/A
Value= N/A
More= No           Log= None
Action Matched= Check Next Rule
Action Not Matched= Check Next Rule

Press ENTER to Confirm or ESC to Cancel:
```

Figure 6-6 Menu 21.1.2 - Generic Filter Rule

Action Not Matched	Select the action for a packet not matching the rule.	<b>Check Next Rule</b> <b>Forward</b> <b>Drop</b>
Once you have completed filling in Menu 21.1.2 - generic Filter Rule, press [Enter] at the message [Press Enter to Confirm] to save your configuration, or press [Esc] to cancel. This data will now be displayed on Menu 21.1 - Filter Rules Summary.		

## 6.3 Applying a Filter

This section shows you where to apply the filter(s) after you design it (them).

### 6.3.1 Ethernet traffic

Go to Menu 3.1 (shown below) and enter the number(s) of the filter set(s) that you want to apply as appropriate. You can specify up to four filter sets (from twelve) by entering their numbers separated by commas, e.g., 3, 4, 6, 11.

```

Menu 3.1 - General Ethernet Setup

Ethernet Interface= 10BaseT
Input Filter Sets:
  protocol filters=
  device filters=
Output Filter Sets:
  protocol filters=
  device filters=

Press ENTER to Confirm or ESC to Cancel:

```

Figure 6-7 Filtering Ethernet traffic

## Chapter 7

# System Maintenance

This chapter covers the diagnostic tools that help you to maintain your Prestige. These tools include updates on system status, port status, log and trace capabilities and upgrades for the system software. This chapter describes how to use these tools in detail.

Select menu 24 in the main menu to open **Menu 24 - System Maintenance**, as shown below.

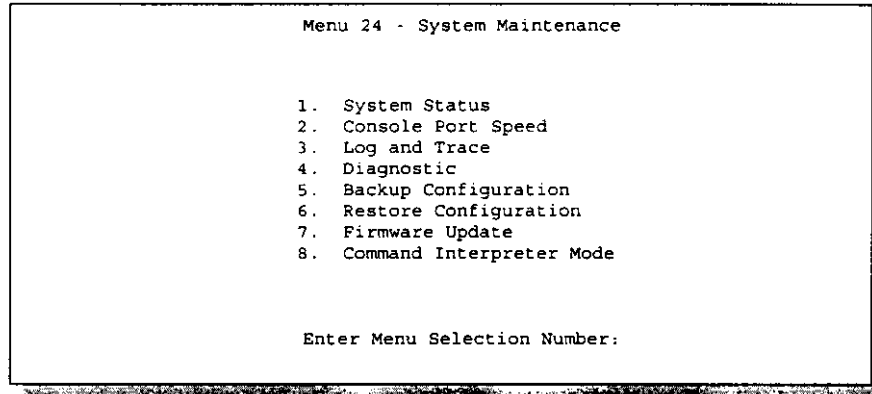

**Figure 7-1 Menu 24 - System Maintenance**

The following table describes the fields present in **Menu 24.1 - System Maintenance - Status**.

**Table 7-1 System Maintenance - Status Menu Fields**

Field	Description
Port	The WAN or LAN port.
Status	Shows the port's speed and duplex setting.
TXPkts	The number of transmitted packets on this port.
RXPkts	The number of received packets on this port.
Cols	The number of collisions on this port.
Tx B/s	Shows the transmit Bytes per second on this port.
Rx B/s	Shows the receive Bytes per second on this port.
Up Time	Time the line has been up.
LAN	
Ethernet Address	The LAN side Ethernet address.
IP Address	The LAN side IP address.
IP Mask	The LAN side IP mask.
DHCP	The LAN side DHCP role.
WAN	
Ethernet Address	The WAN side Ethernet address.
IP Address	The WAN side IP address.
IP Mask	The WAN side IP mask.
DHCP	The WAN side DHCP role.
System up Time	The total time the Prestige has been powered on.
CPU Load	Shows the load on the CPU in percent.
Name	The name that identifies the Prestige.
RAS F/W Version	The RAS Firmware version.

After the Prestige finishes displaying, you will have the option to clear the error log. Examples of typical error and information messages are presented in the figure below.

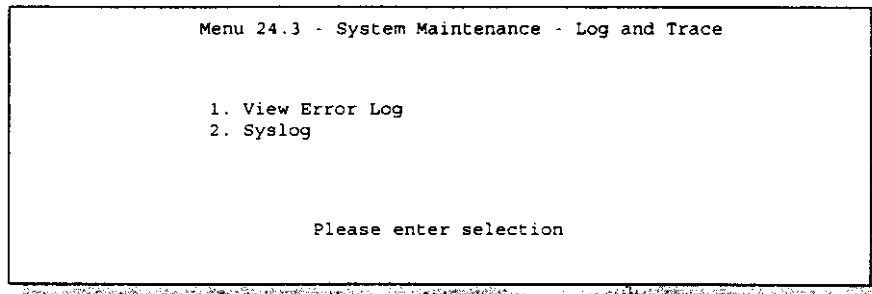

**Figure 7-4 Examples of Error and Information Messages**

Your Prestige sends two types of syslog messages: error information messages and session information messages. Some examples of these syslog messages are shown below:

## 7.4 Diagnostic

The diagnostic facility allows you to test the different aspects of your Prestige to determine if it is working properly. Menu 24.4 allows you to choose among various types of diagnostic tests to evaluate your system, as shown below.

```
Menu 24.4 - System Maintenance - Diagnostic

TCP/IP
  1. Ping Host

System
  11. Reboot System
  12. Command Mode

Enter Menu Selection Number:

Host IP Address= N/A
```

**Figure 7-6 Menu 24.4 - System Maintenance - Diagnostic**

Follow the procedure below to get to Diagnostic

- Step 1.** From the Main Menu, select option 24 to open **Menu 24 - System Maintenance**.
- Step 2.** From this menu, select option 4. Diagnostic. This will open **Menu 24.4 - System Maintenance - Diagnostic**.

## 7.6 Restore Configuration

**Menu 24.5 -- System Maintenance - Restore Configuration** allows you to restore the configuration via the console port. Note that this function erases the current configuration before restoring to the previous back up configuration; please do not attempt to restore unless you have the a backup configuration stored on disk.

```
Menu 24.5 -- System Maintenance - Restore Configuration

Ready to restore Configuration via Xmodem.
Do you want to continue (y/n):
```

Figure 7-8 Menu 24.5 - System Maintenance - Backup Configuration

## 7.7 Firmware Update

**Menu 24.7 -- System Maintenance - Upload Firmware** allows you to upgrade the firmware and the configuration file via the console port. Note that this function erases the old data before installing the new one; please do not attempt to update unless you have the new firmware at hand. There are two components in the system: the router firmware and the configuration file, as shown below.

```
Menu 24.7 -- System Maintenance - Upload Firmware

1. Load RAS Code
2. Load ROM File

Enter Menu Selection Number:
```

Figure 7-9 Menu 24.7 - System Maintenance - Upload Firmware



If you replace the current configuration file with the default configuration file, i.e., p310.rom, you will lose all configurations that you had before and the speed of the console port will be reset to the default of 9600 bps with 8 data bit, no parity and 1 stop bit (8n1). You will need to change your serial communications software to the default before you can connect to the Prestige again. The password will be reset to the default of 1234, also.

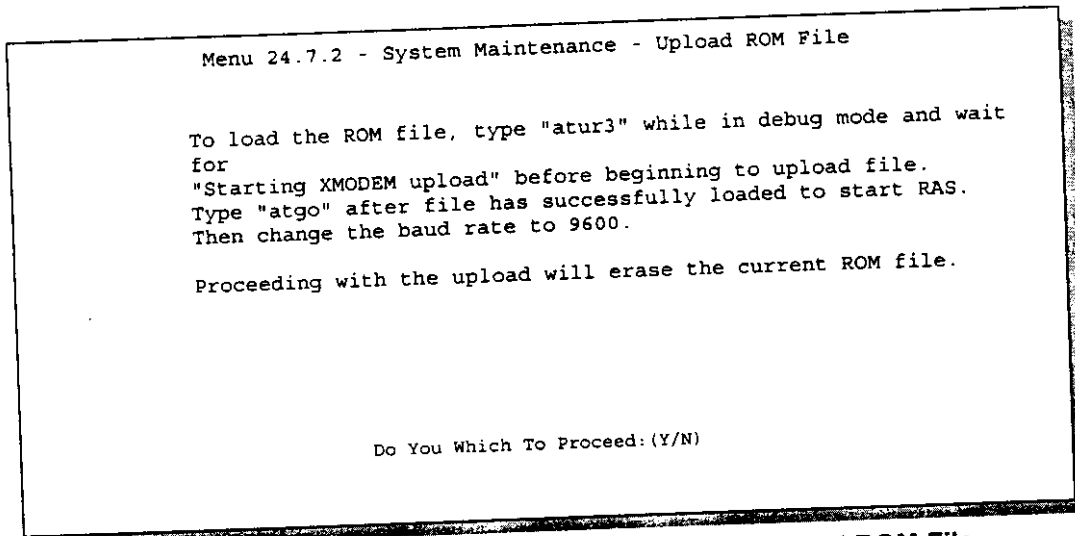

Figure 7-11 Menu 24.7.2 - System Maintenance - Upload ROM File

### 7.7.3 TFTP Transfer

In addition to the direct console port connection, the Prestige supports the up/downloading of the firmware and the configuration file using TFTP (Trivial File Transfer Protocol) over LAN. Although TFTP should work over WAN as well, it is not recommended because of the potential data corruption problems.

To use TFTP, your workstation must have both telnet and TFTP clients. To transfer the firmware and the configuration file, follow the procedure below:

- Step 1.** Use telnet from your workstation to connect to the Prestige and log in. Because TFTP does not have any security check, the Prestige records the IP address of the telnet client and accepts TFTP requests only from this address.
- Step 2.** Put the SMT in command interpreter (CI) mode by entering 8 in **Menu 24 – System Maintenance**.

## 7.8 Command Interpreter Mode

This option allows you to enter the command interpreter mode. A list of valid commands can be found by typing [help] at the command prompt. For more detailed information, check the ZyXEL Web site or send e-mail to the ZyXEL Support Group.

```
Menu 24 - System Maintenance

1. System Status
2. Console Port Speed
3. Log and Trace
4. Diagnostic
5. Backup Configuration
6. Restore Configuration
7. Software Update
8. Command Interpreter Mode

Enter Menu Selection Number: 8

Copyright (c) 1994 - 1999 ZyXEL Communications Corp.
ras>
```

Figure 7-12 Command mode

# Chapter 8

## Telnet Configuration and Capabilities

This chapter covers the Telnet Configuration and Capabilities of the Prestige.

### 8.1 About Telnet Configuration

Before the Prestige is properly setup for TCP/IP, the only option for configuring it is through the console port. Once your Prestige is configured, you can use telnet to configure it remotely as shown below.

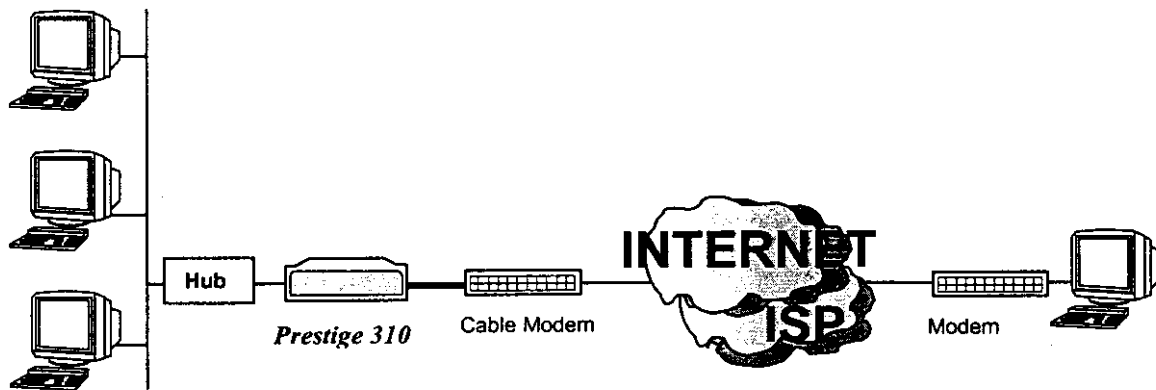

Figure 8-1 Telnet Configuration on a TCP/IP Network

When IP routing is disabled, the Prestige can still function as a host.

# Chapter 9

## Troubleshooting

This chapter covers the potential problems you may run into and the possible remedies. After each problem description, some instructions are provided to help you to diagnose and to solve the problem.

### 9.1 Problems Starting Up the Prestige

Table 9-1 Troubleshooting the Start-Up of your Prestige

Problem	Corrective Action	
None of the LEDs are on when you power on the Prestige	Check the connection between the AC adapter and the Prestige. If the error persists, you may have a hardware problem. In this case, you should contact technical support.	
Cannot access the Prestige via the console port.	1. Check to see if the Prestige is connected to your computer's serial port.	
	2. Check to see if the communications program is configured correctly. The communications software should be configured as follows:	VT100 terminal emulation
		9600 bps
	No parity, 8 Data bits, 1 Stop bit.	

# Appendix A

## Acronyms and Abbreviations

DCE	Data Communications Equipment
DHCP	Dynamic Host Configuration Protocol
DNS	Domain Name System
DTE	Data Terminal Equipment
IANA	Internet Assigned Number Authority
IP	Internet protocol
IPCP	IP Control Protocol
ISP	Internet Service Provider
LAN	Local Area Network
MAC	Media Access Control
NAT	Network Address Translation
RIP	Routing Information Protocol
SAP	(IPX) Service Advertising Protocol
SNAP	Sub-Network Access Protocol
SNMP	Simple Network Management Protocol
SUA	Single User Account
TA	(ISDN) Terminal Adapter
TFTP	Trivial File Transfer Protocol
TCP	Transmission Control Protocol
UDP	User Datagram Protocol
UTP	Unshielded Twisted Pair (cable)
WAN	Wide Area Network

# Index

- console port, 2-4
- DHCP, 3-2
- diagnostic, 7-7
- DNS, 3-3, 3-5
- filter, 2-12, 6-1
- General Setup, 2-10
- generic filter rule, 6-8
- IANA, 3-1
- Internet access, 1-3, 3-1
- IP address, 3-2, 3-6
- IP network number, 3-1
- IP Pool, 3-3
- IP static route, 4-1
- LAN, 7-3, 7-4
- log, 7-4
- Main Menu, 2-8
- password, 2-6, 2-9
- power adapter, 2-4
- Remote Node, 7-3, 7-8
- RIP, 3-2, 3-6
- ROM File, 7-10
- Single User Account, 3-8. *See* SUA
- SMT, 2-7
- software update, 7-10
- SUA, 1-3, 3-8
- Subnet mask, 3-2, 3-6
- syslog, 7-6
- system name, 2-10
- system status, 7-2
- TCP/IP filter rule, 6-6
- telnet, 8-15
- trace, 7-4
- troubleshooting, 9-1
- VT100, 2-4

---





## 9.2 Problems with the LAN Interface

Table 9-2 Troubleshooting the LAN Interface

Problem	Corrective Action
Can't ping any workstation on the LAN	Check the 10M/100M LEDs on the front panel. One of these LED's should be on. If they are both off, check the cables between your Prestige and hub or the station.
	Verify that the IP address and the subnet mask are consistent between the Prestige and the workstations.

## 9.3 Problems with the WAN interface

Table 9-3 Troubleshooting the WAN interface

Problem	Corrective Action
Can't connect to a remote node or ISP	Check Menu 24.1 to verify the line status. If it indicates [down], then refer to the section on the line problems.

## **8.2 Telnet Under SUA**

When Single User Account (SUA) is enabled and an inside server is specified, telnet connections from the outside will be forwarded to the inside server. So to configure the Prestige via telnet from the outside, you must first telnet to the inside server, and then telnet from the server to the Prestige using its inside LAN IP address. If no insider server is specified, telnet to the SUA's IP address will connect to the Prestige directly.

## **8.3 Telnet Capabilities**

### **8.3.1 Single Administrator**

To prevent confusion and discrepancy on the configuration, your Prestige only allows one administrator to log in at any time. Your Prestige also gives priority to the console port over telnet. If you have already connected to your Prestige via telnet, you will be logged out if another user logs in to the Prestige via the console port.

### **8.3.2 System Timeout**

There is a system timeout of 5 minutes (300 seconds) for either the console port or telnet. Your Prestige will automatically log you out if you do nothing in this timeout period, except when it is continuously updating the status in Menu 24.1.

### 7.8.1 Boot commands

Prestige boot module commands are shown below. For ATBAx, x denotes the number preceding the colon to give the baud rate following the colon in the list of numbers that follows; e.g., ATBA3 will give a baud of 9.6 kbps. ATSE displays the seed that is used to generate a password to turn on the debug flag in the firmware. The ATSH command shows product related information such as boot module version, vendor name, product model, RAS code revision, etc.

===== Debug Command Listing =====	
ATHE	print help
ATGO	boot system
ATUR	upload RAS code
ATUR3	upload RAS configuration file
ATBAx	change baud rate. 1:38.4,2:19.2,3:9.6,4:57.6,5:115.2
ATTD	download configuration to PC
ATSE	display seed for password generation
ATSH	display Revision and etc

**Figure 7-13 Boot module commands**

- Step 3.** Enter command “`sys studio 0`” to disable SMT timeout, so the TFTP transfer will not be interrupted.
- Step 4.** Launch TFTP client on your workstation and connect to the Prestige. Set the transfer mode to binary before starting data transfer.
- Step 5.** Use the TFTP client to transfer files between the Prestige and the workstation. The file name for the firmware is “`ras`” and for the configuration file, “`rom-0`” (rom-zero, not capital o).

If you upload the firmware to the Prestige, it will reboot automatically when the file transfer is completed.

Note that the telnet connection must be active and the SMT in CI mode before and during the TFTP transfer. For details on TFTP commands, please consult the documentation of your TFTP client program. For UNIX, use “`get`” to transfer from the Prestige to the workstation, “`put`” the other way around, and “`binary`” to set binary transfer mode.

### **7.7.1 Uploading the RAS Code**

Menu 24.7.2 shows you the instructions for uploading the RAS Code. If you answer yes to the prompt, the Prestige will go into debug mode. Follow the procedure below to upload the configuration file:

- Step 1.** Enter "atur" after the "Enter Debug Mode" message.
- Step 2.** Wait for the "Starting XMODEM upload" message before activating Xmodem upload on your terminal.
- Step 3.** After successful firmware upload, enter "atgo" to restart the Prestige.

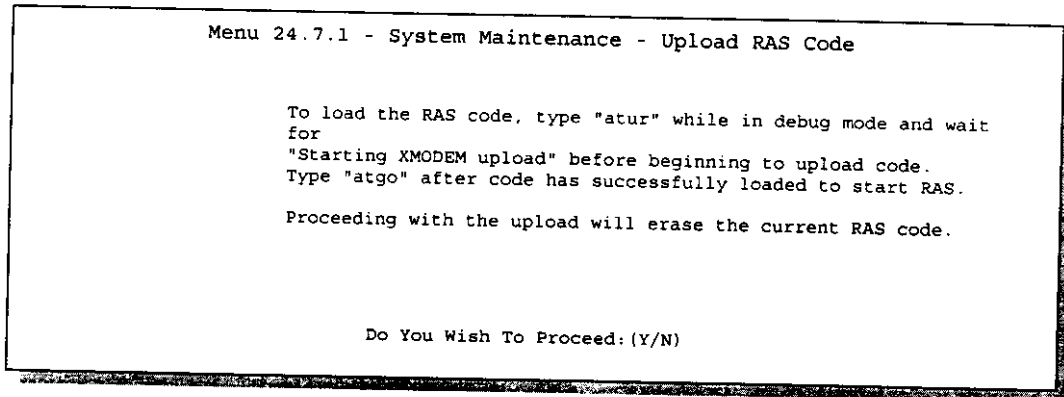

**Figure 7-10 Menu 24.7.1 - System Maintenance - Upload RAS Code**

### **7.7.2 Uploading ROM File**

The configuration data, system-related data, the error log and the trace log are all stored in the configuration file. Please be aware that uploading the configuration file replaces everything contained within.

Menu 24.7.2 shows you the instructions for uploading the ROM file. If you answer yes to the prompt, the Prestige will go into debug mode. Follow the procedure below to upload the configuration file:

- Step 1.** Enter "atur" after the "Enter Debug Mode" message.
- Step 2.** Wait for the "Starting XMODEM upload" message before activating Xmodem upload on your terminal.
- Step 3.** After successful firmware upload, enter "atgo" to restart the Prestige.

The following table describes the diagnostic tests available in Menu 24.4 for your Prestige and the connections.

**Table 7-3 System Maintenance Menu Diagnostic**

Field	Description
Ping Host	This diagnostic test pings the host, which determines the functionality of the TCP/IP protocol on both systems and the links in between.
Reboot System	This option reboots the Prestige.
Command Mode	This option allows you to enter the command mode. This mode allows you to diagnose and test your Prestige using a specified set of commands.

## 7.5 Backup Configuration

Option 5 from **Menu 24 - System Maintenance** allows you to backup the current Prestige configuration to your workstation. Backup is highly recommended once your Prestige is functioning properly.

You can only perform the backup and restore using menu 24 through the console port, not telnet. Any serial communications program should work fine; however, you must use XMODEM protocol to perform the download/upload.

Please note that terms “download” and “upload” are relative to the workstation. Download means to transfer from another machine to the workstation, while upload means from your workstation to another machine.

```
Menu 24.5 -- System Maintenance - Backup Configuration
Ready to backup Configuration via Xmodem.
Do you want to continue (y/n):
```

**Figure 7-7 Menu 24.7 - System Maintenance - Backup Configuration**

### 7.3.2 Unix Syslog

The Prestige uses the UNIX syslog facility to log the messages to a syslog server. Syslog can be configured in **Menu 24.3.2 - System Maintenance - Syslog**, as shown below.

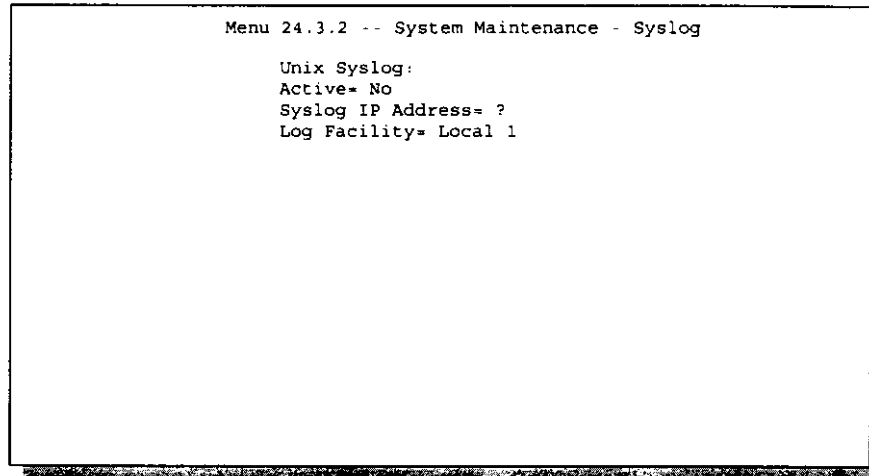

**Figure 7-5 Menu 24.3.2 - System Maintenance - Syslog and Accounting**

You need to configure the following three parameters described in the table below to activate syslog.

**Table 7-2 System Maintenance Menu Syslog Parameters**

Parameter	Description
Active	Use the space bar to turn on or off syslog.
Syslog IP Address	Enter the IP Address of your syslog server.
Log Facility	Use the space bar to toggle between the 7 different Local options. The log facility allows you to log the message in different files in the server. Please refer to your UNIX manual for more detail.

## 7.2 Console Port Speed

You can set up different port speeds for the console port through **Menu 24.2 – Console Port Speed**. Your Prestige supports 9600 (default), 19200, 38400, 57600, and 115200 bps for the console port. Use the space bar to select the desired speed in **Menu 24.2**, as shown below.

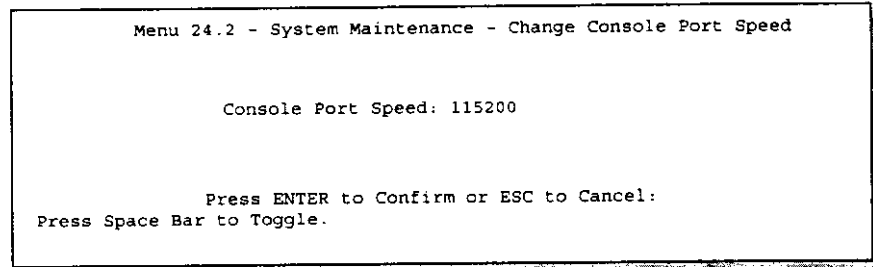

Figure 7-3 Menu 24.2 – System Maintenance – Change Console Port Speed

## 7.3 Log and Trace

There are two logging facilities in the Prestige. The first is the error logs and trace records that are stored locally. The second is the UNIX syslog facility for message logging.

### 7.3.1 Viewing Error Log

The first place you should look for clues when something goes wrong is the error/trace log. Follow the procedure below to view the local error/trace log:

- Step 1.** Select option 24 from the Main Menu to open **Menu 24 - System Maintenance**.
- Step 2.** From Menu 24, select option 3 to open **Menu 24.3 - System Maintenance - Log and Trace**.
- Step 3.** Select the first option from **Menu 24.3 - System Maintenance - Log and Trace** to display the error log in the system.



## 7.1 System Status

The first selection, System Status, gives you information on the version of your system firmware and the status and statistics of the ports, as shown in below. System Status is a tool that can be used to monitor your Prestige. Specifically, it gives you information on your system firmware version, number of packets sent and number of packets received.

To get to the System Status, Enter number **24** to go to **Menu 24 - System Maintenance**. In this menu, enter number **1** to open, **System Maintenance - Status**. There are two commands in **Menu 24.1 - System Maintenance - Status**. Entering **9** resets the counters, and **ESC** takes you back to the previous screen.

The table below describes the fields present in **Menu 24.1 - System Maintenance - Status**. It should be noted that these fields are READ-ONLY and are meant to be used for diagnostic purposes.

Menu 24.1 -- System Maintenance - Status							
Port	Status	TXPkts	RXPkts	Colls	Tx B/s	Rx B/s	Up Time
LAN	100M/Full	421	0	0	0	0	2:46:28
WAN	Down	421	0	0	0	0	0:00:00
Port:	Ethernet Address	IP Address	IP Mask	DHCP			
LAN	00:a0:c5:14:21:24	202.132.50.17	255.255.255.240	None			
WAN	00:a0:c5:14:21:25	202.132.154.126	255.255.255.0	None			
System up Time:		67:08:22	CPU Load:		2.46%		
Name:							
Routing: IP							
RAS F/W Version: A02 990310							
Press Command:							
COMMANDS: 9-Reset Counters				ESC Exit			

Figure 7-2 Menu 24.1 - System Maintenance – Status

### **6.3.2 Remote Node Filters**

Go to Menu 11.5 (shown below) and enter the number(s) of the filter set(s) as appropriate. You can specify up to four filter sets by entering their numbers separated by commas.

```
Menu 11.5 - Remote Node Filter

Input Filter Sets:
  protocol filters=
  device filters=
Output Filter Sets:
  protocol filters=
  device filters=
Call Filter Sets:
  protocol filters=
  device filters=
```

**Figure 6-8 Filtering Remote Node traffic**

The following table describes the fields in the Generic Filter Rule Menu.

**Table 6-5 Generic Filter Rule Menu Fields**

Field	Description	Option
Filter #	This is the filter set, filter rule co-ordinates, i.e., 2,3 refers to the second filter set and the third rule of that set.	
Filter Type	Use the space bar to toggle between both types of rules. Parameters displayed below each type will be different.	Generic Filter Rule/ TCP/IP Filter Rule
Active	Select <b>Yes</b> to turn on the filter rule.	Yes/No
Offset	Enter the starting byte of the data portion in the packet that you wish to compare. The range for this field is from 0 to 255.	Default = 0
Length	Enter the byte count of the data portion in the packet that you wish to compare. The range for this field is 0 to 8.	Default = 0
Mask	Enter the mask (in Hexadecimal) to apply to the data portion before comparison.	
Value	Enter the value (in Hexadecimal) to compare with the data portion.	
More	If yes, a matching packet is passed to the next filter rule before an action is taken; else the packet is disposed of according to the action fields.  If More is <b>Yes</b> , then Action Matched and Action Not Matched will be <b>N/A</b> .	Yes / N/A
Log	Select the logging option from the following: <ul style="list-style-type: none"> <li>● <b>None</b> – No packets will be logged.</li> <li>● <b>Action Matched</b> - Only packets that match the rule parameters will be logged.</li> <li>● <b>Action Not Matched</b> - Only packets that do not match the rule parameters will be logged.</li> <li>● <b>Both</b> – All packets will be logged.</li> </ul>	None Action Matched Action Not Matched Both
Action Matched	Select the action for a matching packet.	Check Next Rule Forward Drop

Field	Description	Option
More	<p>If yes, a matching packet is passed to the next filter rule before an action is taken; else the packet is disposed of according to the action fields.</p> <p>If More is <b>Yes</b>, then Action Matched and Action Not Matched will be <b>N/A</b>.</p>	<b>Yes / N/A</b>
Log	<p>Select the logging option from the following:</p> <ul style="list-style-type: none"> <li>● <b>None</b> – No packets will be logged.</li> <li>● <b>Action Matched</b> - Only packets that match the rule parameters will be logged.</li> <li>● <b>Action Not Matched</b> - Only packets that do not match the rule parameters will be logged.</li> <li>● <b>Both</b> – All packets will be logged.</li> </ul>	<p><b>None</b></p> <p><b>Action Matched</b></p> <p><b>Action Not Matched</b></p> <p><b>Both</b></p>
Action Matched	Select the action for a matching packet.	<p><b>Check Next Rule</b></p> <p><b>Forward</b></p> <p><b>Drop</b></p>
Action Not Matched	Select the action for a packet not matching the rule.	<p><b>Check Next Rule</b></p> <p><b>Forward</b></p> <p><b>Drop</b></p>

Once you have completed filling in Menu 21.1.1 - TCP/IP Filter Rule, press [Enter] at the message [Press Enter to Confirm] to save your configuration, or press [Esc] to cancel. This data will now be displayed on Menu 21.1 - Filter Rules Summary.