



# USG Series

USG20-VPN / USG20W-VPN

VPN Firewalls

Version 4.16  
Edition 1, 12/2015

## User's Guide

### Default Login Details

LAN Port IP Address	<a href="https://192.168.1.1">https://192.168.1.1</a>
User Name	admin
Password	1234

---

## **Part I: User's Guide ..... 16**

### **Chapter 1**

#### **Introduction ..... 18**

1.1 Overview .....	18
1.1.1 Applications .....	18
1.2 Management Overview .....	20
1.3 Web Configurator .....	22
1.3.1 Web Configurator Access .....	22
1.3.2 Web Configurator Screens Overview .....	24
1.3.3 Navigation Panel .....	28
1.3.4 Tables and Lists .....	33

### **Chapter 2**

#### **Installation Setup Wizard ..... 36**

2.1 Installation Setup Wizard Screens .....	36
2.1.1 Internet Access Setup - WAN Interface .....	36
2.1.2 Internet Access: Ethernet .....	37
2.1.3 Internet Access: PPPoE .....	38
2.1.4 Internet Access: PPTP .....	40
2.1.5 Internet Access Setup - Second WAN Interface .....	41
2.1.6 Internet Access Succeed .....	42
2.1.7 Wireless Settings: SSID & Security .....	42
2.1.8 Internet Access - Device Registration .....	43

### **Chapter 3**

#### **Hardware, Interfaces and Zones ..... 44**

3.1 Hardware Overview .....	44
3.1.1 Front Panels .....	44
3.1.2 Rear Panels .....	45
3.1.3 Wall-mounting .....	46
3.2 Default Zones, Interfaces, and Ports .....	47
3.3 Stopping the USG .....	48

### **Chapter 4**

#### **Quick Setup Wizards ..... 49**

4.1 Quick Setup Overview .....	49
4.2 WAN Interface Quick Setup .....	50
4.2.1 Choose an Ethernet Interface .....	50
4.2.2 Select WAN Type .....	51
4.2.3 Configure WAN IP Settings .....	51
4.2.4 ISP and WAN and ISP Connection Settings .....	52
4.2.5 Quick Setup Interface Wizard: Summary .....	54

---

4.3 VPN Setup Wizard .....	55
4.3.1 Welcome .....	56
4.3.2 VPN Setup Wizard: Wizard Type .....	57
4.3.3 VPN Express Wizard - Scenario .....	57
4.3.4 VPN Express Wizard - Configuration .....	59
4.3.5 VPN Express Wizard - Summary .....	59
4.3.6 VPN Express Wizard - Finish .....	60
4.3.7 VPN Advanced Wizard - Scenario .....	61
4.3.8 VPN Advanced Wizard - Phase 1 Settings .....	62
4.3.9 VPN Advanced Wizard - Phase 2 .....	64
4.3.10 VPN Advanced Wizard - Summary .....	65
4.3.11 VPN Advanced Wizard - Finish .....	65
4.4 VPN Settings for Configuration Provisioning Wizard: Wizard Type .....	66
4.4.1 Configuration Provisioning Express Wizard - VPN Settings .....	67
4.4.2 Configuration Provisioning VPN Express Wizard - Configuration .....	68
4.4.3 VPN Settings for Configuration Provisioning Express Wizard - Summary .....	69
4.4.4 VPN Settings for Configuration Provisioning Express Wizard - Finish .....	70
4.4.5 VPN Settings for Configuration Provisioning Advanced Wizard - Scenario .....	71
4.4.6 VPN Settings for Configuration Provisioning Advanced Wizard - Phase 1 Settings .....	72
4.4.7 VPN Settings for Configuration Provisioning Advanced Wizard - Phase 2 .....	74
4.4.8 VPN Settings for Configuration Provisioning Advanced Wizard - Summary .....	74
4.4.9 VPN Settings for Configuration Provisioning Advanced Wizard- Finish .....	76
4.5 VPN Settings for L2TP VPN Settings Wizard .....	77
4.5.1 L2TP VPN Settings .....	78
4.5.2 L2TP VPN Settings .....	79
4.5.3 VPN Settings for L2TP VPN Setting Wizard - Summary .....	80
4.5.4 VPN Settings for L2TP VPN Setting Wizard Completed .....	81

**Chapter 5**  
**Dashboard .....** **82**

5.1 Overview .....	82
5.1.1 What You Can Do in this Chapter .....	82
5.2 Main Dashboard Screen .....	82
5.2.1 Device Information Screen .....	84
5.2.2 System Status Screen .....	85
5.2.3 VPN Status Screen .....	86
5.2.4 DHCP Table Screen .....	87
5.2.5 Number of Login Users Screen .....	88
5.2.6 System Resources Screen .....	89
5.2.7 CPU Usage Screen .....	90
5.2.8 Memory Usage Screen .....	91
5.2.9 Active Session Screen .....	92
5.2.10 Extension Slot Screen .....	93

---

5.2.11 Interface Status Summary Screen .....	93
5.2.12 Secured Service Status Screen .....	94
5.2.13 Content Filter Statistics Screen .....	95
5.2.14 Top 5 IPv4/IPv6 Security Policy Rules that Blocked Traffic Screen .....	96
5.2.15 The Latest Alert Logs Screen .....	96

## **Part II: Technical Reference..... 98**

### **Chapter 6**

#### **Monitor..... 100**

6.1 Overview .....	100
6.1.1 What You Can Do in this Chapter .....	100
6.2 The Port Statistics Screen .....	101
6.2.1 The Port Statistics Graph Screen .....	102
6.3 Interface Status Screen .....	103
6.4 The Traffic Statistics Screen .....	105
6.5 The Session Monitor Screen .....	108
6.6 IGMP Statistics .....	109
6.7 The DDNS Status Screen .....	110
6.8 IP/MAC Binding .....	111
6.9 The Login Users Screen .....	111
6.10 Cellular Status Screen .....	112
6.11 The UPnP Port Status Screen .....	114
6.12 USB Storage Screen .....	115
6.13 Ethernet Neighbor Screen .....	116
6.14 Wireless .....	117
6.14.1 Wireless AP Information: Radio List .....	117
6.14.2 Radio List More Information .....	119
6.14.3 Wireless Station Info .....	120
6.14.4 Detected Device .....	121
6.15 The IPSec Monitor Screen .....	122
6.15.1 Regular Expressions in Searching IPSec SAs .....	123
6.16 The SSL Screen .....	123
6.17 The L2TP over IPSec Session Monitor Screen .....	124
6.18 The Content Filter Screen .....	125
6.19 The Anti-Spam Screens .....	127
6.19.1 Anti-Spam Report .....	127
6.19.2 The Anti-Spam Status Screen .....	129
6.20 Log Screens .....	130
6.20.1 View Log .....	130

---

<b>Chapter 7</b>	
<b>Licensing</b> .....	<b>133</b>
7.1 Registration Overview .....	133
7.1.1 What you Need to Know .....	133
7.1.2 Registration Screen .....	134
7.1.3 Service Screen .....	134
<b>Chapter 8</b>	
<b>Wireless</b> .....	<b>136</b>
8.1 Overview .....	136
8.1.1 What You Can Do in this Chapter .....	136
8.1.2 What You Need to Know .....	136
8.2 AP Management Screen .....	137
8.3 DCS Screen .....	138
8.4 Technical Reference .....	138
8.4.1 Dynamic Channel Selection .....	138
<b>Chapter 9</b>	
<b>Interfaces</b> .....	<b>140</b>
9.1 Interface Overview .....	140
9.1.1 What You Can Do in this Chapter .....	140
9.1.2 What You Need to Know .....	141
9.1.3 What You Need to Do First .....	145
9.2 Port Role Screen .....	145
9.3 Ethernet Summary Screen .....	146
9.3.1 Ethernet Edit .....	148
9.3.2 Object References .....	163
9.3.3 Add/Edit DHCPv6 Request/Release Options .....	164
9.3.4 Add/Edit DHCP Extended Options .....	165
9.4 PPP Interfaces .....	166
9.4.1 PPP Interface Summary .....	167
9.4.2 PPP Interface Add or Edit .....	168
9.5 Cellular Configuration Screen .....	173
9.5.1 Cellular Choose Slot .....	176
9.5.2 Add / Edit Cellular Configuration .....	176
9.6 Tunnel Interfaces .....	182
9.6.1 Configuring a Tunnel .....	184
9.6.2 Tunnel Add or Edit Screen .....	185
9.7 VLAN Interfaces .....	188
9.7.1 VLAN Summary Screen .....	190
9.7.2 VLAN Add/Edit .....	192
9.8 Bridge Interfaces .....	201
9.8.1 Bridge Summary .....	203

---

9.8.2 Bridge Add/Edit .....	204
9.9 Virtual Interfaces .....	213
9.9.1 Virtual Interfaces Add/Edit .....	213
9.10 Interface Technical Reference .....	215
9.11 Trunk Overview .....	218
9.11.1 What You Need to Know .....	218
9.12 The Trunk Summary Screen .....	221
9.12.1 Configuring a User-Defined Trunk .....	222
9.12.2 Configuring the System Default Trunk .....	224
<b>Chapter 10</b>	
<b>Routing .....</b>	<b>226</b>
10.1 Policy and Static Routes Overview .....	226
10.1.1 What You Can Do in this Chapter .....	226
10.1.2 What You Need to Know .....	227
10.2 Policy Route Screen .....	228
10.2.1 Policy Route Edit Screen .....	230
10.3 IP Static Route Screen .....	235
10.3.1 Static Route Add/Edit Screen .....	235
10.4 Policy Routing Technical Reference .....	237
10.5 Routing Protocols Overview .....	238
10.5.1 What You Need to Know .....	238
10.6 The RIP Screen .....	238
10.7 The OSPF Screen .....	240
10.7.1 Configuring the OSPF Screen .....	243
10.7.2 OSPF Area Add/Edit Screen .....	244
10.7.3 Virtual Link Add/Edit Screen .....	246
10.8 Routing Protocol Technical Reference .....	247
<b>Chapter 11</b>	
<b>DDNS .....</b>	<b>249</b>
11.1 DDNS Overview .....	249
11.1.1 What You Can Do in this Chapter .....	249
11.1.2 What You Need to Know .....	249
11.2 The DDNS Screen .....	250
11.2.1 The Dynamic DNS Add/Edit Screen .....	251
<b>Chapter 12</b>	
<b>NAT .....</b>	<b>255</b>
12.1 NAT Overview .....	255
12.1.1 What You Can Do in this Chapter .....	255
12.1.2 What You Need to Know .....	255
12.2 The NAT Screen .....	255

---

12.2.1 The NAT Add/Edit Screen .....	257
12.3 NAT Technical Reference .....	260
<b>Chapter 13</b>	
<b>HTTP Redirect .....</b>	<b>262</b>
13.1 Overview .....	262
13.1.1 What You Can Do in this Chapter .....	262
13.1.2 What You Need to Know .....	262
13.2 The HTTP Redirect Screen .....	263
13.2.1 The HTTP Redirect Edit Screen .....	264
<b>Chapter 14</b>	
<b>ALG .....</b>	<b>266</b>
14.1 ALG Overview .....	266
14.1.1 What You Need to Know .....	266
14.1.2 Before You Begin .....	269
14.2 The ALG Screen .....	269
14.3 ALG Technical Reference .....	271
<b>Chapter 15</b>	
<b>UPnP .....</b>	<b>273</b>
15.1 UPnP and NAT-PMP Overview .....	273
15.2 What You Need to Know .....	273
15.2.1 NAT Traversal .....	273
15.2.2 Cautions with UPnP and NAT-PMP .....	274
15.3 UPnP Screen .....	274
15.4 Technical Reference .....	275
15.4.1 Turning on UPnP in Windows 7 Example .....	275
15.4.2 Using UPnP in Windows XP Example .....	277
15.4.3 Web Configurator Easy Access .....	279
<b>Chapter 16</b>	
<b>IP/MAC Binding .....</b>	<b>282</b>
16.1 IP/MAC Binding Overview .....	282
16.1.1 What You Can Do in this Chapter .....	282
16.1.2 What You Need to Know .....	282
16.2 IP/MAC Binding Summary .....	283
16.2.1 IP/MAC Binding Edit .....	283
16.2.2 Static DHCP Edit .....	284
16.3 IP/MAC Binding Exempt List .....	285
<b>Chapter 17</b>	
<b>Layer 2 Isolation .....</b>	<b>287</b>

---

17.1 Overview .....	287
17.1.1 What You Can Do in this Chapter .....	287
17.2 Layer-2 Isolation General Screen .....	288
17.3 White List Screen .....	288
17.3.1 Add/Edit White List Rule .....	289
<b>Chapter 18</b>	
<b>Inbound Load Balancing.....</b>	<b>291</b>
18.1 Inbound Load Balancing Overview .....	291
18.1.1 What You Can Do in this Chapter .....	291
18.2 The Inbound LB Screen .....	292
18.2.1 The Inbound LB Add/Edit Screen .....	293
18.2.2 The Inbound LB Member Add/Edit Screen .....	295
<b>Chapter 19</b>	
<b>Web Authentication .....</b>	<b>297</b>
19.1 Web Auth Overview .....	297
19.1.1 What You Can Do in this Chapter .....	297
19.1.2 What You Need to Know .....	298
19.2 Web Authentication Screen .....	298
19.2.1 Creating Exceptional Services .....	301
19.2.2 Creating/Editing an Authentication Policy .....	301
19.3 SSO Overview .....	302
19.4 SSO - USG Configuration .....	304
19.4.1 Configuration Overview .....	304
19.4.2 Configure the USG to Communicate with SSO .....	304
19.4.3 Enable Web Authentication .....	305
19.4.4 Create a Security Policy .....	306
19.4.5 Configure User Information .....	307
19.4.6 Configure an Authentication Method .....	308
19.4.7 Configure Active Directory .....	309
19.5 SSO Agent Configuration .....	310
<b>Chapter 20</b>	
<b>Security Policy.....</b>	<b>314</b>
20.1 Overview .....	314
20.2 One Security .....	314
20.3 What You Can Do in this Chapter .....	318
20.3.1 What You Need to Know .....	318
20.4 The Security Policy Screen .....	320
20.4.1 Configuring the Security Policy Control Screen .....	321
20.4.2 The Security Policy Control Add/Edit Screen .....	324
20.5 The Session Control Screen .....	326



---

20.5.1 The Session Control Add/Edit Screen .....	328
20.6 Security Policy Example Applications .....	329
<b>Chapter 21</b>	
<b>IPSec VPN.....</b>	<b>332</b>
21.1 Virtual Private Networks (VPN) Overview .....	332
21.1.1 What You Can Do in this Chapter .....	334
21.1.2 What You Need to Know .....	335
21.1.3 Before You Begin .....	336
21.2 The VPN Connection Screen .....	337
21.2.1 The VPN Connection Add/Edit (IKE) Screen .....	338
21.3 The VPN Gateway Screen .....	344
21.3.1 The VPN Gateway Add/Edit Screen .....	346
21.4 VPN Concentrator .....	353
21.4.1 VPN Concentrator Requirements and Suggestions .....	353
21.4.2 VPN Concentrator Screen .....	354
21.4.3 The VPN Concentrator Add/Edit Screen .....	354
21.5 USG IPSec VPN Client Configuration Provisioning .....	355
21.6 IPSec VPN Background Information .....	357
<b>Chapter 22</b>	
<b>SSL VPN .....</b>	<b>367</b>
22.1 Overview .....	367
22.1.1 What You Can Do in this Chapter .....	367
22.1.2 What You Need to Know .....	367
22.2 The SSL Access Privilege Screen .....	368
22.2.1 The SSL Access Privilege Policy Add/Edit Screen .....	369
22.3 The SSL Global Setting Screen .....	372
22.3.1 How to Upload a Custom Logo .....	373
22.4 USG SecuExtender .....	374
22.4.1 Example: Configure USG for SecuExtender .....	375
<b>Chapter 23</b>	
<b>SSL User Screens.....</b>	<b>378</b>
23.1 Overview .....	378
23.1.1 What You Need to Know .....	378
23.2 Remote SSL User Login .....	379
23.3 The SSL VPN User Screens .....	382
23.4 Bookmarking the USG .....	383
23.5 Logging Out of the SSL VPN User Screens .....	384
23.6 SSL User Application Screen .....	384
23.7 SSL User File Sharing .....	385
23.7.1 The Main File Sharing Screen .....	385

---

23.7.2 Opening a File or Folder .....	386
23.7.3 Downloading a File .....	387
23.7.4 Saving a File .....	387
23.7.5 Creating a New Folder .....	388
23.7.6 Renaming a File or Folder .....	388
23.7.7 Deleting a File or Folder .....	389
23.7.8 Uploading a File .....	389
<b>Chapter 24</b>	
<b>USG SecuExtender (Windows).....</b>	<b>391</b>
24.1 The USG SecuExtender Icon .....	391
24.2 Status .....	391
24.3 View Log .....	392
24.4 Suspend and Resume the Connection .....	393
24.5 Stop the Connection .....	393
24.6 Uninstalling the USG SecuExtender .....	393
<b>Chapter 25</b>	
<b>L2TP VPN.....</b>	<b>395</b>
25.1 Overview .....	395
25.1.1 What You Can Do in this Chapter .....	395
25.1.2 What You Need to Know .....	395
25.2 L2TP VPN Screen .....	396
25.2.1 Example: L2TP and USG Behind a NAT Router .....	398
<b>Chapter 26</b>	
<b>BWM (Bandwidth Management) .....</b>	<b>400</b>
26.1 Overview .....	400
26.1.1 What You Can Do in this Chapter .....	400
26.1.2 What You Need to Know .....	400
26.2 The Bandwidth Management Screen .....	404
26.2.1 The Bandwidth Management Add/Edit Screen .....	406
<b>Chapter 27</b>	
<b>Content Filtering .....</b>	<b>415</b>
27.1 Overview .....	415
27.1.1 What You Can Do in this Chapter .....	415
27.1.2 What You Need to Know .....	415
27.1.3 Before You Begin .....	416
27.2 Content Filter Profile Screen .....	417
27.3 Content Filter Profile Add or Edit Screen .....	419
27.3.1 Content Filter Add Profile Category Service .....	420
27.3.2 Content Filter Add Filter Profile Custom Service .....	427

---

27.4 Content Filter Trusted Web Sites Screen .....	430
27.5 Content Filter Forbidden Web Sites Screen .....	431
27.6 Content Filter Technical Reference .....	432

## **Chapter 28**

### **Anti-Spam.....434**

28.1 Overview .....	434
28.1.1 What You Can Do in this Chapter .....	434
28.1.2 What You Need to Know .....	434
28.2 Before You Begin .....	435
28.3 The Anti-Spam Profile Screen .....	436
28.3.1 The Anti-Spam Profile Add or Edit Screen .....	437
28.4 The Mail Scan Screen .....	439
28.5 The Anti-Spam Black List Screen .....	441
28.5.1 The Anti-Spam Black or White List Add/Edit Screen .....	443
28.5.2 Regular Expressions in Black or White List Entries .....	444
28.6 The Anti-Spam White List Screen .....	444
28.7 The DNSBL Screen .....	446
28.8 Anti-Spam Technical Reference .....	448

## **Chapter 29**

### **Object.....452**

29.1 Zones Overview .....	452
29.1.1 What You Need to Know .....	452
29.1.2 The Zone Screen .....	453
29.2 User/Group Overview .....	454
29.2.1 What You Need To Know .....	455
29.2.2 User/Group User Summary Screen .....	457
29.2.3 User/Group Group Summary Screen .....	460
29.2.4 User/Group Setting Screen .....	461
29.2.5 User/Group MAC Address Summary Screen .....	466
29.2.6 User /Group Technical Reference .....	467
29.3 AP Profile Overview .....	468
29.3.1 Radio Screen .....	469
29.3.2 SSID Screen .....	475
29.4 MON Profile .....	484
29.4.1 Overview .....	484
29.4.2 MON Profile .....	484
29.5 Address Overview .....	487
29.5.1 What You Need To Know .....	487
29.5.2 Address Summary Screen .....	487
29.6 Service Overview .....	491
29.6.1 What You Need to Know .....	492

---

29.6.2	The Service Summary Screen .....	492
29.6.3	The Service Group Summary Screen .....	494
29.7	Schedule Overview .....	496
29.7.1	What You Need to Know .....	496
29.7.2	The Schedule Summary Screen .....	497
29.7.3	The Schedule Group Screen .....	500
29.8	AAA Server Overview .....	501
29.8.1	Directory Service (AD/LDAP) .....	502
29.8.2	RADIUS Server .....	502
29.8.3	ASAS .....	502
29.8.4	What You Need To Know .....	503
29.8.5	Active Directory or LDAP Server Summary .....	504
29.8.6	RADIUS Server Summary .....	508
29.9	Auth. Method Overview .....	510
29.9.1	Before You Begin .....	510
29.9.2	Example: Selecting a VPN Authentication Method .....	510
29.9.3	Authentication Method Objects .....	511
29.10	Certificate Overview .....	513
29.10.1	What You Need to Know .....	513
29.10.2	Verifying a Certificate .....	515
29.10.3	The My Certificates Screen .....	516
29.10.4	The Trusted Certificates Screen .....	523
29.10.5	Certificates Technical Reference .....	528
29.11	ISP Account Overview .....	528
29.11.1	ISP Account Summary .....	528
29.12	SSL Application Overview .....	531
29.12.1	What You Need to Know .....	531
29.12.2	The SSL Application Screen .....	533

**Chapter 30**  
**System .....** **537**

30.1	Overview .....	537
30.1.1	What You Can Do in this Chapter .....	537
30.2	Host Name .....	538
30.3	USB Storage .....	538
30.4	Date and Time .....	539
30.4.1	Pre-defined NTP Time Servers List .....	542
30.4.2	Time Server Synchronization .....	542
30.5	Console Port Speed .....	543
30.6	DNS Overview .....	544
30.6.1	DNS Server Address Assignment .....	544
30.6.2	Configuring the DNS Screen .....	544
30.6.3	Address Record .....	547

---

30.6.4 PTR Record .....	548
30.6.5 Adding an Address/PTR Record .....	548
30.6.6 CNAME Record .....	548
30.6.7 Adding a CNAME Record .....	549
30.6.8 Domain Zone Forwarder .....	549
30.6.9 Adding a Domain Zone Forwarder .....	549
30.6.10 MX Record .....	550
30.6.11 Adding a MX Record .....	551
30.6.12 Security Option Control .....	551
30.6.13 Editing a Security Option Control .....	551
30.6.14 Adding a DNS Service Control Rule .....	552
30.7 WWW Overview .....	553
30.7.1 Service Access Limitations .....	553
30.7.2 System Timeout .....	554
30.7.3 HTTPS .....	554
30.7.4 Configuring WWW Service Control .....	555
30.7.5 Service Control Rules .....	558
30.7.6 Customizing the WWW Login Page .....	559
30.7.7 HTTPS Example .....	562
30.8 SSH .....	569
30.8.1 How SSH Works .....	570
30.8.2 SSH Implementation on the USG .....	571
30.8.3 Requirements for Using SSH .....	571
30.8.4 Configuring SSH .....	571
30.8.5 Secure Telnet Using SSH Examples .....	572
30.9 Telnet .....	573
30.9.1 Configuring Telnet .....	573
30.10 FTP .....	575
30.10.1 Configuring FTP .....	575
30.11 SNMP .....	576
30.11.1 SNMPv3 and Security .....	577
30.11.2 Supported MIBs .....	577
30.11.3 SNMP Traps .....	577
30.11.4 Configuring SNMP .....	578
30.12 Authentication Server .....	580
30.12.1 Add/Edit Trusted RADIUS Client .....	581
30.13 CloudCNM Screen .....	582
30.14 Language Screen .....	585
30.15 IPv6 Screen .....	585
30.16 ZyXEL One Network (ZON) Utility .....	586
30.16.1 ZyXEL One Network (ZON) System Screen .....	587
<b>Chapter 31</b>	
<b>Log and Report .....</b>	<b>589</b>

---

---

31.1 Overview .....	589
31.1.1 What You Can Do In this Chapter .....	589
31.2 Email Daily Report .....	589
31.3 Log Setting Screens .....	591
31.3.1 Log Settings .....	592
31.3.2 Edit System Log Settings .....	593
31.3.3 Edit Log on USB Storage Setting .....	596
31.3.4 Edit Remote Server Log Settings .....	598
31.3.5 Log Category Settings Screen .....	600
<b>Chapter 32</b>	
<b>File Manager.....</b>	<b>604</b>
32.1 Overview .....	604
32.1.1 What You Can Do in this Chapter .....	604
32.1.2 What you Need to Know .....	604
32.2 The Configuration File Screen .....	606
32.3 The Firmware Package Screen .....	610
32.4 The Shell Script Screen .....	612
<b>Chapter 33</b>	
<b>Diagnostics .....</b>	<b>615</b>
33.1 Overview .....	615
33.1.1 What You Can Do in this Chapter .....	615
33.2 The Diagnostic Screen .....	615
33.2.1 The Diagnostics Files Screen .....	616
33.3 The Packet Capture Screen .....	617
33.3.1 The Packet Capture Files Screen .....	620
33.4 The Core Dump Screen .....	620
33.4.1 The Core Dump Files Screen .....	621
33.5 The System Log Screen .....	622
33.6 The Network Tool Screen .....	622
33.7 The Wireless Frame Capture Screen .....	623
33.7.1 The Wireless Frame Capture Files Screen .....	625
<b>Chapter 34</b>	
<b>Packet Flow Explore .....</b>	<b>627</b>
34.1 Overview .....	627
34.1.1 What You Can Do in this Chapter .....	627
34.2 The Routing Status Screen .....	627
34.3 The SNAT Status Screen .....	632
<b>Chapter 35</b>	
<b>Shutdown.....</b>	<b>635</b>

---

35.1 Overview .....	635
35.1.1 What You Need To Know .....	635
35.2 The Shutdown Screen .....	635
<b>Chapter 36</b>	
<b>Troubleshooting.....</b>	<b>636</b>
36.1 Resetting the USG .....	644
36.2 Getting More Troubleshooting Help .....	645
Appendix A Customer Support .....	646
Appendix B Legal Information.....	652
Appendix C Product Features.....	661
<b>Index .....</b>	<b>665</b>

---

# **PART I**

## **User's Guide**

---





# Introduction

## 1.1 Overview

“USG” in this User’s Guide refers to all USG models in the series.

**Table 1** USG Models

USG20-VPN
USG20W-VPN

USG20W-VPN has built-in Wi-Fi functionality

- See [Table 12 on page 47](#) for default port / interface name mapping. See [Table 13 on page 48](#) for default interface / zone mapping.

See the product’s datasheet for detailed information on a specific model.

### 1.1.1 Applications

These are some USG application scenarios.

#### Security Router

Security includes a Stateful Packet Inspection (SPI) firewall, Content Filtering (CF) and Anti-Spam (AS).

**Figure 1** Applications: Security Router Applications: Security Router



## IPv6 Routing

The USG supports IPv6 Ethernet, PPP, VLAN, and bridge routing. You may also create IPv6 policy routes and IPv6 objects. The USG can also route IPv6 packets through IPv4 networks using different tunneling methods.

**Figure 2** Applications: IPv6 Routing

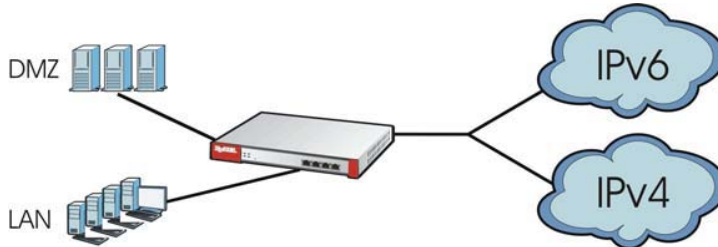

## VPN Connectivity

Set up VPN tunnels with other companies, branch offices, telecommuters, and business travelers to provide secure access to your network. You can also purchase the USG OTPv2 One-Time Password System for strong two-factor authentication for Web Configurator, Web access, SSL VPN, and ZyXEL IPsec VPN client user logins.

**Figure 3** Applications: VPN Connectivity

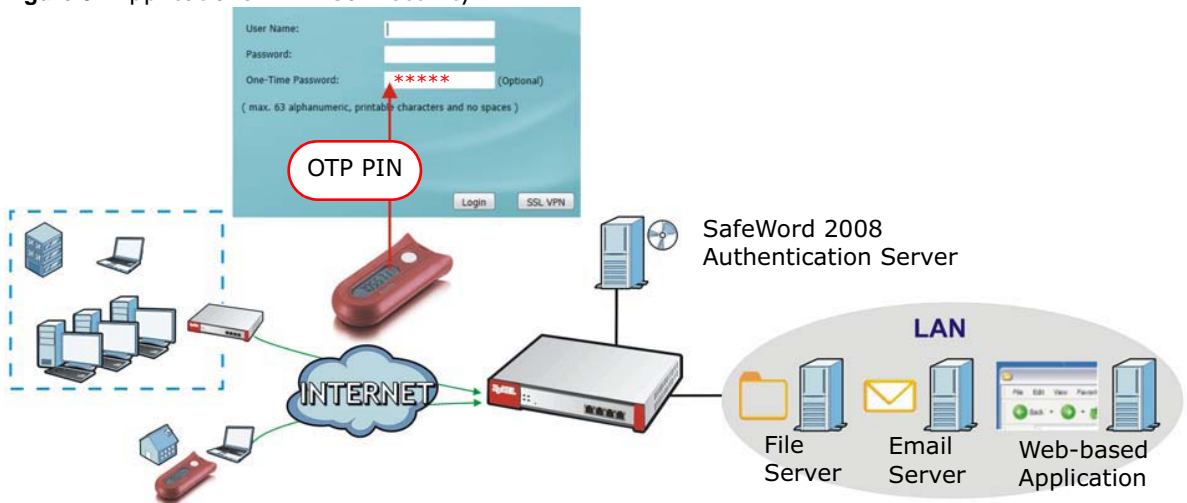

## SSL VPN Network Access

SSL VPN lets remote users use their web browsers for a very easy-to-use VPN solution. A user just browses to the USG's web address and enters his user name and password to securely connect to the USG's network. Here full tunnel mode creates a virtual connection for a remote user and gives him a private IP address in the same subnet as the local network so he can access network resources in the same way as if he were part of the internal network.

**Figure 4** SSL VPN With Full Tunnel Mode

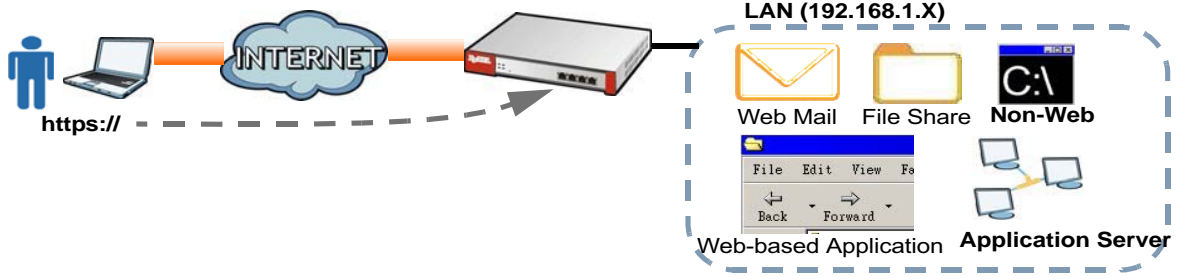

### User-Aware Access Control

Set up security policies to restrict access to sensitive information and shared resources based on the user who is trying to access it. In the following figure user **A** can access both the Internet and an internal file server. User **B** has a lower level of access and can only access the Internet. User **C** is not even logged in, so and cannot access either the Internet or the file server.

**Figure 5** Applications: User-Aware Access Control

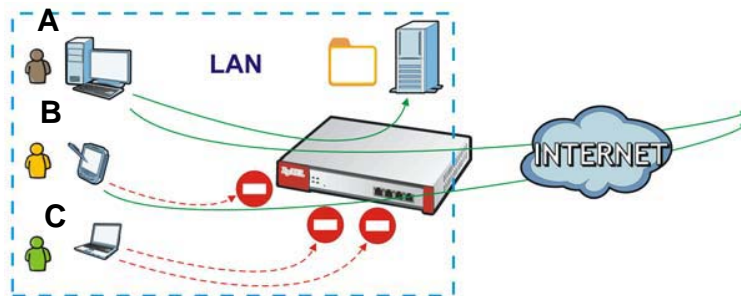

### Load Balancing

Set up multiple connections to the Internet on the same port, or different ports, including cellular interfaces. In either case, you can balance the traffic loads between them.

**Figure 6** Applications: Multiple WAN Interfaces



## 1.2 Management Overview

You can manage the USG in the following ways.

## Web Configurator

The Web Configurator allows easy USG setup and management using an Internet browser. This User's Guide provides information about the Web Configurator.

**Figure 7** Managing the USG: Web Configurator

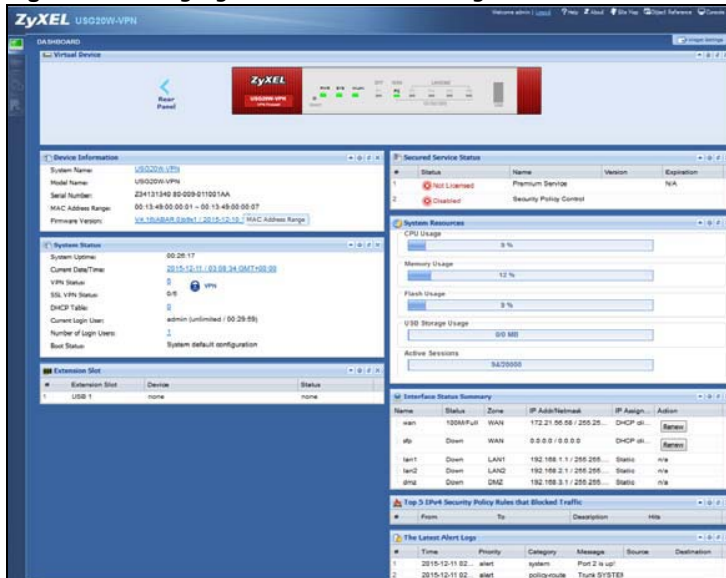

## Command-Line Interface (CLI)

The CLI allows you to use text-based commands to configure the USG. Access it using remote management (for example, SSH or Telnet) or via the physical or Web Configurator console port. See the Command Reference Guide for CLI details. The default settings for the console port are:

**Table 2** Console Port Default Settings

SETTING	VALUE
Speed	115200 bps
Data Bits	8
Parity	None
Stop Bit	1
Flow Control	Off

## FTP

Use File Transfer Protocol for firmware upgrades and configuration backup/restore.

## SNMP

The device can be monitored and/or managed by an SNMP manager. See [Section 30.11 on page 576](#).

## Cloud CNM

Use the **CloudCNM** screen (see [Section 30.13 on page 582](#)) to enable and configure management of the USG by a Central Network Management system.

## 1.3 Web Configurator

In order to use the Web Configurator, you must:

- Use one of the following web browser versions or later: Internet Explorer 7, Firefox 3.5, Chrome 9.0
- Allow pop-up windows (blocked by default in Windows XP Service Pack 2)
- Enable JavaScripts, Java permissions, and cookies

The recommended screen resolution is 1024 x 768 pixels.

### 1.3.1 Web Configurator Access

- 1 Make sure your USG hardware is properly connected. See the Quick Start Guide.
- 2 In your browser go to <http://192.168.1.1>. By default, the USG automatically routes this request to its HTTPS server, and it is recommended to keep this setting. The **Login** screen appears.

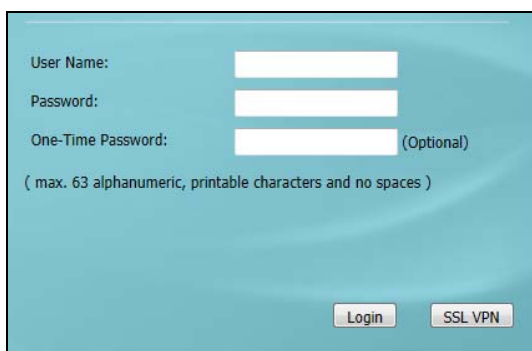

- 3 Type the user name (default: "admin") and password (default: "1234").  
If you have a OTP (One-Time Password) token generate a number and enter it in the **One-Time Password** field. The number is only good for one login. You must use the token to generate a new number the next time you log in.
- 4 Click **Login**. If you logged in using the default user name and password, the **Update Admin Info** screen appears. Otherwise, the dashboard appears.

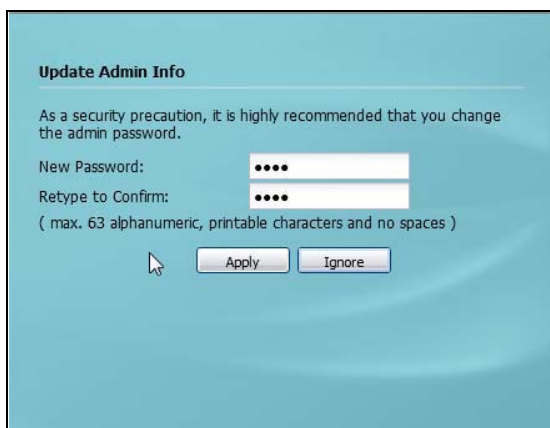

- 5 The **Network Risk Warning** screen displays any unregistered or disabled security services. Select how often to display the screen and click **OK**.



If you select **Never** and you later want to bring this screen back, use these commands (note the space before the underscore).

```
Router> enable
Router#
Router# configure terminal
Router(config)#
Router(config)# service-register _setremind
after-10-days
after-180-days
after-30-days
every-time
never
Router(config)# service-register _setremind every-time
Router(config)#
```

See the Command Line Interface (CLI) Reference Guide (RG) for details on all supported commands.

- Follow the directions in the **Update Admin Info** screen. If you change the default password, the **Login** screen appears after you click **Apply**. If you click **Ignore**, the **Installation Setup Wizard** opens if the USG is using its default configuration; otherwise the dashboard appears.

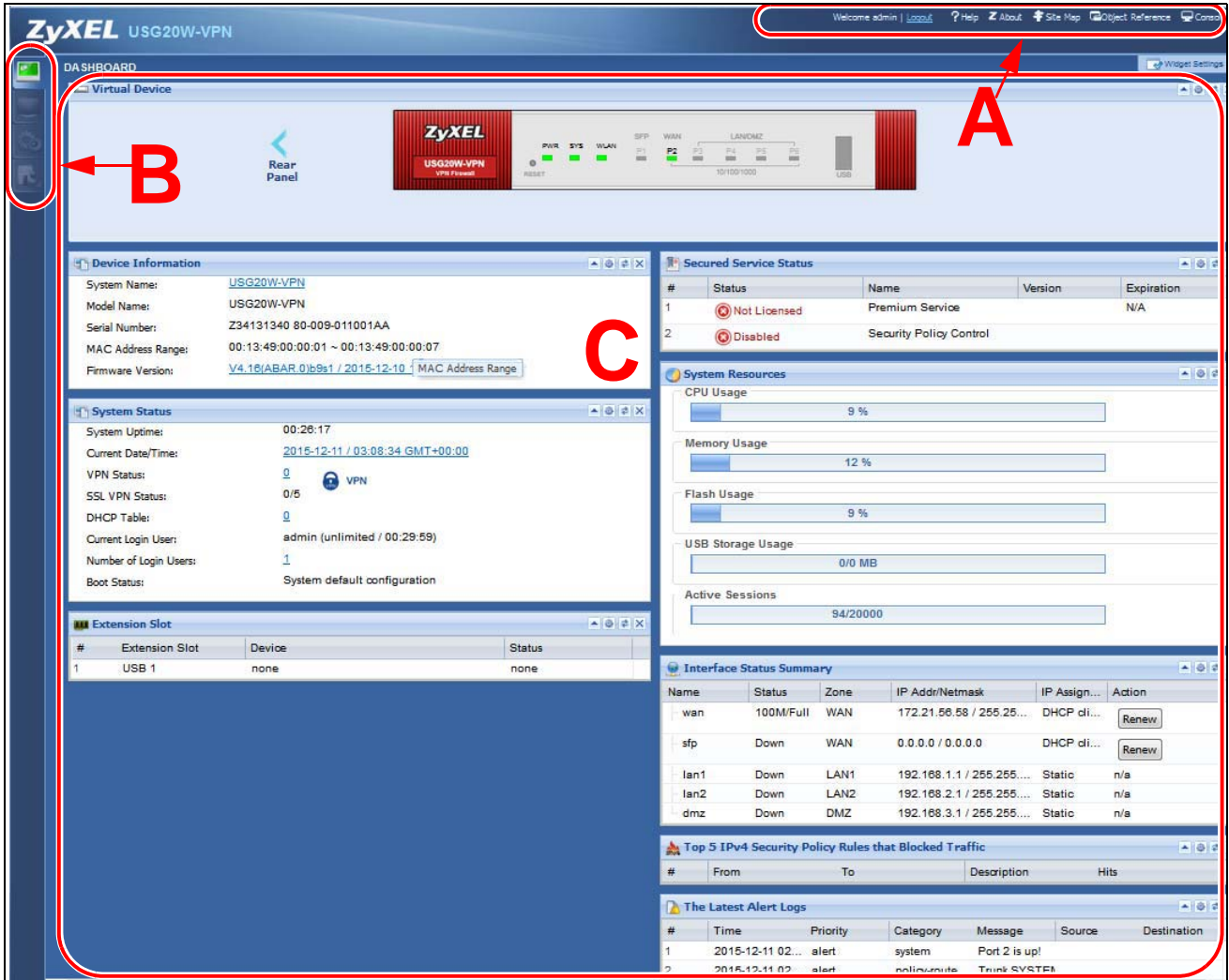

### 1.3.2 Web Configurator Screens Overview

The Web Configurator screen is divided into these parts (as illustrated on page 24):

- **A** - title bar
- **B** - navigation panel
- **C** - main window

#### Title Bar

Figure 8 Title Bar





The title bar icons in the upper right corner provide the following functions.

**Table 3** Title Bar: Web Configurator Icons

LABEL	DESCRIPTION
Logout	Click this to log out of the Web Configurator.
Help	Click this to open the help page for the current screen.
About	Click this to display basic information about the USG.
Site Map	Click this to see an overview of links to the Web Configurator screens.
Object Reference	Click this to check which configuration items reference an object.
Console	Click this to open a Java-based console window from which you can run command line interface (CLI) commands. You will be prompted to enter your user name and password. See the Command Reference Guide for information about the commands.
CLI	Click this to open a popup window that displays the CLI commands sent by the Web Configurator to the USG.

## About

Click **About** to display basic information about the USG.

**Figure 9** About



**Table 4** About

LABEL	DESCRIPTION
Current Version	This shows the firmware version of the USG.
Released Date	This shows the date (yyyy-mm-dd) and time (hh:mm:ss) when the firmware is released.
OK	Click this to close the screen.

## Site Map

Click **Site MAP** to see an overview of links to the Web Configurator screens. Click a screen's link to go to that screen.

Figure 10 Site Map



## Object Reference

Click **Object Reference** to open the **Object Reference** screen. Select the type of object and the individual object and click **Refresh** to show which configuration settings reference the object.

Figure 11 Object Reference

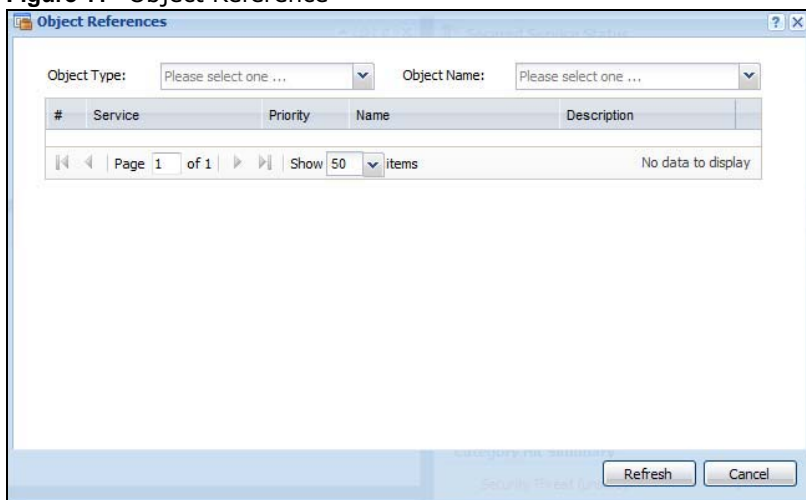

The fields vary with the type of object. This table describes labels that can appear in this screen.

Table 5 Object References

LABEL	DESCRIPTION
Object Name	This identifies the object for which the configuration settings that use it are displayed. Click the object's name to display the object's configuration screen in the main window.
#	This field is a sequential value, and it is not associated with any entry.
Service	This is the type of setting that references the selected object. Click a service's name to display the service's configuration screen in the main window.

**Table 5** Object References (continued)

LABEL	DESCRIPTION
Priority	If it is applicable, this field lists the referencing configuration item's position in its list, otherwise <b>N/A</b> displays.
Name	This field identifies the configuration item that references the object.
Description	If the referencing configuration item has a description configured, it displays here.
Refresh	Click this to update the information in this screen.
Cancel	Click <b>Cancel</b> to close the screen.

## Console

Click **Console** to open a Java-based console window from which you can run CLI commands. You will be prompted to enter your user name and password. See the Command Reference Guide for information about the commands.

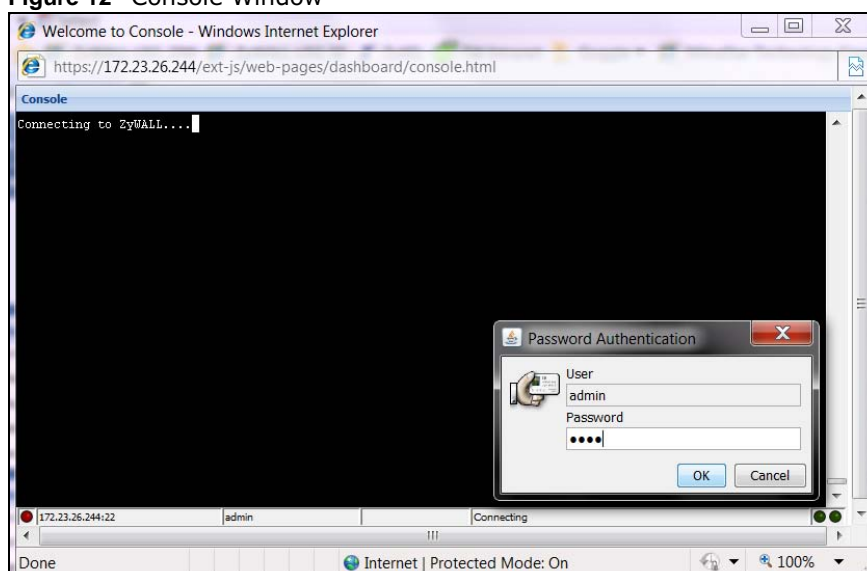
**Figure 12** Console Window

## CLI Messages

Click **CLI** to look at the CLI commands sent by the Web Configurator. Open the pop-up window and then click some menus in the web configurator to display the corresponding commands.

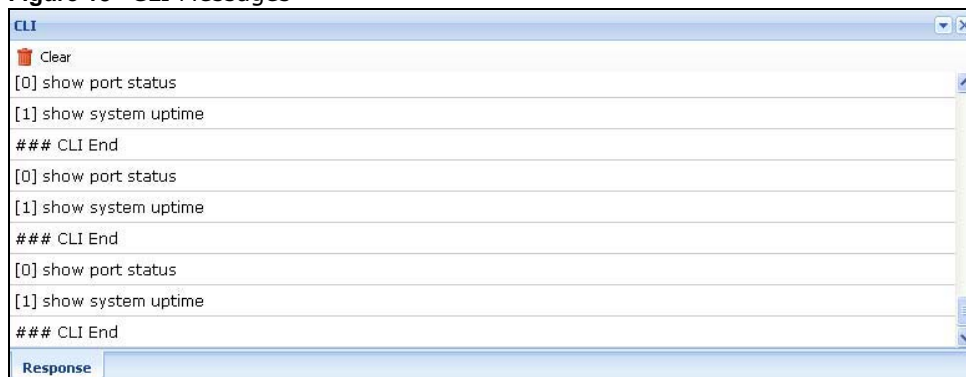
**Figure 13** CLI Messages

### 1.3.3 Navigation Panel

Use the navigation panel menu items to open status and configuration screens. Click the arrow in the middle of the right edge of the navigation panel to hide the panel or drag to resize it. The following sections introduce the USG's navigation panel menus and their screens.

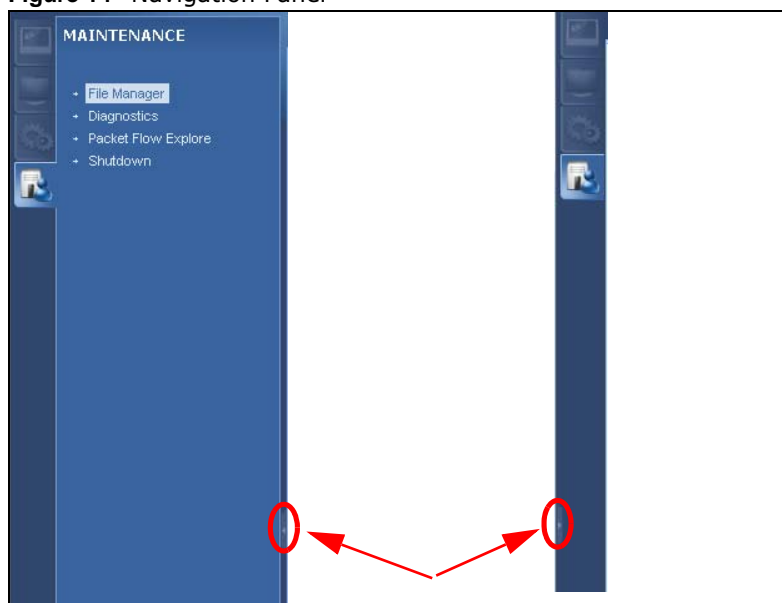
**Figure 14** Navigation Panel

### Dashboard

The dashboard displays general device information, system status, system resource usage, licensed service status, and interface status in widgets that you can re-arrange to suit your needs. See the Web Help for details on the dashboard.

## Monitor Menu

The monitor menu screens display status and statistics information.

**Table 6** Monitor Menu Screens Summary

FOLDER OR LINK	TAB	FUNCTION
System Status		
Port Statistics	Port Statistics	Displays packet statistics for each physical port.
Interface Status	Interface Summary	Displays general interface information and packet statistics.
Traffic Statistics	Traffic Statistics	Collect and display traffic statistics.
Session Monitor	Session Monitor	Displays the status of all current sessions.
IGMP Statistics	IGMP Statistics	Collect and display IGMP statistics.
DDNS Status	DDNS Status	Displays the status of the USG's DDNS domain names.
IP/MAC Binding	IP/MAC Binding	Lists the devices that have received an IP address from USG interfaces using IP/MAC binding.
Login Users	Login Users	Lists the users currently logged into the USG.
Cellular Status	Cellular Status	Displays details about the USG's mobile broadband connection status.
UPnP Port Status	Port Statistics	Displays details about UPnP connections going through the USG.
USB Storage	Storage Information	Displays details about USB device connected to the USG.
Ethernet Neighbor	Ethernet Neighbor	View and manage the USG's neighboring devices via Smart Connect (Layer Link Discovery Protocol (LLDP)). Use the ZyXEL One Network (ZON) utility to view and manage the USG's neighboring devices via the ZyXEL Discovery Protocol (ZDP).
Wireless		
AP Information	WLAN Setting	Edit wireless AP information, remove APs, and reboot them.
DCS		Configure dynamic wireless channel selection.
VPN Monitor		
IPSec	IPSec	Displays and manages the active IPSec SAs.
SSL	SSL	Lists users currently logged into the VPN SSL client portal. You can also log out individual users and delete related session information.
L2TP over IPSec	Session Monitor	Displays details about current L2TP sessions.
UTM Statistics		
Content Filter	Report	Collect and display content filter statistics
Anti-Spam	Report	Collect and display spam statistics.
	Status	Displays how many mail sessions the USG is currently checking and DNSBL (Domain Name Service-based spam Black List) statistics.
Log	View Log	Lists log entries.
	View AP Log	Lists AP log entries.

## Configuration Menu

Use the configuration menu screens to configure the USG's features.

**Table 7** Configuration Menu Screens Summary

FOLDER OR LINK	TAB	FUNCTION
Quick Setup		Quickly configure WAN interfaces or VPN connections.
Licensing		
Registration	Registration	Register the device and activate trial services.
	Service	View the licensed service status and upgrade licensed services.
Wireless		
AP Management	WLAN Setting	Configuration the USG's general wireless settings.
DCS		Configure dynamic wireless channel selection.
Network		
Interface	Port Role	Use this screen to set the USG's flexible ports such as LAN, OPT, WLAN, or DMZ.
	Ethernet	Manage Ethernet interfaces and virtual Ethernet interfaces.
	PPP	Create and manage PPPoE and PPTP interfaces.
	Cellular	Configure a cellular Internet connection for an installed mobile broadband card.
	Tunnel	Configure tunneling between IPv4 and IPv6 networks.
	VLAN	Create and manage VLAN interfaces and virtual VLAN interfaces.
	Bridge	Create and manage bridges and virtual bridge interfaces.
	Trunk	Create and manage trunks (groups of interfaces) for load balancing.
Routing	Policy Route	Create and manage routing policies.
	Static Route	Create and manage IP static routing information.
	RIP	Configure device-level RIP settings.
	OSPF	Configure device-level OSPF settings, including areas and virtual links.
DDNS	DDNS	Define and manage the USG's DDNS domain names.
NAT	NAT	Set up and manage port forwarding rules.
HTTP Redirect	HTTP Redirect	Set up and manage HTTP redirection rules.
ALG	ALG	Configure SIP, H.323, and FTP pass-through settings.
UPnP	UPnP	Configure interfaces that allow UPnP and NAT-PMP connections.
IP/MAC Binding	Summary	Configure IP to MAC address bindings for devices connected to each supported interface.
	Exempt List	Configure ranges of IP addresses to which the USG does not apply IP/MAC binding.
Layer 2 Isolation	General	Enable layer-2 isolation on the USG and the internal interface(s).
	White List	Enable and configure the white list.
DNS Inbound LB	DNS Load Balancing	Configure DNS Load Balancing.
Web Authentication	Web Authentication	Define a web portal and exempt services from authentication.
	SSO	Configure the USG to work with a Single Sign On agent.
Security Policy		

**Table 7** Configuration Menu Screens Summary (continued)

FOLDER OR LINK	TAB	FUNCTION
Policy Control	Policy	Create and manage level-3 traffic rules and apply UTM profiles.
Session Control	Session Control	Limit the number of concurrent client NAT/security policy sessions.
VPN		
IPSec VPN	VPN Connection	Configure IPSec tunnels.
	VPN Gateway	Configure IKE tunnels.
	Concentrator	Combine IPSec VPN connections into a single secure network
	Configuration Provisioning	Set who can retrieve VPN rule settings from the USG using the USG IPSec VPN Client.
SSL VPN	Access Privilege	Configure SSL VPN access rights for users and groups.
	Global Setting	Configure the USG's SSL VPN settings that apply to all connections.
	SecuExtender	Check for the latest version of the SecuExtender VPN client.
L2TP VPN	L2TP VPN	Configure L2TP over IPSec tunnels.
BWM	BWM	Enable and configure bandwidth management rules.
UTM Profile		
Content Filter	Profile	Create and manage the detailed filtering rules for content filtering profiles and then apply to a traffic flow using a security policy.
	Trusted Web Sites	Create a list of allowed web sites that bypass content filtering policies.
	Forbidden Web Sites	Create a list of web sites to block regardless of content filtering policies.
Anti-Spam	Profile	Turn anti-spam on or off and manage anti-spam policies. Create anti-spam template(s) of settings to apply to a traffic flow using a security policy.
	Mail Scan	Configure e-mail scanning details.
	Black/White List	Set up a black list to identify spam and a white list to identify legitimate e-mail.
	DNSBL	Have the USG check e-mail against DNS Black Lists.
Object		
Zone	Zone	Configure zone template(s) used to define various policies.
User/Group	User	Create and manage users.
	Group	Create and manage groups of users.
	Setting	Manage default settings for all users, general settings for user sessions, and rules to force user authentication.
	MAC Address	Configure the MAC addresses or OUI (Organizationally Unique Identifier) of wireless clients for MAC authentication using the local user database.
AP Profile	Radio	Create template(s) of radio settings to apply to policies as an object.
	SSID	Create template(s) of wireless settings to apply to radio profiles or policies as an object.
MON Profile	MON Profile	Create and manage rogue AP monitoring files that can be associated with different APs.
Address	Address	Create and manage host, range, and network (subnet) addresses.
	Address Group	Create and manage groups of addresses to apply to policies as a single objects.

**Table 7** Configuration Menu Screens Summary (continued)

FOLDER OR LINK	TAB	FUNCTION
Service	Service	Create and manage TCP and UDP services.
	Service Group	Create and manage groups of services to apply to policies as a single object.
Schedule	Schedule	Create one-time and recurring schedules.
	Schedule Group	Create and manage groups of schedules to apply to policies as a single object.
AAA Server	Active Directory	Configure the Active Directory settings.
	LDAP	Configure the LDAP settings.
	RADIUS	Configure the RADIUS settings.
Auth. Method	Authentication Method	Create and manage ways of authenticating users.
Certificate	My Certificates	Create and manage the USG's certificates.
	Trusted Certificates	Import and manage certificates from trusted sources.
ISP Account	ISP Account	Create and manage ISP account information for PPPoE/PPTP interfaces.
SSL Application	SSL Application	Create SSL web application or file sharing objects to apply to policies.
DHCPv6	Request	Configure IPv6 DHCP request type and interface information.
	Lease	Configure IPv6 DHCP lease type and interface information.
System		
Host Name	Host Name	Configure the system and domain name for the USG.
USB Storage	Settings	Configure the settings for the connected USB devices.
Date/Time	Date/Time	Configure the current date, time, and time zone in the USG.
Console Speed	Console Speed	Set the console speed.
DNS	DNS	Configure the DNS server and address records for the USG.
WWW	Service Control	Configure HTTP, HTTPS, and general authentication.
	Login Page	Configure how the login and access user screens look.
SSH	SSH	Configure SSH server and SSH service settings.
TELNET	TELNET	Configure telnet server settings for the USG.
FTP	FTP	Configure FTP server settings.
SNMP	SNMP	Configure SNMP communities and services.
Auth. Server	Auth. Server	Configure the USG to act as a RADIUS server.
CloudCNM	CloudCNM	Enable and configure management of the USG by a Central Network Management system.
Language	Language	Select the Web Configurator language.
IPv6	IPv6	Enable IPv6 globally on the USG here.
ZON	ZON	Use the ZyXEL One Network (ZON) utility to view and manage the USG's neighboring devices via the ZyXEL Discovery Protocol (ZDP).
Log & Report		
Email Daily Report	Email Daily Report	Configure where and how to send daily reports and what reports to send.
Log Settings	Log Settings	Configure the system log, e-mail logs, and remote syslog servers.



## Maintenance Menu

Use the maintenance menu screens to manage configuration and firmware files, run diagnostics, and reboot or shut down the USG.

**Table 8** Maintenance Menu Screens Summary

FOLDER OR LINK	TAB	FUNCTION
File Manager	Configuration File	Manage and upload configuration files for the USG.
	Firmware Package	View the current firmware version and upload firmware. Reboot with your choice of firmware.
	Shell Script	Manage and run shell script files for the USG.
Diagnostics	Diagnostic	Collect diagnostic information.
	Packet Capture	Capture packets for analysis.
	Core Dump	Connect a USB device to the USG and save the USG operating system kernel to it here.
	System Log	Connect a USB device to the USG and archive the USG system logs to it here.
	Network Tool	Identify problems with the connections. You can use Ping or TraceRoute to help you identify problems.
	Wireless Frame Capture	Capture wireless frames from APs for analysis.
Packet Flow Explore	Routing Status	Check how the USG determines where to route a packet.
	SNAT Status	View a clear picture on how the USG converts a packet's source IP address and check the related settings.
Shutdown	Shutdown	Turn off the USG.

### 1.3.4 Tables and Lists

Web Configurator tables and lists are flexible with several options for how to display their entries.

Click a column heading to sort the table's entries according to that column's criteria.

**Figure 15** Sorting Table Entries by a Column's Criteria

#	User Name	Description
4	ad-users	External AD Users
1	admin	Administration account

Click the down arrow next to a column heading for more options about how to display the entries. The options available vary depending on the type of fields in the column. Here are some examples of what you can do:

- Sort in ascending or descending (reverse) alphabetical order
- Select which columns to display
- Group entries by field
- Show entries in groups
- Filter by mathematical operators (<, >, or =) or searching for text

**Figure 16** Common Table Column Options

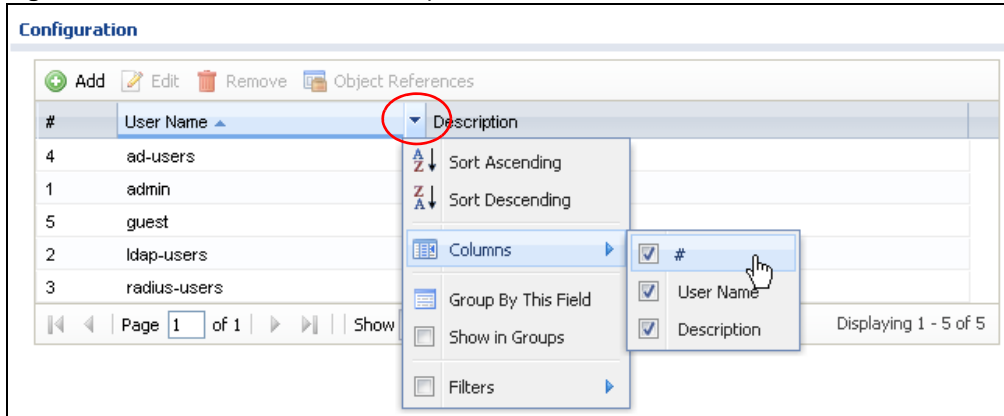

Select a column heading cell's right border and drag to re-size the column.

**Figure 17** Resizing a Table Column

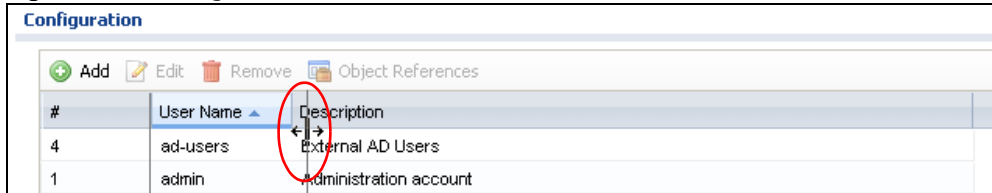

Select a column heading and drag and drop it to change the column order. A green check mark displays next to the column's title when you drag the column to a valid new location.

**Figure 18** Moving Columns

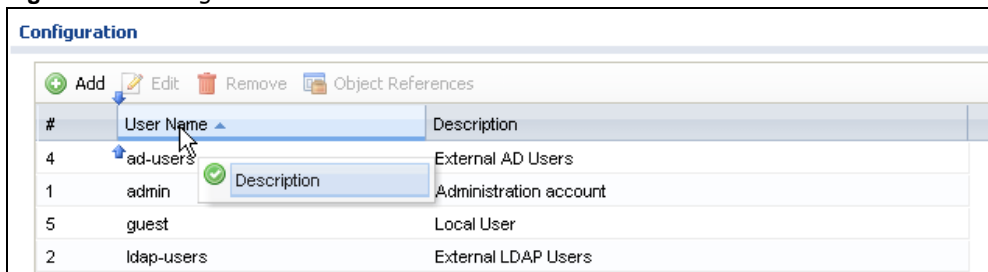

Use the icons and fields at the bottom of the table to navigate to different pages of entries and control how many entries display at a time.

**Figure 19** Navigating Pages of Table Entries

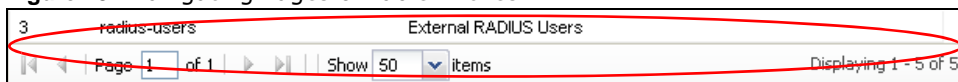

The tables have icons for working with table entries. You can often use the [Shift] or [Ctrl] key to select multiple entries to remove, activate, or deactivate.

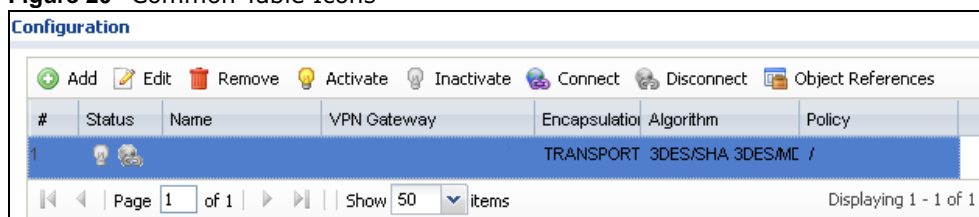
**Figure 20** Common Table Icons

Here are descriptions for the most common table icons.

**Table 9** Common Table Icons

LABEL	DESCRIPTION
Add	Click this to create a new entry. For features where the entry's position in the numbered list is important (features where the USG applies the table's entries in order like the security policy for example), you can select an entry and click <b>Add</b> to create a new entry after the selected entry.
Edit	Double-click an entry or select it and click <b>Edit</b> to open a screen where you can modify the entry's settings. In some tables you can just click a table entry and edit it directly in the table. For those types of tables small red triangles display for table entries with changes that you have not yet applied.
Remove	To remove an entry, select it and click <b>Remove</b> . The USG confirms you want to remove it before doing so.
Activate	To turn on an entry, select it and click <b>Activate</b> .
Inactivate	To turn off an entry, select it and click <b>Inactivate</b> .
Connect	To connect an entry, select it and click <b>Connect</b> .
Disconnect	To disconnect an entry, select it and click <b>Disconnect</b> .
Object References	Select an entry and click <b>Object References</b> to check which settings use the entry.
Move	To change an entry's position in a numbered list, select it and click <b>Move</b> to display a field to type a number for where you want to put that entry and press [ENTER] to move the entry to the number that you typed. For example, if you type 6, the entry you are moving becomes number 6 and the previous entry 6 (if there is one) gets pushed up (or down) one.

## Working with Lists

When a list of available entries displays next to a list of selected entries, you can often just double-click an entry to move it from one list to the other. In some lists you can also use the [Shift] or [Ctrl] key to select multiple entries, and then use the arrow button to move them to the other list.

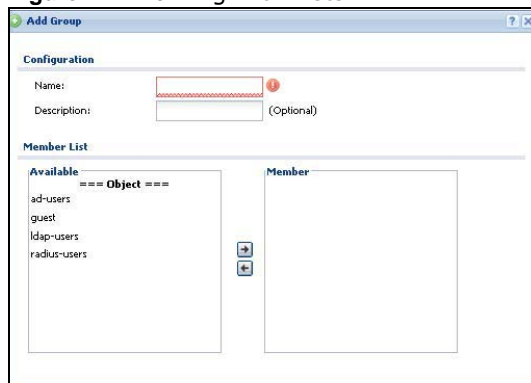
**Figure 21** Working with Lists

## Installation Setup Wizard

### 2.1 Installation Setup Wizard Screens

When you log into the Web Configurator for the first time or when you reset the USG to its default configuration, the **Installation Setup Wizard** screen displays. This wizard helps you configure Internet connection settings and activate subscription services. This chapter provides information on configuring the Web Configurator's installation setup wizard. See the feature-specific chapters in this User's Guide for background information.

**Figure 22** Installation Setup Wizard

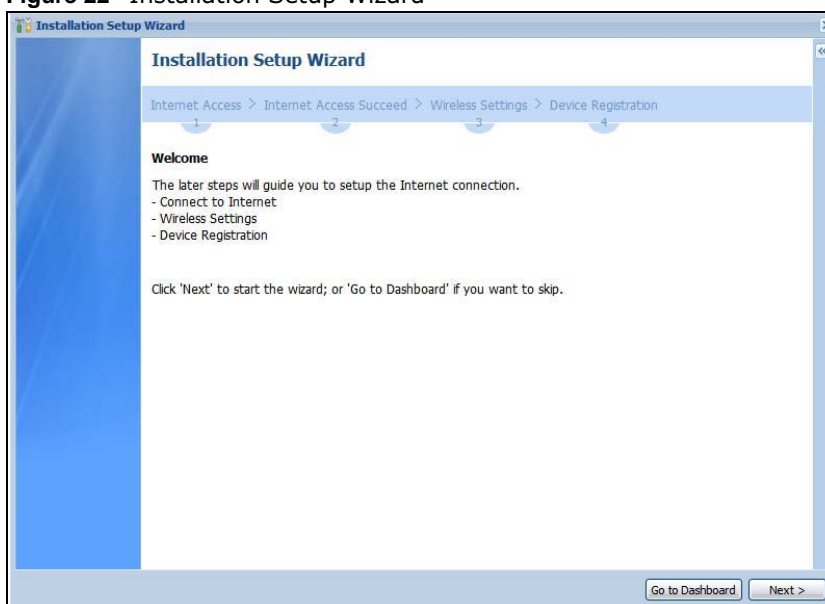

- Click the double arrow in the upper right corner to display or hide the help.
- Click **Go to Dashboard** to skip the installation setup wizard or click **Next** to start configuring for Internet access.

#### 2.1.1 Internet Access Setup - WAN Interface

Use this screen to set how many WAN interfaces to configure and the first WAN interface's type of encapsulation and method of IP address assignment.

The screens vary depending on the encapsulation type. Refer to information provided by your ISP to know what to enter in each field. Leave a field blank if you don't have that information.

**Note:** Enter the Internet access information exactly as your ISP gave it to you.

Figure 23 Internet Access: Step 1

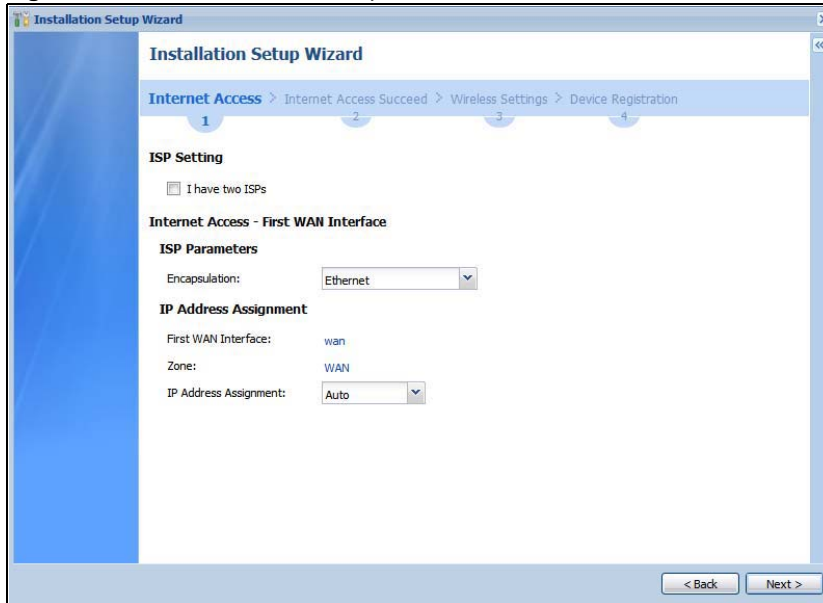

- **I have two ISPs:** Select this option to configure two Internet connections. Leave it cleared to configure just one. This option appears when you are configuring the first WAN interface.
- **Encapsulation:** Choose the **Ethernet** option when the WAN port is used as a regular Ethernet. Otherwise, choose **PPPoE** or **PPTP** for a dial-up connection according to the information from your ISP.
- **WAN Interface:** This is the interface you are configuring for Internet access.
- **Zone:** This is the security zone to which this interface and Internet connection belong.
- **IP Address Assignment:** Select **Auto** if your ISP did not assign you a fixed IP address. Select **Static** if the ISP assigned a fixed IP address.

### 2.1.2 Internet Access: Ethernet

This screen is read-only if you set the previous screen's **IP Address Assignment** field to **Auto**. If you set the previous screen's **IP Address Assignment** field to **Static**, use this screen to configure your IP address settings.

Note: Enter the Internet access information exactly as given to you by your ISP or network administrator.

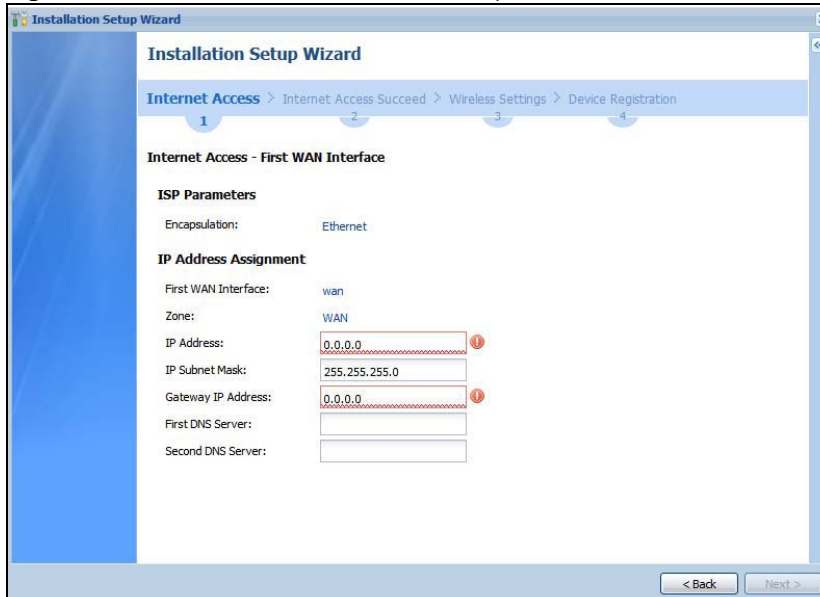
**Figure 24** Internet Access: Ethernet Encapsulation

- **Encapsulation:** This displays the type of Internet connection you are configuring.
- **First WAN Interface:** This is the number of the interface that will connect with your ISP.
- **Zone:** This is the security zone to which this interface and Internet connection will belong.
- **IP Address:** Enter your (static) public IP address. **Auto** displays if you selected **Auto** as the **IP Address Assignment** in the previous screen.

The following fields display if you selected static IP address assignment.

- **IP Subnet Mask:** Enter the subnet mask for this WAN connection's IP address.
- **Gateway IP Address:** Enter the IP address of the router through which this WAN connection will send traffic (the default gateway).
- **First / Second DNS Server:** These fields display if you selected static IP address assignment. The Domain Name System (DNS) maps a domain name to an IP address and vice versa. Enter a DNS server's IP address(es). The DNS server is extremely important because without it, you must know the IP address of a computer before you can access it. The USG uses these (in the order you specify here) to resolve domain names for VPN, DDNS and the time server. Leave the field as 0.0.0.0 if you do not want to configure DNS servers.

### 2.1.3 Internet Access: PPPoE

Note: Enter the Internet access information exactly as given to you by your ISP.

Figure 25 Internet Access: PPPoE Encapsulation

### 2.1.3.1 ISP Parameters

- Type the PPPoE **Service Name** from your service provider. PPPoE uses a service name to identify and reach the PPPoE server. You can use alphanumeric and `-_@$./` characters, and it can be up to 64 characters long.
- **Authentication Type** - Select an authentication protocol for outgoing connection requests. Options are:
  - **CHAP/PAP** - Your USG accepts either CHAP or PAP when requested by the remote node.
  - **CHAP** - Your USG accepts CHAP only.
  - **PAP** - Your USG accepts PAP only.
  - **MSCHAP** - Your USG accepts MSCHAP only.
  - **MSCHAP-V2** - Your USG accepts MSCHAP-V2 only.
- Type the **User Name** given to you by your ISP. You can use alphanumeric and `-_@$./` characters, and it can be up to 31 characters long.
- Type the **Password** associated with the user name. Use up to 64 ASCII characters except the `[]` and `?`. This field can be blank.
- Select **Nailed-Up** if you do not want the connection to time out. Otherwise, type the **Idle Timeout** in seconds that elapses before the router automatically disconnects from the PPPoE server.

### 2.1.3.2 WAN IP Address Assignments

- **WAN Interface:** This is the name of the interface that will connect with your ISP.
- **Zone:** This is the security zone to which this interface and Internet connection will belong.
- **IP Address:** Enter your (static) public IP address. **Auto** displays if you selected **Auto** as the **IP Address Assignment** in the previous screen.

- **First / Second DNS Server:** These fields display if you selected static IP address assignment. The Domain Name System (DNS) maps a domain name to an IP address and vice versa. Enter a DNS server's IP address(es). The DNS server is extremely important because without it, you must know the IP address of a computer before you can access it. The USG uses these (in the order you specify here) to resolve domain names for VPN, DDNS and the time server. Leave the field as 0.0.0.0 if you do not want to configure DNS servers. If you do not configure a DNS server, you must know the IP address of a machine in order to access it.

## 2.1.4 Internet Access: PPTP

Note: Enter the Internet access information exactly as given to you by your ISP.

Figure 26 Internet Access: PPTP Encapsulation

### 2.1.4.1 ISP Parameters

- **Authentication Type** - Select an authentication protocol for outgoing calls. Options are:
  - **CHAP/PAP** - Your USG accepts either CHAP or PAP when requested by the remote node.
  - **CHAP** - Your USG accepts CHAP only.
  - **PAP** - Your USG accepts PAP only.
  - **MSCHAP** - Your USG accepts MSCHAP only.
  - **MSCHAP-V2** - Your USG accepts MSCHAP-V2 only.
- Type the **User Name** given to you by your ISP. You can use alphanumeric and -\_@\$. / characters, and it can be up to 31 characters long.
- Type the **Password** associated with the user name. Use up to 64 ASCII characters except the [ ] and ?. This field can be blank. Re-type your password in the next field to confirm it.
- Select **Nailed-Up** if you do not want the connection to time out. Otherwise, type the **Idle Timeout** in seconds that elapses before the router automatically disconnects from the PPTP server.



### 2.1.4.2 PPTP Configuration

- **Base Interface:** This identifies the Ethernet interface you configure to connect with a modem or router.
- Type a **Base IP Address** (static) assigned to you by your ISP.
- Type the **IP Subnet Mask** assigned to you by your ISP (if given).
- **Server IP:** Type the IP address of the PPTP server.
- Type a **Connection ID** or connection name. It must follow the "c:id" and "n:name" format. For example, C:12 or N:My ISP. This field is optional and depends on the requirements of your broadband modem or router. You can use alphanumeric and -\_ : characters, and it can be up to 31 characters long.

### 2.1.4.3 WAN IP Address Assignments

- **First WAN Interface:** This is the connection type on the interface you are configuring to connect with your ISP.
- **Zone** This is the security zone to which this interface and Internet connection will belong.
- **IP Address:** Enter your (static) public IP address. Auto displays if you selected **Auto** as the **IP Address Assignment** in the previous screen.
- **First / Second DNS Server:** These fields display if you selected static IP address assignment. The Domain Name System (DNS) maps a domain name to an IP address and vice versa. Enter a DNS server's IP address(es). The DNS server is extremely important because without it, you must know the IP address of a computer before you can access it. The USG uses these (in the order you specify here) to resolve domain names for VPN, DDNS and the time server. Leave the field as 0.0.0.0 if you do not want to configure DNS servers.

## 2.1.5 Internet Access Setup - Second WAN Interface

If you selected **I have two ISPs**, after you configure the **First WAN Interface**, you can configure the **Second WAN Interface**. The screens for configuring the second WAN interface are similar to the first (see [Section 2.1.1 on page 36](#)).

**Figure 27** Internet Access: Step 3: Second WAN Interface

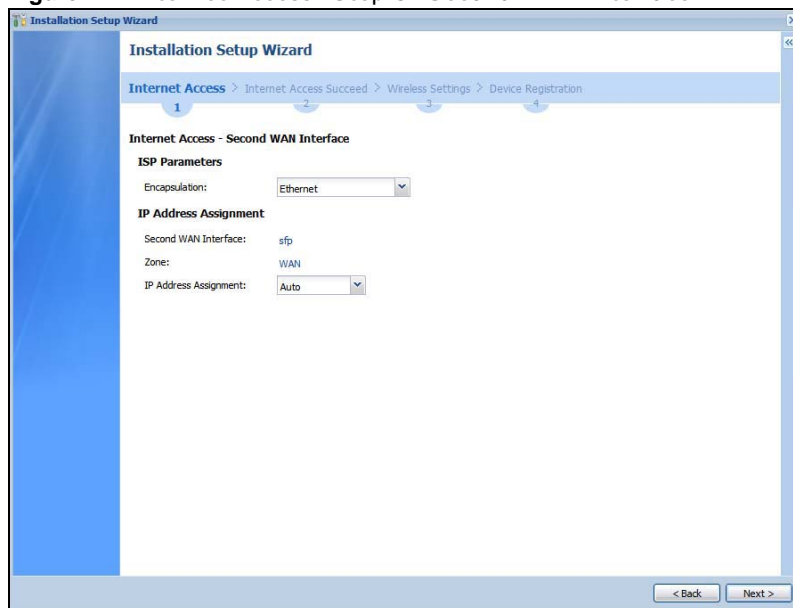

## 2.1.6 Internet Access Succeed

This screen shows your Internet access settings that have been applied successfully.

**Figure 28** Internet Access Succeed

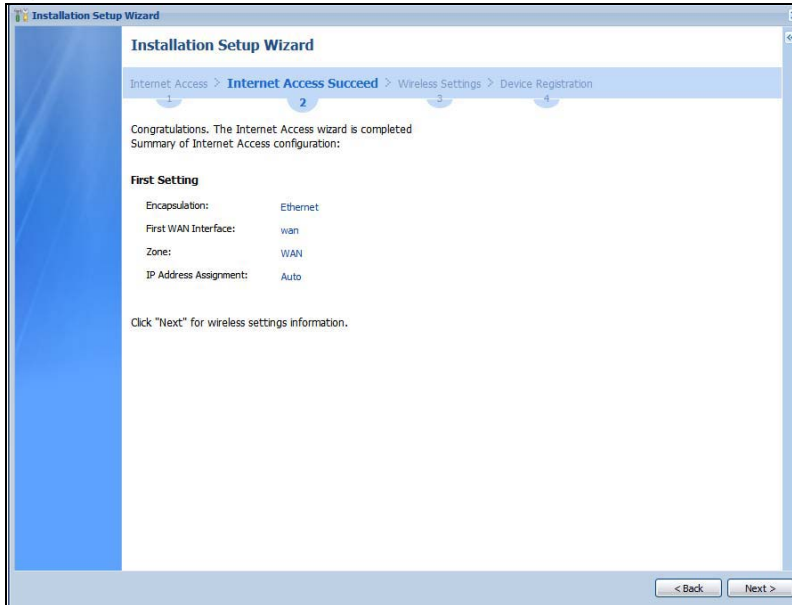

## 2.1.7 Wireless Settings: SSID & Security

Configure SSID and wireless security in this screen.

**Figure 29** Wireless Settings: SSID & Security

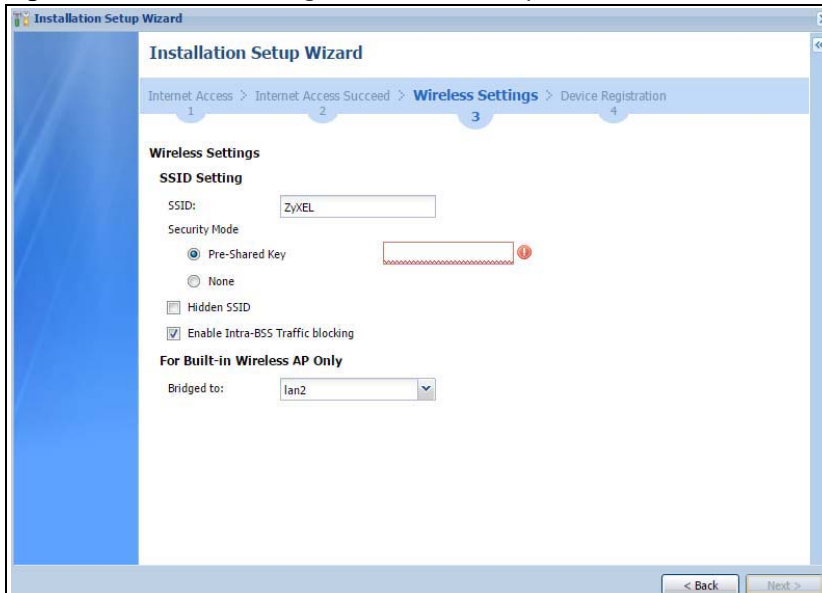

## SSID Setting

- **SSID** - Enter a descriptive name of up to 32 printable characters for the wireless LAN.
- **Security Mode** - Select **Pre-Shared Key** to add security on this wireless network. Otherwise, select **None** to allow any wireless client to associate this network without authentication.
- **Pre-Shared Key** - Enter a pre-shared key of between 8 and 63 case-sensitive ASCII characters (including spaces and symbols) or 64 hexadecimal characters.
- **Hidden SSID** - Select this option if you want to hide the SSID in the outgoing beacon frame. A wireless client then cannot obtain the SSID through scanning using a site survey tool.
- **Enable Intra-BSS Traffic Blocking** - Select this option if you want to prevent crossover traffic from within the same SSID. Wireless clients can still access the wired network but cannot communicate with each other.

## For Built-in Wireless AP Only

- **Bridged to:** USGs with W in the model name have a built-in AP. Select an interface to bridge with the built-in AP wireless network. Devices connected to this interface will then be in the same broadcast domain as devices in the AP wireless network.

## 2.1.8 Internet Access - Device Registration

Click the link in this screen to register your device at [portal.myzyxel.com](http://portal.myzyxel.com).

Note: The USG must be connected to the Internet in order to register.

**Figure 30** Internet Access: Device Registration

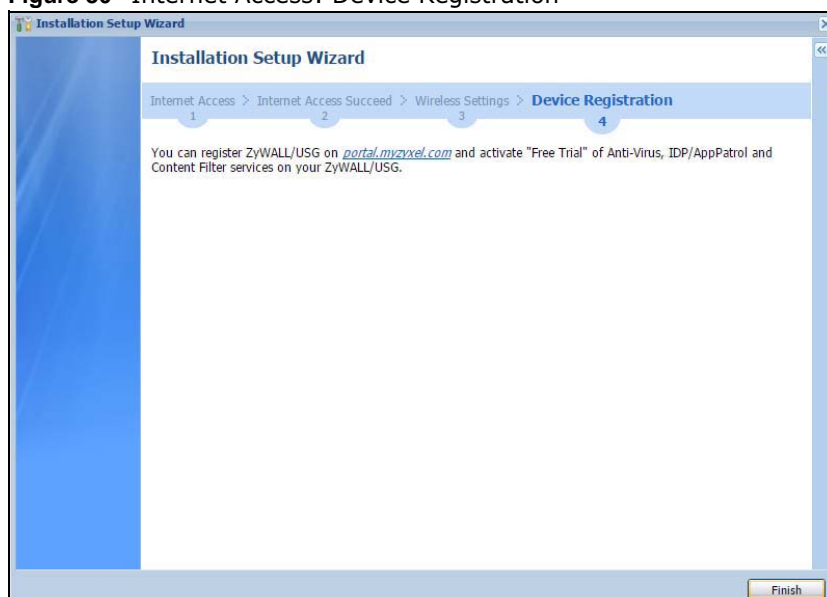

You will need the USG's serial number and LAN MAC address to register it if you have not already done so. Use the **Configuration > Licensing > Registration > Service** screen to update your service subscription status.

## Hardware, Interfaces and Zones

### 3.1 Hardware Overview

USG20-VPN and USG20W-VPN have different housings.

#### 3.1.1 Front Panels

The LED indicators are located on the front panel.

**Figure 31** USG20-VPN Front Panel

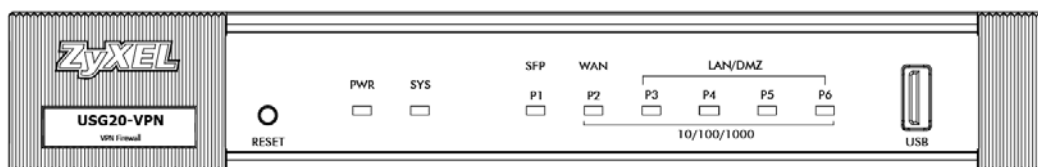

**Figure 32** USG20W-VPN Front Panel

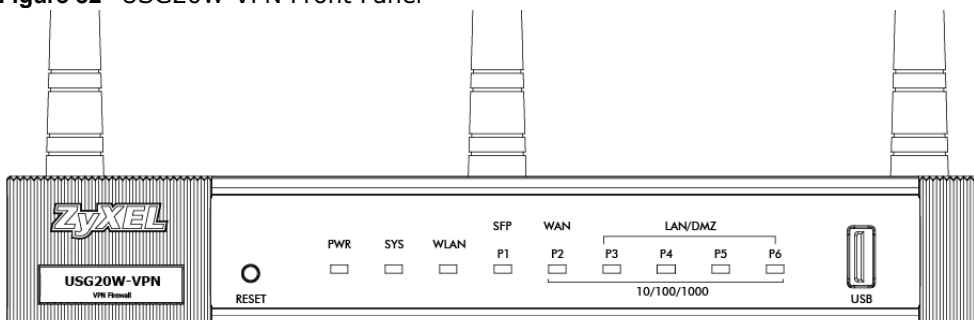

The following table describes the LEDs.

**Table 10** LED Descriptions

LED	COLOR	STATUS	DESCRIPTION
PWR		Off	The USG is turned off.
	Green	On	The USG is turned on.
	Red	On	There is a hardware component failure. Shut down the device, wait for a few minutes and then restart the device (see <a href="#">Section 3.1.3 on page 46</a> ). If the LED turns red again, then please contact your vendor.
SYS	Green	Off	The USG is not ready or has failed.
		On	The USG is ready and running.
		Blinking	The USG is booting.
	Red	On	The USG had an error or has failed.

**Table 10** LED Descriptions (continued)

LED	COLOR	STATUS	DESCRIPTION
WLAN	Green	Off	The built-in wireless LAN card is not ready or has failed.
		On	The built-in wireless LAN card is ready.
		Blinking	The built-in wireless LAN card is sending or receiving packets.
P1, P2...	Green	Off	There is no traffic on this port.
		On	This port has a successful 10/100 Mbps connection.
		Blinking	The USG is sending or receiving packets on this port with a 10/100 Mbps connection.
	Yellow	Off	There is no connection on this port.
		On	This port has a successful 1000 Mbps connection.
		Blinking	The device is sending or receiving packets on this port with a 1000 Mbps connection.

### 3.1.2 Rear Panels

The connection ports are located on the rear panel.

**Figure 33** USG20-VPN Rear Panel



**Figure 34** USG20W-VPN Rear Panel

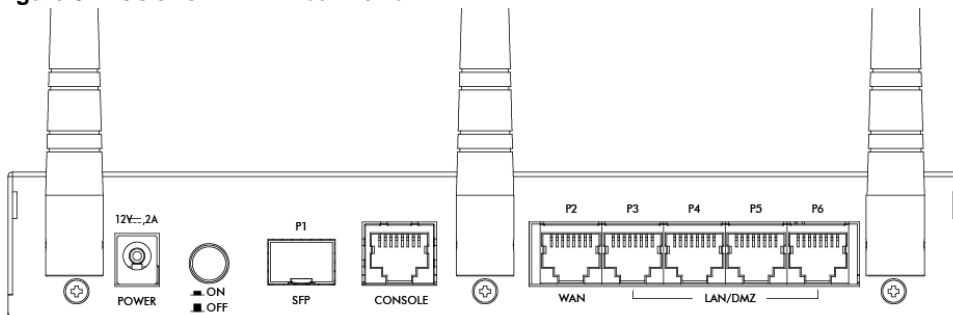

The following table describes the items on the rear panel

**Table 11** Rear Panel Items

LABEL	DESCRIPTION
Power	Use the included power cord to connect the power socket to a power outlet. Turn the power switch on if your USG has a power switch.

**Table 11** Rear Panel Items (continued)

LABEL	DESCRIPTION
WAN/LAN/DMZ/ (Gigabit SFP/ Ethernet Port)	P1- You have to install an SFP (Small Form-factor Pluggable) transceiver and connect fiber optic cables to it for using a 1Gbps/100Mbps WAN connection.  P2~P6 - Connect an Ethernet cable to the port for using a 1Gbps WAN/LAN/DMZ connection.
Console	You can use the console port to manage the USG using CLI commands. You will be prompted to enter your user name and password. See the Command Reference Guide for more information about the CLI.  When configuring using the console port, you need a computer equipped with communications software configured to the following parameters: <ul style="list-style-type: none"> <li>• Speed 115200 bps</li> <li>• Data Bits 8</li> <li>• Parity None</li> <li>• Stop Bit 1</li> <li>• Flow Control Off</li> </ul>

Note: Use an 8-wire Ethernet cable to run your Gigabit Ethernet connection at 1000 Mbps. Using a 4-wire Ethernet cable limits your connection to 100 Mbps. Note that the connection speed also depends on what the Ethernet device at the other end can support.

### 3.1.3 Wall-mounting

Both USG20-VPN and USG20W-VPN can be mounted on a wall.

- 1 Drill two holes 3 mm ~ 4 mm (0.12" ~ 0.16") wide, 20 mm ~ 30 mm (0.79" ~ 1.18") deep and 150 mm apart, into a wall. Place two screw anchors in the holes.
- 2 Screw two screws with 6 mm ~ 8 mm (0.24" ~ 0.31") wide heads into the screw anchors. Do not screw the screws all the way in to the wall; leave a small gap between the head of the screw and the wall.

The gap must be big enough for the screw heads to slide into the screw slots and the connection cables to run down the back of the USG.

Note: Make sure the screws are securely fixed to the wall and strong enough to hold the weight of the USG with the connection cables.

- 3 Use the holes on the bottom of the USG to hang the USG on the screws.

**Wall-mount the USG horizontally. The USG's side panels with ventilation slots should not be facing up or down as this position is less safe.**

Figure 35 Wall Mounting

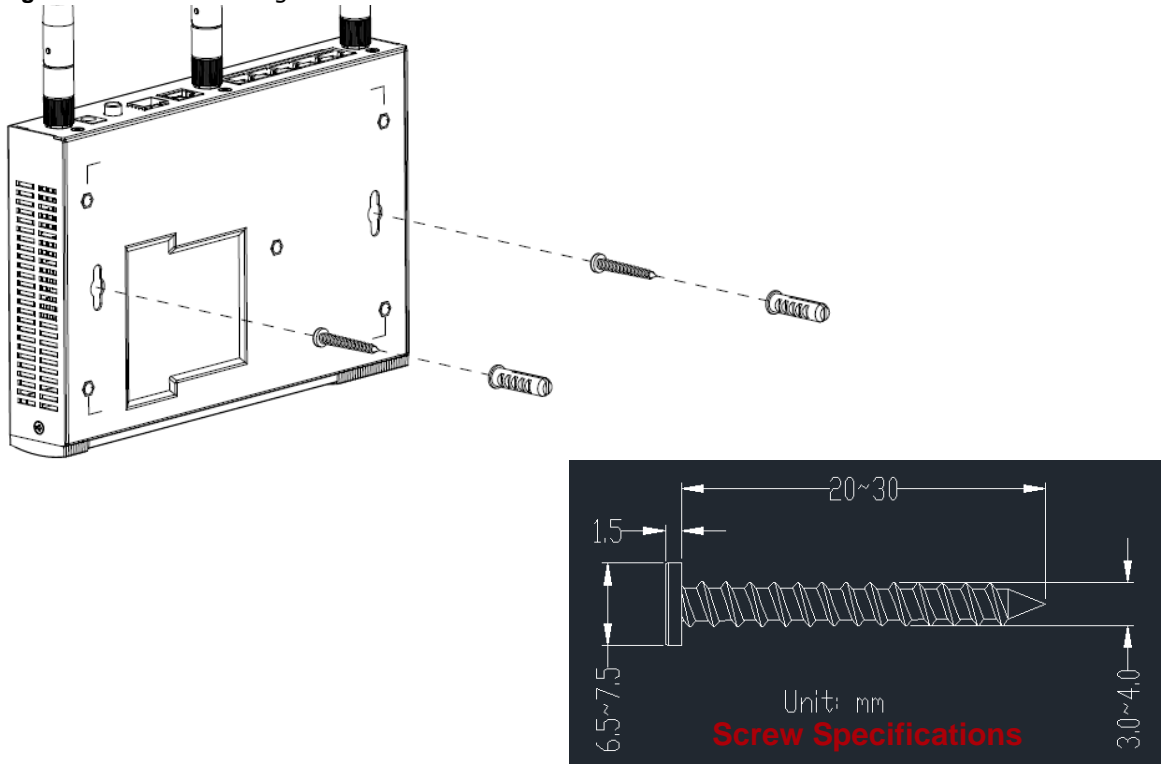

## 3.2 Default Zones, Interfaces, and Ports

The default configurations for zones, interfaces, and ports are as follows. References to interfaces may be generic rather than the specific name used in your model. For example, this guide may use “the WAN interface” rather than “wan1” or “wan2”.

The following table shows the default physical port and interface mapping for each model at the time of writing.

**Table 12** Default Physical Port - Interface Mapping

PORT / INTERFACE	P1	P2	P3	P4	P5	P6
• USG20-VPN	sfp	wan	lan1	lan1	lan1	lan1
• USG20W-VPN	sfp	wan	lan1	lan1	lan1	lan1

The following table shows the default interface and zone mapping for each model at the time of writing.

**Table 13** Default Zone - Interface Mapping

ZONE / INTERFACE	WAN	LAN1	LAN2	DMZ
• USG20-VPN	WAN WAN_PPP SFP SFP_PPP	LAN1	LAN2	DMZ
• USG20W-VPN	WAN WAN_PPP SFP SFP_PPP	LAN1	LAN2	DMZ

### 3.3 Stopping the USG

Always use **Maintenance > Shutdown > Shutdown** or the `shutdown` command before you turn off the USG or remove the power. Not doing so can cause the firmware to become corrupt.



## Quick Setup Wizards

### 4.1 Quick Setup Overview

The Web Configurator's quick setup wizards help you configure Internet and VPN connection settings. This chapter provides information on configuring the quick setup screens in the Web Configurator. See the feature-specific chapters in this User's Guide for background information.

In the Web Configurator, click **Configuration > Quick Setup** to open the first **Quick Setup** screen.

**Figure 36** Quick Setup



- **WAN Interface**

Click this link to open a wizard to set up a WAN (Internet) connection. This wizard creates matching ISP account settings in the USG if you use PPPoE or PPTP. See [Section 4.2 on page 50](#).

- **VPN SETUP**

Use **VPN Setup** to configure a VPN (Virtual Private Network) rule for a secure connection to another computer or network. Use **VPN Settings for Configuration Provisioning** to set up a VPN rule that can be retrieved with the USG IPsec VPN Client. You only need to enter a user name, password and the IP address of the USG in the IPsec VPN Client to get all VPN settings automatically from the USG. See [Section 4.3 on page 55](#). Use **VPN Settings for L2TP VPN Settings** to configure the L2TP VPN for clients.

- Wizard Help

If the help does not automatically display when you run the wizard, click the arrow to display it.

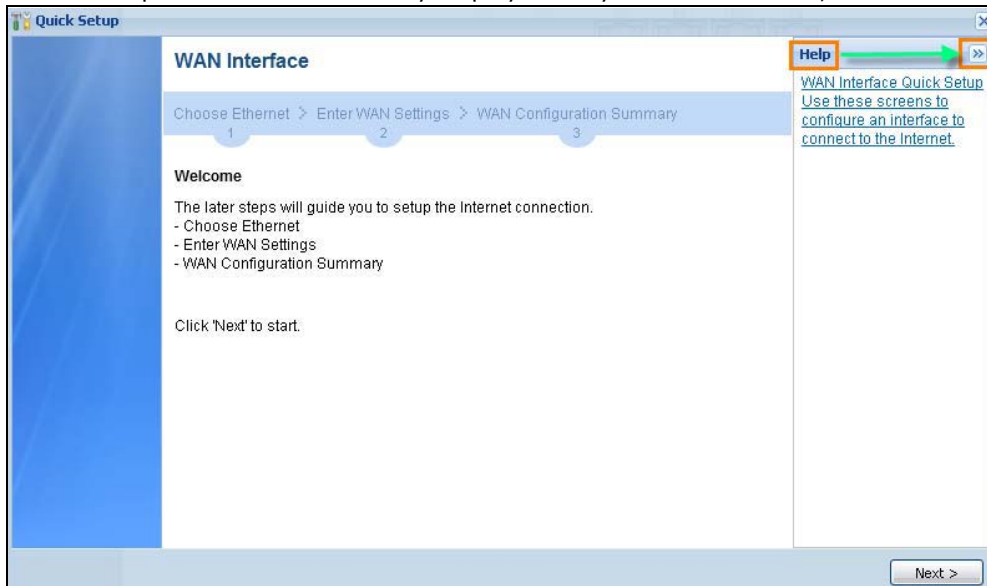

## 4.2 WAN Interface Quick Setup

Click **WAN Interface** in the main **Quick Setup** screen to open the **WAN Interface Quick Setup Wizard Welcome** screen. Use these screens to configure an interface to connect to the Internet. Click **Next**.

**Figure 37** WAN Interface Quick Setup Wizard

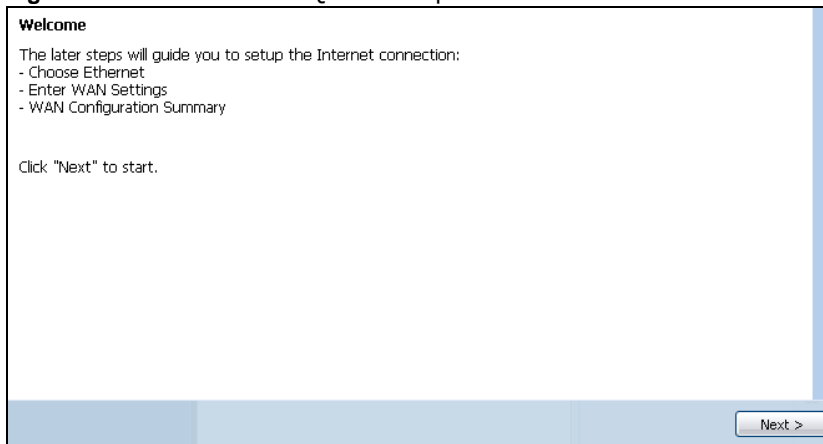

### 4.2.1 Choose an Ethernet Interface

Select the Ethernet interface (names vary by model) that you want to configure for a WAN connection and click **Next**.

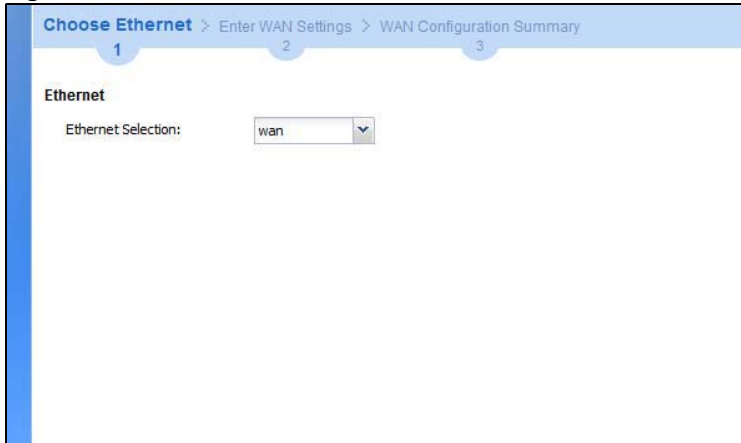
**Figure 38** Choose an Ethernet Interface

## 4.2.2 Select WAN Type

**WAN Type Selection:** Select the type of encapsulation this connection is to use. Choose **Ethernet** when the WAN port is used as a regular Ethernet.

Otherwise, choose **PPPoE** or **PPTP** for a dial-up connection according to the information from your ISP.

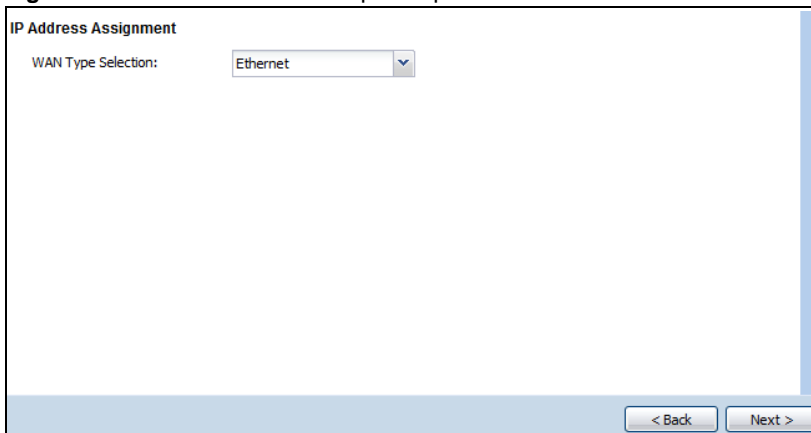
**Figure 39** WAN Interface Setup: Step 2

The screens vary depending on what encapsulation type you use. Refer to information provided by your ISP to know what to enter in each field. Leave a field blank if you don't have that information.

Note: Enter the Internet access information exactly as your ISP gave it to you.

## 4.2.3 Configure WAN IP Settings

Use this screen to select whether the interface should use a fixed or dynamic IP address.

**Figure 40** WAN Interface Setup: Step 2 Dynamic IP

Interface

WAN Interface: wan

Zone: WAN

IP Address Assignment: Auto

< Back Next >

**Figure 41** WAN Interface Setup: Step 2 Fixed IP

IP Address Assignment

WAN Interface: wan

Zone: WAN

IP Address: 1.1.1.1

IP Subnet Mask: 255.255.255.0

Gateway IP Address: (Optional)

First DNS Server:

Second DNS Server:

< Back Next >

- **WAN Interface:** This is the interface you are configuring for Internet access.
- **Zone:** This is the security zone to which this interface and Internet connection belong.
- **IP Address Assignment:** Select **Auto** if your ISP did not assign you a fixed IP address. Select **Static** if you have a fixed IP address and enter the IP address, subnet mask, gateway IP address (optional) and DNS server IP address(es).

#### 4.2.4 ISP and WAN and ISP Connection Settings

Use this screen to configure the ISP and WAN interface settings. This screen is read-only if you select **Ethernet** and set the **IP Address Assignment** to **AutoStatic**. If you set the **IP Address Assignment** to **static** and/or select **PPTP** or **PPPoE**, enter the Internet access information exactly as your ISP gave it to you.

Note: Enter the Internet access information exactly as your ISP gave it to you.

**Figure 42** WAN and ISP Connection Settings: (PPTP Shown)

The screenshot shows the following configuration details:

- ISP Parameters:** Encapsulation: PPTP; Authentication Type: Chap/PAP; User Name, Password, and Retype to Confirm fields are empty with red dashed borders and information icons; Nailed-Up checkbox is unchecked; Idle timeout: 100 Seconds.
- PPTP Configuration:** Base Interface: wan; Base IP Address: 0.0.0.0 (red dashed border, information icon); IP Subnet Mask: 255.255.255.0; Gateway IP Address: (Optional); Server IP: 0.0.0.0 (red dashed border, information icon); Connection ID: (Optional).
- IP Address Assignment:** WAN Interface: wan\_ppp; Zone: WAN; IP Address: 0.0.0.0 (red dashed border, information icon); Gateway IP Address: (Optional); First DNS Server and Second DNS Server fields are empty.

Navigation buttons: < Back, Next >

The following table describes the labels in this screen.

**Table 14** WAN and ISP Connection Settings

LABEL	DESCRIPTION
ISP Parameter	This section appears if the interface uses a PPPoE or PPTP Internet connection.
Encapsulation	This displays the type of Internet connection you are configuring.
Authentication Type	Use the drop-down list box to select an authentication protocol for outgoing calls. Options are: <b>CHAP/PAP</b> - Your USG accepts either CHAP or PAP when requested by this remote node. <b>CHAP</b> - Your USG accepts CHAP only. <b>PAP</b> - Your USG accepts PAP only. <b>MSCHAP</b> - Your USG accepts MSCHAP only. <b>MSCHAP-V2</b> - Your USG accepts MSCHAP-V2 only.
User Name	Type the user name given to you by your ISP. You can use alphanumeric and -_@\$ . / characters, and it can be up to 31 characters long.
Password	Type the password associated with the user name above. Use up to 64 ASCII characters except the [] and ?. This field can be blank.
Retype to Confirm	Type your password again for confirmation.
Nailed-Up	Select <b>Nailed-Up</b> if you do not want the connection to time out.

**Table 14** WAN and ISP Connection Settings (continued)

LABEL	DESCRIPTION
Idle Timeout	Type the time in seconds that elapses before the router automatically disconnects from the PPPoE server. 0 means no timeout.
PPTP Configuration	This section only appears if the interface uses a PPPoE or PPTP Internet connection.
Base Interface	This displays the identity of the Ethernet interface you configure to connect with a modem or router.
Base IP Address	Type the (static) IP address assigned to you by your ISP.
IP Subnet Mask	Type the subnet mask assigned to you by your ISP (if given).
Server IP	Type the IP address of the PPTP server.
Connection ID	Enter the connection ID or connection name in this field. It must follow the "c:id" and "n:name" format. For example, C:12 or N:My ISP. This field is optional and depends on the requirements of your DSL modem. You can use alphanumeric and -_ : characters, and it can be up to 31 characters long.
WAN Interface Setup	
WAN Interface	This displays the identity of the interface you configure to connect with your ISP.
Zone	This field displays to which security zone this interface and Internet connection will belong.
IP Address	This field is read-only when the WAN interface uses a dynamic IP address. If your WAN interface uses a static IP address, enter it in this field.
First DNS Server Second DNS Server	These fields only display for an interface with a static IP address. Enter the DNS server IP address(es) in the field(s) to the right.  Leave the field as <b>0.0.0.0</b> if you do not want to configure DNS servers. If you do not configure a DNS server, you must know the IP address of a machine in order to access it.  DNS (Domain Name System) is for mapping a domain name to its corresponding IP address and vice versa. The DNS server is extremely important because without it, you must know the IP address of a computer before you can access it. The USG uses a system DNS server (in the order you specify here) to resolve domain names for VPN, DDNS and the time server.
Back	Click <b>Back</b> to return to the previous screen.
Next	Click <b>Next</b> to continue.

## 4.2.5 Quick Setup Interface Wizard: Summary

This screen displays the WAN interface's settings.

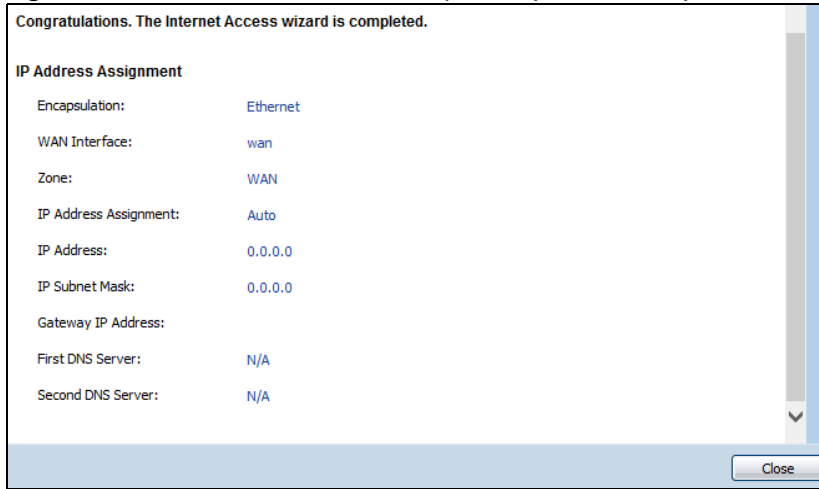
**Figure 43** Interface Wizard: Summary WAN (PPTP Shown)

The following table describes the labels in this screen.

**Table 15** Interface Wizard: Summary WAN

LABEL	DESCRIPTION
Encapsulation	This displays what encapsulation this interface uses to connect to the Internet.
Service Name	This field only appears for a PPPoE interface. It displays the PPPoE service name specified in the ISP account.
Server IP	This field only appears for a PPTP interface. It displays the IP address of the PPTP server.
User Name	This is the user name given to you by your ISP.
Nailed-Up	If <b>No</b> displays the connection will not time out. <b>Yes</b> means the USG uses the idle timeout.
Idle Timeout	This is how many seconds the connection can be idle before the router automatically disconnects from the PPPoE server. 0 means no timeout.
Connection ID	If you specified a connection ID, it displays here.
WAN Interface	This identifies the interface you configure to connect with your ISP.
Zone	This field displays to which security zone this interface and Internet connection will belong.
IP Address Assignment	This field displays whether the WAN IP address is static or dynamic ( <b>Auto</b> ).
First DNS Server Second DNS Server	If the <b>IP Address Assignment</b> is <b>Static</b> , these fields display the DNS server IP address(es).
Close	Click <b>Close</b> to exit the wizard.

## 4.3 VPN Setup Wizard

Click **VPN Setup** in the main **Quick Setup** screen to open the VPN Setup Wizard **Welcome** screen.

Figure 44 VPN Setup Wizard



### 4.3.1 Welcome

Use wizards to create Virtual Private Network (VPN) rules. After you complete the wizard, the Phase 1 rule settings appear in the **VPN > IPsec VPN > VPN Gateway** screen and the Phase 2 rule settings appear in the **VPN > IPsec VPN > VPN Connection** screen.

- **VPN Settings** configures a VPN tunnel for a secure connection to another computer or network.
- **VPN Settings for Configuration Provisioning** sets up a VPN rule the USG IPsec VPN Client can retrieve. Just enter a user name, password and the IP address of the USG in the IPsec VPN Client to get the VPN settings automatically from the USG.
- **VPN Settings for L2TP VPN Settings** sets up a L2TP VPN rule that the USG IPsec L2TP VPN client can retrieve.

Figure 45 VPN Setup Wizard Welcome

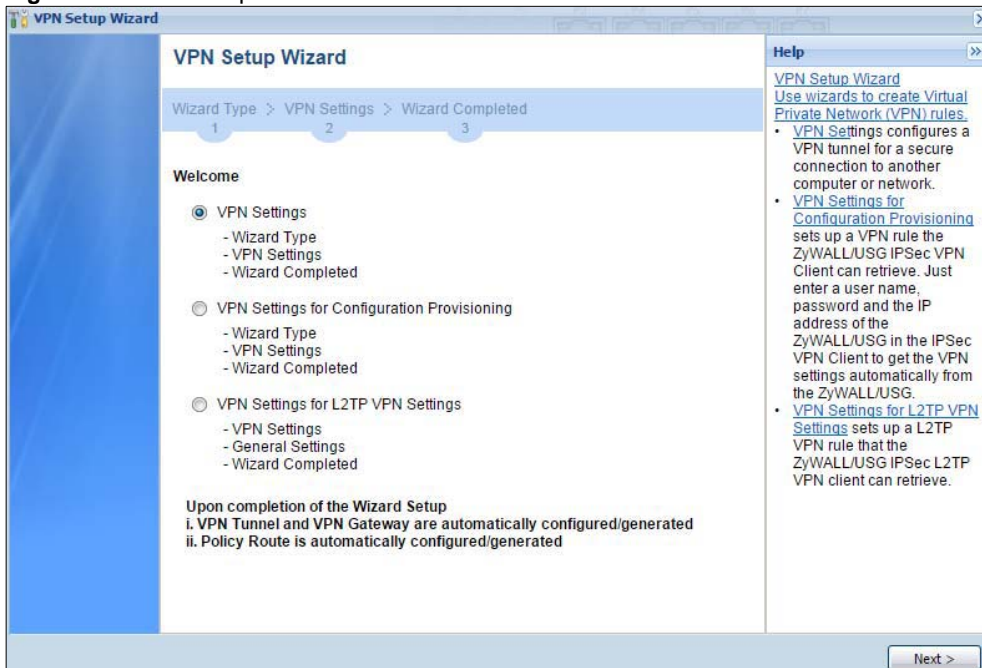



### 4.3.2 VPN Setup Wizard: Wizard Type

Choose **Express** to create a VPN rule with the default phase 1 and phase 2 settings to connect to another ZLD-based USG using a pre-shared key.

Choose **Advanced** to change the default settings and/or use certificates instead of a pre-shared key to create a VPN rule to connect to another IPSec device.

**Figure 46** VPN Setup Wizard: Wizard Type

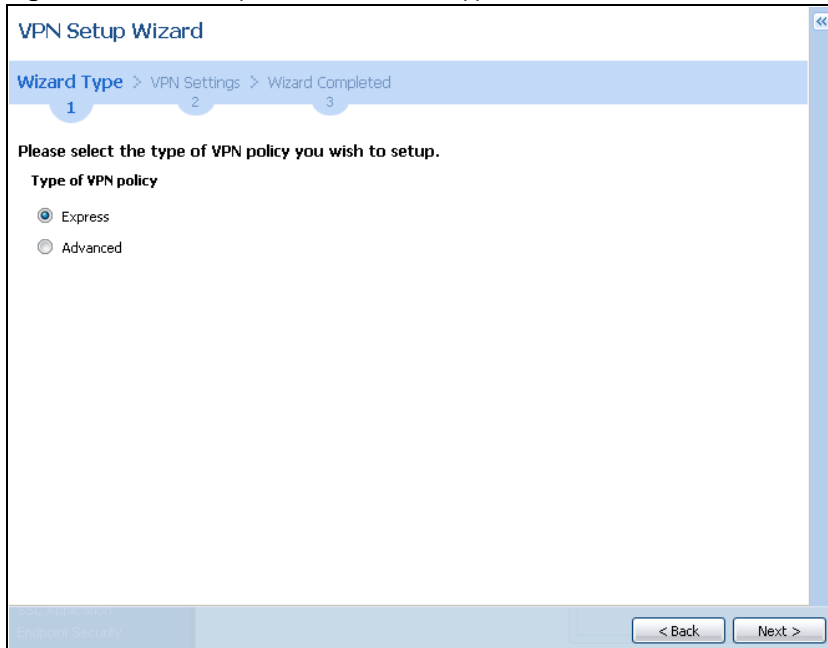

### 4.3.3 VPN Express Wizard - Scenario

Click the **Express** radio button as shown in [Figure 46 on page 57](#) to display the following screen.

Figure 47 VPN Express Wizard: Scenario

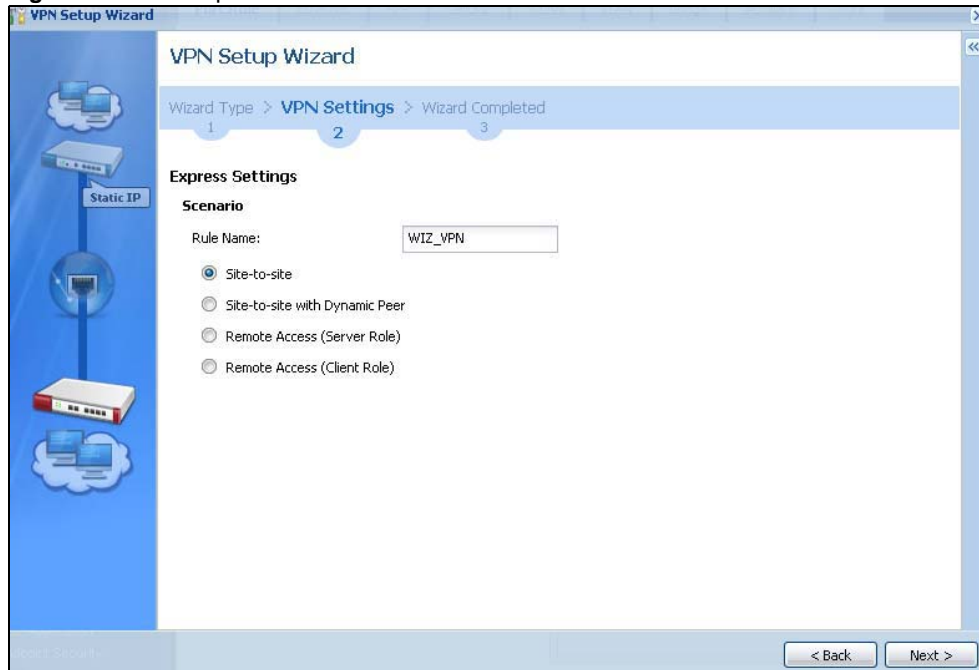

**Rule Name:** Type the name used to identify this VPN connection (and VPN gateway). You may use 1-31 alphanumeric characters, underscores (\_), or dashes (-), but the first character cannot be a number. This value is case-sensitive.

Select the scenario that best describes your intended VPN connection. The figure on the left of the screen changes to match the scenario you select.

- **Site-to-site** - The remote IPsec device has a static IP address or a domain name. This USG can initiate the VPN tunnel.
- **Site-to-site with Dynamic Peer** - The remote IPsec device has a dynamic IP address. Only the remote IPsec device can initiate the VPN tunnel.
- **Remote Access (Server Role)** - Allow incoming connections from IPsec VPN clients. The clients have dynamic IP addresses and are also known as dial-in users. Only the clients can initiate the VPN tunnel.
- **Remote Access (Client Role)** - Connect to an IPsec server. This USG is the client (dial-in user) and can initiate the VPN tunnel.

### 4.3.4 VPN Express Wizard - Configuration

**Figure 48** VPN Express Wizard: Configuration

The screenshot shows the 'Express Settings' window for the VPN Express Wizard. Under the 'Configuration' section, there are four rows of input fields:

- Secure Gateway:** An empty text box with a red dashed border and a red exclamation mark icon to its right, followed by the text '/FQDN'.
- Pre-Shared Key:** An empty text box with a red dashed border and a red exclamation mark icon to its right.
- Local Policy (IP/Mask):** Two text boxes containing '0.0.0.0' and '255.255.255.0' separated by a forward slash.
- Remote Policy (IP/Mask):** Two text boxes containing '0.0.0.0' and '255.255.255.0' separated by a forward slash.

At the bottom of the window, there are two buttons: '< Back' and 'Next >'.

- **Secure Gateway:** **Any** displays in this field if it is not configurable for the chosen scenario. Otherwise, enter the WAN IP address or domain name of the remote IPsec device (secure gateway) to identify the remote IPsec router by its IP address or a domain name. Use 0.0.0.0 if the remote IPsec router has a dynamic WAN IP address.
- **Pre-Shared Key:** Type the password. Both ends of the VPN tunnel must use the same password. Use 8 to 31 case-sensitive ASCII characters or 8 to 31 pairs of hexadecimal ("0-9", "A-F") characters. Proceed a hexadecimal key with "0x". You will receive a PYLD\_MALFORMED (payload malformed) packet if the same pre-shared key is not used on both ends.
- **Local Policy (IP/Mask):** Type the IP address of a computer on your network that can use the tunnel. You can also specify a subnet. This must match the remote IP address configured on the remote IPsec device.
- **Remote Policy (IP/Mask):** **Any** displays in this field if it is not configurable for the chosen scenario. Otherwise, type the IP address of a computer behind the remote IPsec device. You can also specify a subnet. This must match the local IP address configured on the remote IPsec device.

### 4.3.5 VPN Express Wizard - Summary

This screen provides a read-only summary of the VPN tunnel's configuration and commands that you can copy and paste into another ZLD-based USG's command line interface to configure it.

**Figure 49** VPN Express Wizard: Summary

**Express Settings**

**Summary**

Rule Name: WIZ\_VPN

Secure Gateway: 1.2.3.4

Pre-Shared Key: shnr6bge45y4

Local Policy: 192.168.2.1 / 255.255.255.0

Remote Policy: 10.0.0.0 / 255.255.255.0

**Configuration for Secure Gateway**

```
## Edit this shell script according to
## the comments before using it in the remote gateway.
## Check the peer-ip interface.
## Check the local-ip interface.
## Then remove the following line.
PLEASE REMOVE THIS LINE
configure terminal
isakmp policy WIZ_VPN
## If this device's wan1 IP is dynamic,
## consider using DDNS and changing
## the peer-ip listed here to a domain name.
peer-ip 10.0.0.9
## Use the correct interface name in the
## next command line and remove the "#".
# local-ip interface wan1
```

Click "Save" button to write the VPN configuration to ZyWALL.

< Back Save

- **Rule Name:** Identifies the VPN gateway policy.
- **Secure Gateway:** IP address or domain name of the remote IPsec device. If this field displays **Any**, only the remote IPsec device can initiate the VPN connection.
- **Pre-Shared Key:** VPN tunnel password. It identifies a communicating party during a phase 1 IKE negotiation.
- **Local Policy:** IP address and subnet mask of the computers on the network behind your USG that can use the tunnel.
- **Remote Policy:** IP address and subnet mask of the computers on the network behind the remote IPsec device that can use the tunnel. If this field displays **Any**, only the remote IPsec device can initiate the VPN connection.
- Copy and paste the **Configuration for Secure Gateway** commands into another ZLD-based USG's command line interface to configure it to serve as the other end of this VPN tunnel. You can also use a text editor to save these commands as a shell script file with a ".zysh" filename extension. Use the file manager to run the script in order to configure the VPN connection. See the commands reference guide for details on the commands displayed in this list.

### 4.3.6 VPN Express Wizard - Finish

Now the rule is configured on the USG. The Phase 1 rule settings appear in the **VPN > IPsec VPN > VPN Gateway** screen and the Phase 2 rule settings appear in the **VPN > IPsec VPN > VPN Connection** screen.

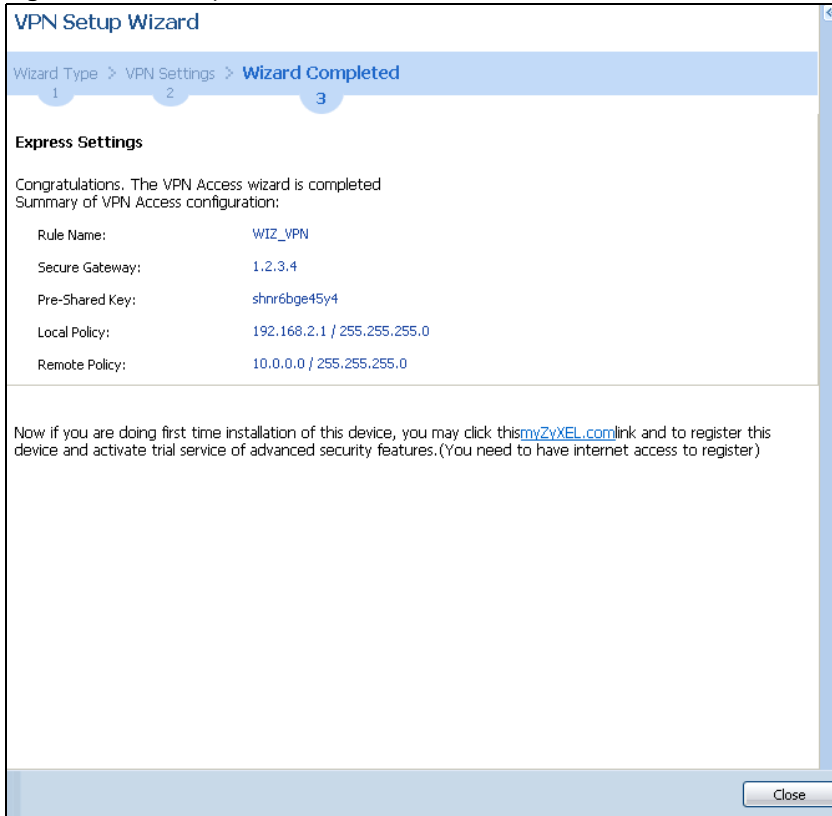
**Figure 50** VPN Express Wizard: Finish

Click **Close** to exit the wizard.

### 4.3.7 VPN Advanced Wizard - Scenario

Click the **Advanced** radio button as shown in [Figure 46 on page 57](#) to display the following screen.

Figure 51 VPN Advanced Wizard: Scenario



**Rule Name:** Type the name used to identify this VPN connection (and VPN gateway). You may use 1-31 alphanumeric characters, underscores (\_), or dashes (-), but the first character cannot be a number. This value is case-sensitive.

Select the scenario that best describes your intended VPN connection. The figure on the left of the screen changes to match the scenario you select.

- **Site-to-site** - The remote IPSec device has a static IP address or a domain name. This USG can initiate the VPN tunnel.
- **Site-to-site with Dynamic Peer** - The remote IPSec device has a dynamic IP address. Only the remote IPSec device can initiate the VPN tunnel.
- **Remote Access (Server Role)** - Allow incoming connections from IPSec VPN clients. The clients have dynamic IP addresses and are also known as dial-in users. Only the clients can initiate the VPN tunnel.
- **Remote Access (Client Role)** - Connect to an IPSec server. This USG is the client (dial-in user) and can initiate the VPN tunnel.

### 4.3.8 VPN Advanced Wizard - Phase 1 Settings

There are two phases to every IKE (Internet Key Exchange) negotiation – phase 1 (Authentication) and phase 2 (Key Exchange). A phase 1 exchange establishes an IKE SA (Security Association).

Figure 52 VPN Advanced Wizard: Phase 1 Settings

- **Secure Gateway:** **Any** displays in this field if it is not configurable for the chosen scenario. Otherwise, enter the WAN IP address or domain name of the remote IPsec device (secure gateway) to identify the remote IPsec device by its IP address or a domain name. Use 0.0.0.0 if the remote IPsec device has a dynamic WAN IP address.
- **My Address (interface):** Select an interface from the drop-down list box to use on your USG.
- **Negotiation Mode:** This displays **Main** or **Aggressive**:
  - **Main** encrypts the USG's and remote IPsec router's identities but takes more time to establish the IKE SA
  - **Aggressive** is faster but does not encrypt the identities.

The USG and the remote IPsec router must use the same negotiation mode. Multiple SAs connecting through a secure gateway must have the same negotiation mode.

- **Encryption Algorithm:** **3DES** and **AES** use encryption. The longer the key, the higher the security (this may affect throughput). Both sender and receiver must use the same secret key, which can be used to encrypt and decrypt the message or to generate and verify a message authentication code. The DES encryption algorithm uses a 56-bit key. Triple DES (**3DES**) is a variation on DES that uses a 168-bit key. As a result, 3DES is more secure than DES. It also requires more processing power, resulting in increased latency and decreased throughput. **AES128** uses a 128-bit key and is faster than 3DES. AES192 uses a 192-bit key, and AES256 uses a 256-bit key.
- **Authentication Algorithm:** **MD5** gives minimal security and **SHA512** gives the highest security. MD5 (Message Digest 5) and SHA (Secure Hash Algorithm) are hash algorithms used to authenticate packet data. The stronger the algorithm the slower it is.
- **Key Group:** **DH5** is more secure than **DH1** or **DH2** (although it may affect throughput). DH1 (default) refers to Diffie-Hellman Group 1 a 768 bit random number. DH2 refers to Diffie-Hellman Group 2 a 1024 bit (1Kb) random number. DH5 refers to Diffie-Hellman Group 5 a 1536 bit random number.
- **SA Life Time:** Set how often the USG renegotiates the IKE SA. A short SA life time increases security, but renegotiation temporarily disconnects the VPN tunnel.
- **NAT Traversal:** Select this if the VPN tunnel must pass through NAT (there is a NAT router between the IPsec devices).

Note: The remote IPsec device must also have NAT traversal enabled. See the help in the main IPsec VPN screens for more information.

- **Dead Peer Detection (DPD)** has the USG make sure the remote IPsec device is there before transmitting data through the IKE SA. If there has been no traffic for at least 15 seconds, the USG sends a message to the remote IPsec device. If it responds, the USG transmits the data. If it does not respond, the USG shuts down the IKE SA.
- **Authentication Method:** Select **Pre-Shared Key** to use a password or **Certificate** to use one of the USG's certificates.

### 4.3.9 VPN Advanced Wizard - Phase 2

Phase 2 in an IKE uses the SA that was established in phase 1 to negotiate SAs for IPsec.

**Figure 53** VPN Advanced Wizard: Phase 2 Settings

**Advanced Settings**

**Phase 2 Setting**

Active Protocol: ESP

Encapsulation: Tunnel

Encryption Algorithm: DES

Authentication Algorithm: SHA1

SA Life Time: 86400 (180 - 3000000 Seconds)

Perfect Forward Secrecy (PFS): None

**Policy Setting**

Local Policy (IP/Mask): 0.0.0.0 / 255.255.255.0

Remote Policy (IP/Mask): 0.0.0.0 / 255.255.255.0

**Property**

Nailed-Up

- **Active Protocol:** **ESP** is compatible with NAT, **AH** is not.
- **Encapsulation:** **Tunnel** is compatible with NAT, **Transport** is not.
- **Encryption Algorithm:** **3DES** and **AES** use encryption. The longer the **AES** key, the higher the security (this may affect throughput). **Null** uses no encryption.
- **Authentication Algorithm:** **MD5** gives minimal security and **SHA512** gives the highest security. MD5 (Message Digest 5) and SHA (Secure Hash Algorithm) are hash algorithms used to authenticate packet data. The stronger the algorithm the slower it is.
- **SA Life Time:** Set how often the USG renegotiates the IKE SA. A short SA life time increases security, but renegotiation temporarily disconnects the VPN tunnel.
- **Perfect Forward Secrecy (PFS):** Disabling PFS allows faster IPsec setup, but is less secure. Select DH1, DH2 or DH5 to enable PFS. **DH5** is more secure than **DH1** or **DH2** (although it may affect throughput). DH1 refers to Diffie-Hellman Group 1 a 768 bit random number. DH2 refers to Diffie-Hellman Group 2 a 1024 bit (1Kb) random number. DH5 refers to Diffie-Hellman Group 5 a 1536 bit random number (more secure, yet slower).
- **Local Policy (IP/Mask):** Type the IP address of a computer on your network. You can also specify a subnet. This must match the remote IP address configured on the remote IPsec device.
- **Remote Policy (IP/Mask):** Type the IP address of a computer behind the remote IPsec device. You can also specify a subnet. This must match the local IP address configured on the remote IPsec device.
- **Nailed-Up:** This displays for the site-to-site and remote access client role scenarios. Select this to have the USG automatically renegotiate the IPsec SA when the SA life time expires.



### 4.3.10 VPN Advanced Wizard - Summary

This is a read-only summary of the VPN tunnel settings.

**Figure 54** VPN Advanced Wizard: Summary

**Express Settings**

**Summary**

Rule Name: WIZ\_VPN

Secure Gateway: 1.2.3.4

Certificate: default

Local Policy: 0.0.0.0 / 255.255.255.0

Remote Policy: 0.0.0.0 / 255.255.255.0

**Configuration for Secure Gateway**

```
## Edit this shell script according to
## the comments before using it in the remote gateway.
## Check the peer-ip interface.
## Check the local-ip interface.
## Edit the WIZ_VPN_LOCAL address-object.
## Then remove the following line.
PLEASE REMOVE THIS LINE
configure terminal
isakmp policy WIZ_VPN
## If this device's wan1 IP is dynamic,
## consider using DDNS and changing
## the peer-ip listed here to a domain name.
peer-ip 10.0.0.9
## Use the correct interface name in the
## next command line and remove the "#".
```

Click "Save" button to write the VPN configuration to ZyWALL.

< Back Save

- **Rule Name:** Identifies the VPN connection (and the VPN gateway).
- **Secure Gateway:** IP address or domain name of the remote IPsec device.
- **Pre-Shared Key:** VPN tunnel password.
- **Certificate:** The certificate the USG uses to identify itself when setting up the VPN tunnel.
- **Local Policy:** IP address and subnet mask of the computers on the network behind your USG that can use the tunnel.
- **Remote Policy:** IP address and subnet mask of the computers on the network behind the remote IPsec device that can use the tunnel.
- Copy and paste the **Configuration for Remote Gateway** commands into another ZLD-based USG's command line interface.
- Click **Save** to save the VPN rule.

### 4.3.11 VPN Advanced Wizard - Finish

Now the rule is configured on the USG. The Phase 1 rule settings appear in the **VPN > IPsec VPN > VPN Gateway** screen and the Phase 2 rule settings appear in the **VPN > IPsec VPN > VPN Connection** screen.

**Figure 55** VPN Wizard: Finish

Advanced Settings	
Congratulations. The VPN Access wizard is completed Summary of VPN Access configuration:	
Rule Name:	WIZ_VPN
Secure Gateway:	1.2.3.4
My Address (interface):	wan1
Pre-Shared Key:	lkj581mjw777
Phase 1	
Negotiation Mode:	main
Encryption Algorithm:	des
Authentication Algorithm:	md5
Key Group:	DH1
SA Life Time:	86400
NAT Traversal:	false
Dead Peer Detection (DPD):	true
Phase 2	
Active Protocol:	esp
Encapsulation:	tunnel
Encryption Algorithm:	des
Authentication Algorithm:	sha
SA Life Time:	86400
Perfect Forward Secrecy:	None
Policy	
Local Policy:	0.0.0.0 / 255.255.255.0
Remote Policy:	0.0.0.0 / 255.255.255.0
Nailed-Up:	true
Now if you are doing first time installation of this device, you may click this <a href="http://myZyXEL.com">myZyXEL.com</a> link and to register this device and activate trial service of advanced security features. (You need to have internet access to register)	

Click **Close** to exit the wizard.

## 4.4 VPN Settings for Configuration Provisioning Wizard: Wizard Type

Use **VPN Settings for Configuration Provisioning** to set up a VPN rule that can be retrieved with the USG IPSec VPN Client.

VPN rules for the USG IPSec VPN Client have certain restrictions. They must *not* contain the following settings:

- **AH** active protocol
- **NULL** encryption
- **SHA512** authentication
- A subnet or range remote policy

Choose **Express** to create a VPN rule with the default phase 1 and phase 2 settings and to use a pre-shared key.

Choose **Advanced** to change the default settings and/or use certificates instead of a pre-shared key in the VPN rule.

**Figure 56** VPN Settings for Configuration Provisioning Express Wizard: Wizard Type

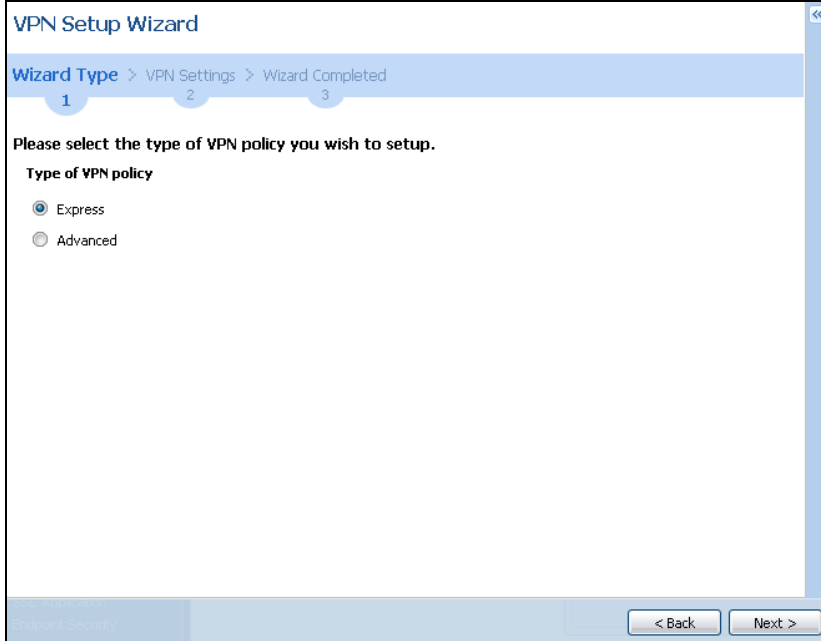

#### 4.4.1 Configuration Provisioning Express Wizard - VPN Settings

Click the **Express** radio button as shown in the previous screen to display the following screen.

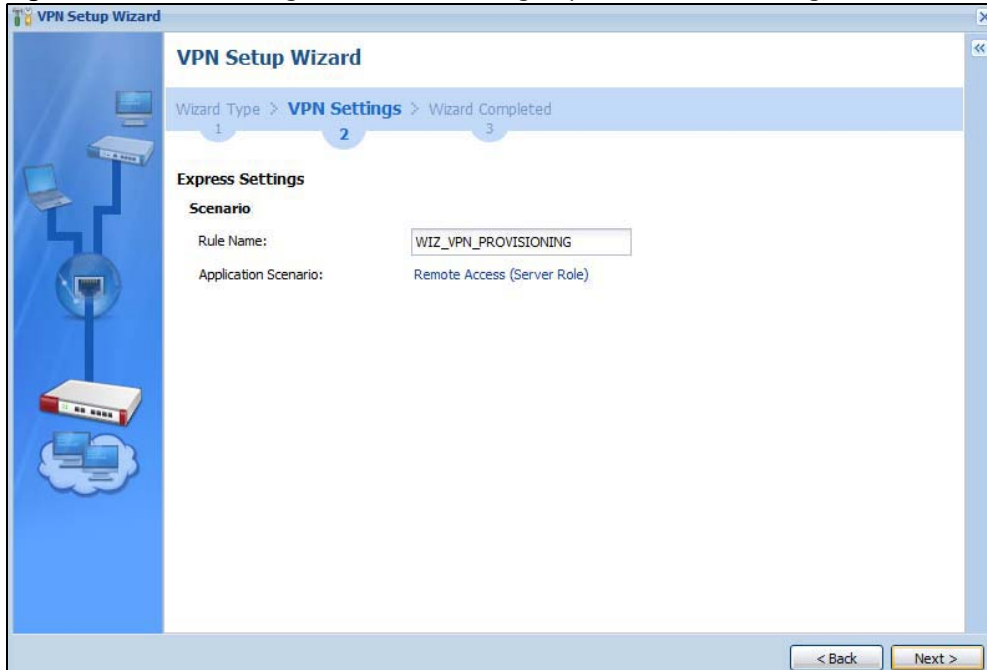
**Figure 57** VPN for Configuration Provisioning Express Wizard: Settings Scenario

**Rule Name:** Type the name used to identify this VPN connection (and VPN gateway). You may use 1-31 alphanumeric characters, underscores (\_), or dashes (-), but the first character cannot be a number. This value is case-sensitive.

**Application Scenario:** Only the **Remote Access (Server Role)** is allowed in this wizard. It allows incoming connections from the USG IPsec VPN Client.

#### 4.4.2 Configuration Provisioning VPN Express Wizard - Configuration

Click **Next** to continue the wizard.

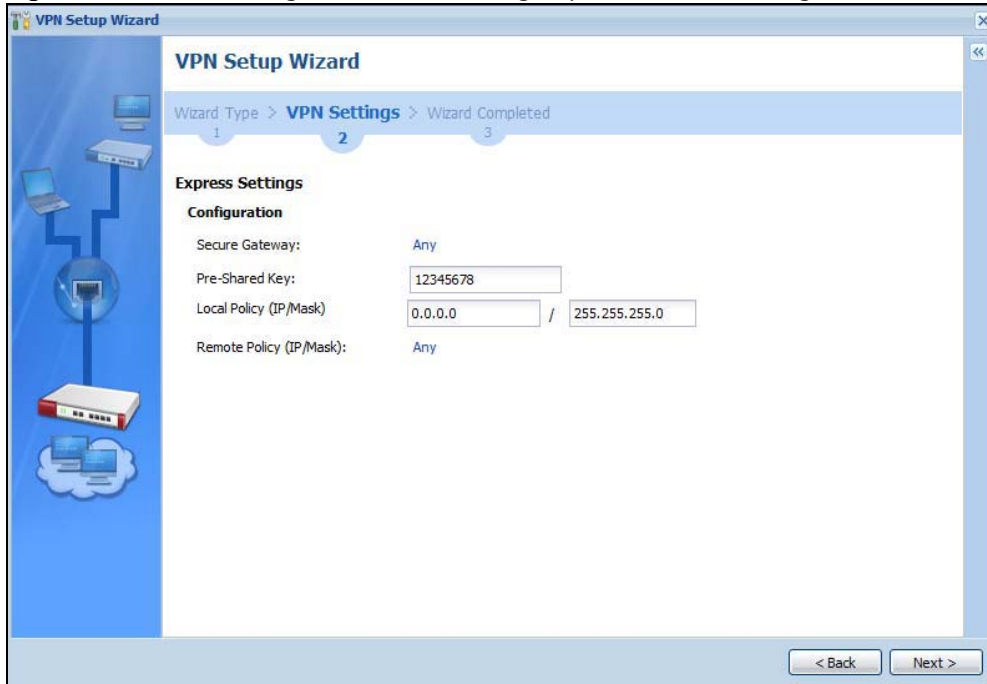
**Figure 58** VPN for Configuration Provisioning Express Wizard: Configuration

- **Secure Gateway:** **Any** displays in this field because it is not configurable in this wizard. It allows incoming connections from the USG IPsec VPN Client.
- **Pre-Shared Key:** Type the password. Both ends of the VPN tunnel must use the same password. Use 8 to 31 case-sensitive ASCII characters or 8 to 31 pairs of hexadecimal ("0-9", "A-F") characters. Proceed a hexadecimal key with "0x". You will receive a PYLD\_MALFORMED (payload malformed) packet if the same pre-shared key is not used on both ends.
- **Local Policy (IP/Mask):** Type the IP address of a computer on your network. You can also specify a subnet. This must match the remote IP address configured on the remote IPsec device.
- **Remote Policy (IP/Mask):** **Any** displays in this field because it is not configurable in this wizard.

### 4.4.3 VPN Settings for Configuration Provisioning Express Wizard - Summary

This screen has a read-only summary of the VPN tunnel's configuration and commands you can copy and paste into another ZLD-based USG's command line interface to configure it.

Figure 59 VPN for Configuration Provisioning Express Wizard: Summary

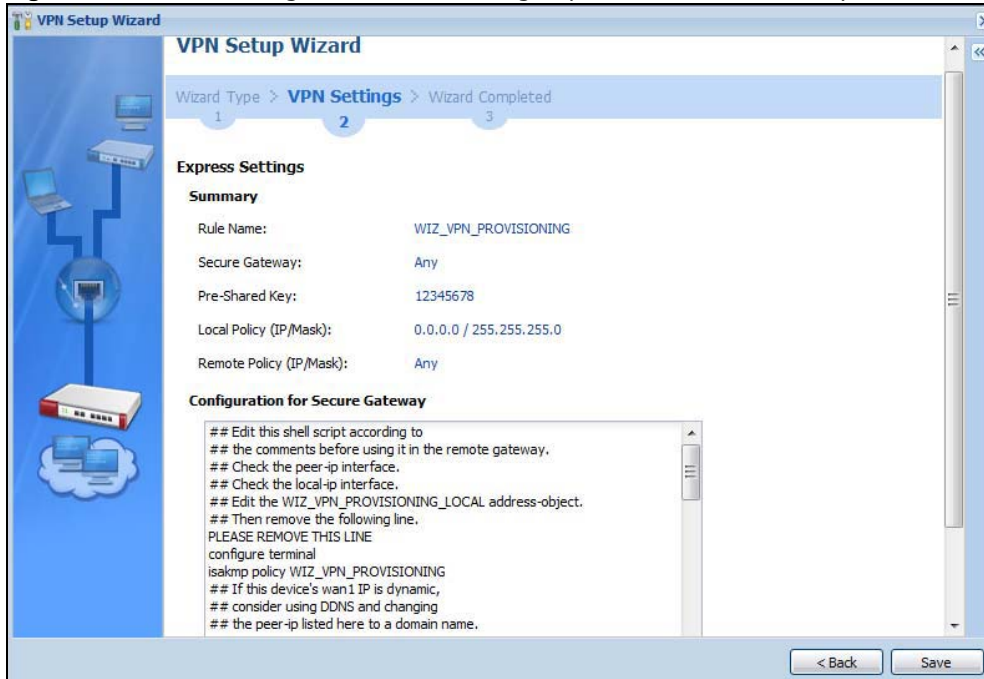

- **Rule Name:** Identifies the VPN gateway policy.
- **Secure Gateway: Any** displays in this field because it is not configurable in this wizard. It allows incoming connections from the USG IPsec VPN Client.
- **Pre-Shared Key:** VPN tunnel password. It identifies a communicating party during a phase 1 IKE negotiation.
- **Local Policy:** (Static) IP address and subnet mask of the computers on the network behind your USG that can be accessed using the tunnel.
- **Remote Policy: Any** displays in this field because it is not configurable in this wizard.
- The **Configuration for Secure Gateway** displays the configuration that the USG IPsec VPN Client will get from the USG.
- Click **Save** to save the VPN rule.

#### 4.4.4 VPN Settings for Configuration Provisioning Express Wizard - Finish

Now the rule is configured on the USG. The Phase 1 rule settings appear in the **VPN > IPsec VPN > VPN Gateway** screen and the Phase 2 rule settings appear in the **VPN > IPsec VPN > VPN Connection** screen. Enter the IP address of the USG in the USG IPsec VPN Client to get all these VPN settings automatically from the USG.

**Figure 60** VPN for Configuration Provisioning Express Wizard: Finish

Click **Close** to exit the wizard.

#### 4.4.5 VPN Settings for Configuration Provisioning Advanced Wizard - Scenario

Click the **Advanced** radio button as shown in the screen shown in [Figure 56 on page 67](#) to display the following screen.

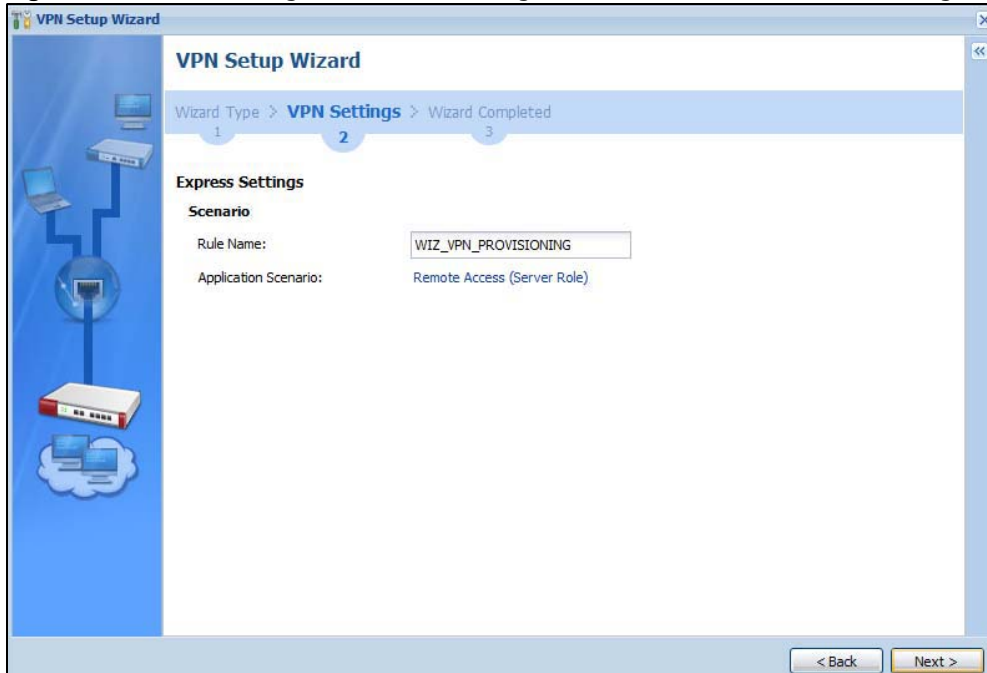
**Figure 61** VPN for Configuration Provisioning Advanced Wizard: Scenario Settings

**Rule Name:** Type the name used to identify this VPN connection (and VPN gateway). You may use 1-31 alphanumeric characters, underscores (\_), or dashes (-), but the first character cannot be a number. This value is case-sensitive.

**Application Scenario:** Only the **Remote Access (Server Role)** is allowed in this wizard. It allows incoming connections from the USG IPsec VPN Client.

Click **Next** to continue the wizard.

#### 4.4.6 VPN Settings for Configuration Provisioning Advanced Wizard - Phase 1 Settings

There are two phases to every IKE (Internet Key Exchange) negotiation – phase 1 (Authentication) and phase 2 (Key Exchange). A phase 1 exchange establishes an IKE SA (Security Association).



**Figure 62** VPN for Configuration Provisioning Advanced Wizard: Phase 1 Settings

**Advanced Settings**

**Phase 1 Setting**

Secure Gateway: Any

My Address (interface): wan1

Negotiation Mode: Main

Encryption Algorithm: DES

Authentication Algorithm: MD5

Key Group: DH1

SA Life Time: 86400 (180 - 3000000 seconds)

**Authentication Method**

Pre-Shared Key

Certificate

- **Secure Gateway:** **Any** displays in this field because it is not configurable in this wizard. It allows incoming connections from the USG IPsec VPN Client.
- **My Address (interface):** Select an interface from the drop-down list box to use on your USG.
- **Negotiation Mode:** This displays **Main** or **Aggressive**:
  - **Main** encrypts the USG's and remote IPsec router's identities but takes more time to establish the IKE SA
  - **Aggressive** is faster but does not encrypt the identities.

The USG and the remote IPsec router must use the same negotiation mode. Multiple SAs connecting through a secure gateway must have the same negotiation mode.

- **Encryption Algorithm:** **3DES** and **AES** use encryption. The longer the key, the higher the security (this may affect throughput). Both sender and receiver must know the same secret key, which can be used to encrypt and decrypt the message or to generate and verify a message authentication code. The DES encryption algorithm uses a 56-bit key. Triple DES (3DES) is a variation on DES that uses a 168-bit key. As a result, 3DES is more secure than DES. It also requires more processing power, resulting in increased latency and decreased throughput. AES128 uses a 128-bit key and is faster than 3DES. AES192 uses a 192-bit key and AES256 uses a 256-bit key.
- **Authentication Algorithm:** MD5 (Message Digest 5) and SHA (Secure Hash Algorithm) are hash algorithms used to authenticate packet data. **MD5** gives minimal security. **SHA1** gives higher security and **SHA256** gives the highest security. The stronger the algorithm, the slower it is.
- **Key Group:** **DH5** is more secure than **DH1** or **DH2** (although it may affect throughput). DH1 (default) refers to Diffie-Hellman Group 1 a 768 bit random number. DH2 refers to Diffie-Hellman Group 2 a 1024 bit (1Kb) random number. **DH5** refers to Diffie-Hellman Group 5 a 1536 bit random number.
- **SA Life Time:** Set how often the USG renegotiates the IKE SA. A short SA life time increases security, but renegotiation temporarily disconnects the VPN tunnel.
- **Authentication Method:** Select **Pre-Shared Key** to use a password or **Certificate** to use one of the USG's certificates.

## 4.4.7 VPN Settings for Configuration Provisioning Advanced Wizard - Phase 2

Phase 2 in an IKE uses the SA that was established in phase 1 to negotiate SAs for IPSec.

**Figure 63** VPN for Configuration Provisioning Advanced Wizard: Phase 2 Settings

**Advanced Settings**

**Phase 2 Setting**

Active Protocol: ESP

Encapsulation: Tunnel

Encryption Algorithm: DES

Authentication Algorithm: SHA1

SA Life Time: 86400 (180 - 3000000 seconds)

Perfect Forward Secrecy (PFS): None

**Policy Setting**

Local Policy (IP/Mask): 0.0.0.0 / 255.255.255.0

Remote Policy (IP/Mask): Any

- **Active Protocol:** **ESP** is compatible with NAT. **AH** is not available in this wizard.
- **Encapsulation:** **Tunnel** is compatible with NAT, **Transport** is not.
- **Encryption Algorithm:** **3DES** and **AES** use encryption. The longer the **AES** key, the higher the security (this may affect throughput). **Null** uses no encryption.
- **Authentication Algorithm:** MD5 (Message Digest 5) and SHA (Secure Hash Algorithm) are hash algorithms used to authenticate packet data. **MD5** gives minimal security. **SHA1** gives higher security and **SHA256** gives the highest security. The stronger the algorithm, the slower it is.
- **SA Life Time:** Set how often the USG renegotiates the IKE SA. A short SA life time increases security, but renegotiation temporarily disconnects the VPN tunnel.
- **Perfect Forward Secrecy (PFS):** Disabling PFS allows faster IPSec setup, but is less secure. Select DH1, DH2 or DH5 to enable PFS. **DH5** is more secure than **DH1** or **DH2** (although it may affect throughput). DH1 refers to Diffie-Hellman Group 1 a 768 bit random number. DH2 refers to Diffie-Hellman Group 2 a 1024 bit (1Kb) random number. DH5 refers to Diffie-Hellman Group 5 a 1536 bit random number (more secure, yet slower).
- **Local Policy (IP/Mask):** Type the IP address of a computer on your network. You can also specify a subnet. This must match the remote IP address configured on the remote IPSec device.
- **Remote Policy (IP/Mask):** **Any** displays in this field because it is not configurable in this wizard.
- **Nailed-Up:** This displays for the site-to-site and remote access client role scenarios. Select this to have the USG automatically renegotiate the IPSec SA when the SA life time expires.

## 4.4.8 VPN Settings for Configuration Provisioning Advanced Wizard - Summary

This is a read-only summary of the VPN tunnel settings.

Figure 64 VPN for Configuration Provisioning Advanced Wizard: Summary

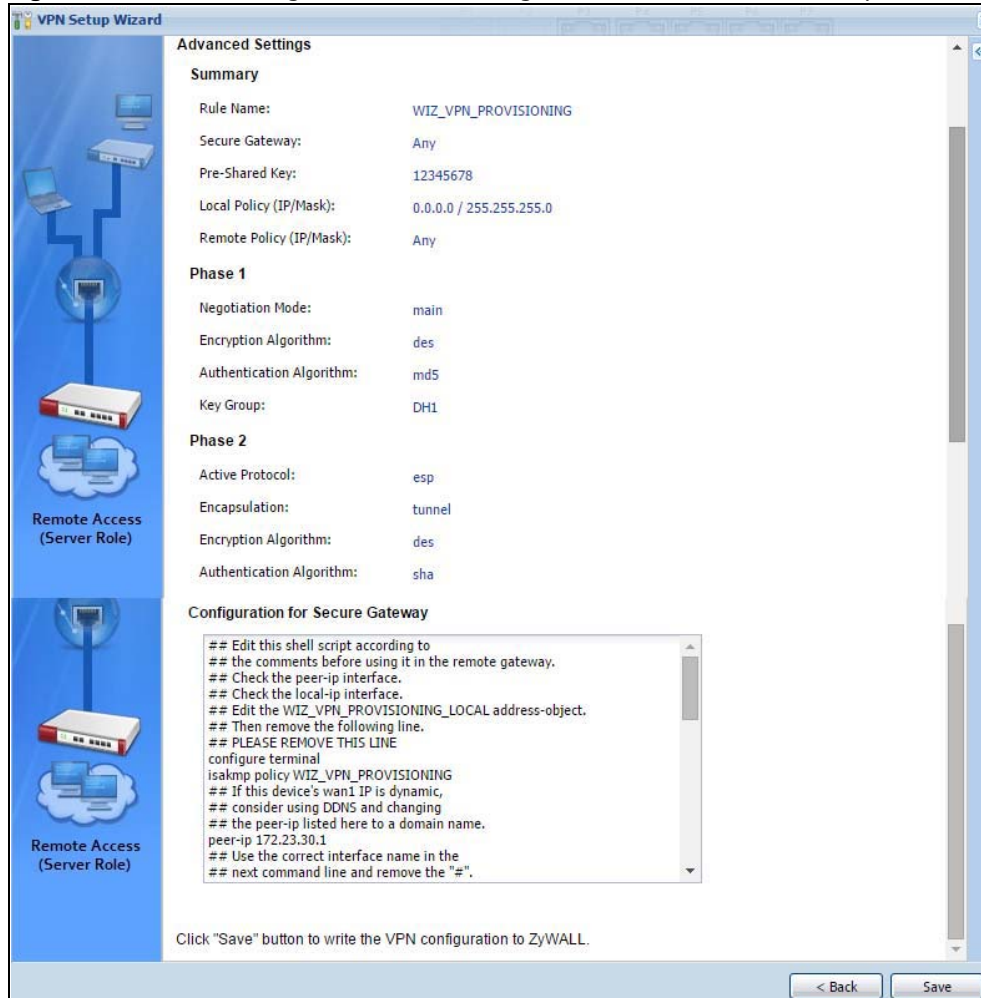

### Summary

- **Rule Name:** Identifies the VPN connection (and the VPN gateway).
- **Secure Gateway:** **Any** displays in this field because it is not configurable in this wizard. It allows incoming connections from the USG IPsec VPN Client.
- **Pre-Shared Key:** VPN tunnel password.
- **Local Policy:** IP address and subnet mask of the computers on the network behind your USG that can use the tunnel.
- **Remote Policy:** **Any** displays in this field because it is not configurable in this wizard.

### Phase 1

- **Negotiation Mode:** This displays **Main** or **Aggressive**:
  - **Main** encrypts the USG's and remote IPsec router's identities but takes more time to establish the IKE SA
  - **Aggressive** is faster but does not encrypt the identities.

The USG and the remote IPsec router must use the same negotiation mode. Multiple SAs connecting through a secure gateway must have the same negotiation mode.

- **Encryption Algorithm:** This displays the encryption method used. The longer the key, the higher the security, the lower the throughput (possibly).
  - **DES** uses a 56-bit key.
  - **3DES** uses a 168-bit key.
  - **AES128** uses a 128-bit key
  - **AES192** uses a 192-bit key
  - **AES256** uses a 256-bit key.
- **Authentication Algorithm:** This displays the authentication algorithm used. The stronger the algorithm, the slower it is.
  - **MD5** gives minimal security.
  - **SHA1** gives higher security
  - **SHA256** gives the highest security.
- **Key Group:** This displays the Diffie-Hellman (DH) key group used. **DH5** is more secure than **DH1** or **DH2** (although it may affect throughput).
  - **DH1** uses a 768 bit random number.
  - **DH2** uses a 1024 bit (1Kb) random number.
  - **DH5** uses a 1536 bit random number.

Phase 2

- **Active Protocol:** This displays **ESP** (compatible with NAT) or **AH**.
- **Encapsulation:** This displays **Tunnel** (compatible with NAT) or **Transport**.
- **Encryption Algorithm:** This displays the encryption method used. The longer the key, the higher the security, the lower the throughput (possibly).
  - **DES** uses a 56-bit key.
  - **3DES** uses a 168-bit key.
  - **AES128** uses a 128-bit key
  - **AES192** uses a 192-bit key
  - **AES256** uses a 256-bit key.
  - **Null** uses no encryption.
- **Authentication Algorithm:** This displays the authentication algorithm used. The stronger the algorithm, the slower it is.
  - **MD5** gives minimal security.
  - **SHA1** gives higher security
  - **SHA256** gives the highest security..

The **Configuration for Secure Gateway** displays the configuration that the USG IPsec VPN Client will get from the USG.

Click **Save** to save the VPN rule.

#### 4.4.9 VPN Settings for Configuration Provisioning Advanced Wizard- Finish

Now the rule is configured on the USG. The Phase 1 rule settings appear in the **VPN > IPsec VPN > VPN Gateway** screen and the Phase 2 rule settings appear in the **VPN > IPsec VPN > VPN**

**Connection** screen. Enter the IP address of the USG in the USG IPsec VPN Client to get all these VPN settings automatically from the USG.

**Figure 65** VPN for Configuration Provisioning Advanced Wizard: Finish



Click **Close** to exit the wizard.

## 4.5 VPN Settings for L2TP VPN Settings Wizard

Use **VPN Settings for L2TP VPN Settings** to set up an L2TP VPN rule. Click **Configuration > Quick Setup > VPN Settings** and select **VPN Settings for L2TP VPN Settings** to see the following screen.

Figure 66 VPN Settings for L2TP VPN Settings Wizard: L2TP VPN Settings

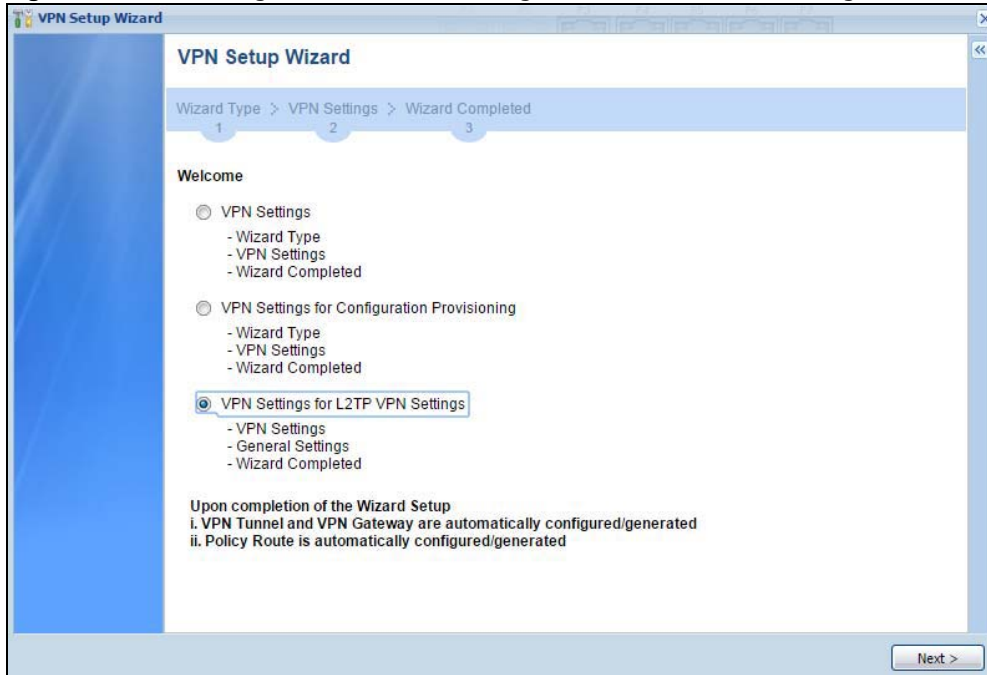

Click **Next** to continue the wizard.

## 4.5.1 L2TP VPN Settings

Figure 67 VPN Settings for L2TP VPN Settings Wizard: L2TP VPN Settings

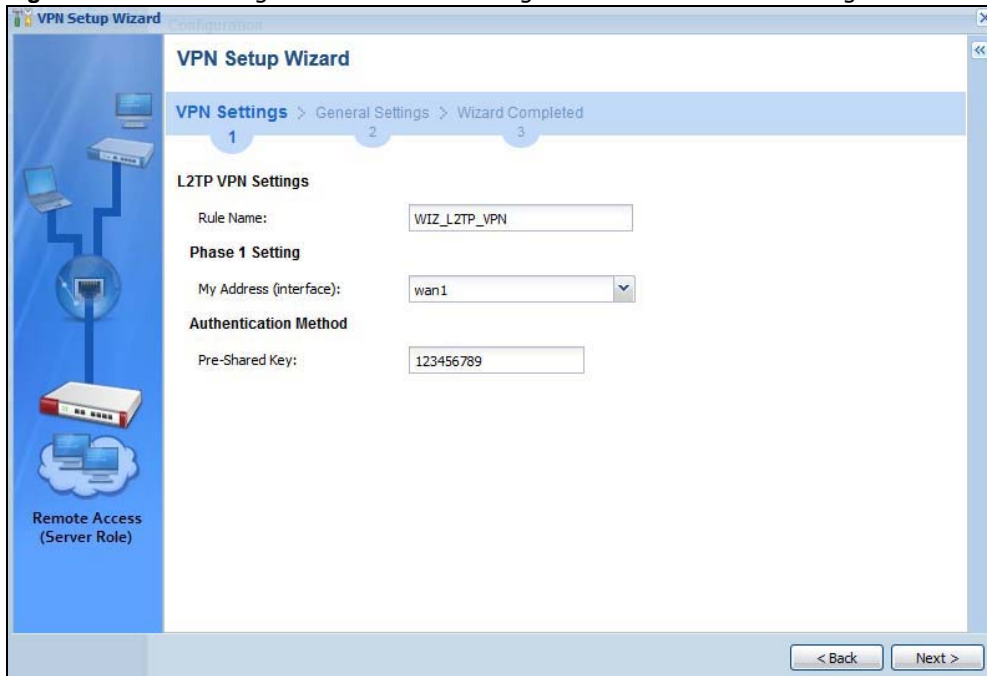

- **Rule Name:** Type the name used to identify this L2TP VPN connection (and L2TP VPN gateway). You may use 1-31 alphanumeric characters, underscores (\_), or dashes (-), but the first character cannot be a number. This value is case-sensitive.

- **My Address (interface):** Select one of the interfaces from the pull down menu to apply the L2TP VPN rule.
- **Pre-Shared Key:** Type the password. Both ends of the VPN tunnel must use the same password. Use 8 to 31 case-sensitive ASCII characters or 8 to 31 pairs of hexadecimal ("0-9", "A-F") characters. Proceed a hexadecimal key with "0x". You will receive a PYLD\_MALFORMED (payload malformed) packet if the same pre-shared key is not used on both ends.

Click **Next** to continue the wizard.

## 4.5.2 L2TP VPN Settings

**Figure 68** VPN Settings for L2TP VPN Settings Wizard: L2TP VPN Settings

- **IP Address Pool:** Select Range or Subnet from the pull down menu. This IP address pool is used to assign to the L2TP VPN clients.
- **Starting IP Address:** Enter the starting IP address in the field.
- **End IP Address:** Enter the ending IP address in the field.
- **First DNS Server (Optional):** Enter the first DNS server IP address in the field. Leave the field as 0.0.0.0 if you do not want to configure DNS servers. If you do not configure a DNS server you must know the IP address of a machine in order to access it.
- **Second DNS Server (Optional):** Enter the second DNS server IP address in the field. Leave the field as 0.0.0.0 if you do not want to configure DNS servers. If you do not configure a DNS server you must know the IP address of a machine in order to access it.
- **Allow L2TP traffic Through WAN:** Select this check box to allow traffic from L2TP clients to go to the Internet.

Click **Next** to continue the wizard.

Note: DNS (Domain Name System) is for mapping a domain name to its corresponding IP address and vice versa. The DNS server is extremely important because without it, you must know the IP address of a computer before you can access it. The USG uses a system DNS server (in the order you specify here) to resolve domain names for VPN, DDNS and the time server.

### 4.5.3 VPN Settings for L2TP VPN Setting Wizard - Summary

This is a read-only summary of the L2TP VPN settings.

**Figure 69** VPN Settings for L2TP VPN Settings Advanced Settings Wizard: Summary

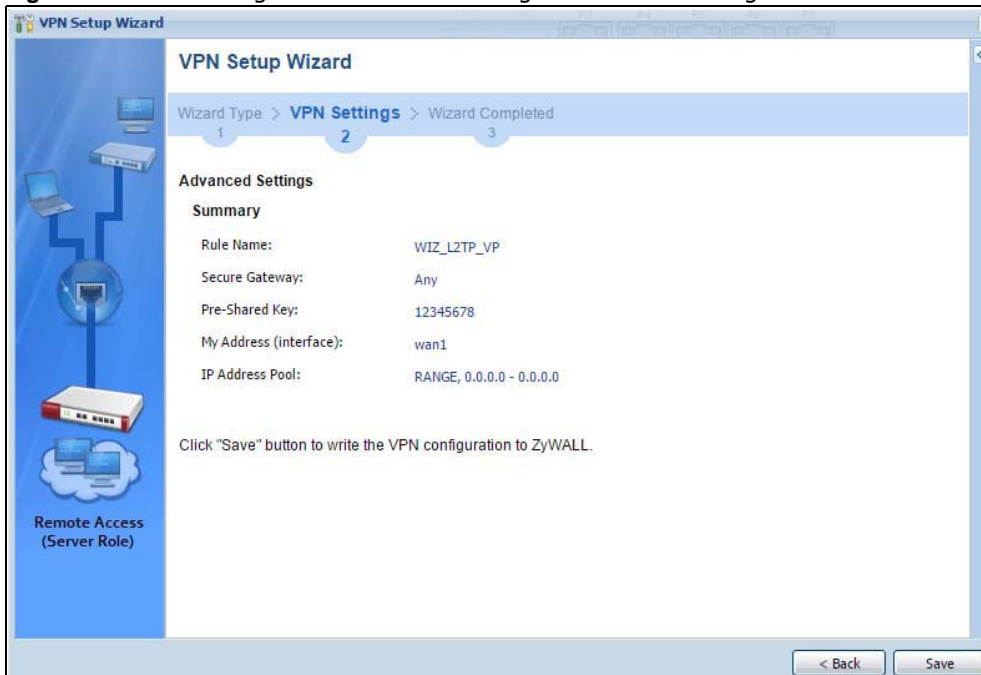

#### Summary

- **Rule Name:** Identifies the L2TP VPN connection (and the L2TP VPN gateway).
- **Secure Gateway:** “Any” displays in this field because it is not configurable in this wizard. It allows incoming connections from the L2TP VPN Client.
- **Pre-Shared Key:** L2TP VPN tunnel password.
- **My Address (Interface):** This displays the interface to use on your USG for the L2TP tunnel.
- **IP Address Pool:** This displays the IP address pool used to assign to the L2TP VPN clients.

Click **Save** to complete the L2TP VPN Setting and the following screen will show.



## 4.5.4 VPN Settings for L2TP VPN Setting Wizard Completed

Figure 70 VPN Settings for L2TP VPN Settings Wizard: Finish

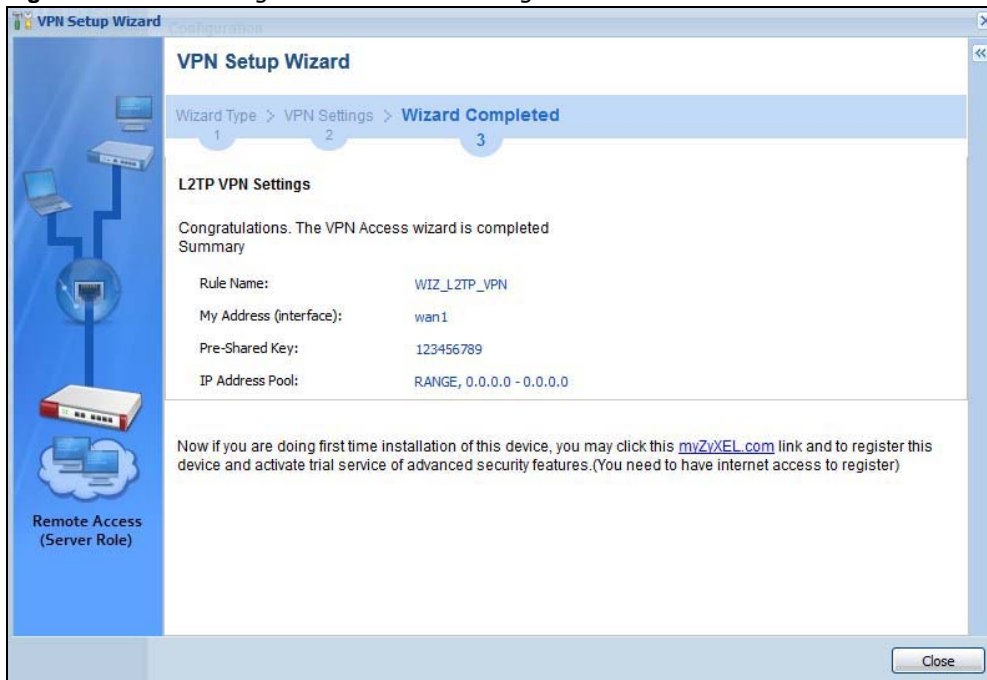

Now the rule is configured on the USG. The L2TP VPN rule settings appear in the **VPN > L2TP VPN** screen and also in the **VPN > IPSec VPN > VPN Connection** and **VPN Gateway** screen.

# Dashboard

## 5.1 Overview

Use the **Dashboard** screens to check status information about the USG.

### 5.1.1 What You Can Do in this Chapter

Use the main **Dashboard** screen to see the USG's general device information, system status, system resource usage, licensed service status, and interface status. You can also display other status screens for more information.

Use the **Dashboard** screens to view the following.

- [Device Information Screen on page 84](#)
- [System Status Screen on page 85](#)
- [VPN Status Screen on page 86](#)
- [DHCP Table Screen on page 87](#)
- [Number of Login Users Screen on page 88](#)
- [System Resources Screen on page 89](#)
- [CPU Usage Screen on page 90](#)
- [Memory Usage Screen on page 91](#)
- [Active Session Screen on page 92](#)
- [Extension Slot Screen on page 93](#)
- [Interface Status Summary Screen on page 93](#)
- [Secured Service Status Screen on page 94](#)
- [Content Filter Statistics Screen on page 95](#)
- [Top 5 IPv4/IPv6 Security Policy Rules that Blocked Traffic Screen on page 96](#)
- [Top 5 IPv4/IPv6 Security Policy Rules that Blocked Traffic Screen on page 96](#)
- [Top 5 IPv4/IPv6 Security Policy Rules that Blocked Traffic Screen on page 96](#)
- [The Latest Alert Logs Screen on page 96](#)

## 5.2 Main Dashboard Screen

The **Dashboard** screen displays when you log into the USG or click **Dashboard** in the navigation panel. The dashboard displays general device information, system status, system resource usage, licensed service status, and interface status in widgets that you can re-arrange to suit your needs. You can also collapse, refresh, and close individual widgets.

Click on the icon to go to the OneSecurity.com website where there is guidance on configuration walkthroughs, troubleshooting, and other information.

Figure 71 Dashboard

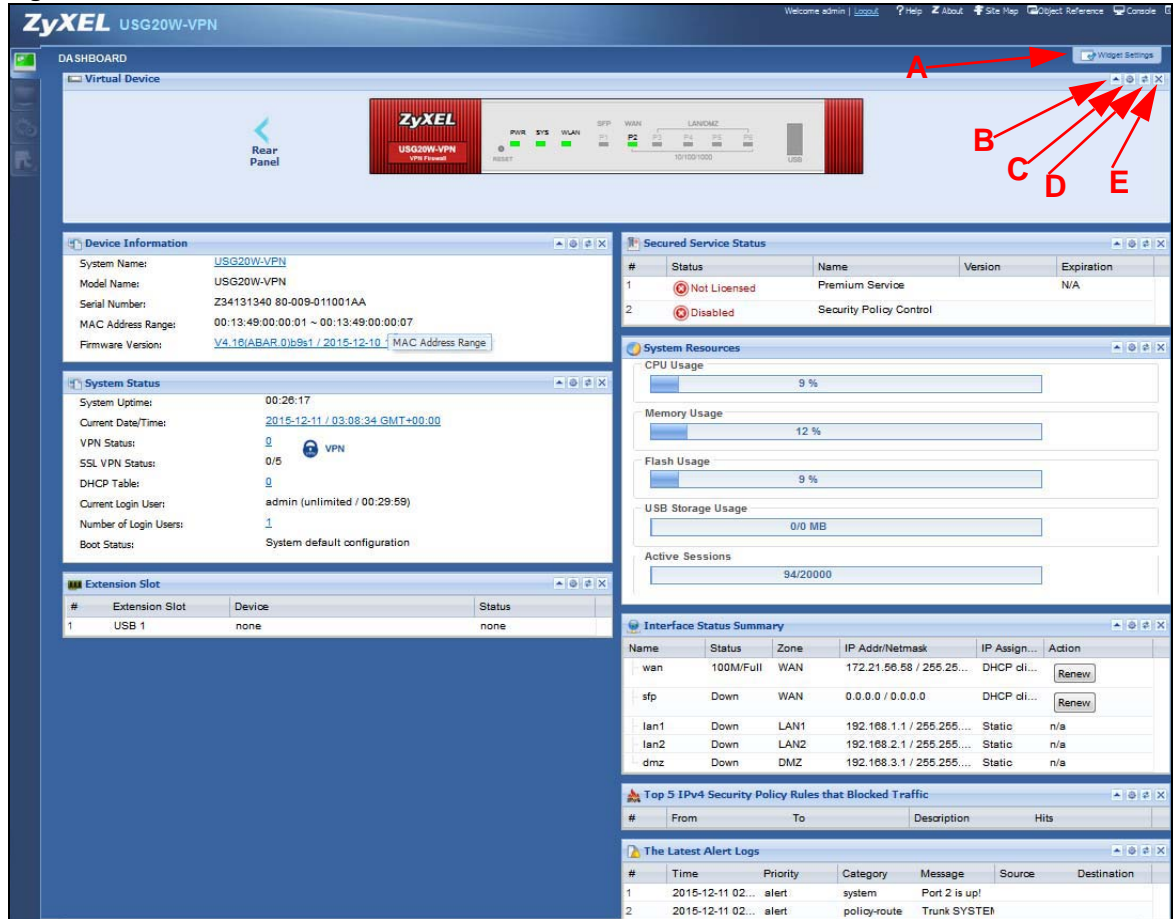

The following table describes the labels in this screen.

Table 16 Dashboard

LABEL	DESCRIPTION
Widget Settings (A)	Use this link to open or close widgets by selecting/clearing the associated checkbox.
expand / collapse widget (B)	Click this to collapse a widget. It then becomes a down arrow. Click it again to enlarge the widget again.
Refresh time setting (C)	Set the interval for refreshing the information displayed in the widget.
Refresh Now (D)	Click this to update the widget's information immediately.
Close widget (E)	Click this to close the widget. Use <b>Widget Setting</b> to re-open it.
Virtual Device	
Rear Panel	Click this to view details about the USG's rear panel. Hover your cursor over a connected interface or slot to display status details.

**Table 16** Dashboard (continued)

LABEL	DESCRIPTION
Front Panel	Click this to view details about the status of the USG's front panel LEDs and connections. See <a href="#">Section 3.1.1 on page 44</a> for LED descriptions. An unconnected interface or slot appears grayed out.
	The following front and rear panel labels display when you hover your cursor over a connected interface or slot.
Name	This field displays the name of each interface.
Status	<p>This field displays the current status of each interface or device installed in a slot. The possible values depend on what type of interface it is.</p> <p><b>Inactive</b> - The Ethernet interface is disabled.</p> <p><b>Down</b> - The Ethernet interface does not have any physical ports associated with it or the Ethernet interface is enabled but not connected.</p> <p><b>Speed / Duplex</b> - The Ethernet interface is enabled and connected. This field displays the port speed and duplex setting (<b>Full</b> or <b>Half</b>).</p> <p>The status for a WLAN card is <b>none</b>.</p> <p>For cellular (mobile broadband) interfaces, see <a href="#">Section 9.5 on page 173</a> for the status that can appear.</p> <p>For the auxiliary interface:</p> <p><b>Inactive</b> - The auxiliary interface is disabled.</p> <p><b>Connected</b> - The auxiliary interface is enabled and connected.</p> <p><b>Disconnected</b> - The auxiliary interface is not connected.</p>
Zone	This field displays the zone to which the interface is currently assigned.
IP Address/ Mask	This field displays the current IP address and subnet mask assigned to the interface. If the interface is a member of an active virtual router, this field displays the IP address it is currently using. This is either the static IP address of the interface (if it is the master) or the management IP address (if it is a backup).

## 5.2.1 Device Information Screen

The Device Information screen displays USG's system and model name, serial number, MAC address and firmware version shown in the below screen.

**Figure 72** Dashboard > Device Information (Example)

This table describes the fields in the above screen.

**Table 17** Dashboard > Device Information

LABEL	DESCRIPTION
Device Information	This identifies a device installed in one of the USG's extension slots, the Security Extension Module slot, or USB ports. For an installed SEM (Security Extension Module) card, this field displays what kind of SEM card is installed.  <b>SEM-VPN</b> - The VPN accelerator. The SEM-VPN provides 500 Mbps VPN throughput, 2,000 IPsec VPN tunnels, and 750 SSL VPN users.  <b>SEM-DUAL</b> - accelerator for both VPN and UTM. The SEM-DUAL provides the benefits of the SEM-VPN.
System Name	This field displays the name used to identify the USG on any network. Click the link and open the <b>Host Name</b> screen where you can edit and make changes to the system and domain name.
Model Name	This field displays the model name of this USG.
Serial Number	This field displays the serial number of this USG. The serial number is used for device tracking and control.
MAC Address Range	This field displays the MAC addresses used by the USG. Each physical port has one MAC address. The first MAC address is assigned to physical port 1, the second MAC address is assigned to physical port 2, and so on.
Firmware Version	This field displays the version number and date of the firmware the USG is currently running. Click the link to open the <b>Firmware Package</b> screen where you can upload firmware.

## 5.2.2 System Status Screen

**Figure 73** Dashboard > System Status (Example)

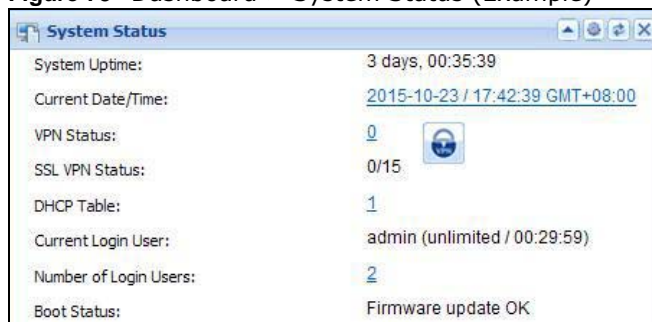

LABEL	DESCRIPTION
System Uptime:	3 days, 00:35:39
Current Date/Time:	<a href="#">2015-10-23 / 17:42:39 GMT+08:00</a>
VPN Status:	<a href="#">0</a> 
SSL VPN Status:	0/15
DHCP Table:	<a href="#">1</a>
Current Login User:	admin (unlimited / 00:29:59)
Number of Login Users:	<a href="#">2</a>
Boot Status:	Firmware update OK

This table describes the fields in the above screen.

**Table 18** Dashboard > System Status

LABEL	DESCRIPTION
System Uptime	This field displays how long the USG has been running since it last restarted or was turned on.
Current Date/Time	This field displays the current date and time in the USG. The format is yyyy-mm-dd hh:mm:ss. Click on the link to see the <b>Date/Time</b> screen where you can make edits and changes to the date, time and time zone information.
VPN Status	Click on the link to look at the VPN tunnels that are currently established. See <a href="#">Section 5.2.3 on page 86</a> . Click on the VPN icon to go to the ZyXEL VPN Client product page at the ZyXEL website.
SSL VPN Status	The first number is the actual number of VPN tunnels up and the second number is the maximum number of SSL VPN tunnels allowed.

**Table 18** Dashboard > System Status

LABEL	DESCRIPTION
DHCP Table	Click this to look at the IP addresses currently assigned to the USG's DHCP clients and the IP addresses reserved for specific MAC addresses. See <a href="#">Section 5.2.4 on page 87</a> .
Current Login User	This field displays the user name used to log in to the current session, the amount of reauthentication time remaining, and the amount of lease time remaining.
Number of Login Users	This field displays the number of users currently logged in to the USG. Click the icon to pop-open a list of the users who are currently logged in to the USG.
Boot Status	<p>This field displays details about the USG's startup state.</p> <p><b>OK</b> - The USG started up successfully.</p> <p><b>Firmware update OK</b> - A firmware update was successful.</p> <p><b>Problematic configuration after firmware update</b> - The application of the configuration failed after a firmware upgrade.</p> <p><b>System default configuration</b> - The USG successfully applied the system default configuration. This occurs when the USG starts for the first time or you intentionally reset the USG to the system default settings.</p> <p><b>Fallback to lastgood configuration</b> - The USG was unable to apply the startup-config.conf configuration file and fell back to the lastgood.conf configuration file.</p> <p><b>Fallback to system default configuration</b> - The USG was unable to apply the lastgood.conf configuration file and fell back to the system default configuration file (system-default.conf).</p> <p><b>Booting in progress</b> - The USG is still applying the system configuration.</p>

### 5.2.3 VPN Status Screen

Click on VPN Status link to look at the VPN tunnels that are currently established. The following screen will show.

**Figure 74** Dashboard > System Status > VPN Status

#	Name	Encapsulation	Algorithm

Refresh Interval: 5 minutes

This table describes the fields in the above screen.

**Table 19** Dashboard > System Status > VPN Status

TABLE	DESCRIPTION
#	This field is a sequential value, and it is not associated with a specific SA.
Name	This field displays the name of the IPsec SA.
Encapsulation	This field displays how the IPsec SA is encapsulated.
Algorithm	This field displays the encryption and authentication algorithms used in the SA.
Refresh Interval	Select how often you want this window to be updated automatically.
Refresh	Click this to update the information in the window right away.

ZyXEL VPN Client Product Page



## 5.2.4 DHCP Table Screen

Click on the DHCP Table link to look at the IP addresses currently assigned to DHCP clients and the IP addresses reserved for specific MAC addresses. The following screen will show.

**Figure 75** Dashboard > System Status > DHCP Table

#	Interface	IP Address	Host Name	MAC Address	Description	Reserve
1	lan1	192.168.30.33	"twpczt01650-01"	74:27:ea:2b:fa:aa		<input type="checkbox"/>
2	lan1	192.168.30.34	"twnb11477-05"	00:1c:25:9c:ac:ac		<input type="checkbox"/>

Refresh Interval: 5 minutes

This table describes the fields in the above screen.

**Table 20** Dashboard > System Status > DHCP Table

LABEL	DESCRIPTION
#	This field is a sequential value, and it is not associated with a specific entry.
Interface	This field identifies the interface that assigned an IP address to a DHCP client.
IP Address	This field displays the IP address currently assigned to a DHCP client or reserved for a specific MAC address. Click the column's heading cell to sort the table entries by IP address. Click the heading cell again to reverse the sort order.
Host Name	This field displays the name used to identify this device on the network (the computer name). The USG learns these from the DHCP client requests. "None" shows here for a static DHCP entry.
MAC Address	This field displays the MAC address to which the IP address is currently assigned or for which the IP address is reserved. Click the column's heading cell to sort the table entries by MAC address. Click the heading cell again to reverse the sort order.
Description	For a static DHCP entry, the host name or the description you configured shows here. This field is blank for dynamic DHCP entries.
Reserve	<p>If this field is selected, this entry is a static DHCP entry. The IP address is reserved for the MAC address.</p> <p>If this field is clear, this entry is a dynamic DHCP entry. The IP address is assigned to a DHCP client.</p> <p>To create a static DHCP entry using an existing dynamic DHCP entry, select this field, and then click <b>Apply</b>.</p> <p>To remove a static DHCP entry, clear this field, and then click <b>Apply</b>.</p>

## 5.2.5 Number of Login Users Screen

Click the Number of Login Users link to see the following screen.



**Figure 76** Dashboard > System Status > Number of Login Users

#	User ID	Reauth Lease T.	Type	IP Address	User Info	Force Logout
1	XIXIX	unlimited / unlimited	http/https	172.28.30.3X	admin(lilli...	Logout
2	XIXIX	unlimited / unlimited	http/https	172.28.30.3X	admin(lilli...	Logout
3	XIXIX	unlimited / unlimited	http/https	172.28.30.3X	admin(lilli...	Logout
4	XIXIX	unlimited / unlimited	http/https	172.28.30.3X	admin(lilli...	Logout

This table describes the fields in the above screen.

**Table 21** Dashboard > System Status > Number of Login Users

LABEL	DESCRIPTION
#	This field is a sequential value and is not associated with any entry.
User ID	This field displays the user name of each user who is currently logged in to the USG.
Reauth Lease T.	This field displays the amount of reauthentication time remaining and the amount of lease time remaining for each user.
Type	This field displays the way the user logged in to the USG.
IP address	This field displays the IP address of the computer used to log in to the USG.
User Info	This field displays the types of user accounts the USG uses. If the user type is <b>ext-user</b> (external user), this field will show its external-group information when you move your mouse over it.  If the external user matches two external-group objects, both external-group object names will be shown.
Force Logout	Click this icon to end a user's session.

## 5.2.6 System Resources Screen

Hover your mouse over an item and click the arrow on the right to see more details on that resource.

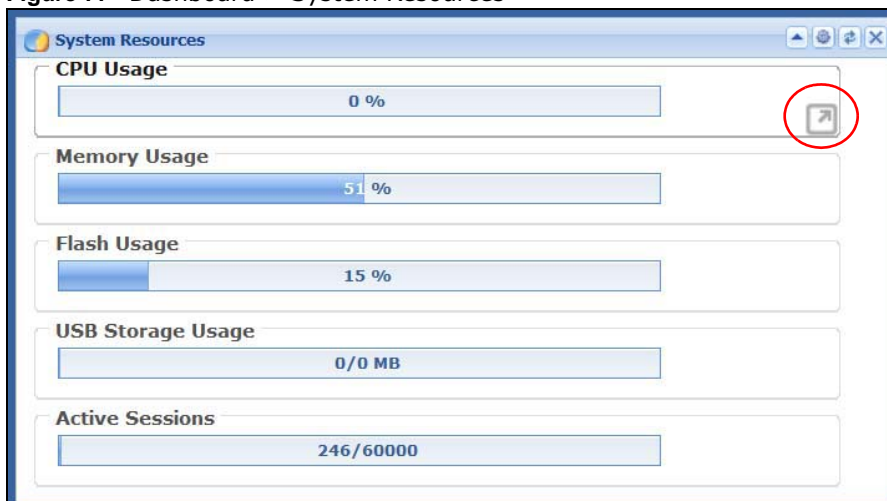
**Figure 77** Dashboard > System Resources

This table describes the fields in the above screen.

**Table 22** .Dashboard > System Resources

LABEL	DESCRIPTION
CPU Usage	This field displays what percentage of the USG's processing capability is currently being used. Hover your cursor over this field to display the <b>Show CPU Usage</b> icon that takes you to a chart of the USG's recent CPU usage.
Memory Usage	This field displays what percentage of the USG's RAM is currently being used. Hover your cursor over this field to display the <b>Show Memory Usage</b> icon that takes you to a chart of the USG's recent memory usage.
Flash Usage	This field displays what percentage of the USG's onboard flash memory is currently being used.
USB Storage Usage	This field shows how much storage in the USB device connected to the USG is in use.
Active Sessions	This field shows how many sessions, established and non-established, that pass through/from/to/within the USG. Hover your cursor over this field to display icons. Click the <b>Detail</b> icon to go to the <b>Session Monitor</b> screen to see details about the active sessions. Click the <b>Show Active Sessions</b> icon to display a chart of USG's recent session usage.

## 5.2.7 CPU Usage Screen

Use the below screen to look at a chart of the USG's recent CPU usage. To access this screen, click **CPU Usage** in the dashboard.

**Figure 78** Dashboard > CPU Usage screen

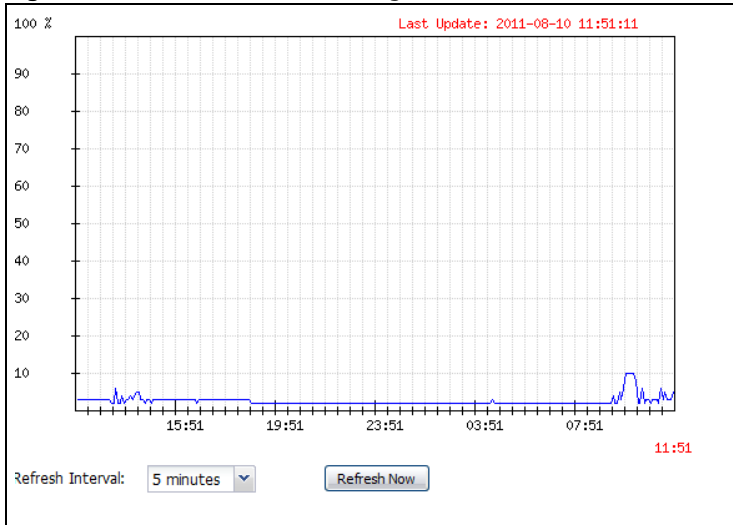

This table describes the fields in the above screen.

**Table 23** Dashboard > CPU Usage

LABEL	DESCRIPTION
	The y-axis represents the percentage of CPU usage.
	The x-axis shows the time period over which the CPU usage occurred
Refresh Interval	Enter how often you want this window to be automatically updated.
Refresh Now	Click this to update the information in the window right away.

## 5.2.8 Memory Usage Screen

Use the below screen to look at a chart of the USG’s recent memory (RAM) usage. To access this screen, click **Memory Usage** in the dashboard.

**Figure 79** Dashboard > Memory Usage screen



This table describes the fields in the above screen.

**Table 24** Dashboard > Memory Usage screen.

LABEL	DESCRIPTION
	The y-axis represents the percentage of RAM usage.
	The x-axis shows the time period over which the RAM usage occurred
Refresh Interval	Enter how often you want this window to be automatically updated.
Refresh Now	Click this to update the information in the window right away.

## 5.2.9 Active Session Screen

To see the details of Active Sessions, move the cursor to the far right of the Active Sessions box and the **Detail** and the **Show Active Session** icons appear. Click the **Show Active Session** icon.

**Figure 80** Dashboard > Active Sessions > Show Active Session



This table describes the fields in the above screen.

**Table 25** Dashboard > Active Sessions > Show Active Session

Sessions	The y-axis represents the number of session.
	The x-axis shows the time period over which the session usage occurred
Refresh Interval	Enter how often you want this window to be automatically updated.
Refresh Now	Click this to update the information in the window right away.

## 5.2.10 Extension Slot Screen

**Figure 81** Dashboard > Extension Slot



#	Extension Slot	Device	Status
1	USB 1	none	none

This table describes the fields in the above screen.

**Table 26** Dashboard > Extension Slot

LABEL	DESCRIPTION
#	
Extension Slot	This field displays the name of each extension slot.
Device	<p>This field displays the name of the device connected to the extension slot (or <b>none</b> if no device is detected). For an installed SEM (Security Extension Module) card, this field displays what kind of SEM card is installed.</p> <p><b>SEM-VPN</b> - The VPN accelerator. The SEM-VPN provides 500 Mbps VPN throughput, 2,000 IPSec VPN tunnels, and 750 SSL VPN users.</p> <p><b>SEM-DUAL</b> - accelerator for both VPN and UTM. The SEM-DUAL provides the benefits of the SEM-VPN.</p> <p><b>USB Flash Drive</b> - Indicates a connected USB storage device and the drive's storage capacity.</p>
Status	<p>The status for an installed WLAN card is <b>none</b>. For cellular (mobile broadband) interfaces, see <a href="#">Section 6.10 on page 112</a> for the status that can appear. For an installed SEM (Security Extension Module) card, this field displays one of the following:</p> <p><b>Active</b> - The SEM card is working properly.</p> <p><b>Ready to activate</b> - The SEM was inserted while the USG was operating. Restart the USG to use the SEM.</p> <p><b>Driver load failed</b> - An error occurred during the USG's attempt to activate the SEM card. Make sure the SEM is installed properly and the thumbscrews are tightened. If this status still displays, contact your vendor.</p> <p>Ready - A USB storage device connected to the USG is ready for the USG to use.</p> <p><b>Unused</b> - The USG is unable to mount a USB storage device connected to the USG.</p>

## 5.2.11 Interface Status Summary Screen

Interfaces per USG model vary.

**Figure 82** Dashboard > Interface Status Summary

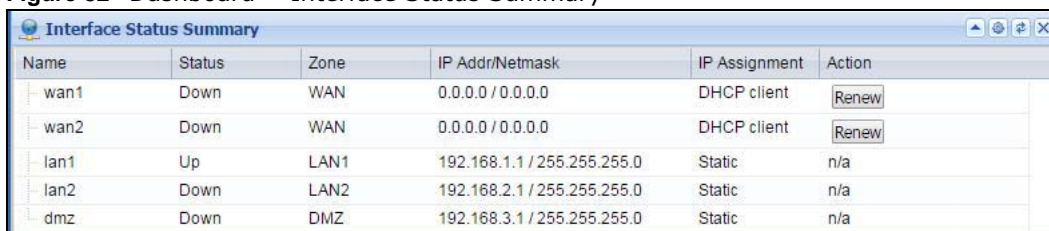

Name	Status	Zone	IP Addr/Netmask	IP Assignment	Action
wan1	Down	WAN	0.0.0.0 / 0.0.0.0	DHCP client	<input type="button" value="Renew"/>
wan2	Down	WAN	0.0.0.0 / 0.0.0.0	DHCP client	<input type="button" value="Renew"/>
lan1	Up	LAN1	192.168.1.1 / 255.255.255.0	Static	n/a
lan2	Down	LAN2	192.168.2.1 / 255.255.255.0	Static	n/a
dmz	Down	DMZ	192.168.3.1 / 255.255.255.0	Static	n/a

This table describes the fields in the above screen.

**Table 27** Dashboard > Interface Status Summary

LABEL	DESCRIPTION
Name	This field displays the name of each interface.
Status	<p>This field displays the current status of each interface. The possible values depend on what type of interface it is.</p> <p>For Ethernet interfaces:</p> <p><b>Inactive</b> - The Ethernet interface is disabled.</p> <p><b>Down</b> - The Ethernet interface does not have any physical ports associated with it or the Ethernet interface is enabled but not connected.</p> <p><b>Speed / Duplex</b> - The Ethernet interface is enabled and connected. This field displays the port speed and duplex setting (<b>Full</b> or <b>Half</b>).</p> <p>For cellular (mobile broadband) interfaces, see <a href="#">Section 6.10 on page 112</a> for the status that can appear.</p> <p>For the auxiliary interface:</p> <p><b>Inactive</b> - The auxiliary interface is disabled.</p> <p><b>Connected</b> - The auxiliary interface is enabled and connected.</p> <p><b>Disconnected</b> - The auxiliary interface is not connected.</p> <p>For PPP interfaces:</p> <p><b>Connected</b> - The PPP interface is connected.</p> <p><b>Disconnected</b> - The PPP interface is not connected.</p> <p>If the PPP interface is disabled, it does not appear in the list.</p> <p>For WLAN interfaces:</p> <p><b>Up</b> - The WLAN interface is enabled.</p> <p><b>Down</b> - The WLAN interface is disabled.</p>
Zone	This field displays the zone to which the interface is currently assigned.
IP Addr/Netmask	<p>This field displays the current IP address and subnet mask assigned to the interface. If the IP address is 0.0.0.0/0.0.0.0, the interface is disabled or did not receive an IP address and subnet mask via DHCP.</p> <p>If this interface is a member of an active virtual router, this field displays the IP address it is currently using. This is either the static IP address of the interface (if it is the master) or the management IP address (if it is a backup).</p>
IP Assignment	This field displays the interface's IP assignment. It will show <b>DHCP</b> or <b>Static</b> .
Action	<p>Use this field to get or to update the IP address for the interface.</p> <p>Click <b>Renew</b> to send a new DHCP request to a DHCP server.</p> <p>Click the <b>Connect</b> icon to have the USG try to connect a PPPoE/PPTP interface. If the interface cannot use one of these ways to get or to update its IP address, this field displays <b>n/a</b>.</p> <p>Click the <b>Disconnect</b> icon to stop a PPPoE/PPTP connection.</p>

## 5.2.12 Secured Service Status Screen

This part shows what security services are available and enabled.

**Figure 83** Dashboard > Secured Service Status

#	Status	Name	Version	Expiration
1	Licensed	Premium Service		N/A
2	Not Licensed	Anti-Spam		0
3	Expired	Content Filter		0
4	Enabled	Security Policy Control		

This table describes the fields in the above screen.

**Table 28** Dashboard > Secured Service Status

LABEL	DESCRIPTION
#	This field is a sequential value, and it is not associated with a specific status.
Status	This field displays the status of the USG's security services. It will show these types of status: <b>Licensed</b> , <b>Unlicensed</b> , <b>Disabled</b> or <b>Enabled</b> .
Name	This field displays the name of security services supported by this model. <b>Status</b> will show <b>Licensed</b> for <b>Premium Service</b> after you register the device at myZyXEL.com. You can then activate security service licenses such as Anti-Spam, Content Filter and so on.
Version	This field displays the version number of the services.
Expiration	This field displays the number of days remaining before the license expires.

### 5.2.13 Content Filter Statistics Screen

Configure **Configuration > UTM Profile > Content Filter** and then view results here.

**Figure 84** Dashboard > Content Filter Statistics

Web Request Statistics	
Total Web Pages Inspected:	0
Blocked:	0
Warned:	0
Passed:	0
Category Hit Summary	
Security Threat (unsafe):	0
Managed Web Pages:	0

This table describes the fields in the above screen.

**Table 29** Dashboard > Content Filter Statistics

LABEL	DESCRIPTION
Web Request Statistics	
Total Web Pages Inspected	This is the number of web pages the USG has checked to see whether they belong to the categories you selected in the content filter screen.

**Table 29** Dashboard > Content Filter Statistics

LABEL	DESCRIPTION
Blocked	This is the number of web pages that the USG blocked access.
Warned	This is the number of web pages for which the USG has displayed a warning message to the access requesters.
Passed	This is the number of web pages that the USG allowed access.
Category Hit Summary	
Security Threat (unsafe)	This is the number of requested web pages that belong to the unsafe categories you have selected in the content filter screen.
Managed Web pages	This is the number of requested web pages that belong to the managed categories you have selected in the content filter screen.

## 5.2.14 Top 5 IPv4/IPv6 Security Policy Rules that Blocked Traffic Screen

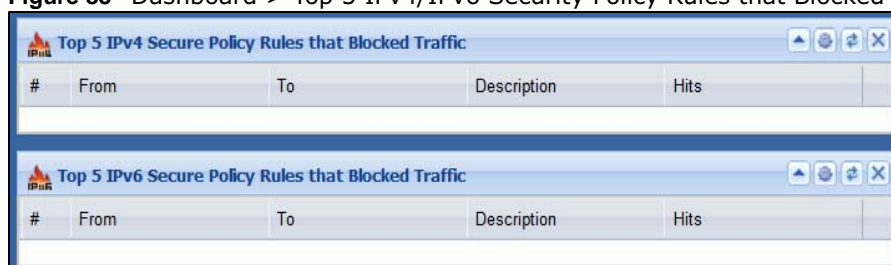
**Figure 85** Dashboard > Top 5 IPv4/IPv6 Security Policy Rules that Blocked Traffic

The figure shows two screenshots of the dashboard. The top screenshot is titled 'Top 5 IPv4 Secure Policy Rules that Blocked Traffic' and the bottom screenshot is titled 'Top 5 IPv6 Secure Policy Rules that Blocked Traffic'. Both screenshots show a table with the following columns: #, From, To, Description, and Hits.

This table describes the fields in the above screen.

**Table 30** Dashboard > Top 5 IPv4/IPv6 Security Policy Rules that Blocked Traffic

LABEL	DESCRIPTION
#	This is the entry's rank in the list of the most commonly triggered security policies.
From	This shows the zone packets came from that the triggered security policy.
To	This shows the zone packets went to that the triggered security policy.
Description	This field displays the descriptive name (if any) of the triggered security policy.
Hits	This field displays how many times the security policy was triggered.

## 5.2.15 The Latest Alert Logs Screen

**Figure 86** Dashboard > The Latest Alert Logs

The figure shows a screenshot of the 'The Latest Alert Logs' screen. It displays a table with the following columns: #, Time, Priority, Category, Message, Source, and Destination. The table contains five rows of alert logs.

#	Time	Priority	Category	Message	Source	Destination
1	2013-12-20 04:4...	alert	system	Port 6 is down!		
2	2013-12-20 04:4...	alert	system	Port 5 is down!		
3	2013-12-20 04:4...	alert	system	Port 4 is down!		
4	2013-12-20 04:4...	alert	system	Port 3 is up!		
5	2013-12-20 04:4...	alert	system	Port 2 is down!		



This table describes the fields in the above screen.

**Table 31** Dashboard > The Latest Alert Logs

<b>LABEL</b>	<b>DESCRIPTION</b>
#	This is the entry's rank in the list of alert logs.
Time	This field displays the date and time the log was created.
Priority	This field displays the severity of the log.
Category	This field displays the type of log generated.
Message	This field displays the actual log message.
Source	This field displays the source address (if any) in the packet that generated the log.
Destination	This field displays the destination address (if any) in the packet that generated the log.
Source Interface	This field displays the incoming interface of the packet that generated the log.

---

# **PART II**

## **Technical Reference**

---



## 6.1 Overview

Use the **Monitor** screens to check status and statistics information.

### 6.1.1 What You Can Do in this Chapter

Use the **Monitor** screens for the following.

- Use the **System Status > Port Statistics** screen (see [Section 6.2 on page 101](#)) to look at packet statistics for each physical port.
- Use the **System Status > Port Statistics > Graph View** screen (see [Section 6.2 on page 101](#)) to look at a line graph of packet statistics for each physical port.
- Use the **System Status > Interface Status** screen ([Section 6.3 on page 103](#)) to see all of the USG's interfaces and their packet statistics.
- Use the **System Status > Traffic Statistics** screen (see [Section 6.4 on page 105](#)) to start or stop data collection and view statistics.
- Use the **System Status > Session Monitor** screen (see [Section 6.5 on page 108](#)) to view sessions by user or service.
- Use the **System Status > IGMP Statistics** screen (see [Section 6.6 on page 109](#)) to view multicasting details.
- Use the **System Status > DDNS Status** screen (see [Section 6.7 on page 110](#)) to view the status of the USG's DDNS domain names.
- Use the **System Status > IP/MAC Binding** screen ([Section 6.8 on page 111](#)) to view a list of devices that have received an IP address from USG interfaces with IP/MAC binding enabled.
- Use the **System Status > Login Users** screen ([Section 6.9 on page 111](#)) to look at a list of the users currently logged into the USG.
- Use the **System Status > Cellular Status** screen ([Section 6.10 on page 112](#)) to check your mobile broadband connection status.
- Use the **System Status > UPnP Port Status** screen (see [Section 6.11 on page 114](#)) to look at a list of the NAT port mapping rules that UPnP creates on the USG.
- Use the **System Status > USB Storage** screen ([Section 6.12 on page 115](#)) to view information about a connected USB storage device.
- Use the **System Status > Ethernet Neighbor** screen ([Section 6.13 on page 116](#)) to view and manage the USG's neighboring devices via Layer Link Discovery Protocol (LLDP).
- Use the **Wireless > AP Information** screen ([Section 6.14.1 on page 117](#)) to view information on connected APs.
- Use the **Wireless > Station Info** screen ([Section 6.14.3 on page 120](#)) to view information on connected wireless stations.
- Use the **Wireless > Detected Device** screen ([Section 6.14.3 on page 120](#)) to view information about suspected rogue APs.

- Use the **VPN Monitor > IPSec** screen (Section 6.15 on page 122) to display and manage active IPSec SAs.
- Use the **VPN Monitor > SSL** screen (see Section 6.16 on page 123) to list the users currently logged into the VPN SSL client portal. You can also log out individual users and delete related session information.
- Use the **VPN Monitor > L2TP over IPSec** screen (see Section 6.17 on page 124) to display and manage the USG's connected L2TP VPN sessions.
- Use the **UTM Statistics > Content Filter** screen (Section 6.18 on page 125) to start or stop data collection and view content filter statistics.
- Use the **UTM Statistics > Anti-Spam** screen (Section 6.19 on page 127) to start or stop data collection and view spam statistics.
- Use the **UTM Statistics > Anti-Spam > Status** screen (Section 6.19.2 on page 129) to see how many mail sessions the USG is currently checking and DNSBL statistics.
- Use the **Log** screens (Section 6.20 on page 130) to view the USG's current log messages. You can change the way the log is displayed, you can e-mail the log, and you can also clear the log in this screen.

## 6.2 The Port Statistics Screen

Use this screen to look at packet statistics for each Gigabit Ethernet port. To access this screen, click **Monitor > System Status > Port Statistics**.

**Figure 87** Monitor > System Status > Port Statistics

#	Port	Status	TxPkts	RxPkts	Collisions	Tx B/s	Rx B/s	Up Time
1	1	Down	0	0	0	0	0	00:00:00
2	2	100M/Full	43408	961210	0	57	1758	46:07:52
3	3	Down	0	0	0	0	0	00:00:00
4	4	Down	0	0	0	0	0	00:00:00
5	5	Down	0	0	0	0	0	00:00:00

The following table describes the labels in this screen.

**Table 32** Monitor > System Status > Port Statistics

LABEL	DESCRIPTION
Poll Interval	Enter how often you want this window to be updated automatically, and click <b>Set Interval</b> .
Set Interval	Click this to set the <b>Poll Interval</b> the screen uses.
Stop	Click this to stop the window from updating automatically. You can start it again by setting the <b>Poll Interval</b> and clicking <b>Set Interval</b> .
Switch to Graphic View	Click this to display the port statistics as a line graph.

**Table 32** Monitor > System Status > Port Statistics (continued)

LABEL	DESCRIPTION
#	This field is a sequential value, and it is not associated with a specific port.
Port	This field displays the physical port number.
Status	This field displays the current status of the physical port.  <b>Down</b> - The physical port is not connected.  <b>Speed / Duplex</b> - The physical port is connected. This field displays the port speed and duplex setting ( <b>Full</b> or <b>Half</b> ).
TxPkts	This field displays the number of packets transmitted from the USG on the physical port since it was last connected.
RxPkts	This field displays the number of packets received by the USG on the physical port since it was last connected.
Collisions	This field displays the number of collisions on the physical port since it was last connected.
Tx B/s	This field displays the transmission speed, in bytes per second, on the physical port in the one-second interval before the screen updated.
Rx B/s	This field displays the reception speed, in bytes per second, on the physical port in the one-second interval before the screen updated.
Up Time	This field displays how long the physical port has been connected.
System Up Time	This field displays how long the USG has been running since it last restarted or was turned on.

## 6.2.1 The Port Statistics Graph Screen

Use this screen to look at a line graph of packet statistics for each physical port. To access this screen, click **Port Statistics** in the **Status** screen and then the **Switch to Graphic View Button**.

**Figure 88** Monitor > System Status > Port Statistics > Switch to Graphic View

The following table describes the labels in this screen.

**Table 33** Monitor > System Status > Port Statistics > Switch to Graphic View

LABEL	DESCRIPTION
Refresh Interval	Enter how often you want this window to be automatically updated.
Refresh Now	Click this to update the information in the window right away.
Port Selection	Select the number of the physical port for which you want to display graphics.
Switch to Grid View	Click this to display the port statistics as a table.
bps	The y-axis represents the speed of transmission or reception.
time	The x-axis shows the time period over which the transmission or reception occurred
TX	This line represents traffic transmitted from the USG on the physical port since it was last connected.
RX	This line represents the traffic received by the USG on the physical port since it was last connected.
Last Update	This field displays the date and time the information in the window was last updated.
System Up Time	This field displays how long the USG has been running since it last restarted or was turned on.

## 6.3 Interface Status Screen

This screen lists all of the USG's interfaces and gives packet statistics for them. Click **Monitor > System Status > Interface Status** to access this screen.

**Figure 89** Monitor > System Status > Interface Status

Interface Summary							
Interface Status							
Name	Port	Status	Zone	IP Addr/Netmask	IP Assignment	Services	Action
wan1	P1	Down	WAN	0.0.0.0 / 0.0.0.0	DHCP client	n/a	Renew
wan1_ppp	P1	Inactive	WAN	0.0.0.0 / 0.0.0.0	Dynamic	n/a	n/a
wan2	P2	Down	WAN	0.0.0.0 / 0.0.0.0	DHCP client	n/a	Renew
wan2_ppp	P2	Inactive	WAN	0.0.0.0 / 0.0.0.0	Dynamic	n/a	n/a
lan1	P3, P4, P5, P6	Up	LAN1	192.168.1.1 / 255.255.255.0	Static	DHCP server	n/a
lan2	n/a	Down	LAN2	192.168.2.1 / 255.255.255.0	Static	DHCP server	n/a
dmz	n/a	Down	DMZ	192.168.3.1 / 255.255.255.0	Static	DHCP server	n/a

Tunnel Interface Status						
Name	Status	Zone	IP Address	My Address	Remote Gateway Address	Mode

Interface Statistics						
Refresh						
Name	Status	TxPkts	RxPkts	Tx B/s	Rx B/s	
wan1	Down	0	0	0	0	
wan2	Down	2	0	0	0	
lan1	Up	7234	7320	0	0	
lan2	Down	0	0	0	0	
dmz	Down	1	0	0	0	

Each field is described in the following table.

**Table 34** Monitor > System Status > Interface Status

LABEL	DESCRIPTION
Interface Status	If an Ethernet interface does not have any physical ports associated with it, its entry is displayed in light gray text.
Name	This field displays the name of each interface. If there is an <b>Expand</b> icon (plus-sign) next to the name, click this to look at the status of virtual interfaces on top of this interface.
Port	This field displays the physical port number.
Status	<p>This field displays the current status of each interface. The possible values depend on what type of interface it is.</p> <p>For Ethernet interfaces:</p> <ul style="list-style-type: none"> <li>• <b>Inactive</b> - The Ethernet interface is disabled.</li> <li>• <b>Down</b> - The Ethernet interface does not have any physical ports associated with it or the Ethernet interface is enabled but not connected.</li> <li>• <b>Speed / Duplex</b> - The Ethernet interface is enabled and connected. This field displays the port speed and duplex setting (<b>Full</b> or <b>Half</b>).</li> </ul> <p>For cellular (mobile broadband) interfaces, see <a href="#">Section 6.12 on page 115</a> the Web Help for the status that can appear.</p> <p>For the auxiliary interface:</p> <ul style="list-style-type: none"> <li>• <b>Inactive</b> - The auxiliary interface is disabled.</li> <li>• <b>Connected</b> - The auxiliary interface is enabled and connected.</li> <li>• <b>Disconnected</b> - The auxiliary interface is not connected.</li> </ul> <p>For virtual interfaces, this field always displays <b>Up</b>. If the virtual interface is disabled, it does not appear in the list.</p> <p>For VLAN and bridge interfaces, this field always displays <b>Up</b>. If the VLAN or bridge interface is disabled, it does not appear in the list.</p> <p>For PPP interfaces:</p> <ul style="list-style-type: none"> <li>• <b>Connected</b> - The PPP interface is connected.</li> <li>• <b>Disconnected</b> - The PPP interface is not connected.</li> </ul> <p>If the PPP interface is disabled, it does not appear in the list.</p> <p>For WLAN interfaces:</p> <ul style="list-style-type: none"> <li>• <b>Up</b> - The WLAN interface is enabled.</li> <li>• <b>Down</b> - The WLAN interface is disabled.</li> </ul>
Zone	This field displays the zone to which the interface is assigned.
IP Addr/Netmask	<p>This field displays the current IP address and subnet mask assigned to the interface. If the IP address and subnet mask are 0.0.0.0, the interface is disabled or did not receive an IP address and subnet mask via DHCP.</p> <p>If this interface is a member of an active virtual router, this field displays the IP address it is currently using. This is either the static IP address of the interface (if it is the master) or the management IP address (if it is a backup).</p>
IP Assignment	<p>This field displays how the interface gets its IP address.</p> <ul style="list-style-type: none"> <li>• <b>Static</b> - This interface has a static IP address.</li> <li>• <b>DHCP Client</b> - This interface gets its IP address from a DHCP server.</li> </ul>
Services	This field lists which services the interface provides to the network. Examples include <b>DHCP relay</b> , <b>DHCP server</b> , <b>DDNS</b> , <b>RIP</b> , and <b>OSPF</b> . This field displays <b>n/a</b> if the interface does not provide any services to the network.



**Table 34** Monitor > System Status > Interface Status (continued)

LABEL	DESCRIPTION
Action	Use this field to get or to update the IP address for the interface. Click <b>Renew</b> to send a new DHCP request to a DHCP server. Click <b>Connect</b> to try to connect a PPPoE/PPTP interface. If the interface cannot use one of these ways to get or to update its IP address, this field displays <b>n/a</b> .
Tunnel Interface Status	This displays the details of the USG's configured tunnel interfaces.
Name	This field displays the name of the interface.
Status	The activate (light bulb) icon is lit when the entry is active and dimmed when the entry is inactive.
Zone	This field displays the zone to which the interface is assigned.
IP Address	This is the IP address of the interface. If the interface is active (and connected), the USG tunnels local traffic sent to this IP address to the <b>Remote Gateway Address</b> .
My Address	This is the interface or IP address uses to identify itself to the remote gateway. The USG uses this as the source for the packets it tunnels to the remote gateway.
Remote Gateway Address	This is the IP address or domain name of the remote gateway to which this interface tunnels traffic.
Mode	This field displays the tunnel mode that you are using.
Interface Statistics	This table provides packet statistics for each interface.
Refresh	Click this button to update the information in the screen.
Name	This field displays the name of each interface. If there is a <b>Expand</b> icon (plus-sign) next to the name, click this to look at the statistics for virtual interfaces on top of this interface.
Status	This field displays the current status of the interface. <ul style="list-style-type: none"> <li>• <b>Down</b> - The interface is not connected.</li> <li>• <b>Speed / Duplex</b> - The interface is connected. This field displays the port speed and duplex setting (<b>Full</b> or <b>Half</b>).</li> </ul> This field displays <b>Connected</b> and the accumulated connection time (hh:mm:ss) when the PPP interface is connected.
TxPkts	This field displays the number of packets transmitted from the USG on the interface since it was last connected.
RxPkts	This field displays the number of packets received by the USG on the interface since it was last connected.
Tx B/s	This field displays the transmission speed, in bytes per second, on the interface in the one-second interval before the screen updated.
Rx B/s	This field displays the reception speed, in bytes per second, on the interface in the one-second interval before the screen updated.

## 6.4 The Traffic Statistics Screen

Click **Monitor > System Status > Traffic Statistics** to display the **Traffic Statistics** screen. This screen provides basic information about the following for example:

- Most-visited Web sites and the number of times each one was visited. This count may not be accurate in some cases because the USG counts HTTP GET packets. Please see [Table 35 on page 106](#) for more information.
- Most-used protocols or service ports and the amount of traffic on each one

- LAN IP with heaviest traffic and how much traffic has been sent to and from each one

You use the **Traffic Statistics** screen to tell the USG when to start and when to stop collecting information for these reports. You cannot schedule data collection; you have to start and stop it manually in the **Traffic Statistics** screen.

**Figure 90** Monitor > System Status > Traffic Statistics

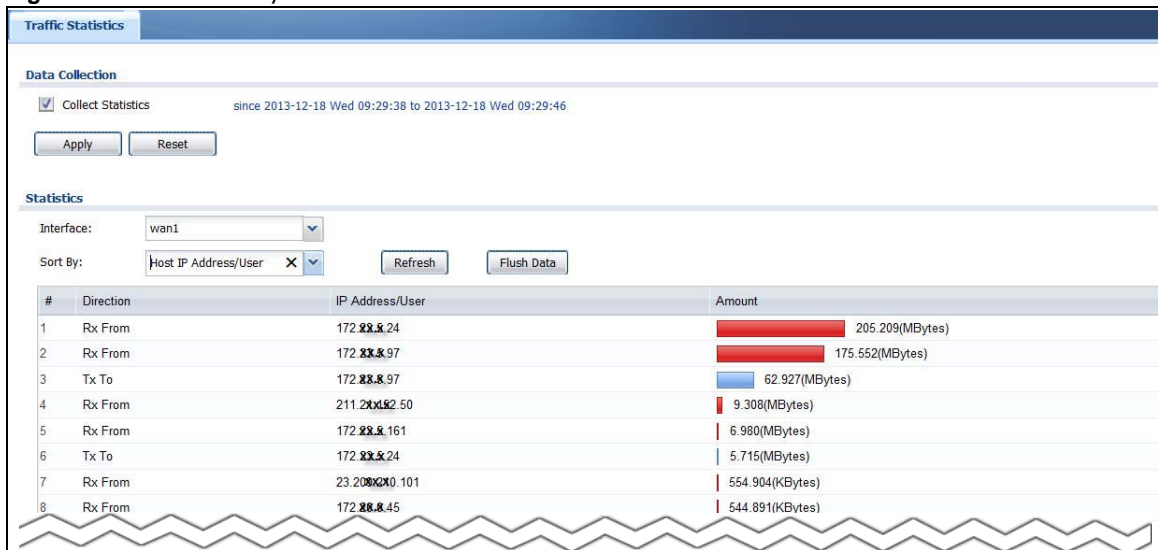

There is a limit on the number of records shown in the report. Please see [Table 36 on page 107](#) for more information. The following table describes the labels in this screen.

**Table 35** Monitor > System Status > Traffic Statistics

LABEL	DESCRIPTION
Data Collection	
Collect Statistics	Select this to have the USG collect data for the report. If the USG has already been collecting data, the collection period displays to the right. The progress is not tracked here real-time, but you can click the <b>Refresh</b> button to update it.
Apply	Click <b>Apply</b> to save your changes back to the USG.
Reset	Click <b>Reset</b> to return the screen to its last-saved settings.
Statistics	
Interface	Select the interface from which to collect information. You can collect information from Ethernet, VLAN, bridge and PPPoE/PPTP interfaces.
Sort By	Select the type of report to display. Choices are: <ul style="list-style-type: none"> <li>• <b>Host IP Address/User</b> - displays the IP addresses or users with the most traffic and how much traffic has been sent to and from each one.</li> <li>• <b>Service/Port</b> - displays the most-used protocols or service ports and the amount of traffic for each one.</li> <li>• <b>Web Site Hits</b> - displays the most-visited Web sites and how many times each one has been visited.</li> </ul> Each type of report has different information in the report (below).
Refresh	Click this button to update the report display.
Flush Data	Click this button to discard all of the screen's statistics and update the report display.
	These fields are available when the <b>Traffic Type</b> is <b>Host IP Address/User</b> .
#	This field is the rank of each record. The IP addresses and users are sorted by the amount of traffic.

**Table 35** Monitor > System Status > Traffic Statistics (continued)

LABEL	DESCRIPTION
Direction	This field indicates whether the IP address or user is sending or receiving traffic. <ul style="list-style-type: none"> <li>• <b>Ingress</b>- traffic is coming from the IP address or user to the USG.</li> <li>• <b>Egress</b> - traffic is going from the USG to the IP address or user.</li> </ul>
IP Address/User	This field displays the IP address or user in this record. The maximum number of IP addresses or users in this report is indicated in <a href="#">Table 36 on page 107</a> .
Amount	This field displays how much traffic was sent or received from the indicated IP address or user. If the <b>Direction</b> is <b>Ingress</b> , a red bar is displayed; if the <b>Direction</b> is <b>Egress</b> , a blue bar is displayed. The unit of measure is bytes, Kbytes, Mbytes or Gbytes, depending on the amount of traffic for the particular IP address or user. The count starts over at zero if the number of bytes passes the byte count limit. See <a href="#">Table 36 on page 107</a> .
	These fields are available when the <b>Traffic Type</b> is <b>Service/Port</b> .
#	This field is the rank of each record. The protocols and service ports are sorted by the amount of traffic.
Service/Port	This field displays the service and port in this record. The maximum number of services and service ports in this report is indicated in <a href="#">Table 36 on page 107</a> .
Protocol	This field indicates what protocol the service was using.
Direction	This field indicates whether the indicated protocol or service port is sending or receiving traffic. <ul style="list-style-type: none"> <li>• <b>Ingress</b> - traffic is coming into the router through the interface</li> <li>• <b>Egress</b> - traffic is going out from the router through the interface</li> </ul>
Amount	This field displays how much traffic was sent or received from the indicated service / port. If the <b>Direction</b> is <b>Ingress</b> , a red bar is displayed; if the <b>Direction</b> is <b>Egress</b> , a blue bar is displayed. The unit of measure is bytes, Kbytes, Mbytes, or Tbytes, depending on the amount of traffic for the particular protocol or service port. The count starts over at zero if the number of bytes passes the byte count limit. See <a href="#">Table 36 on page 107</a> .
	These fields are available when the <b>Traffic Type</b> is <b>Web Site Hits</b> .
#	This field is the rank of each record. The domain names are sorted by the number of hits.
Web Site	This field displays the domain names most often visited. The USG counts each page viewed on a Web site as another hit. The maximum number of domain names in this report is indicated in <a href="#">Table 36 on page 107</a> .
Hits	This field displays how many hits the Web site received. The USG counts hits by counting HTTP GET packets. Many Web sites have HTTP GET references to other Web sites, and the USG counts these as hits too. The count starts over at zero if the number of hits passes the hit count limit. See <a href="#">Table 36 on page 107</a> .

The following table displays the maximum number of records shown in the report, the byte count limit, and the hit count limit.

**Table 36** Maximum Values for Reports

LABEL	DESCRIPTION
Maximum Number of Records	20
Byte Count Limit	$2^{64}$ bytes; this is just less than 17 million terabytes.
Hit Count Limit	$2^{64}$ hits; this is over $1.8 \times 10^{19}$ hits.

## 6.5 The Session Monitor Screen

The **Session Monitor** screen displays all established sessions that pass through the USG for debugging or statistical analysis. It is not possible to manage sessions in this screen. The following information is displayed.

- User who started the session
- Protocol or service port used
- Source address
- Destination address
- Number of bytes received (so far)
- Number of bytes transmitted (so far)
- Duration (so far)

You can look at all established sessions that passed through the USG by user, service, source IP address, or destination IP address. You can also filter the information by user, protocol / service or service group, source address, and/or destination address and view it by user.

Click **Monitor > System Status > Session Monitor** to display the following screen.

**Figure 91** Monitor > System Status > Session Monitor

The following table describes the labels in this screen.

**Table 37** Monitor > System Status > Session Monitor

LABEL	DESCRIPTION
View	Select how you want the established sessions that passed through the USG to be displayed. Choices are: <ul style="list-style-type: none"> <li>• <b>sessions by users</b> - display all active sessions grouped by user</li> <li>• <b>sessions by services</b> - display all active sessions grouped by service or protocol</li> <li>• <b>sessions by source IP</b> - display all active sessions grouped by source IP address</li> <li>• <b>sessions by destination IP</b> - display all active sessions grouped by destination IP address</li> <li>• <b>all sessions</b> - filter the active sessions by the <b>User, Service, Source Address, and Destination Address</b>, and display each session individually (sorted by user).</li> </ul>
Refresh	Click this button to update the information on the screen. The screen also refreshes automatically when you open and close the screen.
	The <b>User, Service, Source Address, and Destination Address</b> fields display if you view all sessions. Select your desired filter criteria and click the Refresh button to filter the list of sessions.
User	This field displays when <b>View</b> is set to <b>all sessions</b> . Type the user whose sessions you want to view. It is not possible to type part of the user name or use wildcards in this field; you must enter the whole user name.

**Table 37** Monitor > System Status > Session Monitor (continued)

LABEL	DESCRIPTION
Service	This field displays when <b>View</b> is set to <b>all sessions</b> . Select the service or service group whose sessions you want to view. The USG identifies the service by comparing the protocol and destination port of each packet to the protocol and port of each services that is defined.
Source	This field displays when <b>View</b> is set to <b>all sessions</b> . Type the source IP address whose sessions you want to view. You cannot include the source port.
Destination	This field displays when <b>View</b> is set to <b>all sessions</b> . Type the destination IP address whose sessions you want to view. You cannot include the destination port.
Rx	This field displays the amount of information received by the source in the active session.
Tx	This field displays the amount of information transmitted by the source in the active session.
Duration	This field displays the length of the active session in seconds.
Active Sessions	This is the total number of established sessions that passed through the USG which matched the search criteria.
Show	Select the number of active sessions displayed on each page. You can use the arrow keys on the right to change pages.
#	This field is the rank of each record. The names are sorted by the name of user in active session. You can use the pull down menu on the right to choose sorting method.
User	This field displays the user in each active session.  If you are looking at the <b>sessions by users</b> (or <b>all sessions</b> ) report, click <b>+</b> or <b>-</b> to display or hide details about a user's sessions.
Service	This field displays the protocol used in each active session.  If you are looking at the <b>sessions by services</b> report, click <b>+</b> or <b>-</b> to display or hide details about a protocol's sessions.
Source	This field displays the source IP address and port in each active session.  If you are looking at the <b>sessions by source IP</b> report, click <b>+</b> or <b>-</b> to display or hide details about a source IP address's sessions.
Destination	This field displays the destination IP address and port in each active session.  If you are looking at the <b>sessions by destination IP</b> report, click <b>+</b> or <b>-</b> to display or hide details about a destination IP address's sessions.
Rx	This field displays the amount of information received by the source in the active session.
Tx	This field displays the amount of information transmitted by the source in the active session.
Duration	This field displays the length of the active session in seconds.

## 6.6 IGMP Statistics

The Internet Group Management Protocol (IGMP) Statistics is used by USG IP hosts to inform adjacent router about multicast group memberships. It can also be used for one-to-many networking applications such as online streaming video and gaming, distribution of company newsletters, updating address book of mobile computer users in the field allowing more efficient use of resources when supporting these types of applications. Click **Monitor > System Status > IGMP Statistics** to open the following screen.

**Figure 92** Monitor > System Status > IGMP Statistics

The following table describes the labels in this screen.

**Table 38** Monitor > System Status > IGMP Statistics

LABEL	DESCRIPTION
#	This field is a sequential value, and it is not associated with a specific IGMP Statistics.
Group	This field displays the group of devices in the IGMP.
Source IP	This field displays the host source IP information of the IGMP.
Incoming Interface	This field displays the incoming interface that's connected on the IGMP.
Packet Count	This field displays the packet size of the data being transferred.
Bytes	This field displays the size of the data being transferred in Bytes.
Outgoing Interface	This field displays the outgoing interface that's connected on the IGMP.

## 6.7 The DDNS Status Screen

The **DDNS Status** screen shows the status of the USG's DDNS domain names. Click **Monitor > System Status > DDNS Status** to open the following screen.

**Figure 93** Monitor > System Status > DDNS Status

The following table describes the labels in this screen.

**Table 39** Monitor > System Status > DDNS Status

LABEL	DESCRIPTION
Update	Click this to have the USG update the profile to the DDNS server. The USG attempts to resolve the IP address for the domain name.
#	This field is a sequential value, and it is not associated with a specific DDNS server.
Profile Name	This field displays the descriptive profile name for this entry.
Domain Name	This field displays each domain name the USG can route.
Effective IP	This is the (resolved) IP address of the domain name.

**Table 39** Monitor > System Status > DDNS Status (continued)

LABEL	DESCRIPTION
Last Update Status	This shows whether the last attempt to resolve the IP address for the domain name was successful or not. <b>Updating</b> means the USG is currently attempting to resolve the IP address for the domain name.
Last Update Time	This shows when the last attempt to resolve the IP address for the domain name occurred (in year-month-day hour:minute:second format).

## 6.8 IP/MAC Binding

Click **Monitor > System Status > IP/MAC Binding** to open the **IP/MAC Binding** screen. This screen lists the devices that have received an IP address from USG interfaces with IP/MAC binding enabled and have ever established a session with the USG. Devices that have never established a session with the USG do not display in the list.

**Figure 94** Monitor > System Status > IP/MAC Binding

The following table describes the labels in this screen.

**Table 40** Monitor > System Status > IP/MAC Binding

LABEL	DESCRIPTION
Interface	Select a USG interface that has IP/MAC binding enabled to show to which devices it has assigned an IP address.
#	This field is a sequential value, and it is not associated with a specific IP/MAC binding entry.
IP Address	This is the IP address that the USG assigned to a device.
Host Name	This field displays the name used to identify this device on the network (the computer name). The USG learns these from the DHCP client requests.
MAC Address	This field displays the MAC address to which the IP address is currently assigned.
Last Access	This is when the device last established a session with the USG through this interface.
Description	This field displays the description of the IP/MAC binding.

## 6.9 The Login Users Screen

Use this screen to look at a list of the users currently logged into the USG. To access this screen, click **Monitor > System Status > Login Users**.

**Figure 95** Monitor > System Status > Login Users

#	User ID	Reauth/Lease Time	Type	IP Address	MAC	User Info
1	admin	unlimited / 00:30:00	http/https	192.168.1.33	00:F9:E0:EA:6C:B3	admin(admin)

The following table describes the labels in this screen.

**Table 41** Monitor > System Status > Login Users

LABEL	DESCRIPTION
Force Logout	Select a user ID and click this icon to end a user's session.
#	This field is a sequential value and is not associated with any entry.
User ID	This field displays the user name of each user who is currently logged in to the USG.
Reauth Lease T.	This field displays the amount of reauthentication time remaining and the amount of lease time remaining for each user.
Type	This field displays the way the user logged in to the USG.
IP Address	This field displays the IP address of the computer used to log in to the USG.
MAC	This field displays the MAC address of the computer used to log in to the USG.
User Info	This field displays the types of user accounts the USG uses. If the user type is <b>ext-user</b> (external user), this field will show its external-group information when you move your mouse over it.  If the external user matches two external-group objects, both external-group object names will be shown.
Refresh	Click this button to update the information in the screen.

## 6.10 Cellular Status Screen

This screen displays your mobile broadband connection status. Click **Monitor > System Status > Cellular Status** to display this screen.

**Figure 96** Monitor > System Status > Cellular Status

#	Extension Slot	Connected Device	Status	Service Provider	Cellular System	Signal Quality
1	USB 1	Huawei E220	Device ready	Chunghwa Telecom	WCDMA	Excellent



The following table describes the labels in this screen.

**Table 42** Monitor > System Status > Cellular Status

LABEL	DESCRIPTION
Refresh	Click this button to update the information in the screen.
More Information	Click this to display more information on your mobile broadband, such as the signal strength, IMEA/ESN and IMSI. This is only available when the mobile broadband device attached and activated on your USG. Refer to <a href="#">Section 6.11 on page 114</a> .
#	This field is a sequential value, and it is not associated with any interface.
Extension Slot	This field displays where the entry's cellular card is located.
Connected Device	This field displays the model name of the cellular card.
Status	<ul style="list-style-type: none"> <li>• <b>No device</b> - no mobile broadband device is connected to the USG.</li> <li>• <b>No Service</b> - no mobile broadband network is available in the area; you cannot connect to the Internet.</li> <li>• <b>Limited Service</b> - returned by the service provider in cases where the SIM card is expired, the user failed to pay for the service and so on; you cannot connect to the Internet.</li> <li>• <b>Device detected</b> - displays when you connect a mobile broadband device.</li> <li>• <b>Device error</b> - a mobile broadband device is connected but there is an error.</li> <li>• <b>Probe device fail</b> - the USG's test of the mobile broadband device failed.</li> <li>• <b>Probe device ok</b> - the USG's test of the mobile broadband device succeeded.</li> <li>• <b>Init device fail</b> - the USG was not able to initialize the mobile broadband device.</li> <li>• <b>Init device ok</b> - the USG initialized the mobile broadband card.</li> <li>• <b>Check lock fail</b> - the USG's check of whether or not the mobile broadband device is locked failed.</li> <li>• <b>Device locked</b> - the mobile broadband device is locked.</li> <li>• <b>SIM error</b> - there is a SIM card error on the mobile broadband device.</li> <li>• <b>SIM locked-PUK</b> - the PUK is locked on the mobile broadband device's SIM card.</li> <li>• <b>SIM locked-PIN</b> - the PIN is locked on the mobile broadband device's SIM card.</li> <li>• <b>Unlock PUK fail</b> - Your attempt to unlock a WCDMA mobile broadband device's PUK failed because you entered an incorrect PUK.</li> <li>• <b>Unlock PIN fail</b> - Your attempt to unlock a WCDMA mobile broadband device's PIN failed because you entered an incorrect PIN.</li> <li>• <b>Unlock device fail</b> - Your attempt to unlock a CDMA2000 mobile broadband device failed because you entered an incorrect device code.</li> <li>• <b>Device unlocked</b> - You entered the correct device code and unlocked a CDMA2000 mobile broadband device.</li> <li>• <b>Get dev-info fail</b> - The USG cannot get cellular device information.</li> <li>• <b>Get dev-info ok</b> - The USG succeeded in retrieving mobile broadband device information.</li> <li>• <b>Searching network</b> - The mobile broadband device is searching for a network.</li> <li>• <b>Get signal fail</b> - The mobile broadband device cannot get a signal from a network.</li> <li>• <b>Network found</b> - The mobile broadband device found a network.</li> <li>• <b>Apply config</b> - The USG is applying your configuration to the mobile broadband device.</li> <li>• <b>Inactive</b> - The mobile broadband interface is disabled.</li> <li>• <b>Active</b> - The mobile broadband interface is enabled.</li> <li>• <b>Incorrect device</b> - The connected mobile broadband device is not compatible with the USG.</li> <li>• <b>Correct device</b> - The USG detected a compatible mobile broadband device.</li> <li>• <b>Set band fail</b> - Applying your band selection was not successful.</li> <li>• <b>Set band ok</b> - The USG successfully applied your band selection.</li> <li>• <b>Set profile fail</b> - Applying your ISP settings was not successful.</li> <li>• <b>Set profile ok</b> - The USG successfully applied your ISP settings.</li> <li>• <b>PPP fail</b> - The USG failed to create a PPP connection for the cellular interface.</li> <li>• <b>Need auth-password</b> - You need to enter the password for the mobile broadband card in the cellular edit screen.</li> <li>• <b>Device ready</b> - The USG successfully applied all of your configuration and you can use the mobile broadband connection.</li> </ul>

**Table 42** Monitor > System Status > Cellular Status (continued)

LABEL	DESCRIPTION
Service Provider	This displays the name of your network service provider. This shows <b>Limited Service</b> if the service provider has stopped service to the mobile broadband card. For example if the bill has not been paid or the account has expired.
Cellular System	This field displays what type of cellular network the mobile broadband connection is using. The network type varies depending on the mobile broadband card you inserted and could be <b>UMTS</b> , <b>UMTS/HSDPA</b> , <b>GPRS</b> or <b>EDGE</b> when you insert a GSM mobile broadband card, or <b>1xRTT</b> , <b>EVDO Rev.0</b> or <b>EVDO Rev.A</b> when you insert a CDMA mobile broadband card.
Signal Quality	This displays the strength of the signal. The signal strength mainly depends on the antenna output power and the distance between your USG and the service provider's base station.

## 6.11 The UPnP Port Status Screen

Use this screen to look at the NAT port mapping rules that UPnP creates on the USG. To access this screen, click **Monitor > System Status > UPnP Port Status**.

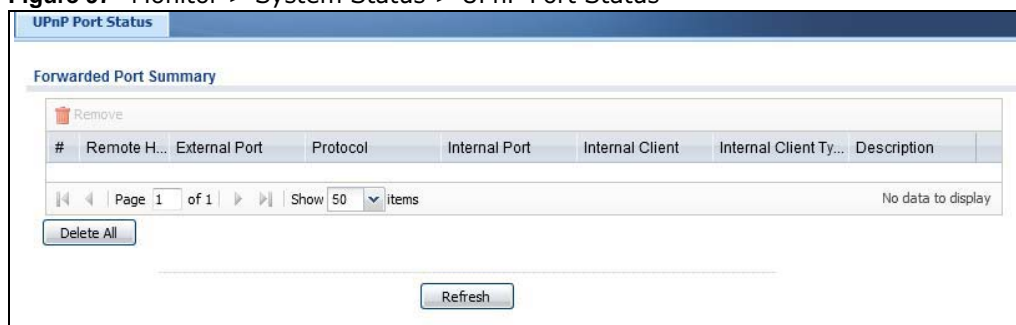
**Figure 97** Monitor > System Status > UPnP Port Status

The following table describes the labels in this screen.

**Table 43** Monitor > System Status > UPnP Port Status

LABEL	DESCRIPTION
Remove	Select an entry and click this button to remove it from the list.
#	This is the index number of the UPnP-created NAT mapping rule entry.
Remote Host	This field displays the source IP address (on the WAN) of inbound IP packets. Since this is often a wildcard, the field may be blank.  When the field is blank, the USG forwards all traffic sent to the <b>External Port</b> on the WAN interface to the <b>Internal Client</b> on the <b>Internal Port</b> .  When this field displays an external IP address, the NAT rule has the USG forward inbound packets to the <b>Internal Client</b> from that IP address only.
External Port	This field displays the port number that the USG "listens" on (on the WAN port) for connection requests destined for the NAT rule's <b>Internal Port</b> and <b>Internal Client</b> . The USG forwards incoming packets (from the WAN) with this port number to the <b>Internal Client</b> on the <b>Internal Port</b> (on the LAN). If the field displays "0", the USG ignores the <b>Internal Port</b> value and forwards requests on all external port numbers (that are otherwise unmapped) to the <b>Internal Client</b> .
Protocol	This field displays the protocol of the NAT mapping rule (TCP or UDP).

**Table 43** Monitor > System Status > UPnP Port Status (continued)

LABEL	DESCRIPTION
Internal Port	This field displays the port number on the <b>Internal Client</b> to which the USG should forward incoming connection requests.
Internal Client	This field displays the DNS host name or IP address of a client on the LAN. Multiple NAT clients can use a single port simultaneously if the internal client field is set to 255.255.255.255 for UDP mappings.
Internal Client Type	This field displays the type of the client application on the LAN.
Description	This field displays a text explanation of the NAT mapping rule.
Delete All	Click this to remove all mapping rules from the NAT table.
Refresh	Click this button to update the information in the screen.

## 6.12 USB Storage Screen

This screen displays information about a connected USB storage device. Click **Monitor > System Status > USB Storage** to display this screen.

**Figure 98** Monitor > System Status > USB Storage

The screenshot shows a web interface titled "Storage Information". Under the "Information" section, there is a table with the following data:

Device description:	N/A
Usage:	N/A
Filesystem:	N/A
Speed:	N/A
Status:	none
Detail:	none

There is a "Use It..." button located to the right of the Status field.

The following table describes the labels in this screen.

**Table 44** Monitor > System Status > USB Storage

LABEL	DESCRIPTION
Device description	This is a basic description of the type of USB device.
Usage	This field displays how much of the USB storage device's capacity is currently being used out of its total capacity and what percentage that makes.
Filesystem	This field displays what file system the USB storage device is formatted with. This field displays <b>Unknown</b> if the file system of the USB storage device is not supported by the USG, such as NTFS.
Speed	This field displays the connection speed the USB storage device supports.

**Table 44** Monitor > System Status > USB Storage (continued)

LABEL	DESCRIPTION
Status	<p><b>Ready</b> - you can have the USG use the USB storage device.</p> <p>Click <b>Remove Now</b> to stop the USG from using the USB storage device so you can remove it.</p> <p><b>Unused</b> - the connected USB storage device was manually unmounted by using the <b>Remove Now</b> button or for some reason the USG cannot mount it.</p> <p>Click <b>Use It</b> to have the USG mount a connected USB storage device. This button is grayed out if the file system is not supported (unknown) by the USG.</p> <p><b>none</b> - no USB storage device is connected.</p>
Detail	<p>This field displays any other information the USG retrieves from the USB storage device.</p> <ul style="list-style-type: none"> <li>• <b>Deactivated</b> - the use of a USB storage device is disabled (turned off) on the USG.</li> <li>• <b>OutofSpace</b> - the available disk space is less than the disk space full threshold.</li> <li>• <b>Mounting</b> - the USG is mounting the USB storage device.</li> <li>• <b>Removing</b> - the USG is unmounting the USB storage device.</li> <li>• <b>none</b> - the USB device is operating normally or not connected.</li> </ul>

## 6.13 Ethernet Neighbor Screen

The Ethernet Neighbor screen allows you to view the USG's neighboring devices in one place.

It uses Smart Connect, that is Link Layer Discovery Protocol (LLDP) for discovering and configuring LLDP-aware devices in the same broadcast domain as the USG that you're logged into using the web configurator.

LLDP is a layer-2 protocol that allows a network device to advertise its identity and capabilities on the local network. It also allows the device to maintain and store information from adjacent devices which are directly connected to the network device. This helps you discover network changes and perform necessary network reconfiguration and management.

Note: Enable Smart Connect in the **System > ZON** screen.

See also **System > ZON** for more information on the ZyXEL One Network (ZON) utility that uses the ZyXEL Discovery Protocol (ZDP) for discovering and configuring ZDP-aware ZyXEL devices in the same network as the computer on which the ZON utility is installed.

Click **Monitor > System Status > Ethernet Neighbor** to see the following screen

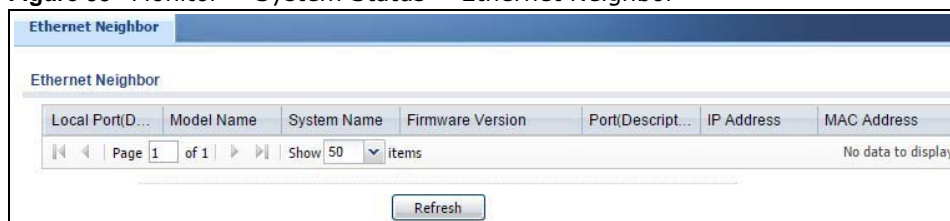
**Figure 99** Monitor > System Status > Ethernet Neighbor

The following table describes the fields in the previous screen.

**Table 45** Monitor > System Status > Ethernet Neighbor

LABEL	DESCRIPTION
Local Port (Description)	This field displays the port of the USG, on which the neighboring device is discovered.  For USGs that support <b>Port Role</b> , if ports 3 to 5 are grouped together and there is a connection to P5 only, the USG will display P3 as the interface port number (even though there is no connection to that port).
Model Name	This field displays the model name of the discovered device.
System Name	This field displays the system name of the discovered device.
Firmware Version	This field displays the firmware version of the discovered device.
Port (Description)	This field displays the first internal port on the discovered device. Internal is an interface type displayed in the <b>Network &gt; Interface &gt; Ethernet &gt; Edit</b> screen. For example, if P1 and P2 are WAN, P3 to P5 are LAN, and P6 is DMZ, then USG will display P3 as the first internal interface port number.  For USGs that support <b>Port Role</b> , if ports 3 to 5 are grouped together and there is a connection to P5 only, the USG will display P3 as the first internal interface port number (even though there is no connection to that port).
IP Address	This field displays the IP address of the discovered device.
MAC Address	This field displays the MAC address of the discovered device.
Refresh	Click this button to update the information in the screen.

## 6.14 Wireless

Wireless contains AP information and Station Info menus.

### 6.14.1 Wireless AP Information: Radio List

Click **Monitor > Wireless > AP Information > Radio List** to display the **Radio List** screen.

**Figure 100** Monitor > Wireless > Radio List

#	AP Description	Model	MAC Address	Radio	OP Mode	Profile	Frequency Band	Channel ID	Tx Power	Station	Rx PKT	Tx PKT	Rx FCS Error Count	Tx Retry Count
1	Local-AP	ZyWALL 20W V2	A0:E4:CB:8B:DB:80	1	AP	default	2.4GHz	6	25 dBm	0	0	0	10158	0

The following table describes the labels in this screen.

**Table 46** Monitor > Wireless > Radio List

LABEL	DESCRIPTION
More Information	Click this icon to see the traffic statistics, station count, SSID, Security Mode and VLAN ID information on the AP.
#	This field is a sequential value, and it is not associated with a specific radio.
AP Description	This field displays the description of the AP.

**Table 46** Monitor > Wireless > Radio List

LABEL	DESCRIPTION
Model	This field displays the AP's hardware model information. It displays <b>N/A</b> (not applicable) only when the AP disconnects from the USG and the information is unavailable as a result.
MAC Address	This field displays the MAC address of the AP.
Radio	This field displays the Radio number. For example 1.
OP Mode	This field displays the operating mode of the AP. It displays <b>n/a</b> for the profile for a radio not using an AP profile.  <b>AP Mode</b> means the AP can receive connections from wireless clients and pass their data traffic through to the USG to be managed (or subsequently passed on to an upstream gateway for managing).  <b>MON Mode</b> means the AP monitors the broadcast area for other APs, then passes their information on to the USG. If an AP is set to this mode it cannot receive connections from wireless clients.
Profile	This field displays the AP Profile for the Radio. It displays n/A for the radio profile not using an AP profile. It displays default if using a default profile.
Frequency Band	This field displays the WLAN frequency band using the IEEE 802.11 a/b/g/n/ac standard of 2.4 or 5 GHz.
Channel ID	This field displays the WLAN channels using the IEEE 802.11 protocols.
Tx Power	This field displays the transmission power the USG is using.
Station	This field displays the station count information.
Rx PKT	This field displays the data packets of incoming traffic on the AP.
Tx PKT	This field displays the data packet of outgoing traffic on the AP.
Rx FCS Error Count	This field displays the erroneous data packet count received and detected by Frame Check Sequence (FCS)
Tx Retry Count	This field displays the data packet count that were transmitted for retry.

## 6.14.2 Radio List More Information

This screen allows you to view detailed information about a selected radio's SSID(s), wireless traffic and wireless clients for the preceding 24 hours. To access this window, select an entry and click the **More Information** button in the **Radio List** screen.

**Figure 101** Monitor > Wireless > AP Information > Radio List > More Information

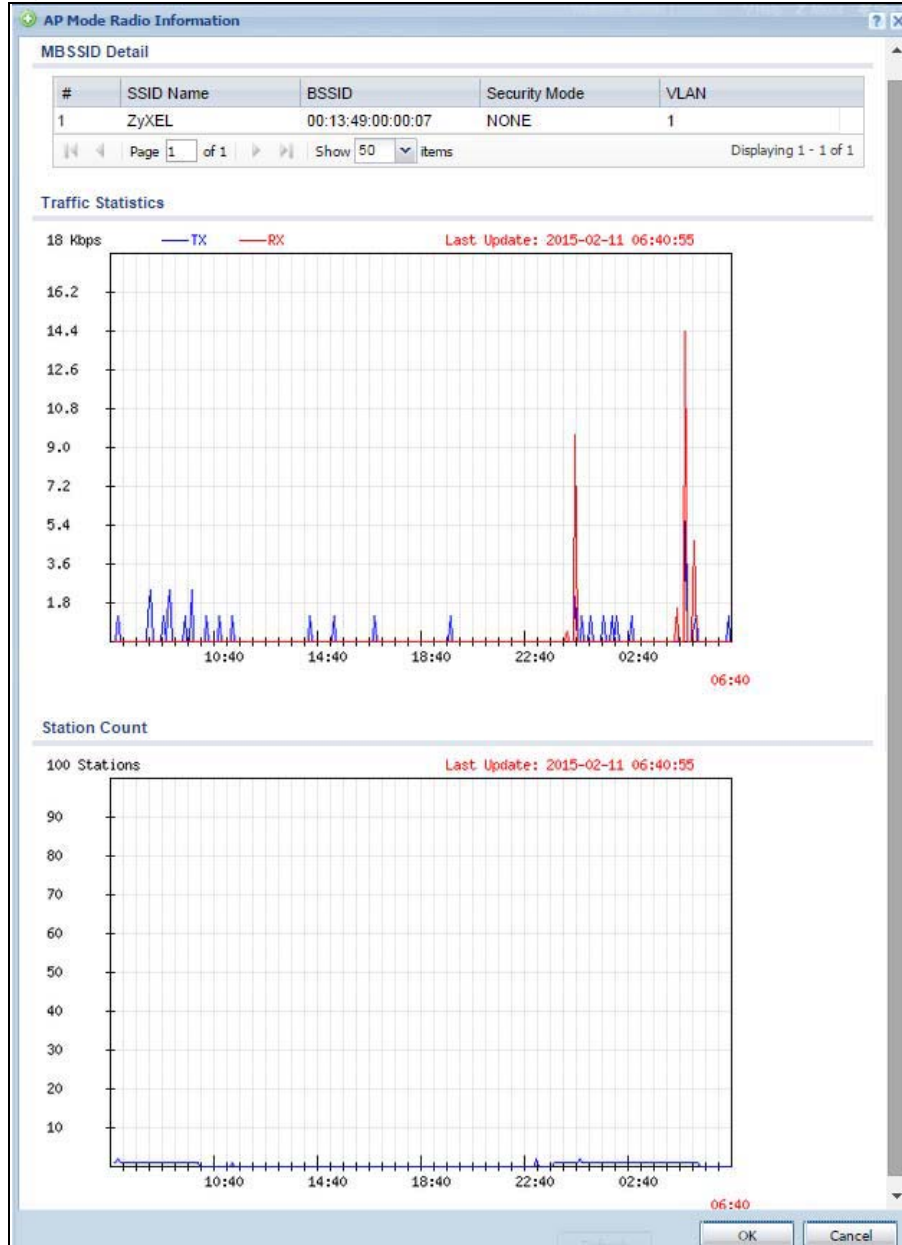

The following table describes the labels in this screen.

**Table 47** Monitor > Wireless > AP Info > Radio List > More Information

LABEL	DESCRIPTION
MBSSID Detail	This list shows information about the SSID(s) that is associated with the radio.
#	This is the items sequential number in the list. It has no bearing on the actual data in this list.
SSID Name	This displays an SSID associated with this radio. There can be up to eight maximum.
BSSID	This displays the MAC address associated with the SSID.
Security Mode	This displays the security mode in which the SSID is operating.
VLAN	This displays the VLAN ID associated with the SSID.
Traffic Statistics	This graph displays the overall traffic information about the radio over the preceding 24 hours.
y-axis	This axis represents the amount of data moved across this radio per second.
x-axis	This axis represents the amount of time over which the data moved across this radio.
Station Count	This graph displays information about all the wireless clients that have connected to the radio over the preceding 24 hours.
y-axis	The y-axis represents the number of connected wireless clients.
x-axis	The x-axis shows the time over which a wireless client was connected.
Last Update	This field displays the date and time the information in the window was last updated.
OK	Click this to close this window.
Cancel	Click this to close this window.

### 6.14.3 Wireless Station Info

This screen displays information about connected wireless stations. Click **Monitor > Wireless > Station Information** to display this screen.

**Figure 102** Monitor > Wireless > Station List

The following table describes the labels in this screen.

**Table 48** Monitor > Wireless > Station List

LABEL	DESCRIPTION
#	This field is a sequential value, and it is not associated with a specific station.
MAC Address	This field displays the MAC address of the station.
Associated AP	This field displays the AP that is associated with the station.
SSID Name	This indicates the name of the wireless network to which the station is connected. A single AP can have multiple SSIDs or networks.
Security Mode	This field displays the security mode the station is using.



**Table 48** Monitor > Wireless > Station List

LABEL	DESCRIPTION
Signal Strength	This field displays the signal strength of the station. The signal strength mainly depends on the antenna output power and the distance between the station and the AP.
Channel	This indicates the number the channel used by the station to connect to the network.
Band	This indicates the frequency band which is currently being used by the station.
IP Address	This field displays the IP address of the station. An 169.x.x.x IP address is a private IP address that means the station didn't get the IP address from a DHCP server.
Tx Rate	This field displays the transmit data rate of the station.
Rx Rate	This field displays the receive data rate of the station.
Tx	This field displays the number of packets transmitted from the station.
Rx	This field displays the number of packets received by the station.
Association Time	This field displays the time duration the station was online and offline.
Refresh	Click this to refresh the items displayed on this page.

### 6.14.4 Detected Device

Use this screen to view information about wireless devices detected by the AP. Click **Monitor > Wireless > Detected Device** to access this screen.

Note: At least one radio of the APs connected to the USG must be set to monitor mode (in the **Configuration > Wireless > AP Management** screen) in order to detect other wireless devices in its vicinity.

**Figure 103** Monitor > Wireless > Detected Device

#	Status	Device	Role	MAC Address	S...	Channel ID	802.11 ...	Security	Description	Last Seen
1	🟡	infrastru...		48:EE:0C:2B:E6:28	dl...	7	IEEE 80...	TKIP,W...		Tue Aug 25 16:...
2	🟡	infrastru...		CC:5D:4E:44:F9:45	Z...	11	IEEE 80...	None		Tue Aug 25 16:...
3	🟡	infrastru...		EC:43:F6:E3:1E:CC	T...	1	IEEE 80...	WPA,P...		Tue Aug 25 16:...

Page 1 of 1 | Show 50 Items | Displaying 1 - 3 of 3

Refresh

The following table describes the labels in this screen.

**Table 49** Monitor > Wireless > Detected Device

LABEL	DESCRIPTION
#	This is the station's index number in this list.
Status	This indicates the detected device's status.
Device	This indicates the detected device's network type (such as <b>infrastructure</b> or <b>ad-hoc</b> ).
MAC Address	This indicates the detected device's MAC address.
SSID Name	This indicates the detected device's SSID.
Channel ID	This indicates the detected device's channel ID.
802.11 Mode	This indicates the 802.11 mode (a/b/g/n/ac) transmitted by the detected device.

**Table 49** Monitor > Wireless > Detected Device (continued)

LABEL	DESCRIPTION
Security	This indicates the encryption method (if any) used by the detected device.
Description	This displays the detected device's description. For more on managing friendly and rogue APs, see the <b>Configuration &gt; Wireless &gt; MON Mode</b> screen.
Last Seen	This indicates the last time the device was detected by the USG.
Refresh	Click this to refresh the items displayed on this page.

## 6.15 The IPSec Monitor Screen

You can use the **IPSec Monitor** screen to display and to manage active IPSec To access this screen, click **Monitor > VPN Monitor > IPSec**. The following screen appears. SAs. Click a column's heading cell to sort the table entries by that column's criteria. Click the heading cell again to reverse the sort order.

**Figure 104** Monitor > VPN Monitor > IPSec

Each field is described in the following table.

**Table 50** Monitor > VPN Monitor > IPSec

LABEL	DESCRIPTION
Name	Type the name of a IPSec SA here and click <b>Search</b> to find it (if it is associated). You can use a keyword or regular expression. Use up to 30 alphanumeric and _+-.(!\$*^:~ {}[]<>)/ characters. See <a href="#">Section 6.15.1 on page 123</a> for more details.
Policy	Type the IP address(es) or names of the local and remote policies for an IPSec SA and click <b>Search</b> to find it. You can use a keyword or regular expression. Use up to 30 alphanumeric and _+-.(!\$*^:~ {}[]<>)/ characters. See <a href="#">Section 6.15.1 on page 123</a> for more details.
Search	Click this button to search for an IPSec SA that matches the information you specified above.
Disconnect	Select an IPSec SA and click this button to disconnect it.
#	This field is a sequential value, and it is not associated with a specific SA.
Name	This field displays the name of the IPSec SA.
Policy	This field displays the content of the local and remote policies for this IPSec SA. The IP addresses, not the address objects, are displayed.
IKE Name	This field displays the Internet Key Exchange (IKE) name.
Cookies	This field displays the cookies information that initiates the IKE.
My Address	This field displays the IP address of local computer.

**Table 50** Monitor > VPN Monitor > IPsec (continued)

LABEL	DESCRIPTION
Secure Gateway	This field displays the secure gateway information.
Up Time	This field displays how many seconds the IPsec SA has been active. This field displays <b>N/A</b> if the IPsec SA uses manual keys.
Timeout	This field displays how many seconds remain in the SA life time, before the USG automatically disconnects the IPsec SA. This field displays <b>N/A</b> if the IPsec SA uses manual keys.
Inbound (Bytes)	This field displays the amount of traffic that has gone through the IPsec SA from the remote IPsec router to the USG since the IPsec SA was established.
Outbound (Bytes)	This field displays the amount of traffic that has gone through the IPsec SA from the USG to the remote IPsec router since the IPsec SA was established.

### 6.15.1 Regular Expressions in Searching IPsec SAs

A question mark (?) lets a single character in the VPN connection or policy name vary. For example, use "a?c" (without the quotation marks) to specify abc, acc and so on.

Wildcards (\*) let multiple VPN connection or policy names match the pattern. For example, use "\*abc" (without the quotation marks) to specify any VPN connection or policy name that ends with "abc". A VPN connection named "testabc" would match. There could be any number (of any type) of characters in front of the "abc" at the end and the VPN connection or policy name would still match. A VPN connection or policy name named "testacc" for example would not match.

A \* in the middle of a VPN connection or policy name has the USG check the beginning and end and ignore the middle. For example, with "abc\*123", any VPN connection or policy name starting with "abc" and ending in "123" matches, no matter how many characters are in between.

The whole VPN connection or policy name has to match if you do not use a question mark or asterisk.

## 6.16 The SSL Screen

The USG keeps track of the users who are currently logged into the VPN SSL client. Click **Monitor > VPN Monitor > SSL** to display the user list.

Use this screen to do the following:

- View a list of active SSL VPN connections.
- Log out individual users and delete related session information.

Once a user logs out, the corresponding entry is removed from the screen.

**Figure 105** Monitor > VPN Monitor > SSL

The following table describes the labels in this screen.

**Table 51** Monitor > VPN Monitor > SSL

LABEL	DESCRIPTION
Disconnect	Select a connection and click this button to terminate the user's connection and delete corresponding session information from the USG.
Refresh	Click <b>Refresh</b> to update this screen.
#	This field is a sequential value, and it is not associated with a specific SSL.
User	This field displays the account user name used to establish this SSL VPN connection.
Access	This field displays the name of the SSL VPN application the user is accessing.
Login Address	This field displays the IP address the user used to establish this SSL VPN connection.
Connected Time	This field displays the time this connection was established.
Inbound (Bytes)	This field displays the number of bytes received by the USG on this connection.
Outbound (Bytes)	This field displays the number of bytes transmitted by the USG on this connection.

## 6.17 The L2TP over IPSec Session Monitor Screen

Click **Monitor > VPN Monitor > L2TP over IPSec** to open the following screen. Use this screen to display and manage the USG's connected L2TP VPN sessions.

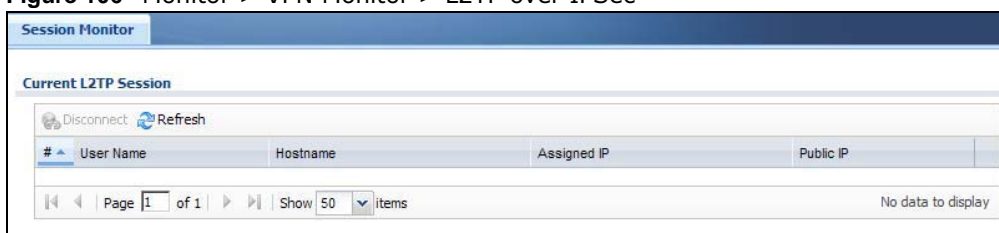
**Figure 106** Monitor > VPN Monitor > L2TP over IPSec

The following table describes the fields in this screen.

**Table 52** Monitor > VPN Monitor > L2TP over IPSec

LABEL	DESCRIPTION
Disconnect	Select a connection and click this button to disconnect it.
Refresh	Click <b>Refresh</b> to update this screen.
#	This field is a sequential value, and it is not associated with a specific L2TP VPN session.
User Name	This field displays the remote user's user name.

**Table 52** Monitor > VPN Monitor > L2TP over IPSec (continued)

LABEL	DESCRIPTION
Hostname	This field displays the name of the computer that has this L2TP VPN connection with the USG.
Assigned IP	This field displays the IP address that the USG assigned for the remote user's computer to use within the L2TP VPN tunnel.
Public IP	This field displays the public IP address that the remote user is using to connect to the Internet.

## 6.18 The Content Filter Screen

Click **Monitor > UTM Statistics > Content Filter** to display the following screen. This screen displays content filter statistics.

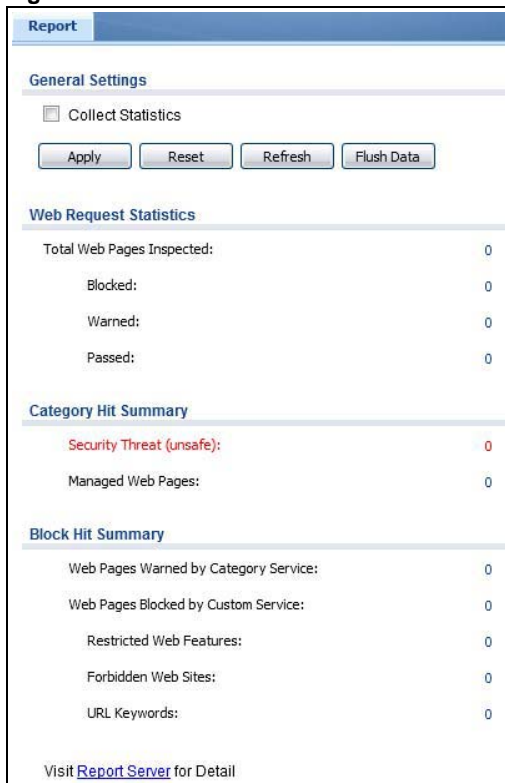
**Figure 107** Monitor > UTM Statistics > Content Filter

The following table describes the labels in this screen.

**Table 53** Monitor > UTM Statistics > Content Filter

LABEL	DESCRIPTION
General Settings	
Collect Statistics	Select this check box to have the USG collect content filtering statistics.  The collection starting time displays after you click <b>Apply</b> . All of the statistics in this screen are for the time period starting at the time displayed here. The format is year, month, day and hour, minute, second. All of the statistics are erased if you restart the USG or click <b>Flush Data</b> . Collecting starts over and a new collection start time displays.
Apply	Click <b>Apply</b> to save your changes back to the USG.
Reset	Click <b>Reset</b> to return the screen to its last-saved settings.
Refresh	Click this button to update the report display.
Flush Data	Click this button to discard all of the screen's statistics and update the report display.
Web Request Statistics	
Total Web Pages Inspected	This field displays the number of web pages that the USG's content filter feature has checked.
Blocked	This is the number of web pages that the USG blocked access.
Warned	This is the number of web pages for which the USG displayed a warning message to the access requesters.
Passed	This is the number of web pages to which the USG allowed access.
Category Hit Summary	
Security Threat (unsafe)	This is the number of requested web pages that the USG's content filtering service identified as posing a threat to users.
Managed Web Pages	This is the number of requested web pages that the USG's content filtering service identified as belonging to a category that was selected to be managed.
Block Hit Summary	
Web Pages Warned by Category Service	This is the number of web pages that matched an external database content filtering category selected in the USG and for which the USG displayed a warning before allowing users access.
Web Pages Blocked by Custom Service	This is the number of web pages to which the USG did not allow access due to the content filtering custom service configuration.
Restricted Web Features	This is the number of web pages to which the USG limited access or removed cookies due to the content filtering custom service's restricted web features configuration.
Forbidden Web Sites	This is the number of web pages to which the USG did not allow access because they matched the content filtering custom service's forbidden web sites list.
URL Keywords	This is the number of web pages to which the USG did not allow access because they contained one of the content filtering custom service's list of forbidden keywords.
Web Pages Blocked Without Policy	This is the number of web pages to which the USG did not allow access because they were not rated by the external database content filtering service.
Report Server	Click this link to go to <a href="http://www.myZyXEL.com">http://www.myZyXEL.com</a> where you can view content filtering reports after you have activated the category-based content filtering subscription service.

## 6.19 The Anti-Spam Screens

The Anti-Spam menu contains the **Report** and **Status** screens.

### 6.19.1 Anti-Spam Report

Click **Monitor > UTM Statistics > Anti-Spam** to display the following screen. This screen displays spam statistics.

**Figure 108** Monitor > UTM Statistics > Anti-Spam

The following table describes the labels in this screen.

**Table 54** Monitor > UTM Statistics > Anti-Spam

LABEL	DESCRIPTION
Collect Statistics	Select this check box to have the USG collect anti-spam statistics.  The collection starting time displays after you click <b>Apply</b> . All of the statistics in this screen are for the time period starting at the time displayed here. The format is year, month, day and hour, minute, second. All of the statistics are erased if you restart the USG or click <b>Flush Data</b> . Collecting starts over and a new collection start time displays.
Apply	Click <b>Apply</b> to save your changes back to the USG.
Reset	Click <b>Reset</b> to return the screen to its last-saved settings.
Refresh	Click this button to update the report display.

**Table 54** Monitor > UTM Statistics > Anti-Spam (continued)

LABEL	DESCRIPTION
Flush Data	Click this button to discard all of the screen's statistics and update the report display.
Total Mails Scanned	This field displays the number of e-mails that the USG's anti-spam feature has checked.
Clear Mails	This is the number of e-mails that the USG has determined to not be spam.
Clear Mails Detected by Whitelist	This is the number of e-mails that matched an entry in the USG's anti-spam white list.
Spam Mails	This is the number of e-mails that the USG has determined to be spam.
Spam Mails Detected by Black List	This is the number of e-mails that matched an entry in the USG's anti-spam black list.
Spam Mails Detected by IP Reputation	This is the number of e-mails that the USG has determined to be spam by IP Reputation. Spam or Unwanted Bulk Email is determined by the sender's IP address.
Spam Mails Detected by Mail Content	This is the number of e-mails that the USG has determined to have malicious contents.
Spam Mails Detected by DNSBL	The USG can check the sender and relay IP addresses in an e-mail's header against DNS (Domain Name Service)-based spam Black Lists (DNSBLs). This is the number of e-mails that had a sender or relay IP address in the header which matched one of the DNSBLs that the USG uses.
Spam Mails with Virus Detected by Mail Content	This is the number of e-mails that the USG has determined to have malicious contents and attached with virus.
Virus Mails	This is the number of e-mails that the USG has determined to be attached with virus.
Query Timeout	This is how many queries that were sent to the USG's configured list of DNSBL domains or Mail Scan services and did not receive a response in time.
Mail Sessions Forwarded	<p>This is how many e-mail sessions the USG allowed because they exceeded the maximum number of e-mail sessions that the anti-spam feature can check at a time.</p> <p>You can see the USG's threshold of concurrent e-mail sessions in the <b>Anti-Spam &gt; Status</b> screen.</p> <p>Use the <b>Anti-Spam &gt; General</b> screen to set whether the USG forwards or drops sessions that exceed this threshold.</p>
Mail Sessions Dropped	<p>This is how many e-mail sessions the USG dropped because they exceeded the maximum number of e-mail sessions that the anti-spam feature can check at a time.</p> <p>You can see the USG's threshold of concurrent e-mail sessions in the <b>Anti-Spam &gt; Status</b> screen.</p> <p>Use the <b>Anti-Spam &gt; General</b> screen to set whether the USG forwards or drops sessions that exceed this threshold.</p>
Top Sender By	<p>Use this field to list the top e-mail or IP addresses from which the USG has detected the most spam.</p> <p>Select <b>Sender IP</b> to list the source IP addresses from which the USG has detected the most spam.</p> <p>Select <b>Sender Email Address</b> to list the top e-mail addresses from which the USG has detected the most spam.</p>
#	This field displays the entry's rank in the list of the top entries.
Sender IP	This column displays when you display the entries by <b>Sender IP</b> . It shows the source IP address of spam e-mails that the USG has detected.



**Table 54** Monitor > UTM Statistics > Anti-Spam (continued)

LABEL	DESCRIPTION
Sender Email Address	This column displays when you display the entries by <b>Sender Email Address</b> . This column displays the e-mail addresses from which the USG has detected the most spam.
Occurrence	This field displays how many spam e-mails the USG detected from the sender.

## 6.19.2 The Anti-Spam Status Screen

Click **Monitor > UTM Statistics > Anti-Spam > Status** to display the **Anti-Spam Status** screen.

Use the **Anti-Spam Status** screen to see how many e-mail sessions the anti-spam feature is scanning and statistics for the DNSBLs.

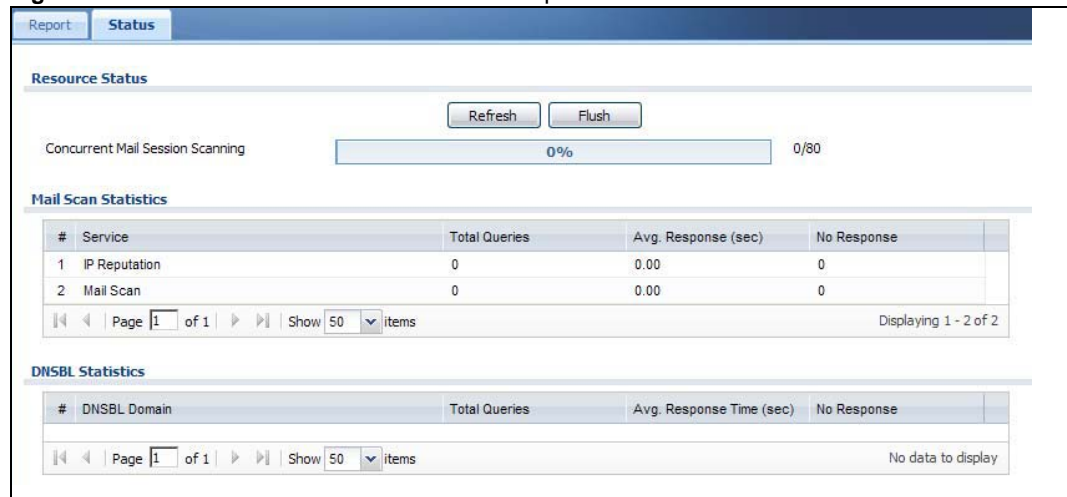
**Figure 109** Monitor > UTM Statistics > Anti-Spam > Status

The following table describes the labels in this screen.

**Table 55** Monitor > UTM Statistics > Anti-Spam > Status

LABEL	DESCRIPTION
Refresh	Click this button to update the information displayed on this screen.
Flush	Click this button to clear the DNSBL statistics. This also clears the concurrent mail session scanning bar's historical high.
Concurrent Mail Session Scanning	The darker shaded part of the bar shows how much of the USG's total spam checking capability is currently being used.  The lighter shaded part of the bar and the pop-up show the historical high.  The first number to the right of the bar is how many e-mail sessions the USG is presently checking for spam. The second number is the maximum number of e-mail sessions that the USG can check at once. An e-mail session is when an e-mail client and e-mail server (or two e-mail servers) connect through the USG.
Mail Scan Statistics	These are the statistics for the service the USG uses. These statistics are for when the USG actually queries the service servers.
#	This is the entry's index number in the list.
Service	This displays the name of the service.
Total Queries	This is the total number of queries the USG has sent to this service.

**Table 55** Monitor > UTM Statistics > Anti-Spam > Status (continued)

LABEL	DESCRIPTION
Avg. Response Time (sec)	This is the average for how long it takes to receive a reply from this service.
No Response	This is how many queries the USG sent to this service without receiving a reply.
DNSBL Statistics	These are the statistics for the DNSBL the USG uses. These statistics are for when the USG actually queries the DNSBL servers. Matches for DNSBL responses stored in the cache do not affect these statistics.
#	This is the entry's index number in the list.
DNSBL Domain	These are the DNSBLs the USG uses to check sender and relay IP addresses in e-mails.
Total Queries	This is the total number of DNS queries the USG has sent to this DNSBL.
Avg. Response Time (sec)	This is the average for how long it takes to receive a reply from this DNSBL.
No Response	This is how many DNS queries the USG sent to this DNSBL without receiving a reply.

## 6.20 Log Screens

Log messages are stored in two separate logs, one for regular log messages and one for debugging messages. In the regular log, you can look at all the log messages by selecting **All Logs**, or you can select a specific category of log messages (for example, security policy or user). You can also look at the debugging log by selecting **Debug Log**. All debugging messages have the same priority.

### 6.20.1 View Log

To access this screen, click **Monitor > Log**. The log is displayed in the following screen.

Note: When a log reaches the maximum number of log messages, new log messages automatically overwrite existing log messages, starting with the oldest existing log message first.

- The maximum possible number of log messages in the USG varies by model.

Events that generate an alert (as well as a log message) display in red. Regular logs display in black. Click a column's heading cell to sort the table entries by that column's criteria. Click the heading cell again to reverse the sort order. The Web Configurator saves the filter settings if you leave the **View Log** screen and return to it later.

Figure 110 Monitor &gt; Log &gt; View Log

#	Time	Pr...	Category	Message	Source	Destination	Note
1	2014-02-21 08:4...	w...	ADP	Rule_id=1 from WAN to Any, [type=UDP-Decoder(40...	172.23....	172.23.30...	ACCESS B...
2	2014-02-21 08:4...	w...	ADP	Rule_id=1 from WAN to Any, [type=UDP-Decoder(40...	172.23....	255.255.2...	ACCESS B...
3	2014-02-21 08:4...	w...	ADP	Rule_id=1 from WAN to Any, [type=UDP-Decoder(40...	172.23....	172.23.30...	ACCESS B...
4	2014-02-21 08:4...	w...	ADP	Rule_id=1 from WAN to Any, [type=UDP-Decoder(40...	172.23....	255.255.2...	ACCESS B...
5	2014-02-21 08:4...	w...	ADP	Rule_id=1 from WAN to Any, [type=UDP-Decoder(40...	172.23....	172.23.30...	ACCESS B...
6	2014-02-21 08:4...	w...	ADP	Rule_id=1 from WAN to Any, [type=UDP-Decoder(40...	172.23....	255.255.2...	ACCESS B...

The following table describes the labels in this screen.

Table 56 Monitor &gt; Log &gt; View Log

LABEL	DESCRIPTION
Show Filter	Click this button to show or hide the filter settings.  If the filter settings are hidden, the <b>Display</b> , <b>Email Log Now</b> , <b>Refresh</b> , and <b>Clear Log</b> fields are available.  If the filter settings are shown, the <b>Display</b> , <b>Priority</b> , <b>Source Address</b> , <b>Destination Address</b> , <b>Service</b> , <b>Keyword</b> , and <b>Search</b> fields are available.
Display	Select the category of log message(s) you want to view. You can also view <b>All Logs</b> at one time, or you can view the <b>Debug Log</b> .
Email Log Now	Click this button to send log message(s) to the <b>Active</b> e-mail address(es) specified in the <b>Send Log To</b> field on the <b>Log Settings</b> page.
Refresh	Click this button to update the information in the screen.
Clear Log	Click this button to clear the whole log, regardless of what is currently displayed on the screen.
#	This field is a sequential value, and it is not associated with a specific log message.
Time	This field displays the time the log message was recorded.
Priority	This displays when you show the filter. Select the priority of log messages to display. The log displays the log messages with this priority or higher. Choices are: <b>any</b> , <b>emerg</b> , <b>alert</b> , <b>crit</b> , <b>error</b> , <b>warn</b> , <b>notice</b> , and <b>info</b> , from highest priority to lowest priority. This field is read-only if the <b>Category</b> is <b>Debug Log</b> .
Category	This field displays the log that generated the log message. It is the same value used in the <b>Display</b> and (other) <b>Category</b> fields.
Message	This field displays the reason the log message was generated. The text "[count=x]", where x is a number, appears at the end of the <b>Message</b> field if log consolidation is turned on and multiple entries were aggregated to generate into this one.
Source	This displays when you show the filter. Type the source IP address of the incoming packet that generated the log message. Do not include the port in this filter.
Destination	This displays when you show the filter. Type the IP address of the destination of the incoming packet when the log message was generated. Do not include the port in this filter.
Protocol	This displays when you show the filter. Select a service protocol whose log messages you would like to see.
Search	This displays when you show the filter. Click this button to update the log using the current filter settings.

**Table 56** Monitor > Log > View Log (continued)

LABEL	DESCRIPTION
Priority	This field displays the priority of the log message. It has the same range of values as the <b>Priority</b> field above.
Source	This field displays the source IP address and the port number in the event that generated the log message.
Destination	This field displays the destination IP address and the port number of the event that generated the log message.
Note	This field displays any additional information about the log message.

# Licensing

## 7.1 Registration Overview

Use the **Configuration > Licensing > Registration** screens to register your USG and manage its service subscriptions.

- Use the **Registration** screen (see [Section 7.1.2 on page 134](#)) to go to [portal.myzyxel.com](http://portal.myzyxel.com) to register your USG and activate a service, such as content filtering.
- Use the **Service** screen (see [Section 7.1.3 on page 134](#)) to display the status of your service registrations and upgrade licenses.

Note: The USG models need a license for UTM (Unified Threat management) functionality.

### 7.1.1 What you Need to Know

This section introduces the topics covered in this chapter.

#### myZyXEL.com

myZyXEL.com is ZyXEL's online services center where you can register your USG and manage subscription services available for the USG. To update signature files or use a subscription service, you have to register the USG and activate the corresponding service at myZyXEL.com (through the USG).

Note: You need to create a myZyXEL.com account before you can register your device and activate the services at myZyXEL.com.

You need your USG's serial number and LAN MAC address to register it. Refer to the web site's on-line help for details.

#### Subscription Services Available

The USG can use anti-spam, SSL VPN, and content filtering subscription services.

The USG models need a license for UTM (Unified Threat Management) functionality - see [Section 1.1 on page 18](#) for details.

You can purchase an iCard and enter the license key from it, at [www.myzyxel.com](http://www.myzyxel.com) to have the USG use UTM services or have the USG use more SSL VPN tunnels. See below the respective chapters in this guide for more information about UTM features.

## 7.1.2 Registration Screen

Click the link in this screen to register your USG at myZyXEL.com. The USG should already have Internet access before you can access it. Click **Configuration > Licensing > Registration** in the navigation panel to open the screen as shown next.

Click on the icon to go to the OneSecurity.com website where there is guidance on configuration walkthrough and other information.

**Figure 111** Configuration > Licensing > Registration > portal.myzyxel.com

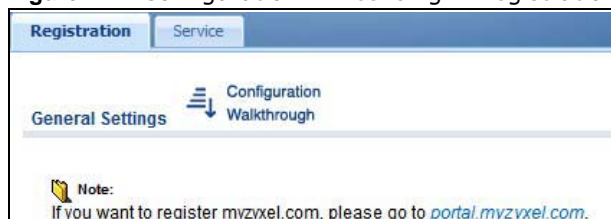

## 7.1.3 Service Screen

Use this screen to display the status of your service registrations and upgrade licenses. To activate or extend a standard service subscription, purchase an iCard and enter the iCard's PIN number (license key) in this screen. Click **Configuration > Licensing > Registration > Service** to open the screen as shown next.

**Figure 112** Configuration > Licensing > Registration > Service



The following table describes the labels in this screen.

**Table 57** Configuration > Licensing > Registration > Service

LABEL	DESCRIPTION
License Status	
#	This is the entry's position in the list.
Service	This lists the services that available on the USG.
Status	This field displays whether a service is activated ( <b>Licensed</b> ) or not ( <b>Not Licensed</b> ) or expired ( <b>Expired</b> ).
Registration Type	This field displays whether you applied for a trial application ( <b>Trial</b> ) or registered a service with your iCard's PIN number ( <b>Standard</b> ). This field is blank when a service is not activated.

**Table 57** Configuration > Licensing > Registration > Service (continued)

<b>LABEL</b>	<b>DESCRIPTION</b>
Expiration Date	This field displays the date your service expires.
Count	This field displays how many VPN tunnels you can use with your current license. This field does not apply to the other services.
Service License Refresh	Click this button to renew service license information (such as the registration status and expiration day).

## 8.1 Overview

Use the **Wireless** screens to configure how the USG manages the Access Points (APs) that are connected to it.

### 8.1.1 What You Can Do in this Chapter

- The **AP Management** screen ([Section 8.2 on page 137](#)) manages all of the APs connected to the USG.
- The **DCS** screen ([Section 8.2 on page 137](#)) configures dynamic radio channel selection.

### 8.1.2 What You Need to Know

The following terms and concepts may help as you read this chapter.

#### **Station / Wireless Client**

A station or wireless client is any wireless-capable device that can connect to an AP using a wireless signal.

#### **Dynamic Channel Selection (DCS)**

Dynamic Channel Selection (DCS) is a feature that allows an AP to automatically select the radio channel upon which it broadcasts by scanning the area around it and determining what channels are currently being used by other devices.



## 8.2 AP Management Screen

Use this screen to manage the USG's general wireless settings. Click **Configuration > Wireless > AP Management** to access this screen.

**Figure 113** Configuration > Wireless > AP Management

The screenshot shows the 'WLAN Setting' configuration page for a 'Wireless AP Controller'. Under the 'Radio Setting' section, 'Radio OP Mode' is set to 'AP Mode' (selected with a radio button), and 'MON Mode' is unselected. 'Radio Profile' is set to 'default' via a dropdown menu. 'Max Output Power' is set to '30' dBm (0-30). The 'MBSSID Settings' section contains a table with 8 rows, each with a '#' column and an 'SSID Profile' column, all of which are set to 'disable'. An 'Edit' button is located above the table. At the bottom of the screen are 'Apply' and 'Reset' buttons.

#	SSID Profile
1	default
2	disable
3	disable
4	disable
5	disable
6	disable
7	disable
8	disable

Each field is described in the following table.

**Table 58** Configuration > Wireless > AP Management

LABEL	DESCRIPTION
Radio Setting	
Radio OP Mode	Select the operating mode.  <b>AP Mode</b> means the radio can receive connections from wireless clients and pass their data traffic through to the USG to be managed (or subsequently passed on to an upstream gateway for managing).  <b>MON Mode</b> means the radio monitors the broadcast area for other APs, then passes their information on to the USG where it can be determined if those APs are friendly or rogue. If a radio is set to this mode it cannot receive connections from wireless clients.
Radio Profile	Select the radio profile the radio uses.
Max Output Power	Enter the output power (between 0 to 30 dBm) of the USG in this field. If there is a high density of APs in an area, decrease the output power of the USG to reduce interference with other APs.  Note: Reducing the output power also reduces the USG's effective broadcast radius.
MBSSID Settings	
Edit	Double-click an entry or select it and click <b>Edit</b> to open a screen where you can modify the entry's settings. In some tables you can just click a table entry and edit it directly in the table. For those types of tables small red triangles display for table entries with changes that you have not yet applied.
#	This field shows the index number of the SSID
SSID Profile	This field displays the SSID profile that is associated with the radio profile.

**Table 58** Configuration > Wireless > AP Management (continued)

LABEL	DESCRIPTION
Apply	Click <b>Apply</b> to save your changes back to the USG.
Reset	Click <b>Reset</b> to close the window with changes unsaved.

## 8.3 DCS Screen

Use this screen to configure dynamic radio channel selection. Click **Configuration > Wireless > DCS** to access this screen.

**Figure 114** Configuration > Wireless > DCS

Each field is described in the following table.

**Table 59** Configuration > Wireless > DCS

LABEL	DESCRIPTION
Select Now	Click this to have the USG scan for and select an available channel immediately.

## 8.4 Technical Reference

The following section contains additional technical information about the features described in this chapter.

### 8.4.1 Dynamic Channel Selection

When numerous APs broadcast within a given area, they introduce the possibility of heightened radio interference, especially if some or all of them are broadcasting on the same radio channel. If the interference becomes too great, then the network administrator must open his AP configuration options and manually change the channel to one that no other AP is using (or at least a channel that has a lower level of interference) in order to give the connected stations a minimum degree of interference. Dynamic channel selection frees the network administrator from this task by letting the AP do it automatically. The AP can scan the area around it looking for the channel with the least amount of interference.

In the 2.4 GHz spectrum, each channel from 1 to 13 is broken up into discrete 22 MHz segments that are spaced 5 MHz apart. Channel 1 is centered on 2.412 GHz while channel 13 is centered on 2.472 GHz.

**Figure 115** An Example Three-Channel Deployment

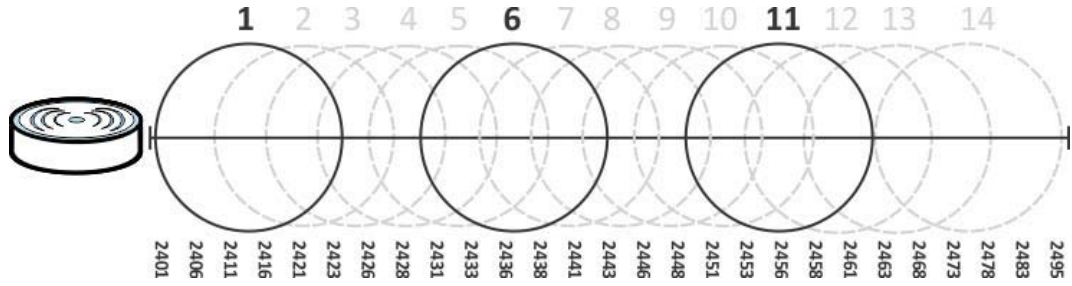

Three channels are situated in such a way as to create almost no interference with one another if used exclusively: 1, 6 and 11. When an AP broadcasts on any of these three channels, it should not interfere with neighboring APs as long as they are also limited to same trio.

**Figure 116** An Example Four-Channel Deployment

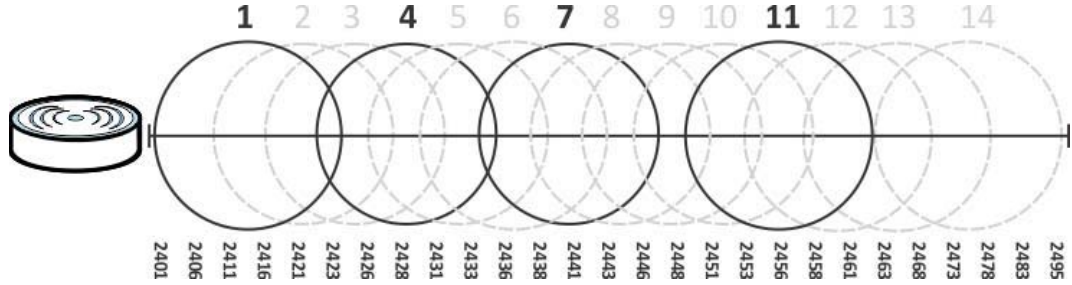

However, some regions require the use of other channels and often use a safety scheme with the following four channels: 1, 4, 7 and 11. While they are situated sufficiently close to both each other and the three so-called "safe" channels (1,6 and 11) that interference becomes inevitable, the severity of it is dependent upon other factors: proximity to the affected AP, signal strength, activity, and so on.

Finally, there is an alternative four channel scheme for ETSI, consisting of channels 1, 5, 9, 13. This offers significantly less overlap than the other one.

**Figure 117** An Alternative Four-Channel Deployment

