

User's Guide

EMG6726/8726-B10A

Dual-Band Wireless AC/N Gigabit Ethernet Gateway

Wireless AC Gigabit Ethernet Gateway with VoIP

Default Login Details

LAN IP Address	http://192.168.1.1
Login	admin
Password	See the device label

Version 5.13 Edition 1, 05/2019

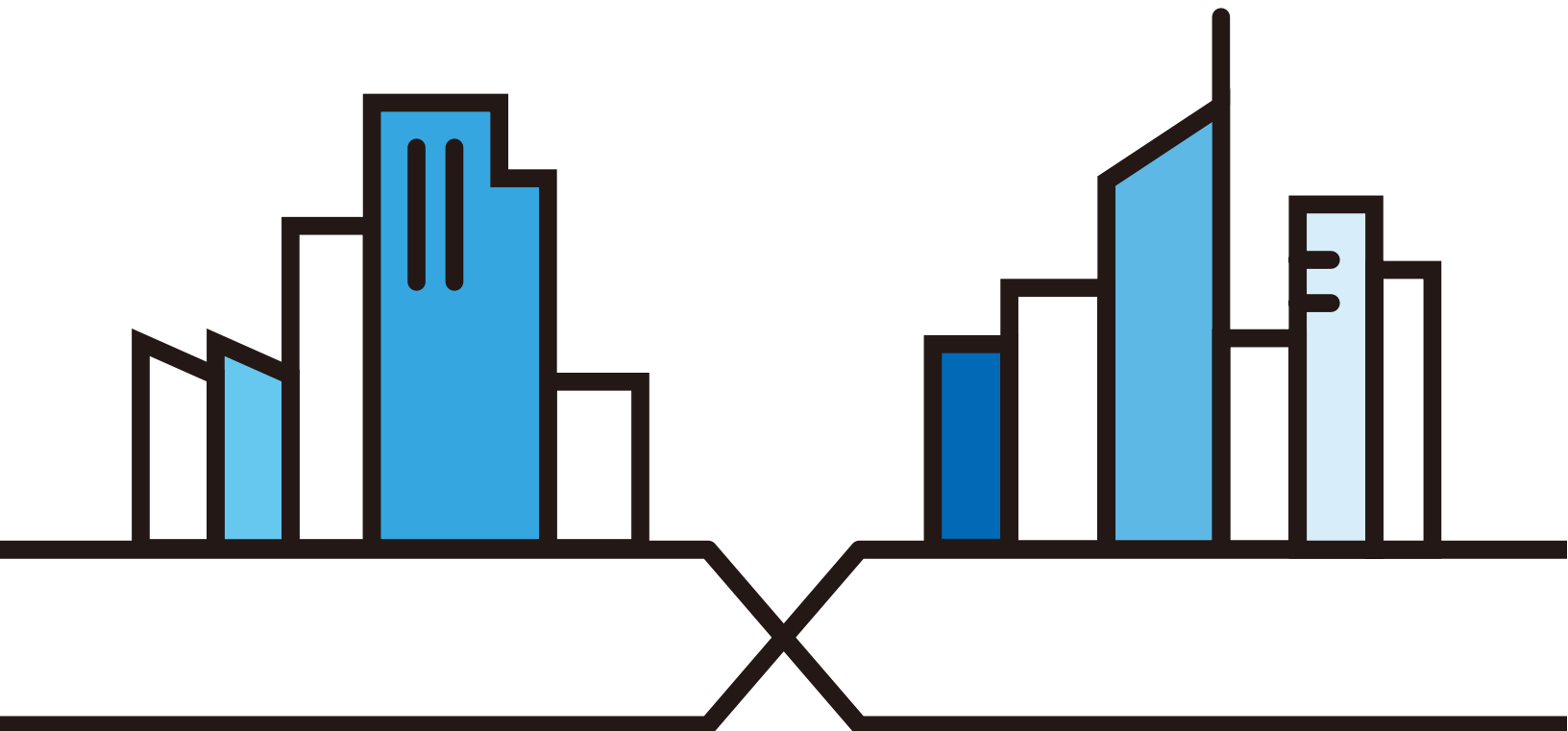

IMPORTANT!

READ CAREFULLY BEFORE USE.

KEEP THIS GUIDE FOR FUTURE REFERENCE.

Graphics in this book may differ slightly from the product due to differences in operating systems, operating system versions, or if you installed updated firmware/software for your device. Every effort has been made to ensure that the information in this manual is accurate.

Related Documentation

- Quick Start Guide

The Quick Start Guide shows how to connect the EMG and access the Web Configurator.

- More Information

Go to **support.zyxel.com** to find other information on the EMG.



Document Conventions

Warnings and Notes

These are how warnings and notes are shown in this guide.

Warnings tell you about things that could harm you or your device.







Note: Notes tell you other important information (for example, other things you may need to configure or helpful tips) or recommendations.





Syntax Conventions

- The EMG6726-B10A may be referred to as the “EMG” in this guide.
- Product labels, screen names, field labels and field choices are all in **bold** font.
- A right angle bracket (>) within a screen name denotes a mouse click. For example, **Network Setting > Broadband** means you first click **Network Setting** in the navigation panel, then the **Broadband** sub menu to get to that screen.

Icons Used in Figures

Figures in this user guide may use the following generic icons. The EMG icon is not an exact representation of your device.

EMG 	Wireless Router / Access Point 	Switch 
Firewall 	USB Storage Device 	Server 

<p>Telephone</p> 	<p>Cell Tower</p> 	<p>Printer</p> 
<p>Telephone Jack</p> 	<p>Splitter</p> 	

Contents Overview

User's Guide	16
Introducing the EMG	17
The Web Configurator	27
Quick Start	34
Tutorials	37
Technical Reference	59
Network Map and Status Screens	60
Broadband	64
Wireless	77
Home Networking	100
Routing	126
Quality of Service (QoS)	134
Network Address Translation (NAT)	153
Dynamic DNS Setup	170
IGMP/MLD	174
VLAN Group	177
Interface Grouping	179
Home Connectivity	184
Firewall	185
MAC Filter	193
Parental Control	195
Scheduler Rule	199
Certificates	201
Voice	208
Log	235
Traffic Status	238
ARP Table	242
Routing Table	244
Multicast Status	246
System	248
User Account	249
Remote Management	252
SNMP	255
Time Settings	257
E-mail Notification	259
Log Setting	261
Firmware Upgrade	264

Backup/Restore	266
Diagnostic	269
Troubleshooting	274
Appendices	279

Table of Contents

Document Conventions	3
Contents Overview	5
Table of Contents	7
Part I: User's Guide.....	16
Chapter 1	
Introducing the EMG.....	17
1.1 Overview	17
1.1.1 Internet Access	17
1.1.2 Ethernet WAN	17
1.1.3 Dual-Band	18
1.1.4 Triple Play	19
1.1.5 Wireless Access	19
1.2 Ways to Manage the EMG	19
1.3 Good Habits for Managing the EMG	20
1.4 Hardware	20
1.4.1 Front Panel	20
1.4.2 LEDs (Lights)	21
1.4.3 Using the WPS Button	23
1.4.4 Rear Panel	23
1.4.5 The RESET Button	24
1.4.6 Wall Mounting	25
Chapter 2	
The Web Configurator.....	27
2.1 Overview	27
2.1.1 Accessing the Web Configurator	27
2.2 Web Configurator Layout	29
2.2.1 Title Bar	29
2.2.2 Navigation Panel	30
Chapter 3	
Quick Start.....	34
3.1 Overview	34
3.2 Quick Start Setup	34

Chapter 4	
Tutorials	37
4.1 Overview	37
4.2 Setting Up a New WAN Connection	37
4.3 Setting Up a Secure Wireless Network	40
4.3.1 Configuring the Wireless Network Settings	40
4.3.2 Using WPS	42
4.3.3 Connecting to the EMG's Wi-Fi Network Manually (No WPS)	44
4.3.4 Configuring Wireless Security on the EMG	44
4.3.5 Configure Your Notebook	46
4.4 Setting Up Multiple Wireless Groups	48
4.5 Configuring Static Route for Routing to Another Network	51
4.6 Configuring QoS Queue and Class Setup	53
4.7 Access the EMG Using DDNS	56
4.7.1 Registering a DDNS Account on www.dyndns.org	56
4.7.2 Configuring DDNS on Your EMG	57
4.7.3 Testing the DDNS Setting	57
4.8 Configuring the MAC Address Filter	57
Part II: Technical Reference	59
Chapter 5	
Network Map and Status Screens	60
5.1 Overview	60
5.2 The Status Screen	60
5.3 The Network Map Screen	62
Chapter 6	
Broadband	64
6.1 Overview	64
6.1.1 What You Can Do in this Chapter	64
6.1.2 What You Need to Know	64
6.1.3 Before You Begin	67
6.2 The Broadband Screen	67
6.2.1 Add/Edit Internet Connection	68
6.3 Technical Reference	74
Chapter 7	
Wireless	77
7.1 Overview	77
7.1.1 What You Can Do in this Chapter	77

7.1.2 What You Need to Know	77
7.2 The WiFi Screen	78
7.2.1 The WiFi Edit Screen	78
7.3 The Guest WiFi Screen	80
7.3.1 Edit Guest WiFi	81
7.4 The WPS Screen	82
7.5 The Advanced Screen	82
7.6 The Channel Status Screen	85
7.7 The MESH Screen	87
7.8 Technical Reference	89
7.8.1 Wireless Network Overview	89
7.8.2 Additional Wireless Terms	91
7.8.3 Wireless Security Overview	91
7.8.4 Signal Problems	93
7.8.5 BSS	93
7.8.6 MBSSID	94
7.8.7 Preamble Type	94
7.8.8 WiFi Protected Setup (WPS)	95

Chapter 8

Home Networking..... 100

8.1 Overview	100
8.1.1 What You Can Do in this Chapter	100
8.1.2 What You Need To Know	101
8.1.3 Before You Begin	102
8.2 The LAN Setup Screen	102
8.3 The Static DHCP Screen	106
8.4 The UPnP Screen	107
8.4.1 Turning on UPnP in Windows 7 Example	108
8.4.2 Auto-discover Your UPnP-enabled Network Device	110
8.4.3 Turn on UPnP in Windows 10 Example	112
8.4.4 Auto-discover Your UPnP-enabled Network Device	114
8.4.5 Web Configurator Easy Access in Windows 7	117
8.4.6 Web Configurator Easy Access in Windows 10	119
8.5 The Additional Subnet Screen	121
8.6 The STB Vendor ID Screen	122
8.7 The Wake on LAN Screen	122
8.8 The TFTP Server Name Screen	123
8.9 Technical Reference	123
8.9.1 LANs, WANs and the EMG	123
8.9.2 DHCP Setup	124
8.9.3 DNS Server Addresses	124
8.9.4 LAN TCP/IP	125

Chapter 9	
Routing	126
9.1 Overview	126
9.2 The Routing Screen	126
9.2.1 Add/Edit Static Route	127
9.3 The DNS Route Screen	128
9.3.1 The DNS Route Add Screen	129
9.4 The Policy Route Screen	130
9.4.1 Add/Edit Policy Route	131
9.5 RIP	132
9.5.1 The RIP Screen	132
Chapter 10	
Quality of Service (QoS)	134
10.1 Overview	134
10.1.1 What You Can Do in this Chapter	134
10.2 What You Need to Know	135
10.3 The Quality of Service General Screen	136
10.4 The Queue Setup Screen	137
10.4.1 Adding a QoS Queue	139
10.5 The Classification Setup Screen	140
10.5.1 Add/Edit QoS Class	140
10.6 The QoS Shaper Setup Screen	144
10.6.1 Add/Edit a QoS Shaper	145
10.7 The QoS Policer Setup Screen	145
10.7.1 Add/Edit a QoS Policer	146
10.8 QoS Monitor	147
10.9 Technical Reference	148
Chapter 11	
Network Address Translation (NAT)	153
11.1 Overview	153
11.1.1 What You Can Do in this Chapter	153
11.1.2 What You Need To Know	153
11.2 The Port Forwarding Screen	154
11.2.1 Add/Edit Port Forwarding	156
11.3 The Applications Screen	157
11.3.1 Add New Application	158
11.4 The Port Triggering Screen	159
11.4.1 Add/Edit Port Triggering Rule	160
11.5 The DMZ Screen	161
11.6 The ALG Screen	162
11.7 The Address Mapping Screen	163

11.7.1 Add/Edit Address Mapping Rule	164
11.8 The Sessions Screen	165
11.9 Technical Reference	165
11.9.1 NAT Definitions	166
11.9.2 What NAT Does	166
11.9.3 How NAT Works	167
11.9.4 NAT Application	167
Chapter 12	
Dynamic DNS Setup.....	170
12.1 Overview	170
12.1.1 What You Can Do in this Chapter	170
12.1.2 What You Need To Know	170
12.2 The DNS Entry Screen	171
12.2.1 Add/Edit DNS Entry	171
12.3 The Dynamic DNS Screen	172
Chapter 13	
IGMP/MLD.....	174
13.1 Overview	174
13.1.1 What You Need To Know	174
13.2 The IGMP/MLD Screen	174
Chapter 14	
VLAN Group.....	177
14.1 Overview	177
14.1.1 What You Can Do in this Chapter	177
14.2 The VLAN Group Screen	177
14.2.1 Add/Edit a VLAN Group	178
Chapter 15	
Interface Grouping.....	179
15.1 Overview	179
15.1.1 What You Can Do in this Chapter	179
15.2 The Interface Grouping Screen	179
15.2.1 Interface Group Configuration	180
15.2.2 Interface Grouping Criteria	182
Chapter 16	
Home Connectivity.....	184
16.1 Overview	184
16.2 The Home Connectivity Screen	184

Chapter 17	
Firewall	185
17.1 Overview	185
17.1.1 What You Can Do in this Chapter	185
17.1.2 What You Need to Know	186
17.2 The Firewall Screen	186
17.3 The Protocol Screen	187
17.3.1 Add/Edit a Service	188
17.4 The Access Control Screen	189
17.4.1 Add/Edit an ACL Rule	190
17.5 The DoS Screen	191
Chapter 18	
MAC Filter	193
18.1 Overview	193
18.2 The MAC Filter Screen	193
Chapter 19	
Parental Control	195
19.1 Overview	195
19.2 The Parental Control Screen	195
19.2.1 Add/Edit a Parental Control Profile	196
Chapter 20	
Scheduler Rule	199
20.1 Overview	199
20.2 The Scheduler Rule Screen	199
20.2.1 Add/Edit a Schedule	199
Chapter 21	
Certificates	201
21.1 Overview	201
21.1.1 What You Can Do in this Chapter	201
21.2 What You Need to Know	201
21.3 The Local Certificates Screen	201
21.3.1 Create Certificate Request	202
21.3.2 View Certificate Request	203
21.4 The Trusted CA Screen	204
21.4.1 View Trusted CA Certificate	205
21.4.2 Import Trusted CA Certificate	206
Chapter 22	
Voice	208

22.1 Overview	208
22.1.1 What You Can Do in this Chapter	208
22.1.2 What You Need to Know About VoIP	208
22.2 Before You Begin	209
22.3 SIP Account	209
22.3.1 SIP Account Add/Edit	210
22.4 SIP Service Provider	214
22.4.1 SIP Service Provider Add/Edit	215
22.5 Phone Device	219
22.5.1 Phone Device Edit	220
22.6 Region	221
22.7 Call Rule	221
22.8 Technical Reference	222
22.8.1 Quality of Service (QoS)	230
22.8.2 Phone Services Overview	230
Chapter 23	
Log	235
23.1 Overview	235
23.1.1 What You Can Do in this Chapter	235
23.1.2 What You Need To Know	235
23.2 The System Log Screen	236
23.3 The Security Log Screen	236
Chapter 24	
Traffic Status	238
24.1 Overview	238
24.1.1 What You Can Do in this Chapter	238
24.2 The WAN Status Screen	238
24.3 The LAN Status Screen	239
24.4 The NAT Status Screen	240
Chapter 25	
ARP Table	242
25.1 Overview	242
25.1.1 How ARP Works	242
25.2 ARP Table Screen	242
Chapter 26	
Routing Table	244
26.1 Overview	244
26.2 The Routing Table Screen	244

Chapter 27	
Multicast Status	246
27.1 Overview	246
27.2 The IGMP Status Screen	246
27.3 The MLD Status Screen	246
Chapter 28	
System.....	248
28.1 Overview	248
28.2 The System Screen	248
Chapter 29	
User Account.....	249
29.1 Overview	249
29.2 The User Account Screen	249
29.2.1 The User Account Add/Edit Screen	250
Chapter 30	
Remote Management	252
30.1 Overview	252
30.2 The MGMT Services Screen	252
30.3 The Trust Domain Screen	253
30.3.1 The Add Trust Domain Screen	253
Chapter 31	
SNMP	255
31.1 Overview	255
31.2 The SNMP Screen	255
Chapter 32	
Time Settings.....	257
32.1 Overview	257
32.2 The Time Screen	257
Chapter 33	
E-mail Notification	259
33.1 Overview	259
33.2 The E-mail Notification Screen	259
33.2.1 E-mail Notification Edit	260
Chapter 34	
Log Setting	261
34.1 Overview	261

34.2 The Log Settings Screen	261
34.2.1 Example E-mail Log	262
Chapter 35	
Firmware Upgrade	264
35.1 Overview	264
35.2 The Firmware Screen	264
Chapter 36	
Backup/Restore	266
36.1 Overview	266
36.2 The Backup/Restore Screen	266
36.3 The Reboot Screen	268
Chapter 37	
Diagnostic.....	269
37.1 Overview	269
37.1.1 What You Can Do in this Chapter	269
37.2 What You Need to Know	269
37.3 Ping & TraceRoute & Nslookup	270
37.4 802.1ag	270
37.5 802.3ah	272
Chapter 38	
Troubleshooting.....	274
38.1 Power, Hardware Connections, and LEDs	274
38.2 EMG Access and Login	275
38.3 Internet Access	276
38.4 Wireless Internet Access	277
38.5 UPnP	278
Part III: Appendices	279
Appendix A Customer Support.....	280
Appendix B Wireless LANs.....	286
Appendix C IPv6.....	296
Appendix D Services.....	304
Appendix E Legal Information	308
Index	317

PART I

User's Guide

CHAPTER 1

Introducing the EMG

1.1 Overview

EMG refers to these models as outlined below.

- EMG6726-B10A
- EMG8726-B10A

The EMG is an Ethernet gateway providing triple-play services with optimized HD IPTV services for the home or office. This model offers a Gigabit Ethernet (GbE) WAN port. The EMG offers 2.4G and 5G Wi-Fi networks that can operate simultaneously.

The following table describes the feature difference of the EMG.

Table 1 EMG Comparison Table

	EMG6726-B10A	EMG8726-B10A
VoIP (see Chapter 22 on page 208 for details)		✓
DFS Channel	✓	

Only use firmware for your EMG's specific model.

1.1.1 Internet Access

Your EMG has a Gigabit Ethernet port for super-fast Internet access. It provides Internet access by connecting the WAN port to your ISP. Computers can connect to the EMG's LAN ports (or wirelessly) and access the Internet simultaneously.

You can also configure IP filtering on the EMG for secure Internet access. When the IP filter is on, all incoming traffic from the Internet to your network is blocked by default unless it is initiated from your network. This means that probes from the outside to your network are not allowed, but you can safely browse the Internet and download files.

1.1.2 Ethernet WAN

If you have another broadband modem or router available, you can connect the WAN port to the broadband modem or router. This way, you can access the Internet via an Ethernet connection and still use the QoS, Firewall and parental control functions on the EMG.

Figure 1 EMG's Internet Access Application: Ethernet WAN

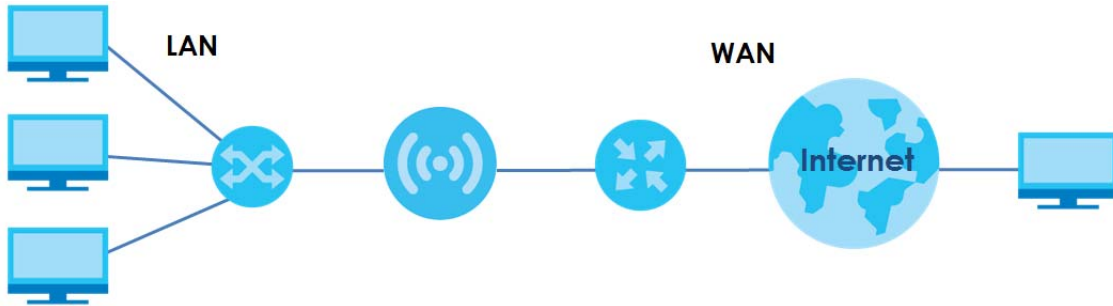

1.1.3 Dual-Band

The EMG is a dual-band gateway that can use both 2.4G and 5G networks at the same time. You could use the 2.4 GHz band for regular Internet surfing and downloading while using the 5 GHz band for time sensitive traffic like high-definition video, music, and gaming.

Figure 2 Dual-Band Application

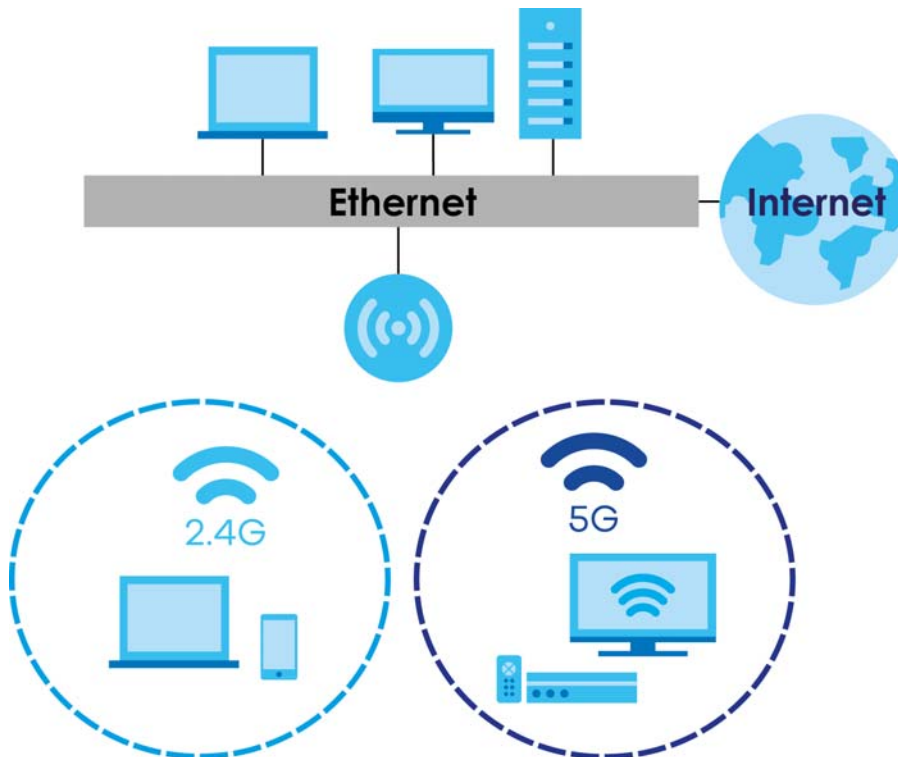

1.1.4 Triple Play

Triple play means using broadband Internet access, VoIP and streaming video/audio media, all at the same time with no noticeable loss in bandwidth.

Figure 3 Triple Play Example

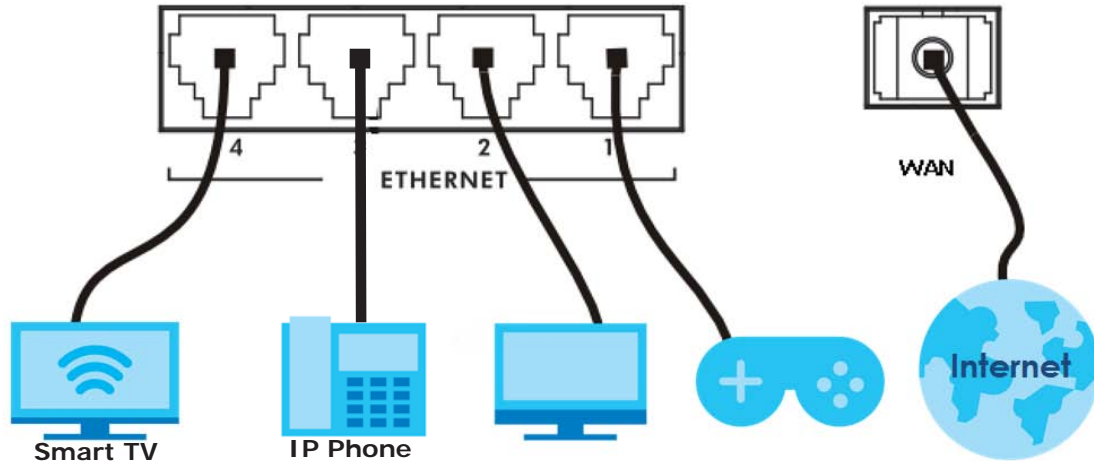

1.1.5 Wireless Access

The EMG is a wireless Access Point (AP) for IEEE 802.11b/g/n/a/ac wireless clients, such as notebook computers, iPads, smartphones, etc. These devices can connect to the EMG to access network resources and the Internet.

Your EMG supports Wi-Fi Protected Setup (WPS), which allows you to quickly set up a wireless network with strong security.

You can configure your wireless network using the built-in Web Configurator.

See [Section 4.3 on page 40](#) for more information about how to set up a wireless network.

Figure 4 Wireless Access Example

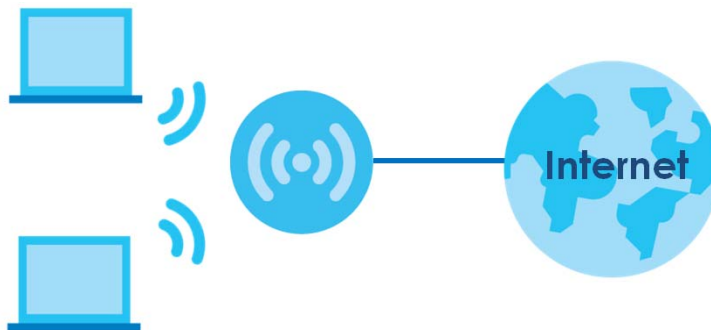

1.2 Ways to Manage the EMG

Use any of the following methods to manage the EMG.

Figure 6 LEDs on the EMG8726-B10A

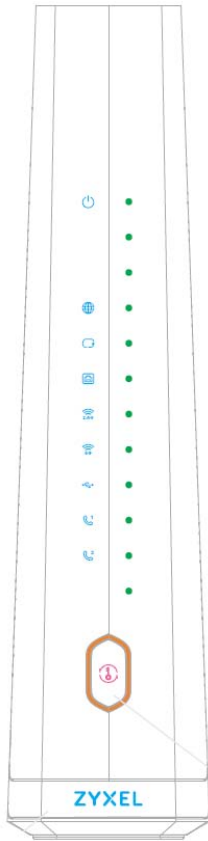

1.4.2 LEDs (Lights)

The following table describes the LEDs.

None of the LEDs are on if the EMG is not receiving power.

Table 2 EMG6726-B10A LED Descriptions



LED	COLOR	STATUS	DESCRIPTION
 Power	Green	On	The EMG is receiving power and ready for use.
		Blinking	The EMG is self-testing.
	Red	On	The EMG detected an error while self-testing, or there is a device malfunction.
		Blinking	The EMG is uploading firmware.
 Internet	Green	On	The EMG has an IP connection but no traffic.
		Blinking	The EMG is sending or receiving IP traffic.
		Off	There is no Internet connection or the gateway is in bridged mode.
	Red	On	The EMG attempted to make an IP connection but failed. Possible causes are no response from a DHCP server, no PPPoE response, PPPoE authentication failed.

Table 2 EMG6726-B10A LED Descriptions (continued)





LED	COLOR	STATUS	DESCRIPTION
 LAN/WAN	Green	On	The EMG has a successful 10/100/1000 Mbps Ethernet connection on the WAN.
		Blinking	The EMG is sending or receiving data to/from the WAN at 10/100/1000 Mbps.
	Off	There is no Ethernet connection on the WAN.	
 Ethernet 1~4	Green	On	The EMG has a successful 10/100/1000 Mbps Ethernet connection with a device on the Local Area Network (LAN).
		Blinking	The EMG is sending or receiving data to/from the LAN at 10/100/1000 Mbps.
	Off	The EMG does not have an Ethernet connection with the LAN.	
 USB	Note: The USB LED is reserved for future development.		
 WiFi 2.4G WiFi 5G	Green	On	The 2.4 GHz or 5 GHz wireless network is activated.
		Blinking	The EMG is communicating with 2.4 GHz or 5 GHz wireless clients.
	Amber	Blinking	The EMG is setting up a WPS connection with a 2.4 GHz or 5 GHz wireless client.
		Off	The 2.4 GHz or 5GHz wireless network is not activated.
 WPS	Amber	On	WPS is enabled.
		Off	WPS is disabled.

Table 3 EMG8726-B10A LED Descriptions









LED	COLOR	STATUS	DESCRIPTION
 Power	Green	On	The EMG is receiving power and ready for use.
		Blinking	The EMG is self-testing.
	Red	On	The EMG detected an error while self-testing, or there is a device malfunction.
		Blinking	The EMG is uploading firmware.
Off	The EMG is not receiving power.		
 Internet	Green	On	The EMG has an IP connection but no traffic. Your device has a WAN IP address (either static or assigned by a DHCP server), PPP negotiation was successfully completed (if used) and the DSL connection is up.
		Blinking	The EMG is sending or receiving IP traffic.
		Off	There is no Internet connection or the gateway is in bridged mode.
	Red	On	The EMG attempted to make an IP connection but failed. Possible causes are no response from a DHCP server, no PPPoE response, PPPoE authentication failed.
 WAN	Green	On	The EMG has a successful 10/100/1000 Mbps Ethernet connection on the WAN.
		Blinking	The EMG is sending or receiving data to/from the WAN at 10/100/1000 Mbps.
	Off	There is no Ethernet connection on the WAN.	
 Ethernet	Green	On	The EMG has a successful 10/100/1000 Mbps Ethernet connection with a device on the Local Area Network (LAN).
		Blinking	The EMG is sending or receiving data to/from the LAN at 10/100/1000 Mbps.
	Off	The EMG does not have an Ethernet connection with the LAN.	

Table 3 EMG8726-B10A LED Descriptions (continued)

LED	COLOR	STATUS	DESCRIPTION
 WiFi 2.4G WiFi 5G	Green	On	The 2.4 GHz or 5 GHz wireless network is activated.
		Blinking	The EMG is communicating with 2.4 GHz or 5 GHz wireless clients.
	Amber	Blinking	The EMG is setting up a WPS connection with a 2.4 GHz or 5 GHz wireless client.
		Off	The 2.4 GHz or 5GHz wireless network is not activated.
 USB	Note: The USB LED is reserved for future development.		
 Phone1, Phone2	Green	On	A SIP account is registered for the phone port, and there's no voice message in the corresponding SIP account.
		Blinking	A telephone connected to the phone port has its receiver off of the hook or there is an incoming call.
	Amber	On	A SIP account is registered for the phone port and there is a voice message in the corresponding SIP account.
		Blinking	A telephone connected to the phone port has its receiver off the hook and there is a voice message in the corresponding SIP account.
		Off	The phone port does not have a SIP account registered.
	Red	On	Registration to the network has failed.
 WPS	Amber	On	WPS is enabled.
		Off	WPS is disabled.

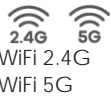
1.4.3 Using the WPS Button

Once the **WiFi** LED turns green, the wireless network is active. If the wireless network is turned off, see [Section 7.2.1 on page 78](#) for how to enable the wireless network on the EMG.

You can also use the **WPS** button to quickly set up a secure wireless connection between the EMG and a WPS-compatible client by adding one device at a time.

To activate WPS:

- 1 Make sure the **POWER** LED is on and not blinking.
- 2 Press the **WPS** button for more than five seconds and release it.
- 3 Press the WPS button on another WPS-enabled device within range of the EMG. The **WiFi 2.4G** and **WiFi 5G** LEDs flash amber while the EMG sets up a WPS connection with the other wireless device.
- 4 Once the connection is successfully made, the **WPS** LED shines green. Note that it depends on your client's configuration to have a 2.4GHz or 5GHz wireless network.

The **WPS** LED turns off when the wireless network is off.

1.4.4 Rear Panel

The following graphic displays the rear panel of the EMG.

Figure 7 EMG67256-B10A's Rear Panel

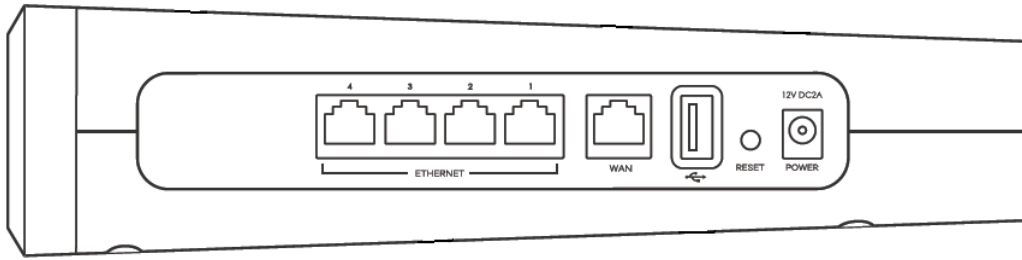
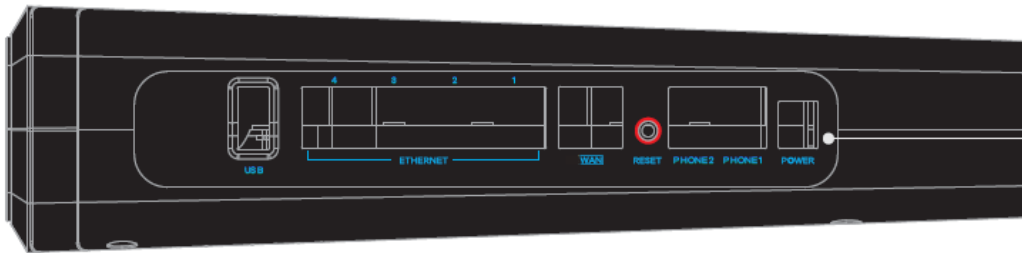

Figure 8 EMG8726-B10A's Rear Panel



The following table describes the items on the rear panel.

Table 4 Rear Panel Ports

LABEL	DESCRIPTION
ETHERNET1 ~ ETHERNET4	Connect computers or other Ethernet devices to Ethernet ports for Internet access.
WAN	Connect an Ethernet cable to the Ethernet WAN port for Internet access.
PHONE1 ~PHONE2	Connect analog phones to the phone ports to make phone calls.
USB	The USB port is reserved for future development.
Reset	Press the button to return the EMG to the factory defaults.
Power	Connect the power cable and press the power button to start the EMG.

1.4.5 The RESET Button

If you forget your password or cannot access the Web Configurator, you will need to use the **RESET** button at the back of the device to reload the factory-default configuration file. This means that you will lose all configurations that you had previously and the password will be reset to the factory default (see the device label).

- 1 Make sure the **POWER** LED is on (not blinking).
- 2 To set the device back to the factory default settings, press the **RESET** button for more than ten seconds or until the **POWER** LED begins to blink and then release it. When the **POWER** LED begins to blink, the defaults have been restored and the device restarts.

1.4.6 Wall Mounting

You may need screw anchors if mounting on a concrete or brick wall.

Table 5 Wall Mounting Information

Distance between holes	88 mm
Screws	Two
Screw anchors (optional)	Two

The following figure introduces the specifications of the screws and screws anchors for wall mounting.

Figure 9 Screws & Screw Anchors Specifications

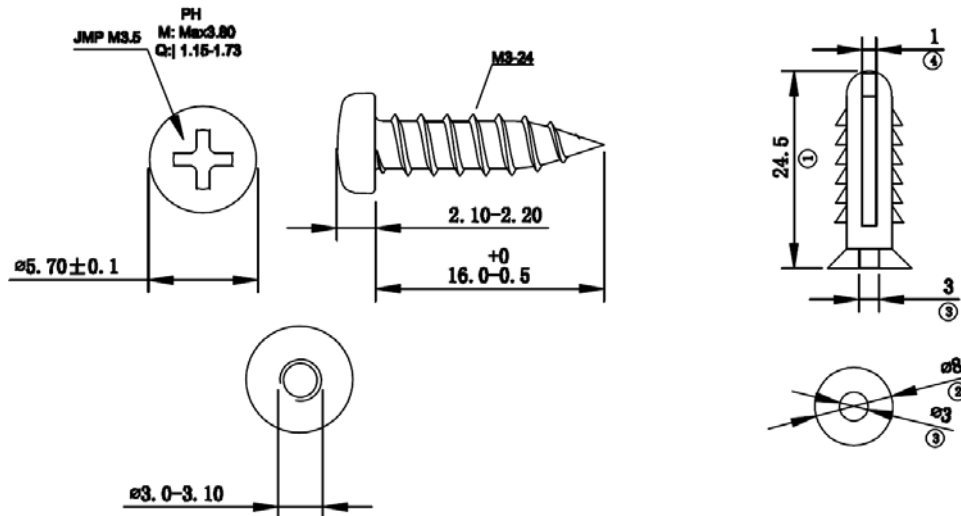

- 1 Select a position free of obstructions on a wall strong enough to hold the weight of the device.
- 2 Mark two holes on the wall at the appropriate distance apart for the screws.

Be careful to avoid damaging pipes or cables located inside the wall when drilling holes for the screws.

- 3 If using screw anchors, drill two holes for the screw anchors into the wall. Push the anchors into the full depth of the holes, then insert the screws into the anchors. Do not insert the screws all the way in - leave a small gap of about 0.5 cm.

If not using screw anchors, use a screwdriver to insert the screws into the wall. Do not insert the screws all the way in - leave a gap of about 0.5 cm.

- 4 Make sure the screws are fastened well enough to hold the weight of the EMG with the connection cables.
- 5 Align the holes on the back of the EMG with the screws on the wall. Hang the EMG on the screws.

Figure 10 Wall Mounting Example

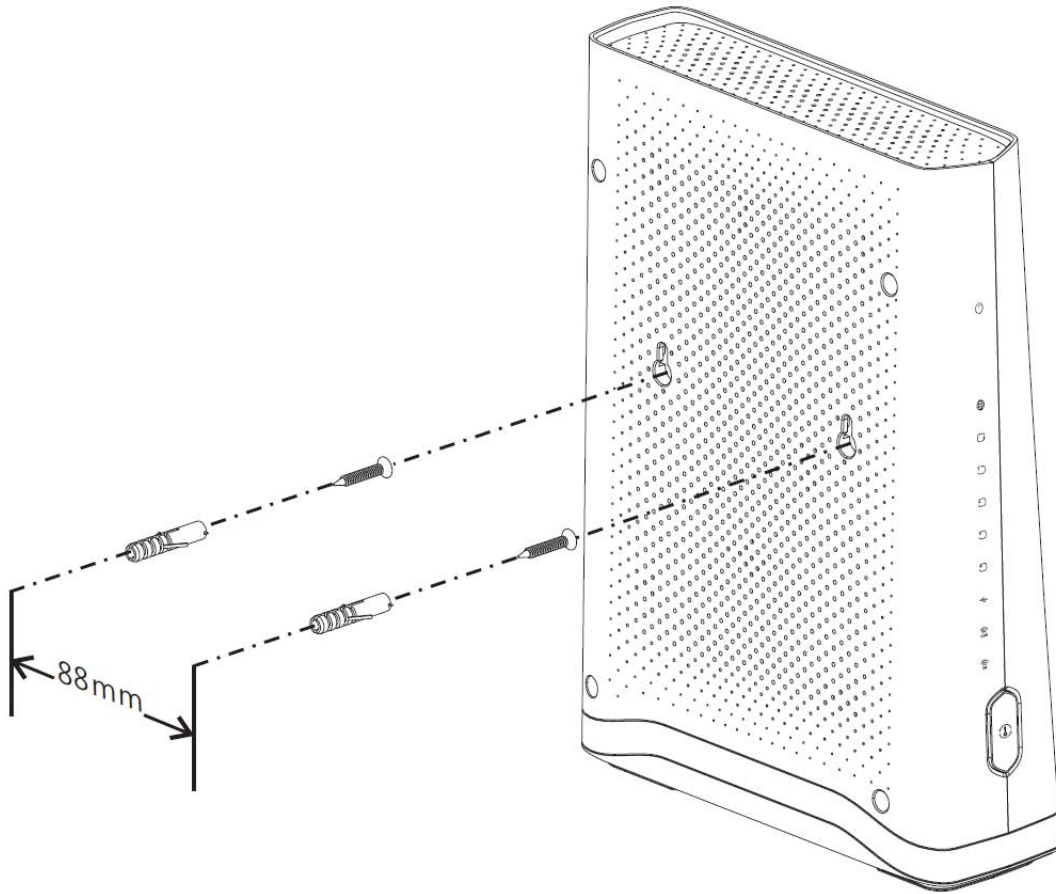

CHAPTER 2

The Web Configurator

2.1 Overview

The web configurator is an HTML-based management interface that allows easy EMG setup and management via Internet browser. Use Internet Explorer 8.0 and later versions or Mozilla Firefox 3 and later versions or Safari 2.0 and later versions. The recommended screen resolution is 1024 by 768 pixels.

In order to use the web configurator you need to allow:

- Web browser pop-up windows from your EMG. Web pop-up blocking is enabled by default in Windows XP SP (Service Pack) 2.
- JavaScript (enabled by default).
- Java permissions (enabled by default).

2.1.1 Accessing the Web Configurator

- 1 Make sure your EMG hardware is properly connected (refer to the Quick Start Guide).
- 2 Launch your web browser. If the EMG does not automatically re-direct you to the login screen, go to <http://192.168.1.1>.
- 3 A password screen displays. To access the administrative web configurator and manage the EMG, type the default username **admin** and password (**see the back label on your EMG**) in the password screen and click **Login**. If you have changed the password, enter your password and click **Login**.

Figure 11 Password Screen

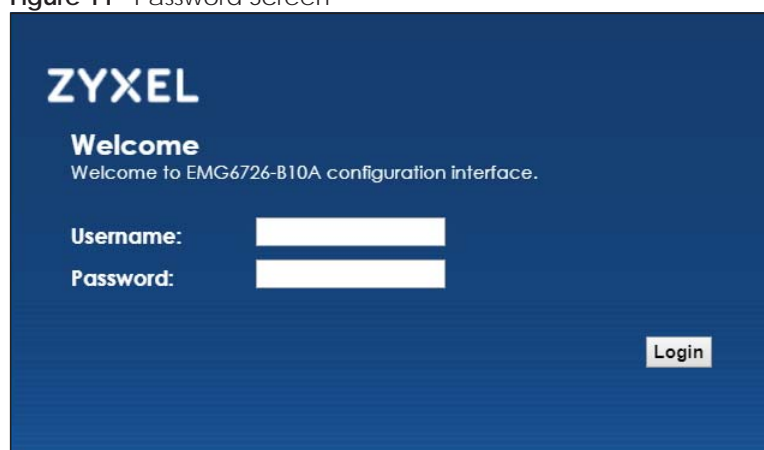

- 4 The following screen displays if you have not yet changed your password. Enter a new password, retype it to confirm and click **Apply**.

Figure 12 Change Password Screen

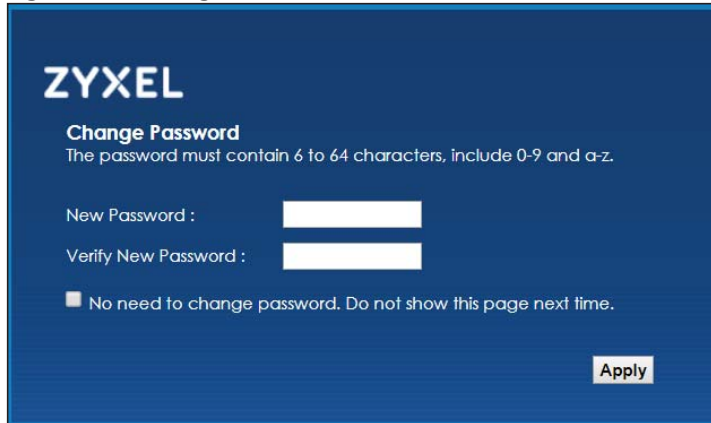

ZYXEL

Change Password
The password must contain 6 to 64 characters, include 0-9 and a-z.

New Password :

Verify New Password :

No need to change password. Do not show this page next time.

Apply

- 5 The **Quick Start Wizard** screen appears. You can configure basic Internet access, and wireless settings. See [Chapter 3 on page 34](#) for more information.
- 6 After you finished or closed the **Quick Start Wizard** screen, the **Network Map** page appears.

Figure 13 Network Map: List View Mode

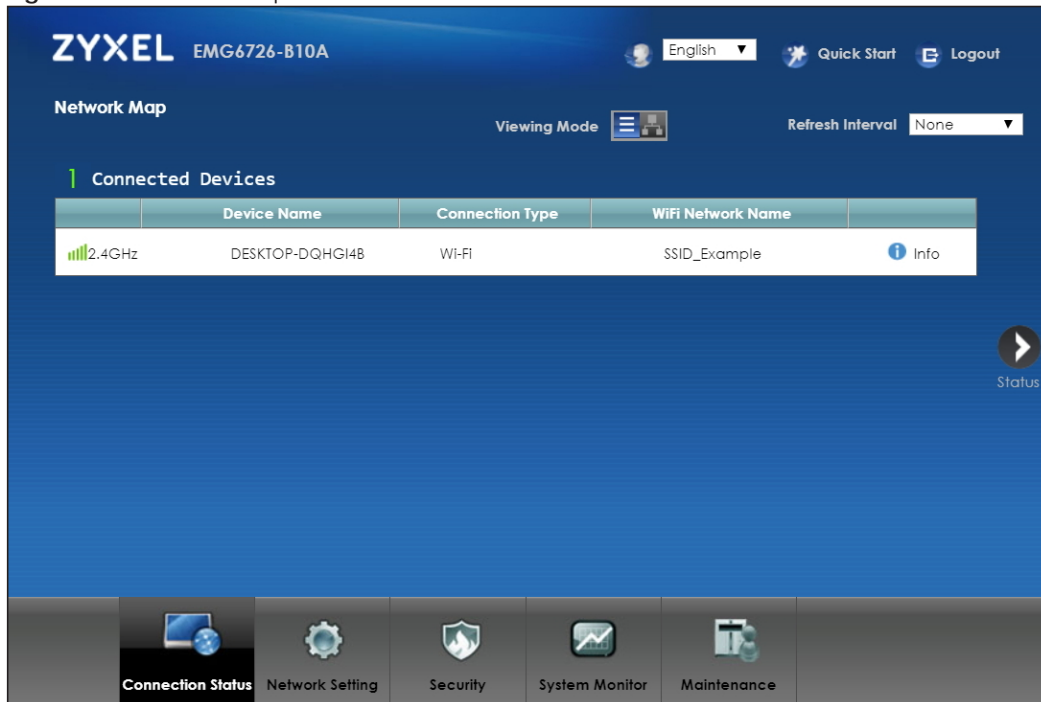

ZYXEL EMG6726-B10A English Quick Start Logout

Network Map Viewing Mode Refresh Interval None

1 Connected Devices

	Device Name	Connection Type	WiFi Network Name	
2.4GHz	DESKTOP-DQHGI4B	WI-FI	SSID_Example	Info

Status

Connection Status Network Setting Security System Monitor Maintenance

- 7 Click **Status** to display the **Status** screen, where you can view the EMG's interface and system information.

2.2 Web Configurator Layout

Figure 14 Screen Layout

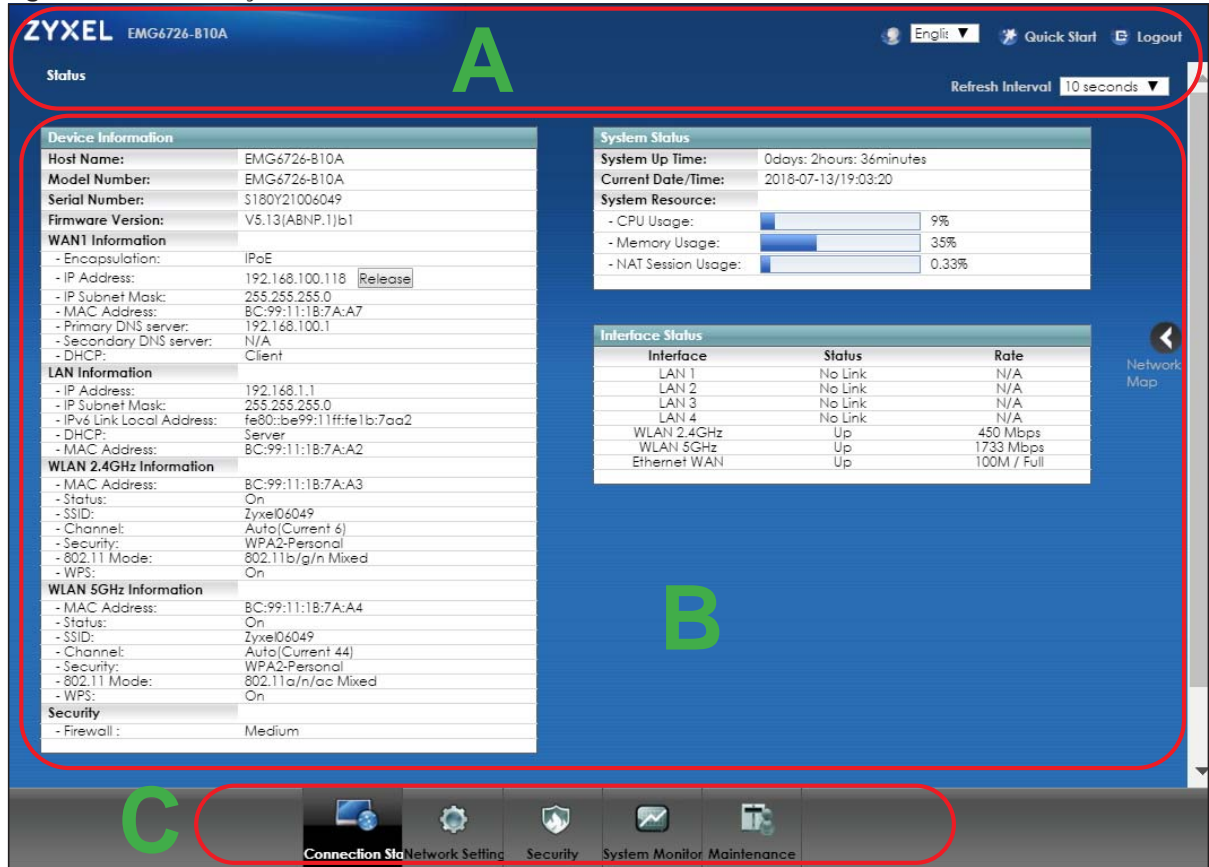

As illustrated above, the main screen is divided into these parts:

- A - title bar
- B - main window
- C - navigation panel

2.2.1 Title Bar

The title bar provides some icons in the upper right corner.

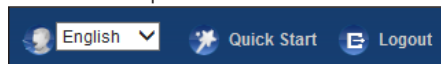



The icons provide the following functions.

Table 6 Web Configurator Icons in the Title Bar

ICON	DESCRIPTION
	Language: Select the language you prefer.

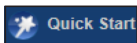
Table 6 Web Configurator Icons in the Title Bar

ICON	DESCRIPTION
	Quick Start: Click this icon to open screens where you can configure the EMG's time zone Internet access, and wireless settings.
	Logout: Click this icon to log out of the web configurator.

2.2.2 Navigation Panel

Use the menu items on the navigation panel to open screens to configure EMG features. The following tables describe each menu item.

Table 7 Navigation Panel Summary

LINK	TAB	FUNCTION
Connection Status		This screen shows the network status of the EMG and computers/devices connected to it.
Network Setting		
Broadband	Broadband	Use this screen to view and configure Ethernet WAN connections. You can also add new WAN connections.
Wireless	WiFi	Use this screen to configure the wireless LAN settings and WLAN authentication/security settings.
	Guest WiFi	Use this screen to configure multiple wireless networks on the EMG.
	WPS	Use this screen to view your WPS (Wi-Fi Protected Setup) settings. You can use the screen to add a wireless client to your wireless network.
	Advanced	Use this screen to configure advanced wireless settings.
	Channel Status	Use this screen to scan the number of devices which are using 2.4G and/or 5G wireless channels and view the results.
	MESH	Use this screen to enable MESH which combines the 2.4GHz and 5GHz wireless network name, password, security type together for eliminating configuration hassles.
Home Networking	LAN Setup	Use this screen to configure LAN TCP/IP settings, and other advanced properties.
	Static DHCP	Use this screen to assign specific IP addresses to individual MAC addresses.
	UPnP	Use this screen to turn UPnP and UPnP NAT-T on or off.
	Additional Subnet	Use this screen to configure IP alias and public static IP.
	STB Vendor ID	Use this screen to configure the Vendor IDs of the connected Set Top Box (STB) devices, which have the EMG automatically create static DHCP entries for the STB devices when they request IP addresses.
	Wake on LAN	Use this screen to remotely turn on a device on the local network.
	TFTP Server Name	Configure a TFTP server name which is sent to clients using DHCP option 66.
Routing	Static Route	Use this screen to view and set up static routes on the EMG.
	DNS Route	Use this screen to forward DNS queries for certain domain names through a specific WAN interface to its DNS server(s).
	Policy Route	Use this screen to configure policy routing on the EMG.
	RIP	Use this screen to configure Routing Information Protocol to exchange routing information with other routers.

Table 7 Navigation Panel Summary (continued)

LINK	TAB	FUNCTION
QoS	General	Use this screen to enable QoS and traffic prioritizing. You can also configure the QoS rules and actions.
	Queue Setup	Use this screen to configure QoS queues.
	Classification Setup	Use this screen to define a classifier.
	Shaper Setup	Use this screen to limit outgoing traffic rate on the selected interface.
	Policer Setup	Use this screen to configure QoS policers.
	Monitor	Use this screen to view statistics of QoS on WAN/LAN interface and the status of queues.
NAT	Port Forwarding	Use this screen to make your local servers visible to the outside world.
	Applications	Use this screen to configure servers behind the EMG.
	Port Triggering	Use this screen to change your EMG's port triggering settings.
	DMZ	Use this screen to configure a default server which receives packets from ports that are not specified in the Port Forwarding screen.
	ALG	Use this screen to enable or disable SIP ALG.
	Address Mapping	Use this screen to change your EMG's address mapping settings.
	Sessions	Use this screen to configure the maximum number of NAT sessions each client host is allowed to have through the EMG.
DNS	DNS Entry	Use this screen to view and configure DNS routes.
	Dynamic DNS	Use this screen to allow a static hostname alias for a dynamic IP address.
IGMP/MLD	IGMP/MLD	Use this screen to configure multicast settings (IGMP for IPv4 and MLD for IPv6 multicast groups) on the WAN.
Vlan Group	Vlan Group	Use this screen to group and tag VLAN IDs to outgoing traffic from the specified interface.
Interface Grouping	Interface Grouping	Use this screen to map a port to a PVC or bridge group.
Home Connectivity	ONE Connect	Use this screen to enable the one connect function on the EMG.
Security		
Firewall	General	Use this screen to configure the security level of your firewall.
	Protocol	Use this screen to add Internet services and configure firewall rules.
	Access Control	Use this screen to enable specific traffic directions for network services.
	DoS	Use this screen to activate protection against Denial of Service (DoS) attacks.
MAC Filter	MAC Filter	Use this screen to block or allow traffic from devices of certain MAC addresses to the EMG.
Parental Control	Parental Control	Use this screen to block web sites with the specific URL.
Scheduler Rule	Scheduler Rule	Use this screen to configure the days and times when a configured restriction (such as parental control) is enforced.
Certificates	Local Certificates	Use this screen to view a summary list of certificates and manage certificates and certification requests.
	Trusted CA	Use this screen to view and manage the list of the trusted CAs.
VoIP (for EMG8726-B10A)		

Table 7 Navigation Panel Summary (continued)

LINK	TAB	FUNCTION
SIP	SIP Account	Use this screen to set up information about your SIP account and configure audio settings such as volume levels for the phones connected to the VMG.
	SIP Service Provider	Use this screen to configure the SIP server information, QoS for VoIP calls, the numbers for certain phone functions, and dialing plan.
Phone	Phone Device	Use this screen to view detailed information of the phone devices.
	Region	Use this screen to select your location and a call service mode.
Call Rule	Speed Dial	Use this screen to configure speed dial for SIP phone numbers that you call often.
System Monitor		
Log	System Log	Use this screen to view the status of events that occurred to the EMG. You can export or e-mail the logs.
	Security Log	Use this screen to view all security related events. You can select level and category of the security events in their proper drop-down list window. Levels include: <ul style="list-style-type: none"> • Emergency • Alert • Critical • Error • Warning • Notice • Informational • Debugging Categories include: <ul style="list-style-type: none"> • Account • Attack • Firewall • MAC Filter
Traffic Status	WAN	Use this screen to view the status of all network traffic going through the WAN port of the EMG.
	LAN	Use this screen to view the status of all network traffic going through the LAN ports of the EMG.
	NAT	Use this screen to view NAT statistics for connected hosts.
ARP table	ARP table	Use this screen to view the ARP table. It displays the IP and MAC address of each DHCP connection.
Routing Table	Routing Table	Use this screen to view the routing table on the EMG.
Multicast Status	IGMP Status	Use this screen to view the status of all IGMP settings on the EMG.
	MLD Status	Use this screen to view the status of all MLD settings on the EMG.
Maintenance		
System	System	Use this screen to set Device name and Domain name.
User Account	User Account	Use this screen to change user password on the EMG.
Remote Management	MGMT Services	Use this screen to enable specific traffic directions for network services.
	Trust Domain	Use this screen to view a list of public IP addresses which are allowed to access the EMG through the services configured in the Maintenance > Remote Management screen.

Table 7 Navigation Panel Summary (continued)

LINK	TAB	FUNCTION
SNMP	SNMP	Use this screen to configure SNMP (Simple Network Management Protocol) settings.
Time	Time	Use this screen to change your EMG's time and date.
E-mail Notification	E-mail Notification	Use this screen to configure up to two mail servers and sender addresses on the EMG.
Log Setting	Log Setting	Use this screen to change your EMG's log settings.
Firmware Upgrade	Firmware Upgrade	Use this screen to upload firmware to your EMG.
Backup/Restore	Backup/Restore	Use this screen to backup and restore your EMG's configuration (settings) or reset the factory default settings.
Reboot	Reboot	Use this screen to reboot the EMG without turning the power off.
Diagnostic	Ping&Traceroute &Nslookup	Use this screen to identify problems with the Ethernet WAN connection. You can use Ping, TraceRoute, or Nslookup to help you identify problems.
	802.1ag	Use this screen to configure CFM (Connectivity Fault Management) MD (maintenance domain) and MA (maintenance association), perform connectivity tests and view test reports.
	802.3ah	Use this screen to configure link OAM port parameters.

CHAPTER 3

Quick Start

3.1 Overview

Use the Quick Start screens to configure the EMG's time zone, basic Internet access, and wireless settings.

Note: See the technical reference chapters (starting on [Chapter 4 on page 37](#)) for background information on the features in this chapter.

3.2 Quick Start Setup

- 1 The Quick Start Wizard appears automatically after login. Or you can click the **Quick Start** icon in the top right corner of the web configurator to open the quick start screens. Select the time zone of your location. Click **Next**.

Figure 15 Quick Start - Welcome

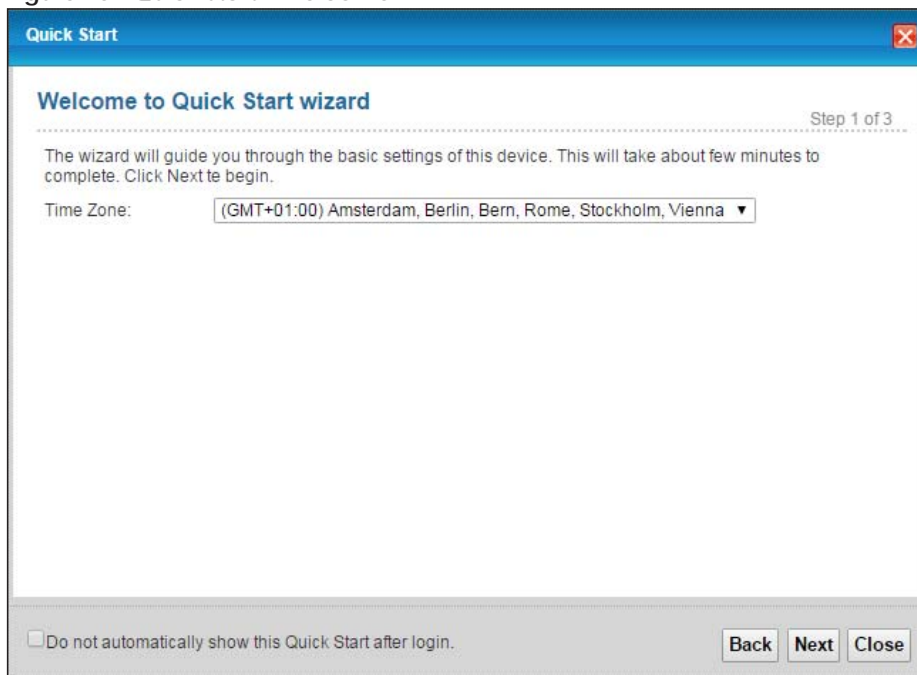

- 2 Enter your Internet connection information in this screen. The screen and fields to enter may vary depending on your current connection type. Click **Next**.

Figure 16 Quick Start - Internet Connection

Quick Start

Internet Connection

Step 2 of 3

Please select the interface:

The current connection type is set to **IPoE**.

Is there specific IP address information from your Internet Service Provider (ISP)?

Yes No

Then the IP Address information will be dynamically assigned to you from your ISP.

Do not automatically show this Quick Start after login.

Back Next Close

- 3 Turn the wireless LAN on or off. If you keep it on, record the security settings so you can configure your wireless clients to connect to the EMG. Click **Save**.

Figure 17 Quick Start - Wireless Setting

Quick Start

Wireless Setting

Step 3 of 3

The following settings are the current wireless settings which your wireless client devices need in order to get connected to this device.

Wireless Service: Enable Disable

Wireless Network Name (SSID): Zyxel06049

Security: WPA2-Personal

Password: *****

Do not automatically show this Quick Start after login.

Back Save Close

- 4 Your EMG saves your settings and attempts to connect to the Internet. Click **Close** to complete the setup.

Figure 18 Quick Start - Result Summary

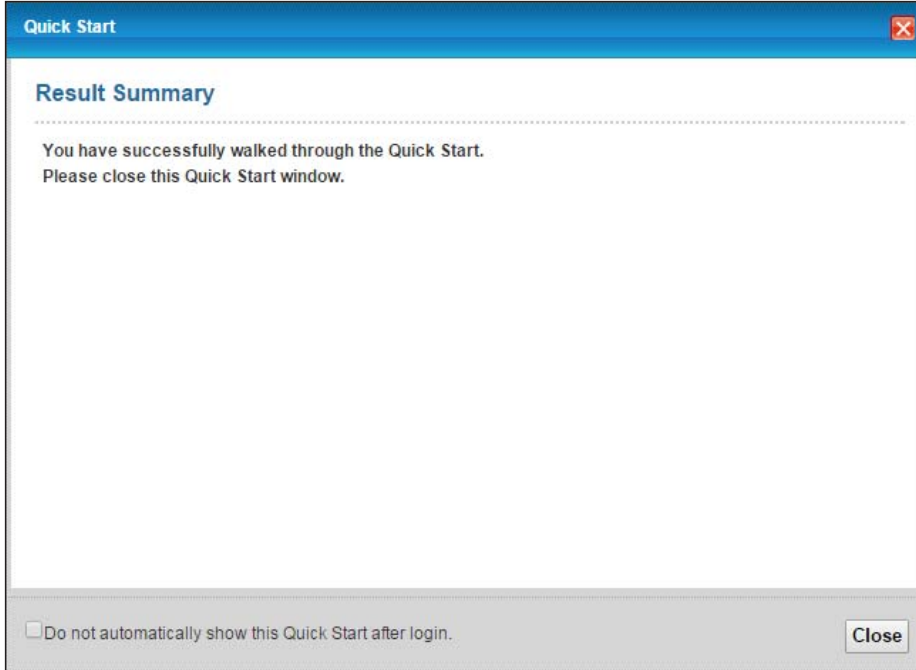

CHAPTER 4

Tutorials

4.1 Overview

This chapter shows you how to use the EMG's various features.

- [Setting Up a New WAN Connection](#), see page 37
- [Setting Up a Secure Wireless Network](#), see page 40
- [Setting Up Multiple Wireless Groups](#), see page 48
- [Configuring Static Route for Routing to Another Network](#), see page 51
- [Configuring QoS Queue and Class Setup](#), see page 53
- [Access the EMG Using DDNS](#), see page 56
- [Configuring the MAC Address Filter](#), see page 57

4.2 Setting Up a New WAN Connection

This tutorial shows you how to set up a new WAN Internet connection using the Web Configurator.

If you have another broadband modem or router available, you can connect the WAN port to the router and access the Internet via an Ethernet connection.

- 1 Click **Network Setting > Broadband** to open the following screen. Click **Add New WAN Interface**.



- 2 In this example, the Ethernet WAN connection has the following information.

General	
Active	Enable
Name	MyWANConnection
Type	Ethernet
Mode	Routing

Encapsulation	PPPoE
IPv6/IPv4 Mode	IPv4 Only
Account Information	
PPP User Name	1234@WAN-Ex.com
PPP Password	ABCDEF!
Static IP Address	192.168.1.32
Others	PPP Connection Trigger: Auto Connect PPPoE Passthrough: Disable NAT Enable: Enable IGMP Proxy Enable: Enable Apply as Default Gateway: Enable VLAN Active: Disable

- 3** Select the **Active** check box. Enter the **General** and **Account Information** settings as provided above.

Set the **Type** to **Ethernet**.

Choose the **Encapsulation** specified by your service provider. For this example, the service provider requires a username and password to establish Internet connection. Therefore, select **PPPoE** as the WAN encapsulation type.

Set the **IPv6/IPv4 Mode** to **IPv4 Only**.

- 4** Enter the account information provided to you by your service provider.
- 5** Configure this rule as your default Internet connection by selecting the **Apply as Default Gateway** check box. Then select DNS as **Static** and enter the DNS server addresses provided to you, such as **192.168.5.2** (DNS server1)/**192.168.5.1** (DNS server2).
- 6** Leave the rest of the fields to the default settings.
- 7** Click **Apply** to save your settings.

Add New WAN Interface

General

Active Enable Disable

Name

Type

Mode Routing Bridge

Encapsulation

IPv4/IPv6 Mode

PPP Information

PPP User Name

PPP Password

password unmask

PPP Connection Trigger Auto Connect On Demand

PPPoE Passthrough Enable Disable

IP Address

Obtain an IP Address Automatically

Static IP Address

IP Address

VLAN

Active : Enable Disable

802.1p :

802.1q : (1~4094)

MTU

MTU

Routing Feature

NAT Enable Enable Disable

Fullcone NAT Enable Enable Disable

IGMP Proxy Enable Enable Disable

Apply as Default Gateway Enable Disable

DNS Server

Obtain DNS Info Automatically

Use Following Static DNS Address

Primary DNS Server

Secondary DNS Server

WAN MAC Address

Factory Default

Clone LAN Host's MAC Address - IP Address

Set WAN MAC Address

6RD

6RD Enable Disable

OK Cancel

- 8 You should see a summary of your new WAN connection setup in the **Broadband** screen as follows.

Add New WAN Interface												
#	Name	Type	Mode	Encap...	802.1p	802.1q	IgmpP...	NAT	Defaul...	IPv6	MLD Proxy	Modify
1	ETHWAN	ETH	Routing	IPoE	N/A	N/A	Y	Y	Y	N	N	 
2	MyWANConnection	ETH	Routing	PPPoE	0	1	Y	Y	Y	N	N	 

Try to connect to a website to see if you have correctly set up your Internet connection.

4.3 Setting Up a Secure Wireless Network

Thomas wants to set up a wireless network so that he can use his notebook to access the Internet. In this wireless network, the EMG serves as an access point (AP), and the notebook is the wireless client. The wireless client can access the Internet through the AP.

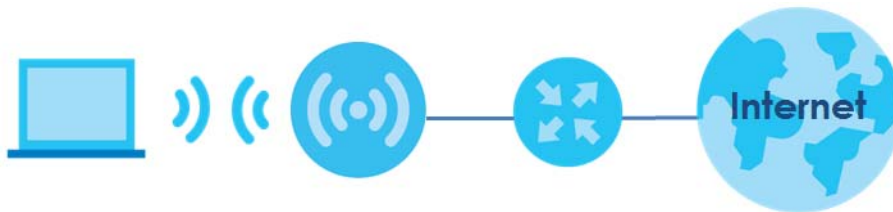

Thomas has to configure the wireless network settings on the EMG. Then he can set up a wireless network using WPS (Section 4.3.2 on page 42) or manual configuration (Section 4.3.3 on page 44).

4.3.1 Configuring the Wireless Network Settings

This example uses the following parameters to set up a 2.4G wireless network.

WiFi Network Name	Example
WiFi	Enable
WiFi Security Type	WPA2-PSK
WiFi Password	DoNotStealMyWirelessNetwork
802.11 Mode	802.11b/g/n Mixed

- 1 Click **Network Setting** > **Wireless** > **WiFi** and click the **Edit** button. Note that you may see one or two network name(s) displayed on this screen depending on whether you have selected **Keep 2.4G and 5G WiFi network name the same**.

WiFi Keep 2.4G and 5G WiFi network name the same

WiFi Network Name	Password	Action
Zyxel06049	YKGGFFGH7F	 Edit

OR

WiFi Keep 2.4G and 5G WiFi network name the same

WiFi Network Name	Password	Action
<div style="display: flex; align-items: center;"> <div style="margin-right: 5px;"> ▬▬▬ 2.4G </div> <div>Zyxel06049</div> </div> <div style="display: flex; align-items: center; margin-top: 2px;"> <div style="margin-right: 5px;"> ▬▬▬ 5G </div> <div>Zyxel06049_5G</div> </div>	YKGGFFGH7F	 Edit

- 2 The **WiFi Edit** screen displays. Select **WPA2-PSK** as the security type. Configure the screen using the provided parameters (see page 40). Click **Save**.

WiFi Edit

Wireless security can protect the data from unauthorized access or damage via wireless network. You need a wireless network name (also known as SSID) and security mode to set up the wireless security.

WiFi Network Settings

WiFi Enable Disable (Settings are invalid when disabled)

Keep 2.4G and 5G WiFi network name the same

WiFi Network Name

WiFi Password

Password Unmask

WiFi Security Type

- 3 Go to the **Wireless > Advanced** screen and select **802.11b/g/n Mixed** in the **802.11 Mode** field in the **2.4G Advanced Settings** section. Click **Apply**.

The screenshot displays two sections of network settings: 2.4G Advanced Settings and 5G Advanced Settings. In the 2.4G section, the '802.11 Mode' dropdown menu is highlighted with a red circle and set to '802.11b/g/n Mixed'. Other settings include 'Channel' (Auto), 'RTS/CTS Threshold' (2347), 'Fragmentation Threshold' (2346), 'Output Power' (100%), 'Beacon Interval' (100 ms), 'DTIM Interval' (1 ms), '802.11 Protection' (Off), 'Preamble' (Long), 'WPS' (checked), 'OBSS Coexistence' (Disable), 'WMM' (Enable), and 'WMM Automatic Power Save Delivery' (Enable). The 5G section has similar settings but with '802.11a/n/ac Mixed' selected for the mode. 'Apply' and 'Cancel' buttons are at the bottom right.

Thomas can now use the WPS feature to establish a wireless connection between his notebook and the EMG (see [Section 4.3.2 on page 42](#)). He can also use the notebook's wireless client to search for the EMG (see [Section 4.3.3 on page 44](#)).

4.3.2 Using WPS

This section shows you how to set up a wireless network using WPS. It uses the EMG as the AP and a WPS-enabled Android 4.4.2 smartphone as the wireless client.

to set up the wireless client settings:

- 1 Make sure that your EMG is turned on and your Android 4.42 smartphone is within the cover range of the wireless signal.
- 2 Make sure WPS is enabled on the EMG. You can check it by logging into the EMG's Web Configurator and see if it is enabled in the **Network Setting > Wireless > Advanced** screen. If not, select the **WPS** checkbox for the 2.4G or 5G wireless network and then click **Apply**.

Note: When the MESH function is enabled (see [Section 7.7 on page 87](#)), the EMG automatically enables WPS and grays the field out on this **Network Setting > Wireless > Advanced** screen.

The configurations below are the advanced wireless settings.

2.4G Advanced Settings

Hide WiFi Network Name :

Channel : Auto

Bandwidth : 40MHz

802.11 Mode : 802.11b/g/n Mixed

RTS/CTS Threshold : 2347

Fragmentation Threshold : 2346

Output Power : 100%

Beacon Interval : 100 ms

DTIM Interval : 1 ms

802.11 Protection : Off

Preamble : Long

WPS :

OBSS Coexistence : Enable Disable

WMM : Enable Disable

WMM Automatic Power Save Delivery : Enable Disable

5G Advanced Settings

Hide WiFi Network Name :

Channel : Auto

802.11 Mode : 802.11a/n/ac Mixed

RTS/CTS Threshold : 2347

Fragmentation Threshold : 2346

Output Power : 100%

Beacon Interval : 100 ms

DTIM Interval : 1 ms

802.11 Protection : Off

Preamble : Long

WPS :

OBSS Coexistence : Enable Disable

WMM : Enable Disable

- 3 You can either press the **WPS** button on the EMG's panel or click the **Connect** button for the corresponding 2.4G or 5G wireless band in the **Network Setting > Wireless > WPS** screen.

Connection Type	Wi-Fi Name	WPS
2.4G Wi-Fi	Zyxel06049	Connect
5G Wi-Fi	Zyxel06049	Connect

Activate WPS on wireless client within 2 minutes after clicking "Connect".

- 4 Go to your phone settings and turn on Wi-Fi. Open the Wi-Fi networks list and tap **WPS Push Button** or the WPS icon (🌀).

Note: It doesn't matter which button is pressed first. You must press the second button within two minutes of pressing the first one.

The EMG sends the proper configuration settings to the wireless client. This may take up to two minutes. The wireless client is then able to communicate with the EMG securely.

The following figure shows you an example of how to set up a wireless network and its security by pressing a button on both EMG and wireless client (the Android 4.4.2 phone in this example).

Wireless Client



EMG



Press and hold for more than 5 seconds



4.3.3 Connecting to the EMG's Wi-Fi Network Manually (No WPS)

In this example, we change the EMG's wireless settings, and then manually select the EMG's new SSID and enter the Wi-Fi key to connect a wireless client to the EMG.

4.3.4 Configuring Wireless Security on the EMG

This section shows you how to configure wireless security settings with the following parameters on your EMG.

Frequency Band	2.4 GHz
SSID	SSID_Example
Channel	Auto
Security	WPA2-PSK (Wireless Password: ThisismyWPA-PSKpre-sharedkey)

Follow the steps below to configure the wireless settings on your EMG.

The instructions require that your hardware is connected (see the Quick Start Guide) and you are logged into the Web Configurator through your LAN connection (see [Section 2.2 on page 29](#)).

- 1 Go to the **Network Setting > Wireless > WiFi > Edit** screen to enable the 2.4 GHz wireless network.

- Enter **SSID_Example** as the wireless name. Set WiFi security type to **WPA2-PSK** and enter **ThisismyWPA-PSKpre-sharedkey** in the **Pre-Shared Key** field. Click **Save**.

WiFi Network Settings

WiFi Enable Disable (Settings are invalid when disabled)

Keep 2.4G and 5G WiFi network name the same

WiFi Network Name

WiFi Password

Password Unmask

WiFi Security Type

Save **Cancel**

- Go to the **Network Setting > Wireless > Advanced** screen and select **Auto** in the **Channel** field to have the EMG scan for and select an available channel automatically.
- Open the **Status** screen. Verify your wireless and wireless security settings under **Device Information** and check if the WLAN connection is up under **Interface Status**.

Device Information

Host Name: EMG6726-B10A

Model Number: EMG6726-B10A

Serial Number: S180Y21006049

Firmware Version: V5.13(ABNP.1)b1

WAN1 Information

- Encapsulation: IPoE

- IP Address: 192.168.100.118 [Release](#)

- IP Subnet Mask: 255.255.255.0

- MAC Address: BC:99:11:1B:7A:A7

- Primary DNS server: 192.168.100.1

- Secondary DNS server: N/A

- DHCP: Client

LAN Information

- IP Address: 192.168.1.1

- IP Subnet Mask: 255.255.255.0

- IPv6 Link Local Address: fe80:ba99:11ff:fe1b:7aa2

- DHCP: Server

- MAC Address: BC:99:11:1B:7A:A2

WLAN 2.4GHz Information

- MAC Address: BC:99:11:1B:7A:A3

- Status: On

- SSID: SSID_Example

- Channel: Auto(Current 1)

- Security: WPA2-Personal

- 802.11 Mode: 802.11b/g/n Mixed

- WPS: On

WLAN 5GHz Information

- MAC Address: BC:99:11:1B:7A:A4

- Status: On

- SSID: SSID_Example

- Channel: Auto(Current 44)

- Security: WPA2-Personal

- 802.11 Mode: 802.11a/n/ac Mixed

- WPS: On

Security

- Firewall: Medium

System Status

System Up Time: 3days: 1hours: 57minutes

Current Date/Time: 2018-07-19/13:05:57

System Resource:

- CPU Usage: 5%

- Memory Usage: 36%

- NAT Session Usage: 1.1%

Interface Status

Interface	Status	Rate
LAN 1	No Link	N/A
LAN 2	No Link	N/A
LAN 3	No Link	N/A
LAN 4	No Link	N/A
WLAN 2.4GHz	Up	450 Mbps
WLAN 5GHz	Up	1733 Mbps
Ethernet WAN	Up	100M / Full

4.3.5 Configure Your Notebook

Note: In this example, we use a Windows 7 laptop that has a built-in wireless adapter as the wireless client.

- 1 The EMG supports IEEE 802.11a/g/n/b/ac wireless clients. Make sure that your notebook or computer's wireless adapter supports one of these standards.
- 2 Click the Wi-Fi icon in your computer's system tray

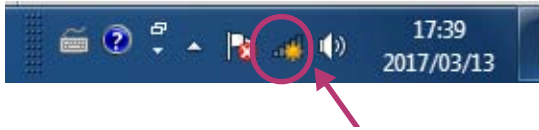

- 3 The **Wireless Network Connection** screen displays. Click the refresh button to update the list of available wireless APs within range.
- 4 Select **SSID_Example** and click **Connect**.



- 5 The following screen displays if WPS is enabled on the EMG but you didn't press the WPS button. Click **Connect using as security key instead**.



- 6 Type the security key in the following screen. Click **OK**.

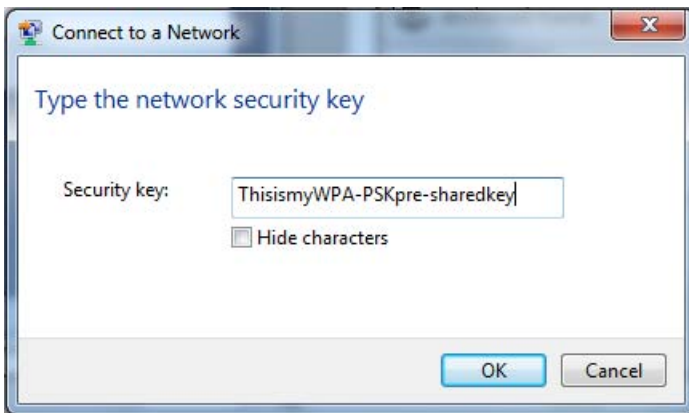

- 7 Check the status of your wireless connection in the screen below.



- 8 If the wireless client keeps trying to connect to or acquiring an IP address from the EMG, make sure you entered the correct security key.

If the connection has limited or no connectivity, make sure the EMG is connected to a router with the DHCP server enabled.

If your connection is successful, open your Internet browser and enter <http://www.zyxel.com> or the URL of any other web site in the address bar. If you are able to access the web site, your wireless connection is successfully configured.

4.4 Setting Up Multiple Wireless Groups

A family wants to create different wireless network groups for different types of users as shown in the following figure. Each group has its own wireless network name (SSID) and security type.

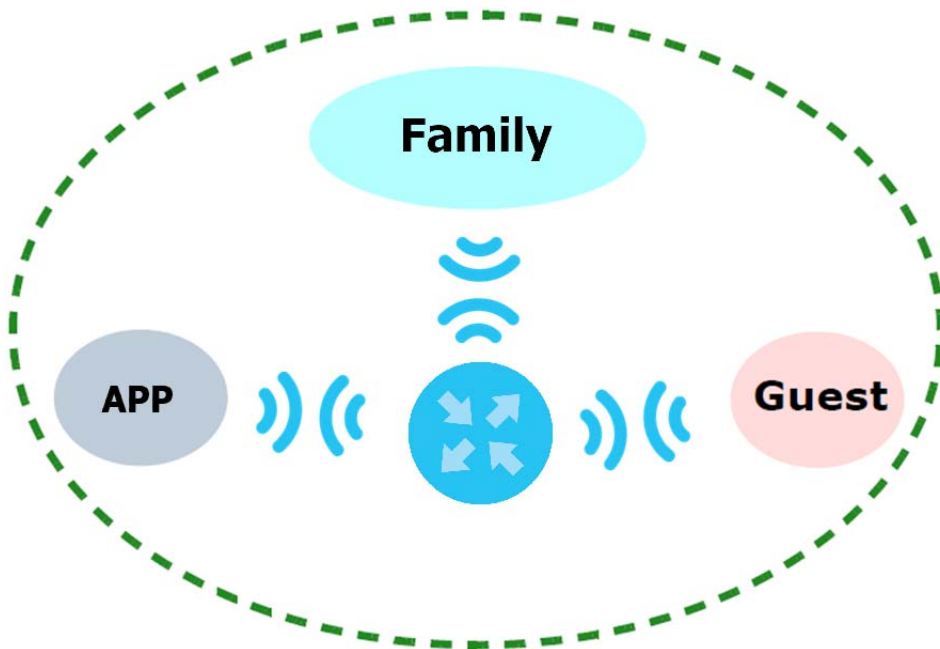

- The family members will use the general **Family** wireless network group.
- Visiting guests will use the **Guest** group with the restriction of the Internet access for the following 48 hours (in this example) after the setting is applied.
- The **APP** group will be dedicated to some home applications that require the Internet or an internal network, such as playing PS4 games.

The family will use the following parameters to set up the wireless network groups.

	FAMILY	GUEST	APP
SSID	Family	Guest	APP
Security Type	WPA2-PSK		
Wireless Password	ForFamilyOnly	guest123	123456789
Available Time	N/A	48 hours	N/A

- 1 Click **Network Setting > Wireless > WiFi > Edit** to open the **WiFi Edit** screen. Use this screen to set up the family's general wireless network group. Configure the screen using the provided parameters and click **Save**.

WiFi Network Settings

WiFi Enable Disable (Settings are invalid when disabled)

Keep 2.4G and 5G WiFi network name the same

WiFi Network Name
Family

WiFi Password
ForFamilyOnly

Password Unmask

WiFi Security Type
WPA2-PSK



- 2 Click **Network Setting > Wireless > Guest WiFi** to open the following screen. Click the **Edit** icon in the **Guest WiFi** section to configure the second wireless network group.

Guest WiFi

Enable Guest WiFi

WiFi Network Name	Password	Action
Zyxel06049_guest	YKGGFFGH	 Edit

Extra WiFi

Band	WiFi Network Name	Password	Action
2.4G	Zyxel6049_extra2	YKGGFFGH7F	 Edit
2.4G	Zyxel6049_extra3	YKGGFFGH7F	 Edit
5G	Zyxel6049_extra2_5G	YKGGFFGH7F	 Edit

- 3 Configure the screen using the provided parameters and click **Save**.

Guest WiFi Network Settings

Guest WiFi Enable Disable (Settings are invalid when disabled)

WiFi Network Name

WiFi Password

Password Unmask

Time Period Duration (hours) 1 4 8 12 24 48 Always on

- 4 In the **Guest WiFi** screen, click an **Edit** icon next to a 2.4G “extra WiFi” network to configure the third wireless network group. Configure the screen using the provided parameters and click **Save**.

Guest WiFi Network Settings

Guest WiFi Enable Disable (Settings are invalid when disabled)

WiFi Network Name

WiFi Password

Password Unmask

- 5 Check the status of **Guest** and **APP** in the **Guest WiFi** screen. The screen also displays the remaining available time for using the **Guest WiFi** network at the upper right corner.

Guest WiFi 47 hours 54 minutes left

Enable Guest WiFi

WiFi Network Name	Password	Action
Guest	guest123	

Extra WiFi

Band	WiFi Network Name	Password	Action
2.4G	APP	123456789	
2.4G	Zyxel6049_extra3	YKGGFFGH7F	
5G	Zyxel6049_extra2_5G	YKGGFFGH7F	

4.5 Configuring Static Route for Routing to Another Network

In order to extend your Intranet and control traffic flowing directions, you may connect a router to the EMG's LAN. The router may be used to separate two department networks. This tutorial shows how to configure a static routing rule for two network routings.

In the following figure, router **R** is connected to the EMG's LAN. **R** connects to two networks, **N1** (192.168.1.x/24) and **N2** (192.168.10.x/24). If you want to send traffic from computer **A** (in **N1** network) to computer **B** (in **N2** network), the traffic is sent to the EMG's WAN default gateway by default. In this case, **B** will never receive the traffic.

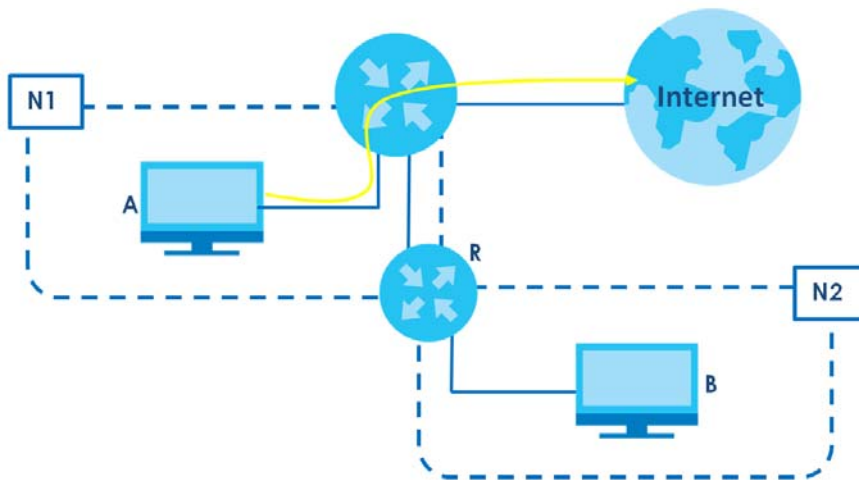

You need to specify a static routing rule on the EMG to specify **R** as the router in charge of forwarding traffic to **N2**. In this case, the EMG routes traffic from **A** to **R** and then **R** routes the traffic to **B**.

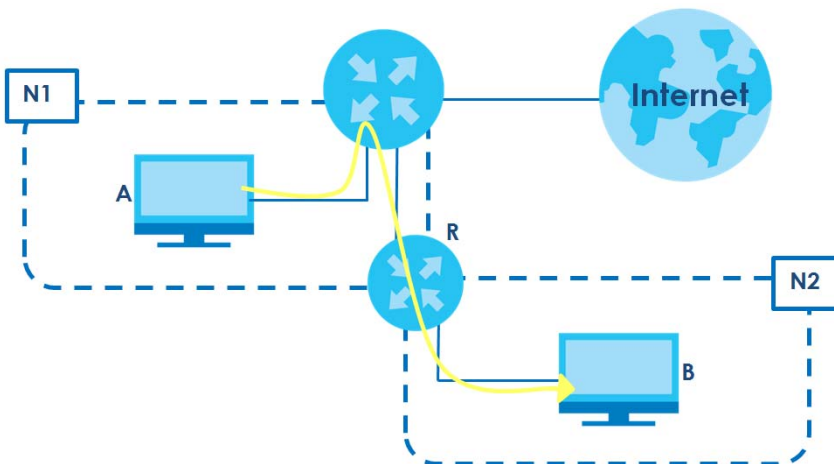

This tutorial uses the following example IP settings:

Table 8 IP Settings in this Tutorial

DEVICE / COMPUTER	IP ADDRESS
The EMG's WAN	172.16.1.1
The EMG's LAN	192.168.1.1
IP Type	IPv4
Use Interface	ETHWAN
A	192.168.1.34
R's N1	192.168.1.253
R's N2	192.168.10.2
B	192.168.10.33

To configure a static route to route traffic from **N1** to **N2**:

- 1 Log into the EMG's Web Configurator in advanced mode.
- 2 Click **Network Setting > Routing**.
- 3 Click **Add New Static Route** in the **Static Route** screen.

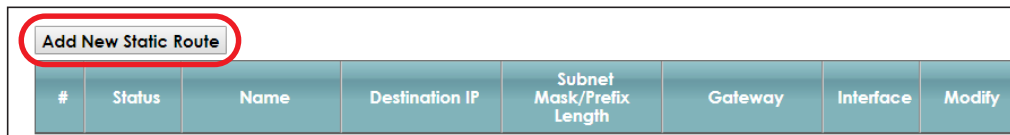

- 4 Configure the **Static Route Setup** screen using the following settings:
 - 4a Select the **Active** check box. Enter the **Route Name** as **R**.
 - 4b Set **IP Type** to **IPv4**.
 - 4c Type **192.168.10.0** and subnet mask **255.255.255.0** for the destination, **N2**.
 - 4d Select **Enable** in the **Use Gateway IP Address** field. Type **192.168.1.253** (**R's N1** address) in the **Gateway IP Address** field.
 - 4e Select **ETHWAN** as the **Use Interface**.

The screenshot shows the 'Add New Static Route' configuration window with the following settings:

- Active: Enable Disable
- Route Name: R
- IP Type: IPv4
- Destination IP Address: 192.168.10.0
- IP Subnet Mask: 255.255.255.0
- Use Gateway IP Address: Enable Disable
- Gateway IP Address: 192.168.1.253
- Use Interface: ETHWAN

Note
The input range of the Gateway IP Address must be in the same range of the Use

4a Click **OK**.

Now **B** should be able to receive traffic from **A**. You may need to additionally configure **B**'s firewall settings to allow specific traffic to pass through.

4.6 Configuring QoS Queue and Class Setup

This section contains tutorials on how you can configure the QoS screen.

Let's say you are a team leader of a small sales branch office. You want to prioritize e-mail traffic because your task includes sending urgent updates to clients at least twice every hour. You also upload data files (such as logs and e-mail archives) to the FTP server throughout the day. Your colleagues use the Internet for research, as well as chat applications for communicating with other branch offices.

In the following figure, your Internet connection has an upstream transmission bandwidth of 10,000 kbps. For this example, you want to configure QoS so that e-mail traffic gets the highest priority with at least 5,000 kbps. You can do the following:

- Configure a queue to assign the highest priority queue (1) to e-mail traffic going to the WAN interface, so that e-mail traffic would not get delayed when there is network congestion.
- Note the IP address (192.168.1.23 for example) and/or MAC address (AA:FF:AA:FF:AA:FF for example) of your computer and map it to queue 7.

Note: QoS is applied to traffic flowing out of the EMG.

Traffic that does not match this class is assigned a priority queue based on the internal QoS mapping table on the EMG.

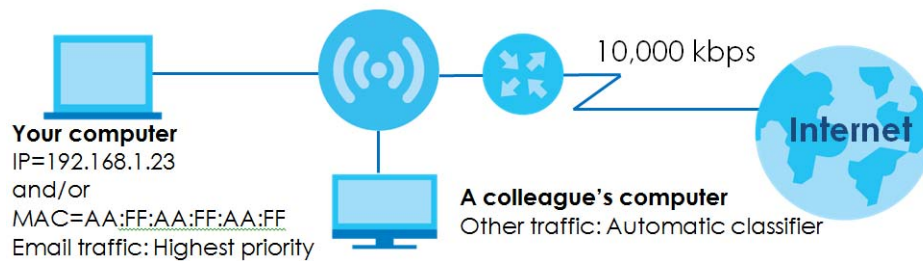

- 1 Click **Network Setting > QoS > General** and select **Enable**. Set your **WAN Managed Upstream Bandwidth** to 10,000 kbps (or leave this blank to have the EMG automatically determine this figure). Click **Apply**.

Quality of Service (QoS) defines the traffic priority of Internet services to the home network.

QoS Enable Disable (Settings are invalid when disabled)

WAN Managed Upstream Bandwidth : (kbps)

LAN Managed Downstream Bandwidth (kbps)

:

Upstream Traffic Priority Assigned by:

Note

1. You can assign the upstream bandwidth manually. If the field is empty, the CPE set the value automatically.
2. If Upstream Traffic Priority is selected, 8 level strict priority QoS will be applied automatically according to the selected criteria. In this mode, user manually defined QoS will not be applied until Auto-Priority Mapping is disabled.
3. If the setting of WAN managed upstream bandwidth is greater than current WAN interface linkup rate, then the WAN managed upstream bandwidth will become current WAN interface linkup rate.

- 2 Click **Queue Setup > Add new Queue** to create a new queue. In the screen that opens, check **Active** and enter or select the following values:

- **Name:** E-mail
- **Interface:** WAN
- **Priority:** 1 (High)
- **Weight:** 8
- **Rate Limit:** 5,000 (kbps)

Add New Queue

Active Enable Disable

Name

Interface

Priority

Weight

Buffer Management

Rate Limit (kbps) (kbps)

- 3 Click **Classification Setup > Add new Classification** to create a new class. Check **Active** and follow the settings as shown in the screen below.

Please follow the guidance through step 1-5 to configure a QoS rule

Step1: Class Configuration

Active Enable Disable

Class Name:

Classification Order:

Step2: Criteria Configuration

Use the configurations below to specify the characteristics of a data flow needed to be managed by this QoS rule

Basic

From Interface:

Ether Type:

Source

Address: Subnet Mask: Exclude

Port Range: Exclude

MAC: MAC Mask: Exclude

Destination

Address: Subnet Mask: Exclude

Port Range: Exclude

MAC: MAC Mask: Exclude

Others

Service: Exclude

IP protocol: Exclude

DHCP: Exclude

Packet Length: Exclude

DSCP: Exclude

802.1P: Exclude

VLAN ID: Exclude

TCP ACK: Exclude

Step3: Packet Modification

The content of the packet can be modified by applying the following settings

DSCP Mark: Exclude

802.1P Mark: Exclude

VLAN ID Tag: Exclude

Step4: Class Routing

This module can route a packet to a certain interface according to the class setting

Forward To Interface:

Step5: Outgoing Queue Selection

Outgoing queue decides the priority of the traffic and how traffic should be shaped in the WAN interface.

To Queue Index:

OK Cancel

FIELD TO CONFIGURE	HOW TO CONFIGURE
Class Name	Give a class name to this traffic, such as E-mail in this example.
From Interface	This is the interface from which the traffic will be coming from. Select LAN1 for this example.
Ether Type	Select IP to identify the traffic source by its IP address or MAC address.
IP Address	Type the IP address of your computer - 192.168.1.23 . Type the IP Subnet Mask if you know it.
MAC Address	Type the MAC address of your computer - AA:FF:AA:FF:AA:FF . Type the MAC Mask if you know it.
To Queue Index	Link this to an item in the Network Setting > QoS > Queue Setup screen, which is the E-mail queue created in this example.

This maps e-mail traffic coming from port 25 to the highest priority, which you have created in the previous screen (see the **IP Protocol** field). This also maps your computer's IP address and MAC address to the **E-mail** queue (see the **Source** fields).

4.7 Access the EMG Using DDNS

If you connect your EMG to the Internet and it uses a dynamic WAN IP address, it is inconvenient for you to manage the device from the Internet. The EMG's WAN IP address changes dynamically. Dynamic DNS (DDNS) allows you to access the EMG using a domain name.

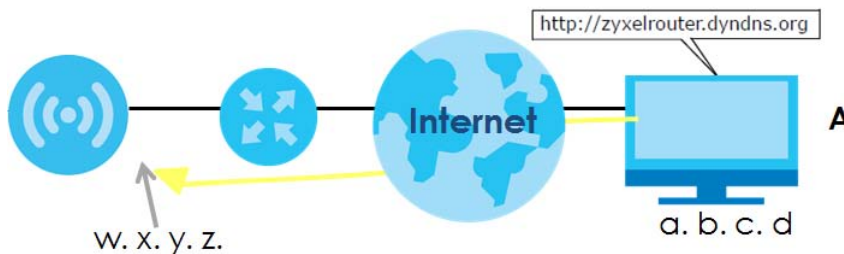

To use this feature, you have to apply for DDNS service at www.dyndns.org.

This tutorial covers:

- [Registering a DDNS Account on \[www.dyndns.org\]\(http://www.dyndns.org\)](#)
- [Configuring DDNS on Your EMG](#)
- [Testing the DDNS Setting](#)

Note: If you have a private WAN IP address, then you cannot use DDNS.

4.7.1 Registering a DDNS Account on www.dyndns.org

- 1 Open a browser and type **http://www.dyndns.org**.
- 2 Apply for a user account. This tutorial uses **UserName1** and **12345** as the username and password.
- 3 Log into www.dyndns.org using your account.
- 4 Add a new DDNS host name. This tutorial uses the following settings as an example.
 - Hostname: **zyxelrouter.dyndns.org**
 - Service Type: **Host with IP address**
 - IP Address: Enter the WAN IP address that your EMG is currently using. You can find the IP address on the EMG's Web Configurator **Status** page.

Then you will need to configure the same account and host name on the EMG later.

4.7.2 Configuring DDNS on Your EMG

Configure the following settings in the **Network Setting > DNS > Dynamic DNS** screen.

- Select **Enable Dynamic DNS**.
- Select **www.DynDNS.com** as the service provider.
- Type **zyxelrouter.dyndns.org** in the **Host Name** field.
- Enter the user name (**UserName1**) and password (**12345**).

Dynamic DNS Setup

Dynamic DNS Enable Disable (Settings are invalid when disabled)

Service Provider :

Host/Domain Name :

Username :

Password :

Dynamic DNS Status

User Authentication Result :

Last Updated Time :

Current Dynamic IP :

Click **Apply**.

4.7.3 Testing the DDNS Setting

Now you should be able to access the EMG from the Internet. To test this:

- 1 Open a web browser on the computer (using the IP address **a.b.c.d**) that is connected to the Internet.
- 2 Type **http://zyxelrouter.dyndns.org** and press [Enter].
- 3 The EMG's login page should appear. You can then log into the EMG and manage it.

4.8 Configuring the MAC Address Filter

Thomas noticed that his daughter Josephine spends too much time surfing the web and downloading media files. He decided to prevent Josephine from accessing the Internet so that she can concentrate on preparing for her final exams.

Josephine's computer connects wirelessly to the Internet through the EMG. Thomas decides to use the **Security > MAC Filter** screen to grant wireless network access to his computer but not to Josephine's computer.

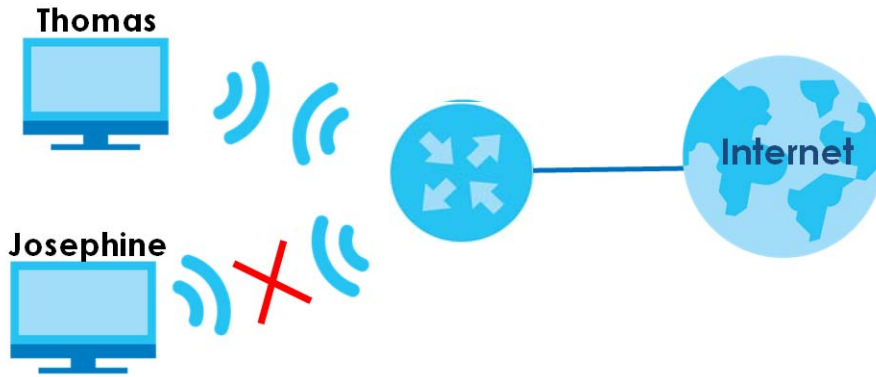

- 1 Click **Security > MAC Filter** to open the **MAC Filter** screen. Select the **Enable** check box to activate MAC filter function.
- 2 Select **Allow**. Then enter the host name and MAC address of Thomas' computer in this screen. Click **Apply**.

Enable MAC filters and add the MAC addresses of LAN client in your home or office network to the following table, if you wish to allow or deny them to access your network. Sometimes, MAC Filter is considered a method to increase the security of your network.

MAC Address Filter Enable Disable (Settings are invalid when disabled)

MAC Restrict Mode Allow Deny

Set	Active	Host Name	MAC Address
1	<input checked="" type="checkbox"/>	Thomas	00 - 24 - 21 - AB - 1F - 0D
2	<input type="checkbox"/>		- - - - -
3	<input type="checkbox"/>		- - - - -
4	<input type="checkbox"/>		- - - - -
5	<input type="checkbox"/>		- - - - -
6	<input type="checkbox"/>		- - - - -
7	<input type="checkbox"/>		- - - - -
29	<input type="checkbox"/>		- - - - -
30	<input type="checkbox"/>		- - - - -
31	<input type="checkbox"/>		- - - - -
32	<input type="checkbox"/>		- - - - -

Note:
Only devices listed here are granted access to the network.

Apply **Cancel**

Thomas can also grant access to the computers of other members of his family and friends. However, Josephine and others not listed in this screen will no longer be able to access the Internet through the EMG.

PART II

Technical Reference

CHAPTER 5

Network Map and Status Screens

5.1 Overview

After you log into the Web Configurator, the **Status** screen appears. You can use the **Status** screen to look at the current status of the EMG, system resources, and interfaces (LAN, WAN, and WLAN).

5.2 The Status Screen

Use this screen to view the status of the EMG. Click **Connection Status** to open this screen.

Figure 19 Status Screen

The screenshot shows the ZYXEL EMG6726-B10A Status screen. The interface is divided into several sections:

- Device Information:** Host Name: EMG6726-B10A, Model Number: EMG6726-B10A, Serial Number: S180Y21006049, Firmware Version: V5.13[ABNP.1]b1.
- WAN1 Information:** Encapsulation: IPoE, IP Address: 192.168.100.118 (with a Release button), Subnet Mask: 255.255.255.0, MAC Address: BC:99:11:1B:7A:A7, Primary DNS server: 192.168.100.1, Secondary DNS server: N/A, DHCP: Client.
- LAN Information:** IP Address: 192.168.1.1, Subnet Mask: 255.255.255.0, IPv6 Link Local Address: fe80::be99:11ff:fe1b:7aa2, DHCP: Server, MAC Address: BC:99:11:1B:7A:A2.
- WLAN 2.4GHz Information:** MAC Address: BC:99:11:1B:7A:A3, Status: On, SSID: Zyxel06049, Channel: Auto (Current 6), Security: WPA2-Personal, 802.11 Mode: 802.11b/g/n Mixed, WPS: On.
- WLAN 5GHz Information:** MAC Address: BC:99:11:1B:7A:A4, Status: On, SSID: Zyxel06049, Channel: Auto (Current 44), Security: WPA2-Personal, 802.11 Mode: 802.11a/n/ac Mixed, WPS: On.
- Security:** Firewall: Medium.
- System Status:** System Up Time: 0days: 2hours: 36minutes, Current Date/Time: 2018-07-13/19:03:20. System Resource: CPU Usage: 9%, Memory Usage: 35%, NAT Session Usage: 0.33%.
- Interface Status:** A table showing the status and rate of various interfaces.

Interface	Status	Rate
LAN 1	No Link	N/A
LAN 2	No Link	N/A
LAN 3	No Link	N/A
LAN 4	No Link	N/A
WLAN 2.4GHz	Up	450 Mbps
WLAN 5GHz	Up	1733 Mbps
Ethernet WAN	Up	100M / Full

The bottom navigation bar includes icons for Connection Status (selected), Network Setting, Security, System Monitor, and Maintenance. A Network Map icon is also visible on the right side.

Each field is described in the following table.

Table 9 Status Screen

LABEL	DESCRIPTION
Refresh Interval	Select how often you want the EMG to update this screen.
Device Information	
Host Name	This field displays the EMG system name. It is used for identification.
Model Number	This shows the model number of your EMG.
Serial Number	This field displays the serial number of the EMG.
Firmware Version	This is the current version of the firmware inside the EMG.
WAN Information (These fields display when you have a WAN connection.)	
Encapsulation	This field displays the current encapsulation method.
IP Address	This field displays the current IP address of the EMG in the WAN. Click Release to release the current IP address settings. Click Renew to obtain an IP address from the ISP.
IP Subnet Mask	This field displays the current subnet mask in the WAN.
MAC Address	This shows the WAN Ethernet adapter MAC (Media Access Control) Address of your EMG.
Primary DNS server	This field displays the first DNS server address assigned by the ISP.
Secondary DNS server	This field displays the second DNS server address assigned by the ISP.
DHCP	This field displays whether the WAN interface is using a DHCP IP address or a static IP address. Choices are: Client - The WAN interface can obtain an IP address from a DHCP server. None - The WAN interface is using a static IP address.
LAN Information	
IP Address	This is the current IP address of the EMG in the LAN.
IP Subnet Mask	This is the current subnet mask in the LAN.
IPv6 Link Local Address	This field displays the current link-local address of the EMG for the LAN interface.
DHCP	This field displays what DHCP services the EMG is providing to the LAN. The possible values are: Server - The EMG is a DHCP server in the LAN. It assigns IP addresses to other computers in the LAN. Relay - The EMG acts as a surrogate DHCP server and relays DHCP requests and responses between the remote server and the clients. Disable - The EMG is not providing any DHCP services to the LAN.
MAC Address	This shows the LAN Ethernet adapter MAC (Media Access Control) Address of your EMG.
WLAN 2.4GHz/5GHz Information	
MAC Address	This shows the wireless adapter MAC (Media Access Control) Address of the wireless interface.
Status	This displays whether the WLAN is activated.
SSID	This is the descriptive name used to identify the EMG in a wireless LAN.
Channel	This is the channel number used by the wireless interface now.
Security	This displays the type of security mode the wireless interface is using in the wireless LAN.
802.11 Mode	This displays the type of 802.11 mode the wireless interface is using in the wireless LAN.
WPS	This displays whether WPS is activated on the wireless interface.

Table 9 Status Screen (continued)

LABEL	DESCRIPTION
Security	
Firewall	This displays the firewall's current security level.
System Status	
System Up Time	This field displays how long the EMG has been running since it last started up. The EMG starts up when you plug it in, when you restart it (Maintenance > Reboot), or when you reset it.
Current Date/Time	This field displays the current date and time in the EMG. You can change this in Maintenance > Time Setting .
System Resource	
CPU Usage	This field displays what percentage of the EMG's processing ability is currently used. When this percentage is close to 100%, the EMG is running at full load, and the throughput is not going to improve anymore. If you want some applications to have more throughput, you should turn off other applications (for example, using QoS; see Chapter 10 on page 134).
Memory Usage	This field displays what percentage of the EMG's memory is currently used. Usually, this percentage should not increase much. If memory usage does get close to 100%, the EMG is probably becoming unstable, and you should restart the device. See Section 36.2 on page 266 , or turn off the device (unplug the power) for a few seconds.
NAT Session Usage	This field displays what percentage of the EMG supported NAT sessions are currently being used. This field also displays the number of active NAT sessions and the maximum number of NAT sessions the EMG can support.
Interface Status	
Interface	This column displays each interface the EMG has.
Status	This field indicates the interface's use status. For the LAN and Ethernet WAN interfaces, this field displays Up when using the interface and NoLink when not using the interface. For a WLAN interface, this field displays the enabled (Up) or disabled (Disable) state of the interface.
Rate	For the Ethernet WAN and LAN interfaces, this displays the port speed and duplex setting. For the WLAN interface, it displays the maximum transmission rate or N/A with WLAN disabled.

5.3 The Network Map Screen

Use this screen to view the network connection status of the device and its clients in a list. You can configure how often you want the EMG to update this screen in **Refresh interval**.

Figure 20 Network Map: List View Mode

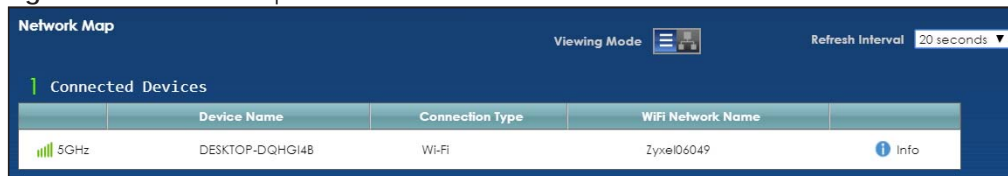

If you want to view information about a client, click **Info** of the entry and the following screen displays.



If you prefer to view the layout of the device and its client icons, click **Icon View** in the **Viewing Mode** selection box. A warning message appears if there is a connection problem.

Figure 21 Network Map: Icon View Mode

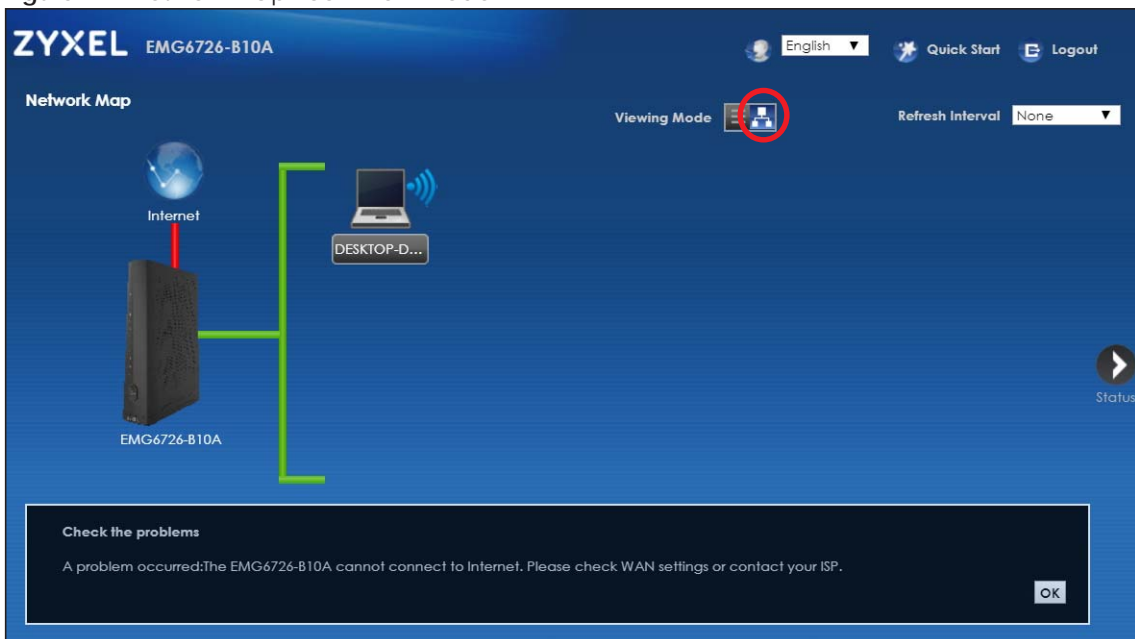

If you want to view information about a client in this icon mode, click the client's name and **Info**. If you want to change the name or icon of the client, click **Change icon/name**.



CHAPTER 6

Broadband

6.1 Overview

This chapter discusses the EMG's **Broadband** screens. Use these screens to configure your EMG for Internet access.

A WAN (Wide Area Network) connection is an outside connection to another network or the Internet. It connects your private networks, such as a LAN (Local Area Network) and other networks, so that a computer in one location can communicate with computers in other locations.

Figure 22 LAN and WAN

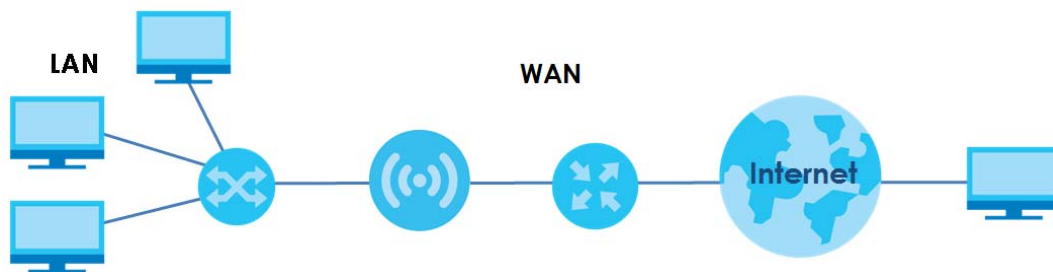

6.1.1 What You Can Do in this Chapter

- Use the **Broadband** screen to view, remove or add a WAN interface. You can also configure the WAN settings on the EMG for Internet access (Section 6.2 on page 67).

Table 10 WAN Setup Overview

LAYER-2 INTERFACE	INTERNET CONNECTION		
	CONNECTION	MODE	ENCAPSULATION
Ethernet	Routing	PPPoE	PPP user name and password, WAN IPv4/IPv6 IP address, routing feature, DNS server, VLAN, and MTU
		IPoE	WAN IPv4/IPv6 IP address, NAT, DNS server and routing feature
	Bridge	N/A	VLAN

6.1.2 What You Need to Know

The following terms and concepts may help as you read this chapter.

WAN IP Address

The WAN IP address is an IP address for the EMG, which makes it accessible from an outside network. It is used by the EMG to communicate with other devices in other networks. It can be static (fixed) or dynamically assigned by the ISP each time the EMG tries to access the Internet.

If your ISP assigns you a static WAN IP address, they should also assign you the subnet mask and DNS server IP address(es).

IPv6 Introduction

IPv6 (Internet Protocol version 6), is designed to enhance IP address size and features. The increase in IPv6 address size to 128 bits (from the 32-bit IPv4 address) allows up to 3.4×10^{38} IP addresses. The EMG can use IPv4/IPv6 dual stack to connect to IPv4 and IPv6 networks, and supports IPv6 rapid deployment (6RD).

IPv6 Addressing

The 128-bit IPv6 address is written as eight 16-bit hexadecimal blocks separated by colons (:). This is an example IPv6 address `2001:0db8:1a2b:0015:0000:0000:1a2f:0000`.

IPv6 addresses can be abbreviated in two ways:

- Leading zeros in a block can be omitted. So `2001:0db8:1a2b:0015:0000:0000:1a2f:0000` can be written as `2001:db8:1a2b:15:0:0:1a2f:0`.
- Any number of consecutive blocks of zeros can be replaced by a double colon. A double colon can only appear once in an IPv6 address. So `2001:0db8:0000:0000:1a2f:0000:0000:0015` can be written as `2001:0db8::1a2f:0000:0000:0015`, `2001:0db8:0000:0000:1a2f::0015`, `2001:db8::1a2f:0:0:0:15` or `2001:db8:0:0:1a2f::15`.

IPv6 Prefix and Prefix Length

Similar to an IPv4 subnet mask, IPv6 uses an address prefix to represent the network address. An IPv6 prefix length specifies how many most significant bits (start from the left) in the address compose the network address. The prefix length is written as "/x" where x is a number. For example,

```
2001:db8:1a2b:15::1a2f:0/32
```

means that the first 32 bits (`2001:db8`) is the subnet prefix.

IPv6 Subnet Masking

Both an IPv6 address and IPv6 subnet mask compose of 128-bit binary digits, which are divided into eight 16-bit blocks and written in hexadecimal notation. Hexadecimal uses four bits for each character (1 ~ 10, A ~ F). Each block's 16 bits are then represented by four hexadecimal characters. For example, `FFFF:FFFF:FFFF:FFFF:FC00:0000:0000:0000`.

IPv6 Rapid Deployment

Use IPv6 Rapid Deployment (6rd) when the local network uses IPv6 and the ISP has an IPv4 network. When the EMG has an IPv4 WAN address and you set **IPv4/IPv6 Mode** to **IPv4 Only**, you can enable 6rd to encapsulate IPv6 packets in IPv4 packets to cross the ISP's IPv4 network.

The EMG generates a global IPv6 prefix from its IPv4 WAN address and tunnels IPv6 traffic to the ISP's Border Relay router (BR in the figure) to connect to the native IPv6 Internet. The local network can also use IPv4 services. The EMG uses its configured IPv4 WAN IP to route IPv4 traffic to the IPv4 Internet.

Figure 23 IPv6 Rapid Deployment

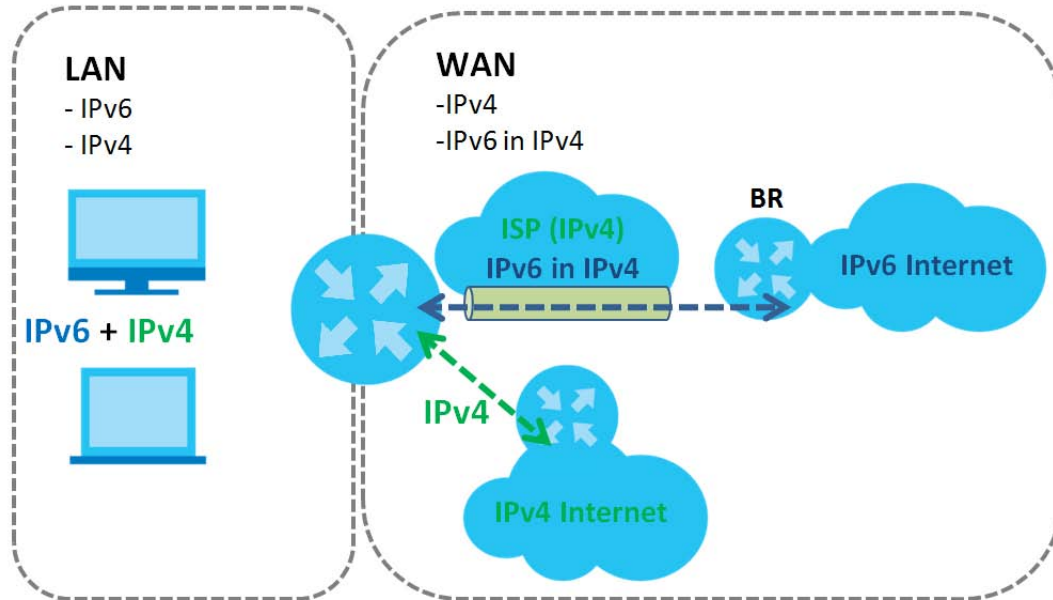

Dual Stack Lite

Use Dual Stack Lite when local network computers use IPv4 and the ISP has an IPv6 network. When the EMG has an IPv6 WAN address and you set **IPv4/IPv6 Mode** to **IPv6 Only**, you can enable Dual Stack Lite to use IPv4 computers and services.

The EMG tunnels IPv4 packets inside IPv6 encapsulation packets to the ISP's Address Family Transition Router (AFTR in the graphic) to connect to the IPv4 Internet. The local network can also use IPv6 services. The EMG uses its configured IPv6 WAN IP to route IPv6 traffic to the IPv6 Internet.

Figure 24 Dual Stack Lite

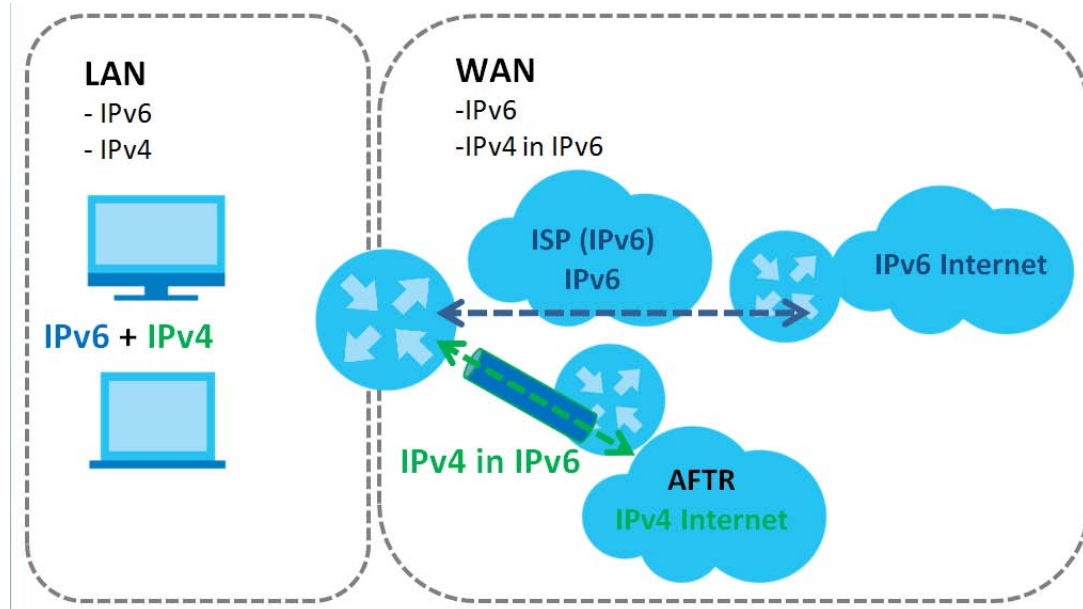

6.1.3 Before You Begin

You need to know your Internet access settings such as encapsulation and WAN IP address. Get this information from your ISP.

6.2 The Broadband Screen

Use this screen to change your EMG's Internet access settings. Click **Network Setting > Broadband** from the menu. The summary table shows you the configured WAN services (connections) on the EMG.

Figure 25 Network Setting > Broadband

Add New WAN Interface												
#	Name	Type	Mode	Encaps...	802.1p	802.1q	IgmpPr...	NAI	Defaull ...	IPv6	MLD proxy	Modify
1	ETHWAN	ETH	Routing	IPoE	N/A	N/A	Y	Y	Y	N	N	 

The following table describes the labels in this screen.

Table 11 Network Setting > Broadband

LABEL	DESCRIPTION
Add New WAN Interface	Click this button to create a new connection.
#	This is the index number of the entry.
Name	This is the service name of the connection.
Type	This shows it is an Ethernet connection.
Mode	This shows whether the connection is in routing or bridge mode.
Encapsulation	This is the method of encapsulation used by this connection.
802.1p	This indicates the 802.1p priority level assigned to traffic sent through this connection. This displays N/A when there is no priority level assigned.

Table 11 Network Setting > Broadband (continued)

LABEL	DESCRIPTION
802.1q	This indicates the VLAN ID number assigned to traffic sent through this connection. This displays N/A when there is no VLAN ID number assigned.
Icmp Proxy	This shows whether the EMG act as an IGMP proxy on this connection.
NAT	This shows whether NAT is activated or not for this connection.
Default Gateway	This shows whether the EMG use the WAN interface of this connection as the system default gateway.
IPv6	This shows whether IPv6 is activated or not for this connection. IPv6 is not available when the connection uses the bridging service.
MLD Proxy	This shows whether Multicast Listener Discovery (MLD) is activated or not for this connection. MLD is not available when the connection uses the bridging service.
Modify	Click the Edit icon to configure the WAN connection. Click the Delete icon to remove the WAN connection.

6.2.1 Add/Edit Internet Connection

Click **Add New WAN Interface** in the **Broadband** screen or the **Edit** icon next to an existing WAN interface to configure a WAN connection. The screen varies depending on the interface type, mode, encapsulation, and IPv6/IPv4 mode you select.

6.2.1.1 Routing Mode

Use **Routing** mode if your ISP give you one IP address only and you want multiple computers to share an Internet account.

The following example screen displays when you select the **Ethernet** connection type, **Routing** mode, and **PPPoE** encapsulation. The screen varies when you select other encapsulation and IPv4/IPv6 mode.

Figure 26 Network Setting > Broadband > Add New WAN Interface/Edit (Routing Mode)

The following table describes the labels in this screen.

Table 12 Network Setting > Broadband > Add New WAN Interface/Edit (Routing Mode)

LABEL	DESCRIPTION
General	
Active	Select Enable to activate this WAN interface.
Name	Specify a descriptive name for this connection.
Type	Select an Ethernet connection.
Mode	Select Routing if your ISP give you one IP address only and you want multiple computers to share an Internet account.
Encapsulation	Select the method of encapsulation used by your ISP from the drop-down list box. This option is available only when you select Routing in the Mode field. The choices are PPPoE and IPoE .

Table 12 Network Setting > Broadband > Add New WAN Interface/Edit (Routing Mode) (continued)

LABEL	DESCRIPTION
IPv4/IPv6 Mode	Select IPv4 Only if you want the EMG to run IPv4 only. Select IPv4 IPv6 DualStack to allow the EMG to run IPv4 and IPv6 at the same time. Select IPv6 Only if you want the EMG to run IPv6 only.
PPP Information (This is available only when you select PPPoE in the Mode field.)	
PPP User Name	Enter the user name exactly as your ISP assigned. If assigned a name in the form user@domain where domain identifies a service name, then enter both components exactly as given.
PPP Password	Enter the password associated with the user name above. Select password unmask to show your entered password in plain text.
PPP Connection Trigger	Select when to have the EMG establish the PPP connection. Auto Connect - select this to not let the connection time out. On Demand - select this to automatically bring up the connection when the EMG receives packets destined for the Internet.
Idle Timeout	This value specifies the time in minutes that elapses before the router automatically disconnects from the PPPoE server. This field is not available if you select On Demand in the PPP Connection Trigger field.
PPPoE Passthrough	This field is available when you select PPPoE encapsulation. In addition to the EMG's built-in PPPoE client, you can enable PPPoE pass through to allow up to ten hosts on the LAN to use PPPoE client software on their computers to connect to the ISP via the EMG. Each host can have a separate account and a public WAN IP address. PPPoE pass through is an alternative to NAT for application where NAT is not appropriate. Disable PPPoE pass through if you do not need to allow hosts on the LAN to use PPPoE client software on their computers to connect to the ISP.
IP Address (This is available only when you select IPv4 Only or IPv4 IPv6 DualStack in the IPv4/IPv6 Mode field.)	
Obtain an IP Address Automatically	A static IP address is a fixed IP that your ISP gives you. A dynamic IP address is not fixed; the ISP assigns you a different one each time you connect to the Internet. Select this if you have a dynamic IP address.
Static IP Address	Select this option if the ISP assigned a fixed IP address
IP Address	Enter the static IP address provided by your ISP.
Subnet Mask	Enter the subnet mask provided by your ISP.
Gateway IP Address	Enter the gateway IP address provided by your ISP.
VLAN	
Active	Select Enable to enable VLAN on this WAN interface.
802.1p	IEEE 802.1p defines up to 8 separate traffic types by inserting a tag into a MAC-layer frame that contains bits to define class of service. Select the IEEE 802.1p priority level (from 0 to 7) to add to traffic through this connection. The greater the number, the higher the priority level.
802.1q	Type the VLAN ID number (from 1 to 4094) for traffic through this connection.
MTU	
MTU	Enter the MTU (Maximum Transfer Unit) size for this traffic.
Routing Feature (This is available only when you select IPv4 Only or IPv4 IPv6 DualStack in the IPv4/IPv6 Mode field.)	
NAT Enable	Select Enable to activate NAT on this connection.

Table 12 Network Setting > Broadband > Add New WAN Interface/Edit (Routing Mode) (continued)

LABEL	DESCRIPTION
Fullcone NAT Enable	Select Enable to enable full cone NAT on this connection. This field is available only when you activate NAT. In full cone NAT, the EMG maps all outgoing packets from an internal IP address and port to a single IP address and port on the external network. The EMG also maps packets coming to that external IP address and port to the internal IP address and port.
IGMP Proxy Enable	Internet Group Multicast Protocol (IGMP) is a network-layer protocol used to establish membership in a Multicast group - it is not used to carry user data. Select Enable to have the EMG act as an IGMP proxy on this connection. This allows the EMG to get subscribing information and maintain a joined member list for each multicast group. It can reduce multicast traffic significantly.
Apply as Default Gateway	Select Enable to have the EMG use the WAN interface of this connection as the system default gateway.
DNS Server (This is available only when you select IPv4 Only or IPv4 IPv6 DualStack in the IPv4/IPv6 Mode field.)	
	Select Obtain DNS Info Automatically if you want the EMG to use the DNS server addresses assigned by your ISP. Select Use Following Static DNS Address if you want the EMG to use the DNS server addresses you configure manually.
Primary DNS Server	Enter the first DNS server address assigned by the ISP.
Secondary DNS Server	Enter the second DNS server address assigned by the ISP.
WAN MAC Address You can see the default MAC address on the EMG's bottom label. This is also the MAC address the EMG reports to the ACS (Auto Configuration Server) server.	
Factory Default	Select this option to have the EMG use the default MAC address for the WAN interface that came along with this EMG when it was produced.
Clone LAN Host's MAC Address - IP Address	Select this option and enter a LAN host's MAC address this WAN interface will use. In this way, the WAN interface pretends to be that LAN host to the ISP.
Set WAN MAC Address	Select this option and enter a MAC address that you want the WAN interface to use.
Tunnel The DS-Lite (Dual Stack Lite) fields display when you set the IPv4/IPv6 Mode field to IPv6 Only . Enable Dual Stack Lite to let local computers use IPv4 through an ISP's IPv6 network. See Dual Stack Lite on page 66 for more information.	
Enable DS-Lite	This is available only when you select IPv6 Only in the IPv4/IPv6 Mode field. Select Enable to let local computers use IPv4 through an ISP's IPv6 network.
DS-Lite Relay Server IP	Specify the transition router's IPv6 address.
6RD The 6RD (IPv6 rapid deployment) fields display when you set the IPv6/IPv4 Mode field to IPv4 Only . See IPv6 Rapid Deployment on page 66 for more information.	
6RD	Select Enable to tunnel IPv6 traffic from the local network through the ISP's IPv4 network.
	Select Manually Configured if you have the IPv4 address of the relay server. Otherwise, select Automatically configured by DHCP to have the EMG detect it automatically through DHCP. The Automatically configured by DHCP option is configurable only when you set the method of encapsulation to IPoE .

Table 12 Network Setting > Broadband > Add New WAN Interface/Edit (Routing Mode) (continued)

LABEL	DESCRIPTION
Service Provider IPv6 Prefix	Enter an IPv6 prefix for tunneling IPv6 traffic to the ISP's border relay router and connecting to the native IPv6 Internet.
IPv4 Mask Length	Enter the subnet mask number (1-32) for the IPv4 network.
Border Relay IPv4 Address	When you select Manually Configured , specify the relay server's IPv4 address in this field.
DHCP Options (This is available only when you select IPoE for the encapsulation and IPv4 Only or IPv4 IPv6 DualStack in the IPv4/IPv6 Mode field.)	
Request Options	Select Option 43 to have the EMG automatically add vendor specific information in the DHCP packets to request the vendor specific options from the DHCP server. Select Option 121 to have the EMG push static routes to clients.
Sent Options	
option 60	Select this and enter the device identity you want the EMG to add in the DHCP discovery packets that go to the DHCP server.
Vendor ID	Enter the Vendor Class Identifier, such as the type of the hardware or firmware.
option 61	Select this and enter any string that identifies the device.
IAID	Enter the Identity Association Identifier (IAID) of the device, for example, the WAN connection index number.
DUID	Enter the hardware type, a time value and the MAC address of the device.
option 125	Select this to have the EMG automatically generate and add vendor specific parameters in the DHCP discovery packets that go to the DHCP server.
IPv6 Address (This is available only when you select IPv4 IPv6 DualStack or IPv6 Only in the IPv4/IPv6 Mode field.)	
Obtain an IPv6 Address Automatically	Select Obtain an IPv6 Address Automatically if you want to have the EMG use the IPv6 prefix from the connected router's Router Advertisement (RA) to generate an IPv6 address.
Static IPv6 Address	Select Static IPv6 Address if you have a fixed IPv6 address assigned by your ISP. When you select this, the following fields appear.
IPv6 Address	Enter an IPv6 IP address that your ISP gave to you for this WAN interface.
Prefix Length	Enter the address prefix length to specify how many most significant bits in an IPv6 address compose the network address.
IPv6 Default Gateway	Enter the IP address of the next-hop gateway. The gateway is a router or switch on the same segment as your EMG's interface(s). The gateway helps forward packets to their destinations.
IPv6 Routing Feature (This is available only when you select IPv4 IPv6 DualStack or IPv6 Only in the IPv4/IPv6 Mode field. You can enable IPv6 routing features in the following section.)	
MLD Proxy Enable	Select this checkbox to have the EMG act as an MLD proxy on this connection. This allows the EMG to get subscription information and maintain a joined member list for each multicast group. It can reduce multicast traffic significantly.
Apply as Default Gateway	Select this option to have the EMG use the WAN interface of this connection as the system default gateway.
IPv6 DNS Server This is available only when you select IPv4 IPv6 DualStack or IPv6 Only in the IPv4/IPv6 Mode field. Configure the IPv6 DNS server in the following section.	
Obtain IPv6 DNS Info Automatically	Select Obtain IPv6 DNS Info Automatically to have the EMG get the IPv6 DNS server addresses from the ISP automatically.
Use Following Static IPv6 DNS Address	Select Use Following Static IPv6 DNS Address to have the EMG use the IPv6 DNS server addresses you configure manually.

Table 12 Network Setting > Broadband > Add New WAN Interface/Edit (Routing Mode) (continued)

LABEL	DESCRIPTION
Primary DNS Server	Enter the first IPv6 DNS server address assigned by the ISP.
Secondary DNS Server	Enter the second IPv6 DNS server address assigned by the ISP.
OK	Click OK to save your changes back to the EMG.
Cancel	Click Cancel to exit this screen without saving.

6.2.1.2 Bridge Mode

Click the **Add new WAN Interface** in the **Network Setting > Broadband** screen or the **Edit** icon next to the connection you want to configure. Select **Bridge** as the encapsulation mode. The screen varies depending on the interface type you select.

If you select **Ethernet** as the interface type, the following screen appears.

Figure 27 Network Setting > Broadband > Add New WAN Interface/Edit (Ethernet-Bridge Mode)

The following table describes the fields in this screen.

Table 13 Network Setting > Broadband > Add New WAN Interface/Edit (Ethernet-Bridge)

LABEL	DESCRIPTION
General	
Active	Select Enable to enable this WAN interface.
Name	Enter a service name of the connection.
Type	Select Ethernet as the interface that you want to configure.
Mode	Select Bridge when your ISP provides you more than one IP address and you want the connected computers to get individual IP address from ISP's DHCP server directly. If you select Bridge , you cannot use routing functions, such as QoS, Firewall, DHCP server and NAT on traffic from the selected LAN port(s).
VLAN	

Table 13 Network Setting > Broadband > Add New WAN Interface/Edit (Ethernet-Bridge) (continued)

LABEL	DESCRIPTION
Active	Select Enable to enable VLAN on this WAN interface.
802.1p	IEEE 802.1p defines up to 8 separate traffic types by inserting a tag into a MAC-layer frame that contains bits to define class of service. Select the IEEE 802.1p priority level (from 0 to 7) to add to traffic through this connection. The greater the number, the higher the priority level.
802.1q	Type the VLAN ID number (from 0 to 4094) for traffic through this connection.
OK	Click OK to save your changes.
Cancel	Click Cancel to exit this screen without saving.

6.3 Technical Reference

The following section contains additional technical information about the EMG features described in this chapter.

Encapsulation

Be sure to use the encapsulation method required by your ISP. The EMG can work in bridge mode or routing mode. When the EMG is in routing mode, it supports the following methods.

IP over Ethernet

IP over Ethernet (IPoE) is an alternative to PPPoE. IP packets are being delivered across an Ethernet network, without using PPP encapsulation. They are routed between the Ethernet interface and the WAN interface and then formatted so that they can be understood in a bridged environment. For instance, it encapsulates routed Ethernet frames into bridged Ethernet cells.

PPP over Ethernet (PPPoE)

Point-to-Point Protocol over Ethernet (PPPoE) provides access control and billing functionality in a manner similar to dial-up services using PPP. PPPoE is an IETF standard (RFC 2516) specifying how a personal computer (PC) interacts with a broadband modem (DSL, cable, wireless, etc.) connection.

For the service provider, PPPoE offers an access and authentication method that works with existing access control systems (for example RADIUS).

One of the benefits of PPPoE is the ability to let you access one of multiple network services, a function known as dynamic service selection. This enables the service provider to easily create and offer new IP services for individuals.

Operationally, PPPoE saves significant effort for both you and the ISP or carrier, as it requires no specific configuration of the broadband modem at the customer site.

By implementing PPPoE directly on the EMG (rather than individual computers), the computers on the LAN do not need PPPoE software installed, since the EMG does that part of the task. Furthermore, with NAT, all of the LANs' computers will have access.

IP Address Assignment

A static IP is a fixed IP that your ISP gives you. A dynamic IP is not fixed; the ISP assigns you a different one each time. The Single User Account feature can be enabled or disabled if you have either a dynamic or static IP. However the encapsulation method assigned influences your choices for IP address and default gateway.

Introduction to VLANs

A Virtual Local Area Network (VLAN) allows a physical network to be partitioned into multiple logical networks. Devices on a logical network belong to one group. A device can belong to more than one group. With VLAN, a device cannot directly talk to or hear from devices that are not in the same group(s); the traffic must first go through a router.

In Multi-Tenant Unit (MTU) applications, VLAN is vital in providing isolation and security among the subscribers. When properly configured, VLAN prevents one subscriber from accessing the network resources of another on the same LAN, thus a user will not see the printers and hard disks of another user in the same building.

VLAN also increases network performance by limiting broadcasts to a smaller and more manageable logical broadcast domain. In traditional switched environments, all broadcast packets go to each and every individual port. With VLAN, all broadcasts are confined to a specific broadcast domain.

Introduction to IEEE 802.1Q Tagged VLAN

A tagged VLAN uses an explicit tag (VLAN ID) in the MAC header to identify the VLAN membership of a frame across bridges - they are not confined to the switch on which they were created. The VLANs can be created statically by hand or dynamically through GVRP. The VLAN ID associates a frame with a specific VLAN and provides the information that switches need to process the frame across the network. A tagged frame is four bytes longer than an untagged frame and contains two bytes of TPID (Tag Protocol Identifier), residing within the type/length field of the Ethernet frame) and two bytes of TCI (Tag Control Information), starts after the source address field of the Ethernet frame).

The CFI (Canonical Format Indicator) is a single-bit flag, always set to zero for Ethernet switches. If a frame received at an Ethernet port has a CFI set to 1, then that frame should not be forwarded as it is to an untagged port. The remaining twelve bits define the VLAN ID, giving a possible maximum number of 4,096 VLANs. Note that user priority and VLAN ID are independent of each other. A frame with VID (VLAN Identifier) of null (0) is called a priority frame, meaning that only the priority level is significant and the default VID of the ingress port is given as the VID of the frame. Of the 4096 possible VIDs, a VID of 0 is used to identify priority frames and value 4095 (FFF) is reserved, so the maximum possible VLAN configurations are 4,094.

TPID	User Priority	CFI	VLAN ID
2 Bytes	3 Bits	1 Bit	12 Bits

Multicast

IP packets are transmitted in either one of two ways - Unicast (1 sender - 1 recipient) or Broadcast (1 sender - everybody on the network). Multicast delivers IP packets to a group of hosts on the network - not everybody and not just 1.

Internet Group Multicast Protocol (IGMP) is a network-layer protocol used to establish membership in a Multicast group - it is not used to carry user data. IGMP version 2 (RFC 2236) is an improvement over version 1 (RFC 1112) but IGMP version 1 is still in wide use. If you would like to read more detailed information about interoperability between IGMP version 2 and version 1, please see sections 4 and 5 of RFC 2236. The class D IP address is used to identify host groups and can be in the range 224.0.0.0 to 239.255.255.255. The address 224.0.0.0 is not assigned to any group and is used by IP multicast computers. The address 224.0.0.1 is used for query messages and is assigned to the permanent group of all IP hosts (including gateways). All hosts must join the 224.0.0.1 group in order to participate in IGMP. The address 224.0.0.2 is assigned to the multicast routers group.

At start up, the EMG queries all directly connected networks to gather group membership. After that, the EMG periodically updates this information.

DNS Server Address Assignment

Use Domain Name System (DNS) to map a domain name to its corresponding IP address and vice versa, for instance, the IP address of `www.zyxel.com` is `204.217.0.2`. The DNS server is extremely important because without it, you must know the IP address of a computer before you can access it.

The EMG can get the DNS server addresses in the following ways.

- 1 The ISP tells you the DNS server addresses, usually in the form of an information sheet, when you sign up. If your ISP gives you DNS server addresses, manually enter them in the DNS server fields.
- 2 If your ISP dynamically assigns the DNS server IP addresses (along with the EMG's WAN IP address), set the DNS server fields to get the DNS server address from the ISP.

IPv6 Addressing

The 128-bit IPv6 address is written as eight 16-bit hexadecimal blocks separated by colons (:). This is an example IPv6 address `2001:0db8:1a2b:0015:0000:0000:1a2f:0000`.

IPv6 addresses can be abbreviated in two ways:

- Leading zeros in a block can be omitted. So `2001:0db8:1a2b:0015:0000:0000:1a2f:0000` can be written as `2001:db8:1a2b:15:0:0:1a2f:0`.
- Any number of consecutive blocks of zeros can be replaced by a double colon. A double colon can only appear once in an IPv6 address. So `2001:0db8:0000:0000:1a2f:0000:0000:0015` can be written as `2001:0db8::1a2f:0000:0000:0015`, `2001:0db8:0000:0000:1a2f::0015`, `2001:db8::1a2f:0:0:15` or `2001:db8:0:0:1a2f::15`.

IPv6 Prefix and Prefix Length

Similar to an IPv4 subnet mask, IPv6 uses an address prefix to represent the network address. An IPv6 prefix length specifies how many most significant bits (start from the left) in the address compose the network address. The prefix length is written as `/x` where `x` is a number. For example,

```
2001:db8:1a2b:15::1a2f:0/32
```

means that the first 32 bits (`2001:db8`) is the subnet prefix.

CHAPTER 7

Wireless

7.1 Overview

This chapter describes the EMG's **Network Setting > Wireless** screens. Use these screens to set up your EMG's wireless connection.

7.1.1 What You Can Do in this Chapter

This section describes the EMG's **Wireless** screens. Use these screens to set up your EMG's wireless connection.

- Use the **WiFi** screen to enable the Wireless LAN, enter the SSID and select the wireless security mode ([Section 7.2 on page 78](#)).
- Use the **Guest WiFi** screen to set up multiple wireless networks on your EMG ([Section 7.3 on page 80](#)).
- Use the **WPS** screen to add another WPS-enabled wireless device (within wireless range of the EMG) to the EMG's 2.4G or 5G wireless network([Section 7.4 on page 82](#)).
- Use the **Advanced** screen to configure advanced settings for the EMG's 2.4G and 5G wireless network ([Section 7.5 on page 82](#)).
- Use the **Channel Status** screen to scan the number of devices which are using 2.4G and/or 5G wireless channels and view the results ([Section 7.6 on page 85](#)).
- Use the **MESH** screen to enable or disable wireless roaming between the EMG and an wireless AP extender device ([Section 7.7 on page 87](#)).

7.1.2 What You Need to Know

Wireless Basics

"Wireless" is essentially radio communication. In the same way that walkie-talkie radios send and receive information over the airwaves, wireless networking devices exchange information with one another. A wireless networking device is just like a radio that lets your computer exchange information with radios attached to other computers. Like walkie-talkies, most wireless networking devices operate at radio frequency bands that are open to the public and do not require a license to use. However, wireless networking is different from that of most traditional radio communications in that there a number of wireless networking standards available with different methods of data encryption.

Finding Out More

See [Section 7.8 on page 89](#) for advanced technical information on wireless networks.

7.2 The WiFi Screen

Use this screen to view the wireless network name and password. You can also click the **Edit** icon to configure the settings.

Click **Network Setting > Wireless** to open the **WiFi** screen.

Figure 28 Network Setting > Wireless > WiFi

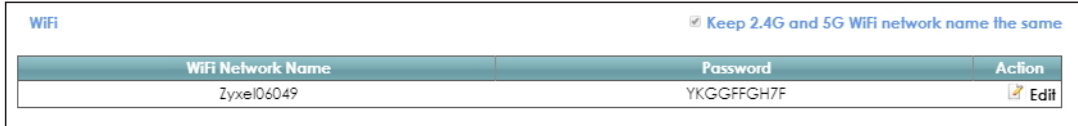
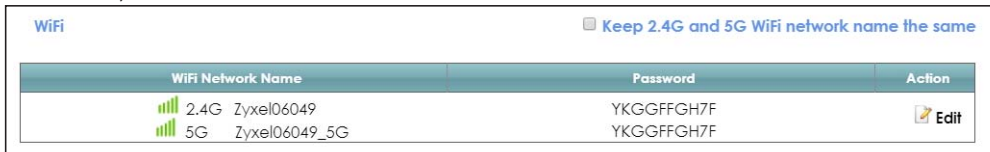

Figure 29 Network Setting > Wireless > WiFi (Without Keeping 2.4G and 5G WiFi Network Name The Same)



The following table describes the general wireless LAN labels in this screen.

Table 14 Network Setting > Wireless > WiFi

LABEL	DESCRIPTION
Keep 2.4G and 5G WiFi network name the same	Select this if you want the EMG use the same wireless network name, password, and security type for both the 2.4GHz and 5GHz band networks. Clear this to have the screen display the corresponding information for the 2.4GHz and 5GHz band networks. 2.4GHz is the frequency used by IEEE 802.11b/g/n wireless clients while 5GHz is used by IEEE 802.11a/ac wireless clients. Note: This setting is configurable only when the MESH function is disabled in the Network Setting > Wireless > MESH screen.
WiFi Network Name	This is the wireless network name.
Password	This is the password of the wireless network.
Action	Click the Edit icon to configure the wireless network settings.

7.2.1 The WiFi Edit Screen

Use this screen to view and configure the wireless network name, password and security type. Click the **Edit** icon on the **Network Setting > Wireless > WiFi** screen to open the **WiFi Edit** screen.

Figure 30 Network Setting > Wireless > WiFi > Edit

Figure 31 Network Setting > Wireless > WiFi > Edit (Without Keeping 2.4G and 5G WiFi Network Name The Same)

The following table describes the general wireless LAN labels in this screen.

Table 15 Network Setting > Wireless > WiFi > Edit

LABEL	DESCRIPTION
WiFi	You can Enable or Disable the wireless LAN in this field.
Keep 2.4G and 5G WiFi network name the same	Select this if you want the EMG use the same wireless network name, password, and security type for both the 2.4G and 5G networks. Clear this to have the screen display the corresponding information for the 2.4GHz and 5GHz band networks. Note: This setting is configurable only when the MESH function is disabled in the Network Setting > Wireless > MESH screen.
WiFi Network Name	This is the wireless network name.
WiFi Password	This is the password of the wireless network. Select Password Unmark to display the entered password in plain text. Clear it to hide the password to avoid shoulder surfing.

Table 15 Network Setting > Wireless > WiFi > Edit (continued)

LABEL	DESCRIPTION
WiFi Security Type	Select WPA2-PSK to add security on this wireless network. The WPA2-PSK security mode is a newer, more robust version of the WPA encryption standard. It offers wireless clients a better and secure connection. The wireless clients which want to associate to this network must have same wireless security settings as the EMG. Or you can select No Security to allow any client to associate this network and the guest wireless network of the same wireless band (see Section 7.3) without any data encryption or authentication.
Save	Click Save to save your changes.
Cancel	Click Cancel to restore your previously saved settings.

7.3 The Guest WiFi Screen

This screen allows you to enable and configure multiple wireless networks for guests on the EMG.

You can view/configure one guest WiFi network and three extra WiFi networks on this screen. The extra WiFi networks include two extra 2.4GHz WiFi networks and one extra 5GHz WiFi network. The only difference between guest WiFi and extra WiFi is that you can configure the number of hours to keep the guest WiFi network on before the EMG turns it off.

Click **Network Setting > Wireless > Guest WiFi**. The following screen displays.

Figure 32 Network Setting > Wireless > Guest WiFi

Guest WiFi			
<input type="checkbox"/> Enable Guest WiFi			
WiFi Network Name	Password	Action	
Zyxel6049_guest	YKGGFFGH		
Extra WiFi			
Band	WiFi Network Name	Password	Action
2.4G	Zyxel6049_extra2	YKGGFFGH7F	
2.4G	Zyxel6049_extra3	YKGGFFGH7F	
5G	Zyxel6049_extra2_5G	YKGGFFGH7F	

The following table describes the labels in this screen.

Table 16 Network Setting > Wireless > Guest WiFi

LABEL	DESCRIPTION
Guest WiFi	
Enable Guest WiFi	Select this to enable the guest wireless network.
WiFi Network Name	This field displays the guest WiFi network name.
Password	This field displays the password used to connect to this guest wireless network.
Action	Click the Edit icon to configure the WiFi network profile.
Extra WiFi	
Band	This field indicates whether this extra WiFi network uses 2.4GHz or 5GHz band.
WiFi Network Name	This field displays the extra WiFi network name.

Table 16 Network Setting > Wireless > Guest WiFi (continued)

LABEL	DESCRIPTION
Password	This field displays the password used to connect to this extra wireless network.
Action	Click the Edit icon to configure the WiFi network profile.

7.3.1 Edit Guest WiFi

Use this screen to edit a guest WiFi or an extra WiFi settings. Click an **Edit** icon in the **Guest WiFi** screen. The following screen displays.

Note: Guest WiFi and Extra WiFi share the same security type with the main WiFi network setting configured in the **Network Setting > Wireless > WiFi > Edit** screen.

Figure 33 Network Setting > Wireless > Guest WiFi > Edit (For Guest WiFi)

Guest WiFi Network Settings

Guest WiFi Enable Disable (Settings are invalid when disabled)

2.4G WiFi Network Name: 5G WiFi Network Name:

WiFi Password: Password Unmask

Time Period Duration (hours): 1 4 8 12 24 48 Always on

Save **Cancel**

The following table describes the fields in this screen.

Table 17 Network Setting > Wireless > Guest WiFi > Edit

LABEL	DESCRIPTION
Guest WiFi	You can Enable or Disable the wireless LAN in this field.
2.4G/5G WiFi Network Name	Enter a descriptive name (up to 32 English keyboard characters) for the wireless LAN.
WiFi Password	Type a pre-shared key from 8 to 64 case-sensitive keyboard characters. Select Password Unmask to display the entered password in plain text. Clear it to hide the password to avoid shoulder surfing.
Time Period Duration (hours)	This field is only available when you are editing for the guest WiFi network, rather than for an extra WiFi network. Select the number of hours that you want to keep this wireless network on right after you apply the setting. The EMG automatically turns it off when time is up. Select Always on to have the EMG never turn the wireless network off.
Save	Click Save to save your changes.
Cancel	Click Cancel to exit this screen without saving.

7.4 The WPS Screen

Use this screen to use the WiFi Protected Setup (WPS) function on your EMG.

WPS allows you to quickly set up a wireless network with strong security, without having to configure security settings manually. Set up each WPS connection between two devices. Both devices must support WPS. See [Section 7.8.8.2 on page 95](#) for more information about WPS.

Note: The EMG applies the security settings of the main 2.4G or 5G wireless profile (see [Section 7.2.1 on page 78](#)). If you want to use the WPS feature, make sure you have enabled **WPS** in the **Network Setting > Wireless > Advanced** screen.

Click **Network Setting > Wireless > WPS**. The following screen displays.

Figure 34 Network Setting > Wireless > WPS

Connection Type	Wi-Fi Name	WPS
2.4G Wi-Fi	Zyxel06049	Connect
5G Wi-Fi	Zyxel06049	Connect

Activate WPS on wireless client within 2 minutes after clicking "Connect".

The following table describes the labels in this screen.

Table 18 Network Setting > Wireless > WPS

LABEL	DESCRIPTION
Connection Type	This field indicates whether you will apply WPS to the 2.4G or 5G wireless network.
Wi-Fi Name	This field displays the wireless network name.
WPS	Click the Connect button to add another WPS-enabled wireless device (within wireless range of the EMG) to the wireless network. This button may either be a physical button on the outside of device, or a menu button similar to the WPS button on this screen. Note: You must press the other wireless device's WPS button within two minutes of pressing this button.

7.5 The Advanced Screen

Use this screen to configure advanced wireless settings. Click **Network Setting > Wireless > Advanced**. The screen appears as shown.

See [Section 7.8.2 on page 91](#) for detailed definitions of the terms listed in this screen.

Figure 35 Network Setting > Wireless > Advanced

The configurations below are the advanced wireless settings.

2.4G Advanced Settings

Hide WiFi Network Name :

Channel :

Bandwidth :

802.11 Mode :

RTS/CTS Threshold :

Fragmentation Threshold :

Output Power :

Beacon Interval : ms

DTIM Interval : ms

802.11 Protection :

Preamble :

WPS :

OBSS Coexistence : Enable Disable

WMM : Enable Disable

WMM Automatic Power Save Delivery : Enable Disable

5G Advanced Settings

Hide WiFi Network Name :

Channel :

802.11 Mode :

RTS/CTS Threshold :

Fragmentation Threshold :

Output Power :

Beacon Interval : ms

DTIM Interval : ms

802.11 Protection :

Preamble :

WPS :

OBSS Coexistence : Enable Disable

WMM : Enable Disable

WMM Automatic Power Save Delivery : Enable Disable

DFS Channel : Enable Disable

MU-MIMO : Enable Disable

The following table describes the labels in this screen.

Table 19 Network Setting > Wireless > Advanced

LABEL	DESCRIPTION
2.4G Advanced Settings / 5G Advanced Settings	
Hide WiFi Network Name	<p>Select this check box to hide the wireless band's network name (SSID) in the outgoing beacon frame so a station cannot obtain the SSID through scanning using a site survey tool or any wireless clients.</p> <p>Note: This setting only applies to the main 2.4G and 5G wireless networks. It does not apply to the guest and extra wireless networks configured in the Network Setting > Wireless > Guest WiFi screen.</p>
Channel	<p>Select a specific channel the EMG uses for the wireless band. Select Auto to have the EMG automatically determine a channel to use.</p>
802.11 Mode	<p>Select 802.11b Only to allow only IEEE 802.11b compliant WLAN devices to associate with the EMG.</p> <p>Select 802.11g Only to allow only IEEE 802.11g compliant WLAN devices to associate with the EMG.</p> <p>Select 802.11n Only to allow only IEEE 802.11n compliant WLAN devices to associate with the EMG.</p> <p>Select 802.11b/g Mixed to allow either IEEE 802.11b or IEEE 802.11g compliant WLAN devices to associate with the EMG. The transmission rate of your EMG might be reduced.</p> <p>Select 802.11b/g/n Mixed to allow IEEE 802.11b, IEEE 802.11g or IEEE802.11n compliant WLAN devices to associate with the EMG. The transmission rate of your EMG might be reduced.</p>
RTS/CTS Threshold	<p>Data with its frame size larger than this value will perform the RTS (Request To Send)/CTS (Clear To Send) handshake.</p> <p>Enter a value between 0 and 2347.</p>
Fragmentation Threshold	<p>This is the maximum data fragment size that can be sent. Enter a value between 256 and 2346.</p>
Output Power	<p>Set the output power of the EMG. If there is a high density of APs in an area, decrease the output power to reduce interference with other APs. Select one of the following: 20%, 40%, 60%, 80% or 100%.</p>
Beacon Interval	<p>When a wirelessly networked device sends a beacon, it includes with it a beacon interval. This specifies the time period before the device sends the beacon again.</p> <p>The interval tells receiving devices on the network how long they can wait in low power mode before waking up to handle the beacon. This value can be set from 50ms to 1000ms. A high value helps save current consumption of the access point.</p>
DTIM Interval	<p>Delivery Traffic Indication Message (DTIM) is the time period after which broadcast and multicast packets are transmitted to mobile clients in the Power Saving mode. A high DTIM value can cause clients to lose connectivity with the network. This value can be set from 1 to 255.</p>
802.11 Protection	<p>Enabling this feature can help prevent collisions in mixed-mode networks (networks with both IEEE 802.11b and IEEE 802.11g traffic).</p> <p>Select Auto to have the wireless devices transmit data after a RTS/CTS handshake. This helps improve IEEE 802.11g performance.</p> <p>Select Off to disable 802.11 protection. The transmission rate of your EMG might be reduced in a mixed-mode network.</p> <p>This field displays Off and is not configurable when you set 802.11 Mode to 802.11b Only.</p>
Preamble	<p>Select a preamble type from the drop-down list box. Choices are Long or Short. See Section 7.8.7 on page 94 for more information.</p> <p>This field is configurable only when you set 802.11 Mode to 802.11b.</p>

Table 19 Network Setting > Wireless > Advanced (continued)

LABEL	DESCRIPTION
WPS	Select this to enable WPS function for the wireless network. Note: This setting only applies to the main 2.4G and 5G wireless networks. It does not apply to the guest and extra wireless networks configured in the Network Setting > Wireless > Guest WiFi screen. Note: This setting is configurable only when the MESH function is disabled in the Network Setting > Wireless > MESH screen.
OBSS Coexistence	Select Enable to allow the coexistence of 20 MHz and 40 MHz Overlapping Basic Service Sets (OBSS) in wireless local area networks. Select Disabled to disable this feature.
WMM	Select Enable to have the EMG automatically give the wireless network a priority level according to the ToS value in the IP header of packets it sends. WMM QoS (WiFi MultiMedia Quality of Service) gives high priority to voice and video, which makes them run more smoothly. Note: At the time of writing, WMM is enabled by default and it is not changeable.
WMM Automatic Power Save Delivery	Select Enable to extend the battery life of your mobile devices (especially useful for small devices that are running multimedia applications). The EMG goes to sleep mode to save power when it is not transmitting data. The AP buffers the packets sent to the EMG until the EMG "wakes up". The EMG wakes up periodically to check for incoming data. Note: This works only if the wireless device to which the EMG is connected also supports this feature.
DFS Channel	This option is only available for the 5GHz band. Disabling it will force Channel in Network Setting > Wireless > General to be set to Auto . Enabling this option allows the use of DFS channel, ranging from 52~144, which may interfere with some RADAR devices. If your device is operating near an area known to have RADAR devices, it is recommended to disable DFS Channel to avoid interfering with their signal. Note: At the time of writing, this field is not available for the EMG8726-B10A.
MU-MIMO	Select Enable to allow accelerated and simultaneous WiFi service when there are multiple MUMIMO (Multi User-Multiple input, Multiple Output) ready devices connected to the EMG.
Apply	Click Apply to save your changes.
Cancel	Click Cancel to restore your previously saved settings.

7.6 The Channel Status Screen

Use the **Channel Status** screen to scan the number of devices which are using 2.4G and/or 5G wireless LAN channels and view the results. Click **Network Setting > Wireless > Channel Status**. The screen appears as shown. Click **2.4G Scan** and/or **5G Scan** to scan the 2.4GHz and/or 5GHz wireless band channels. You can view the results in the corresponding **Channel Scan Result** section.

Note: The **2.4G Scan** or **5G Scan** button only works when the EMG uses 20MHz for the wireless channel width. You can go to the **Network Setting > Wireless > General** screen, click the **more** link, and then change the channel width setting in the **Bandwidth** field.

Figure 36 Network Setting > Wireless > Channel Status

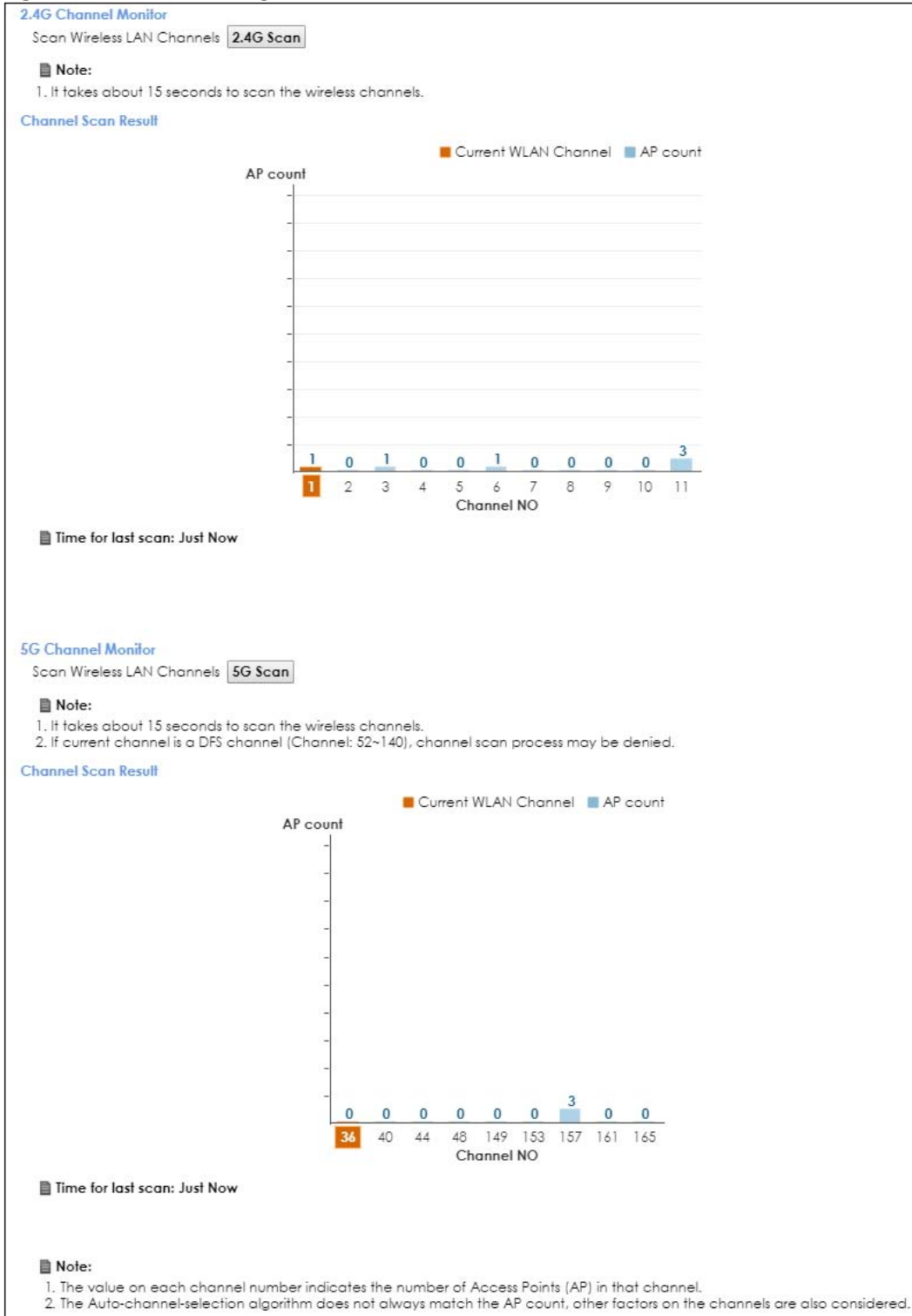

7.7 The MESH Screen

Use this screen to enable or disable Zyxel MESH (Multy Pro). It supports AP steering and Band steering. AP steering allows wireless clients to roam seamlessly between Multy-Pro-supported devices in your MESH network by using the same SSID and WiFi password. Also, AP steering helps monitor wireless clients and drop their connections to optimize the EMG bandwidth when the clients are idle or have a low signal.

When a wireless client is dropped, it has the opportunity to steer to a Multy-Pro-supported device with a strong signal. Band steering allows dual band wireless clients to steer from one band to another.

A MESH network consists of a controller, the EMG, and a maximum of three Multy-Pro-supported extenders.

When Multy Pro is enabled:

- One Connect will be enabled and grayed out automatically. It's used for the communication between the EMG and a Multy-Pro-supported extenders for the setup of a MESH network.
- The SSID and WiFi password of the main 2.4GHz wireless network will be copied to the main 5GHz wireless network.

See the steps below on how to set up a MESH network with the EMG. The setup could take you 30 minutes.

Configurations on a Multy-Pro-Supported Extender(s)

- 1 Prepare a Multy-Pro-supported extender(s) from Zyxel.

The following table lists the Multy-Pro-supported extenders from Zyxel at the time of writing.

Table 20 Multy-Pro-Supported Extenders from Zyxel

MODELS
WAP6804
WAP6906
WAP7205

- 2 If the Multy-Pro-supported extender is in repeater mode, enable the wireless LAN. See your Multy-Pro-supported extender's UG for how to enable the wireless LAN.
- 3 If the Multy-Pro-supported extender is in AP mode, connect it to the EMG using an Ethernet cable.
- 4 Turn on the Multy-Pro-supported extender.
- 5 Enable Zyxel MESH in the Web Configurator. See your Multy-Pro-supported extender's UG for how to enable Zyxel MESH.

Configurations on the EMG

- 1 If the Multy-Pro-supported extender is in repeater mode, enable the wireless LAN. See Section 5.1.3 on page 74 or Section 1.4.4 on page 24 for more information on enabling the wireless LAN.
- 2 Enable Zyxel MESH in the **Network > Wireless > MESH** screen.

- 3 Press the **WPS** button for more than five seconds on the EMG.

Or

Click **Add Extender** in the Multy Pro App. Install from Google Play or the Apple App store.

The following figure shows the Multy Pro application. Device Z is the EMG. Device A is a Multy-Prosupported extender in AP mode. Devices B and C are Multy-Pro-supported extenders in repeater Mode.

Figure 37 MESH Application

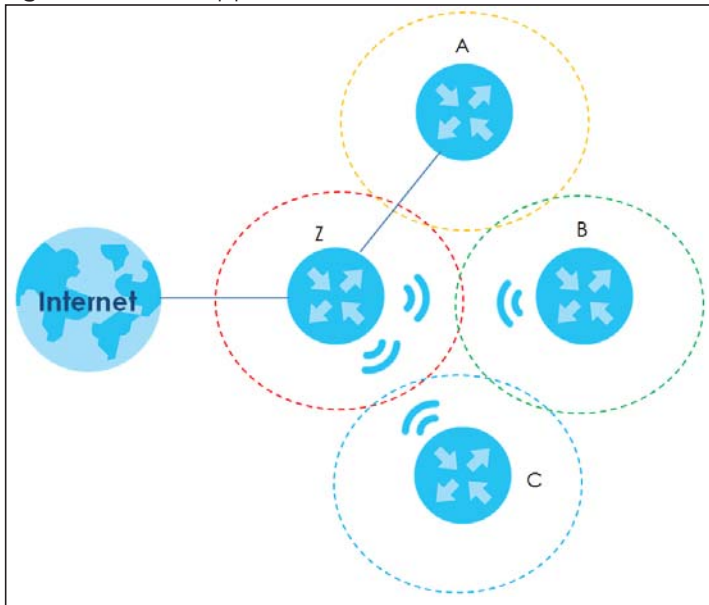

Click **Network > Wireless > MESH**. The following screen displays.

Figure 38 Network Setting > Wireless > MESH

MESH : Enable Disable

The following table describes the labels in this screen.

Table 21 Network Setting > Wireless > MESH

LABEL	DESCRIPTION
MESH	<p>Select Enable to activate MESH and have the EMG apply the wireless name, password, and security type of the main 2.4G wireless network to the main 5G wireless network. A warning displays when you select Enable (see Figure 39 on page 89).</p> <p>Note: When MESH is enabled, the following settings become not configurable:</p> <ul style="list-style-type: none"> The Keep 2.4G and 5G WiFi network name the same setting in the Network Setting > Wireless > WiFi and Network Setting > Wireless > WiFi > Edit screens. The WPS setting in the Network Setting > Wireless > Advanced screen. The ONE Connect setting in the Network Setting > Home Connectivity screen.
Apply	Click Apply to save your changes.
Cancel	Click Cancel to restore your previously saved settings.

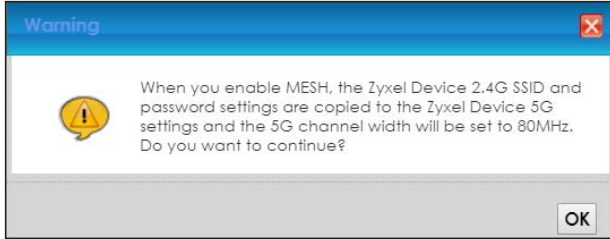
Figure 39 Network Setting > Wireless > MESH > A Warning When You Enable MESH

7.8 Technical Reference

This section discusses wireless LANs in depth. For more information, see [Appendix B on page 286](#).

7.8.1 Wireless Network Overview

Wireless networks consist of wireless clients, access points and bridges.

- A wireless client is a radio connected to a user's computer.
- An access point is a radio with a wired connection to a network, which can connect with numerous wireless clients and let them access the network.
- A bridge is a radio that relays communications between access points and wireless clients, extending a network's range.

Traditionally, a wireless network operates in one of two ways.

- An "infrastructure" type of network has one or more access points and one or more wireless clients. The wireless clients connect to the access points.
- An "ad-hoc" type of network is one in which there is no access point. Wireless clients connect to one another in order to exchange information.

The following figure provides an example of a wireless network.

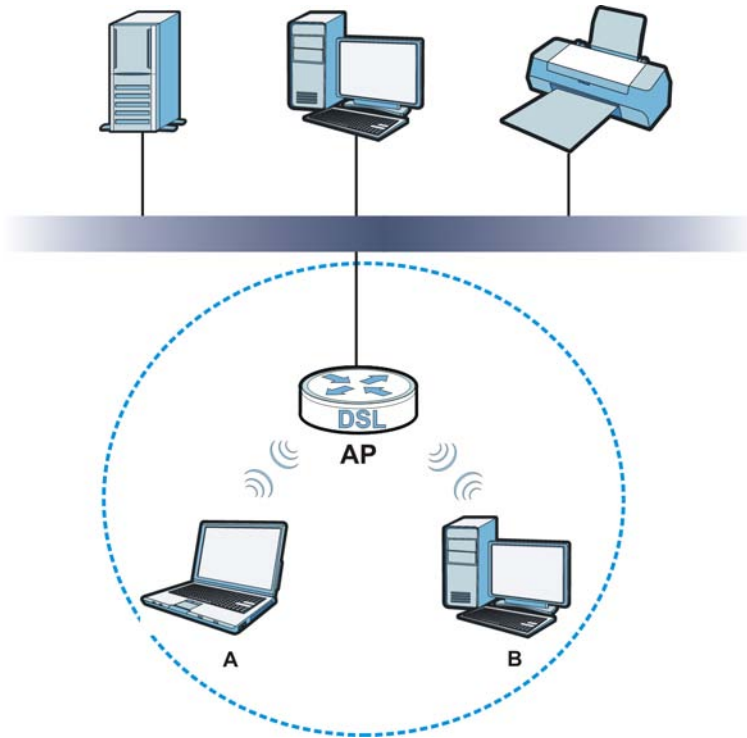
Figure 40 Example of a Wireless Network

The wireless network is the part in the blue circle. In this wireless network, devices **A** and **B** use the access point (**AP**) to interact with the other devices (such as the printer) or with the Internet. Your EMG is the AP.

Every wireless network must follow these basic guidelines.

- Every device in the same wireless network must use the same SSID.
The SSID is the name of the wireless network. It stands for Service Set Identifier.
- If two wireless networks overlap, they should use a different channel.
Like radio stations or television channels, each wireless network uses a specific channel, or frequency, to send and receive information.
- Every device in the same wireless network must use security compatible with the AP.
Security stops unauthorized devices from using the wireless network. It can also protect the information that is sent in the wireless network.

Radio Channels

In the radio spectrum, there are certain frequency bands allocated for unlicensed, civilian use. For the purposes of wireless networking, these bands are divided into numerous channels. This allows a variety of networks to exist in the same place without interfering with one another. When you create a network, you must select a channel to use.

Since the available unlicensed spectrum varies from one country to another, the number of available channels also varies.

7.8.2 Additional Wireless Terms

The following table describes some wireless network terms and acronyms used in the EMG's Web Configurator.

Table 22 Additional Wireless Terms

TERM	DESCRIPTION
RTS/CTS Threshold	<p>In a wireless network which covers a large area, wireless devices are sometimes not aware of each other's presence. This may cause them to send information to the AP at the same time and result in information colliding and not getting through.</p> <p>By setting this value lower than the default value, the wireless devices must sometimes get permission to send information to the EMG. The lower the value, the more often the devices must get permission.</p> <p>If this value is greater than the fragmentation threshold value (see below), then wireless devices never have to get permission to send information to the EMG.</p>
Preamble	A preamble affects the timing in your wireless network. There are two preamble modes: long and short. If a device uses a different preamble mode than the EMG does, it cannot communicate with the EMG.
Authentication	The process of verifying whether a wireless device is allowed to use the wireless network.
Fragmentation Threshold	A small fragmentation threshold is recommended for busy networks, while a larger threshold provides faster performance if the network is not very busy.

7.8.3 Wireless Security Overview

By their nature, radio communications are simple to intercept. For wireless data networks, this means that anyone within range of a wireless network without security can not only read the data passing over the airwaves, but also join the network. Once an unauthorized person has access to the network, he or she can steal information or introduce malware (malicious software) intended to compromise the network. For these reasons, a variety of security systems have been developed to ensure that only authorized people can use a wireless data network, or understand the data carried on it.

WPA2-PSK does two things. First, it authenticates. This means that only people presenting the right credentials (often a username and password, or a "key" phrase) can access the network. Second, it encrypts. This means that the information sent over the air is encoded. Only people with the code key can understand the information, and only people who have been authenticated are given the code key.

Because of the damage that can be done by a malicious attacker, it's not just people who have sensitive information on their network who should use security. Everybody who uses any wireless network should ensure that effective security is in place.

A good way to come up with effective security keys, passwords and so on is to use obscure information that you personally will easily remember, and to enter it in a way that appears random and does not include real words. For example, if your mother owns a 1970 Dodge Challenger and her favorite movie is Vanishing Point (which you know was made in 1971) you could use "70dodchal71vanpoi" as your security key.

The following sections introduce different types of wireless security you can set up in the wireless network.

7.8.3.1 SSID

Normally, the EMG acts like a beacon and regularly broadcasts the SSID in the area. You can hide the SSID instead, in which case the EMG does not broadcast the SSID. In addition, you should change the default SSID to something that is difficult to guess.

This type of security is fairly weak, however, because there are ways for unauthorized wireless devices to get the SSID. In addition, unauthorized wireless devices can still see the information that is sent in the wireless network.

7.8.3.2 MAC Address Filter

Every device that can use a wireless network has a unique identification number, called a MAC address.¹ A MAC address is usually written using twelve hexadecimal characters²; for example, 00A0C5000002 or 00:A0:C5:00:00:02. To get the MAC address for each device in the wireless network, see the device's User's Guide or other documentation.

You can use the MAC address filter to tell the EMG which devices are allowed or not allowed to use the wireless network. If a device is allowed to use the wireless network, it still has to have the correct information (SSID, channel, and security). If a device is not allowed to use the wireless network, it does not matter if it has the correct information.

This type of security does not protect the information that is sent in the wireless network. Furthermore, there are ways for unauthorized wireless devices to get the MAC address of an authorized device. Then, they can use that MAC address to use the wireless network.

7.8.3.3 User Authentication

Authentication is the process of verifying whether a wireless device is allowed to use the wireless network. You can make every user log in to the wireless network before using it. For wireless networks, you can store the user names and passwords for each user in a RADIUS server. This is a server used in businesses more than in homes. If you do not have a RADIUS server, you cannot set up user names and passwords for your users.

Unauthorized wireless devices can still see the information that is sent in the wireless network, even if they cannot use the wireless network. Furthermore, there are ways for unauthorized wireless users to get a valid user name and password. Then, they can use that user name and password to use the wireless network.

7.8.3.4 Encryption

Wireless networks can use encryption to protect the information that is sent in the wireless network. Encryption is like a secret code. If you do not know the secret code, you cannot understand the message.

-
1. Some wireless devices, such as scanners, can detect wireless networks but cannot use wireless networks. These kinds of wireless devices might not have MAC addresses.
 2. Hexadecimal characters are 0, 1, 2, 3, 4, 5, 6, 7, 8, 9, A, B, C, D, E, and F.

The types of encryption you can choose depend on the type of authentication. (See [Section 7.8.3.3 on page 92](#) for information about this.)

Table 23 Types of Encryption for Each Type of Authentication

	NO AUTHENTICATION
Weakest	No Security
↕	
Strongest	WPA2-PSK

For example, if users do not log in to the wireless network, you can choose no encryption or **WPA2-PSK**.

Usually, you should set up the strongest encryption that every device in the wireless network supports. For example, suppose you have a wireless network with the EMG and you do not have a RADIUS server. Therefore, there is no authentication.

Note: It is recommended that wireless networks use **WPA2-PSK**.

Many types of encryption use a key to protect the information in the wireless network. The longer the key, the stronger the encryption. Every device in the wireless network must have the same key.

7.8.4 Signal Problems

Because wireless networks are radio networks, their signals are subject to limitations of distance, interference and absorption.

Problems with distance occur when the two radios are too far apart. Problems with interference occur when other radio waves interrupt the data signal. Interference may come from other radio transmissions, such as military or air traffic control communications, or from machines that are coincidental emitters such as electric motors or microwaves. Problems with absorption occur when physical objects (such as thick walls) are between the two radios, muffling the signal.

7.8.5 BSS

A Basic Service Set (BSS) exists when all communications between wireless stations or between a wireless station and a wired network client go through one access point (AP).

Intra-BSS traffic is traffic between wireless stations in the BSS. When Intra-BSS traffic blocking is disabled, wireless station A and B can access the wired network and communicate with each other. When Intra-BSS traffic blocking is enabled, wireless station A and B can still access the wired network but cannot communicate with each other.

Figure 41 Basic Service set

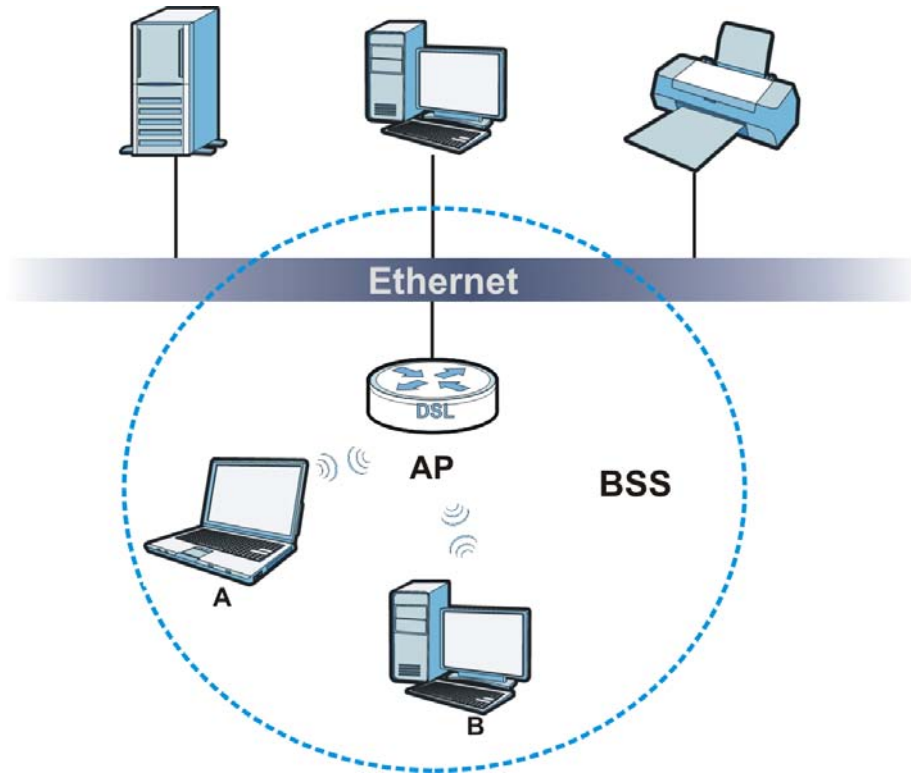

7.8.6 MBSSID

Traditionally, you need to use different APs to configure different Basic Service Sets (BSSs). As well as the cost of buying extra APs, there is also the possibility of channel interference. The EMG's MBSSID (Multiple Basic Service Set Identifier) function allows you to use one access point to provide several BSSs simultaneously. You can then assign varying QoS priorities and/or security modes to different SSIDs.

Wireless devices can use different BSSIDs to associate with the same AP.

7.8.6.1 Notes on Multiple BSSs

- A maximum of eight BSSs are allowed on one AP simultaneously.
- You must use different keys for different BSSs. If two wireless devices have different BSSIDs (they are in different BSSs), but have the same keys, they may hear each other's communications (but not communicate with each other).

7.8.7 Preamble Type

Preamble is used to signal that data is coming to the receiver. Short and long refer to the length of the synchronization field in a packet.

Short preamble increases performance as less time sending preamble means more time for sending data. All IEEE 802.11 compliant wireless adapters support long preamble, but not all support short preamble.

Use long preamble if you are unsure what preamble mode other wireless devices on the network support, and to provide more reliable communications in busy wireless networks.

Use short preamble if you are sure all wireless devices on the network support it, and to provide more efficient communications.

Use the dynamic setting to automatically use short preamble when all wireless devices on the network support it, otherwise the EMG uses long preamble.

Note: The wireless devices MUST use the same preamble mode in order to communicate.

7.8.8 WiFi Protected Setup (WPS)

Your EMG supports WiFi Protected Setup (WPS), which is an easy way to set up a secure wireless network. WPS is an industry standard specification, defined by the WiFi Alliance.

WPS allows you to quickly set up a wireless network with strong security, without having to configure security settings manually. Each WPS connection works between two devices. Both devices must support WPS (check each device's documentation to make sure).

Depending on the devices you have, you can either press a button (on the device itself, or in its configuration utility) in each of the two devices. When WPS is activated on a device, it has two minutes to find another device that also has WPS activated. Then, the two devices connect and set up a secure network by themselves.

7.8.8.1 Push Button Configuration

WPS Push Button Configuration (PBC) is initiated by pressing a button on each WPS-enabled device, and allowing them to connect automatically. You do not need to enter any information.

Not every WPS-enabled device has a physical WPS button. Some may have a WPS PBC button in their configuration utilities instead of or in addition to the physical button.

Take the following steps to set up WPS using the button.

- 1 Ensure that the two devices you want to set up are within wireless range of one another.
- 2 Look for a WPS button on each device. If the device does not have one, log into its configuration utility and locate the button (see the device's User's Guide for how to do this - for the EMG, see [Section 7.5 on page 82](#)).
- 3 Press the button on one of the devices (it doesn't matter which). For the EMG you must press the WPS button for more than three seconds.
- 4 Within two minutes, press the button on the other device. The registrar sends the network name (SSID) and security key through an secure connection to the enrollee.

If you need to make sure that WPS worked, check the list of associated wireless clients in the AP's configuration utility. If you see the wireless client in the list, WPS was successful.

7.8.8.2 How WPS Works

When two WPS-enabled devices connect, each device must assume a specific role. One device acts as the registrar (the device that supplies network and security settings) and the other device acts as the

enrollee (the device that receives network and security settings. The registrar creates a secure EAP (Extensible Authentication Protocol) tunnel and sends the network name (SSID) and the WPA2-PSK pre-shared key to the enrollee. Whether WPA2-PSK is used depends on the standards supported by the devices. If the registrar is already part of a network, it sends the existing information. If not, it generates the SSID and WPA2-PSK randomly.

The following figure shows a WPS-enabled client (installed in a notebook computer) connecting to a WPS-enabled access point.

Figure 42 How WPS works

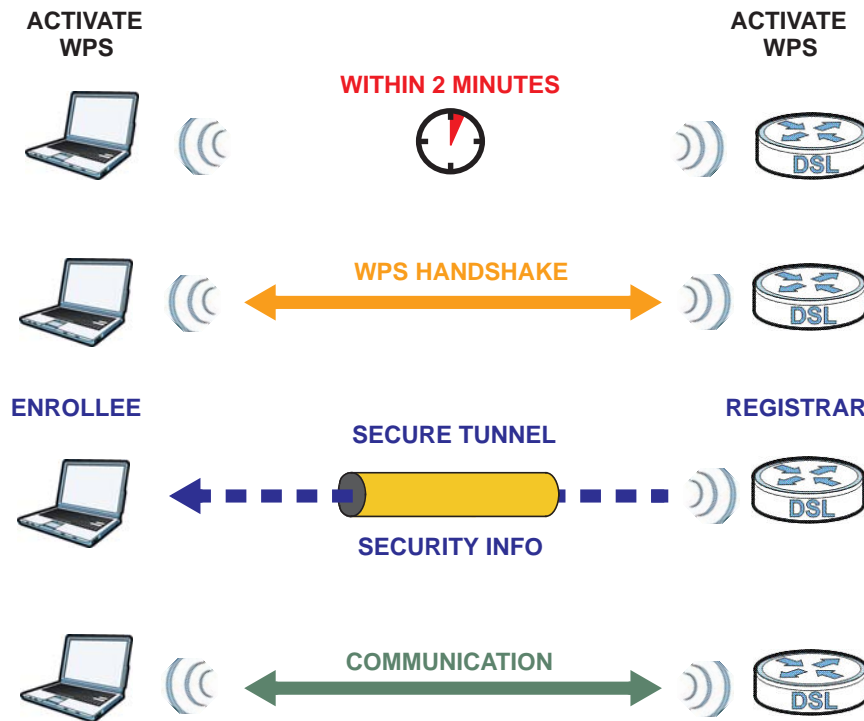

The roles of registrar and enrollee last only as long as the WPS setup process is active (two minutes). The next time you use WPS, a different device can be the registrar if necessary.

The WPS connection process is like a handshake; only two devices participate in each WPS transaction. If you want to add more devices you should repeat the process with one of the existing networked devices and the new device.

Note that the access point (AP) is not always the registrar, and the wireless client is not always the enrollee. All WPS-certified APs can be a registrar, and so can some WPS-enabled wireless clients.

By default, a WPS device is "unconfigured". This means that it is not part of an existing network and can act as either enrollee or registrar (if it supports both functions). If the registrar is unconfigured, the security settings it transmits to the enrollee are randomly-generated. Once a WPS-enabled device has connected to another device using WPS, it becomes "configured". A configured wireless client can still act as enrollee or registrar in subsequent WPS connections, but a configured access point can no longer act as enrollee. It will be the registrar in all subsequent WPS connections in which it is involved. If you want a configured AP to act as an enrollee, you must reset it to its factory defaults.

7.8.8.3 Example WPS Network Setup

This section shows how security settings are distributed in an example WPS setup.

The following figure shows an example network. In step 1, both **AP1** and **Client 1** are unconfigured. When WPS is activated on both, they perform the handshake. In this example, **AP1** is the registrar, and **Client 1** is the enrollee. The registrar randomly generates the security information to set up the network, since it is unconfigured and has no existing information.

Figure 43 WPS: Example Network Step 1



In step 2, you add another wireless client to the network. You know that **Client 1** supports registrar mode, but it is better to use **AP1** for the WPS handshake with the new client since you must connect to the access point anyway in order to use the network. In this case, **AP1** must be the registrar, since it is configured (it already has security information for the network). **AP1** supplies the existing security information to **Client 2**.

Figure 44 WPS: Example Network Step 2

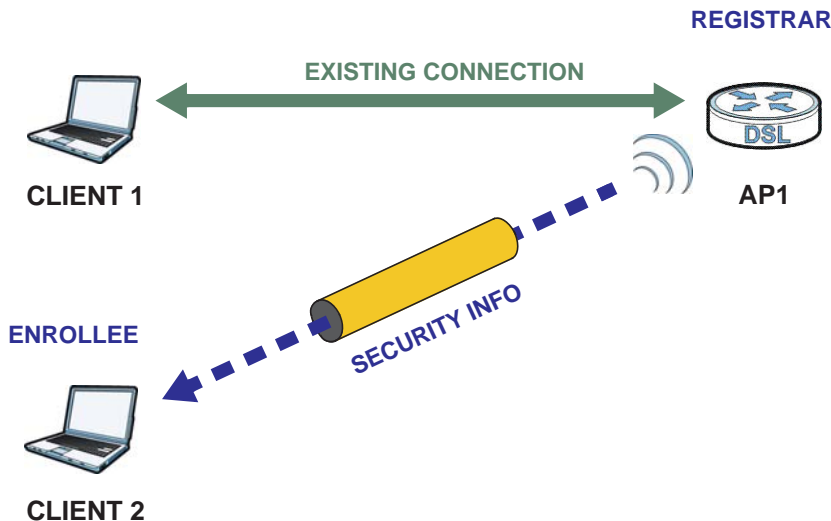

In step 3, you add another access point (**AP2**) to your network. **AP2** is out of range of **AP1**, so you cannot use **AP1** for the WPS handshake with the new access point. However, you know that **Client 2** supports the registrar function, so you use it to perform the WPS handshake instead.

Figure 45 WPS: Example Network Step 3

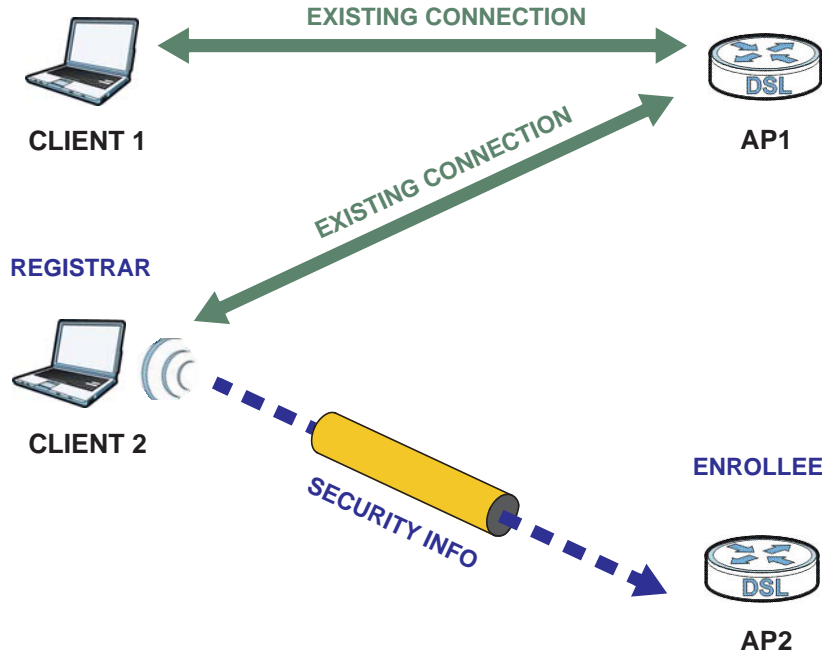

7.8.8.4 Limitations of WPS

WPS has some limitations of which you should be aware.

- WPS works in Infrastructure networks only (where an AP and a wireless client communicate). It does not work in Ad-Hoc networks (where there is no AP).
- When you use WPS, it works between two devices only. You cannot enroll multiple devices simultaneously, you must enroll one after the other.

For instance, if you have two enrollees and one registrar you must set up the first enrollee (by pressing the WPS button on the registrar and the first enrollee, for example), then check that it successfully enrolled, then set up the second device in the same way.

- WPS works only with other WPS-enabled devices. However, you can still add non-WPS devices to a network you already set up using WPS.

WPS works by automatically issuing a randomly-generated WPA2-PSK pre-shared key from the registrar device to the enrollee devices. Whether the network uses WPA2-PSK depends on the device. You can check the configuration interface of the registrar device to discover the key the network is using (if the device supports this feature). Then, you can enter the key into the non-WPS device and join the network as normal (the non-WPS device must also support WPA2-PSK).

- When you use the PBC method, there is a short period (from the moment you press the button on one device to the moment you press the button on the other device) when any WPS-enabled device could join the network. This is because the registrar has no way of identifying the "correct" enrollee, and cannot differentiate between your enrollee and a rogue device. This is a possible way for a hacker to gain access to a network.

You can easily check to see if this has happened. WPS works between only two devices simultaneously, so if another device has enrolled your device will be unable to enroll, and will not have access to the network. If this happens, open the access point's configuration interface and look at the list of associated clients (usually displayed by MAC address). It does not matter if the access

point is the WPS registrar, the enrollee, or was not involved in the WPS handshake; a rogue device must still associate with the access point to gain access to the network. Check the MAC addresses of your wireless clients (usually printed on a label on the bottom of the device). If there is an unknown MAC address you can remove it or reset the AP.

CHAPTER 8

Home Networking

8.1 Overview

A Local Area Network (LAN) is a shared communication system to which many networking devices are connected. It is usually located in one immediate area such as a building or floor of a building.

Use the LAN screens to help you configure a LAN DHCP server and manage IP addresses.



8.1.1 What You Can Do in this Chapter

- Use the **LAN Setup** screen to set the LAN IP address, subnet mask, and DHCP settings of your EMG (Section 8.2 on page 102).
- Use the **Static DHCP** screen to assign IP addresses on the LAN to specific individual computers based on their MAC Addresses (Section 8.3 on page 106).
- Use the **UPnP** screen to enable UPnP and UPnP NAT traversal on the EMG (Section 8.4 on page 107).
- Use the **Additional Subnet** screen to configure IP alias and public static IP (Section 8.5 on page 121).
- Use the **STB Vendor ID** screen to configure the Vendor IDs of the connected Set Top Box (STB) devices, which have the EMG automatically create static DHCP entries for the STB devices when they request IP addresses (Section 8.6 on page 122).
- Use the **Wake on LAN** screen to remotely turn on a device on the network. (Section 8.7 on page 122).
- Use the **TFTP Server Name** screen to set a TFTP server address which is passed to the clients using DHCP option 66. (Section 8.8 on page 123).

8.1.2 What You Need To Know

8.1.2.1 About LAN

IP Address

IP addresses identify individual devices on a network. Every networking device (including computers, servers, routers, printers, etc.) needs an IP address to communicate across the network. These networking devices are also known as hosts.

Subnet Mask

Subnet masks determine the maximum number of possible hosts on a network. You can also use subnet masks to divide one network into multiple sub-networks.

DHCP

A DHCP (Dynamic Host Configuration Protocol) server can assign your EMG an IP address, subnet mask, DNS and other routing information when it's turned on.

DNS

DNS (Domain Name System) is for mapping a domain name to its corresponding IP address and vice versa. The DNS server is extremely important because without it, you must know the IP address of a networking device before you can access it.

RADVD (Router Advertisement Daemon)

When an IPv6 host sends a Router Solicitation (RS) request to discover the available routers, RADVD with Router Advertisement (RA) messages in response to the request. It specifies the minimum and maximum intervals of RA broadcasts. RA messages containing the address prefix. IPv6 hosts can be generated with the IPv6 prefix an IPv6 address.

8.1.2.2 About UPnP

Identifying UPnP Devices

UPnP hardware is identified as an icon in the Network Connections folder (Windows XP). Each UPnP compatible device installed on your network will appear as a separate icon. Selecting the icon of a UPnP device will allow you to access the information and properties of that device.

NAT Traversal

UPnP NAT traversal automates the process of allowing an application to operate through NAT. UPnP network devices can automatically configure network addressing, announce their presence in the network to other UPnP devices and enable exchange of simple product and service descriptions. NAT traversal allows the following:

- Dynamic port mapping
- Learning public IP addresses

- Assigning lease times to mappings

Windows Messenger is an example of an application that supports NAT traversal and UPnP.

See the [Chapter 11 on page 153](#) for more information on NAT.

Cautions with UPnP

The automated nature of NAT traversal applications in establishing their own services and opening firewall ports may present network security issues. Network information and configuration may also be obtained and modified by users in some network environments.

When a UPnP device joins a network, it announces its presence with a multicast message. For security reasons, the EMG allows multicast messages on the LAN only.

All UPnP-enabled devices may communicate freely with each other without additional configuration. Disable UPnP if this is not your intention.

UPnP and Zyxel

Zyxel has achieved UPnP certification from the Universal Plug and Play Forum UPnP™ Implementers Corp. (UIC). Zyxel's UPnP implementation supports Internet Gateway Device (IGD) 1.0.

See [Section 8.4.1 on page 108](#) for examples of installing and using UPnP.

Finding Out More

See [Section 8.9 on page 123](#) for technical background information on LANs.

8.1.3 Before You Begin

Find out the MAC addresses of your network devices if you intend to add them to the DHCP Client List screen.

8.2 The LAN Setup Screen

Use this screen to set the Local Area Network IP address and subnet mask of your EMG. Click **Network Setting > Home Networking** to open the **LAN Setup** screen.

Follow these steps to configure your LAN settings.

- 1 Enter an IP address into the **IP Address** field. The IP address must be in dotted decimal notation. This will become the IP address of your EMG.
- 2 Enter the IP subnet mask into the **Subnet Mask** field. Unless instructed otherwise it is best to leave this alone, the configurator will automatically compute a subnet mask based upon the IP address you entered.

- 3 Click **Apply** to save your settings.

Figure 46 Network Setting > Home Networking > LAN Setup

Interface Group	
Group Name	Default ▾
LAN IP Setup	
IP Address	192.168.1.1
Subnet Mask	255.255.255.0
IGMP Snooping	
Active	<input checked="" type="radio"/> Enable <input type="radio"/> Disable
IGMP Mode	<input type="radio"/> Standard Mode <input checked="" type="radio"/> Blocking Mode
DHCP Server State	
DHCP	<input checked="" type="radio"/> Enable <input type="radio"/> Disable <input type="radio"/> DHCP Relay
IP Addressing Values	
Beginning IP Address	192.168.1.2
Ending IP Address	192.168.1.254
Auto reserve IP for the same host	<input type="radio"/> Enable <input checked="" type="radio"/> Disable
DHCP Server Lease Time	
1 Days 0 Hours 0 Minutes	
DNS Values	
DNS	<input checked="" type="radio"/> DNS Proxy <input type="radio"/> Static <input type="radio"/> From ISP
LAN IPv6 Mode Setup	
IPv6 Active	<input checked="" type="radio"/> Enable <input type="radio"/> Disable
Link Local Address Type	
	<input checked="" type="radio"/> EUI64 <input type="radio"/> Manual
LAN Global Identifier Type	
	<input checked="" type="radio"/> EUI64 <input type="radio"/> Manual
LAN IPv6 Prefix Setup	
<input checked="" type="radio"/> Delegate prefix from WAN	Default ▾
<input type="radio"/> Static	
MLD Snooping	
Active	<input checked="" type="radio"/> Enable <input type="radio"/> Disable
MLD Mode :	<input type="radio"/> Standard Mode <input checked="" type="radio"/> Blocking Mode
LAN IPv6 Address Assign Setup	
	Stateless ▾
LAN IPv6 DNS Assign Setup	
	From DHCPv6 Server ▾
DHCPv6 Configuration	
DHCPv6 Active	DHCPv6 Server
IPv6 Router Advertisement State	
RADVD Active	Enable
IPv6 DNS Values	
IPv6 DNS Server 1	From ISP ▾ <input type="text"/>
IPv6 DNS Server 2	From ISP ▾ <input type="text"/>
IPv6 DNS Server 3	From ISP ▾ <input type="text"/>
DNS Query Scenario:	
	IPv4/IPv6 DNS Server ▾
<input type="button" value="Apply"/> <input type="button" value="Cancel"/>	

The following table describes the fields in this screen.

Table 24 Network Setting > Home Networking > LAN Setup

LABEL	DESCRIPTION
Interface Group	
Group Name	Select the interface group name for which you want to configure LAN settings. See Chapter 15 on page 179 for how to create a new interface group.
LAN IP Setup	
IP Address	Enter the LAN IPv4 address you want to assign to your EMG in dotted decimal notation, for example, 192.168.1.1 (factory default).
Subnet Mask	Type the subnet mask of your network in dotted decimal notation, for example 255.255.255.0 (factory default). Your EMG automatically computes the subnet mask based on the IP Address you enter, so do not change this field unless you are instructed to do so.
IGMP Snooping	
Active	Select Enable to allows the EMG to passively learn multicast group.
IGMP Mode	Select Standard Mode to forward multicast packets to a port that joins the multicast group and broadcast unknown multicast packets from the WAN to all LAN ports. Select Blocking Mode to block all unknown multicast packets from the WAN.
DHCP Server State	
DHCP	Select Enable to have the EMG act as a DHCP server or DHCP relay agent. Select Disable to stop the DHCP server on the EMG. Select DHCP Relay to have the EMG forward DHCP request to the DHCP server.
DHCP Relay Server Address	This field is only available when you select DHCP Relay in the DHCP field.
IP Address	Enter the IPv4 address of the actual remote DHCP server in this field.
IP Addressing Values	This field is only available when you select Enable in the DHCP field.
Beginning IP Address	This field specifies the first of the contiguous addresses in the IP address pool.
Ending IP Address	This field specifies the last of the contiguous addresses in the IP address pool.
Auto reserve IP for the same host	Select Enable to have the EMG record DHCP IP addresses with the MAC addresses the IP addresses are assigned to. The EMG assigns the same IP address to the same MAC address when the host requests an IP address again through DHCP.
DHCP Server Lease Time	This is the period of time DHCP-assigned addresses is used. DHCP automatically assigns IP addresses to clients when they log in. DHCP centralizes IP address management on central computers that run the DHCP server program. DHCP leases addresses, for a period of time, which means that past addresses are "recycled" and made available for future reassignment to other systems. This field is only available when you select Enable in the DHCP field.
Days/Hours/Minutes	Enter the lease time of the DHCP server.
DNS Values	This field is only available when you select Enable in the DHCP field.
DNS	Select From ISP if your ISP dynamically assigns DNS server information. Select DNS Proxy if you have the DNS proxy service. The EMG redirects clients' DNS queries to a DNS server for resolving domain names. Select Static if you have the IP address of a DNS server.
DNS Server 1/2	Enter the first and second DNS (Domain Name System) server IP addresses the EMG passes to the DHCP clients.

Table 24 Network Setting > Home Networking > LAN Setup (continued)

LABEL	DESCRIPTION
LAN IPv6 Mode Setup	
IPv6 Active	Select Enable to activate the IPv6 mode and configure IPv6 settings on the EMG.
Link Local Address Type	
EUI64	Select this to have the EMG generate an interface ID for the LAN interface's link-local address using the EUI-64 format.
Manual	Select this to manually enter an interface ID for the LAN interface's link-local address.
LAN Global Identifier Type	
EUI64	Select this to have the EMG generate an interface ID using the EUI-64 format for its global address.
Manual	Select this to manually enter an interface ID for the LAN interface's global IPv6 address.
LAN IPv6 Prefix Setup	
Delegate prefix from WAN	Select this option to automatically obtain an IPv6 network prefix from the service provider or an uplink router.
Static	Select this option to configure a fixed IPv6 address for the EMG's LAN IPv6 address.
MLD Snooping	Multicast Listener Discovery (MLD) allows an IPv6 switch or router to discover the presence of MLD hosts who wish to receive multicast packets and the IP addresses of multicast groups the hosts want to join on its network.
Active	Select Enable to activate MLD Snooping on the EMG. This allows the EMG to check MLD packets passing through it and learn the multicast group membership. It helps reduce multicast traffic.
MLD Mode	Select Standard Mode to forward multicast packets to a port that joins the multicast group and broadcast unknown multicast packets from the WAN to all LAN ports. Select Blocking Mode to block all unknown multicast packets from the WAN.
LAN IPv6 Address Assign Setup	Select how you want to obtain an IPv6 address: <ul style="list-style-type: none"> • Stateless: The EMG uses IPv6 stateless autoconfiguration. RADVD (Router Advertisement Daemon) is enabled to have the EMG send IPv6 prefix information in router advertisements periodically and in response to router solicitations. DHCPv6 server is disabled. • Stateful: The EMG uses IPv6 stateful autoconfiguration. The DHCPv6 server is enabled to have the EMG act as a DHCPv6 server and pass IPv6 addresses to DHCPv6 clients.
LAN IPv6 DNS Assign Setup	Select how the EMG provide DNS server and domain name information to the clients: <ul style="list-style-type: none"> • From Router Advertisement: The EMG provides DNS information through router advertisements. • From DHCPv6 Server: The EMG provides DNS information through DHCPv6. • From RA & DHCPv6 Server: The EMG provides DNS information through both router advertisements and DHCPv6.
DHCPv6 Configuration	
DHCPv6 Active	This shows the status of the DHCPv6. DHCPv6 Server displays if you configured the EMG to act as a DHCPv6 server which assigns IPv6 addresses and/or DNS information to clients.
IPv6 Router Advertisement State	
RADVD Active	This shows whether RADVD is enabled or not.
IPv6 DNS Values	
IPv6 DNS Server 1-3	Select From ISP if your ISP dynamically assigns IPv6 DNS server information. Select User-Defined if you have the IPv6 address of a DNS server. Enter the DNS server IPv6 addresses the EMG passes to the DHCP clients. Select None if you do not want to configure IPv6 DNS servers.

Table 24 Network Setting > Home Networking > LAN Setup (continued)

LABEL	DESCRIPTION
DNS Query Scenario	<p>Select how the EMG handles clients' DNS information requests.</p> <ul style="list-style-type: none"> IPv4/IPv6 DNS Server: The EMG forwards the requests to both the IPv4 and IPv6 DNS servers and sends clients the first DNS information it receives. IPv6 DNS Server Only: The EMG forwards the requests to the IPv6 DNS server and sends clients the DNS information it receives. IPv4 DNS Server Only: The EMG forwards the requests to the IPv4 DNS server and sends clients the DNS information it receives. IPv6 DNS Server First: The EMG forwards the requests to the IPv6 DNS server first and then the IPv4 DNS server. Then it sends clients the first DNS information it receives. IPv4 DNS Server First: The EMG forwards the requests to the IPv4 DNS server first and then the IPv6 DNS server. Then it sends clients the first DNS information it receives.
Apply	Click Apply to save your changes.
Cancel	Click Cancel to restore your previously saved settings.

8.3 The Static DHCP Screen

This table allows you to assign IP addresses on the LAN to specific individual computers based on their MAC Addresses.

Every Ethernet device has a unique MAC (Media Access Control) address. The MAC address is assigned at the factory and consists of six pairs of hexadecimal characters, for example, 00:A0:C5:00:00:02.

Use this screen to change your EMG's static DHCP settings. Click **Network Setting > Home Networking > Static DHCP** to open the following screen.

Figure 47 Network Setting > Home Networking > Static DHCP

Static DHCP Configuration				
#	Status	MAC Address	IP Address	Modify

The following table describes the labels in this screen.

Table 25 Network Setting > Home Networking > Static DHCP

LABEL	DESCRIPTION
Static DHCP Configuration	Click this to add a new static DHCP entry.
#	This is the index number of the entry.
Status	This field displays whether the client is connected to the EMG.
MAC Address	<p>The MAC (Media Access Control) or Ethernet address on a LAN (Local Area Network) is unique to your computer (six pairs of hexadecimal notation).</p> <p>A network interface card such as an Ethernet adapter has a hardwired address that is assigned at the factory. This address follows an industry standard that ensures no other adapter has a similar address.</p>
IP Address	This field displays the IP address relative to the # field listed above.
Modify	<p>Click the Edit icon to have the IP address field editable and change it.</p> <p>Click the Delete icon to delete a static DHCP entry. A window displays asking you to confirm that you want to delete the selected entry.</p>

If you click **Static DHCP Configuration** in the **Static DHCP** screen or the Edit icon next to a static DHCP entry, the following screen displays.

Figure 48 Static DHCP: Static DHCP Configuration/Edit

The following table describes the labels in this screen.

Table 26 Static DHCP: Static DHCP Configuration/Edit

LABEL	DESCRIPTION
Active	Select this to activate the connection between the client and the EMG.
Group Name	Select the interface group name for which you want to configure static DHCP settings. See Chapter 15 on page 179 for how to create a new interface group.
IP Type	This field displays IPv4 for the type of the DHCP IP address. At the time of writing, it is not allowed to select other type.
Select Device Info	Select a device or computer from the drop-down list or select Manual Input to manually enter a device's MAC address and IP address in the following fields.
MAC Address	If you select Manual Input , enter the MAC address of a computer on your LAN.
IP Address	If you select Manual Input , enter the IP address that you want to assign to the computer on your LAN with the MAC address that you will also specify.
OK	Click OK to save your changes.
Cancel	Click Cancel to exit this screen without saving.

8.4 The UPnP Screen

Universal Plug and Play (UPnP) is a distributed, open networking standard that uses TCP/IP for simple peer-to-peer network connectivity between devices. A UPnP device can dynamically join a network, obtain an IP address, convey its capabilities and learn about other devices on the network. In turn, a device can leave a network smoothly and automatically when it is no longer in use.

See [page 101](#) for more information on UPnP.

Use the following screen to configure the UPnP settings on your EMG. Click **Network Setting > Home Networking > UPnP** to display the screen shown next.

Figure 49 Network Setting > Home Networking > UPnP

UPnP State
UPnP Enable Disable

UPnP NAT-T State
UPnP NAT-T: Enable Disable

Note :
UPnP NAT-T only works when NAT is enable

#	Description	Destination IP Address	External Port	Internal Port	Protocol
<input type="button" value="Apply"/> <input type="button" value="Cancel"/>					

The following table describes the labels in this screen.

Table 27 Network Setting > Home Networking > UPnP

LABEL	DESCRIPTION
UPnP	Select Enable to activate UPnP. Be aware that anyone could use a UPnP application to open the web configurator's login screen without entering the EMG's IP address (although you must still enter the password to access the web configurator).
UPnP NAT-T	Select Enable to allow UPnP-enabled applications to automatically configure the EMG so that they can communicate through the EMG by using NAT traversal. UPnP applications automatically reserve a NAT forwarding port in order to communicate with another UPnP enabled device; this eliminates the need to manually configure port forwarding for the UPnP enabled application. The table below displays the NAT port forwarding rules added automatically by UPnP NAT-T.
#	This is the index number of the UPnP NAT-T connection.
Description	This is the description of the UPnP NAT-T connection.
Destination IP Address	This is the IP address of the other connected UPnP-enabled device.
External Port	This is the external port number that identifies the service.
Internal Port	This is the internal port number that identifies the service.
Protocol	This is the transport layer protocol used for the service.
Apply	Click Apply to save your changes.
Cancel	Click Cancel to exit this screen without saving.

8.4.1 Turning on UPnP in Windows 7 Example

This section shows you how to use the UPnP feature in Windows 7. UPnP server is installed in Windows 7. Activate UPnP on the EMG.

Make sure the computer is connected to a LAN port of the EMG. Turn on your computer and the EMG.

- 1 Click the start icon, **Control Panel** and then the **Network and Sharing Center**.

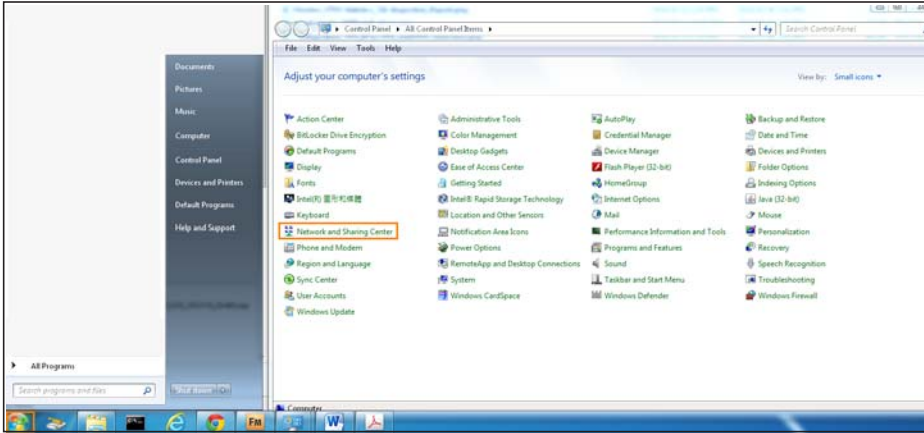

2 Click **Change Advanced Sharing Settings**.

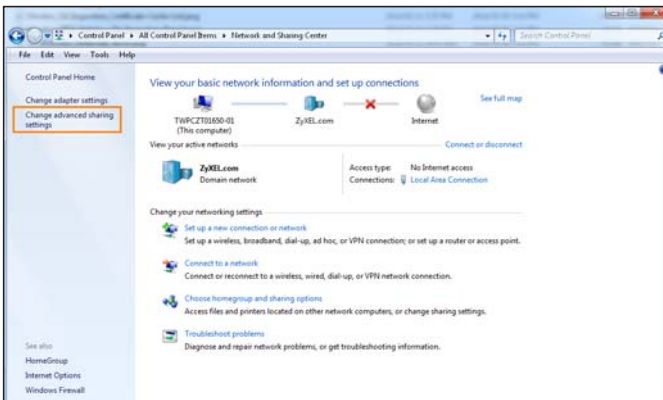

3 Select **Turn on network discovery** and click **Save Changes**. Network discovery allows your computer to find other computers and devices on the network and other computers on the network to find your computer. This makes it easier to share files and printers.

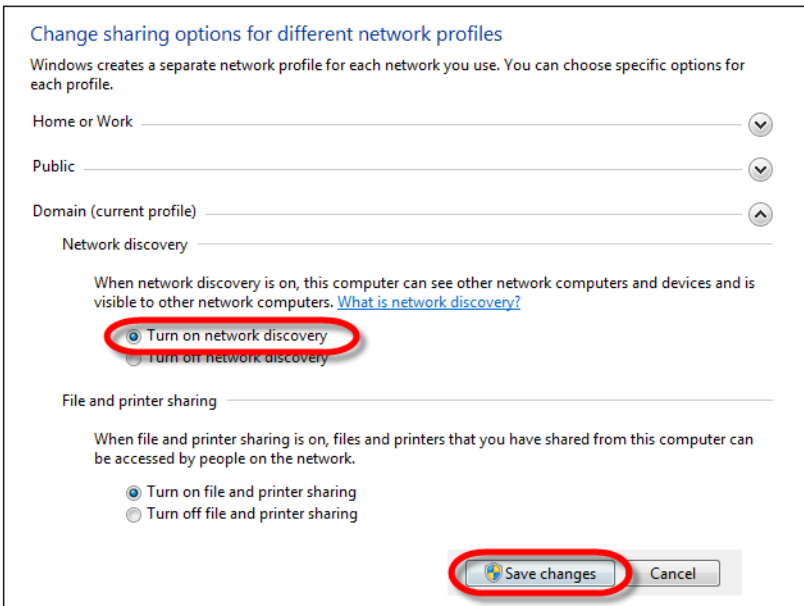

8.4.2 Auto-discover Your UPnP-enabled Network Device

Before you follow these steps, make sure you already have UPnP activated on the EMG and in your computer.

Make sure your computer is connected to the LAN port of the EMG.

- 1 Open **Windows Explorer** and click **Network**.
- 2 Right-click the EMG icon and select **Properties**.

Figure 50 Network Connections

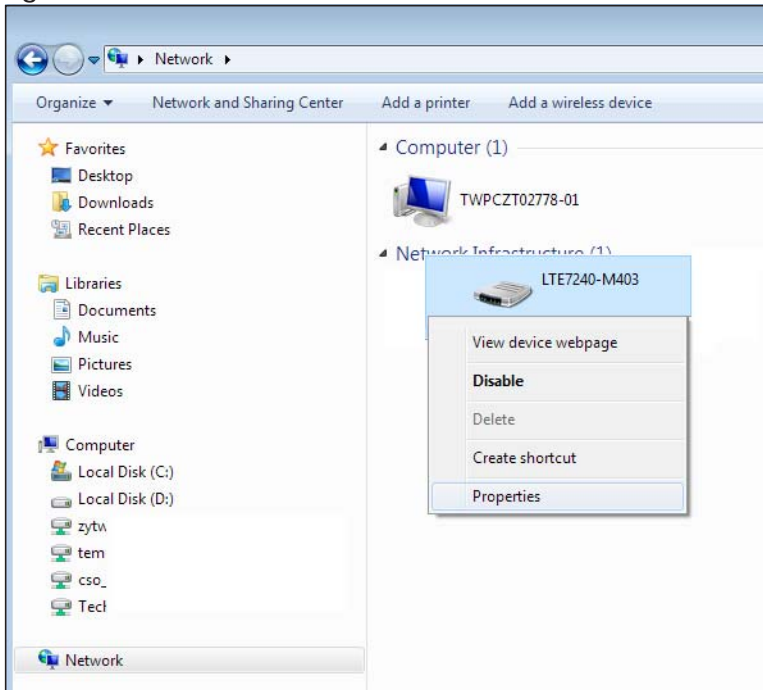

- 3 In the **Internet Connection Properties** window, click **Settings** to see port mappings.

Figure 51 Internet Connection Properties

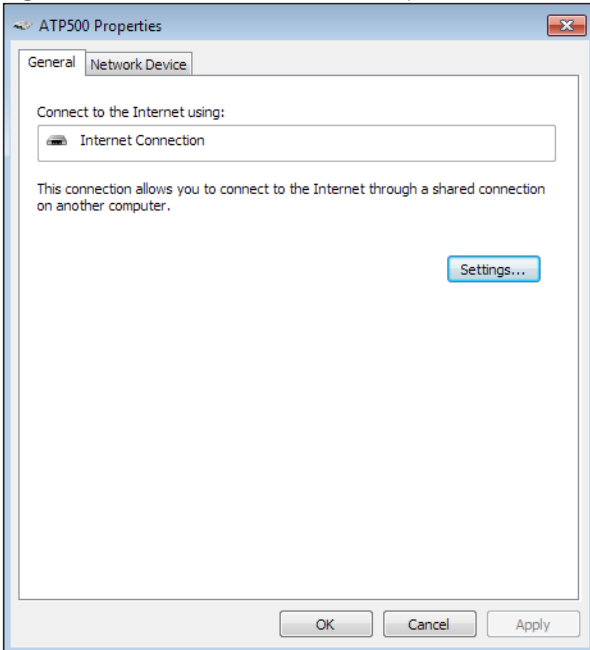

- 4 You may edit or delete the port mappings or click **Add** to manually add port mappings.

Figure 52 Internet Connection Properties: Advanced Settings

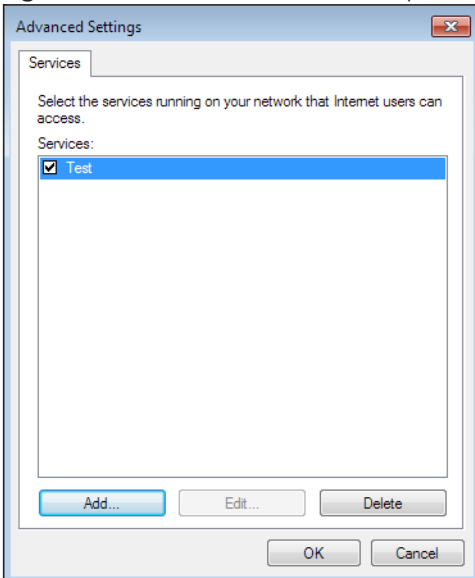
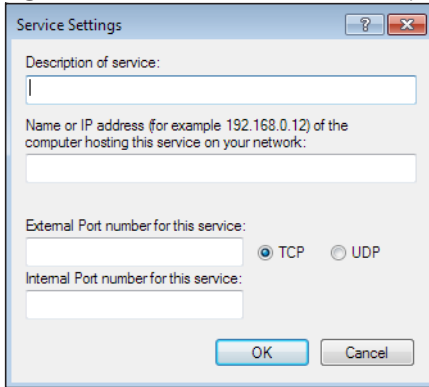

Figure 53 Internet Connection Properties: Advanced Settings: Add

Note: When the UPnP-enabled device is disconnected from your computer, all port mappings will be deleted automatically.

- 5 Click **OK**. Check the network icon on the system tray to see your Internet connection status.

Figure 54 System Tray Icon

- 6 To see more details about your current Internet connection status, right click the network icon in the system tray and click **Open Network and Sharing Center**. Click **Local Area Network**.

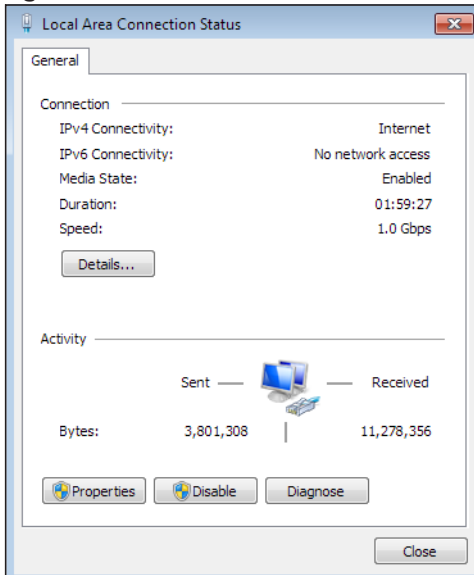
Figure 55 Internet Connection Status

8.4.3 Turn on UPnP in Windows 10 Example

This section shows you how to use the UPnP feature in Windows 10. UPnP server is installed in Windows 10. Activate UPnP on the EMG by clicking **Network Setting > Home Networking > UPnP**.

Make sure the computer is connected to the LAN port of the EMG. Turn on your computer and the EMG.

- 1 Click the start icon, **Settings** and then **Network & Internet**.

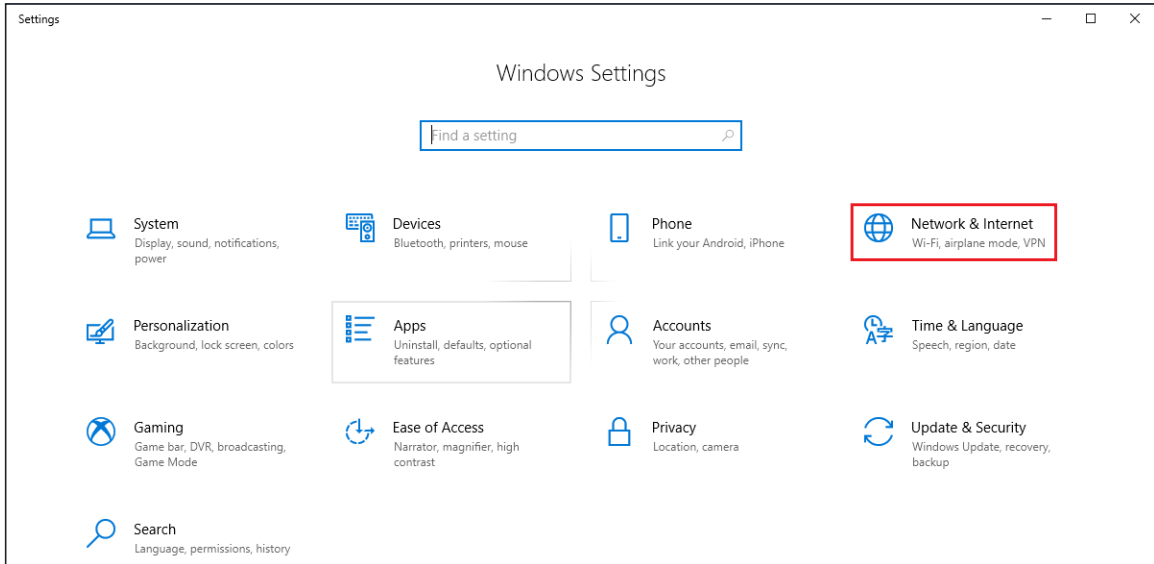

2 Click **Network and Sharing Center**.

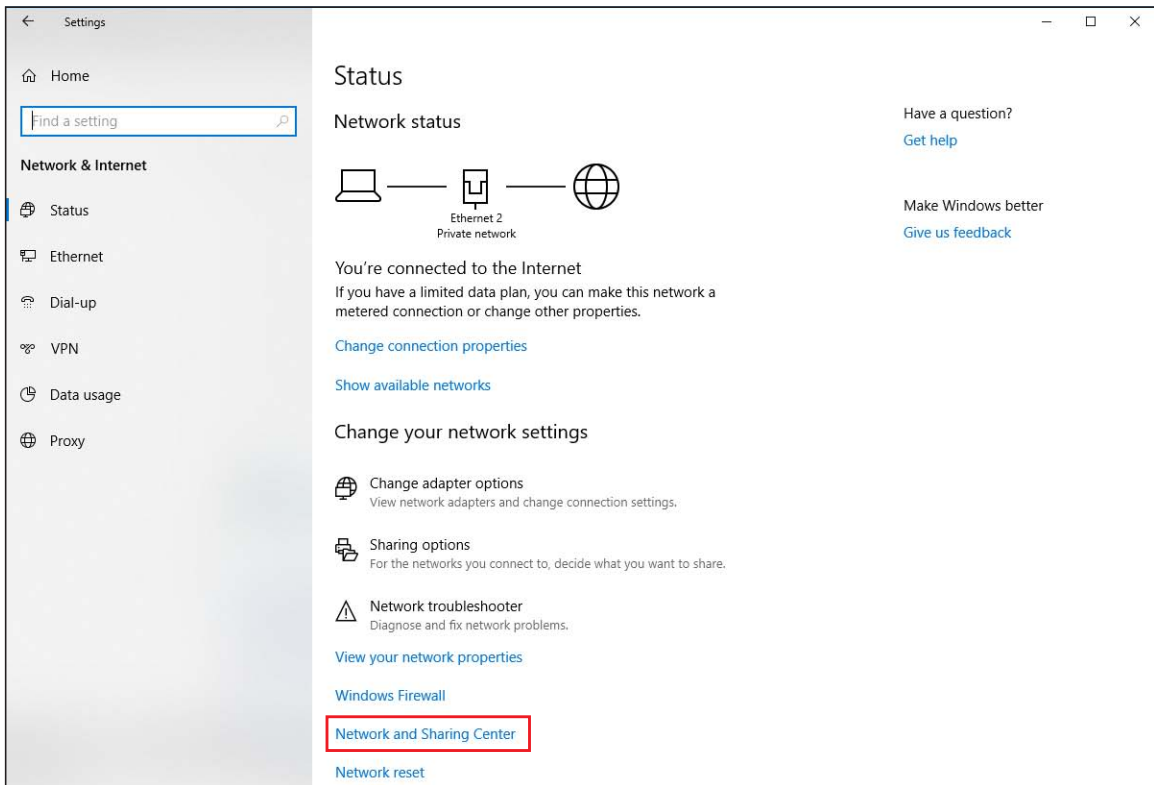

3 Click **Change advanced sharing settings**.

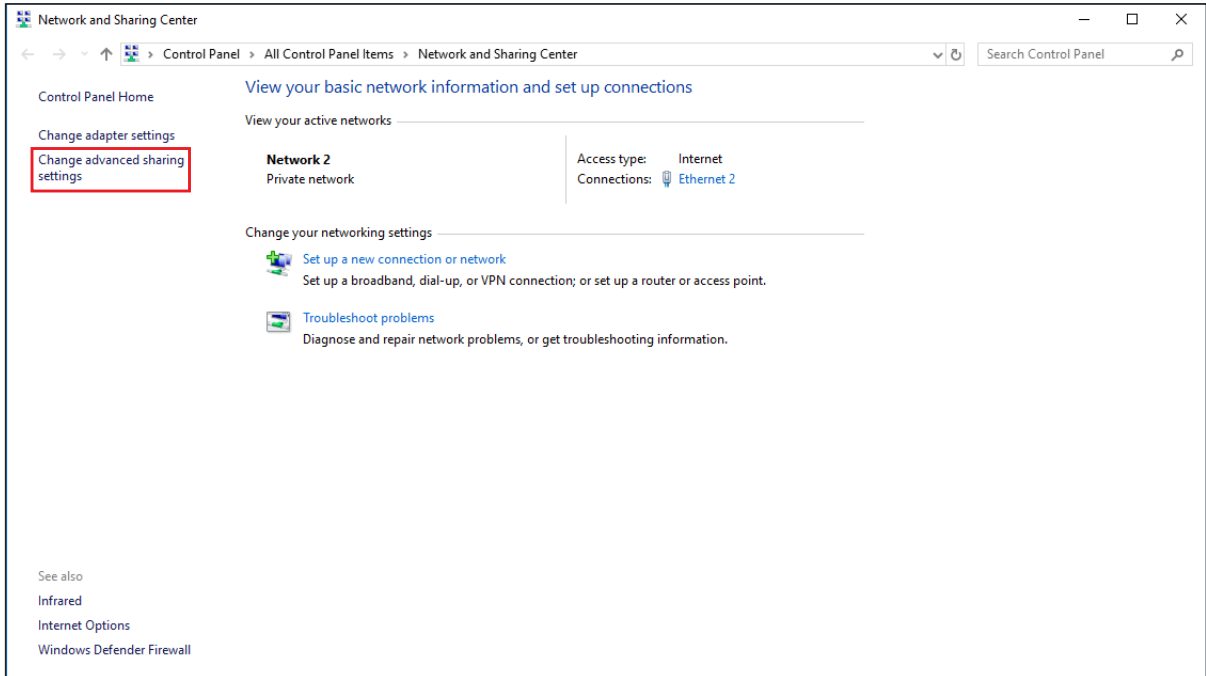

- 4 Under **Domain**, select **Turn on network discovery** and click **Save Changes**. Network discovery allows your computer to find other computers and devices on the network and other computers on the network to find your computer. This makes it easier to share files and printers.

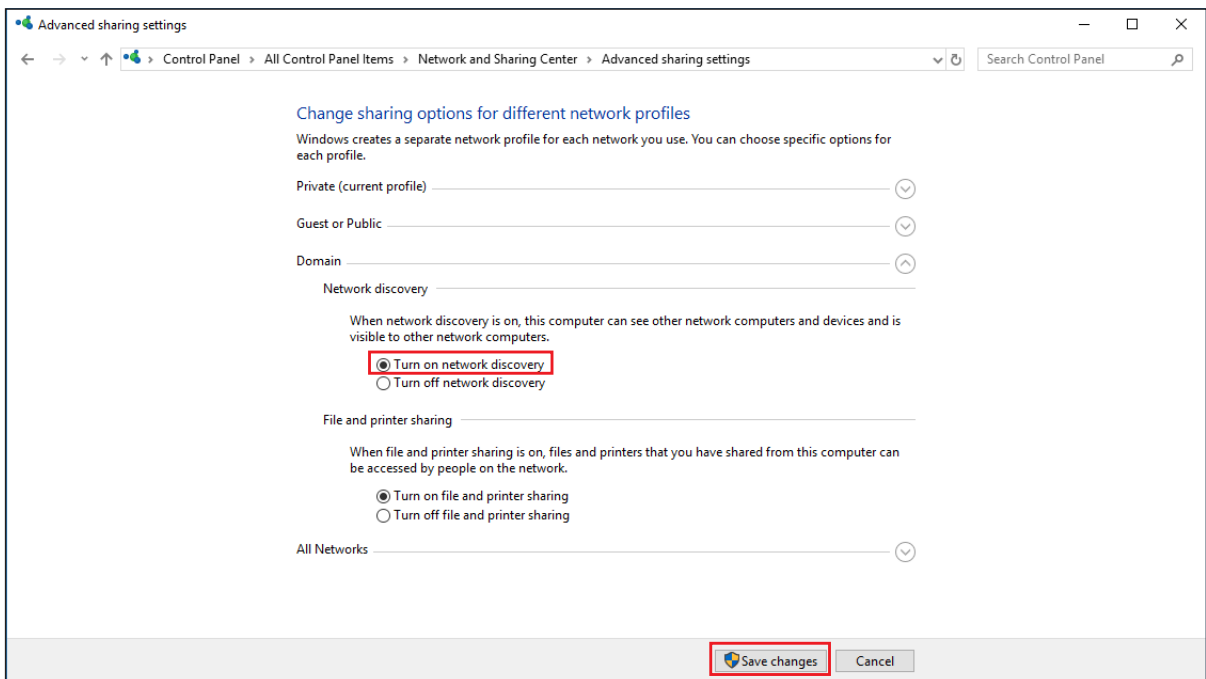

8.4.4 Auto-discover Your UPnP-enabled Network Device

Before you follow these steps, make sure you already have UPnP activated on the EMG and in your computer.

Make sure your computer is connected to the LAN port of the EMG.

- 1 Open **File Explorer** and click **Network**.
- 2 Right-click the EMG icon and select **Properties**.

Figure 56 Network Connections

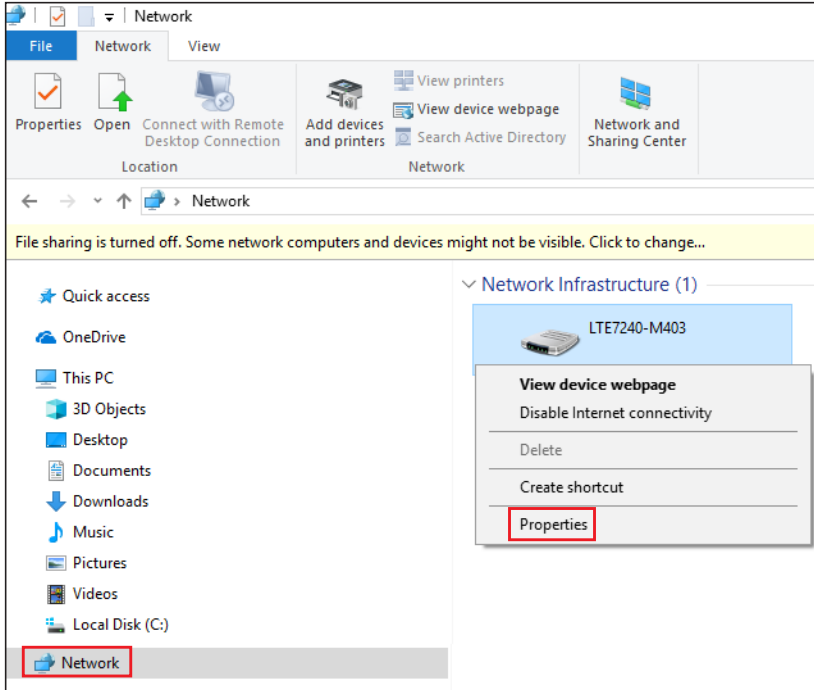

- 3 In the **Internet Connection Properties** window, click **Settings** to see port mappings.

Figure 57 Internet Connection Properties

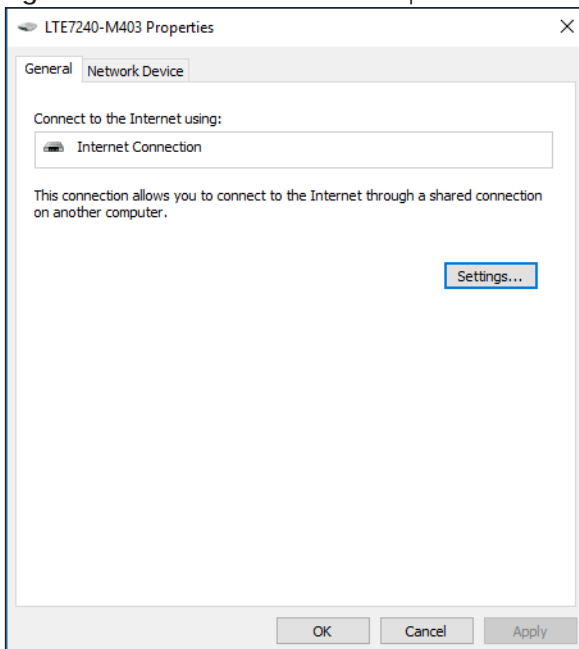

- 4 You may edit or delete the port mappings or click **Add** to manually add port mappings.

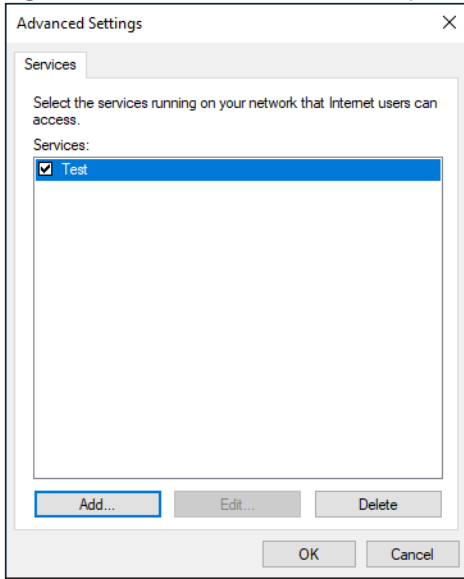
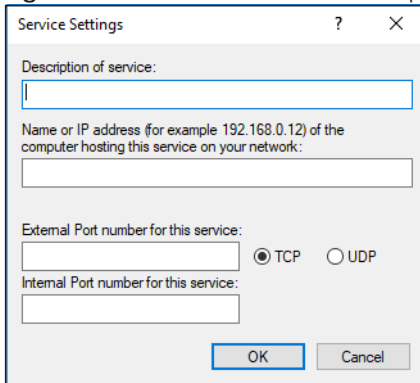
Figure 58 Internet Connection Properties: Advanced Settings**Figure 59** Internet Connection Properties: Advanced Settings: Add

Note: When the UPnP-enabled device is disconnected from your computer, all port mappings will be deleted automatically.

- 5 Click **OK**. Check the network icon on the system tray to see your Internet connection status.

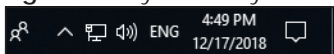
Figure 60 System Tray Icon

- 6 To see more details about your current Internet connection status, right click the network icon in the system tray and click **Open Network & Internet settings**. Click **Network and Sharing Center** and click the **Connections**.

Figure 61 Internet Connection Status

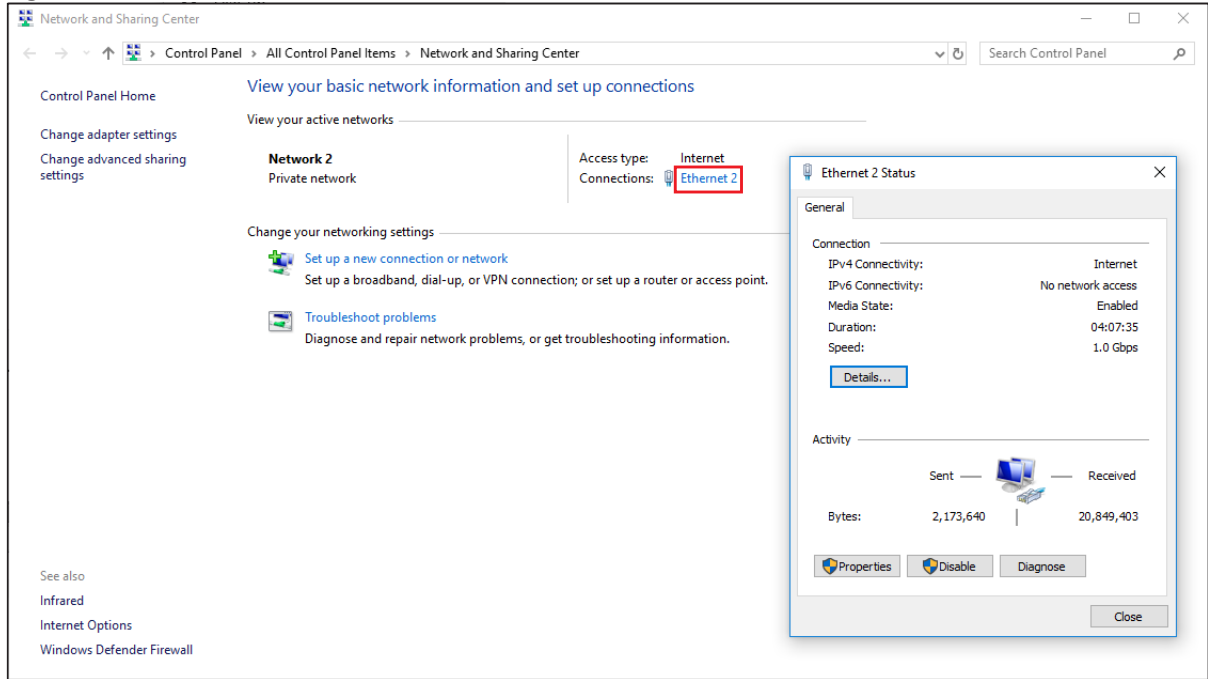

8.4.5 Web Configurator Easy Access in Windows 7

With UPnP, you can access the Web-based Configurator on the EMG without needing to find out the IP address of the EMG first. This comes helpful if you do not know the IP address of the EMG.

Follow the steps below to access the Web Configurator.

- 1 Open **Windows Explorer**.
- 2 Click **Network**.

Figure 62 Network Connections

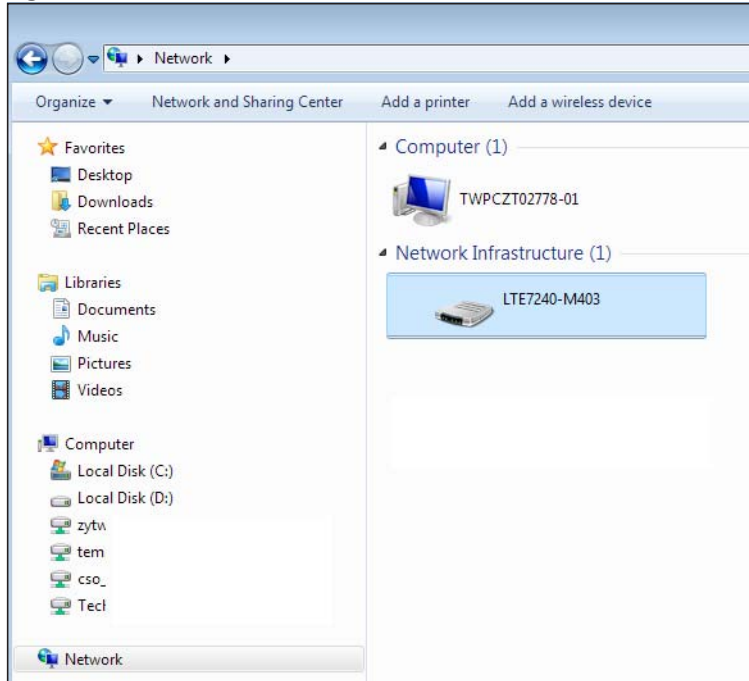

- 3 An icon with the description for each UPnP-enabled device displays under **Network Infrastructure**.
- 4 Right-click the icon for your EMG and select **View device webpage**. The Web Configurator login screen displays.

Figure 63 Network Connections: My Network Places

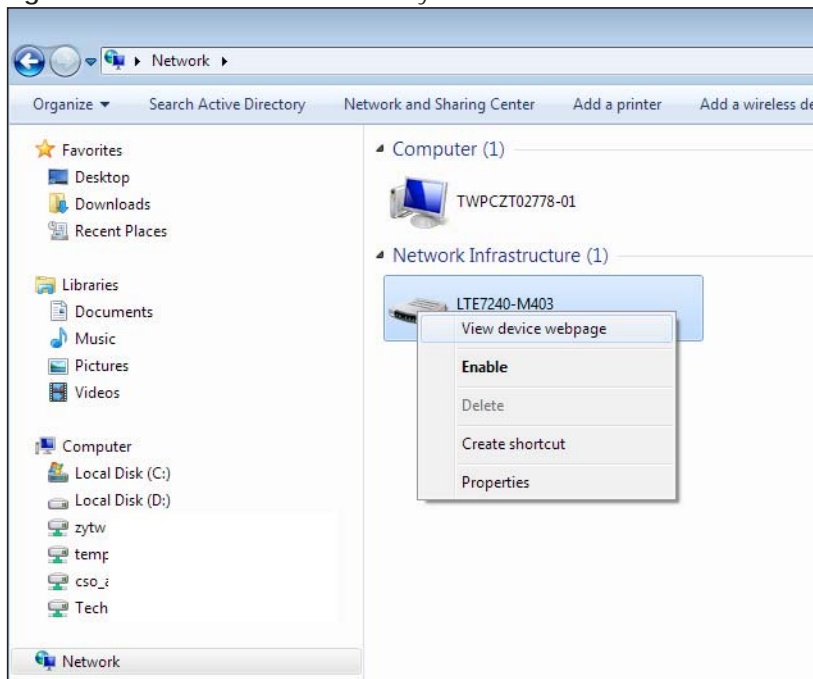

- 5 Right-click the icon for your EMG and select **Properties**. Click the **Network Device** tab. A window displays with information about the EMG.

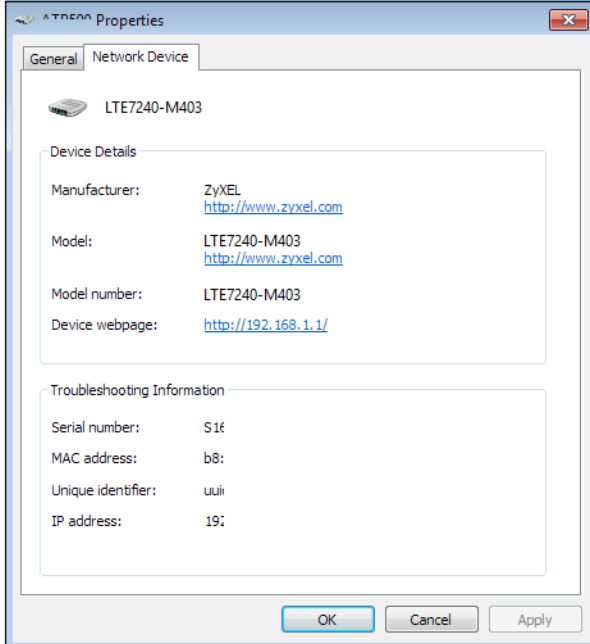
Figure 64 Network Connections: My Network Places: Properties: Example

8.4.6 Web Configurator Easy Access in Windows 10

Follow the steps below to access the Web Configurator.

- 1 Open **File Explorer**.
- 2 Click **Network**.

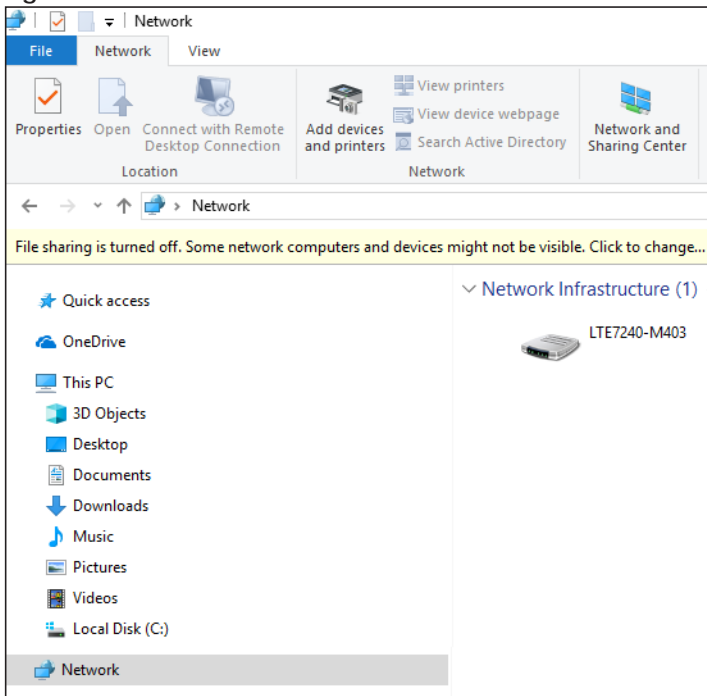
Figure 65 Network Connections

- 3 An icon with the description for each UPnP-enabled device displays under **Network Infrastructure**.
- 4 Right-click the icon for your EMG and select **View device webpage**. The Web Configurator login screen displays.

Figure 66 Network Connections: Network Infrastructure

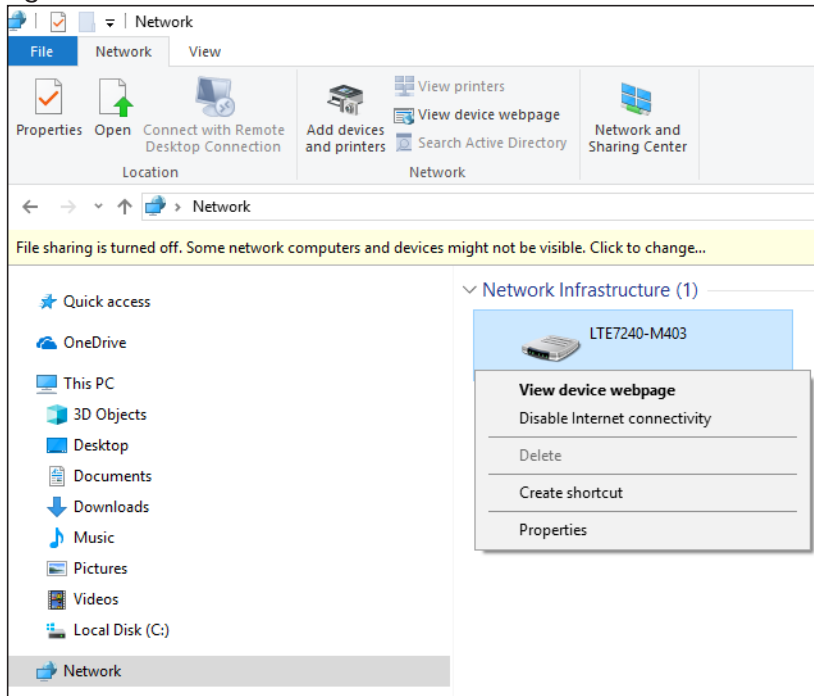

- 5 Right-click the icon for your EMG and select **Properties**. Click the **Network Device** tab. A window displays information about the EMG.

Figure 67 Network Connections: Network Infrastructure: Properties: Example

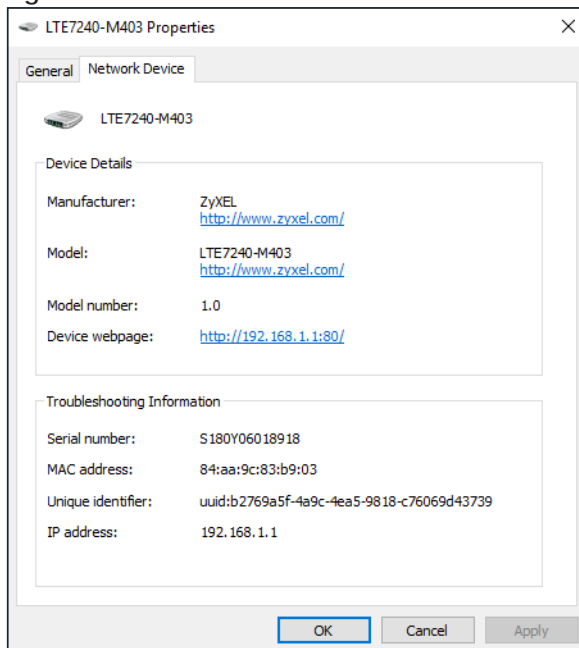

8.5 The Additional Subnet Screen

Use the **Additional Subnet** screen to configure IP alias and public static IP.

IP alias allows you to partition a physical network into different logical networks over the same Ethernet interface. The EMG supports multiple logical LAN interfaces via its physical Ethernet interface with the EMG itself as the gateway for the LAN network. When you use IP alias, you can also configure firewall rules to control access to the LAN's logical network (subnet).

If your ISP provides the Public LAN service, the EMG may use an LAN IP address that can be accessed from the WAN.

Click **Network Setting > Home Networking > Additional Subnet** to display the screen shown next.

Figure 68 Network Setting > Home Networking > Additional Subnet

The following table describes the labels in this screen.

Table 28 Network Setting > Home Networking > Additional Subnet

LABEL	DESCRIPTION
IP Alias Setup	
Group Name	Select the interface group name for which you want to configure the IP alias settings. See Chapter 15 on page 179 for how to create a new interface group.
Active	Select Enable to configure a LAN network for the EMG.
IPv4 Address	Enter the IP address of your EMG in dotted decimal notation.
Subnet Mask	Enter the subnet mask of your network in dotted decimal notation, for example 255.255.255.0 (factory default).
Public LAN	
Active	Select Enable to enable the Public LAN feature. Your ISP must support Public LAN and Static IP.
IPv4 Address	Enter the public IP address provided by your ISP.
Subnet Mask	Enter the public IPv4 subnet mask provided by your ISP.
Offer Public IP by DHCP	Select Enable to enable the EMG to provide public IP addresses by DHCP server.
Enable ARP Proxy	Select Enable to enable the ARP (Address Resolution Protocol) proxy.
Apply	Click Apply to save your changes.
Cancel	Click Cancel to exit this screen without saving.

8.6 The STB Vendor ID Screen

Set Top Box (STB) devices with dynamic IP addresses sometimes don't renew their IP addresses before the lease time expires. This could lead to IP address conflicts if the STB continues to use an IP address that gets assigned to another device. Use this screen to configure the Vendor IDs of connected STBs, which have the EMG automatically created static DHCP entries for them when they request IP addresses.

Click **Network Setting** > **Home Networking** > **STB Vendor ID** to open this screen.

Figure 69 Network Setting > Home Networking > STB Vendor ID

Please enter Vendor ID for STB.

Vendor ID 1:

Vendor ID 2:

Vendor ID 3:

Vendor ID 4:

Vendor ID 5:

The following table describes the labels in this screen.

Table 29 Network Setting > Home Networking > STB Vendor ID

LABEL	DESCRIPTION
Vendor ID 1~5	These are STB's Vendor Class Identifiers (DHCP option 60). A Vendor Class Identifier is usually used to inform the DHCP server a DHCP client's vendor and functionality.
Apply	Click Apply to save your changes.
Cancel	Click Cancel to exit this screen without saving.

8.7 The Wake on LAN Screen

Use this screen to turn on a device on the LAN network. To use this feature, the remote device must also support Wake On LAN.

You need to know the MAC address of the LAN device. It may be on a label on the device or in its documentation.

Click **Network Setting** > **Home Networking** > **Wake on LAN** to open this screen.

Figure 70 Network Setting > Home Networking > Wake on LAN

Wake by Address:

IP Address:

MAC Address:

The following table describes the labels in this screen.

Table 30 Network Setting > Home Networking > Wake on LAN

LABEL	DESCRIPTION
Wake by Address	Select Manual and enter the IP address or MAC address of the device to turn it on remotely. The drop-down list also lists the IP addresses that can be found in the EMG's ARP table. Select an IP address and it will then automatically update the IP address and MAC address in the following fields.
IP Address	Enter the IPv4 IP address of the device to turn it on.
MAC Address	Enter the MAC address of the device to turn it on. A MAC address consists of six hexadecimal character pairs.
Wake up	Click this to send a wake up packet to wake up the specified device.

8.8 The TFTP Server Name Screen

Use the **TFTP Server Name** screen to set the TFTP server address which is passed to the clients using DHCP option 66. The DHCP clients in the EMG local network, such as STB devices that support the TFTP booting mechanism, can then use the TFTP server address or domain name for initial system settings download. RFC 2132 defines the option 66 open standard. DHCP option 66 carries the IP address or the domain name of a single TFTP server.

Click **Network Setting > Home Networking > TFTP Server Name** to open this screen.

Figure 71 Network Setting > Home Networking > TFTP Server Name

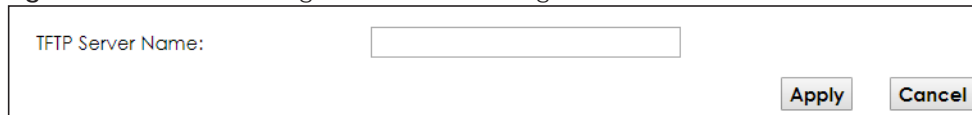

The following table describes the labels in this screen.

Table 31 Network Setting > Home Networking > TFTP Server Name

LABEL	DESCRIPTION
TFTP Server Name	Enter the IP address or the domain name of a single TFTP server.
Apply	Click Apply to save your changes.
Cancel	Click Cancel to exit this screen without saving.

8.9 Technical Reference

This section provides some technical background information about the topics covered in this chapter.

8.9.1 LANs, WANs and the EMG

The actual physical connection determines whether the EMG ports are LAN or WAN ports. There are two separate IP networks, one inside the LAN network and the other outside the WAN network as shown next.

Figure 72 LAN and WAN IP Addresses

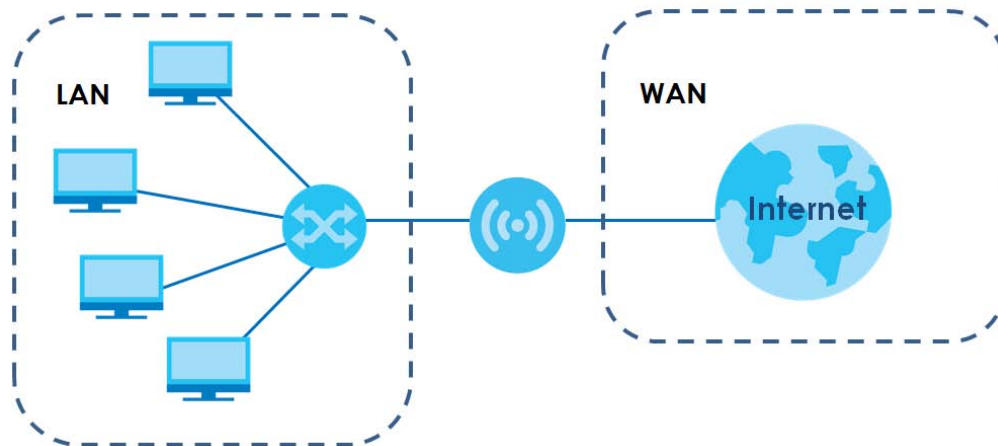

8.9.2 DHCP Setup

DHCP (Dynamic Host Configuration Protocol, RFC 2131 and RFC 2132) allows individual clients to obtain TCP/IP configuration at start-up from a server. You can configure the EMG as a DHCP server or disable it. When configured as a server, the EMG provides the TCP/IP configuration for the clients. If you turn DHCP service off, you must have another DHCP server on your LAN, or else the computer must be manually configured.

IP Pool Setup

The EMG is pre-configured with a pool of IP addresses for the DHCP clients (DHCP Pool). See the product specifications in the appendices. Do not assign static IP addresses from the DHCP pool to your LAN computers.

8.9.3 DNS Server Addresses

DNS (Domain Name System) maps a domain name to its corresponding IP address and vice versa. The DNS server is extremely important because without it, you must know the IP address of a computer before you can access it. The DNS server addresses you enter when you set up DHCP are passed to the client machines along with the assigned IP address and subnet mask.

There are two ways that an ISP disseminates the DNS server addresses.

- The ISP tells you the DNS server addresses, usually in the form of an information sheet, when you sign up. If your ISP gives you DNS server addresses, enter them in the **DNS Server** fields in the **DHCP Setup** screen.
- Some ISPs choose to disseminate the DNS server addresses using the DNS server extensions of IPCP (IP Control Protocol) after the connection is up. If your ISP did not give you explicit DNS servers, chances are the DNS servers are conveyed through IPCP negotiation. The EMG supports the IPCP DNS server extensions through the DNS proxy feature.

Please note that DNS proxy works only when the ISP uses the IPCP DNS server extensions. It does not mean you can leave the DNS servers out of the DHCP setup under all circumstances. If your ISP gives you explicit DNS servers, make sure that you enter their IP addresses in the **DHCP Setup** screen.

8.9.4 LAN TCP/IP

The EMG has built-in DHCP server capability that assigns IP addresses and DNS servers to systems that support DHCP client capability.

IP Address and Subnet Mask

Similar to the way houses on a street share a common street name, so too do computers on a LAN share one common network number.

Where you obtain your network number depends on your particular situation. If the ISP or your network administrator assigns you a block of registered IP addresses, follow their instructions in selecting the IP addresses and the subnet mask.

If the ISP did not explicitly give you an IP network number, then most likely you have a single user account and the ISP will assign you a dynamic IP address when the connection is established. If this is the case, it is recommended that you select a network number from 192.168.0.0 to 192.168.255.0 and you must enable the Network Address Translation (NAT) feature of the EMG. The Internet Assigned Number Authority (IANA) reserved this block of addresses specifically for private use; please do not use any other number unless you are told otherwise. Let's say you select 192.168.1.0 as the network number; which covers 254 individual addresses, from 192.168.1.1 to 192.168.1.254 (zero and 255 are reserved). In other words, the first three numbers specify the network number while the last number identifies an individual computer on that network.

Once you have decided on the network number, pick an IP address that is easy to remember, for instance, 192.168.1.1, for your EMG, but make sure that no other device on your network is using that IP address.

The subnet mask specifies the network number portion of an IP address. Your EMG will compute the subnet mask automatically based on the IP address that you entered. You don't need to change the subnet mask computed by the EMG unless you are instructed to do otherwise.

Private IP Addresses

Every machine on the Internet must have a unique address. If your networks are isolated from the Internet, for example, only between your two branch offices, you can assign any IP addresses to the hosts without problems. However, the Internet Assigned Numbers Authority (IANA) has reserved the following three blocks of IP addresses specifically for private networks:

- 10.0.0.0 — 10.255.255.255
- 172.16.0.0 — 172.31.255.255
- 192.168.0.0 — 192.168.255.255

You can obtain your IP address from the IANA, from an ISP or it can be assigned from a private network. If you belong to a small organization and your Internet access is through an ISP, the ISP can provide you with the Internet addresses for your local networks. On the other hand, if you are part of a much larger organization, you should consult your network administrator for the appropriate IP addresses.

Note: Regardless of your particular situation, do not create an arbitrary IP address; always follow the guidelines above. For more information on address assignment, please refer to RFC 1597, "Address Allocation for Private Internets" and RFC 1466, "Guidelines for Management of IP Address Space".

CHAPTER 9

Routing

9.1 Overview

The EMG usually uses the default gateway to route outbound traffic from computers on the LAN to the Internet. To have the EMG send data to devices not reachable through the default gateway, use static routes.

For example, the next figure shows a computer (**A**) connected to the EMG's LAN interface. The EMG routes most traffic from **A** to the Internet through the EMG's default gateway (**R1**). You create one static route to connect to services offered by your ISP behind router **R2**. You create another static route to communicate with a separate network behind a router **R3** connected to the LAN.

Figure 73 Example of Routing Topology

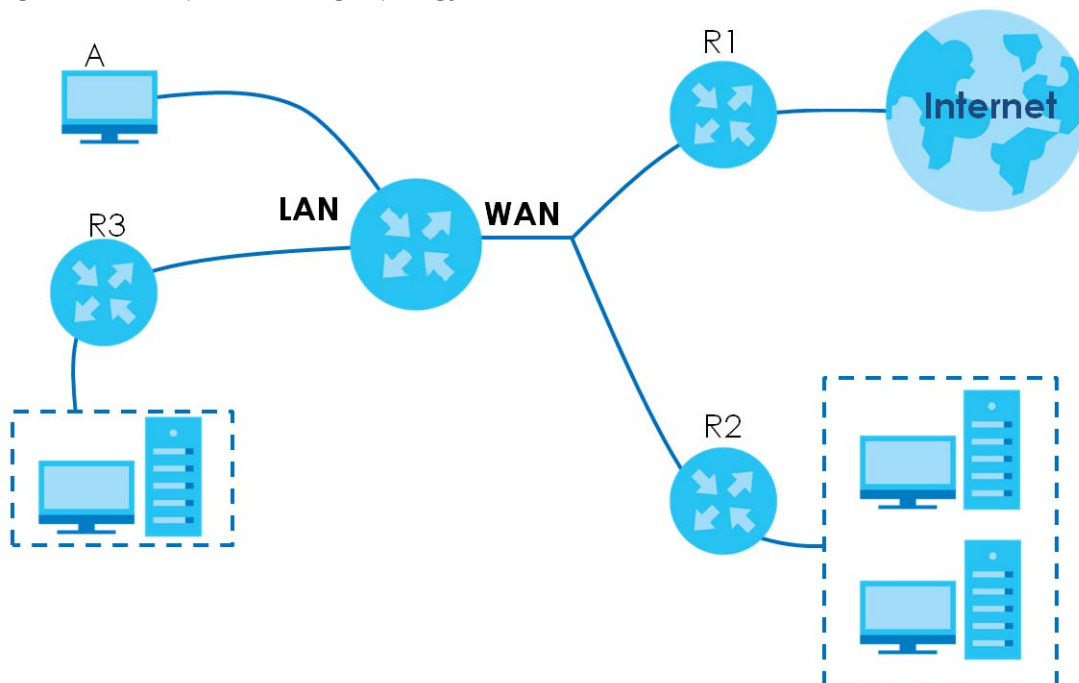

9.2 The Routing Screen

Use this screen to view and configure the static route rules on the EMG. Click **Network Setting > Routing > Static Route** to open the following screen.

Figure 74 Network Setting > Routing > Static Route

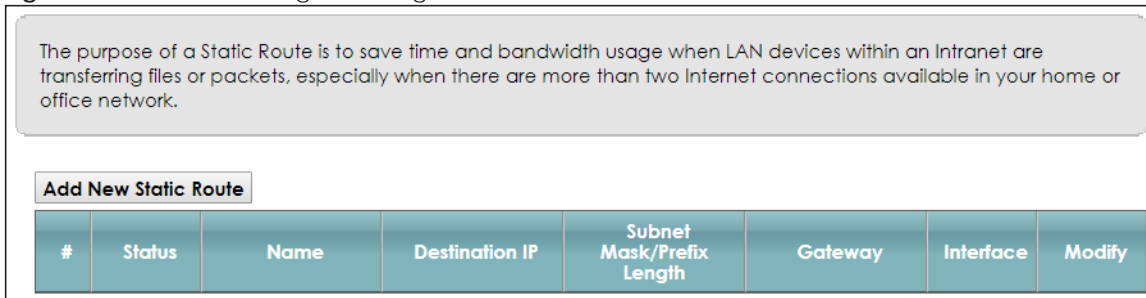

The following table describes the labels in this screen.

Table 32 Network Setting > Routing > Static Route

LABEL	DESCRIPTION
Add new static route	Click this to configure a new static route.
#	This is the index number of the entry.
Status	This field displays whether the static route is active or not. A yellow bulb signifies that this route is active. A gray bulb signifies that this route is not active.
Name	This is the name that describes or identifies this route.
Destination IP	This parameter specifies the IP network address of the final destination. Routing is always based on network number.
Subnet Mask/Prefix Length	This parameter specifies the IP network subnet mask of the final destination.
Gateway	This is the IP address of the gateway. The gateway is a router or switch on the same network segment as the device's LAN or WAN port. The gateway helps forward packets to their destinations.
Interface	This is the WAN interface used for this static route.
Modify	Click the Edit icon to edit the static route on the EMG. Click the Delete icon to remove a static route from the EMG. A window displays asking you to confirm that you want to delete the route.

9.2.1 Add/Edit Static Route

Use this screen to add or edit a static route. Click **Add new static route** in the **Routing** screen or the **Edit** icon next to the static route you want to edit. The screen shown next appears.

Figure 75 Routing: Add/Edit

The following table describes the labels in this screen.

Table 33 Routing: Add/Edit

LABEL	DESCRIPTION
Active	This field allows you to activate/deactivate this static route. Select Enable to activate the static route. Select Disable to deactivate this static route without having to delete the entry.
Route Name	Enter a descriptive name for the static route.
IP Type	Select whether your IP type is IPv4 or IPv6 .
Destination IP Address	Enter the IPv4 or IPv6 network address of the final destination.
IP Subnet Mask	If you are using IPv4 and need to specify a route to a single host, use a subnet mask of 255.255.255.255 in the subnet mask field to force the network number to be identical to the host ID. Enter the IP subnet mask here.
Use Gateway IP Address	The gateway is a router or switch on the same network segment as the device's LAN or WAN port. The gateway helps forward packets to their destinations. If you want to use the gateway IP address, select Enable .
Gateway IP Address	Enter the IP address of the gateway.
Use Interface	Select the WAN interface you want to use for this static route.
OK	Click OK to save your changes.
Cancel	Click Cancel to exit this screen without saving.

9.3 The DNS Route Screen

Use this screen to view and configure DNS routes on the EMG. Click **Network Setting > Routing > DNS Route** to open the following screen.

Figure 76 Network Setting > Routing > DNS Route

A DNS route entry defines a policy for the device to forward particular DNS query to a specific WAN interface.

Add New DNS Route

#	Status	Domain Name	WAN Interface	Subnet Mask	Modify
---	--------	-------------	---------------	-------------	--------

Note
Maximum of 20 entries can be added.

The following table describes the labels in this screen.

Table 34 Network Setting > Routing > DNS Route

LABEL	DESCRIPTION
Add New DNS Route	Click this to add a new DNS route.
#	This is the index number of a DNS route.
Status	This field displays whether the DNS route is active or not. A yellow bulb signifies that this DNS route is active. A gray bulb signifies that this DNS route is not active.
Domain Name	This is the host name or domain name of the DNS route entry.
WAN Interface	This is the WAN connection through which the EMG forwards DNS requests for this domain name.
Subnet Mask	This is the subnet mask of the DNS route entry.
Modify	Click the Edit icon to modify the DNS route. Click the Delete icon to delete the DNS route.

9.3.1 The DNS Route Add Screen

You can manually add the EMG's DNS route entry. Click **Add New DNS Route** in the **Network Setting > Routing > DNS Route** screen. The screen shown next appears.

Figure 77 DNS Route Add

Add New DNS Route

Active Enable Disable

Domain Name :

Subnet Mask :

WAN Interface :

OK Cancel

The following table describes the labels in this screen.

Table 35 DNS Route Add

LABEL	DESCRIPTION
Active	Select to enable or disable this DNS route.
Domain Name	Enter the domain name of the DNS route entry.
Subnet Mask	Enter the subnet mask of the DNS route entry.
WAN Interface	Select the WAN connection through which the EMG forwards DNS requests for this domain name.
OK	Click this to save your changes.
Cancel	Click this to exit this screen without saving any changes.

9.4 The Policy Route Screen

Traditionally, routing is based on the destination address only and the EMG takes the shortest path to forward a packet. Policy route allows the EMG to override the default routing behavior and alter the packet forwarding based on the policy defined by the network administrator. Policy-based routing is applied to outgoing packets, prior to the normal routing.

You can use source-based policy forwarding to direct traffic from different users through different connections or distribute traffic among multiple paths for load sharing.

The **Policy Route** screen let you view and configure routing policies on the EMG. Click **Network Setting > Routing > Policy Route** to open the following screen.

Figure 78 Network Setting > Routing > Policy Route

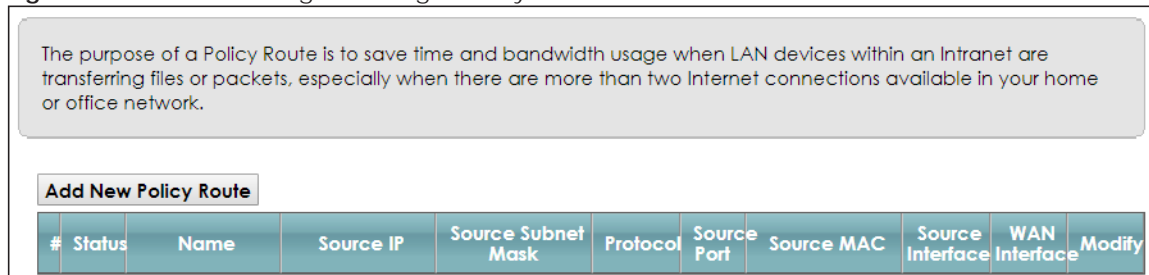

The following table describes the labels in this screen.

Table 36 Network Setting > Routing > Policy Route

LABEL	DESCRIPTION
Add New Policy Route	Click this to create a new policy forwarding rule.
#	This is the index number of the entry.
Status	This field displays whether the DNS route is active or not. A yellow bulb signifies that this DNS route is active. A gray bulb signifies that this DNS route is not active.
Name	This is the name of the rule.
Source IP	This is the source IP address.
Source Subnet Mask	This is the source subnet mask address.

Table 36 Network Setting > Routing > Policy Route (continued)

LABEL	DESCRIPTION
Protocol	This is the transport layer protocol.
Source Port	This is the source port number.
Source MAC	This is the source MAC address.
Source Interface	This is the interface from which the matched traffic is sent.
WAN Interface	This is the WAN interface through which the traffic is routed.
Modify	Click the Edit icon to edit this policy. Click the Delete icon to remove a policy from the EMG. A window displays asking you to confirm that you want to delete the policy.

9.4.1 Add/Edit Policy Route

Click **Add New Policy Route** in the **Policy Route** screen or click the **Edit** icon next to a policy. Use this screen to configure the required information for a policy route.

Figure 79 Policy Route: Add/Edit

The following table describes the labels in this screen.

Table 37 Policy Route: Add/Edit (Sheet 1 of 2)

LABEL	DESCRIPTION
Active	Select to enable or disable this policy route.
Route Name	Enter a descriptive name of up to 8 printable English keyboard characters, not including spaces.
Source IP Address	Enter the source IP address.
Source Subnet Mask	Enter the source subnet mask address.
Protocol	Select the transport layer protocol (TCP or UDP).
Source Port	Enter the source port number.
Source MAC	Enter the source MAC address.

Table 37 Policy Route: Add/Edit (Sheet 2 of 2)

LABEL	DESCRIPTION
Source Interface	Type the name of the interface from which the matched traffic is sent.
WAN Interface	Select a WAN interface through which the traffic is sent. You must have the WAN interface(s) already configured in the Broadband screens.
OK	Click OK to save your changes.
Cancel	Click Cancel to exit this screen without saving.

9.5 RIP

Routing Information Protocol (RIP, RFC 1058 and RFC 1389) allows a device to exchange routing information with other routers.

9.5.1 The RIP Screen

Click **Network Setting > Routing > RIP** to open the **RIP** screen.

Figure 80 RIP

To activate RIP for the WAN Interface, select the desired RIP version and operation and place a check in the Enabled checkbox. To stop RIP on the WAN Interface, uncheck the Enabled checkbox. Click the Apply button to start/stop RIP and save the configuration.

#	Interface	Version	Operation	Enable	Disable Default Gateway
1	Default	2 ▼	Active ▼	<input type="checkbox"/>	<input type="checkbox"/>
2	ADSL	2 ▼	Active ▼	<input type="checkbox"/>	<input type="checkbox"/>
3	VDSL	2 ▼	Active ▼	<input type="checkbox"/>	<input type="checkbox"/>
4	ETHWAN	2 ▼	Active ▼	<input type="checkbox"/>	<input type="checkbox"/>

The following table describes the labels in this screen.

Table 38 RIP

LABEL	DESCRIPTION
#	This is the index of the interface in which the RIP setting is used.
Interface	This is the name of the interface in which the RIP setting is used.
Version	The RIP version controls the format and the broadcasting method of the RIP packets that the EMG sends (it recognizes both formats when receiving). RIP version 1 is universally supported but RIP version 2 carries more information. RIP version 1 is probably adequate for most networks, unless you have an unusual network topology.
Operation	Select Passive to have the EMG update the routing table based on the RIP packets received from neighbors but not advertise its route information to other routers in this interface. Select Active to have the EMG advertise its route information and also listen for routing updates from neighboring routers.
Enable	Select the check box to activate the settings.

Table 38 RIP

LABEL	DESCRIPTION
Disable Default Gateway	Select the check box to set the EMG to not send the route information to the default gateway.
Apply	Click Apply to save your changes back to the EMG.
Cancel	Click Cancel to restore your previously saved settings.

CHAPTER 10

Quality of Service (QoS)

10.1 Overview

Quality of Service (QoS) refers to both a network's ability to deliver data with minimum delay, and the networking methods used to control the use of bandwidth. Without QoS, all traffic data is equally likely to be dropped when the network is congested. This can cause a reduction in network performance and make the network inadequate for time-critical application such as video-on-demand.

Configure QoS on the EMG to group and prioritize application traffic and fine-tune network performance. Setting up QoS involves these steps:

- 1 Configure classifiers to sort traffic into different flows.
- 2 Assign priority and define actions to be performed for a classified traffic flow.

The EMG assigns each packet a priority and then queues the packet accordingly. Packets assigned a high priority are processed more quickly than those with low priority if there is congestion, allowing time-sensitive applications to flow more smoothly. Time-sensitive applications include both those that require a low level of latency (delay) and a low level of jitter (variations in delay) such as Voice over IP (VoIP) or Internet gaming, and those for which jitter alone is a problem such as Internet radio or streaming video.

This chapter contains information about configuring QoS and editing classifiers.

10.1.1 What You Can Do in this Chapter

- Use the **General** screen to enable or disable QoS and set the upstream bandwidth ([Section 10.3 on page 136](#)).
- Use the **Queue Setup** screen to configure QoS queue assignment ([Section 10.4 on page 137](#)).
- Use the **Classification Setup** screen to add, edit or delete QoS classifiers ([Section 10.5 on page 140](#)).
- Use the **Shaper Setup** screen to limit outgoing traffic transmission rate on the selected interface ([Section 10.6 on page 144](#)).
- Use the **Policer Setup** screen to control incoming traffic transmission rate and bursts ([Section 10.7 on page 145](#)).
- Use the **Monitor** screen to view statistics of QoS on WAN/LAN interface and the status of queues ([Section 10.8 on page 147](#)).

10.2 What You Need to Know

The following terms and concepts may help as you read through this chapter.

QoS versus Cos

QoS is used to prioritize source-to-destination traffic flows. All packets in the same flow are given the same priority. CoS (class of service) is a way of managing traffic in a network by grouping similar types of traffic together and treating each type as a class. You can use CoS to give different priorities to different packet types.

CoS technologies include IEEE 802.1p layer 2 tagging and DiffServ (Differentiated Services or DS). IEEE 802.1p tagging makes use of three bits in the packet header, while DiffServ is a new protocol and defines a new DS field, which replaces the eight-bit ToS (Type of Service) field in the IP header.

Tagging and Marking

In a QoS class, you can configure whether to add or change the DSCP (DiffServ Code Point) value, IEEE 802.1p priority level and VLAN ID number in a matched packet. When the packet passes through a compatible network, the networking device, such as a backbone switch, can provide specific treatment or service based on the tag or marker.

Traffic Shaping

Bursty traffic may cause network congestion. Traffic shaping regulates packets to be transmitted with a pre-configured data transmission rate using buffers (or queues). Your EMG uses the Token Bucket algorithm to allow a certain amount of large bursts while keeping a limit at the average rate.

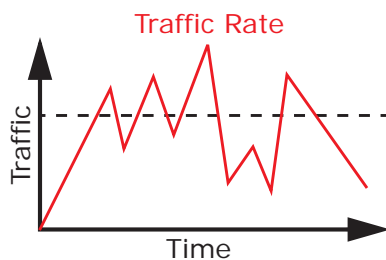

(Before Traffic Shaping)

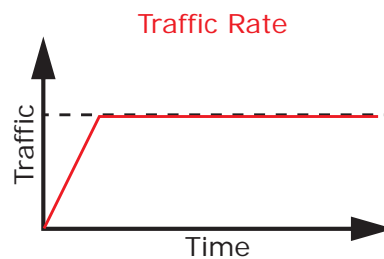

(After Traffic Shaping)

Traffic Policing

Traffic policing is the limiting of the input or output transmission rate of a class of traffic on the basis of user-defined criteria. Traffic policing methods measure traffic flows against user-defined criteria and identify it as either conforming, exceeding or violating the criteria.

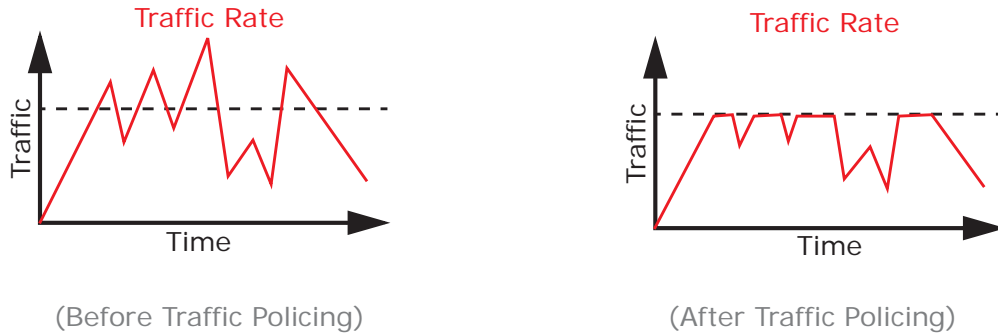

The EMG supports three incoming traffic metering algorithms: Token Bucket Filter (TBF), Single Rate Two Color Marker (srTCM), and Two Rate Two Color Marker (trTCM). You can specify actions which are performed on the colored packets. See [Section 10.9 on page 148](#) for more information on each metering algorithm.

10.3 The Quality of Service General Screen

Click **Network Setting > QoS > General** to open the screen as shown next.

Use this screen to enable or disable QoS and set the upstream bandwidth. See [Section 10.1 on page 134](#) for more information.

Figure 81 Network Settings > QoS > General

QoS Enable Disable (Settings are invalid when disabled)

WAN Managed Upstream Bandwidth : (kbps)

LAN Managed Downstream Bandwidth : (kbps)

Upstream Traffic Priority Assigned by:

Note

1. You can assign the upstream bandwidth manually. If the field is empty, the CPE set the value automatically.
2. If Upstream Traffic Priority is selected, 8 level strict priority QoS will be applied automatically according to the selected criteria. In this mode, user manually defined QoS will not be applied until Auto-Priority Mapping is disabled.
3. If the setting of WAN managed upstream bandwidth is greater than current WAN interface linkup rate, then the WAN managed upstream bandwidth will become current WAN interface linkup rate.

The following table describes the labels in this screen.

Table 39 Network Setting > QoS > General

LABEL	DESCRIPTION
QoS	Select the Enable check box to turn on QoS to improve your network performance.
WAN Managed Upstream Bandwidth	<p>Enter the amount of upstream bandwidth for the WAN interfaces that you want to allocate using QoS.</p> <p>The recommendation is to set this speed to match the interfaces' actual transmission speed. For example, set the WAN interfaces' speed to 100000 kbps if your Internet connection has an upstream transmission speed of 100 Mbps.</p> <p>You can also set this number lower than the interfaces' actual transmission speed. This will cause the EMG to not use some of the interfaces' available bandwidth.</p> <p>If you leave this field blank, the EMG automatically sets this number to be 95% of the WAN interfaces' actual upstream transmission speed.</p>
LAN Managed Downstream Bandwidth	<p>Enter the amount of downstream bandwidth for the LAN interfaces (including WLAN) that you want to allocate using QoS.</p> <p>The recommendation is to set this speed to match the WAN interfaces' actual transmission speed. For example, set the LAN managed downstream bandwidth to 100000 kbps if you use a 100 Mbps wired Ethernet WAN connection.</p> <p>You can also set this number lower than the WAN interfaces' actual transmission speed. This will cause the EMG to not use some of the interfaces' available bandwidth.</p> <p>If you leave this field blank, the EMG automatically sets this to the LAN interfaces' maximum supported connection speed.</p>
Upstream Traffic Priority Assigned by	<p>Select how the EMG assigns priorities to various upstream traffic flows.</p> <ul style="list-style-type: none"> • None: Disables auto priority mapping and has the EMG put packets into the queues according to your classification rules. Traffic which does not match any of the classification rules is mapped into the default queue with the lowest priority. • Ethernet Priority: Automatically assign priority based on the IEEE 802.1p priority level. • IP Precedence: Automatically assign priority based on the first three bits of the TOS field in the IP header. • Packet Length: Automatically assign priority based on the packet size. Smaller packets get higher priority since control, signaling, VoIP, internet gaming, or other real-time packets are usually small while larger packets are usually best effort data packets like file transfers.
Apply	Click Apply to save your changes.
Cancel	Click Cancel to restore your previously saved settings.

10.4 The Queue Setup Screen

Click **Network Setting > QoS > Queue Setup** to open the screen as shown next.

Use this screen to configure QoS queue assignment.

Figure 82 Network Setting > QoS > Queue Setup

Queue Setup decides the priority on WAN interfaces. Use this page to configure QoS queue assignment.

Add New Queue

#	Status	Name	Interface	Priority	Weight	Buffer Management	Rate Limit	Modify
1		default queue	WAN	8	1	DT		

Note

1. Maximum 7 configurable entries and 1 unconfigurable default queue for WAN port.
2. Priority level 1 is the highest priority for QoS.
3. Rate limit 0 is max bandwidth.
4. If queue is deleted, then related classifiers will be removed too.

The following table describes the labels in this screen.

Table 40 Network Setting > QoS > Queue Setup

LABEL	DESCRIPTION
Add New Queue	Click this button to create a new queue entry.
#	This is the index number of the entry.
Status	This field displays whether the queue is active or not. A yellow bulb signifies that this queue is active. A gray bulb signifies that this queue is not active.
Name	This shows the descriptive name of this queue.
Interface	This shows the name of the EMG's interface through which traffic in this queue passes.
Priority	This shows the priority of this queue.
Weight	This shows the weight of this queue.
Buffer Management	This shows the queue management algorithm used for this queue. Queue management algorithms determine how the EMG should handle packets when it receives too many (network congestion).
Rate Limit	This shows the maximum transmission rate allowed for traffic on this queue.
Modify	Click the Edit icon to edit the queue. Click the Delete icon to delete an existing queue. Note that subsequent rules move up by one when you take this action.

10.4.1 Adding a QoS Queue

Click **Add New Queue** or the edit icon in the **Queue Setup** screen to configure a queue.

Figure 83 Queue Setup: Add

The following table describes the labels in this screen.

Table 41 Queue Setup: Add

LABEL	DESCRIPTION
Active	Select to enable or disable this queue.
Name	Enter the descriptive name of this queue.
Interface	Select the interface to which this queue is applied. This field is read-only if you are editing the queue.
Priority	Select the priority level (from 1 to 7) of this queue. The smaller the number, the higher the priority level. Traffic assigned to higher priority queues gets through faster while traffic in lower priority queues is dropped if the network is congested.
Weight	Select the weight (from 1 to 8) of this queue. If two queues have the same priority level, the EMG divides the bandwidth across the queues according to their weights. Queues with larger weights get more bandwidth than queues with smaller weights.
Buffer Management	This field displays Drop Tail (DT) . Drop Tail (DT) is a simple queue management algorithm that allows the EMG buffer to accept as many packets as it can until it is full. Once the buffer is full, new packets that arrive are dropped until there is space in the buffer again (packets are transmitted out of it).
Rate Limit	Specify the maximum transmission rate (in Kbps) allowed for traffic on this queue.
OK	Click OK to save your changes.
Cancel	Click Cancel to exit this screen without saving.

10.5 The Classification Setup Screen

Use this screen to add, edit or delete QoS classifiers. A classifier groups traffic into data flows according to specific criteria such as the source address, destination address, source port number, destination port number or incoming interface. For example, you can configure a classifier to select traffic from the same protocol port (such as Telnet) to form a flow.

You can give different priorities to traffic that the EMG forwards out through the WAN interface. Give high priority to voice and video to make them run more smoothly. Similarly, give low priority to many large file downloads so that they do not reduce the quality of other applications.

Click **Network Setting > QoS > Classification Setup** to open the following screen.

Figure 84 Network Setting > QoS > Classification Setup

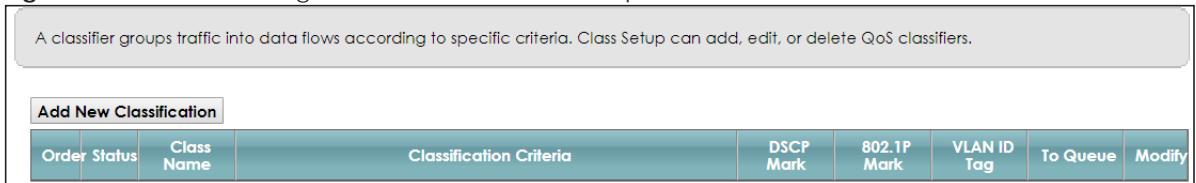

The following table describes the labels in this screen.

Table 42 Network Setting > QoS > Classification Setup

LABEL	DESCRIPTION
Add New Classification	Click this to create a new classifier.
Order	This is the index number of the entry. The classifiers are applied in order of their numbering.
Status	This field displays whether the classifier is active or not. A yellow bulb signifies that this classifier is active. A gray bulb signifies that this classifier is not active.
Class Name	This is the name of the classifier.
Classification Criteria	This shows criteria specified in this classifier, for example the interface from which traffic of this class should come and the source MAC address of traffic that matches this classifier.
DSCP Mark	This is the DSCP number added to traffic of this classifier.
802.1P Mark	This is the IEEE 802.1p priority level assigned to traffic of this classifier.
VLAN ID Tag	This is the VLAN ID number assigned to traffic of this classifier.
To Queue	This is the name of the queue in which traffic of this classifier is put.
Modify	Click the Edit icon to edit the classifier. Click the Delete icon to delete an existing classifier. Note that subsequent rules move up by one when you take this action.

10.5.1 Add/Edit QoS Class

Click **Add New Classification** in the **Classification Setup** screen or the **Edit** icon next to a classifier to open the following screen.

Figure 85 Classification Setup: Add/Edit

Add New Classification
✕

Please follow the guidance through step 1~5 to configure a QoS rule

Step1: Class Configuration

Active Enable Disable

Class Name

Classification Order: ▼

Step2: Criteria Configuration

Use the configurations below to specify the characteristics of a data flow needed to be managed by this QoS rule

Basic

From Interface ▼

Ether Type ▼

Source

<input type="checkbox"/> Address	<input type="text"/>	Subnet Mask	<input type="text"/>	<input type="checkbox"/> Exclude
<input type="checkbox"/> Port Range	<input type="text"/> ~ <input type="text"/>			<input type="checkbox"/> Exclude
<input type="checkbox"/> MAC	<input type="text"/> - - - - -	MAC Mask	<input type="text"/>	<input type="checkbox"/> Exclude

Destination

<input type="checkbox"/> Address	<input type="text"/>	Subnet Mask	<input type="text"/>	<input type="checkbox"/> Exclude
<input type="checkbox"/> Port Range	<input type="text"/> ~ <input type="text"/>			<input type="checkbox"/> Exclude
<input type="checkbox"/> MAC	<input type="text"/> - - - - -	MAC Mask	<input type="text"/>	<input type="checkbox"/> Exclude

Others

<input type="checkbox"/> Service	<input type="text" value="Age of Empires"/> ▼	<input type="checkbox"/> Exclude
<input type="checkbox"/> IP protocol	<input type="text" value="TCP"/> ▼ <input type="text"/>	<input type="checkbox"/> Exclude
<input type="checkbox"/> DHCP	<input type="text"/> ▼	<input type="checkbox"/> Exclude
<input type="checkbox"/> Packet Length	<input type="text"/> ~ <input type="text"/>	<input type="checkbox"/> Exclude
<input type="checkbox"/> DSCP	<input type="text"/> (0~63)	<input type="checkbox"/> Exclude
<input type="checkbox"/> 802.1P	<input type="text" value="0 BE"/> ▼	<input type="checkbox"/> Exclude
<input type="checkbox"/> VLAN ID	<input type="text"/> (1~4095)	<input type="checkbox"/> Exclude
<input type="checkbox"/> TCP ACK		<input type="checkbox"/> Exclude

Step3: Packet Modification

The content of the packet can be modified by applying the following settings

DSCP Mark ▼ (0~63)

802.1P Mark ▼

VLAN ID Tag ▼ (1~4095)

Step4: Class Routing

This module can route a packet to a certain interface according to the class setting

Forward To Interface ▼

Step5: Outgoing Queue Selection

Outgoing queue decides the priority of the traffic and how traffic should be shaped in the WAN interface.

To Queue Index: ▼

The following table describes the labels in this screen.

Table 43 Classification Setup: Add/Edit

LABEL	DESCRIPTION
Step1: Class Configuration	
Active	Select to enable or disable this classifier.
Class Name	Enter a descriptive name of up to 15 printable English keyboard characters, not including spaces.
Classification Order	Select an existing number for where you want to put this classifier to move the classifier to the number you selected after clicking Apply . Select Last to put this rule in the back of the classifier list.
Step2: Criteria Configuration	
Basic	
From Interface	If you want to classify the traffic by an ingress interface, select an interface from the From Interface drop-down list box.
Ether Type	Select a predefined application to configure a class for the matched traffic. If you select IP , you can configure source or destination MAC address, IP address, DHCP options, DSCP value or the protocol type. If you select 802.1Q , you can configure an 802.1p priority level. You can also select other options, such as ARP , PPPoE_DISC , and so on to make configurations according to your needs.
Source	
Address	Select the check box and enter the source IP address in dotted decimal notation. A blank source IP address means any source IP address.
Subnet Mask	Enter the source subnet mask.
Port Range	If you select TCP or UDP in the IP Protocol field, select the check box and enter the port number(s) of the source.
MAC	Select the check box and enter the source MAC address of the packet.
MAC Mask	Type the mask for the specified MAC address to determine which bits a packet's MAC address should match. Enter "f" for each bit of the specified source MAC address that the traffic's MAC address should match. Enter "0" for the bit(s) of the matched traffic's MAC address, which can be of any hexadecimal character(s). For example, if you set the MAC address to 00:13:49:00:00:00 and the mask to ff:ff:ff:00:00:00, a packet with a MAC address of 00:13:49:12:34:56 matches this criteria.
Exclude	Select this option to exclude the packets that match the specified criteria from this classifier.
Destination	
Address	Select the check box and enter the destination IP address in dotted decimal notation. A blank source IP address means any source IP address.
Subnet Mask	Enter the destination subnet mask.
Port Range	If you select TCP or UDP in the IP Protocol field, select the check box and enter the port number(s) of the destination.
MAC	Select the check box and enter the destination MAC address of the packet.
MAC Mask	Type the mask for the specified MAC address to determine which bits a packet's MAC address should match. Enter "f" for each bit of the specified destination MAC address that the traffic's MAC address should match. Enter "0" for the bit(s) of the matched traffic's MAC address, which can be of any hexadecimal character(s). For example, if you set the MAC address to 00:13:49:00:00:00 and the mask to ff:ff:ff:00:00:00, a packet with a MAC address of 00:13:49:12:34:56 matches this criteria.

Table 43 Classification Setup: Add/Edit (continued)

LABEL	DESCRIPTION
Exclude	Select this option to exclude the packets that match the specified criteria from this classifier.
Others	
Service	<p>This field is available only when you select IP in the Ether Type field.</p> <p>This field simplifies classifier configuration by allowing you to select a predefined application. When you select a predefined application, you do not configure the rest of the filter fields.</p>
IP Protocol	<p>This field is available only when you select IP in the Ether Type field.</p> <p>Select this option and select the protocol (service type) from TCP, UDP, ICMP or IGMP. If you select User defined, enter the protocol (service type) number.</p>
DHCP	<p>This field is available only when you select IP in the Ether Type field.</p> <p>Select this option and select a DHCP option.</p> <p>If you select Vendor Class ID (DHCP Option 60), enter the Vendor Class Identifier (Option 60) of the matched traffic, such as the type of the hardware or firmware.</p> <p>If you select Client ID (DHCP Option 61), enter the Identity Association Identifier (IAD Option 61) of the matched traffic, such as the MAC address of the device.</p> <p>If you select User Class ID (DHCP Option 77), enter a string that identifies the user's category or application type in the matched DHCP packets.</p> <p>If you select Vendor Specific Info (DHCP Option 125), enter the vendor specific information of the matched traffic, such as the product class, model name, and serial number of the device.</p>
IP Packet Length	<p>This field is available only when you select IP in the Ether Type field.</p> <p>Select this option and enter the minimum and maximum packet length (from 46 to 1500) in the fields provided.</p>
DSCP	<p>This field is available only when you select IP in the Ether Type field.</p> <p>Select this option and specify a DSCP (DiffServ Code Point) number between 0 and 63 in the field provided.</p>
802.1P	<p>This field is available only when you select 802.1Q in the Ether Type field.</p> <p>Select this option and select a priority level (between 0 and 7) from the drop-down list box. "0" is the lowest priority level and "7" is the highest.</p>
VLAN ID	<p>This field is available only when you select 802.1Q in the Ether Type field.</p> <p>Select this option and specify a VLAN ID number.</p>
TCP ACK	<p>This field is available only when you select IP in the Ether Type field.</p> <p>If you select this option, the matched TCP packets must contain the ACK (Acknowledge) flag.</p>
Exclude	Select this option to exclude the packets that match the specified criteria from this classifier.
Step3: Packet Modification	
DSCP Mark	<p>This field is available only when you select IP in the Ether Type field.</p> <p>If you select Remark, enter a DSCP value with which the EMG replaces the DSCP field in the packets.</p> <p>If you select Unchange, the EMG keep the DSCP field in the packets.</p>
802.1P Mark	<p>Select a priority level with which the EMG replaces the IEEE 802.1p priority field in the packets.</p> <p>If you select Unchange, the EMG keep the 802.1p priority field in the packets.</p>

Table 43 Classification Setup: Add/Edit (continued)

LABEL	DESCRIPTION
VLAN ID Tag	If you select Remark , enter a VLAN ID number with which the EMG replaces the VLAN ID of the frames. If you select Remove , the EMG deletes the VLAN ID of the frames before forwarding them out. If you select Add , the EMG treat all matched traffic untagged and add a second VLAN ID. If you select Unchange , the EMG keep the VLAN ID in the packets.
Step4: Class Routing	
Forward to Interface	Select a WAN interface through which traffic of this class will be forwarded out. If you select Unchange , the EMG forward traffic of this class according to the default routing table.
Step5: Outgoing Queue Selection	
To Queue Index	Select a queue that applies to this class. You should have configured a queue in the Queue Setup screen already.
OK	Click OK to save your changes.
Cancel	Click Cancel to exit this screen without saving.

10.6 The QoS Shaper Setup Screen

This screen shows that you can use the token bucket algorithm to allow a certain amount of large bursts while keeping a limit for processing outgoing traffic at the average rate. Click **Network Setting > QoS > Shaper Setup**. The screen appears as shown.

Figure 86 Network Setting > QoS > Shaper Setup

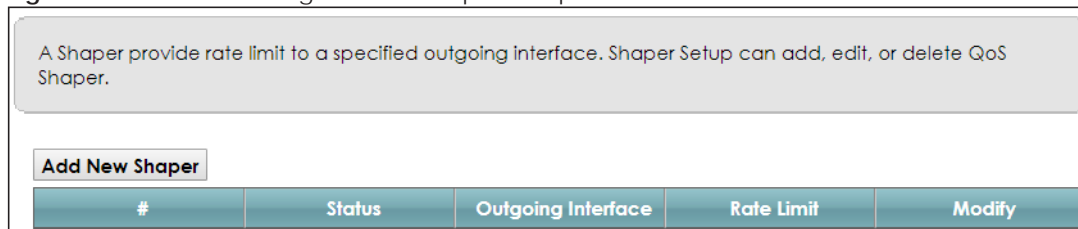

The following table describes the labels in this screen.

Table 44 Network Setting > QoS > Shaper Setup

LABEL	DESCRIPTION
Add New Shaper	Click this to create a new entry.
#	This is the index number of the entry.
Status	This field displays whether the shaper is active or not. A yellow bulb signifies that this policer is active. A gray bulb signifies that this shaper is not active.
Outgoing Interface	This shows the name of the EMG's interface through which traffic in this shaper applies.
Rate Limit (kbps)	This shows the average rate limit of traffic bursts for this shaper.
Modify	Click the Edit icon to edit the shaper. Click the Delete icon to delete an existing shaper. Note that subsequent rules move up by one when you take this action.

10.6.1 Add/Edit a QoS Shaper

Click **Add New Shaper** in the **Shaper Setup** screen or the **Edit** icon next to a shaper to show the following screen.

Figure 87 Shaper Setup: Add/Edit

The following table describes the labels in this screen.

Table 45 Shaper Setup: Add/Edit

LABEL	DESCRIPTION
Active	Select to enable or disable this shaper.
Interface	Select the EMG's interface through which traffic in this shaper applies
Rate Limit	Enter the average rate limit of traffic bursts for this shaper.
OK	Click OK to save your changes.
Cancel	Click Cancel to exit this screen without saving.

10.7 The QoS Policer Setup Screen

Use this screen to view QoS policers that allow you to limit the transmission rate of incoming traffic and apply actions, such as drop, pass, or modify the DSCP value for matched traffic. Click **Network Setting > QoS > Policer Setup**. The screen appears as shown.

Figure 88 Network Setting > QoS > Policer Setup

#	Status	Name	Regulated Classes	Meter Type	Rule	Action	Modify
---	--------	------	-------------------	------------	------	--------	--------

The following table describes the labels in this screen.

Table 46 Network Setting > QoS > Policer Setup

LABEL	DESCRIPTION
Add new Policer	Click this to create a new entry.
#	This is the index number of the entry.
Status	This field displays whether the policer is active or not. A yellow bulb signifies that this policer is active. A gray bulb signifies that this policer is not active.
Name	This field displays the descriptive name of this policer.
Regulated Classes	This field displays the name of a QoS classifier
Meter Type	This field displays the type of QoS metering algorithm used in this policer.
Rule	These are the rates and burst sizes against which the policer checks the traffic of the member QoS classes.
Action	This shows the how the policer has the EMG treat different types of traffic belonging to the policer's member QoS classes.
Modify	Click the Edit icon to edit the policer. Click the Delete icon to delete an existing policer. Note that subsequent rules move up by one when you take this action.

10.7.1 Add/Edit a QoS Policer

Click **Add New Policer** in the **Policer Setup** screen or the **Edit** icon next to a policer to show the following screen.

Figure 89 Policer Setup: Add/Edit

The following table describes the labels in this screen.

Table 47 Policer Setup: Add/Edit

LABEL	DESCRIPTION
Active	Select to enable or disable this policer.
Name	Enter the descriptive name of this policer.
Meter Type	This shows the traffic metering algorithm used in this policer. The Simple Token Bucket algorithm uses tokens in a bucket to control when traffic can be transmitted. Each token represents one byte. The algorithm allows bursts of up to b bytes which is also the bucket size. The Single Rate Three Color (srTCM) is based on the token bucket filter and identifies packets by comparing them to the Committed Information Rate (CIR), the Committed Burst Size (CBS) and the Excess Burst Size (EBS). The Two Rate Three Color (trTCM) is based on the token bucket filter and identifies packets by comparing them to the Committed Information Rate (CIR) and the Peak Information Rate (PIR).
Committed Rate	Specify the committed rate. When the incoming traffic rate of the member QoS classes is less than the committed rate, the device applies the conforming action to the traffic.
Committed Burst Size	Specify the committed burst size for packet bursts. This must be equal to or less than the peak burst size (two rate three color) or excess burst size (single rate three color) if it is also configured. This is the maximum size of the (first) token bucket in a traffic metering algorithm.
Conforming Action	Specify what the EMG does for packets within the committed rate and burst size (green-marked packets). <ul style="list-style-type: none"> • Pass: Send the packets without modification. • DSCP Mark: Change the DSCP mark value of the packets. Enter the DSCP mark value to use.
Non-Conforming Action	Specify what the EMG does for packets that exceed the excess burst size or peak rate and burst size (red-marked packets). <ul style="list-style-type: none"> • Drop: Discard the packets. • DSCP Mark: Change the DSCP mark value of the packets. Enter the DSCP mark value to use. The packets may be dropped if there is congestion on the network.
Available Class	Select a QoS classifier to apply this QoS policer to traffic that matches the QoS classifier.
Selected Class	Highlight a QoS classifier in the Available Class box and use the > button to move it to the Selected Class box. To remove a QoS classifier from the Selected Class box, select it and use the < button.
OK	Click OK to save your changes.
Cancel	Click Cancel to exit this screen without saving.

10.8 QoS Monitor

To view the EMG's QoS packet statistics, click **Network Setting > QoS > Monitor**. The screen appears as shown.

Figure 90 Network Setting > QoS > Monitor

Monitor

Refresh Interval : ▼

Status

Interface Monitor

#	Name	Pass Rate(bps)	Drop Rate (bps)
1	WAN	0	0
2	LAN		

Queue Monitor

#	Name	Pass Rate(bps)	Drop Rate (bps)
---	------	----------------	-----------------

The following table describes the labels in this screen.

Table 48 Network Setting > QoS > Monitor

LABEL	DESCRIPTION
Refresh Interval	Enter how often you want the VMG to update this screen. Select No Refresh to stop refreshing statistics.
Interface Monitor	
#	This is the index number of the entry.
Name	This shows the name of the interface on the EMG.
Pass Rate	This shows how many packets forwarded to this interface are transmitted successfully.
Drop Rate	This shows how many packets forwarded to this interface are dropped.
Queue Monitor	
#	This is the index number of the entry.
Name	This shows the name of the queue.
Pass Rate	This shows how many packets assigned to this queue are transmitted successfully.
Drop Rate	This shows how many packets assigned to this queue are dropped.

10.9 Technical Reference

The following section contains additional technical information about the EMG features described in this chapter.

IEEE 802.1Q Tag

The IEEE 802.1Q standard defines an explicit VLAN tag in the MAC header to identify the VLAN membership of a frame across bridges. A VLAN tag includes the 12-bit VLAN ID and 3-bit user priority. The VLAN ID associates a frame with a specific VLAN and provides the information that devices need to process the frame across the network.

IEEE 802.1p specifies the user priority field and defines up to eight separate traffic types. The following table describes the traffic types defined in the IEEE 802.1d standard (which incorporates the 802.1p).

Table 49 IEEE 802.1p Priority Level and Traffic Type

PRIORITY LEVEL	TRAFFIC TYPE
Level 7	Typically used for network control traffic such as router configuration messages.
Level 6	Typically used for voice traffic that is especially sensitive to jitter (jitter is the variations in delay).
Level 5	Typically used for video that consumes high bandwidth and is sensitive to jitter.
Level 4	Typically used for controlled load, latency-sensitive traffic such as SNA (Systems Network Architecture) transactions.
Level 3	Typically used for "excellent effort" or better than best effort and would include important business traffic that can tolerate some delay.
Level 2	This is for "spare bandwidth".
Level 1	This is typically used for non-critical "background" traffic such as bulk transfers that are allowed but that should not affect other applications and users.
Level 0	Typically used for best-effort traffic.

DiffServ

QoS is used to prioritize source-to-destination traffic flows. All packets in the flow are given the same priority. You can use CoS (class of service) to give different priorities to different packet types.

DiffServ (Differentiated Services) is a class of service (CoS) model that marks packets so that they receive specific per-hop treatment at DiffServ-compliant network devices along the route based on the application types and traffic flow. Packets are marked with DiffServ Code Points (DSCPs) indicating the level of service desired. This allows the intermediary DiffServ-compliant network devices to handle the packets differently depending on the code points without the need to negotiate paths or remember state information for every flow. In addition, applications do not have to request a particular service or give advanced notice of where the traffic is going.

DSCP and Per-Hop Behavior

DiffServ defines a new Differentiated Services (DS) field to replace the Type of Service (TOS) field in the IP header. The DS field contains a 2-bit unused field and a 6-bit DSCP field which can define up to 64 service levels. The following figure illustrates the DS field.

DSCP is backward compatible with the three precedence bits in the ToS octet so that non-DiffServ compliant, ToS-enabled network device will not conflict with the DSCP mapping.

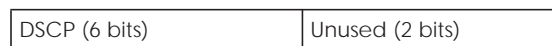

The DSCP value determines the forwarding behavior, the PHB (Per-Hop Behavior), that each packet gets across the DiffServ network. Based on the marking rule, different kinds of traffic can be marked for different kinds of forwarding. Resources can then be allocated according to the DSCP values and the configured policies.

IP Precedence

Similar to IEEE 802.1p prioritization at layer-2, you can use IP precedence to prioritize packets in a layer-3 network. IP precedence uses three bits of the eight-bit ToS (Type of Service) field in the IP header. There are eight classes of services (ranging from zero to seven) in IP precedence. Zero is the lowest priority level and seven is the highest.

Automatic Priority Queue Assignment

If you enable QoS on the EMG, the EMG can automatically base on the IEEE 802.1p priority level, IP precedence and/or packet length to assign priority to traffic which does not match a class.

The following table shows you the internal layer-2 and layer-3 QoS mapping on the EMG. On the EMG, traffic assigned to higher priority queues gets through faster while traffic in lower index queues is dropped if the network is congested.

Table 50 Internal Layer2 and Layer3 QoS Mapping

PRIORITY QUEUE	LAYER 2		LAYER 3	
	IEEE 802.1P USER PRIORITY (ETHERNET PRIORITY)	TOS (IP PRECEDENCE)	DSCP	IP PACKET LENGTH (BYTE)
0	1	0	000000	
1	2			
2	0	0	000000	>1100
3	3	1	001110 001100 001010 001000	250~1100
4	4	2	010110 010100 010010 010000	
5	5	3	011110 011100 011010 011000	<250
6	6	4	100110 100100 100010 100000	
		5	101110 101000	
7	7	6	110000	
		7	111000	