

---

# PART II

## Technical Reference

---

# CHAPTER 4

# Dashboard

## 4.1 Overview

Use the **Dashboard** screens to check status information about the NWA/WAC.

### 4.1.1 What You Can Do in this Chapter

- The main **Dashboard** screen ([Section 4.2 on page 54](#)) displays the NWA/WAC's general device information, system status, system resource usage, and interface status. You can also display other status screens for more information.

## 4.2 Dashboard

This screen is the first thing you see when you log into the NWA/WAC. It also appears every time you click the **Dashboard** icon in the navigation panel. The Dashboard displays general device information, system status, system resource usage, and interface status in widgets that you can re-arrange to suit your needs. You can also collapse, refresh, and close individual widgets.

Figure 27 Dashboard

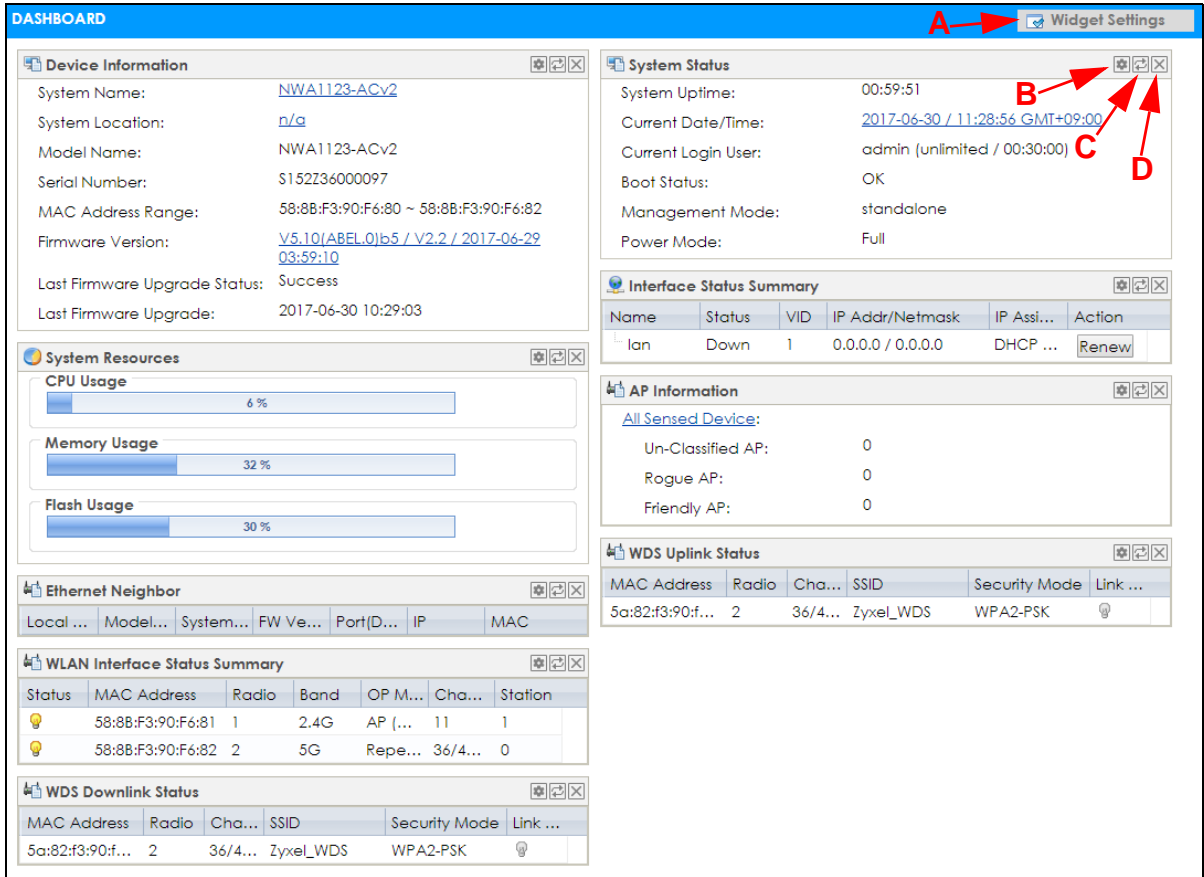

The following table describes the labels in this screen.

Table 23 Dashboard

LABEL	DESCRIPTION
Widget Settings (A)	Use this link to re-open closed widgets. Widgets that are already open appear grayed out.
Refresh Time Setting (B)	Set the interval for refreshing the information displayed in the widget.
Refresh Now (C)	Click this to update the widget's information immediately.
Close Widget (D)	Click this to close the widget. Use <b>Widget Settings</b> to re-open it.
Device Information	
System Name	This field displays the name used to identify the NWA/WAC on any network. Click the icon to open the screen where you can change it.
System Location	This field displays the location of the NWA/WAC. Click the icon to open the screen where you can change it.
Model Name	This field displays the model name of this NWA/WAC.
Serial Number	This field displays the serial number of this NWA/WAC.
MAC Address Range	This field displays the MAC addresses used by the NWA/WAC. Each physical port or wireless radio has one MAC address. The first MAC address is assigned to the Ethernet LAN port, the second MAC address is assigned to the first radio, and so on.
Firmware Version	This field displays the version number and date of the firmware the NWA/WAC is currently running. Click the icon to open the screen where you can upload firmware.
Last Firmware Upgrade Status	This field displays whether the latest firmware update was successfully completed.

Table 23 Dashboard (continued)

LABEL	DESCRIPTION
Last Firmware Upgrade	This field displays the date and time when the last firmware update was made.
System Resources	
CPU Usage	This field displays what percentage of the NWA/WAC's processing capability is currently being used. Hover your cursor over this field to display the <b>Show CPU Usage</b> icon that takes you to a chart of the NWA/WAC's recent CPU usage.
Memory Usage	This field displays what percentage of the NWA/WAC's RAM is currently being used. Hover your cursor over this field to display the <b>Show Memory Usage</b> icon that takes you to a chart of the NWA/WAC's recent memory usage.
Flash Usage	This field displays what percentage of the NWA/WAC's onboard flash memory is currently being used.
Ethernet Neighbor	
Local Port (Description)	This field displays the port of the NWA/WAC, on which the neighboring device is discovered.
Model Name	This field displays the model name of the discovered device.
System Name	This field displays the system name of the discovered device.
FW Version	This field displays the firmware version of the discovered device.
Port (Description)	This field displays the discovered device's port which is connected to the NWA/WAC.
IP	This field displays the IP address of the discovered device. Click the IP address to access and manage the discovered device using its web configurator.
MAC	This field displays the MAC address of the discovered device.
WDS (Wireless Distribution System) Uplink/Downlink Status	
MAC Address	This field displays the MAC address of the root AP or repeater to which the NWA/WAC is connected using WDS.
Radio	This field displays the radio number on the root AP or repeater to which the NWA/WAC is connected using WDS.
Channel	This field displays the channel number on the root AP or repeater to which the NWA/WAC is connected using WDS.
SSID	This field displays the name of the wireless network to which the NWA/WAC is connected using WDS.
Security Mode	This field displays which secure encryption methods is being used by the NWA/WAC to connect to the root AP or repeater using WDS.
Link Status	This field displays the RSSI (Received Signal Strength Indicator) and transmission/reception rate of the wireless connection in WDS.
System Status	
System Uptime	This field displays how long the NWA/WAC has been running since it last restarted or was turned on.
Current Date/Time	This field displays the current date and time in the NWA/WAC. The format is yyyy-mm-dd hh:mm:ss.
Current Login User	This field displays the user name used to log in to the current session, the amount of reauthentication time remaining, and the amount of lease time remaining.

Table 23 Dashboard (continued)

LABEL	DESCRIPTION
Boot Status	<p>This field displays details about the NWA/WAC's startup state.</p> <p><b>OK</b> - The NWA/WAC started up successfully.</p> <p><b>Firmware update OK</b> - A firmware update was successful.</p> <p><b>Problematic configuration after firmware update</b> - The application of the configuration failed after a firmware upgrade.</p> <p><b>System default configuration</b> - The NWA/WAC successfully applied the system default configuration. This occurs when the NWA/WAC starts for the first time or you intentionally reset the NWA/WAC to the system default settings.</p> <p><b>Fallback to lastgood configuration</b> - The NWA/WAC was unable to apply the startup-config.conf configuration file and fell back to the lastgood.conf configuration file.</p> <p><b>Fallback to system default configuration</b> - The NWA/WAC was unable to apply the lastgood.conf configuration file and fell back to the system default configuration file (system-default.conf).</p> <p><b>Booting in progress</b> - The NWA/WAC is still applying the system configuration.</p>
Management Mode	This shows whether the NWA/WAC is set to work as a stand alone AP.
Power Mode	<p>This displays the NWA/WAC's power status.</p> <p><b>Full</b> - the NWA/WAC receives power using a power adaptor and/or through a PoE switch/injector using IEEE 802.3at PoE plus.</p> <p><b>Limited</b> - the NWA/WAC receives power through a PoE switch/injector using IEEE 802.3af PoE even when it is also connected to a power source using a power adaptor.</p> <p>When the NWA/WAC is in limited power mode, the NWA/WAC throughput decreases and has just one transmitting radio chain.</p> <p>It always shows <b>Full</b> if the NWA/WAC does not support power detection. At the time of writing, only the WAC6500 series APs support the power detection feature.</p>
Interface Status Summary	If an Ethernet interface does not have any physical ports associated with it, its entry is displayed in light gray text. Click the <b>Detail</b> icon to go to a (more detailed) summary screen of interface statistics.
Name	This field displays the name of each interface.
Status	<p>This field displays the current status of each interface. The possible values depend on what type of interface it is.</p> <p><b>Inactive</b> - The Ethernet interface is disabled.</p> <p><b>Down</b> - The Ethernet interface is enabled but not connected.</p> <p><b>Speed / Duplex</b> - The Ethernet interface is enabled and connected. This field displays the port speed and duplex setting (<b>Full</b> or <b>Half</b>).</p>
VID	This field displays the VLAN ID to which the interface belongs.
IP Addr/Netmask	This field displays the current IP address and subnet mask assigned to the interface. If the IP address is 0.0.0.0, the interface is disabled or did not receive an IP address and subnet mask via DHCP.
IP Assignment	<p>This field displays how the interface gets its IP address.</p> <p><b>Static</b> - This interface has a static IP address.</p> <p><b>DHCP Client</b> - This interface gets its IP address from a DHCP server.</p>
Action	<p>If the interface has a static IP address, this shows <b>n/a</b>.</p> <p>If the interface has a dynamic IP address, use this field to get or to update the IP address for the interface. Click <b>Renew</b> to send a new DHCP request to a DHCP server.</p>

Table 23 Dashboard (continued)

LABEL	DESCRIPTION
WLAN Interface Status Summary	This displays status information for the WLAN interface.
Status	This displays whether or not the WLAN interface is activated.
MAC Address	This displays the MAC address of the radio.
Radio	This indicates the radio number on the NWA/WAC.
Band	This indicates the wireless frequency band currently being used by the radio. This shows - when the radio is in monitor mode.
OP Mode	This indicates the radio's operating mode. Operating modes are <b>AP (MBSSID)</b> , <b>MON</b> (monitor), <b>Root AP</b> or <b>Repeater</b> .
Channel	This indicates the channel number the radio is using.
Antenna	This indicates the antenna orientation for the radio ( <b>Wall</b> or <b>Ceiling</b> ). This field is not available if the NWA/WAC does not allow you to adjust antenna orientation for each radio using the web configurator or a physical switch. Refer to <a href="#">Table 1 on page 13</a> and <a href="#">Table 3 on page 15</a> to see if your NWA/WAC has an antenna switch.
Station	This displays the number of wireless clients connected to the NWA/WAC.
AP Information	This shows a summary of connected wireless Access Points (APs).
All Sensed Device	This sections displays a summary of all wireless devices detected by the network. Click the link to go to the <b>Monitor &gt; Wireless &gt; Detected Device</b> screen.
Un-Classified AP	This displays the number of detected unclassified APs.
Rogue AP	This displays the number of detected rogue APs.
Friendly AP	This displays the number of detected friendly APs.

## 4.2.1 CPU Usage

Use this screen to look at a chart of the NWA/WAC's recent CPU usage. To access this screen, click **CPU Usage** in the dashboard.

Figure 28 Dashboard &gt; CPU Usage

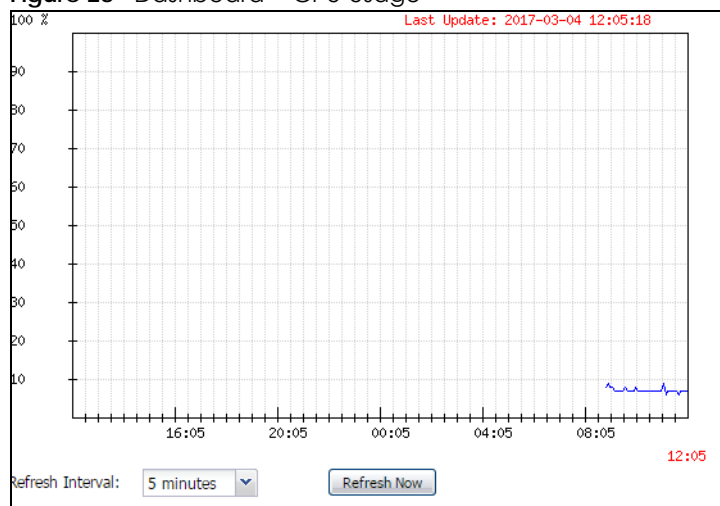

The following table describes the labels in this screen.

Table 24 Dashboard > CPU Usage

LABEL	DESCRIPTION
%	The y-axis represents the percentage of CPU usage.
time	The x-axis shows the time period over which the CPU usage occurred
Refresh Interval	Enter how often you want this window to be automatically updated.
Refresh Now	Click this to update the information in the window right away.

## 4.2.2 Memory Usage

Use this screen to look at a chart of the NWA/WAC's recent memory (RAM) usage. To access this screen, click **Memory Usage** in the dashboard.

Figure 29 Dashboard > Memory Usage



The following table describes the labels in this screen.

Table 25 Dashboard > Memory Usage

LABEL	DESCRIPTION
%	The y-axis represents the percentage of RAM usage.
time	The x-axis shows the time period over which the RAM usage occurred
Refresh Interval	Enter how often you want this window to be automatically updated.
Refresh Now	Click this to update the information in the window right away.

# CHAPTER 5

# Monitor

## 5.1 Overview

Use the **Monitor** screens to check status and statistics information.

### 5.1.1 What You Can Do in this Chapter

- The **Network Status** screen ([Section 5.3 on page 61](#)) displays general LAN interface information and packet statistics.
- The **AP Information > Radio List** screen ([Section 5.4 on page 64](#)) displays statistics about the wireless radio transmitters in the NWA/WAC.
- The **Station Info** screen ([Section 5.5 on page 67](#)) displays statistics pertaining to the associated stations.
- The **WDS Link Info** screen ([Section 5.6 on page 68](#)) displays statistics about the NWA/WAC's WDS (Wireless Distribution System) connections.
- The **Detected Device** screen ([Section 5.7 on page 69](#)) displays information about suspected rogue APs.
- The **View Log** screen ([Section 5.8 on page 72](#)) displays the NWA/WAC's current log messages. You can change the way the log is displayed, you can e-mail the log, and you can also clear the log in this screen.

## 5.2 What You Need to Know

The following terms and concepts may help as you read through the chapter.

### Rogue AP

Rogue APs are wireless access points operating in a network's coverage area that are not under the control of the network's administrators, and can open up holes in a network's security. See [Chapter 11 on page 126](#) for details.

### Friendly AP

Friendly APs are other wireless access points that are detected in your network, as well as any others that you know are not a threat (those from neighboring networks, for example). See [Chapter 11 on page 126](#) for details.



## 5.3 Network Status

Use this screen to look at general Ethernet interface information and packet statistics. To access this screen, click **Monitor > Network Status**. The screen varies depending on whether the NWA/WAC has an extra Ethernet port (except the uplink port).

**Figure 30** Monitor > Network Status (for NWA/WAC with one Ethernet port)

**Network Status**

**Interface Summary**

Name	Status	VID	IP Addr/Netmask	IP Assignment	Action
Ian	Down	1	0.0.0.0 / 0.0.0.0	DHCP client	<a href="#">Renew</a>

**IPv6 Interface Summary**

Name	Status	IP Address	Action
Ian	Down	LINK LOCAL -- fe80::5a8b:f3ff:fe90:f680/64	n/a

**Port Statistics Table**

Poll Interval:  Seconds [Set Interval](#) [Stop](#)

[Switch To Graphic View](#)

Status	TxPkts	RxPkts	Tx Bcast	Rx Bcast	Collisions	Tx	Rx	Up Time
Down	0	0	0	0	0	0	0	00:00:00

System Up Time: 02:59:00

**Figure 31** Monitor > Network Status (for NWA/WAC with multiple Ethernet ports)

**Network Status**

**Interface Summary**

IP Addr/Netmask	IP Assignment	Action
172.16.1.4 / 255.255.0.0	DHCP client	<a href="#">Renew</a>

**IPv6 Interface Summary**

IP Address	Action
LINK LOCAL -- fe80::6231:97ff:fe0f:8dc4/64	n/a

**Port Statistics Table**

Poll Interval:  Seconds [Set Interval](#) [Stop](#)

[Switch To Graphic View](#)

Name	Status	TxPkts	RxPkts	Tx Bcast	Rx Bcast	Collisions	Tx	Rx	Up Time
UPLINK	100M/Full	3102	1910	123	24	0	64	64	00:11:27
Ian1	Down	0	0	0	0	0	0	0	00:00:00

System Up Time: 00:11:27

The following table describes the labels in this screen.

Table 26 Monitor > Network Status

LABEL	DESCRIPTION
Interface Summary IPv6 Interface Summary	Use the <b>Interface Summary</b> section for IPv4 network settings. Use the <b>IPv6 Interface Summary</b> section for IPv6 network settings if you connect your NWA/WAC to an IPv6 network. Both sections have similar fields as described below.
Name	This field displays the name of the physical Ethernet port on the NWA/WAC.
Status	This field displays the current status of each physical port on the NWA/WAC.  <b>Down</b> - The port is not connected.  <b>Speed / Duplex</b> - The port is connected. This field displays the port speed and duplex setting ( <b>Full</b> or <b>Half</b> ).
VID	This field displays the VLAN ID to which the port belongs.
IP Addr/Netmask IP Address	This field displays the current IP address (and subnet mask) of the interface. If the IP address is 0.0.0.0 (in the IPv4 network) or :: (in the IPv6 network), the interface does not have an IP address yet.
IP Assignment	This field displays how the interface gets its IPv4 address.  <b>Static</b> - This interface has a static IPv4 address.  <b>DHCP Client</b> - This interface gets its IPv4 address from a DHCP server.
Action	Use this field to get or to update the IP address for the interface. Click <b>Renew</b> to send a new DHCP request to a DHCP server. If the interface cannot use one of these ways to get or to update its IP address, this field displays <b>n/a</b> .
Port Statistics Table	
Poll Interval	Enter how often you want this window to be updated automatically, and click <b>Set Interval</b> .
Set Interval	Click this to set the <b>Poll Interval</b> the screen uses.
Stop	Click this to stop the window from updating automatically. You can start it again by setting the <b>Poll Interval</b> and clicking <b>Set Interval</b> .
Switch to Graphic View	Click this to display the port statistics as a line graph.
Name	This field displays the name of the interface.
Status	This field displays the current status of the physical port.  <b>Down</b> - The physical port is not connected.  <b>Speed / Duplex</b> - The physical port is connected. This field displays the port speed and duplex setting ( <b>Full</b> or <b>Half</b> ).
TxPkts	This field displays the number of packets transmitted from the NWA/WAC on the physical port since it was last connected.
RxPkts	This field displays the number of packets received by the NWA/WAC on the physical port since it was last connected.
Tx Bcast	This field displays the number of broadcast packets transmitted from the NWA/WAC on the physical port since it was last connected.
Rx Bcast	This field displays the number of broadcast packets received by the NWA/WAC on the physical port since it was last connected.
Collisions	This field displays the number of collisions on the physical port since it was last connected.
Tx	This field displays the transmission speed, in bytes per second, on the physical port in the one-second interval before the screen updated.

Table 26 Monitor &gt; Network Status (continued)

LABEL	DESCRIPTION
Rx	This field displays the reception speed, in bytes per second, on the physical port in the one-second interval before the screen updated.
Up Time	This field displays how long the physical port has been connected.
System Up Time	This field displays how long the NWA/WAC has been running since it last restarted or was turned on.

### 5.3.1 Port Statistics Graph

Use the port statistics graph to look at a line graph of packet statistics for the Ethernet port. To view, click **Monitor > Network Status** and then the **Switch to Graphic View** button.

This screen is NOT available on the NWA/WAC that has an extra Ethernet port (except the uplink port).

Figure 32 Monitor &gt; Network Status &gt; Switch to Graphic View

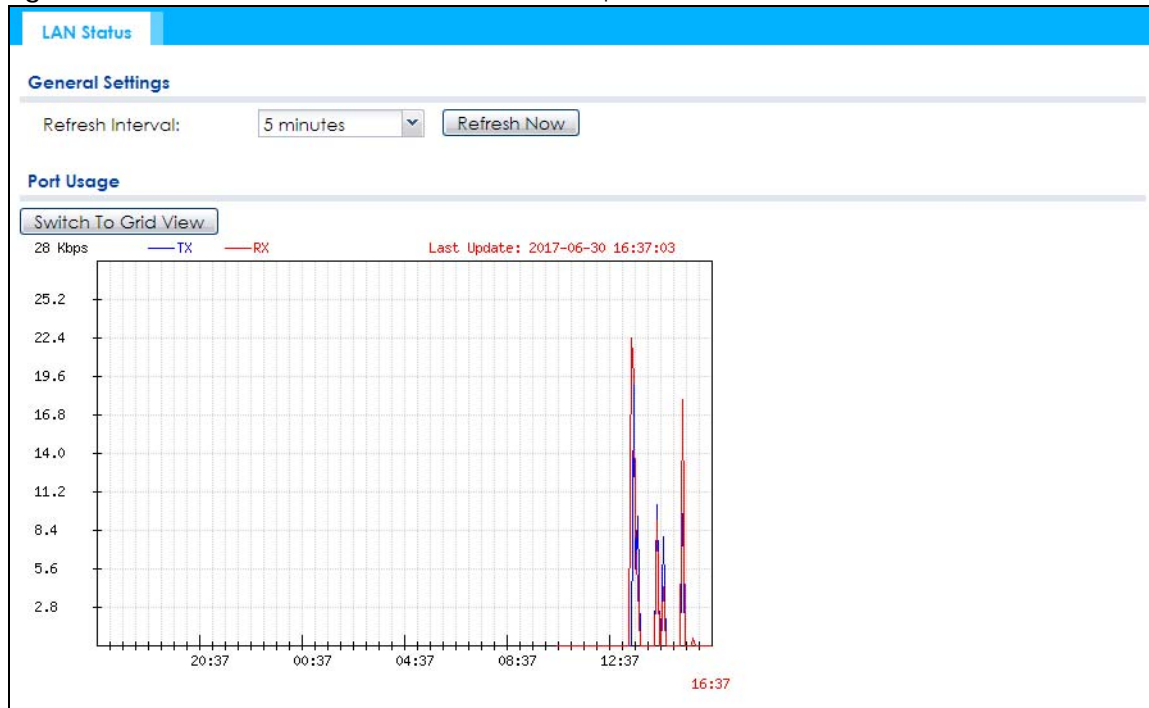

The following table describes the labels in this screen.

Table 27 Monitor &gt; Network Status &gt; Switch to Graphic View

LABEL	DESCRIPTION
Refresh Interval	Enter how often you want this window to be automatically updated.
Refresh Now	Click this to update the information in the window right away.
Switch to Grid View	Click this to display the port statistics as a table.
Kbps/Mbps	The y-axis represents the speed of transmission or reception.
Time	The x-axis shows the time period over which the transmission or reception occurred.
TX	This line represents traffic transmitted from the NWA/WAC on the physical port since it was last connected.

Table 27 Monitor &gt; Network Status &gt; Switch to Graphic View (continued)

LABEL	DESCRIPTION
RX	This line represents the traffic received by the NWA/WAC on the physical port since it was last connected.
Last Update	This field displays the date and time the information in the window was last updated.

## 5.4 Radio List

Use this screen to view statistics for the NWA/WAC's wireless radio transmitters. To access this screen, click **Monitor > Wireless > AP Information > Radio List**.

Figure 33 Monitor &gt; Wireless &gt; AP Information &gt; Radio List (for NWA/WAC that supports WDS)

St...	Loading	Frequen...	Chan...	Tx P...	St...	Rx	Tx	MAC Add...	Ra...	OP Mo...	AP / WDS Pro...
⚡	-	2.4G	11	23	1	4908339	139006...	58:8B:F3:9...	1	AP (M...	Wiz_Radio_2...
⚡	-	5G	36/40...	20	0	0	0	58:8B:F3:9...	2	repeater	Wiz_Radio_5...

Figure 34 Monitor &gt; Wireless &gt; AP Information &gt; Radio List (for NWA/WAC that doesn't support WDS)

St...	Loading	Frequen...	Chan...	Tx P...	St...	Rx	Tx	MAC Add...	Ra...	OP Mo...	Profile
⚡	-	2.4G	11	22	1	33648	340272	60:31:97:0...	1	AP (M...	default
⚡	-	5G	48/44...	22	0	0	311660	60:31:97:0...	2	AP (M...	default2

The following table describes the labels in this screen.

Table 28 Monitor &gt; Wireless &gt; AP Information &gt; Radio List

LABEL	DESCRIPTION
More Information	Click this to view additional information about the selected radio's wireless traffic and station count. Information spans a 24 hour period.
Status	This displays whether or not the radio is enabled.

Table 28 Monitor &gt; Wireless &gt; AP Information &gt; Radio List (continued)

LABEL	DESCRIPTION
Loading	This indicates the AP's load balance status ( <b>UnderLoad</b> or <b>OverLoad</b> ) when load balancing is enabled on the NWA/WAC. Otherwise, it shows - when load balancing is disabled or the radio is in monitor mode.
MAC Address	This displays the MAC address of the radio.
Radio	This indicates the radio number on the NWA/WAC to which it belongs.
OP Mode	This indicates the radio's operating mode. Operating modes are <b>AP (MBSSID)</b> , <b>MONITOR</b> , <b>Root AP</b> or <b>Repeater</b>
AP/WDS Profile	This indicates the AP profile name and WDS profile name to which the radio belongs. This field is available only on the NWA/WAC that supports WDS.
Profile	This indicates the AP profile name to which the radio belongs. This field is available only on the NWA/WAC that doesn't support WDS.
Frequency Band	This indicates the wireless frequency band currently being used by the radio. This shows - when the radio is in monitor mode.
Channel	This indicates the radio's channel ID.
Tx Power	This displays the output power of the radio.
Station	This displays the number of wireless clients connected to this radio on the NWA/WAC.
Rx	This displays the total number of packets received by the radio.
Tx	This displays the total number of packets transmitted by the radio.

### 5.4.1 AP Mode Radio Information

This screen allows you to view a selected radio's SSID details, wireless traffic statistics and station count for the preceding 24 hours. To access this window, select a radio and click the **More Information** button in the **Radio List** screen.

Figure 35 Monitor > Wireless > AP Information > Radio List > More Information

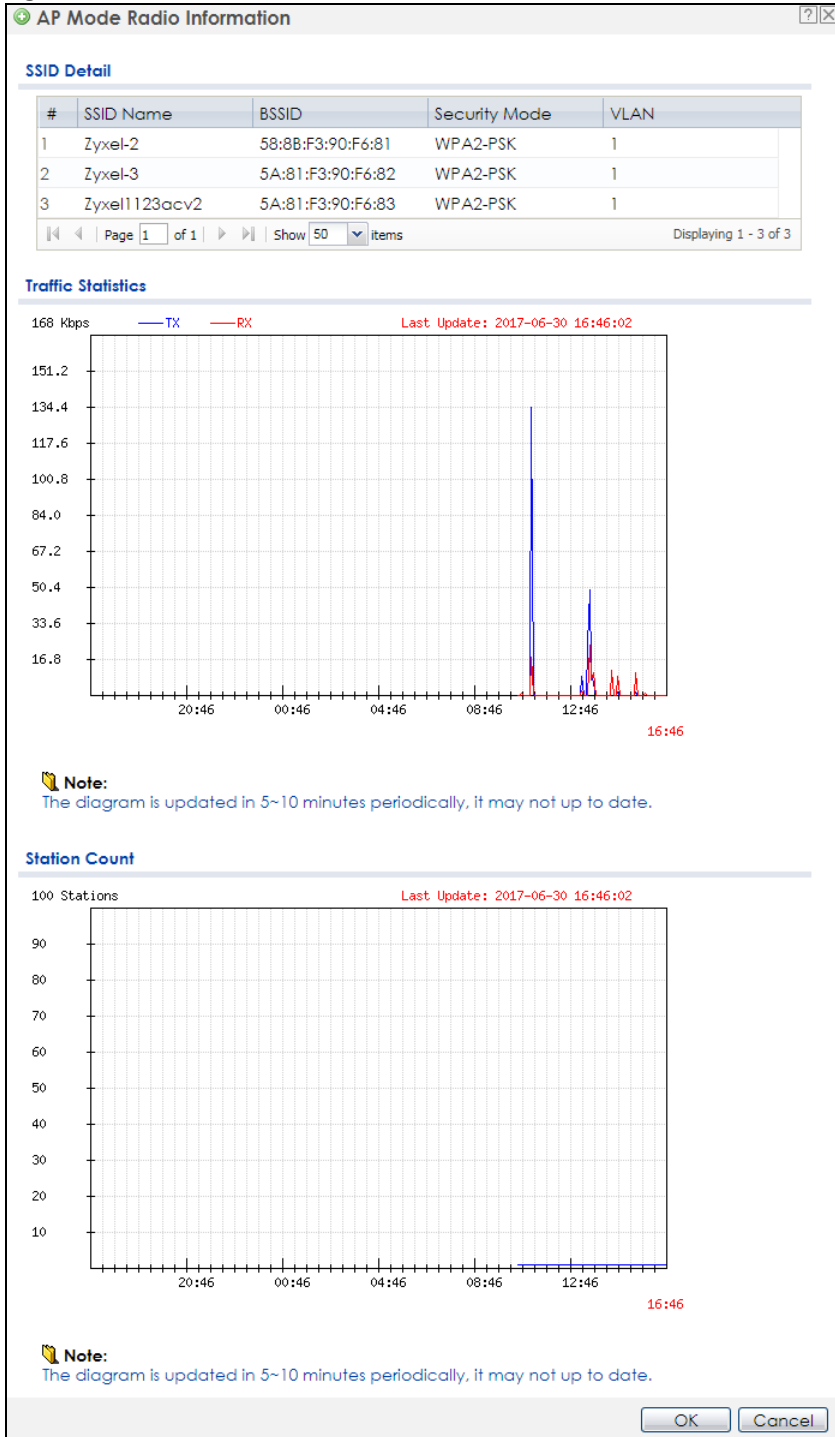

The following table describes the labels in this screen.

Table 29 Monitor > Wireless > AP Information > Radio List > More Information

LABEL	DESCRIPTION
SSID Detail	This list shows information about all the wireless clients that have connected to the specified radio over the preceding 24 hours.
#	This is the items sequential number in the list. It has no bearing on the actual data in this list.

Table 29 Monitor &gt; Wireless &gt; AP Information &gt; Radio List &gt; More Information (continued)

LABEL	DESCRIPTION
SSID Name	This displays an SSID associated with this radio. There can be up to eight maximum.
BSSID	This displays a BSSID associated with this radio. The BSSID is tied to the SSID.
Security Mode	This displays the security mode in which the SSID is operating.
VLAN	This displays the VLAN ID associated with the SSID.
Traffic Statistics	This graph displays the overall traffic information of the radio over the preceding 24 hours.
Kbps/Mbps	This y-axis represents the amount of data moved across this radio in megabytes per second.
Time	This x-axis represents the amount of time over which the data moved across this radio.
Station Count	This graph displays the connected station information of the radio over the preceding 24 hours.
Stations	The y-axis represents the number of connected stations.
Time	The x-axis shows the time period over which a station was connected.
Last Update	This field displays the date and time the information in the window was last updated.
OK	Click this to close this window.
Cancel	Click this to close this window.

## 5.5 Station List

Use this screen to view statistics pertaining to the associated stations (or "wireless clients"). Click **Monitor > Wireless > Station Info** to access this screen.

Figure 36 Monitor &gt; Wireless &gt; Station Info

#	IP Addr...	MAC Ad...	Radio	Capability	SSID Name	Security ...	Signal Str...	Tx R...	Rx R...	Associati...
1	172.16...	00:19:cb:...	1	802.11b/g	Zyxe1123acv2	WPA2-PSK	-50dBm	1M	54M	10:34:18 ...

Page 1 of 1 | Show 50 items | Displaying 1 - 1 of 1

Refresh

The following table describes the labels in this screen.

Table 30 Monitor &gt; Wireless &gt; Station Info

LABEL	DESCRIPTION
#	This is the station's index number in this list.
IP Address	This is the station's IP address.
MAC Address	This is the station's MAC address.
Radio	This is the radio number on the NWA/WAC to which the station is connected.
Capability	This displays the supported standard currently being used by the station or the standards supported by the station.

Table 30 Monitor &gt; Wireless &gt; Station Info (continued)

LABEL	DESCRIPTION
SSID Name	This indicates the name of the wireless network to which the station is connected. A single AP can have multiple SSIDs or networks.
Security Mode	This indicates which secure encryption methods is being used by the station to connect to the network.
Signal Strength	This is the RSSI (Received Signal Strength Indicator) of the station's wireless connection.
Tx Rate	This is the maximum transmission rate of the station.
Rx Rate	This is the maximum reception rate of the station.
Association Time	This displays the time the station first associated with the NWA/WAC's wireless network.
Refresh	Click this to refresh the items displayed on this page.

## 5.6 WDS Link Info

Use this screen to view the WDS traffic statistics between the NWA/WAC and a root AP or repeaters. Click **Monitor > Wireless > WDS Link Info** to access this screen.

Figure 37 Monitor &gt; Wireless &gt; WDS Link Info

The screenshot shows the 'WDS Link Info' interface. It is divided into two main sections: 'WDS Uplink Info' and 'WDS Downlink Info'. Each section contains a table with the following columns: '#', 'MAC Address', 'Radio', 'SSID Name', 'Security Mo...', 'Signal Str...', 'Tx Rate', and 'Association time'. Below each table is a pagination control showing 'Page 1 of 1' and a 'Show 50 items' dropdown. The status 'No data to display' is shown at the bottom right of each table. A 'Refresh' button is positioned at the bottom center of the screen.

The following table describes the labels in this screen.

Table 31 Monitor &gt; Wireless &gt; WDS Link Info

LABEL	DESCRIPTION
WDS Uplink Info	<b>Uplink</b> refers to the WDS link from the repeaters to the root AP.
WDS Downlink Info	<b>Downlink</b> refers to the WDS link from the root AP to the repeaters. When the NWA/WAC is in root AP mode and connected to a repeater, only the downlink information is displayed. When the NWA/WAC is in repeater mode and connected to a root AP directly or via another repeater, the uplink information is displayed.
	When the NWA/WAC is in repeater mode and connected to a root AP and other repeater(s), both the uplink and downlink information would be displayed.
#	This is the index number of the root AP or repeater in this list.



Table 31 Monitor &gt; Wireless &gt; WDS Link Info (continued)

LABEL	DESCRIPTION
MAC Address	This is the MAC address of the root AP or repeater to which the NWA/WAC is connected using WDS.
Radio	This is the radio number on the root AP or repeater to which the NWA/WAC is connected using WDS.
SSID Name	This indicates the name of the wireless network to which the NWA/WAC is connected using WDS.
Security Mode	This indicates which secure encryption methods is being used by the NWA/WAC to connect to the root AP or repeater using WDS.
Signal Strength	This is the RSSI (Received Signal Strength Indicator) of the wireless connection in WDS.
Tx Rate	This is the maximum transmission rate of the root AP or repeater to which the NWA/WAC is connected using WDS.
Rx Rate	This is the maximum reception rate of the root AP or repeater to which the NWA/WAC is connected using WDS.
Association Time	This displays the time the NWA/WAC first associated with the wireless network using WDS.
Refresh	Click this to refresh the items displayed on this page.

## 5.7 Detected Device

Use this screen to view information about suspected rogue APs. Click **Monitor > Wireless > Detected Device** to access this screen. Not all NWA/WACs support monitor mode.

Note: If the NWA/WAC supports monitor mode, the radio or at least one of the NWA/WAC's radio must be set to monitor mode (in the **Wireless > AP Management** screen) in order to detect other wireless devices in its vicinity.

If the NWA/WAC doesn't support monitor mode, turn on rogue AP detection in the **Configuration > Wireless > Rogue AP** screen to detect rogue APs.

Figure 38 Monitor > Wireless > Detected Device (for NWA/WAC that supports Monitor mode)

Detected Device										
#	Stat...	Device	Role	MAC Address	SSID Name	Channe...	802...	Sec...	Descrip...	Last Seen
1	🔆	infrastruc...		00:02:6F:12:34:56	VIDEOTRON...	10	IEEE...	WP...		Mon Jul...
2	🔆	infrastruc...		00:02:CF:AF:69:DC	SDD1-85662...	8	IEEE...	TKIP...		Mon Jul...
3	🔆	infrastruc...		00:13:49:11:66:8C	Zy_private_...	5	IEEE...	WP...		Mon Jul...
4	🔆	infrastruc...		00:13:49:F1:2B:88	\343\204\2...	5	IEEE...	WP...		Mon Jul...
5	🔆	infrastruc...		00:17:16:44:33:70	xxxxxx2	10	IEEE...	WP...		Mon Jul...
6	🔆	infrastruc...		00:19:CB:11:44:D0	wpa	10	IEEE...	TKIP...		Mon Jul...
7	🔆	infrastruc...		00:25:36:AC:25:78	418N v2	9		WEP		Mon Jul...
8	🔆	infrastruc...		00:50:18:D2:A2:E6	ZyXEL_A2E6	5	IEEE...	WP...		Mon Jul...
9	🔆	infrastruc...		00:AA:BB:01:23:40	Zyxel_AP	6	IEEE...	WP...		Mon Jul...
10	🔆	infrastruc...		02:11:22:33:44:88	aisfibre_334...	8	IEEE...	TKIP...		Mon Jul...
11	🔆	infrastruc...		02:17:16:44:33:70	zzzzzzzz222	10	IEEE...	WP...		Mon Jul...
12	🔆	infrastruc...		02:AA:BB:11:23:40	HT_AP1	6	IEEE...	None		Mon Jul...
13	🔆	infrastruc...		02:AA:BB:21:23:40	HT_AP2	6	IEEE...	None		Mon Jul...
14	🔆	infrastruc...		02:AA:BB:31:23:40	HT_AP3	6	IEEE...	None		Mon Jul...
15	🔆	infrastruc...		04:BF:6D:5A:ED:10	VIDEOTRON...	5	IEEE...	WP...		Mon Jul...
16	🔆	infrastruc...		10:11:12:13:14:00	GO_GO_ZY...	5	IEEE...	WP...		Mon Jul...
17	🔆	infrastruc...		10:7B:EF:C5:AC:85	Elisa_999999...	11	IEEE...	WP...		Mon Jul...
18	🔆	infrastruc...		14:91:82:16:24:9A	1G_Ext	11	IEEE...	WP...		Mon Jul...
19	🔆	infrastruc...		14:91:82:81:AA:21	Kelly%&5%3...	9	IEEE...	WP...		Mon Jul...
20	🔆	infrastruc...		14:91:82:82:30:99	Kelly%&5%3...	8	IEEE...	WP...		Mon Jul...

Mark as Rogue AP    Mark as Friendly AP

Page 1 of 12 | Show 20 items | Displaying 1 - 20 of 235

Refresh

**Figure 39** Monitor > Wireless > Detected Device (for NWA/WAC that doesn't support Monitor mode)

**Detected Device**

**Discovered APs**

Rogue AP:	0
Suspected rogue AP:	37
Friendly AP:	1
Un-classified AP:	310

**Detected Device**

Mark as Rogue AP  Mark as Friendly AP

#	Role	Classified by	MAC Address	SSID Name	Chann...	802...	Sec...	Descrip...	Last Seen
21			A0:E4:CB:7C:FB:88	ZyXEL_CSO	6	IEEE...	WP...		Mon Jul...
22			5C:F4:AB:AB:59:05	VIDEOTRON...	153	IEEE...	WP...		Mon Jul...
23			B0:B2:DC:6F:55:BE	test_IOS	36	IEEE...	WP...		Mon Jul...
24			90:EF:68:FB:27:21	6515_55	157	IEEE...	WP...		Mon Jul...
25			10:7B:EF:C5:AC:85	Elisa_99999...	11	IEEE...	WP...		Mon Jul...
26			5A:67:F3:91:12:6B	Unizyx_WLAN	1	IEEE...	WP...		Mon Jul...
27			60:31:97:10:BF:F5	Fioptics00049	4	IEEE...	WP...		Thu Jan...
28	Suspected r...	Hidden SSID	1C:74:0D:FF:D3:...		153	IEEE...	WP...		Mon Jul...
29	Friendly AP		60:31:97:7D:5B:51	Nebula Ac...	1	IEEE...	WP...		Mon Jul...
30			1C:74:0D:FF:D3:B1	ADHBU_5G	36	IEEE...	WP...		Mon Jul...
31			60:31:97:7D:5B:2A	SSID1	48	IEEE...	None		Mon Jul...
32			4E:AB:FF:7F:D7:AC	ZyXEL_CSO...	36	IEEE...	WP...		Mon Jul...
33			A2:88:CB:7C:FB:89	ZyXEL_CSO...	6	IEEE...	WP...		Mon Jul...
34	Suspected r...	Hidden SSID	72:EC:A3:74:CB:57		157	IEEE...	WP...		Thu Jan...
35	Suspected r...	Hidden SSID	1C:74:0D:FF:D3:...		161	IEEE...	WP...		Mon Jul...
36			5A:67:F3:91:12:69	Unizyx_MA...	1	IEEE...	WP...		Mon Jul...
37	Suspected r...	Hidden SSID	1C:74:0D:FF:D2:B4		161	IEEE...	WP...		Thu Jan...
38			B0:B2:DC:C2:15:00	ZT01746_88...	6	IEEE...	WP...		Mon Jul...
39			62:91:97:73:B5:92	e-Nebula-...	44	IEEE...	None		Mon Jul...
40			E8:37:7A:86:E7:19	ZyXEL86E71...	149	IEEE...	WP...		Thu Jan...

Page 2 of 18 | Show 20 items | Displaying 21 - 40 of 348

The following table describes the labels in this screen.

**Table 32** Monitor > Wireless > Detected Device

LABEL	DESCRIPTION
Discovered APs	
Rogue AP	This shows how many devices are detected as rogue APs.
Suspected rogue AP	This shows how many devices are detected as possible rogue APs by classification rule.
Friendly AP	This shows how many devices are detected as friendly APs.
Un-classified AP	This shows how many devices are detected, but have not been classified by the NWA/WAC.
Detect Now	Click this button for the NWA/WAC to scan for APs in the network.
Detected Device	

Table 32 Monitor &gt; Wireless &gt; Detected Device (continued)

LABEL	DESCRIPTION
Mark as Rogue AP	Click this button to mark the selected AP as a rogue AP. A rogue AP can be contained in the <b>Configuration &gt; Wireless &gt; Rogue AP</b> screen ( <a href="#">Section 7.3 on page 88</a> ).
Mark as Friendly AP	Click this button to mark the selected AP as a friendly AP. For more on managing friendly APs, see the <b>Configuration &gt; Wireless &gt; Rogue AP</b> screen ( <a href="#">Section 7.3 on page 88</a> ).
#	This is the detected device's index number in this list.
Status	This indicates the detected device's status.
Device	This indicates the type of device detected.
Role	This indicates the detected device's role (such as friendly or rogue).
Classified by	This indicates the detected device's classification rule.
MAC Address	This indicates the detected device's MAC address.
SSID Name	This indicates the detected device's SSID.
Channel ID	This indicates the detected device's channel ID.
802.11 Mode	This indicates the 802.11 mode (a/b/g/n) transmitted by the detected device.
Security	This indicates the encryption method (if any) used by the detected device.
Description	This displays the detected device's description. For more on managing friendly and rogue APs, see the <b>Configuration &gt; Wireless &gt; Rogue AP</b> screen ( <a href="#">Section 7.3 on page 88</a> ).
Last Seen	This indicates the last time the device was detected by the NWA/WAC.
Refresh	Click this to refresh the items displayed on this page.

## 5.8 View Log

Log messages are stored in two separate logs, one for regular log messages and one for debugging messages. In the regular log, you can look at all the log messages by selecting **All Logs**, or you can select a specific category of log messages (for example, user). You can also look at the debugging log by selecting **Debug Log**. All debugging messages have the same priority.

To access this screen, click **Monitor > Log**. The log is displayed in the following screen.

Note: When a log reaches the maximum number of log messages, new log messages automatically overwrite existing log messages, starting with the oldest existing log message first.

Events that generate an alert (as well as a log message) display in red. Regular logs display in black. Click a column's heading cell to sort the table entries by that column's criteria. Click the heading cell again to reverse the sort order.

Figure 40 Monitor &gt; Log &gt; View Log

The following table describes the labels in this screen.

Table 33 Monitor &gt; Log &gt; View Log

LABEL	DESCRIPTION
Show Filter / Hide Filter	Click this button to show or hide the filter settings.  If the filter settings are hidden, the <b>Display</b> , <b>Email Log Now</b> , <b>Refresh</b> , and <b>Clear Log</b> fields are available.  If the filter settings are shown, the <b>Display</b> , <b>Priority</b> , <b>Source Address</b> , <b>Destination Address</b> , <b>Source Interface</b> , <b>Destination Interface</b> , <b>Protocol</b> , <b>Keyword</b> , and <b>Search</b> fields are available.
Display	Select the category of log message(s) you want to view. You can also view <b>All Logs</b> at one time, or you can view the <b>Debug Log</b> .
Priority	This displays when you show the filter. Select the priority of log messages to display. The log displays the log messages with this priority or higher. Choices are: <b>any</b> , <b>emerg</b> , <b>alert</b> , <b>crit</b> , <b>error</b> , <b>warn</b> , <b>notice</b> , and <b>info</b> , from highest priority to lowest priority. This field is read-only if the <b>Category</b> is <b>Debug Log</b> .
Source Address	This displays when you show the filter. Type the source IP address of the incoming packet that generated the log message. Do not include the port in this filter.

Table 33 Monitor &gt; Log &gt; View Log (continued)

LABEL	DESCRIPTION
Destination Address	This displays when you show the filter. Type the IP address of the destination of the incoming packet when the log message was generated. Do not include the port in this filter.
Source Interface	This displays when you show the filter. Select the source interface of the packet that generated the log message.
Destination Interface	This displays when you show the filter. Select the destination interface of the packet that generated the log message.
Protocol	This displays when you show the filter. Select a service protocol whose log messages you would like to see.
Keyword	This displays when you show the filter. Type a keyword to look for in the <b>Message</b> , <b>Source</b> , <b>Destination</b> and <b>Note</b> fields. If a match is found in any field, the log message is displayed. You can use up to 63 alphanumeric characters and the underscore, as well as punctuation marks ( ) ' ; : ? ! + - * / = # \$ % @ ; the period, double quotes, and brackets are not allowed.
Search	This displays when you show the filter. Click this button to update the log using the current filter settings.
Email Log Now	Click this button to send log messages to the <b>Active</b> e-mail addresses specified in the <b>Send Log To</b> field on the <b>Configuration &gt; Log &amp; Report &gt; Log Settings</b> screen.
Refresh	Click this to update the list of logs.
Clear Log	Click this button to clear the whole log, regardless of what is currently displayed on the screen.
#	This field is a sequential value, and it is not associated with a specific log message.
Time	This field displays the time the log message was recorded.
Priority	This field displays the priority of the log message. It has the same range of values as the <b>Priority</b> field above.
Category	This field displays the log that generated the log message. It is the same value used in the <b>Display</b> and (other) <b>Category</b> fields.
Message	This field displays the reason the log message was generated. The text "[count=x]", where <i>x</i> is a number, appears at the end of the <b>Message</b> field if log consolidation is turned on and multiple entries were aggregated to generate into this one.
Source	This field displays the source IP address and the port number in the event that generated the log message.
Source Interface	This field displays the source interface of the packet that generated the log message.
Destination	This field displays the destination IP address and the port number of the event that generated the log message.
Destination Interface	This field displays the destination interface of the packet that generated the log message.
Protocol	This field displays the service protocol in the event that generated the log message.
Note	This field displays any additional information about the log message.

The Web Configurator saves the filter settings if you leave the **View Log** screen and return to it later.

# CHAPTER 6

## Network

### 6.1 Overview

This chapter describes how you can configure the management IP address and VLAN settings of your NWA/WAC.

The Internet Protocol (IP) address identifies a device on a network. Every networking device (including computers, servers, routers, printers, etc.) needs an IP address to communicate across the network. These networking devices are also known as hosts.

**Figure 41** IP Setup

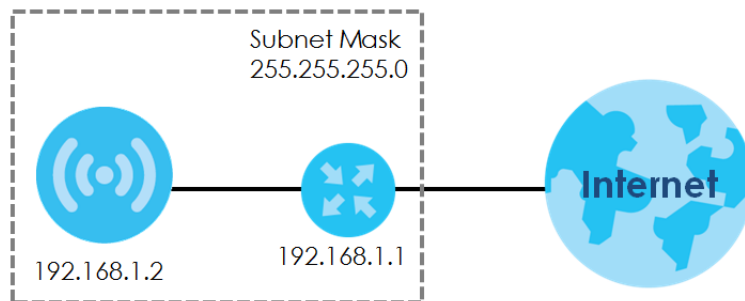

The figure above illustrates one possible setup of your NWA/WAC. The gateway IP address is 192.168.1.1 and the managed IP address of the NWA/WAC is 192.168.1.2 (default), but if the NWA/WAC is assigned an IP address by a DHCP server, the default (192.168.1.2) will not be used. The gateway and the NWA/WAC must belong in the same IP subnet to be able to communicate with each other.

#### 6.1.1 Management Mode

This discusses using the NWA/WAC in management mode, which determines whether the NWA/WAC is used in its standalone mode, or as part of a Control And Provisioning of Wireless Access Points (CAPWAP) network.

##### About CAPWAP

The NWA/WAC supports CAPWAP. This is Zyxel's implementation of the CAPWAP protocol (RFC 5415).

The CAPWAP data flow is protected by Datagram Transport Layer Security (DTLS).

The following figure illustrates a CAPWAP wireless network. You (**U**) configure the AP controller (**C**), which then automatically updates the configurations of the managed APs (**M1 ~ M4**).



Figure 42 CAPWAP Network Example

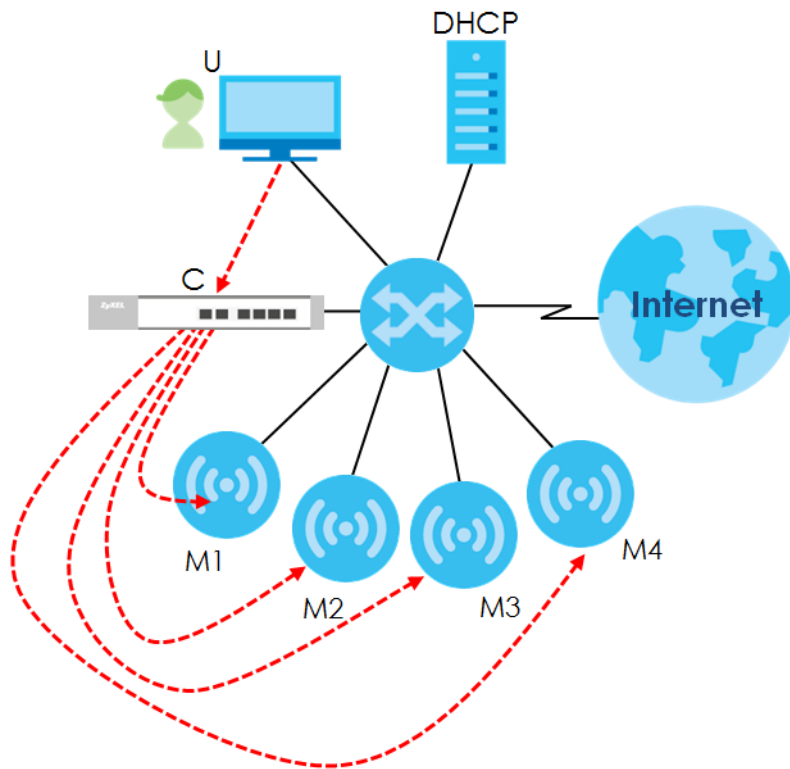

Note: The NWA/WAC can be a standalone AP (default), or a CAPWAP managed AP.

## CAPWAP Discovery and Management

The link between CAPWAP-enabled access points proceeds as follows:

- 1 An AP in managed AP mode joins a wired network (receives a dynamic IP address).
- 2 The AP sends out a discovery request, looking for a CAPWAP AP controller.
- 3 If there is an AP controller on the network, it receives the discovery request. If the AP controller is in **Manual** mode it adds the details of the AP to its **Unmanaged Access Points** list, and you decide which available APs to manage. If the AP controller is in **Always Accept** mode, it automatically adds the AP to its **Managed Access Points** list and provides the managed AP with default configuration information, as well as securely transmitting the DTLS pre-shared key. The managed AP is ready for association with wireless clients.

### Managed AP Finds the Controller

A managed NWA/WAC can find the controller in one of the following ways:

- Manually specify the controller's IP address in the Web Configurator's **AC (AP Controller) Discovery** screen.
- Get the controller's IP address from a DHCP server with the controller's IP address configured as option 138.
- Get the controller's IP address from a DNS server SRV (Service) record.



- Broadcasting to discover the controller within the broadcast domain.

Note: The AP controller needs to have a static IP address. If it is a DHCP client, set the DHCP server to reserve an IP address for the AP controller.

## CAPWAP and IP Subnets

By default, CAPWAP works only between devices with IP addresses in the same subnet.

However, you can configure CAPWAP to operate between devices with IP addresses in different subnets by doing the following.

- Activate DHCP. Your network's DHCP server must support option 138 defined in RFC 5415.
- Configure DHCP option 138 with the IP address of the CAPWAP AP controller on your network.

DHCP Option 138 allows the CAPWAP management request (from the AP in managed AP mode) to reach the AP controller in a different subnet, as shown in the following figure.

**Figure 43** CAPWAP and DHCP Option 138

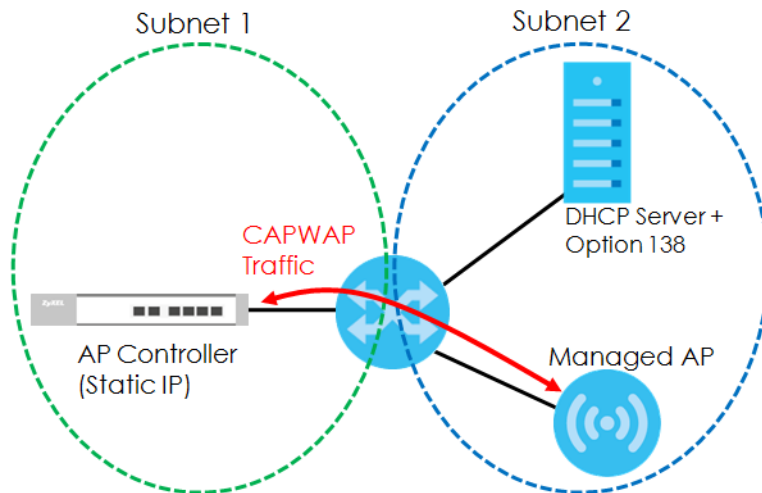

## Notes on CAPWAP

This section lists some additional features of Zyxel's implementation of the CAPWAP protocol.

- When the AP controller uses its internal Remote Authentication Dial In User Service (RADIUS) server, managed APs also use the AP controller's authentication server to authenticate wireless clients.
- If a managed AP's link to the AP controller is broken, the managed AP continues to use the wireless settings with which it was last provided.

## 6.1.2 What You Can Do in this Chapter

- The **IP Setting** screen ([Section 6.2 on page 78](#)) configures the NWA/WAC's LAN IP address.
- The **VLAN** screen ([Section 6.3 on page 79](#)) configures the NWA/WAC's VLAN settings.
- The **AC (AP Controller) Discovery** screen ([Section 6.3 on page 79](#)) configures the NWA/WAC's AP Controller settings.

## 6.2 IP Setting

Use this screen to configure the IP address for your NWA/WAC. To access this screen, click **Configuration > Network > IP Setting**.

**Figure 44** Configuration > Network > IP Setting

Each field is described in the following table.

**Table 34** Configuration > Network > IP Setting

LABEL	DESCRIPTION
IP Address Assignment	
Get Automatically	Select this to make the interface a DHCP client and automatically get the IP address, subnet mask, and gateway address from a DHCP server.
Use Fixed IP Address	Select this if you want to specify the IP address, subnet mask, and gateway manually.
IP Address	Enter the IP address for this interface.
Subnet Mask	Enter the subnet mask of this interface in dot decimal notation. The subnet mask indicates what part of the IP address is the same for all computers in the network.
Gateway	Enter the IP address of the gateway. The NWA/WAC sends packets to the gateway when it does not know how to route the packet to its destination. The gateway should be on the same network as the interface.
DNS Server IP Address	Enter the IP address of the DNS server.

Table 34 Configuration &gt; Network &gt; IP Setting (continued)

LABEL	DESCRIPTION
IPv6 Address Assignment	
Enable Stateless Address Auto-configuration (SLAAC)	Select this to enable IPv6 stateless auto-configuration on the NWA/WAC. The NWA/WAC will generate an IPv6 address itself from a prefix obtained from an IPv6 router in the network.
Link-Local Address	This displays the IPv6 link-local address and the network prefix that the NWA/WAC generates itself for the LAN interface.
IPv6 Address/Prefix Length	Enter the IPv6 address and the prefix length for the LAN interface if you want to use a static IP address. This field is optional.  The prefix length indicates what the left-most part of the IP address is the same for all computers in the network, that is, the network address.
Gateway	Enter the IPv6 address of the default outgoing gateway using colon (:) hexadecimal notation.
Metric	Enter the priority of the gateway (if any) on the LAN interface. The NWA/WAC decides which gateway to use based on this priority. The lower the number, the higher the priority. If two or more gateways have the same priority, the NWA/WAC uses the one that was configured first. Enter zero to set the metric to 1024 for IPv6.
DHCPv6 Client	Select this option to set the NWA/WAC to act as a DHCPv6 client.
DUID	This field displays the DHCP Unique IDentifier (DUID) of the NWA/WAC, which is unique and used for identification purposes when the NWA/WAC is exchanging DHCPv6 messages with others. See <a href="#">Appendix B on page 227</a> for more information.
Request Address	Select this option to get an IPv6 address from the DHCPv6 server.
DHCPv6 Request Options	Select this option to determine what additional information to get from the DHCPv6 server.
DNS Server	Select this option to obtain the IP address of the DNS server.
NTP Server	Select this option to obtain the IP address of the NTP server.
Apply	Click <b>Apply</b> to save your changes back to the NWA/WAC.
Reset	Click <b>Reset</b> to return the screen to its last-saved settings.

## 6.3 VLAN

This section discusses how to configure the NWA/WAC's VLAN settings.

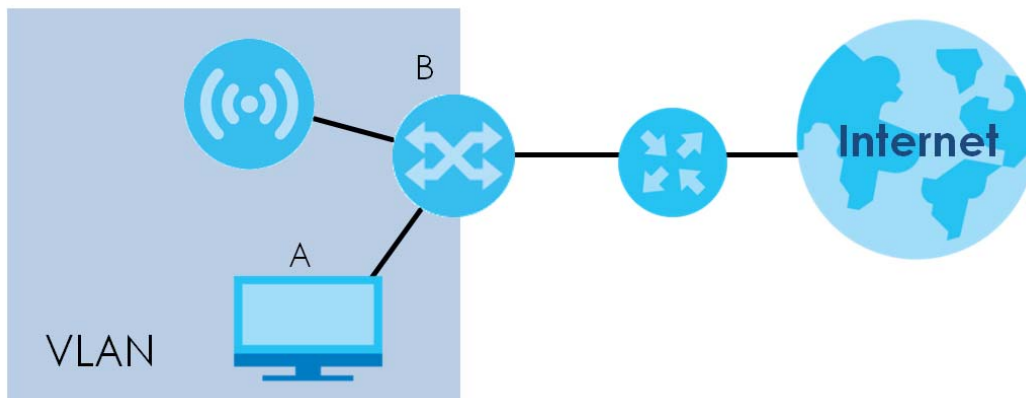
**Figure 45** Management VLAN Setup

In the figure above, to access and manage the NWA/WAC from computer **A**, the NWA/WAC and switch **B**'s ports to which computer **A** and the NWA/WAC are connected should be in the same VLAN.

A Virtual Local Area Network (VLAN) allows a physical network to be partitioned into multiple logical networks. Devices on a logical network belong to one group. A device can belong to more than one group. With VLAN, a device cannot directly talk to or hear from devices that are not in the same group(s); the traffic must first go through a router.

VLAN also increases network performance by limiting broadcasts to a smaller and more manageable logical broadcast domain. In traditional switched environments, all broadcast packets go to each and every individual port. With VLAN, all broadcasts are confined to a specific broadcast domain.

### IEEE 802.1Q Tag

The IEEE 802.1Q standard defines an explicit VLAN tag in the MAC header to identify the VLAN membership of a frame across bridges. A VLAN tag includes the 12-bit VLAN ID and 3-bit user priority. The VLAN ID associates a frame with a specific VLAN and provides the information that devices need to process the frame across the network.

Use this screen to configure the VLAN settings for your NWA/WAC. To access this screen, click **Configuration > Network > VLAN**.

The screen varies depending on whether the NWA/WAC has an extra Ethernet port (except the uplink port).

**Figure 46** Configuration > Network > VLAN (for NWA/WAC with multiple Ethernet ports)

**VLAN Settings**

Management VLAN ID:  (1~4094)

As Native VLAN i

**LAN Setting**

**Port Setting**

[Edit](#) [Activate](#) [Inactivate](#)

#	Status	Port	PVID
1	<span style="color: yellow;">i</span>	lan1	1

Page 1 of 1 | Show 50 items | Displaying 1 - 1 of 1

**VLAN Configuration**

[Add](#) [Edit](#) [Remove](#) [Activate](#) [Inactivate](#)

#	Status	Name	VID	Member
1	<span style="color: yellow;">i</span>	vlan1	1	lan1 (U)

Page 1 of 1 | Show 50 items | Displaying 1 - 1 of 1

**Figure 47** Configuration > Network > VLAN (for NWA/WAC with one Ethernet port)

**VLAN Settings**

Management VLAN ID:  (1~4094)

As Native VLAN i

**LAN Setting**

Each field is described in the following table.

Table 35 Configuration &gt; Network &gt; VLAN

LABEL	DESCRIPTION
VLAN Settings	
Management VLAN ID	Enter a VLAN ID for the NWA/WAC.
As Native VLAN	Select this option to treat this VLAN ID as a VLAN created on the NWA/WAC and not one assigned to it from outside the network.
LAN Setting	
Port Setting	
Edit	Double-click an entry or select it and click <b>Edit</b> to open a screen where you can modify the entry's settings. In some tables you can just click a table entry and edit it directly in the table. For those types of tables small red triangles display for table entries with changes that you have not yet applied.
Activate/Inactivate	To turn on an entry, select it and click <b>Activate</b> . To turn off an entry, select it and click <b>Inactivate</b> .
#	This is the index number of the port.

Table 35 Configuration &gt; Network &gt; VLAN (continued)

LABEL	DESCRIPTION
Status	This field indicates whether the port is enabled (a yellow bulb) or not (a gray bulb).
Port	This field displays the name of the port.
PVID	This field displays the port number of the VLAN ID.
VLAN Configuration	
Add	Click this to create a new entry. For features where the entry's position in the numbered list is important (features where the NWA/WAC applies the table's entries in order like the SSID for example), you can select an entry and click <b>Add</b> to create a new entry after the selected entry.
Edit	Double-click an entry or select it and click <b>Edit</b> to open a screen where you can modify the entry's settings. In some tables you can just click a table entry and edit it directly in the table. For those types of tables small red triangles display for table entries with changes that you have not yet applied.
Remove	To remove an entry, select it and click <b>Remove</b> . The NWA/WAC confirms you want to remove it before doing so.
Activate/ Inactivate	To turn on an entry, select it and click <b>Activate</b> . To turn off an entry, select it and click <b>Inactivate</b> .
#	This is the index number of the VLAN ID
Status	This field indicates whether the VLAN is enabled (a yellow bulb) or not (a gray bulb).
Name	This field displays the name of each VLAN.
VID	This field displays the VLAN ID.
Member	This field displays the VLAN membership to which the port belongs.
Apply	Click <b>Apply</b> to save your changes back to the NWA/WAC.
Reset	Click <b>Reset</b> to return the screen to its last-saved settings.

## 6.4 AC (AP Controller) Discovery

This section discusses how to configure the NWA/WAC's AC (AP Controller) Discovery settings. You can have the NWA/WAC managed by an AP controller on your network. When you do this, the NWA/WAC can be configured ONLY by the AP controller. See [Section 6.1.1 on page 75](#) for more information on management mode and AP Controller.

Note: The AC (AP Controller) Discovery settings are not available in all NWA/WACs. See [Section 1.1 on page 13](#) for more information.

If you want to return the NWA/WAC to standalone AP mode, you can do one of the two following options:

- Press the Reset button.
- Check the AP controller for the NWA/WAC's IP address and use FTP to upload the default configuration file to the NWA/WAC. You can get the configuration file at conf/system-default.conf. You must reboot the device after uploading the configuration file.

To access the Controller Discover screen, click **Configuration > Network > AC Discovery**.

**Figure 48** Configuration > Network > AC Discovery

Each field is described in the following table.

**Table 36** Configuration > Network > AC Discovery

LABEL	DESCRIPTION
Discovery Setting	
Auto	Select this option to use DHCP option 138/DNS SRV record/Broadcast to get the AP controller's IP address. If the NWA/WAC and a Zyxel AP controller, such as the NXC2500 or NXC5500, are in the same subnet, it will be managed by the controller automatically.
Manual	Select this option and enter the IP address of the AP controller manually. This is necessary when the AP Controller is not in the same subnet and you want it to manage the NWA/WAC.
Primary / Secondary Static AC IP	Specify the primary and secondary IP address of the AP controller to which the NWA/WAC connects.
Disable	Select this to manage the NWA/WAC using its own web configurator, neither managing nor managed by other devices. Please note if an AP Controller is in the same subnet, you will need to click <b>Disable</b> if you do not want the NWA/WAC to be managed.
Apply	Click <b>Apply</b> to save the information entered in this screen.  If you select <b>Auto</b> or <b>Manual</b> , the AP controller uploads the firmware package for managed AP mode to the NWA/WAC and you cannot log in as the web configurator is disabled; you must manage the NWA/WAC through the AP controller on your network.
Reset	Click <b>Reset</b> to return the screen to its last-saved settings.

# CHAPTER 7

## Wireless

### 7.1 Overview

This chapter discusses how to configure the wireless network settings in your NWA/WAC.

The following figure provides an example of a wireless network.

**Figure 49** Example of a Wireless Network

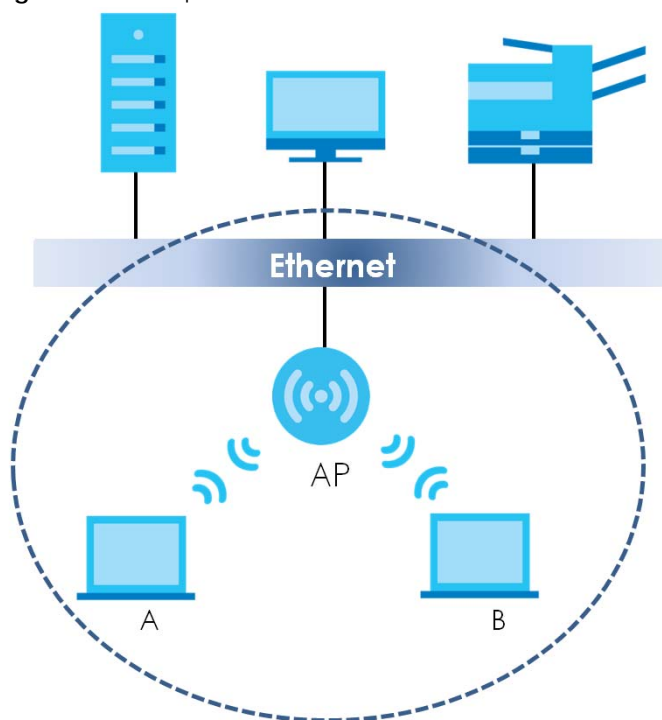

The wireless network is the part in the blue circle. In this wireless network, devices **A** and **B** are called wireless clients. The wireless clients use the access point (AP) to interact with other devices (such as the printer) or with the Internet. Your NWA/WAC is the AP.

#### 7.1.1 What You Can Do in this Chapter

- The **AP Management** screen ([Section 7.2 on page 85](#)) manages the NWA/WAC's general wireless settings.
- The **Rogue AP** screen ([Section 7.3 on page 88](#)) allows you to assign APs either to the rogue AP list or the friendly AP list.
- The **Load Balancing** screen ([Section 7.4 on page 91](#)) configures network traffic load balancing between the APs and the NWA/WAC.
- The **DCS** screen ([Section 7.5 on page 94](#)) configures dynamic radio channel selection.



## 7.1.2 What You Need to Know

The following terms and concepts may help as you read this chapter.

### Station / Wireless Client

A station or wireless client is any wireless-capable device that can connect to an AP using a wireless signal.

### Dynamic Channel Selection (DCS)

Dynamic Channel Selection (DCS) is a feature that allows an AP to automatically select the radio channel upon which it broadcasts by scanning the area around it and determining what channels are currently being used by other devices.

### Load Balancing (Wireless)

Wireless load balancing is the process where you limit the number of connections allowed on an wireless access point (AP) or you limit the amount of wireless traffic transmitted and received on it so the AP does not become overloaded.

## 7.2 AP Management

Use this screen to manage the NWA/WAC's general wireless settings. Click **Configuration > Wireless > AP Management** to access this screen.

Figure 50 Configuration &gt; Wireless &gt; AP Management

WLAN Setting

---

### Radio 1 Setting

Radio 1 Activate

Radio 1 OP Mode:     AP Mode    MON Mode    Root AP    Repeater i

Radio 1 Profile(Only for 2.4G):   

Max Output Power:        dBm (0~30)

#### MBSSID Settings

[Edit](#)

#	SSID Profile
1	Wiz_SSID_1
2	Wiz_SSID_2
3	Wiz_SSID_3
4	disable
5	disable
6	disable
7	disable
8	disable

---

### Radio 2 Setting

Radio 2 Activate

Radio 2 OP Mode:     AP Mode    MON Mode    Root AP    Repeater i

Radio 2 Profile(Only for 5G):   

Radio 2 WDS Profile:   

Uplink Selection     AUTO    Manual

Radio 2 Uplink MAC Address:     i

Max Output Power:        dBm (0~30)

#### MBSSID Settings

[Edit](#)

#	SSID Profile
1	Wiz_SSID_1
2	Wiz_SSID_2
3	Wiz_SSID_3
4	disable
5	disable
6	disable
7	disable
8	disable

Each field is described in the following table.

Table 37 Configuration &gt; Wireless &gt; AP Management

LABEL	DESCRIPTION
Radio 1 Setting	
Radio 1 Activate	Select the check box to enable the NWA/WAC's first (default) radio.

Table 37 Configuration &gt; Wireless &gt; AP Management (continued)

LABEL	DESCRIPTION
Radio 1 OP Mode	<p>Select the operating mode for radio 1.</p> <p><b>AP Mode</b> means the radio can receive connections from wireless clients and pass their data traffic through to the NWA/WAC to be managed (or subsequently passed on to an upstream gateway for managing).</p> <p><b>MON Mode</b> means the radio monitors the broadcast area for other APs, then passes their information on to the NWA/WAC where it can be determined if those APs are friendly or rogue. If a radio is set to this mode it cannot receive connections from wireless clients.</p> <p><b>Root AP</b> means the radio acts as an AP and also supports the wireless connections with other APs (in repeater mode) to form a WDS (Wireless Distribution System) to extend its wireless network.</p> <p><b>Repeater</b> means the radio can establish a wireless connection with other APs (in either root AP or repeater mode) to form a WDS.</p>
Radio 1 Profile	<p>Select the radio profile the radio uses.</p> <p>Note: You can only apply a 2.4G AP radio profile to radio 1. Otherwise, the first radio will not be working.</p>
Radio 1 WDS Profile	<p>This field is available only when the radio is in <b>Root AP</b> or <b>Repeater</b> mode.</p> <p>Select the WDS profile the radio uses to connect to a root AP or repeater.</p>
Uplink Selection Mode	<p>This field is available only when the radio is in <b>Repeater</b> mode.</p> <p>Select <b>AUTO</b> to have the NWA/WAC automatically use the settings in the applied WDS profile to connect to a root AP or repeater.</p> <p>Select <b>Manual</b> to have the NWA/WAC connect to the root AP or repeater with the MAC address specified in the <b>Radio 1 Uplink MAC Address</b> field.</p>
Max Output Power	<p>Enter the maximum output power (between 0 to 30 dBm) of the NWA/WAC in this field. If there is a high density of APs in an area, decrease the output power of the NWA/WAC to reduce interference with other APs.</p> <p>Note: Reducing the output power also reduces the NWA/WAC's effective broadcast radius.</p>
MBSSID Settings	
Edit	<p>Double-click an entry or select it and click <b>Edit</b> to open a screen where you can modify the entry's settings. In some tables you can just click a table entry and edit it directly in the table. For those types of tables small red triangles display for table entries with changes that you have not yet applied.</p>
#	<p>This field shows the index number of the SSID</p>
SSID Profile	<p>This field displays the SSID profile that is associated with the radio profile.</p>
Radio 2 Setting	
Radio 2 Activate	<p>This displays if the NWA/WAC has a second radio.</p> <p>Select the check box to enable the NWA/WAC's second radio.</p>

Table 37 Configuration &gt; Wireless &gt; AP Management (continued)

LABEL	DESCRIPTION
Radio 2 OP Mode	<p>This displays if the NWA/WAC has a second radio. Select the operating mode for radio 2.</p> <p><b>AP Mode</b> means the radio can receive connections from wireless clients and pass their data traffic through to the NWA/WAC to be managed (or subsequently passed on to an upstream gateway for managing).</p> <p><b>MON Mode</b> means the radio monitors the broadcast area for other APs, then passes their information on to the NWA/WAC where it can be determined if those APs are friendly or rogue. If a radio is set to this mode it cannot receive connections from wireless clients.</p> <p><b>Root AP</b> means the radio acts as an AP and also supports the wireless connections with other APs (in repeater mode) to form a WDS to extend its wireless network.</p> <p><b>Repeater</b> means the radio can establish a wireless connection with other APs (in either root AP or repeater mode) to form a WDS.</p>
Radio 2 Profile	<p>This displays if the NWA/WAC has a second radio. Select the radio profile the radio uses.</p> <p>Note: You can only apply a 5G AP radio profile to radio 2. Otherwise, the second radio will not be working.</p>
Radio 2 WDS Profile	<p>This field is available only when the radio is in <b>Root AP</b> or <b>Repeater</b> mode.</p> <p>Select the WDS profile the radio uses to connect to a root AP or repeater.</p>
Uplink Selection Mode	<p>This field is available only when the radio is in <b>Repeater</b> mode.</p> <p>Select <b>AUTO</b> to have the NWA/WAC automatically use the settings in the applied WDS profile to connect to a root AP or repeater.</p> <p>Select <b>Manual</b> to have the NWA/WAC connect to the root AP or repeater with the MAC address specified in the <b>Radio 2 Uplink MAC Address</b> field.</p>
Max Output Power	<p>Enter the maximum output power (between 0 to 30 dBm) of the NWA/WAC in this field. If there is a high density of APs in an area, decrease the output power of the NWA/WAC to reduce interference with other APs.</p> <p>Note: Reducing the output power also reduces the NWA/WAC's effective broadcast radius.</p>
MBSSID Settings	
Edit	<p>Double-click an entry or select it and click <b>Edit</b> to open a screen where you can modify the entry's settings. In some tables you can just click a table entry and edit it directly in the table. For those types of tables small red triangles display for table entries with changes that you have not yet applied.</p>
#	This field shows the index number of the SSID
SSID Profile	This field shows the SSID profile that is associated with the radio profile.
Apply	Click <b>Apply</b> to save your changes back to the NWA/WAC.
Reset	Click <b>Reset</b> to return the screen to its last-saved settings.

## 7.3 Rogue AP

Use this screen to assign APs either to the rogue AP list or the friendly AP list. A rogue AP is a wireless access point operating in a network's coverage area that is not under the control of the network administrator, and which can potentially open up holes in a network's security.

Click **Configuration > Wireless > Rogue AP** to access this screen.

Figure 51 Configuration &gt; Wireless &gt; Rogue AP (for NWA/WAC that supports Monitor mode)

**Rogue/Friendly AP List**

**Rogue/Friendly AP List**

#	Role	MAC Address	Description
1	rogue-ap	00:A0:C5:01:23:45	rogueexample

Displaying 1 - 1 of 1

**Rogue AP List Importing/Exporting**

File Path:

**Friendly AP List Importing/Exporting**

File Path:

Figure 52 Configuration &gt; Wireless &gt; Rogue AP (for NWA/WAC that doesn't support Monitor mode)

**Rogue/Friendly AP List**

**Rogue AP Detection Setting**

Enable Rogue AP Detection

**Suspected Rogue AP Classification Rule**

Weak Security (Open,WEP,WPA-PSK)  
 Hidden SSID  
 SSID Keyword

#	SSID Keyword
1	test

**Rogue/Friendly AP List**

#	Role	MAC Address	Description
1	friendly-ap	60:31:97:7D:5B:51	
2	rogue-ap	00:A0:C5:01:23:45	example

Displaying 1 - 2 of 2

**Rogue AP List Importing/Exporting**

File Path:

**Friendly AP List Importing/Exporting**

File Path:

Each field is described in the following table.

Table 38 Configuration > Wireless > Rogue AP

LABEL	DESCRIPTION
Rogue AP Detection Setting	
Enable Rogue AP Detection	Select this option to detect Rogue APs in the network.
Suspected Rogue AP Classification Rule	Click the check boxes ( <b>Weak Security (Open, WEP, WPA-PSK)</b> , <b>Hidden SSID</b> , <b>SSID Keyword</b> ) of the characteristics an AP should have for the NWA/WAC to rule it as a Rogue AP.
Add	Click this to add an SSID Keyword.
Edit	Select an SSID Keyword and click this button to modify it.
Remove	Select an existing SSID keyword and click this button to delete it.
#	This is the SSID Keyword's index number in this list.
SSID Keyword	This field displays the SSID Keyword.
Rogue/Friendly AP List	
Add	Click this button to add an AP to the list and assign it either friendly or rogue status.
Edit	Select an AP in the list to edit and reassign its status.
Remove	Select an AP in the list to remove.
#	This field is a sequential value, and it is not associated with any interface.
Role	This field indicates whether the selected AP is a <b>rogue-ap</b> or a <b>friendly-ap</b> . To change the AP's role, click the <b>Edit</b> button.
MAC Address	This field indicates the AP's radio MAC address.
Description	This field displays the AP's description. You can modify this by clicking the <b>Edit</b> button.
Rogue/Friendly AP List Importing/Exporting	These controls allow you to export the current list of rogue and friendly APs or import existing lists.
File Path / Browse / Importing	Enter the file name and path of the list you want to import or click the <b>Browse</b> button to locate it. Once the <b>File Path</b> field has been populated, click <b>Importing</b> to bring the list into the NWA/WAC.  You need to wait a while for the importing process to finish.
Exporting	Click this button to export the current list of either rogue APs or friendly APs.
Apply	Click <b>Apply</b> to save your changes back to the NWA/WAC.
Reset	Click <b>Reset</b> to return the screen to its last-saved settings.

### 7.3.1 Add/Edit Rogue/Friendly List

Click **Add** or select an AP and click the **Edit** button in the **Configuration > Wireless > Rogue AP** table to display this screen.

**Figure 53** Configuration > Wireless > Rogue AP > Add/Edit Rogue/Friendly AP List

Each field is described in the following table.

**Table 39** Configuration > Wireless > Rogue AP > Add/Edit Rogue/Friendly AP List

LABEL	DESCRIPTION
MAC	Enter the MAC address of the AP you want to add to the list. A MAC address is a unique hardware identifier in the following hexadecimal format: xx:xx:xx:xx:xx:xx where xx is a hexadecimal number separated by colons.
Description	Enter up to 60 characters for the AP's description. Spaces and underscores are allowed.
Role	Select either <b>Rogue AP</b> or <b>Friendly AP</b> for the AP's role.
OK	Click <b>OK</b> to save your changes back to the NWA/WAC.
Cancel	Click <b>Cancel</b> to close the window with changes unsaved.

## 7.4 Load Balancing

Use this screen to configure wireless network traffic load balancing between the APs on your network. Click **Configuration > Wireless > Load Balancing** to access this screen.

**Figure 54** Configuration > Wireless > Load Balancing

Each field is described in the following table.

Table 40 Configuration > Wireless > Load Balancing

LABEL	DESCRIPTION
Enable Load Balancing	<p>Select this to enable load balancing on the NWA/WAC.</p> <p>Use this section to configure wireless network traffic load balancing between the managed APs in this group.</p>
Mode	<p>Select a mode by which load balancing is carried out.</p> <p>Select <b>By Station Number</b> to balance network traffic based on the number of specified stations connected to the NWA/WAC.</p> <p>Select <b>By Traffic Level</b> to balance network traffic based on the volume generated by the stations connected to the NWA/WAC.</p> <p>Select <b>By Smart Classroom</b> to balance network traffic based on the number of specified stations connected to the NWA/WAC. The NWA/WAC ignores association request and authentication request packets from any new station when the maximum number of stations is reached.</p> <p>If you select <b>By Station Number</b> or <b>By Traffic Level</b>, once the threshold is crossed (either the maximum station numbers or with network traffic), the NWA/WAC delays association request and authentication request packets from any new station that attempts to make a connection. This allows the station to automatically attempt to connect to another, less burdened AP if one is available.</p>
Max Station Number	<p>Enter the threshold number of stations at which the NWA/WAC begins load balancing its connections.</p>
Traffic Level	<p>Select the threshold traffic level at which the NWA/WAC begins load balancing its connections (<b>Low, Medium, High</b>).</p> <p>The maximum bandwidth allowed for each level is:</p> <ul style="list-style-type: none"> <li>• <b>Low</b> - 11 Mbps,</li> <li>• <b>Medium</b> - 23 Mbps</li> <li>• <b>High</b> - 35M bps</li> </ul>
Disassociate station when overloaded	<p>This function is enabled by default and the disassociation priority is always <b>Signal Strength</b> when you set <b>Mode</b> to <b>By Smart Classroom</b>.</p> <p>Select this option to disassociate wireless clients connected to the AP when it becomes overloaded. If you do not enable this option, then the AP simply delays the connection until it can afford the bandwidth it requires, or it transfers the connection to another AP within its broadcast radius.</p> <p>The disassociation priority is determined automatically by the NWA/WAC and is as follows:</p> <ul style="list-style-type: none"> <li>• <b>Idle Timeout</b> - Devices that have been idle the longest will be kicked first. If none of the connected devices are idle, then the priority shifts to <b>Signal Strength</b>.</li> <li>• <b>Signal Strength</b> - Devices with the weakest signal strength will be kicked first.</li> </ul> <p>Note: If you enable this function, you should ensure that there are multiple APs within the broadcast radius that can accept any rejected or kicked wireless clients; otherwise, a wireless client attempting to connect to an overloaded AP will be disassociated permanently and never be allowed to connect.</p>
Apply	<p>Click <b>Apply</b> to save your changes back to the NWA/WAC.</p>
Reset	<p>Click <b>Reset</b> to return the screen to its last-saved settings.</p>



## 7.4.1 Disassociating and Delaying Connections

When your AP becomes overloaded, there are two basic responses it can take. The first one is to “delay” a client connection. This means that the AP withholds the connection until the data transfer throughput is lowered or the client connection is picked up by another AP. If the client is picked up by another AP then the original AP cannot resume the connection.

For example, here the AP has a balanced bandwidth allotment of 6 Mbps. If laptop **R** connects and it pushes the AP over its allotment, say to 7 Mbps, then the AP delays the red laptop's connection until it can afford the bandwidth or the laptop is picked up by a different AP with bandwidth to spare.

**Figure 55** Delaying a Connection

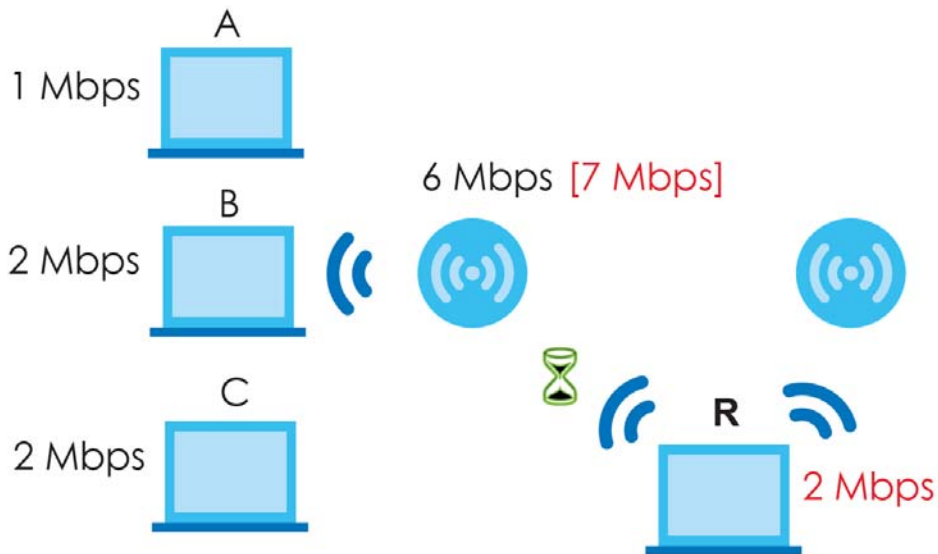

The second response your AP can take is to kick the connections that are pushing it over its balanced bandwidth allotment.

**Figure 56** Kicking a Connection

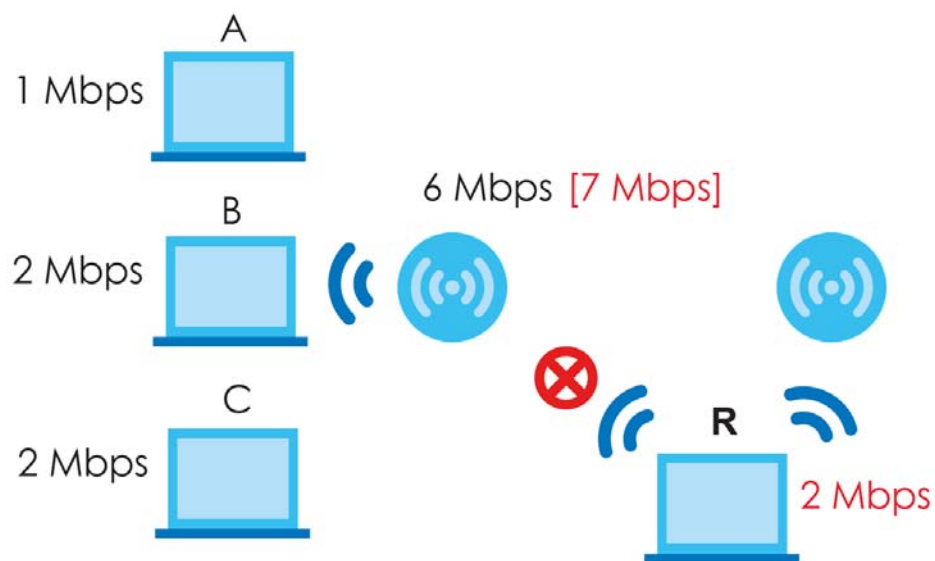

Connections are kicked based on either **idle timeout** or **signal strength**. The NWA/WAC first looks to see which devices have been idle the longest, then starts kicking them in order of highest idle time. If no connections are idle, the next criteria the NWA/WAC analyzes is signal strength. Devices with the weakest signal strength are kicked first.

## 7.5 DCS

Use this screen to configure dynamic radio channel selection. Click **Configuration > Wireless > DCS** to access this screen.

**Figure 57** Configuration > Wireless > DCS

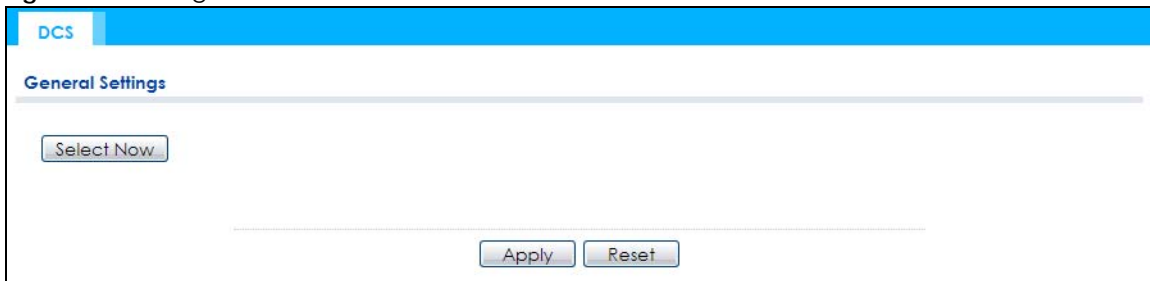

Each field is described in the following table.

Table 41 Configuration > Wireless > DCS

LABEL	DESCRIPTION
Select Now	Click this to have the NWA/WAC scan for and select an available channel immediately.
Apply	Click <b>Apply</b> to save your changes back to the NWA/WAC.
Reset	Click <b>Reset</b> to return the screen to its last-saved settings.

## 7.6 Technical Reference

The following section contains additional technical information about the features described in this chapter.

### Dynamic Channel Selection

When numerous APs broadcast within a given area, they introduce the possibility of heightened radio interference, especially if some or all of them are broadcasting on the same radio channel. If the interference becomes too great, then the network administrator must open his AP configuration options and manually change the channel to one that no other AP is using (or at least a channel that has a lower level of interference) in order to give the connected stations a minimum degree of interference. Dynamic channel selection frees the network administrator from this task by letting the AP do it automatically. The AP can scan the area around it looking for the channel with the least amount of interference.

In the 2.4 GHz spectrum, each channel from 1 to 13 is broken up into discrete 22 MHz segments that are spaced 5 MHz apart. Channel 1 is centered on 2.412 GHz while channel 13 is centered on 2.472 GHz.

**Figure 58** An Example Three-Channel Deployment

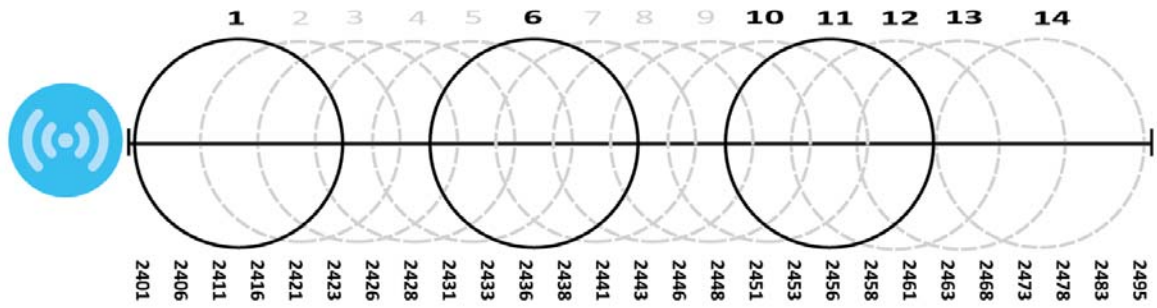

Three channels are situated in such a way as to create almost no interference with one another if used exclusively: 1, 6 and 11. When an AP broadcasts on any of these three channels, it should not interfere with neighboring APs as long as they are also limited to same trio.

**Figure 59** An Example Four-Channel Deployment

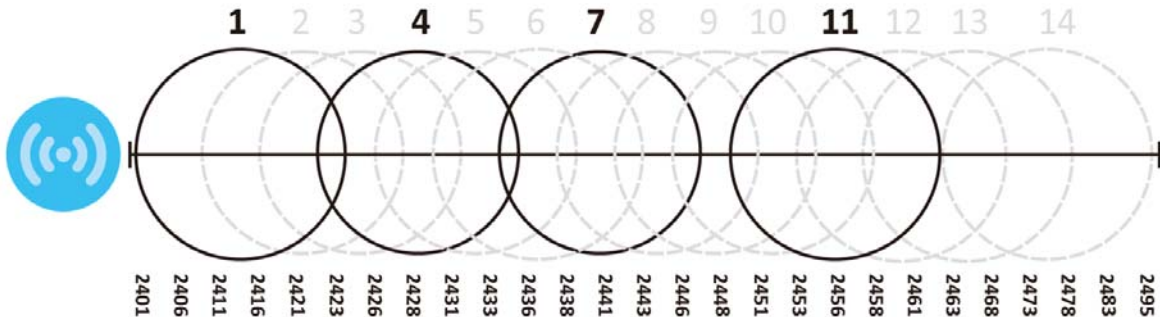

However, some regions require the use of other channels and often use a safety scheme with the following four channels: 1, 4, 7 and 11. While they are situated sufficiently close to both each other and the three so-called "safe" channels (1,6 and 11) that interference becomes inevitable, the severity of it is dependent upon other factors: proximity to the affected AP, signal strength, activity, and so on.

Finally, there is an alternative four channel scheme for ETSI, consisting of channels 1, 5, 9, 13. This offers significantly less overlap than the other one.

**Figure 60** An Alternative Four-Channel Deployment

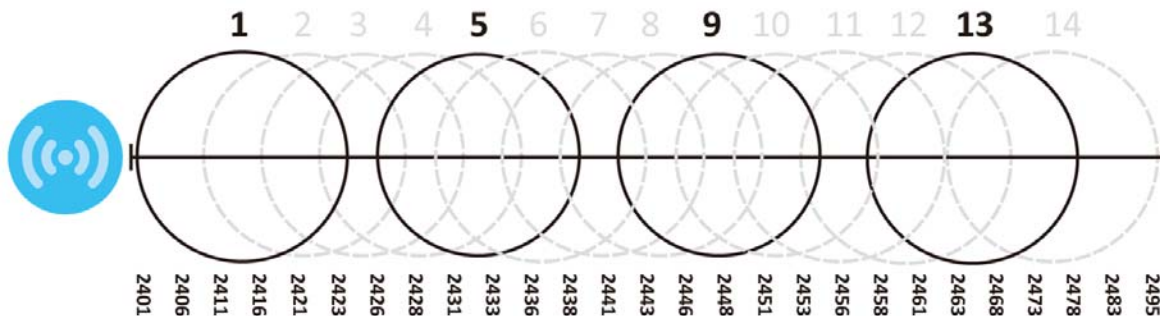

## Load Balancing

Because there is a hard upper limit on an AP's wireless bandwidth, load balancing can be crucial in areas crowded with wireless users. Rather than let every user connect and subsequently dilute the

available bandwidth to the point where each connecting device receives a meager trickle, the load balanced AP instead limits the incoming connections as a means to maintain bandwidth integrity.

There are three kinds of wireless load balancing available on the NWA/WAC:

**Load balancing by station number** limits the number of devices allowed to connect to your AP. If you know exactly how many stations you want to let connect, choose this option.

For example, if your company's graphic design team has their own AP and they have 10 computers, you can load balance for 10. Later, if someone from the sales department visits the graphic design team's offices for a meeting and he tries to access the network, his computer's connection is delayed, giving it the opportunity to connect to a different, neighboring AP. If he still connects to the AP regardless of the delay, then the AP may boot other people who are already connected in order to associate with the new connection.

**Load balancing by smart classroom** also limits the number of devices allowed to connect to your AP. But any new connections will be just rejected when the AP is overloaded.

**Load balancing by traffic level** limits the number of connections to the AP based on maximum bandwidth available. If you are uncertain as to the exact number of wireless connections you will have then choose this option. By setting a maximum bandwidth cap, you allow any number of devices to connect as long as their total bandwidth usage does not exceed the configured bandwidth cap associated with this setting. Once the cap is hit, any new connections are rejected or delayed provided that there are other APs in range.

Imagine a coffee shop in a crowded business district that offers free wireless connectivity to its customers. The coffee shop owner can't possibly know how many connections his AP will have at any given moment. As such, he decides to put a limit on the bandwidth that is available to his customers but not on the actual number of connections he allows. This means anyone can connect to his wireless network as long as the AP has the bandwidth to spare. If too many people connect and the AP hits its bandwidth cap then all new connections must basically wait for their turn or get shunted to the nearest identical AP.

# CHAPTER 8

## Bluetooth

### 8.1 Overview

Use this screen to configure the Bluetooth advertising settings for the NWA/WAC that supports Bluetooth Low Energy (BLE). Bluetooth Low Energy, which is also known as Bluetooth Smart, transmits less data over a shorter distance and consumes less power than classic Bluetooth.

#### 8.1.1 What You Need To Know

iBeacon is Apple's communication protocol on top of Bluetooth Low Energy wireless technology. Beacons (Bluetooth radio transmitters) or BLE enabled devices broadcast packets to every device around it to announce their presence. Advertising packets contain their iBeacon ID which mainly consists of the UUID, major number, minor number and TX (transmit) power. The ID is used to distinguish beacons in your network.

The universally unique identifier (UUID) is a 128-bit (16-byte) number which can be used to identify a service, a device, a manufacturer or an owner. The 2-byte major number is to identify and distinguish a group, and the 2-byte minor number is to identify and distinguish an individual.

For example, you can set all the beacons in one network to share the same UUID, the beacons in a particular room to use the same major number, and each beacon in the room can have its own minor number.

	NETWORK A		
	ROOM X		ROOM Y
	BEACON 1	BEACON 2	BEACON 3
UUID	EBAECFAF-DFE0-4039-BE5A-F030EED4303C		
Major	10	10	20
Minor	1	2	1

### 8.2 Bluetooth Advertising Settings

The NWA/WAC communicates with another BLE enabled device using advertisements. Use this screen to configure the beacon ID(s) to be included in the advertising packet. You can have up to five combinations of the UUID, Major and Minor parameters.

To access this screen, click **Configuration > Bluetooth > Advertising Settings**.

Figure 61 Configuration &gt; Bluetooth &gt; Advertising Settings

#	Status	UUID	Major	Minor
1			0	0
2			0	0
3			0	0
4			0	0
5			0	0

The following table describes the labels in this screen.

Table 42 Configuration &gt; Bluetooth &gt; Advertising Settings

LABEL	DESCRIPTION
Edit	Click this to edit the selected entry.
Activate	To turn on an entry, select it and click <b>Activate</b> .
Inactivate	To turn off an entry, select it and click <b>Inactivate</b> .
#	This field is a sequential value, and it is not associated with a specific entry.
Status	This field shows whether or not the entry is activated. A yellow bulb signifies that this rule is active. A gray bulb signifies that this rule is not active.
UUID	This field indicates the UUID to be included in the Bluetooth advertising packets.
Major	This field indicates the major number to be included in the Bluetooth advertising packets.
Minor	This field indicates the minor number to be included in the Bluetooth advertising packets.

## 8.2.1 Edit Advertising Settings

Select an entry in the **Configuration > Bluetooth > Advertising Settings** screen and click the **Edit** icon to open the **Edit Advertising** screen. Use this screen to configure the beacon ID in the Bluetooth advertising packets.

Figure 62 Configuration &gt; Bluetooth &gt; Advertising Settings &gt; Edit

The following table describes the labels in this screen.

Table 43 Configuration > Bluetooth > Advertising Settings > Edit

LABEL	DESCRIPTION
Activate	Select this option to enable the advertising settings.
UUID	To specify a UUID of the NWA/WAC's beacon ID, enter 32 hexadecimal digits in the range of "A-F", "a-f" and "0-9", split into five groups separated by hyphens (-). The UUID format is as follows: xxxxxxxx-xxxx-xxxx-xxxx-xxxxxxxxxxxx (8-4-4-4-12)
Generate new UUID	Click this button to have the NWA/WAC generate a UUID automatically.
Major	Enter an integer from 0 to 65535 as the major value to identify the beacon.
Minor	Enter an integer from 0 to 65535 as the minor value to identify the beacon.
OK	Click <b>OK</b> to save your changes back to the NWA/WAC.
Cancel	Click <b>Cancel</b> to exit this screen without saving your changes.

# CHAPTER 9

## User

### 9.1 Overview

This chapter describes how to set up user accounts and user settings for the NWA/WAC.

#### 9.1.1 What You Can Do in this Chapter

- The **User** screen (see [Section 9.2 on page 101](#)) provides a summary of all user accounts.
- The **Setting** screen (see [Section 9.3 on page 103](#)) controls default settings, login settings, lockout settings, and other user settings for the NWA/WAC.

#### 9.1.2 What You Need To Know

The following terms and concepts may help as you read this chapter.

##### User Account

A user account defines the privileges of a user logged into the NWA/WAC. User accounts are used in controlling access to configuration and services in the NWA/WAC.

##### User Types

These are the types of user accounts the NWA/WAC uses.

Table 44 Types of User Accounts

TYPE	ABILITIES	LOGIN METHOD(S)
Admin Users		
admin	Change NWA/WAC configuration (web, CLI)	WWW, TELNET, SSH, FTP
limited-admin	Look at NWA/WAC configuration (web, CLI) Perform basic diagnostics (CLI)	WWW, TELNET, SSH
Access Users		
user	Used for the embedded RADIUS server and SNMPv3 user access  Browse user-mode commands (CLI)	

Note: The default **admin** account is always authenticated locally, regardless of the authentication method setting.



## 9.2 User Summary

The **User** screen provides a summary of all user accounts. To access this screen click **Configuration > Object > User**.

**Figure 63** Configuration > Object > User

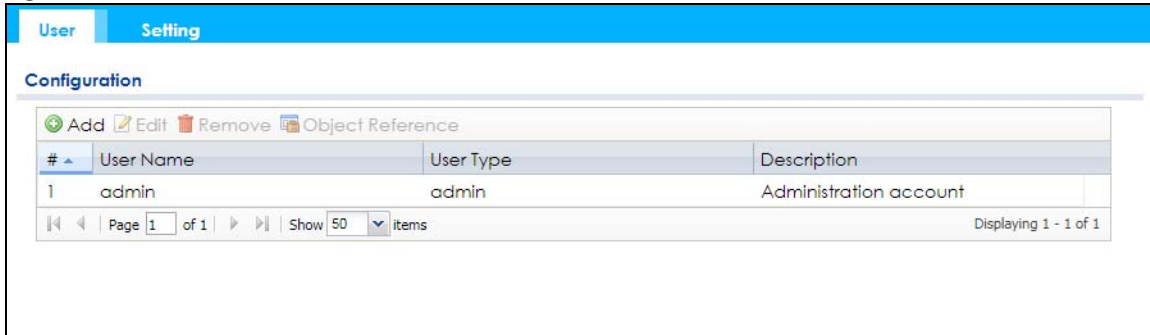

The following table describes the labels in this screen.

**Table 45** Configuration > Object > User

LABEL	DESCRIPTION
Add	Click this to create a new entry.
Edit	Double-click an entry or select it and click <b>Edit</b> to open a screen where you can modify the entry's settings.
Remove	To remove an entry, select it and click <b>Remove</b> . The NWA/WAC confirms you want to remove it before doing so.
Object Reference	Select an entry and click <b>Object Reference</b> to open a screen that shows which settings use the entry.
#	This field is a sequential value, and it is not associated with a specific user.
User Name	This field displays the user name of each user.
User Type	This field displays type of user this account was configured as. <ul style="list-style-type: none"> <li><b>admin</b> - this user can look at and change the configuration of the NWA/WAC</li> <li><b>limited-admin</b> - this user can look at the configuration of the NWA/WAC but not to change it</li> <li><b>user</b> - this user has access to the NWA/WAC's services but cannot look at the configuration</li> </ul>
Description	This field displays the description for each user.

### 9.2.1 Add/Edit User

The **User Add/Edit** screen allows you to create a new user account or edit an existing one.

#### 9.2.1.1 Rules for User Names

Enter a user name from 1 to 31 characters.

The user name can only contain the following characters:

- Alphanumeric A-z 0-9 (there is no unicode support)
- \_ [underscores]

- - [dashes]

The first character must be alphabetical (A-Z a-z), an underscore (\_), or a dash (-). Other limitations on user names are:

- User names are case-sensitive. If you enter a user 'bob' but use 'BOB' when connecting via CIFS or FTP, it will use the account settings used for 'BOB' not 'bob'.
- User names have to be different than user group names.
- Here are the reserved user names:
  - adm
  - admin
  - any
  - bin
  - daemon
  - debug
  - devicehaecived
  - ftp
  - games
  - halt
  - ldap-users
  - lp
  - mail
  - news
  - nobody
  - operator
  - radius-users
  - root
  - shutdown
  - sshd
  - sync
  - uucp
  - zyxel

To access this screen, go to the **User** screen, and click **Add** or **Edit**.

**Figure 64** Configuration > Object > User > Add/Edit A User

The following table describes the labels in this screen.

**Table 46** Configuration > User > User > Add/Edit A User

LABEL	DESCRIPTION
User Name	Type the user name for this user account. You may use 1-31 alphanumeric characters, underscores(_), or dashes (-), but the first character cannot be a number. This value is case-sensitive. User names have to be different than user group names, and some words are reserved.
User Type	Select what type of user this is. Choices are: <ul style="list-style-type: none"> <li>• <b>admin</b> - this user can look at and change the configuration of the NWA/WAC</li> <li>• <b>limited-admin</b> - this user can look at the configuration of the NWA/WAC but not to change it</li> <li>• <b>user</b> - this is used for embedded RADIUS server and SNMPv3 user access</li> </ul>
Password	Enter the password of this user account. It can consist of 4 - 63 alphanumeric characters.
Retype	Re-enter the password to make sure you have entered it correctly.
Description	Enter the description of each user, if any. You can use up to 60 printable ASCII characters. Default descriptions are provided.

Table 46 Configuration &gt; User &gt; User &gt; Add/Edit A User (continued)

LABEL	DESCRIPTION
Authentication Timeout Settings	This field is not available if the user type is <b>user</b> . If you want to set authentication timeout to a value other than the default settings, select <b>Use Manual Settings</b> then fill your preferred values in the fields that follow.
Lease Time	This field is not available if the user type is <b>user</b> . Enter the number of minutes this user has to renew the current session before the user is logged out. You can specify 1 to 1440 minutes. You can enter 0 to make the number of minutes unlimited. Admin users renew the session every time the main screen refreshes in the Web Configurator.
Reauthentication Time	This field is not available if the user type is <b>user</b> . Type the number of minutes this user can be logged into the NWA/WAC in one session before the user has to log in again. You can specify 1 to 1440 minutes. You can enter 0 to make the number of minutes unlimited. Unlike <b>Lease Time</b> , the user has no opportunity to renew the session without logging out.
OK	Click <b>OK</b> to save your changes back to the NWA/WAC.
Cancel	Click <b>Cancel</b> to exit this screen without saving your changes.

## 9.3 Setting

This screen controls default settings, login settings, lockout settings, and other user settings for the NWA/WAC.

To access this screen, login to the Web Configurator, and click **Configuration > Object > User > Setting**.

Figure 65 Configuration &gt; Object &gt; User &gt; Setting

**User Default Setting**

**Default Authentication Timeout Settings**

[Edit](#)

#	User Type	Lease Time	Reauthentication Time
1	admin	1440	1440
2	limited-admin	1440	1440
3	user	-	-

Page 1 of 1 | Show 50 items | Displaying 1 - 3 of 3

**User Logon Settings**

Limit the number of simultaneous logons for administration account

Maximum number per administration account:  (1-64)

**User Lockout Settings**

Enable logon retry limit

Maximum retry count:  (1-99)

Lockout period:  (1-65535 minutes)

The following table describes the labels in this screen.

Table 47 Configuration &gt; Object &gt; User &gt; Setting

LABEL	DESCRIPTION
User Default Setting	
Default Authentication Timeout Settings	These authentication timeout settings are used by default when you create a new user account. They also control the settings for any existing user accounts that are set to use the default settings. You can still manually configure any user account's authentication timeout settings.
Edit	Double-click an entry or select it and click <b>Edit</b> to open a screen where you can modify the entry's settings.
#	This field is a sequential value, and it is not associated with a specific entry.
User Type	These are the kinds of user account the NWA/WAC supports. <ul style="list-style-type: none"> <li><b>admin</b> - this user can look at and change the configuration of the NWA/WAC</li> <li><b>limited-admin</b> - this user can look at the configuration of the NWA/WAC but not to change it</li> <li><b>user</b> - this is used for embedded RADIUS server and SNMPv3 user access</li> </ul>
Lease Time	This is the default lease time in minutes for each type of user account. It defines the number of minutes the user has to renew the current session before the user is logged out.  Admin users renew the session every time the main screen refreshes in the Web Configurator.
Reauthentication Time	This is the default reauthentication time in minutes for each type of user account. It defines the number of minutes the user can be logged into the NWA/WAC in one session before having to log in again. Unlike <b>Lease Time</b> , the user has no opportunity to renew the session without logging out.
User Logon Settings	

Table 47 Configuration &gt; Object &gt; User &gt; Setting (continued)

LABEL	DESCRIPTION
Limit the number of simultaneous logons for administration account	Select this check box if you want to set a limit on the number of simultaneous logins by admin users. If you do not select this, admin users can login as many times as they want at the same time using the same or different IP addresses.
Maximum number per administration account	This field is effective when <b>Limit ... for administration account</b> is checked. Type the maximum number of simultaneous logins by each admin user.
User Lockout Settings	
Enable logon retry limit	Select this check box to set a limit on the number of times each user can login unsuccessfully (for example, wrong password) before the IP address is locked out for a specified amount of time.
Maximum retry count	This field is effective when <b>Enable logon retry limit</b> is checked. Type the maximum number of times each user can login unsuccessfully before the IP address is locked out for the specified <b>lockout period</b> . The number must be between 1 and 99.
Lockout period	This field is effective when <b>Enable logon retry limit</b> is checked. Type the number of minutes the user must wait to try to login again, if <b>logon retry limit</b> is enabled and the <b>maximum retry count</b> is reached. This number must be between 1 and 65,535 (about 45.5 days).
Apply	Click <b>Apply</b> to save the changes.
Reset	Click <b>Reset</b> to return the screen to its last-saved settings.

### 9.3.1 Edit User Authentication Timeout Settings

This screen allows you to set the default authentication timeout settings for the selected type of user account. These default authentication timeout settings also control the settings for any existing user accounts that are set to use the default settings. You can still manually configure any user account's authentication timeout settings.

To access this screen, go to the **Configuration > Object > User > Setting** screen, select one of the **Default Authentication Timeout Settings** entry and click the **Edit** icon.

Figure 66 User &gt; Setting &gt; Edit User Authentication Timeout Settings

**Edit User Authentication Timeout Settings**

User Type: admin

Lease Time: 1440 (0-1440 minutes, 0 is unlimited)

Reauthentication Time: 1440 (0-1440 minutes, 0 is unlimited)

OK Cancel

The following table describes the labels in this screen.

Table 48 User > Setting > Edit User Authentication Timeout Settings

LABEL	DESCRIPTION
User Type	<p>This read-only field identifies the type of user account for which you are configuring the default settings.</p> <ul style="list-style-type: none"> <li>• <b>admin</b> - this user can look at and change the configuration of the NWA/WAC.</li> <li>• <b>limited-admin</b> - this user can look at the configuration of the NWA/WAC but not to change it.</li> </ul>
Lease Time	<p>Enter the number of minutes this type of user account has to renew the current session before the user is logged out. You can specify 1 to 1440 minutes. You can enter 0 to make the number of minutes unlimited.</p> <p>Admin users renew the session every time the main screen refreshes in the Web Configurator. Access users can renew the session by clicking the <b>Renew</b> button on their screen. If you allow access users to renew time automatically, the users can select this check box on their screen as well. In this case, the session is automatically renewed before the lease time expires.</p>
Reauthentication Time	<p>Type the number of minutes this type of user account can be logged into the NWA/WAC in one session before the user has to log in again. You can specify 1 to 1440 minutes. You can enter 0 to make the number of minutes unlimited. Unlike <b>Lease Time</b>, the user has no opportunity to renew the session without logging out.</p>
OK	<p>Click <b>OK</b> to save your changes back to the NWA/WAC.</p>
Cancel	<p>Click <b>Cancel</b> to exit this screen without saving your changes.</p>

# CHAPTER 10

## AP Profile

### 10.1 Overview

This chapter shows you how to configure preset profiles for the NWA/WAC.

#### 10.1.1 What You Can Do in this Chapter

- The **Radio** screen ([Section 10.2 on page 108](#)) creates radio configurations that can be used by the APs.
- The **SSID** screen ([Section 10.3 on page 114](#)) configures three different types of profiles for your networked APs.

#### 10.1.2 What You Need To Know

The following terms and concepts may help as you read this chapter.

##### Wireless Profiles

At the heart of all wireless AP configurations on the NWA/WAC are profiles. A profile represents a group of saved settings that you can use across any number of connected APs. You can set up the following wireless profile types:

- **Radio** - This profile type defines the properties of an AP's radio transmitter. You can have a maximum of 32 radio profiles on the NWA/WAC.
- **SSID** - This profile type defines the properties of a single wireless network signal broadcast by an AP. Each radio on a single AP can broadcast up to 8 SSIDs. You can have a maximum of 32 SSID profiles on the NWA/WAC.
- **Security** - This profile type defines the security settings used by a single SSID. It controls the encryption method required for a wireless client to associate itself with the SSID. You can have a maximum of 32 security profiles on the NWA/WAC.
- **MAC Filtering** - This profile provides an additional layer of security for an SSID, allowing you to block access or allow access to that SSID based on wireless client MAC addresses. If a client's MAC address is on the list, then it is either allowed or denied, depending on how you set up the MAC Filter profile. You can have a maximum of 32 MAC filtering profiles on the NWA/WAC.
- **Layer-2 Isolation** - This profile defines the MAC addresses of the devices that you want to allow the associated wireless clients to have access to when layer-2 isolation is enabled.

##### SSID

The SSID (Service Set Identifier) is the name that identifies the Service Set with which a wireless station is associated. Wireless stations associating to the access point (AP) must have the same SSID. In other words, it is the name of the wireless network that clients use to connect to it.

## WEP

WEP (Wired Equivalent Privacy) encryption scrambles all data packets transmitted between the AP and the wireless stations associated with it in order to keep network communications private. Both the wireless stations and the access points must use the same WEP key for data encryption and decryption.

## WPA2

WPA2 (IEEE 802.11i) is a wireless security standard that defines stronger encryption, authentication and key management than WPA. Key differences between WPA2 and WEP are improved data encryption and user authentication.

## IEEE 802.1x

The IEEE 802.1x standard outlines enhanced security methods for both the authentication of wireless stations and encryption key management. Authentication is done using an external RADIUS server.

# 10.2 Radio

This screen allows you to create radio profiles for the NWA/WAC. A radio profile is a list of settings that an NWA/WAC can use to configure its radio transmitter(s). To access this screen click **Configuration > Object > AP Profile**.

Note: You can have a maximum of 32 radio profiles on the NWA/WAC.

**Figure 67** Configuration > Object > AP Profile > Radio

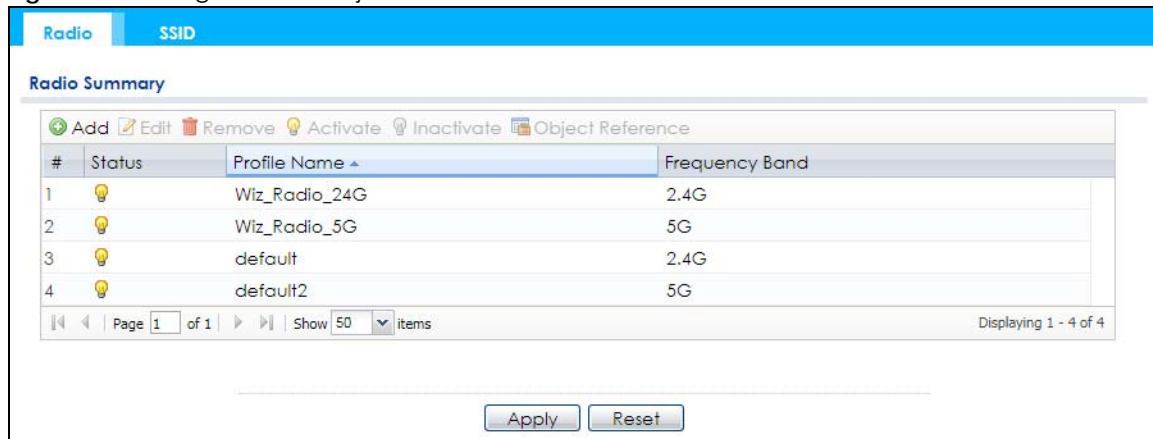

The following table describes the labels in this screen.

**Table 49** Configuration > Object > AP Profile > Radio

LABEL	DESCRIPTION
Add	Click this to add a new radio profile.
Edit	Click this to edit the selected radio profile.
Remove	Click this to remove the selected radio profile.
Activate	To turn on an entry, select it and click <b>Activate</b> .



Table 49 Configuration &gt; Object &gt; AP Profile &gt; Radio (continued)

LABEL	DESCRIPTION
Inactivate	To turn off an entry, select it and click <b>Inactivate</b> .
Object Reference	Click this to view which other objects are linked to the selected radio profile.
#	This field is a sequential value, and it is not associated with a specific user.
Status	This field shows whether or not the entry is activated. A yellow bulb signifies that this rule is active. A gray bulb signifies that this rule is not active.
Profile Name	This field indicates the name assigned to the radio profile.
Frequency Band	This field indicates the frequency band which this radio profile is configured to use.
Apply	Click <b>Apply</b> to save your changes back to the NWA/WAC.
Reset	Click <b>Reset</b> to return the screen to its last-saved settings.

## 10.2.1 Add/Edit Radio Profile

This screen allows you to create a new radio profile or edit an existing one. To access this screen, click the **Add** button or select a radio profile from the list and click the **Edit** button.

Figure 68 Configuration > Object > AP Profile > Add/Edit Profile

The following table describes the labels in this screen.

Table 50 Configuration > Object > AP Profile > Add/Edit Profile

LABEL	DESCRIPTION
Hide / Show Advanced Settings	Click this to hide or show the <b>Advanced Settings</b> in this window.
General Settings	
Activate	Select this option to make this profile active.

Table 50 Configuration &gt; Object &gt; AP Profile &gt; Add/Edit Profile (continued)

LABEL	DESCRIPTION
Profile Name	Enter up to 31 alphanumeric characters to be used as this profile's name. Spaces and underscores are allowed.
802.11 Band	<p>Select the wireless band which this radio profile should use. Not all NWA/WACs support both 2.4 GHz and 5 GHz frequency bands.</p> <p>2.4 GHz is the frequency used by IEEE 802.11b/g/n wireless clients.</p> <p>5 GHz is the frequency used by IEEE 802.11ac/a/n wireless clients.</p> <ul style="list-style-type: none"> <li>• <b>11b/g</b>: allows either IEEE 802.11b or IEEE 802.11g compliant WLAN devices to associate with the NWA/WAC. The NWA/WAC adjusts the transmission rate automatically according to the wireless standard supported by the wireless devices.</li> <li>• <b>11b/g/n</b>: allows IEEE802.11b, IEEE802.11g and IEEE802.11n compliant WLAN devices to associate with the NWA/WAC. The transmission rate of your NWA/WAC might be reduced.</li> <li>• <b>11a</b>: allows only IEEE 802.11a compliant WLAN devices to associate with the NWA/WAC.</li> <li>• <b>11a/n</b>: allows both IEEE802.11n and IEEE802.11a compliant WLAN devices to associate with the NWA/WAC. The transmission rate of your NWA/WAC might be reduced.</li> <li>• <b>11ac</b>: allows IEEE 802.11ac compliant WLAN devices to associate with the WAC.</li> </ul>
Channel Width	<p>Select the channel bandwidth you want to use for your wireless network.</p> <p>Select <b>20 MHz</b> if you want to lessen radio interference with other wireless devices in your neighborhood.</p> <p>Select <b>20/40 MHz</b> to allow the NWA/WAC to choose the channel bandwidth (20 or 40 MHz) that has least interference.</p> <p>Select <b>20/40/80 MHz</b> to allow the NWA/WAC to choose the channel bandwidth (20 or 40 or 80 MHz) that has least interference. This option is available only when you select <b>11ac</b> in the <b>802.11 Band</b> field.</p>
Channel Selection	<p>This is the radio channel which the signal will use for broadcasting by this radio profile.</p> <ul style="list-style-type: none"> <li>• <b>DCS</b>: Choose Dynamic Channel Selection to have the NWA/WAC choose a radio channel that has least interference.</li> <li>• <b>Manual</b>: Choose from the available radio channels in the list. If your NWA/WAC is outdoor type, be sure to choose non-indoors channels.</li> </ul>
Enable DCS Client Aware	<p>Select this to have the NWA/WAC switch channels only when there are no clients connected to it. If there is a client connected, the NWA/WAC will not switch channels but generate a log. The NWA/WAC tries to scan and switch channels again at the end of the specified time interval or at the scheduled time.</p> <p>If you disable this then the NWA/WAC switches channels immediately regardless of any client connections. In this instance, clients that are connected to the NWA/WAC when it switches channels are dropped.</p>
2.4 GHz Channel Selection Method	<p>Select how you want to specify the channels the NWA/WAC switches between for 2.4 GHz operation. This field appears only when you choose 802.11b/g/n mode.</p> <p>Select <b>auto</b> to have the NWA/WAC display a <b>2.4 GHz Channel Deployment</b> field you can use to limit channel switching to 3 or 4 channels.</p> <p>Select <b>manual</b> to select the individual channels the NWA/WAC switches between.</p> <p>Note: The method is automatically set to <b>auto</b> when no channel is selected or any one of the previously selected channels is not supported.</p>
Channel ID	<p>This field is available only when you set <b>Channel Selection</b> to <b>DCS</b> and set <b>2.4 GHz Channel Selection Method</b> to <b>manual</b>.</p> <p>Select the channels that you want the NWA/WAC to use.</p>

Table 50 Configuration &gt; Object &gt; AP Profile &gt; Add/Edit Profile (continued)

LABEL	DESCRIPTION
2.4 GHz Channel Deployment	<p>This is available when the <b>2.4 GHz Channel Selection Method</b> is set to <b>auto</b>.</p> <p>Select <b>Three-Channel Deployment</b> to limit channel switching to channels 1, 6, and 11, the three channels that are sufficiently attenuated to have almost no impact on one another. In other words, this allows you to minimize channel interference by limiting channel-hopping to these three "safe" channels.</p> <p>Select <b>Four-Channel Deployment</b> to limit channel switching to four channels. Depending on the country domain, if the only allowable channels are 1-11 then the NWA/WAC uses channels 1, 4, 7, 11 in this configuration; otherwise, the NWA/WAC uses channels 1, 5, 9, 13 in this configuration. Four channel deployment expands your pool of possible channels while keeping the channel interference to a minimum.</p>
Enable 5 GHz DFS Aware	<p>This field is available only when you select <b>11a</b>, <b>11a/n</b> or <b>11ac</b> in the <b>802.11 Band</b> field and set <b>5 GHz Channel Selection Method</b> to <b>auto</b>.</p> <p>Select this if your APs are operating in an area known to have RADAR devices. This allows the device to downgrade its frequency to below 5 GHz in the event RADAR signal is detected, thus preventing it from interfering with that signal.</p> <p>Enabling this forces the AP to select a non-DFS channel.</p>
5 GHz Channel Selection Method	<p>Select how you want to specify the channels the NWA/WAC switches between for 5 GHz operation.</p> <p>Select <b>Auto</b> to have the NWA/WAC automatically select the best channel.</p> <p>Select <b>manual</b> to select the individual channels the NWA/WAC switches between.</p> <p>Note: The method is automatically set to <b>auto</b> when no channel is selected or any one of the previously selected channels is not supported.</p>
Channel ID	<p>This field is available only when you set <b>Channel Selection</b> to <b>DCS</b> and set <b>5 GHz Channel Selection Method</b> to <b>manual</b>.</p> <p>Select the channels that you want the NWA/WAC to use.</p>
Time Interval	<p>Select this option to have the NWA/WAC survey the other APs within its broadcast radius at the end of the specified time interval.</p>
DCS Time Interval	<p>This field is available when you set <b>Channel Selection</b> to <b>DCS</b> and select the <b>Time Interval</b> option.</p> <p>Enter a number of minutes. This regulates how often the NWA/WAC surveys the other APs within its broadcast radius. If the channel on which it is currently broadcasting suddenly comes into use by another AP, the NWA/WAC will then dynamically select the next available clean channel or a channel with lower interference.</p>
Schedule	<p>Select this option to have the NWA/WAC survey the other APs within its broadcast radius at a specific time on selected days of the week.</p>
Start Time	<p>Specify the time of the day (in 24-hour format) to have the NWA/WAC use DCS to automatically scan and find a less-used channel.</p>
Week Days	<p>Select each day of the week to have the NWA/WAC use DCS to automatically scan and find a less-used channel.</p>
Advanced Settings	
Guard Interval	<p>Set the guard interval for this radio profile to either <b>short</b> or <b>long</b>. This option isn't applicable if you set <b>802.11 Band</b> to <b>11a</b> or <b>11b/g</b> and/or choose 20 MHz channel width.</p> <p>The guard interval is the gap introduced between data transmission from users in order to reduce interference. Reducing the interval increases data transfer rates but also increases interference. Increasing the interval reduces data transfer rates but also reduces interference.</p>

Table 50 Configuration &gt; Object &gt; AP Profile &gt; Add/Edit Profile (continued)

LABEL	DESCRIPTION
Enable A-MPDU Aggregation	<p>Select this to enable A-MPDU aggregation. This field is not available if you set <b>802.11 Band</b> to <b>11a</b> or <b>11b/g</b>.</p> <p>Message Protocol Data Unit (MPDU) aggregation collects Ethernet frames along with their 802.11n headers and wraps them in a 802.11n MAC header. This method is useful for increasing bandwidth throughput in environments that are prone to high error rates.</p>
Enable A-MSDU Aggregation	<p>Select this to enable A-MSDU aggregation. This field is not available if you set <b>802.11 Band</b> to <b>11a</b> or <b>11b/g</b>.</p> <p>Mac Service Data Unit (MSDU) aggregation collects Ethernet frames without any of their 802.11n headers and wraps the header-less payload in a single 802.11n MAC header. This method is useful for increasing bandwidth throughput. It is also more efficient than A-MPDU except in environments that are prone to high error rates.</p>
RTS/CTS Threshold	<p>Use RTS/CTS to reduce data collisions on the wireless network if you have wireless clients that are associated with the same AP but out of range of one another. When enabled, a wireless client sends an RTS (Request To Send) and then waits for a CTS (Clear To Send) before it transmits. This stops wireless clients from transmitting packets at the same time (and causing data collisions).</p> <p>A wireless client sends an RTS for all packets larger than the number (of bytes) that you enter here. Set the RTS/CTS equal to or higher than the fragmentation threshold to turn RTS/CTS off.</p>
Beacon Interval	<p>When a wirelessly networked device sends a beacon, it includes with it a beacon interval. This specifies the time period before the device sends the beacon again. The interval tells receiving devices on the network how long they can wait in low-power mode before waking up to handle the beacon. A high value helps save current consumption of the access point.</p>
DTIM	<p>Delivery Traffic Indication Message (DTIM) is the time period after which broadcast and multicast packets are transmitted to mobile clients in the Active Power Management mode. A high DTIM value can cause clients to lose connectivity with the network. This value can be set from 1 to 255.</p>
Enable Signal Threshold	<p>Select the check box to use the signal threshold to ensure wireless clients receive good throughput. This allows only wireless clients with a strong signal to connect to the AP.</p> <p>Clear the check box to not require wireless clients to have a minimum signal strength to connect to the AP.</p>
Station Signal Threshold	<p>Set a minimum client signal strength. A wireless client is allowed to connect to the AP only when its signal strength is stronger than the specified threshold.</p> <p>-20 dBm is the strongest signal you can require and -76 is the weakest.</p>
Disassociate Station Threshold	<p>Set a minimum kick-off signal strength. When a wireless client's signal strength is lower than the specified threshold, the NWA/WAC disconnects the wireless client from the AP.</p> <p>-20 dBm is the strongest signal you can require and -90 is the weakest.</p>
Allow Station Connection after Multiple Retries	<p>Select this option to allow a wireless client to try to associate with the AP again after it is disconnected due to weak signal strength.</p>
Station Retry Count	<p>Set the maximum number of times a wireless client can attempt to re-connect to the AP</p>
Allow 802.11n/ac stations only	<p>Select this option to allow only 802.11 n/ac clients to connect, and reject 802.11 a/b/g clients.</p>
Multicast Settings	

Table 50 Configuration &gt; Object &gt; AP Profile &gt; Add/Edit Profile (continued)

LABEL	DESCRIPTION
Transmission Mode	Specify how the NWA/WAC handles wireless multicast traffic.  Select <b>Multicast to Unicast</b> to broadcast wireless multicast traffic to all of the wireless clients as unicast traffic. Unicast traffic dynamically changes the data rate based on the application's bandwidth requirements. The retransmit mechanism of unicast traffic provides more reliable transmission of the multicast traffic, although it also produces duplicate packets.  Select <b>Fixed Multicast Rate</b> to send multicast traffic to all wireless clients at a single data rate. You must know the multicast application's bandwidth requirements and set it in the following field.
Multicast Rate(Mbps)	If you set <b>Transmission Mode</b> to <b>Fixed Multicast Rate</b> , select a data rate at which the NWA/WAC transmits multicast packets to wireless clients. For example, to deploy 4 Mbps video, select a fixed multicast rate higher than 4 Mbps.
OK	Click <b>OK</b> to save your changes back to the NWA/WAC.
Cancel	Click <b>Cancel</b> to exit this screen without saving your changes.

## 10.3 SSID

The SSID screens allow you to configure three different types of profiles for your networked APs: an SSID list, which can assign specific SSID configurations to your APs; a security list, which can assign specific encryption methods to the APs when allowing wireless clients to connect to them; and a MAC filter list, which can limit connections to an AP based on wireless clients MAC addresses.

### 10.3.1 SSID List

This screen allows you to create and manage SSID configurations that can be used by the APs. An SSID, or Service Set IDentifier, is basically the name of the wireless network to which a wireless client can connect. The SSID appears as readable text to any device capable of scanning for wireless frequencies (such as the WiFi adapter in a laptop), and is displayed as the wireless network name when a person makes a connection to it.

To access this screen click **Configuration > Object > AP Profile > SSID > SSID List**.

Note: You cannot add or remove an SSID profile after running the setup wizard.

Figure 69 Configuration &gt; Object &gt; AP Profile &gt; SSID &gt; SSID List (Default)

#	Profile Name	SSID	Security Profile	QoS	MAC Filterin...	Layer-2 Isolat...	VLAN ID
1	default	Zyxel	default	WMM	disable	disable	1

Figure 70 Configuration > Object > AP Profile > SSID > SSID List (After wizard setup)

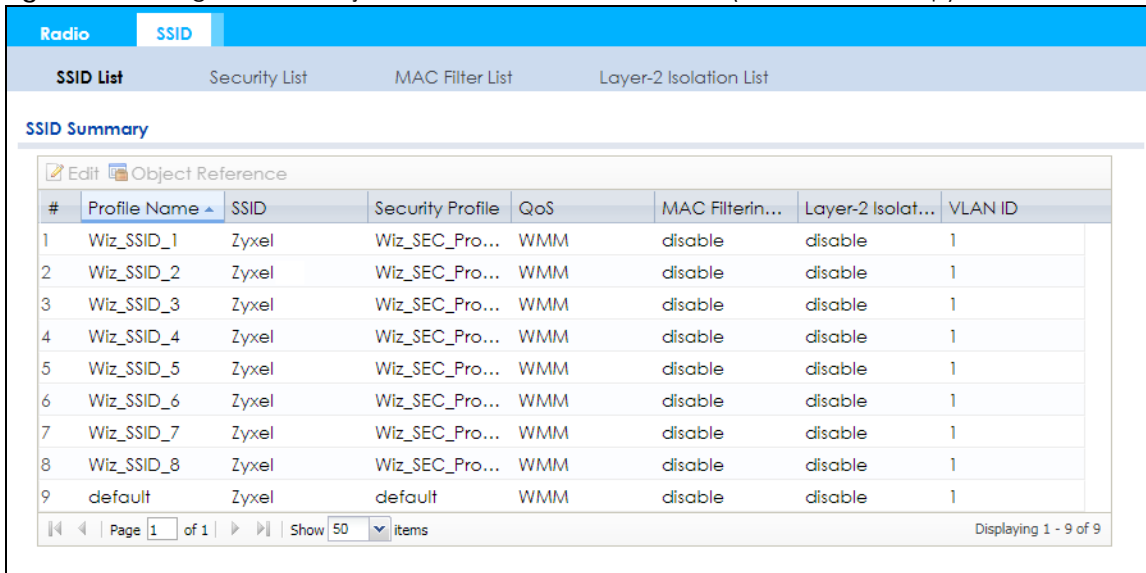

The following table describes the labels in this screen.

Table 51 Configuration > Object > AP Profile > SSID List

LABEL	DESCRIPTION
Add	Click this to add a new SSID profile. This button is not available after you configure the NWA/WAC using the wizard.
Edit	Click this to edit the selected SSID profile.
Remove	Click this to remove the selected SSID profile. This button is not available after you configure the NWA/WAC using the wizard.
Object Reference	Click this to view which other objects are linked to the selected SSID profile (for example, radio profile).
#	This field is a sequential value, and it is not associated with a specific user.
Profile Name	This field indicates the name assigned to the SSID profile.
SSID	This field indicates the SSID name as it appears to wireless clients.
Security Profile	This field indicates which (if any) security profile is associated with the SSID profile.
QoS	This field indicates the QoS type associated with the SSID profile.
MAC Filtering Profile	This field indicates which (if any) MAC filter Profile is associated with the SSID profile.
Layer-2 Isolation Profile	This field indicates which (if any) layer-2 isolation Profile is associated with the SSID profile.
VLAN ID	This field indicates the VLAN ID associated with the SSID profile.

### 10.3.2 Add/Edit SSID Profile

This screen allows you to create a new SSID profile or edit an existing one. To access this screen, click the **Add** button or select a SSID profile from the list and click the **Edit** button.

**Figure 71** Configuration > Object > AP Profile > Add/Edit SSID Profile

The following table describes the labels in this screen.

**Table 52** Configuration > Object > AP Profile > Add/Edit SSID Profile

LABEL	DESCRIPTION
Create new Object	Select an object type from the list to create a new one associated with this SSID profile.
Profile Name	Enter up to 31 alphanumeric characters for the profile name. This name is only visible in the Web Configurator and is only for management purposes. Spaces and underscores are allowed.
SSID	Enter the SSID name for this profile. This is the name visible on the network to wireless clients. Enter up to 32 characters, spaces and underscores are allowed.
Security Profile	Select a security profile from this list to associate with this SSID. If none exist, you can use the <b>Create new Object</b> menu to create one.  Note: It is highly recommended that you create security profiles for all of your SSIDs to enhance your network security.
MAC Filtering Profile	Select a MAC filtering profile from the list to associate with this SSID. If none exist, you can use the <b>Create new Object</b> menu to create one.  MAC filtering allows you to limit the wireless clients connecting to your network through a particular SSID by wireless client MAC addresses. Any clients that have MAC addresses not in the MAC filtering profile of allowed addresses are denied connections.  The <b>disable</b> setting means no MAC filtering is used.



Table 52 Configuration &gt; Object &gt; AP Profile &gt; Add/Edit SSID Profile (continued)

LABEL	DESCRIPTION
Layer-2 Isolation Profile	<p>Select a layer-2 isolation profile from the list to associate with this SSID. If none exist, you can use the <b>Create new Object</b> menu to create one.</p> <p>Layer-2 isolation allows you to prevent wireless clients associated with your NWA/WAC from communicating with other wireless clients, APs, computers or routers in a network.</p> <p>The <b>disable</b> setting means no layer-2 isolation is used.</p>
QoS	<p>Select a Quality of Service (QoS) access category to associate with this SSID. Access categories minimize the delay of data packets across a wireless network. Certain categories, such as video or voice, are given a higher priority due to the time sensitive nature of their data packets.</p> <p>QoS access categories are as follows:</p> <p><b>disable</b>: Turns off QoS for this SSID. All data packets are treated equally and not tagged with access categories.</p> <p><b>WMM</b>: Enables automatic tagging of data packets. The NWA/WAC assigns access categories to the SSID by examining data as it passes through it and making a best guess effort. If something looks like video traffic, for instance, it is tagged as such.</p> <p><b>WMM_VOICE</b>: All wireless traffic to the SSID is tagged as voice data. This is recommended if an SSID is used for activities like placing and receiving VoIP phone calls.</p> <p><b>WMM_VIDEO</b>: All wireless traffic to the SSID is tagged as video data. This is recommended for activities like video conferencing.</p> <p><b>WMM_BEST_EFFORT</b>: All wireless traffic to the SSID is tagged as "best effort," meaning the data travels the best route it can without displacing higher priority traffic. This is good for activities that do not require the best bandwidth throughput, such as surfing the Internet.</p> <p><b>WMM_BACKGROUND</b>: All wireless traffic to the SSID is tagged as low priority or "background traffic", meaning all other access categories take precedence over this one. If traffic from an SSID does not have strict throughput requirements, then this access category is recommended. For example, an SSID that only has network printers connected to it.</p>
Rate Limiting	
Downlink	Define the maximum incoming transmission data rate (either in mbps or kbps) on a perstation basis.
Uplink	Define the maximum outgoing transmission data rate (either in mbps or kbps) on a perstation basis.
VLAN ID	Enter a VLAN ID for the NWA/WAC to use to tag traffic originating from this SSID.
Hidden SSID	<p>Select this if you want to "hide" your SSID from wireless clients. This tells any wireless clients in the vicinity of the AP using this SSID profile not to display its SSID name as a potential connection. Not all wireless clients respect this flag and display it anyway.</p> <p>When a SSID is "hidden" and a wireless client cannot see it, the only way you can connect to the SSID is by manually entering the SSID name in your wireless connection setup screen(s) (these vary by client, client connectivity software, and operating system).</p>
Enable Intra-BSS Traffic Blocking	Select this option to prevent crossover traffic from within the same SSID on the NWA/WAC.
Enable U-APSD	Select this option to enable Unscheduled Automatic Power Save Delivery (U-APSD), which is also known as WMM-Power Save. This helps increase battery life for battery-powered wireless clients connected to the NWA/WAC using this SSID profile.
Schedule SSID	Select this option and set whether the SSID is enabled or disabled on each day of the week. You also need to select the hour and minute (in 24-hour format) to specify the time period of each day during which the SSID is enabled/enabled.
OK	Click <b>OK</b> to save your changes back to the NWA/WAC.
Cancel	Click <b>Cancel</b> to exit this screen without saving your changes.

## 10.4 Security List

This screen allows you to manage wireless security configurations that can be used by your SSIDs. Wireless security is implemented strictly between the AP broadcasting the SSID and the stations that are connected to it.

To access this screen click **Configuration > Object > AP Profile > SSID > Security List**.

Note: You can have a maximum of 32 security profiles on the NWA/WAC.

**Figure 72** Configuration > Object > AP Profile > SSID > Security List

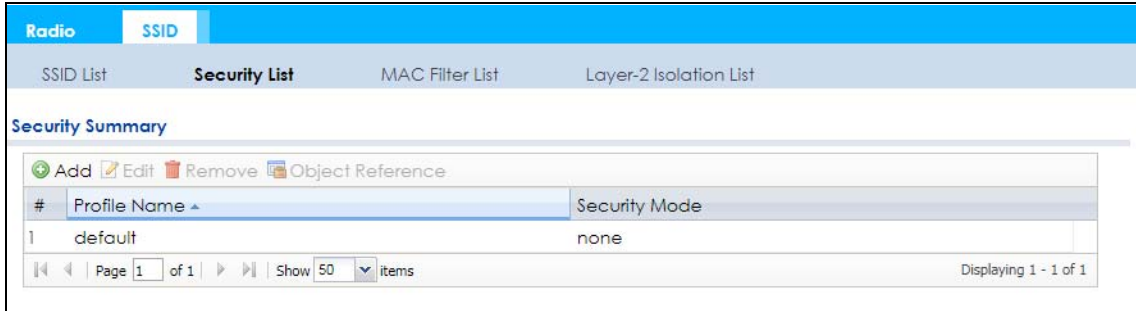

The following table describes the labels in this screen.

**Table 53** Configuration > Object > AP Profile > SSID > Security List

LABEL	DESCRIPTION
Add	Click this to add a new security profile.
Edit	Click this to edit the selected security profile.
Remove	Click this to remove the selected security profile.
Object Reference	Click this to view which other objects are linked to the selected security profile (for example, SSID profile).
#	This field is a sequential value, and it is not associated with a specific user.
Profile Name	This field indicates the name assigned to the security profile.
Security Mode	This field indicates this profile's security mode (if any).

### 10.4.1 Add/Edit Security Profile

This screen allows you to create a new security profile or edit an existing one. To access this screen, click the **Add** button or select a security profile from the list and click the **Edit** button.

Note: This screen's options change based on the **Security Mode** selected. Only the default screen is displayed here.

Figure 73 Configuration > Object > AP Profile > SSID > Security List > Add/Edit Security Profile

The following table describes the labels in this screen.

Table 54 Configuration > Object > AP Profile > SSID > Security List > Add/Edit Security Profile

LABEL	DESCRIPTION
Profile Name	Enter up to 31 alphanumeric characters for the profile name. This name is only visible in the Web Configurator and is only for management purposes. Spaces and underscores are allowed.
Security Mode	Select a security mode from the list: <b>none</b> , <b>wep</b> , <b>wpa2</b> , or <b>wpa2-mix</b> .
Radius Server Type	This shows <b>External</b> and the NWA/WAC uses an external RADIUS server for authentication.

Table 54 Configuration &gt; Object &gt; AP Profile &gt; SSID &gt; Security List &gt; Add/Edit Security Profile (continued)

LABEL	DESCRIPTION
Primary / Secondary Radius Server Activate	Select this to have the NWA/WAC use the specified RADIUS server.
Radius Server IP Address	Enter the IP address of the RADIUS server to be used for authentication.
Radius Server Port	Enter the port number of the RADIUS server to be used for authentication.
Radius Server Secret	Enter the shared secret password of the RADIUS server to be used for authentication.
Primary / Secondary Accounting Server Activate	Select the check box to enable user accounting through an external authentication server.
Accounting Server IP Address	Enter the IP address of the external accounting server in dotted decimal notation.
Accounting Server Port	Enter the port number of the external accounting server. The default port number is 1813. You need not change this value unless your network administrator instructs you to do so with additional information.
Accounting Share Secret	Enter a password (up to 128 alphanumeric characters) as the key to be shared between the external accounting server and the NWA/WAC. The key must be the same on the external accounting server and your NWA/WAC. The key is not sent over the network.
Accounting Interim Update	This field is available only when you enable user accounting through an external authentication server.  Select this to have the NWA/WAC send subscriber status updates to the accounting server at the interval you specify.
Interim Update Interval	Specify the time interval for how often the NWA/WAC is to send a subscriber status update to the accounting server.
802.1X	Select this to enable 802.1x secure authentication.
ReAuthentication Timer	Enter the interval (in seconds) between authentication requests. Enter a 0 for unlimited requests.
WEP Authentication Settings	
Idle Timeout	Enter the idle interval (in seconds) that a client can be idle before authentication is discontinued.
Authentication Type	Select a WEP authentication method. Choices are <b>Open</b> or <b>Share</b> key. <b>Share</b> key is only available if you are not using 802.1x.
Key Length	Select the bit-length of the encryption key to be used in WEP connections.  If you select <b>WEP-64</b> : <ul style="list-style-type: none"> <li>Enter 10 hexadecimal digits in the range of "A-F", "a-f" and "0-9" (for example, 0x11AA22BB33) for each <b>Key</b> used.</li> </ul> or <ul style="list-style-type: none"> <li>Enter 5 ASCII characters (case sensitive) ranging from "a-z", "A-Z" and "0-9" (for example, MyKey) for each <b>Key</b> used.</li> </ul> If you select <b>WEP-128</b> : <ul style="list-style-type: none"> <li>Enter 26 hexadecimal digits in the range of "A-F", "a-f" and "0-9" (for example, 0x00112233445566778899AABBCC) for each <b>Key</b> used.</li> </ul> or <ul style="list-style-type: none"> <li>Enter 13 ASCII characters (case sensitive) ranging from "a-z", "A-Z" and "0-9" (for example, MyKey12345678) for each <b>Key</b> used.</li> </ul>
Key 1~4	Based on your <b>Key Length</b> selection, enter the appropriate length hexadecimal or ASCII key.
WPA2/WPA2-Mix Authentication Settings	

Table 54 Configuration &gt; Object &gt; AP Profile &gt; SSID &gt; Security List &gt; Add/Edit Security Profile (continued)

LABEL	DESCRIPTION
PSK	This field is available when you select the <b>wpa2</b> , or <b>wpa2-mix</b> security mode. Select this option to use a Pre-Shared Key with WPA2 encryption.
Pre-Shared Key	Enter a pre-shared key of between 8 and 63 case-sensitive ASCII characters (including spaces and symbols) or 64 hexadecimal characters.
Cipher Type	Select an encryption cipher type from the list. <ul style="list-style-type: none"> <li><b>auto</b> - This automatically chooses the best available cipher based on the cipher in use by the wireless client that is attempting to make a connection.</li> <li><b>aes</b> - This is the Advanced Encryption Standard encryption method. It is a more recent development over TKIP and considerably more robust. Not all wireless clients may support this.</li> </ul>
Idle Timeout	Enter the interval (in seconds) that a client can be idle before authentication is discontinued.
Group Key Update Timer	Enter the interval (in seconds) at which the AP updates the group WPA2 encryption key.
Management Frame Protection	This field is available only when you select <b>wpa2</b> in the <b>Security Mode</b> field and set <b>Cipher Type</b> to <b>aes</b> .  Data frames in 802.11 WLANs can be encrypted and authenticated with WEP, WPA or WPA2. But 802.11 management frames, such as beacon/probe response, association request, association response, de-authentication and disassociation are always unauthenticated and unencrypted. IEEE 802.11w Protected Management Frames allows APs to use the existing security mechanisms (encryption and authentication methods defined in IEEE 802.11i WPA/WPA2) to protect management frames. This helps prevent wireless DoS attacks.  Select the check box to enable management frame protection (MFP) to add security to 802.11 management frames.  Select <b>Optional</b> if you do not require the wireless clients to support MFP. Management frames will be encrypted if the clients support MFP.  Select <b>Required</b> and wireless clients must support MFP in order to join the NWA/WAC's wireless network.
OK	Click <b>OK</b> to save your changes back to the NWA/WAC.
Cancel	Click <b>Cancel</b> to exit this screen without saving your changes.

## 10.5 MAC Filter List

This screen allows you to create and manage security configurations that can be used by your SSIDs. To access this screen click **Configuration > Object > AP Profile > SSID > MAC Filter List**.

Note: You can have a maximum of 32 MAC filtering profiles on the NWA/WAC.

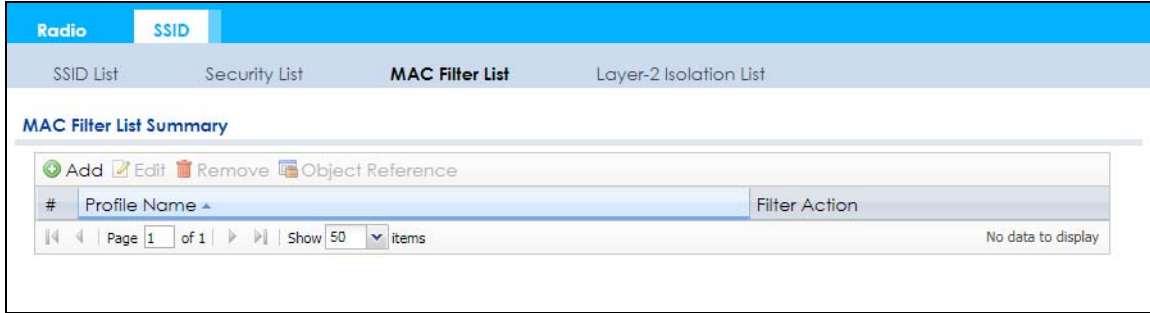
**Figure 74** Configuration > Object > AP Profile > SSID > MAC Filter List

The following table describes the labels in this screen.

**Table 55** Configuration > Object > AP Profile > SSID > MAC Filter List

LABEL	DESCRIPTION
Add	Click this to add a new MAC filtering profile.
Edit	Click this to edit the selected MAC filtering profile.
Remove	Click this to remove the selected MAC filtering profile.
Object Reference	Click this to view which other objects are linked to the selected MAC filtering profile (for example, SSID profile).
#	This field is a sequential value, and it is not associated with a specific user.
Profile Name	This field indicates the name assigned to the MAC filtering profile.
Filter Action	This field indicates this profile's filter action (if any).

## 10.5.1 Add/Edit MAC Filter Profile

This screen allows you to create a new MAC filtering profile or edit an existing one. To access this screen, click the **Add** button or select a MAC filter profile from the list and click the **Edit** button.

Note: Each MAC filtering profile can include a maximum of 512 MAC addresses.

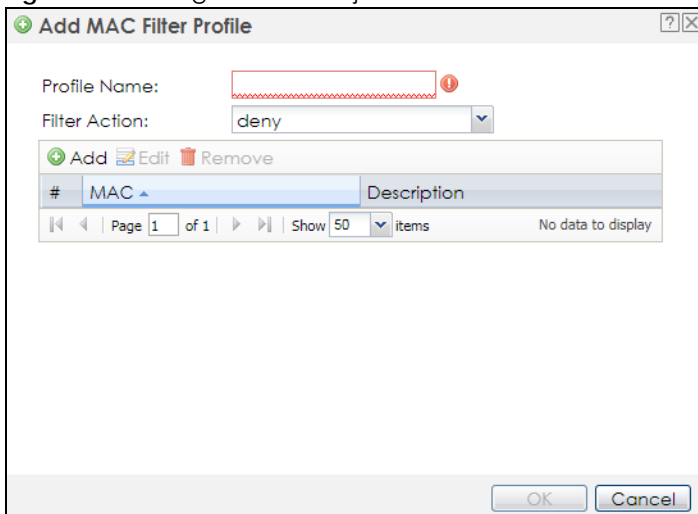
**Figure 75** Configuration > Object > AP Profile > SSID > MAC Filter List > Add/Edit MAC Filter Profile

The following table describes the labels in this screen.

Table 56 Configuration > Object > AP Profile > SSID > MAC Filter List > Add/Edit MAC Filter Profile

LABEL	DESCRIPTION
Profile Name	Enter up to 31 alphanumeric characters for the profile name. This name is only visible in the Web Configurator and is only for management purposes. Spaces and underscores are allowed.
Filter Action	Select <b>allow</b> to permit the wireless client with the MAC addresses in this profile to connect to the network through the associated SSID; select <b>deny</b> to block the wireless clients with the specified MAC addresses.
Add	Click this to add a MAC address to the profile's list.
Edit	Click this to edit the selected MAC address in the profile's list.
Remove	Click this to remove the selected MAC address from the profile's list.
#	This field is a sequential value, and it is not associated with a specific user.
MAC	This field specifies a MAC address associated with this profile. You can click the MAC address to make it editable.
Description	This field displays a description for the MAC address associated with this profile. You can click the description to make it editable. Enter up to 60 characters, spaces and underscores allowed.
OK	Click <b>OK</b> to save your changes back to the NWA/WAC.
Cancel	Click <b>Cancel</b> to exit this screen without saving your changes.

## 10.6 Layer-2 Isolation List

Layer-2 isolation is used to prevent wireless clients associated with your NWA/WAC from communicating with other wireless clients, APs, computers or routers in a network.

In the following example, layer-2 isolation is enabled on the NWA/WAC to allow a guest wireless client (A) to access the main network router (B). The router provides access to the Internet and the network printer (C) while preventing the client from accessing other computers and servers on the network. The client can communicate with other wireless clients only if Intra-BSS Traffic blocking is disabled.

Note: Intra-BSS Traffic Blocking is activated when you enable layer-2 isolation.

Figure 76 Layer-2 Isolation Application

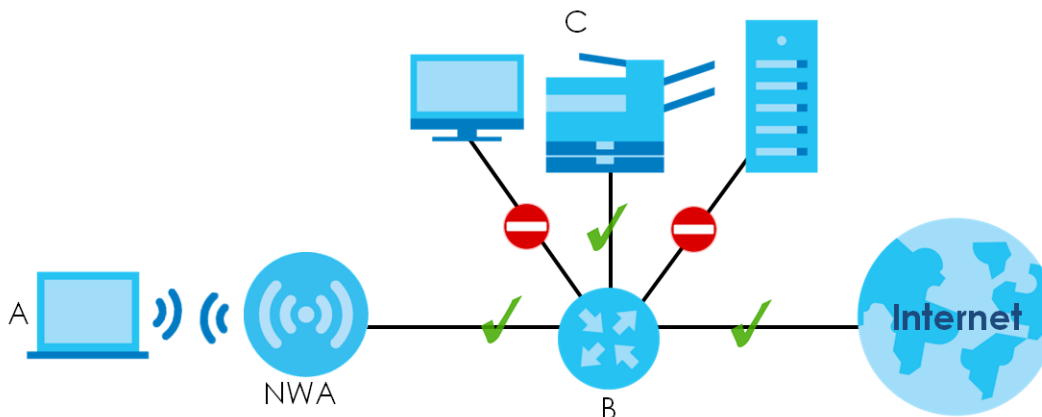

MAC addresses that are not listed in the layer-2 isolation table are blocked from communicating with the NWA/WAC's wireless clients except for broadcast packets. Layer-2 isolation does not check the traffic between wireless clients that are associated with the same AP. Intra-BSS traffic allows wireless clients associated with the same AP to communicate with each other.

This screen allows you to specify devices you want the users on your wireless networks to access. To access this screen click **Configuration > Object > AP Profile > SSID > Layer-2 Isolation List**.

**Figure 77** Configuration > Object > AP Profile > SSID > Layer-2 Isolation List

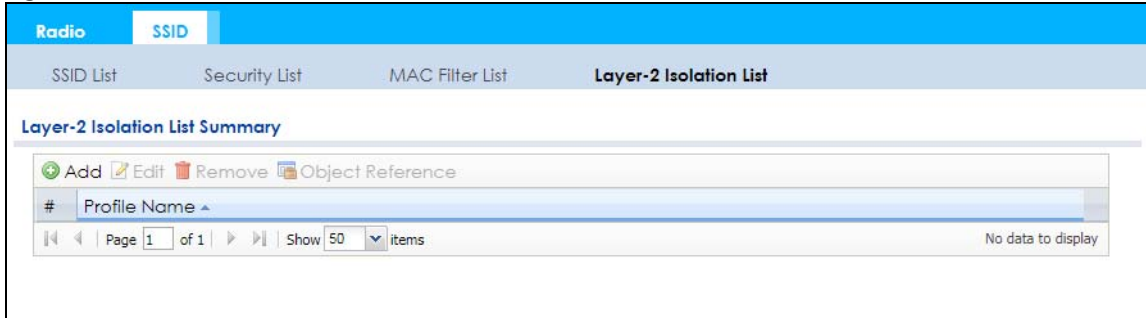

The following table describes the labels in this screen.

**Table 57** Configuration > Object > AP Profile > SSID > Layer-2 Isolation List

LABEL	DESCRIPTION
Add	Click this to add a new MAC filtering profile.
Edit	Click this to edit the selected MAC filtering profile.
Remove	Click this to remove the selected MAC filtering profile.
Object Reference	Click this to view which other objects are linked to the selected MAC filtering profile (for example, SSID profile).
#	This field is a sequential value, and it is not associated with a specific user.
Profile Name	This field indicates the name assigned to the layer-2 isolation profile.

### 10.6.1 Add/Edit Layer-2 Isolation Profile

This screen allows you to create a new layer-2 isolation profile or edit an existing one. To access this screen, click the **Add** button or select a layer-2 isolation profile from the list and click the **Edit** button.

**Note:** You need to know the MAC address of each wireless client, AP, computer or router that you want to allow to communicate with the NWA/WAC's wireless clients.



**Figure 78** Configuration > Object > AP Profile > SSID > Layer-2 Isolation List > Add/Edit Layer-2 Isolation Profile

The following table describes the labels in this screen.

**Table 58** Configuration > Object > AP Profile > SSID > Layer-2 Isolation List > Add/Edit Layer-2 Isolation Profile

LABEL	DESCRIPTION
Profile Name	Enter up to 31 alphanumeric characters for the profile name. This name is only visible in the Web Configurator and is only for management purposes. Spaces and underscores are allowed.
Add	Click this to add a MAC address to the profile's list.
Edit	Click this to edit the selected MAC address in the profile's list.
Remove	Click this to remove the selected MAC address from the profile's list.
#	This field is a sequential value, and it is not associated with a specific user.
MAC	This field specifies a MAC address associated with this profile. You can click the MAC address to make it editable.
Description	This field displays a description for the MAC address associated with this profile. You can click the description to make it editable. Enter up to 60 characters, spaces and underscores allowed.
OK	Click <b>OK</b> to save your changes back to the NWA/WAC.
Cancel	Click <b>Cancel</b> to exit this screen without saving your changes.

# CHAPTER 11

## MON Profile

### 11.1 Overview

This screen allows you to set up monitor mode configurations that allow your NWA/WAC to scan for other wireless devices in the vicinity. Once detected, you can use the **Wireless > MON Mode** screen (Section 7.3 on page 88) to classify them as either rogue or friendly.

Not all NWA/WACs support monitor mode and rogue APs detection.

#### 11.1.1 What You Can Do in this Chapter

The **MON Profile** screen (Section 11.2 on page 126) creates preset monitor mode configurations that can be used by the NWA/WAC.

### 11.2 MON Profile

This screen allows you to create monitor mode configurations that can be used by the APs. To access this screen, log into the Web Configurator, and click **Configuration > Object > MON Profile**.

Figure 79 Configuration > Object > MON Profile

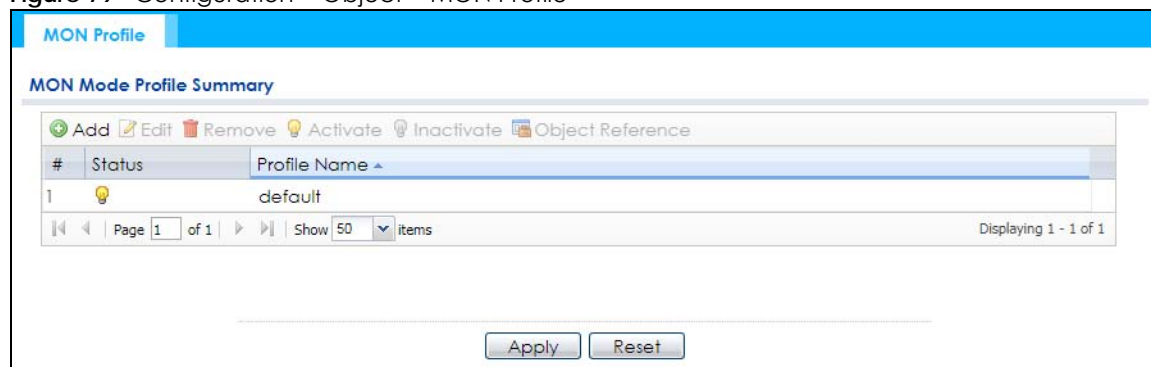

The following table describes the labels in this screen.

Table 59 Configuration > Object > MON Profile

LABEL	DESCRIPTION
Add	Click this to add a new monitor mode profile.
Edit	Click this to edit the selected monitor mode profile.
Remove	Click this to remove the selected monitor mode profile.
Activate	To turn on an entry, select it and click <b>Activate</b> .
Inactivate	To turn off an entry, select it and click <b>Inactivate</b> .

Table 59 Configuration &gt; Object &gt; MON Profile (continued)

LABEL	DESCRIPTION
Object Reference	Click this to view which other objects are linked to the selected monitor mode profile (for example, an AP management profile).
#	This field is a sequential value, and it is not associated with a specific profile.
Status	This field shows whether or not the entry is activated.
Profile Name	This field indicates the name assigned to the monitor profile.

## 11.2.1 Add/Edit MON Profile

This screen allows you to create a new monitor mode profile or edit an existing one. To access this screen, click the **Add** button or select an existing monitor mode profile and click the **Edit** button.

Figure 80 Configuration &gt; Object &gt; MON Profile &gt; Add/Edit MON Profile

**Add MON Profile**

**General Settings**

Activate

Profile Name:  !

Channel dwell time:  (100ms~1000ms)

Scan Channel Mode:

**Set Scan Channel List (2.4 GHz)**

Channel ID
1
2
3
4
5
6
7

**Set Scan Channel List (5 GHz)**

Channel ID
36
40
44
48
149
153
157

OK Cancel

The following table describes the labels in this screen.

Table 60 Configuration > Object > MON Profile > Add/Edit MON Profile

LABEL	DESCRIPTION
Activate	Select this to activate this monitor mode profile.
Profile Name	This field indicates the name assigned to the monitor mode profile.
Channel dwell time	Enter the interval (in milliseconds) before the NWA/WAC switches to another channel for monitoring.
Scan Channel Mode	Select <b>auto</b> to have the NWA/WAC switch to the next sequential channel once the <b>Channel dwell time</b> expires.  Select <b>manual</b> to set specific channels through which to cycle sequentially when the <b>Channel dwell time</b> expires. Selecting this options makes the <b>Scan Channel List</b> options available.
Set Scan Channel List (2.4 GHz)	Select one or more than one channel to have the NWA/WAC using this profile scan the channel(s) when <b>Scan Channel Mode</b> is set to <b>manual</b> .  These channels are limited to the 2.4 GHz range (802.11 b/g/n).
Set Scan Channel List (5 GHz)	Select one or more than one channel to have the NWA/WAC using this profile scan the channel(s) when <b>Scan Channel Mode</b> is set to <b>manual</b> .  These channels are limited to the 5 GHz range (802.11 a/n). Not all NWA/WACs support both 2.4 GHz and 5 GHz frequency bands.
OK	Click <b>OK</b> to save your changes back to the NWA/WAC.
Cancel	Click <b>Cancel</b> to exit this screen without saving your changes.

## 11.3 Technical Reference

The following section contains additional technical information about the features described in this chapter.

### Rogue APs

Rogue APs are wireless access points operating in a network's coverage area that are not under the control of the network's administrators, and can open up holes in a network's security. Attackers can take advantage of a rogue AP's weaker (or non-existent) security to gain access to the network, or set up their own rogue APs in order to capture information from wireless clients. If a scan reveals a rogue AP, you can use commercially-available software to physically locate it.

Figure 81 Rogue AP Example

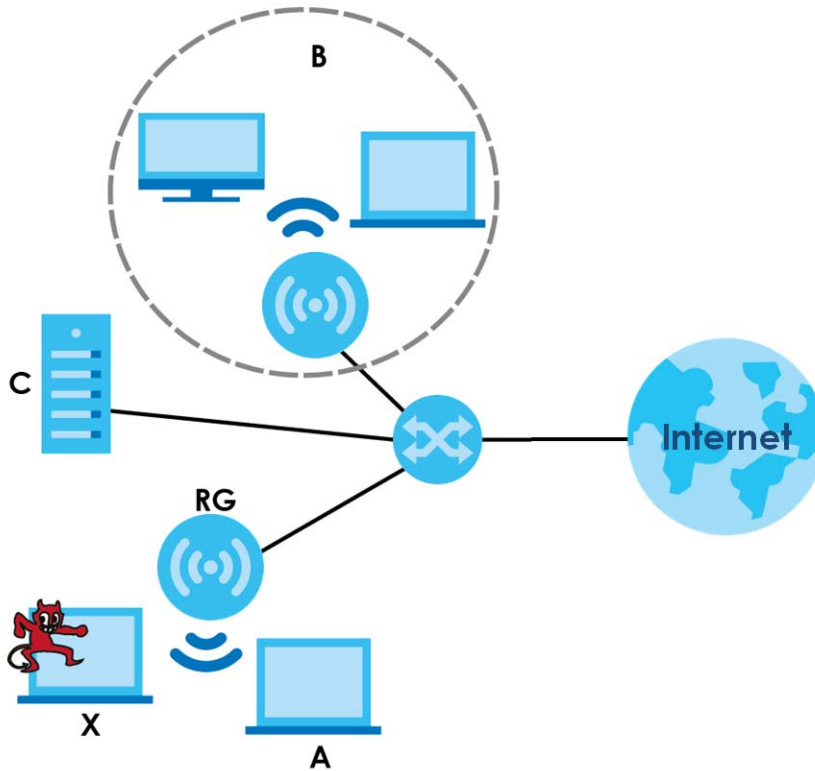

In the example above, a corporate network's security is compromised by a rogue AP (**RG**) set up by an employee at his workstation in order to allow him to connect his notebook computer wirelessly (**A**). The company's legitimate wireless network (the dashed ellipse **B**) is well-secured, but the rogue AP uses inferior security that is easily broken by an attacker (**X**) running readily available encryption-cracking software. In this example, the attacker now has access to the company network, including sensitive data stored on the file server (**C**).

## Friendly APs

If you have more than one AP in your wireless network, you should also configure a list of "friendly" APs. Friendly APs are other wireless access points that are detected in your network, as well as any others that you know are not a threat (those from recognized networks, for example). It is recommended that you export (save) your list of friendly APs often, especially if you have a network with a large number of access points.

# CHAPTER 12

## WDS Profile

### 12.1 Overview

This chapter shows you how to configure WDS (Wireless Distribution System) profiles for the NWA/WAC to form a WDS with other APs.

#### 12.1.1 What You Can Do in this Chapter

The **WDS Profile** screen (Section 12.2 on page 130) creates preset WDS configurations that can be used by the NWA/WAC.

### 12.2 WDS Profile

This screen allows you to manage and create WDS profiles that can be used by the APs. To access this screen, click **Configuration > Object > WDS Profile**.

Figure 82 Configuration > Object > WDS Profile

#	Profile Name	WDS SSID
1	default	ZyxeL_WDS

The following table describes the labels in this screen.

Table 61 Configuration > Object > WDS Profile

LABEL	DESCRIPTION
Add	Click this to add a new profile.
Edit	Click this to edit the selected profile.
Remove	Click this to remove the selected profile.
#	This field is a sequential value, and it is not associated with a specific profile.
Profile Name	This field indicates the name assigned to the profile.
WDS SSID	This field shows the SSID specified in this WDS profile.

## 12.2.1 Add/Edit WDS Profile

This screen allows you to create a new WDS profile or edit an existing one. To access this screen, click the **Add** button or select an existing profile and click the **Edit** button.

**Figure 83** Configuration > Object > WDS Profile > Add/Edit WDS Profile

The following table describes the labels in this screen.

**Table 62** Configuration > Object > WDS Profile > Add/Edit WDS Profile

LABEL	DESCRIPTION
Profile Name	Enter up to 31 alphanumeric characters for the profile name.
WDS SSID	Enter the SSID with which you want the NWA/WAC to connect to a root AP or repeater to form a WDS.
Pre-Shared Key	Enter a pre-shared key of between 8 and 63 case-sensitive ASCII characters (including spaces and symbols) or 64 hexadecimal characters. The key is used to encrypt the traffic between the APs.
OK	Click <b>OK</b> to save your changes back to the NWA/WAC.
Cancel	Click <b>Cancel</b> to exit this screen without saving your changes.

# CHAPTER 13

## Certificates

### 13.1 Overview

The NWA/WAC can use certificates (also called digital IDs) to authenticate users. Certificates are based on public-private key pairs. A certificate contains the certificate owner's identity and public key. Certificates provide a way to exchange public keys for use in authentication.

#### 13.1.1 What You Can Do in this Chapter

- The **My Certificates** screens ([Section 13.2 on page 135](#)) generate and export self-signed certificates or certification requests and import the NWA/WAC's CA-signed certificates.
- The **Trusted Certificates** screens ([Section 13.3 on page 142](#)) save CA certificates and trusted remote host certificates to the NWA/WAC. The NWA/WAC trusts any valid certificate that you have imported as a trusted certificate. It also trusts any valid certificate signed by any of the certificates that you have imported as a trusted certificate.

#### 13.1.2 What You Need to Know

The following terms and concepts may help as you read this chapter.

When using public-key cryptology for authentication, each host has two keys. One key is public and can be made openly available. The other key is private and must be kept secure.

These keys work like a handwritten signature (in fact, certificates are often referred to as "digital signatures"). Only you can write your signature exactly as it should look. When people know what your signature looks like, they can verify whether something was signed by you, or by someone else. In the same way, your private key "writes" your digital signature and your public key allows people to verify whether data was signed by you, or by someone else.

This process works as follows:

- 1 Tim wants to send a message to Jenny. He needs her to be sure that it comes from him, and that the message content has not been altered by anyone else along the way. Tim generates a public key pair (one public key and one private key).
- 2 Tim keeps the private key and makes the public key openly available. This means that anyone who receives a message seeming to come from Tim can read it and verify whether it is really from him or not.
- 3 Tim uses his private key to sign the message and sends it to Jenny.
- 4 Jenny receives the message and uses Tim's public key to verify it. Jenny knows that the message is from Tim, and that although other people may have been able to read the message, no-one can have altered it (because they cannot re-sign the message with Tim's private key).



- 5 Additionally, Jenny uses her own private key to sign a message and Tim uses Jenny's public key to verify the message.

The NWA/WAC uses certificates based on public-key cryptology to authenticate users attempting to establish a connection, not to encrypt the data that you send after establishing a connection. The method used to secure the data that you send through an established connection depends on the type of connection.

The certification authority uses its private key to sign certificates. Anyone can then use the certification authority's public key to verify the certificates.

A certification path is the hierarchy of certification authority certificates that validate a certificate. The NWA/WAC does not trust a certificate if any certificate on its path has expired or been revoked.

Certification authorities maintain directory servers with databases of valid and revoked certificates. A directory of certificates that have been revoked before the scheduled expiration is called a CRL (Certificate Revocation List). The NWA/WAC can check a peer's certificate against a directory server's list of revoked certificates. The framework of servers, software, procedures and policies that handles keys is called PKI (public-key infrastructure).

## Advantages of Certificates

Certificates offer the following benefits.

- The NWA/WAC only has to store the certificates of the certification authorities that you decide to trust, no matter how many devices you need to authenticate.
- Key distribution is simple and very secure since you can freely distribute public keys and you never need to transmit private keys.

## Self-signed Certificates

You can have the NWA/WAC act as a certification authority and sign its own certificates.

## Factory Default Certificate

The NWA/WAC generates its own unique self-signed certificate when you first turn it on. This certificate is referred to in the GUI as the factory default certificate.

## Certificate File Formats

Any certificate that you want to import has to be in one of these file formats:

- Binary X.509: This is an ITU-T recommendation that defines the formats for X.509 certificates.
- PEM (Base-64) encoded X.509: This Privacy Enhanced Mail format uses lowercase letters, uppercase letters and numerals to convert a binary X.509 certificate into a printable form.
- Binary PKCS#7: This is a standard that defines the general syntax for data (including digital signatures) that may be encrypted. A PKCS #7 file is used to transfer a public key certificate. The private key is not included. The NWA/WAC currently allows the importation of a PKCS#7 file that contains a single certificate.
- PEM (Base-64) encoded PKCS#7: This Privacy Enhanced Mail (PEM) format uses lowercase letters, uppercase letters and numerals to convert a binary PKCS#7 certificate into a printable form.

- Binary PKCS#12: This is a format for transferring public key and private key certificates. The private key in a PKCS #12 file is within a password-encrypted envelope. The file's password is not connected to your certificate's public or private passwords. Exporting a PKCS #12 file creates this and you must provide it to decrypt the contents when you import the file into the NWA/WAC.

Note: Be careful not to convert a binary file to text during the transfer process. It is easy for this to occur since many programs use text files by default.

### 13.1.3 Verifying a Certificate

Before you import a trusted certificate into the NWA/WAC, you should verify that you have the correct certificate. You can do this using the certificate's fingerprint. A certificate's fingerprint is a message digest calculated using the MD5 or SHA1 algorithm. The following procedure describes how to check a certificate's fingerprint to verify that you have the actual certificate.

- 1 Browse to where you have the certificate saved on your computer.
- 2 Make sure that the certificate has a ".cer" or ".crt" file name extension.

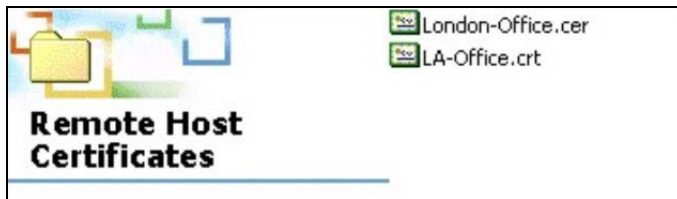

- 3 Double-click the certificate's icon to open the **Certificate** window. Click the **Details** tab and scroll down to the **Thumbprint Algorithm** and **Thumbprint** fields.

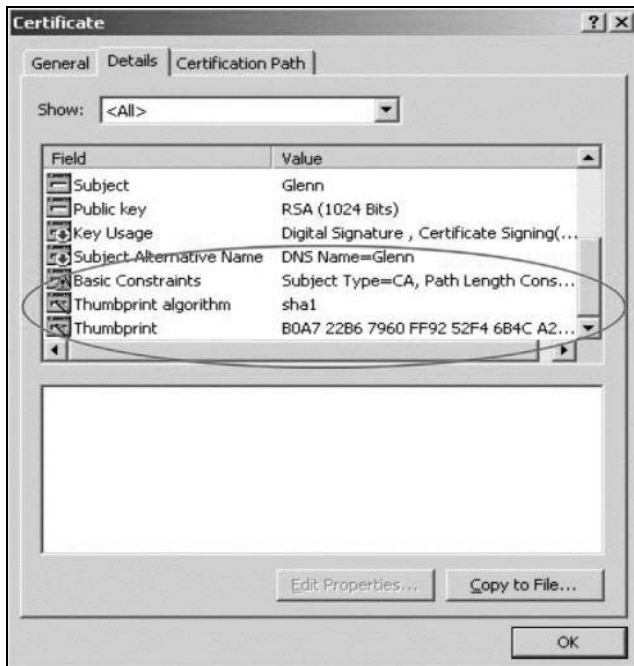

- 4 Use a secure method to verify that the certificate owner has the same information in the **Thumbprint Algorithm** and **Thumbprint** fields. The secure method may vary based on your situation. Possible examples would be over the telephone or through an HTTPS connection.

## 13.2 My Certificates

Click **Configuration > Object > Certificate > My Certificates** to open this screen. This is the NWA/WAC's summary list of certificates and certification requests.

**Figure 84** Configuration > Object > Certificate > My Certificates

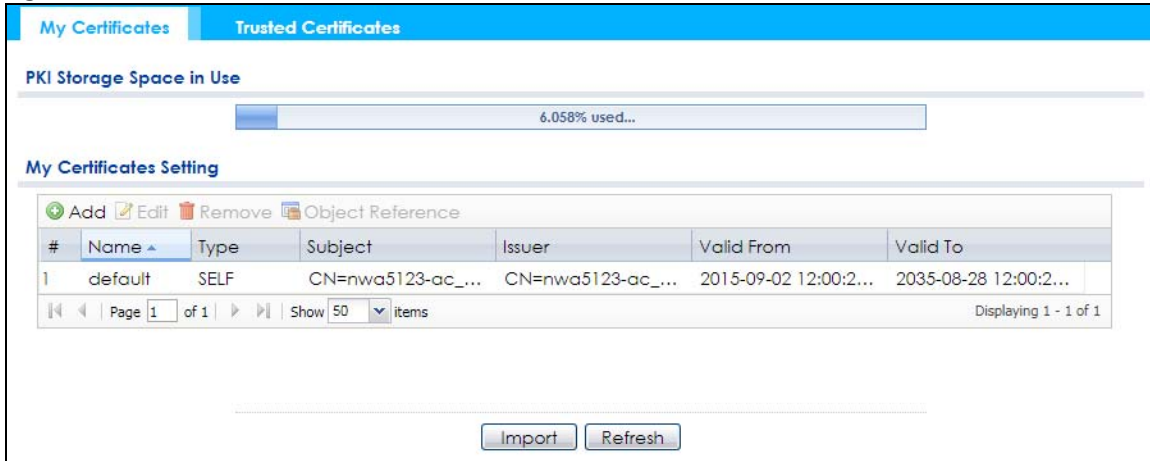

The following table describes the labels in this screen.

**Table 63** Configuration > Object > Certificate > My Certificates

LABEL	DESCRIPTION
PKI Storage Space in Use	This bar displays the percentage of the NWA/WAC's PKI storage space that is currently in use. When the storage space is almost full, you should consider deleting expired or unnecessary certificates before adding more certificates.
Add	Click this to go to the screen where you can have the NWA/WAC generate a certificate or a certification request.
Edit	Double-click an entry or select it and click <b>Edit</b> to open a screen with an in-depth list of information about the certificate.
Remove	The NWA/WAC keeps all of your certificates unless you specifically delete them. Uploading a new firmware or default configuration file does not delete your certificates. To remove an entry, select it and click <b>Remove</b> . The NWA/WAC confirms you want to remove it before doing so. Subsequent certificates move up by one when you take this action.
Object Reference	You cannot delete certificates that any of the NWA/WAC's features are configured to use. Select an entry and click <b>Object Reference</b> to open a screen that shows which settings use the entry.
#	This field displays the certificate index number. The certificates are listed in alphabetical order.
Name	This field displays the name used to identify this certificate. It is recommended that you give each certificate a unique name.
Type	This field displays what kind of certificate this is.  <b>REQ</b> represents a certification request and is not yet a valid certificate. Send a certification request to a certification authority, which then issues a certificate. Use the <b>My Certificate Import</b> screen to import the certificate and replace the request.  <b>SELF</b> represents a self-signed certificate.  <b>CERT</b> represents a certificate issued by a certification authority.
Subject	This field displays identifying information about the certificate's owner, such as CN (Common Name), OU (Organizational Unit or department), O (Organization or company) and C (Country). It is recommended that each certificate have unique subject information.

Table 63 Configuration &gt; Object &gt; Certificate &gt; My Certificates (continued)

LABEL	DESCRIPTION
Issuer	This field displays identifying information about the certificate's issuing certification authority, such as a common name, organizational unit or department, organization or company and country. With self-signed certificates, this is the same information as in the <b>Subject</b> field.
Valid From	This field displays the date that the certificate becomes applicable.
Valid To	This field displays the date that the certificate expires. The text displays in red and includes an Expired! message if the certificate has expired.
Import	Click <b>Import</b> to open a screen where you can save a certificate to the NWA/WAC.
Refresh	Click <b>Refresh</b> to display the current validity status of the certificates.

## 13.2.1 Add My Certificates

Click **Configuration > Object > Certificate > My Certificates** and then the **Add** icon to open the **Add My Certificates** screen. Use this screen to have the NWA/WAC create a self-signed certificate, enroll a certificate with a certification authority or generate a certification request.

Figure 85 Configuration &gt; Object &gt; Certificate &gt; My Certificates &gt; Add

**Add My Certificates**

**Configuration**

Name:

**Subject Information**

Host IP Address

Host Domain Name

E-Mail

Organizational Unit:  (Optional)

Organization:  (Optional)

Town(City):  (Optional)

State(Province):  (Optional)

Country:  (Optional)

Key Type: RSA-SHA256

Key Length: 2048 bits

**Extended Key Usage**

Server Authentication

Client Authentication

Create a self-signed certificate

Create a certification request and save it locally for later manual enrollment

Create a certification request and enroll for a certificate immediately online

Enrollment Protocol: Simple Certificate Enrollment protocol|SC

CA Server Address:

CA Certificate: Please select one... [See Trusted CAs](#)

Request Authentication

Key:

OK Cancel

The following table describes the labels in this screen.

Table 64 Configuration > Object > Certificate > My Certificates > Add

LABEL	DESCRIPTION
Name	Type a name to identify this certificate. You can use up to 31 alphanumeric and ;'~!@#\$\$%^&()_+[]{}',.- characters.
Subject Information	<p>Use these fields to record information that identifies the owner of the certificate. You do not have to fill in every field, although you must specify a <b>Host IP Address</b>, <b>Host Domain Name</b>, or <b>E-Mail</b>. The certification authority may add fields (such as a serial number) to the subject information when it issues a certificate. It is recommended that each certificate have unique subject information.</p> <p>Select a radio button to identify the certificate's owner by IP address, domain name or e-mail address. Type the IP address (in dotted decimal notation), domain name or e-mail address in the field provided. The domain name or e-mail address is for identification purposes only and can be any string.</p> <p>A domain name can be up to 255 characters. You can use alphanumeric characters, the hyphen and periods.</p> <p>An e-mail address can be up to 63 characters. You can use alphanumeric characters, the hyphen, the @ symbol, periods and the underscore.</p>
Organizational Unit	Identify the organizational unit or department to which the certificate owner belongs. You can use up to 31 characters. You can use alphanumeric characters, the hyphen and the underscore.
Organization	Identify the company or group to which the certificate owner belongs. You can use up to 31 characters. You can use alphanumeric characters, the hyphen and the underscore.
Town (City)	Identify the town or city where the certificate owner is located. You can use up to 31 characters. You can use alphanumeric characters, the hyphen and the underscore.
State (Province)	Identify the state or province where the certificate owner is located. You can use up to 31 characters. You can use alphanumeric characters, the hyphen and the underscore.
Country	Identify the nation where the certificate owner is located. You can use up to 31 characters. You can use alphanumeric characters, the hyphen and the underscore.
Key Type	<p>The NWA/WAC uses the RSA (Rivest, Shamir and Adleman) public-key encryption algorithm. SHA1 (Secure Hash Algorithm) and SHA2 are hash algorithms used to authenticate packet data. SHA2-256 or SHA2-512 are part of the SHA2 set of cryptographic functions and they are considered even more secure than SHA1.</p> <p>Select a key type from <b>RSA-SHA256</b> and <b>RSA-SHA512</b>.</p>
Key Length	Select a number from the drop-down list box to determine how many bits the key should use (1024 to 2048). The longer the key, the more secure it is. A longer key also uses more PKI storage space.
Extended Key Usage	<p>Select <b>Server Authentication</b> to allow a web server to send clients the certificate to authenticate itself.</p> <p>Select <b>Client Authentication</b> to use the certificate's key to authenticate clients to the secure gateway.</p>
	These radio buttons deal with how and when the certificate is to be generated.
Create a self-signed certificate	Select this to have the NWA/WAC generate the certificate and act as the Certification Authority (CA) itself. This way you do not need to apply to a certification authority for certificates.
Create a certification request and save it locally for later manual enrollment	<p>Select this to have the NWA/WAC generate and store a request for a certificate. Use the <b>My Certificate Edit</b> screen to view the certification request and copy it to send to the certification authority.</p> <p>Copy the certification request from the <b>My Certificate Edit</b> screen and then send it to the certification authority.</p>

Table 64 Configuration &gt; Object &gt; Certificate &gt; My Certificates &gt; Add (continued)

LABEL	DESCRIPTION
Create a certification request and enroll for a certificate immediately online	<p>Select this to have the NWA/WAC generate a request for a certificate and apply to a certification authority for a certificate.</p> <p>You must have the certification authority's certificate already imported in the <b>Trusted Certificates</b> screen.</p> <p>When you select this option, you must select the certification authority's enrollment protocol and the certification authority's certificate from the drop-down list boxes and enter the certification authority's server address. You also need to fill in the <b>Reference Number</b> and <b>Key</b> if the certification authority requires them.</p>
Enrollment Protocol	<p>This field applies when you select <b>Create a certification request and enroll for a certificate immediately online</b>. Select the certification authority's enrollment protocol from the drop-down list box.</p> <p><b>Simple Certificate Enrollment Protocol (SCEP)</b> is a TCP-based enrollment protocol that was developed by VeriSign and Cisco.</p> <p><b>Certificate Management Protocol (CMP)</b> is a TCP-based enrollment protocol that was developed by the Public Key Infrastructure X.509 working group of the Internet Engineering Task Force (IETF) and is specified in RFC 2510.</p>
CA Server Address	<p>This field applies when you select <b>Create a certification request and enroll for a certificate immediately online</b>. Enter the IP address (or URL) of the certification authority server.</p> <p>For a URL, you can use up to 511 of the following characters. a-zA-Z0-9'()+,./:=-?;!*#@\$_%&amp;</p>
CA Certificate	<p>This field applies when you select <b>Create a certification request and enroll for a certificate immediately online</b>. Select the certification authority's certificate from the <b>CA Certificate</b> drop-down list box.</p> <p>You must have the certification authority's certificate already imported in the <b>Trusted Certificates</b> screen. Click <b>Trusted CAs</b> to go to the <b>Trusted Certificates</b> screen where you can view (and manage) the NWA/WAC's list of certificates of trusted certification authorities.</p>
Request Authentication	<p>When you select <b>Create a certification request and enroll for a certificate immediately online</b>, the certification authority may want you to include a reference number and key to identify you when you send a certification request.</p> <p>Fill in both the <b>Reference Number</b> and the <b>Key</b> fields if your certification authority uses the CMP enrollment protocol. Just the <b>Key</b> field displays if your certification authority uses the SCEP enrollment protocol.</p> <p>For the reference number, use 0 to 99999999.</p> <p>For the key, use up to 31 of the following characters. a-zA-Z0-9; `~!@#%&amp;^&amp;*()_+{}':;./&lt;&gt;=-</p>
OK	Click <b>OK</b> to begin certificate or certification request generation.
Cancel	Click <b>Cancel</b> to quit and return to the <b>My Certificates</b> screen.

If you configured the **Add My Certificates** screen to have the NWA/WAC enroll a certificate and the certificate enrollment is not successful, you see a screen with a **Return** button that takes you back to the **Add My Certificates** screen. Click **Return** and check your information in the **Add My Certificates** screen. Make sure that the certification authority information is correct and that your Internet connection is working properly if you want the NWA/WAC to enroll a certificate online.

## 13.2.2 Edit My Certificates

Click **Configuration > Object > Certificate > My Certificates** and then the **Edit** icon to open the **My Certificate Edit** screen. You can use this screen to view in-depth certificate information and change the certificate's name.

Figure 86 Configuration &gt; Object &gt; Certificate &gt; My Certificates &gt; Edit

**Edit My Certificates** [?] [X]

---

**Configuration**

Name:

---

**Certification Path**

---

**Certificate Information**

Type:	Self-signed X.509 Certificate
Version:	V3
Serial Number:	Signature
Subject:	CN=nwa5123-ac_588BF390F680
Issuer:	CN=nwa5123-ac_588BF390F680
Signature Algorithm:	sha1WithRSAEncryption
Valid From:	2015-09-02 12:00:21 GMT
Valid To:	2035-08-28 12:00:21 GMT
Key Algorithm:	rsaEncryption (1024 bit)
Subject Alternative Name:	nwa5123-ac_588BF390F680
Key Usage:	Digital Signature, Key Encipherment, Data Encipherment, Certificate Sign
Extended Key Usage:	
Basic Constraint:	Subject Type=CA, Path Length Constraint=1
MD5 Fingerprint:	49:69:70:78:6D:03:44:C1:94:3C:4F:A7:07:44:E1:CE
SHA1 Fingerprint:	AF:AE:EC:1D:C1:86:71:80:12:52:D7:F8:A6:F7:B1:9F:7D:B2:99:DC

---

**Certificate in PEM (Base-64) Encoded Format**

```
-----BEGIN X509 CERTIFICATE-----
MIICBzCCAXCgAwIBAgIEVebk1TANBgkqhkiG9w0BAQUFADAIMA5AwHgYDVQQDDDBdu
d2E1MTIzLWFjZm00OUEJGmzkwrjY4MDAeFw0xNTA5MDIxMjAwMjFhZm0zNTA4Mjg4
MjAwMjFhZm0zIDAEbG9uY2oLNTYhKzY4MDAeFw0xNTA5MDIxMjAwMjFhZm0z
MA0GCSqGSIb3DQEBAAUAA4GNADCBiQKBggQDV3HncqwwwvqRaYUBGIE073LSOZm0r3LVg
QexcwULTDmg7ZeNhCeLlqaxludusfulbUHSh1xLzjw0kWAXiaw7ni9RAuAuCT67
xlQVFbnIX1SPs4HLXcYdbYu2oLNyh+rxKP7pUoO5VefgwNIYhuHEzFA/QvDXWDFG
wupgKElq1wIDAQABo0owSDAOBgNVHQ8BAf8EBAMCArQwlgYDVR0RBBSwGYEXbndh
NTEvMkx1YjY4MDAeFw0xNTA5MDIxMjAwMjFhZm0zIDAEbG9uY2oLNTYhKzY4MDAeFw0xNTA5MDIxMjAwMjFhZm0z
-----
```

Password:

The following table describes the labels in this screen.

Table 65 Configuration > Object > Certificate > My Certificates > Edit

LABEL	DESCRIPTION
Name	This field displays the identifying name of this certificate. You can use up to 31 alphanumeric and ;'~!@#\$\$%^&()_+[]{}',.-= characters.
Certification Path	<p>This field displays for a certificate, not a certification request.</p> <p>Click the <b>Refresh</b> button to have this read-only text box display the hierarchy of certification authorities that validate the certificate (and the certificate itself).</p> <p>If the issuing certification authority is one that you have imported as a trusted certification authority, it may be the only certification authority in the list (along with the certificate itself). If the certificate is a self-signed certificate, the certificate itself is the only one in the list. The NWA/WAC does not trust the certificate and displays "Not trusted" in this field if any certificate on the path has expired or been revoked.</p>
Refresh	Click <b>Refresh</b> to display the certification path.
Certificate Information	These read-only fields display detailed information about the certificate.
Type	This field displays general information about the certificate. CA-signed means that a Certification Authority signed the certificate. Self-signed means that the certificate's owner signed the certificate (not a certification authority). "X.509" means that this certificate was created and signed according to the ITU-T X.509 recommendation that defines the formats for public-key certificates.
Version	This field displays the X.509 version number. "
Serial Number	This field displays the certificate's identification number given by the certification authority or generated by the NWA/WAC.
Subject	This field displays information that identifies the owner of the certificate, such as Common Name (CN), Organizational Unit (OU), Organization (O), State (ST), and Country (C).
Issuer	<p>This field displays identifying information about the certificate's issuing certification authority, such as Common Name, Organizational Unit, Organization and Country.</p> <p>With self-signed certificates, this is the same as the <b>Subject Name</b> field.</p> <p>"none" displays for a certification request.</p>
Signature Algorithm	This field displays the type of algorithm that was used to sign the certificate.
Valid From	This field displays the date that the certificate becomes applicable. "none" displays for a certification request.
Valid To	This field displays the date that the certificate expires. The text displays in red and includes an Expired! message if the certificate has expired. "none" displays for a certification request.
Key Algorithm	This field displays the type of algorithm that was used to generate the certificate's key pair (the NWA/WAC uses RSA encryption) and the length of the key set in bits (1024 bits for example).
Subject Alternative Name	This field displays the certificate owner's IP address (IP), domain name (DNS) or e-mail address (EMAIL).
Key Usage	This field displays for what functions the certificate's key can be used. For example, "DigitalSignature" means that the key can be used to sign certificates and "KeyEncipherment" means that the key can be used to encrypt text.
Extended Key Usage	This field displays for what EKU (Extended Key Usage) functions the certificate's key can be used.
Basic Constraint	This field displays general information about the certificate. For example, Subject Type=CA means that this is a certification authority's certificate and "Path Length Constraint=1" means that there can only be one certification authority in the certificate's path. This field does not display for a certification request.



Table 65 Configuration &gt; Object &gt; Certificate &gt; My Certificates &gt; Edit

LABEL	DESCRIPTION
MD5 Fingerprint	This is the certificate's message digest that the NWA/WAC calculated using the MD5 algorithm.
SHA1 Fingerprint	This is the certificate's message digest that the NWA/WAC calculated using the SHA1 algorithm.
Certificate in PEM (Base-64) Encoded Format	<p>This read-only text box displays the certificate or certification request in Privacy Enhanced Mail (PEM) format. PEM uses lowercase letters, uppercase letters and numerals to convert a binary certificate into a printable form.</p> <p>You can copy and paste a certification request into a certification authority's web page, an e-mail that you send to the certification authority or a text editor and save the file on a management computer for later manual enrollment.</p> <p>You can copy and paste a certificate into an e-mail to send to friends or colleagues or you can copy and paste a certificate into a text editor and save the file on a management computer for later distribution (via floppy disk for example).</p>
Export Certificate Only	Use this button to save a copy of the certificate without its private key. Click this button and then <b>Save</b> in the <b>File Download</b> screen. The <b>Save As</b> screen opens, browse to the location that you want to use and click <b>Save</b> .
Password	If you want to export the certificate with its private key, create a password and type it here. Make sure you keep this password in a safe place. You will need to use it if you import the certificate to another device.
Export Certificate with Private Key	Use this button to save a copy of the certificate with its private key. Type the certificate's password and click this button. Click <b>Save</b> in the <b>File Download</b> screen. The <b>Save As</b> screen opens, browse to the location that you want to use and click <b>Save</b> .
OK	Click <b>OK</b> to save your changes back to the NWA/WAC. You can only change the name.
Cancel	Click <b>Cancel</b> to quit and return to the <b>My Certificates</b> screen.

### 13.2.3 Import Certificates

Click **Configuration > Object > Certificate > My Certificates > Import** to open the **My Certificate Import** screen. Follow the instructions in this screen to save an existing certificate to the NWA/WAC.

Note: You can import a certificate that matches a corresponding certification request that was generated by the NWA/WAC. You can also import a certificate in PKCS#12 format, including the certificate's public and private keys.

The certificate you import replaces the corresponding request in the **My Certificates** screen.

You must remove any spaces in the certificate's filename before you can import it.

**Figure 87** Configuration > Object > Certificate > My Certificates > Import

The following table describes the labels in this screen.

**Table 66** Configuration > Object > Certificate > My Certificates > Import

LABEL	DESCRIPTION
File Path	Type in the location of the file you want to upload in this field or click <b>Browse</b> to find it. You cannot import a certificate with the same name as a certificate that is already in the NWA/WAC.
Browse	Click <b>Browse</b> to find the certificate file you want to upload.
Password	This field only applies when you import a binary PKCS#12 format file. Type the file's password that was created when the PKCS #12 file was exported.
OK	Click <b>OK</b> to save the certificate on the NWA/WAC.
Cancel	Click <b>Cancel</b> to quit and return to the <b>My Certificates</b> screen.

## 13.3 Trusted Certificates

Click **Configuration > Object > Certificate > Trusted Certificates** to open the **Trusted Certificates** screen. This screen displays a summary list of certificates that you have set the NWA/WAC to accept as trusted. The NWA/WAC also accepts any valid certificate signed by a certificate on this list as being trustworthy; thus you do not need to import any certificate that is signed by one of these certificates.

Figure 88 Configuration &gt; Object &gt; Certificate &gt; Trusted Certificates

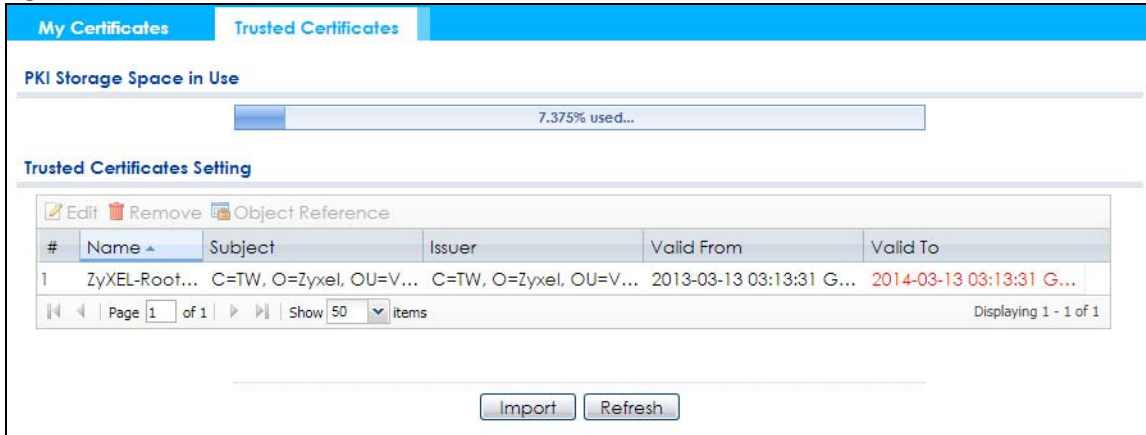

The following table describes the labels in this screen.

Table 67 Configuration &gt; Object &gt; Certificate &gt; Trusted Certificates

LABEL	DESCRIPTION
PKI Storage Space in Use	This bar displays the percentage of the NWA/WAC's PKI storage space that is currently in use. When the storage space is almost full, you should consider deleting expired or unnecessary certificates before adding more certificates.
Edit	Double-click an entry or select it and click <b>Edit</b> to open a screen with an in-depth list of information about the certificate.
Remove	The NWA/WAC keeps all of your certificates unless you specifically delete them. Uploading a new firmware or default configuration file does not delete your certificates. To remove an entry, select it and click <b>Remove</b> . The NWA/WAC confirms you want to remove it before doing so. Subsequent certificates move up by one when you take this action.
Object Reference	You cannot delete certificates that any of the NWA/WAC's features are configured to use. Select an entry and click <b>Object Reference</b> to open a screen that shows which settings use the entry.
#	This field displays the certificate index number. The certificates are listed in alphabetical order.
Name	This field displays the name used to identify this certificate.
Subject	This field displays identifying information about the certificate's owner, such as CN (Common Name), OU (Organizational Unit or department), O (Organization or company) and C (Country). It is recommended that each certificate have unique subject information.
Issuer	This field displays identifying information about the certificate's issuing certification authority, such as a common name, organizational unit or department, organization or company and country. With self-signed certificates, this is the same information as in the <b>Subject</b> field.
Valid From	This field displays the date that the certificate becomes applicable.
Valid To	This field displays the date that the certificate expires. The text displays in red and includes an Expired! message if the certificate has expired.
Import	Click <b>Import</b> to open a screen where you can save the certificate of a certification authority that you trust, from your computer to the NWA/WAC.
Refresh	Click this button to display the current validity status of the certificates.

### 13.3.1 Edit Trusted Certificates

Click **Configuration > Object > Certificate > Trusted Certificates** and then a certificate's **Edit** icon to open the **Trusted Certificates Edit** screen. Use this screen to view in-depth information about the certificate, change the certificate's name and set whether or not you want the NWA/WAC to check a certification authority's list of revoked certificates before trusting a certificate issued by the certification authority.

Figure 89 Configuration &gt; Object &gt; Certificate &gt; Trusted Certificates &gt; Edit

**Edit Trusted Certificates**

---

**Configuration**

Name:

---

**Certification Path**

---

**Certificate Validation**

Enable X.509v3 CRL Distribution Points and OCSP checking

OCSP Server

URL:

ID:

Password:

LDAP Server

Address:  Port:

ID:

Password:

---

**Certificate Information**

Type: Self-signed X.509 Certificate

Version: V3

Serial Number: 59:72:93:d0:34:4b:11:f5:ed:33:3c:3d:bf:87:01:da

Subject: C=TW, O=Zyxel, OU=VPN Department, OU=RootCA

Issuer: C=TW, O=Zyxel, OU=VPN Department, OU=RootCA

Signature Algorithm: sha1WithRSAEncryption

Valid From: 2013-03-13 03:13:31 GMT

Valid To: 2014-03-13 03:13:31 GMT

Key Algorithm: rsaEncryption (2048 bit)

Subject Alternative Name:

Key Usage:

Extended Key Usage:

Basic Constraint: Subject Type=CA, Path Length Constraint=-1

MD5 Fingerprint: 16:43:D8:57:C5:CD:26:D0:FD:EC:33:ED:7E:7D:85:E9

SHA1 Fingerprint: CC:1E:DB:F8:07:48:B4:07:04:23:33:21:6D:39:45:BC:61:39:A0:C8

---

**Certificate**

```
-----BEGIN X509 CERTIFICATE-----
MIIDRzCCAItgAwIBAgIQWXXKT0DRLEfXtMzw9v4cB2jANBgkqhkiG9w0BAQUFADBH
MQswCQYDVQQGEwJUVzEOMAwGA1UECgwFWWnl4ZWwxfzAVBgNVBAsMDIZQTIBEXBh
cnRtZW50MQ8wDQYDVQQQLDAZSb290Q0EwHhcNMMDMwMzEzMDMxMzVhcnNMDQw
MzEz
MDMxMzEzMDMxMzVhcnRtZW50MQ8wDQYDVQQGEwJUVzEOMAwGA1UECgwFWWnl4ZWwxfzAVBgNVB
AsM
DIZQTIBEXBhcnRtZW50MQ8wDQYDVQQQLDAZSb290Q0EwggEIMA0GCSqGSIb3DQEB
AQIIA4A1BDMwAwgAEKAAoR&ODAnmeIA3HvHlGOr9A/hA7NwvTRvuO8koTf1E/gd0z
```

The following table describes the labels in this screen.

Table 68 Configuration > Object > Certificate > Trusted Certificates > Edit

LABEL	DESCRIPTION
Name	This field displays the identifying name of this certificate. You can change the name. You can use up to 31 alphanumeric and ;'~!@#%&()_+[]{}',.- characters.
Certification Path	Click the <b>Refresh</b> button to have this read-only text box display the end entity's certificate and a list of certification authority certificates that shows the hierarchy of certification authorities that validate the end entity's certificate. If the issuing certification authority is one that you have imported as a trusted certificate, it may be the only certification authority in the list (along with the end entity's own certificate). The NWA/WAC does not trust the end entity's certificate and displays "Not trusted" in this field if any certificate on the path has expired or been revoked.
Refresh	Click <b>Refresh</b> to display the certification path.
Enable X.509v3 CRL Distribution Points and OCSP checking	Select this check box to have the NWA/WAC check incoming certificates that are signed by this certificate against a Certificate Revocation List (CRL) or an OCSP server. You also need to configure the OCSP or LDAP server details.
OCSP Server	Select this check box if the directory server uses OCSP (Online Certificate Status Protocol).
URL	Type the protocol, IP address and pathname of the OCSP server.
ID	The NWA/WAC may need to authenticate itself in order to assess the OCSP server. Type the login name (up to 31 ASCII characters) from the entity maintaining the server (usually a certification authority).
Password	Type the password (up to 31 ASCII characters) from the entity maintaining the OCSP server (usually a certification authority).
LDAP Server	Select this check box if the directory server uses LDAP (Lightweight Directory Access Protocol). LDAP is a protocol over TCP that specifies how clients access directories of certificates and lists of revoked certificates.
Address	Type the IP address (in dotted decimal notation) of the directory server.
Port	Use this field to specify the LDAP server port number. You must use the same server port number that the directory server uses. 389 is the default server port number for LDAP.
ID	The NWA/WAC may need to authenticate itself in order to assess the CRL directory server. Type the login name (up to 31 ASCII characters) from the entity maintaining the server (usually a certification authority).
Password	Type the password (up to 31 ASCII characters) from the entity maintaining the CRL directory server (usually a certification authority).
Certificate Information	These read-only fields display detailed information about the certificate.
Type	This field displays general information about the certificate. CA-signed means that a Certification Authority signed the certificate. Self-signed means that the certificate's owner signed the certificate (not a certification authority). X.509 means that this certificate was created and signed according to the ITU-T X.509 recommendation that defines the formats for public-key certificates.
Version	This field displays the X.509 version number.
Serial Number	This field displays the certificate's identification number given by the certification authority.
Subject	This field displays information that identifies the owner of the certificate, such as Common Name (CN), Organizational Unit (OU), Organization (O) and Country (C).
Issuer	This field displays identifying information about the certificate's issuing certification authority, such as Common Name, Organizational Unit, Organization and Country.  With self-signed certificates, this is the same information as in the <b>Subject Name</b> field.
Signature Algorithm	This field displays the type of algorithm that was used to sign the certificate. Some certification authorities use rsa-pkcs1-sha1 (RSA public-private key encryption algorithm and the SHA1 hash algorithm). Other certification authorities may use rsa-pkcs1-md5 (RSA public-private key encryption algorithm and the MD5 hash algorithm).

Table 68 Configuration &gt; Object &gt; Certificate &gt; Trusted Certificates &gt; Edit (continued)

LABEL	DESCRIPTION
Valid From	This field displays the date that the certificate becomes applicable. The text displays in red and includes a Not Yet Valid! message if the certificate has not yet become applicable.
Valid To	This field displays the date that the certificate expires. The text displays in red and includes an Expiring! or Expired! message if the certificate is about to expire or has already expired.
Key Algorithm	This field displays the type of algorithm that was used to generate the certificate's key pair (the NWA/WAC uses RSA encryption) and the length of the key set in bits (1024 bits for example).
Subject Alternative Name	This field displays the certificate's owner's IP address (IP), domain name (DNS) or e-mail address (EMAIL).
Key Usage	This field displays for what functions the certificate's key can be used. For example, "DigitalSignature" means that the key can be used to sign certificates and "KeyEncipherment" means that the key can be used to encrypt text.
Basic Constraint	This field displays general information about the certificate. For example, Subject Type=CA means that this is a certification authority's certificate and "Path Length Constraint=1" means that there can only be one certification authority in the certificate's path.
MD5 Fingerprint	This is the certificate's message digest that the NWA/WAC calculated using the MD5 algorithm. You can use this value to verify with the certification authority (over the phone for example) that this is actually their certificate.
SHA1 Fingerprint	This is the certificate's message digest that the NWA/WAC calculated using the SHA1 algorithm. You can use this value to verify with the certification authority (over the phone for example) that this is actually their certificate.
Certificate	This read-only text box displays the certificate or certification request in Privacy Enhanced Mail (PEM) format. PEM uses lowercase letters, uppercase letters and numerals to convert a binary certificate into a printable form.  You can copy and paste the certificate into an e-mail to send to friends or colleagues or you can copy and paste the certificate into a text editor and save the file on a management computer for later distribution (via floppy disk for example).
Export Certificate	Click this button and then <b>Save</b> in the <b>File Download</b> screen. The <b>Save As</b> screen opens, browse to the location that you want to use and click <b>Save</b> .
OK	Click <b>OK</b> to save your changes back to the NWA/WAC. You can only change the name.
Cancel	Click <b>Cancel</b> to quit and return to the <b>Trusted Certificates</b> screen.

### 13.3.2 Import Trusted Certificates

Click **Configuration > Object > Certificate > Trusted Certificates > Import** to open the **Import Trusted Certificates** screen. Follow the instructions in this screen to save a trusted certificate to the NWA/WAC.

Note: You must remove any spaces from the certificate's filename before you can import the certificate.

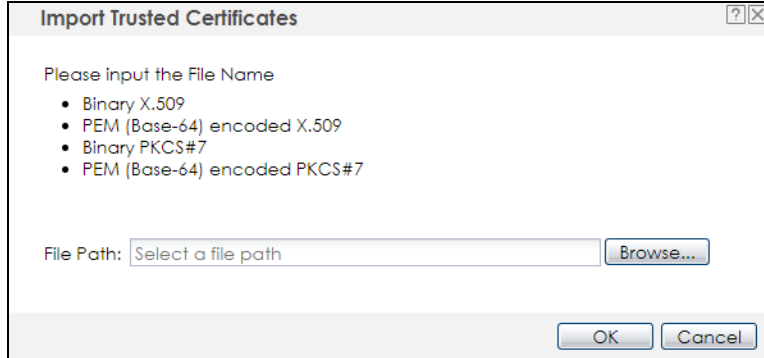
**Figure 90** Configuration > Object > Certificate > Trusted Certificates > Import

The following table describes the labels in this screen.

**Table 69** Configuration > Object > Certificate > Trusted Certificates > Import

LABEL	DESCRIPTION
File Path	Type in the location of the file you want to upload in this field or click <b>Browse</b> to find it.  You cannot import a certificate with the same name as a certificate that is already in the NWA/WAC.
Browse	Click <b>Browse</b> to find the certificate file you want to upload.
OK	Click <b>OK</b> to save the certificate on the NWA/WAC.
Cancel	Click <b>Cancel</b> to quit and return to the previous screen.

## 13.4 Technical Reference

The following section contains additional technical information about the features described in this chapter.

### OCSP

OCSP (Online Certificate Status Protocol) allows an application or device to check whether a certificate is valid. With OCSP the NWA/WAC checks the status of individual certificates instead of downloading a Certificate Revocation List (CRL). OCSP has two main advantages over a CRL. The first is real-time status information. The second is a reduction in network traffic since the NWA/WAC only gets information on the certificates that it needs to verify, not a huge list. When the NWA/WAC requests certificate status information, the OCSP server returns a "expired", "current" or "unknown" response.

# CHAPTER 14

## System

### 14.1 Overview

Use the system screens to configure general NWA/WAC settings.

#### 14.1.1 What You Can Do in this Chapter

- The **Host Name** screen ([Section 14.2 on page 148](#)) configures a unique name for the NWA/WAC in your network.
- The **Date/Time** screen ([Section 14.3 on page 149](#)) configures the date and time for the NWA/WAC.
- The **WWW** screens ([Section 14.4 on page 153](#)) configure settings for HTTP or HTTPS access to the NWA/WAC.
- The **SSH** screen ([Section 14.5 on page 163](#)) configures SSH (Secure SHell) for securely accessing the NWA/WAC's command line interface.
- The **Telnet** screen ([Section 14.6 on page 167](#)) configures Telnet for accessing the NWA/WAC's command line interface.
- The **FTP** screen ([Section 14.7 on page 167](#)) specifies FTP server settings. You can upload and download the NWA/WAC's firmware and configuration files using FTP. Please also see [Chapter 16 on page 185](#) for more information about firmware and configuration files.
- The **SNMP** screens ([Section 14.8 on page 168](#)) configure the device's SNMP settings, including profiles that define allowed SNMPv3 access.

### 14.2 Host Name

A host name is the unique name by which a device is known on a network. Click **Configuration > System > Host Name** to open this screen.

**Figure 91** Configuration > System > Host Name

The screenshot shows a web-based configuration interface for the 'Host Name' screen. The title bar is blue and contains the text 'Host Name'. Below the title bar, there is a section titled 'General Settings'. This section contains three rows of configuration options, each with a text input field and the label '(Optional)'. The first row is 'System Name:', the second is 'System Location:', and the third is 'Domain Name:'. At the bottom of the form, there are two buttons: 'Apply' and 'Reset'.



The following table describes the labels in this screen.

Table 70 Configuration > System > Host Name

LABEL	DESCRIPTION
System Name	Choose a descriptive name to identify your NWA/WAC device. This name can be up to 64 alphanumeric characters long. Spaces are not allowed, but dashes (-) underscores (_) and periods (.) are accepted.
System Location	Specify the name of the place where the NWA/WAC is located. You can enter up to 60 alphanumeric and '() ,:;! +* / = # \$ % @ characters. Spaces and underscores are allowed. The name should start with a letter.
Domain Name	Enter the domain name (if you know it) here. This name is propagated to DHCP clients connected to interfaces with the DHCP server enabled. This name can be up to 254 alphanumeric characters long. Spaces are not allowed, but dashes "-" are accepted.
Apply	Click <b>Apply</b> to save your changes back to the NWA/WAC.
Reset	Click <b>Reset</b> to return the screen to its last-saved settings.

## 14.3 Date and Time

For effective scheduling and logging, the NWA/WAC system time must be accurate. The NWA/WAC has a software mechanism to set the time manually or get the current time and date from an external server.

To change your NWA/WAC's time based on your local time zone and date, click **Configuration > System > Date/Time**. The screen displays as shown. You can manually set the NWA/WAC's time and date or have the NWA/WAC get the date and time from a time server.

Figure 92 Configuration &gt; System &gt; Date/Time

The following table describes the labels in this screen.

Table 71 Configuration &gt; System &gt; Date/Time

LABEL	DESCRIPTION
Current Time and Date	
Current Time	This field displays the present time of your NWA/WAC.
Current Date	This field displays the present date of your NWA/WAC.
Time and Date Setup	
Manual	Select this radio button to enter the time and date manually. If you configure a new time and date, time zone and daylight saving at the same time, the time zone and daylight saving will affect the new time and date you entered. When you enter the time settings manually, the NWA/WAC uses the new setting once you click <b>Apply</b> .
New Time (hh:mm:ss)	This field displays the last updated time from the time server or the last time configured manually. When you set <b>Time and Date Setup</b> to <b>Manual</b> , enter the new time in this field and then click <b>Apply</b> .
New Date (yyyy-mm-dd)	This field displays the last updated date from the time server or the last date configured manually. When you set <b>Time and Date Setup</b> to <b>Manual</b> , enter the new date in this field and then click <b>Apply</b> .

Table 71 Configuration &gt; System &gt; Date/Time (continued)

LABEL	DESCRIPTION
Get from Time Server	<p>Select this radio button to have the NWA/WAC get the time and date from the time server you specify below. The NWA/WAC requests time and date settings from the time server under the following circumstances.</p> <ul style="list-style-type: none"> <li>• When the NWA/WAC starts up.</li> <li>• When you click <b>Apply</b> or <b>Sync. Now</b> in this screen.</li> <li>• 24-hour intervals after starting up.</li> </ul>
Time Server Address	Enter the IP address or URL of your time server. Check with your ISP/network administrator if you are unsure of this information.
Sync. Now	Click this button to have the NWA/WAC get the time and date from a time server (see the <b>Time Server Address</b> field). This also saves your changes (except the daylight saving settings).
Time Zone Setup	
Time Zone	Choose the time zone of your location. This will set the time difference between your time zone and Greenwich Mean Time (GMT).
Enable Daylight Saving	<p>Daylight saving is a period from late spring to fall when many countries set their clocks ahead of normal local time by one hour to give more daytime light in the evening.</p> <p>Select this option if you use Daylight Saving Time.</p>
Start Date	<p>Configure the day and time when Daylight Saving Time starts if you selected <b>Enable Daylight Saving</b>. The <b>at</b> field uses the 24 hour format. Here are a couple of examples:</p> <p>Daylight Saving Time starts in most parts of the United States on the second Sunday of March. Each time zone in the United States starts using Daylight Saving Time at 2 A.M. local time. So in the United States you would select <b>Second, Sunday, March</b> and type 2 in the <b>at</b> field.</p> <p>Daylight Saving Time starts in the European Union on the last Sunday of March. All of the time zones in the European Union start using Daylight Saving Time at the same moment (1 A.M. GMT or UTC). So in the European Union you would select <b>Last, Sunday, March</b>. The time you type in the <b>at</b> field depends on your time zone. In Germany for instance, you would type 2 because Germany's time zone is one hour ahead of GMT or UTC (GMT+1).</p>
End Date	<p>Configure the day and time when Daylight Saving Time ends if you selected <b>Enable Daylight Saving</b>. The <b>at</b> field uses the 24 hour format. Here are a couple of examples:</p> <p>Daylight Saving Time ends in the United States on the first Sunday of November. Each time zone in the United States stops using Daylight Saving Time at 2 A.M. local time. So in the United States you would select <b>First, Sunday, November</b> and type 2 in the <b>at</b> field.</p> <p>Daylight Saving Time ends in the European Union on the last Sunday of October. All of the time zones in the European Union stop using Daylight Saving Time at the same moment (1 A.M. GMT or UTC). So in the European Union you would select <b>Last, Sunday, October</b>. The time you type in the <b>at</b> field depends on your time zone. In Germany for instance, you would type 2 because Germany's time zone is one hour ahead of GMT or UTC (GMT+1).</p>
Offset	<p>Specify how much the clock changes when daylight saving begins and ends.</p> <p>Enter a number from 1 to 5.5 (by 0.5 increments).</p> <p>For example, if you set this field to 3.5, a log occurred at 6 P.M. in local official time will appear as if it had occurred at 10:30 P.M.</p>
Apply	Click <b>Apply</b> to save your changes back to the NWA/WAC.
Reset	Click <b>Reset</b> to return the screen to its last-saved settings.

### 14.3.1 Pre-defined NTP Time Servers List

When you turn on the NWA/WAC for the first time, the date and time start at 2003-01-01 00:00:00. The NWA/WAC then attempts to synchronize with one of the following pre-defined list of Network Time Protocol (NTP) time servers.

The NWA/WAC continues to use the following pre-defined list of NTP time servers if you do not specify a time server or it cannot synchronize with the time server you specified.

Table 72 Default Time Servers

0.pool.ntp.org
1.pool.ntp.org
2.pool.ntp.org

When the NWA/WAC uses the pre-defined list of NTP time servers, it randomly selects one server and tries to synchronize with it. If the synchronization fails, then the NWA/WAC goes through the rest of the list in order from the first one tried until either it is successful or all the pre-defined NTP time servers have been tried.

### 14.3.2 Time Server Synchronization

Click the **Sync. Now** button to get the time and date from the time server you specified in the **Time Server Address** field.

When the **Loading** message appears, you may have to wait up to one minute.

Figure 93 Loading

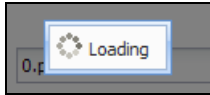

The **Current Time** and **Current Date** fields will display the appropriate settings if the synchronization is successful.

If the synchronization was not successful, a log displays in the **View Log** screen. Try re-configuring the **Date/Time** screen.

To manually set the NWA/WAC date and time:

- 1 Click **System > Date/Time**.
- 2 Select **Manual** under **Time and Date Setup**.
- 3 Enter the NWA/WAC's time in the **New Time** field.
- 4 Enter the NWA/WAC's date in the **New Date** field.
- 5 Under **Time Zone Setup**, select your **Time Zone** from the list.
- 6 As an option you can select the **Enable Daylight Saving** check box to adjust the NWA/WAC clock for daylight savings.
- 7 Click **Apply**.

To get the NWA/WAC date and time from a time server:

- 1 Click **System > Date/Time**.
- 2 Select **Get from Time Server** under **Time and Date Setup**.
- 3 Under **Time Zone Setup**, select your **Time Zone** from the list.
- 4 Under **Time and Date Setup**, enter a **Time Server Address**.
- 5 Click **Apply**.

## 14.4 WWW Overview

The following figure shows secure and insecure management of the NWA/WAC coming in from the WAN. HTTPS and SSH access are secure. HTTP, Telnet, and FTP management access are not secure.

**Figure 94** Secure and Insecure Service Access From the WAN

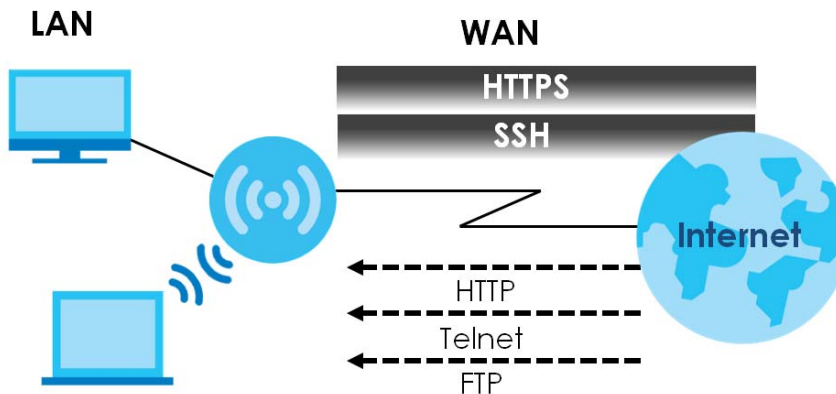

### 14.4.1 Service Access Limitations

A service cannot be used to access the NWA/WAC when you have disabled that service in the corresponding screen.

### 14.4.2 System Timeout

There is a lease timeout for administrators. The NWA/WAC automatically logs you out if the management session remains idle for longer than this timeout period. The management session does not time out when a statistics screen is polling.

Each user is also forced to log in the NWA/WAC for authentication again when the reauthentication time expires.

You can change the timeout settings in the **User** screens.

### 14.4.3 HTTPS

You can set the NWA/WAC to use HTTP or HTTPS (HTTPS adds security) for Web Configurator sessions.

HTTPS (HyperText Transfer Protocol over Secure Socket Layer, or HTTP over SSL) is a web protocol that encrypts and decrypts web pages. Secure Socket Layer (SSL) is an application-level protocol that enables secure transactions of data by ensuring confidentiality (an unauthorized party cannot read the transferred data), authentication (one party can identify the other party) and data integrity (you know if data has been changed).

It relies upon certificates, public keys, and private keys (see [Chapter 13 on page 132](#) for more information).

HTTPS on the NWA/WAC is used so that you can securely access the NWA/WAC using the Web Configurator. The SSL protocol specifies that the HTTPS server (the NWA/WAC) must always authenticate itself to the HTTPS client (the computer which requests the HTTPS connection with the NWA/WAC), whereas the HTTPS client only should authenticate itself when the HTTPS server requires it to do so (select **Authenticate Client Certificates** in the **WWW** screen). **Authenticate Client Certificates** is optional and if selected means the HTTPS client must send the NWA/WAC a certificate. You must apply for a certificate for the browser from a CA that is a trusted CA on the NWA/WAC.

Please refer to the following figure.

- 1 HTTPS connection requests from an SSL-aware web browser go to port 443 (by default) on the NWA/WAC's web server.
- 2 HTTP connection requests from a web browser go to port 80 (by default) on the NWA/WAC's web server.

**Figure 95** HTTP/HTTPS Implementation

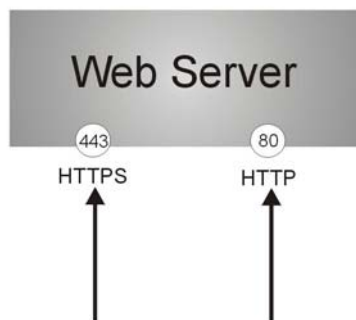

Note: If you disable **HTTP** in the **WWW** screen, then the NWA/WAC blocks all HTTP connection attempts.

### 14.4.4 Configuring WWW Service Control

Click **Configuration** > **System** > **WWW** to open the **WWW** screen. Use this screen to specify HTTP or HTTPS settings.

Figure 96 Configuration &gt; System &gt; WWW &gt; Service Control

**Service Control**

**HTTPS**

Enable

Server Port:

Authenticate Client Certificates (See [Trusted CAs](#))

Server Certificate:

Redirect HTTP to HTTPS

**HTTP**

Enable

Server Port:

The following table describes the labels in this screen.

Table 73 Configuration &gt; System &gt; WWW &gt; Service Control

LABEL	DESCRIPTION
HTTPS	
Enable	Select the check box to allow or disallow the computer with the IP address that matches the IP address(es) in the <b>Service Control</b> table to access the NWA/WAC Web Configurator using secure HTTPs connections.
Server Port	The HTTPS server listens on port 443 by default. If you change the HTTPS server port to a different number on the NWA/WAC, for example 8443, then you must notify people who need to access the NWA/WAC Web Configurator to use "https://NWA/WAC IP Address: <b>8443</b> " as the URL.
Authenticate Client Certificates	Select <b>Authenticate Client Certificates</b> (optional) to require the SSL client to authenticate itself to the NWA/WAC by sending the NWA/WAC a certificate. To do that the SSL client must have a CA-signed certificate from a CA that has been imported as a trusted CA on the NWA/WAC.
Server Certificate	Select a certificate the HTTPS server (the NWA/WAC) uses to authenticate itself to the HTTPS client. You must have certificates already configured in the <b>My Certificates</b> screen.
Redirect HTTP to HTTPS	To allow only secure Web Configurator access, select this to redirect all HTTP connection requests to the HTTPS server.
HTTP	
Enable	Select the check box to allow or disallow the computer with the IP address that matches the IP address(es) in the <b>Service Control</b> table to access the NWA/WAC Web Configurator using HTTP connections.
Server Port	You may change the server port number for a service if needed, however you must use the same port number in order to use that service to access the NWA/WAC.
Apply	Click <b>Apply</b> to save your changes back to the NWA/WAC.
Reset	Click <b>Reset</b> to return the screen to its last-saved settings.

### 14.4.5 HTTPS Example

If you haven't changed the default HTTPS port on the NWA/WAC, then in your browser enter "https://NWA/WAC IP Address/" as the web site address where "NWA/WAC IP Address" is the IP address or domain name of the NWA/WAC you wish to access.

### 14.4.5.1 Internet Explorer Warning Messages

When you attempt to access the NWA/WAC HTTPS server, you will see the error message shown in the following screen.

**Figure 97** Security Alert Dialog Box (Internet Explorer)

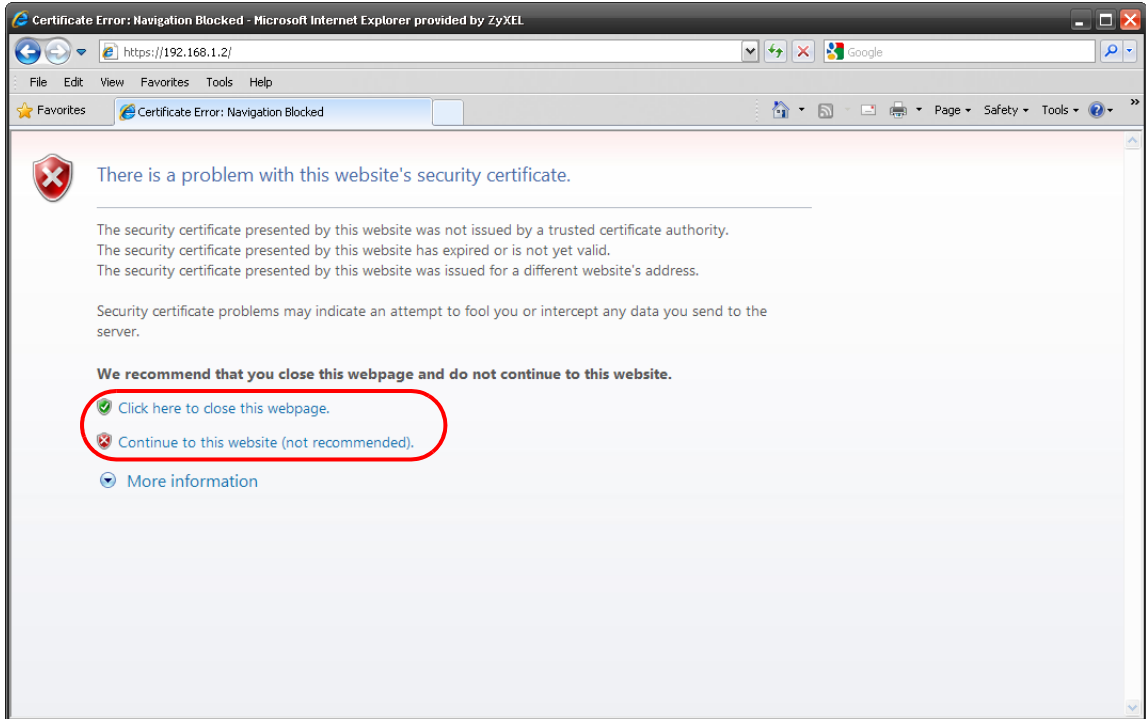

Select **Continue to this website.** to proceed to the Web Configurator login screen. Otherwise, select **Click here to close this webpage.** to block the access.

### 14.4.5.2 Mozilla Firefox Warning Messages

When you attempt to access the NWA/WAC HTTPS server, a **The Connection is Untrusted** screen appears as shown in the following screen. Click **Technical Details** if you want to verify more information about the certificate from the NWA/WAC.

Select **I Understand the Risks** and then click **Add Exception** to add the NWA/WAC to the security exception list. Click **Confirm Security Exception.**



Figure 98 Security Certificate 1 (Firefox)

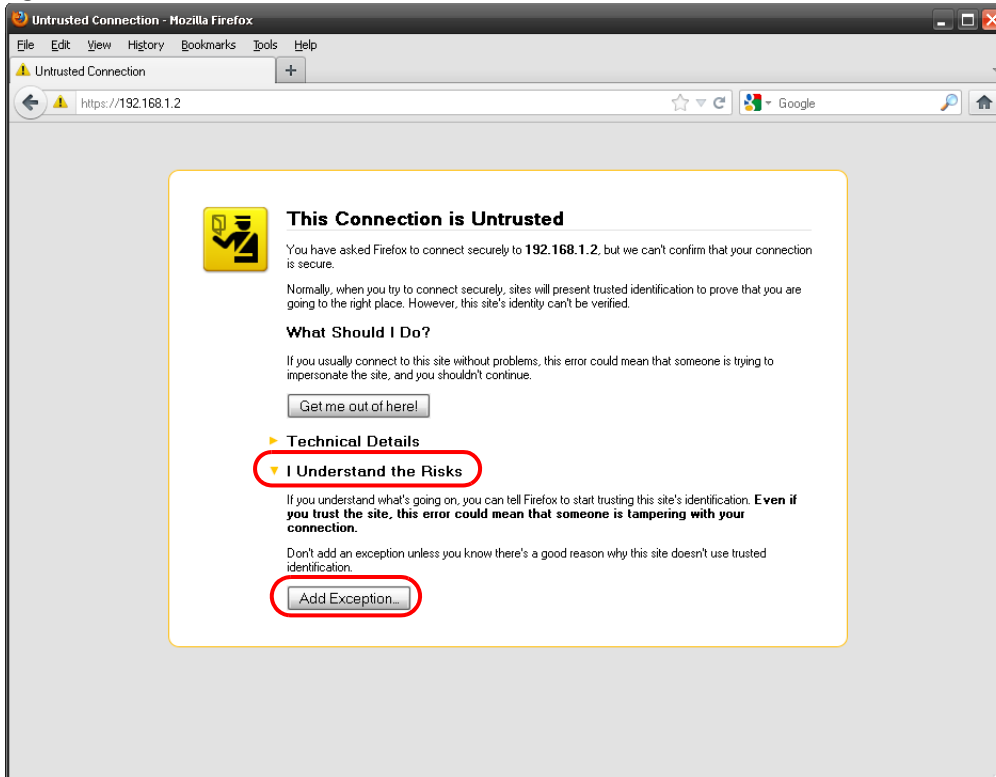
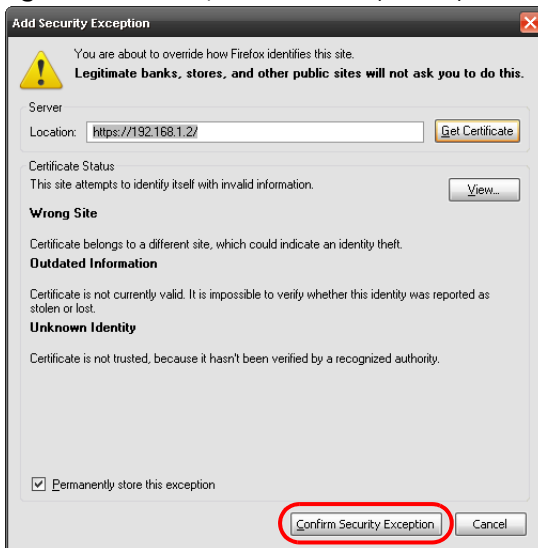

Figure 99 Security Certificate 2 (Firefox)



### 14.4.5.3 Avoiding Browser Warning Messages

Here are the main reasons your browser displays warnings about the NWA/WAC's HTTPS server certificate and what you can do to avoid seeing the warnings:

- The issuing certificate authority of the NWA/WAC's HTTPS server certificate is not one of the browser's trusted certificate authorities. The issuing certificate authority of the NWA/WAC's factory default certificate is the NWA/WAC itself since the certificate is a self-signed certificate.

- For the browser to trust a self-signed certificate, import the self-signed certificate into your operating system as a trusted certificate.
- To have the browser trust the certificates issued by a certificate authority, import the certificate authority's certificate into your operating system as a trusted certificate. Refer to [Appendix A on page 214](#) for details.

#### 14.4.5.4 Enrolling and Importing SSL Client Certificates

The SSL client needs a certificate if **Authenticate Client Certificates** is selected on the NWA/WAC.

You must have imported at least one trusted CA to the NWA/WAC in order for the **Authenticate Client Certificates** to be active (see the Certificates chapter for details).

Apply for a certificate from a Certification Authority (CA) that is trusted by the NWA/WAC (see the NWA/WAC's **Trusted Certificates** Web Configurator screen).

**Figure 100** Trusted Certificates

The screenshot displays the 'Trusted Certificates' configuration page. At the top, there are tabs for 'My Certificates' and 'Trusted Certificates'. Below the tabs, a progress bar indicates 'PKI Storage Space in Use' at 7.375%. The main section is titled 'Trusted Certificates Setting' and contains a table with the following data:

#	Name	Subject	Issuer	Valid From	Valid To
1	ZyXEL-Root...	C=TW, O=Zyxel, OU=V...	C=TW, O=Zyxel, OU=V...	2013-03-13 03:13:31 G...	2014-03-13 03:13:31 G...

Below the table, there are navigation controls: 'Page 1 of 1', 'Show 50 items', and 'Displaying 1 - 1 of 1'. At the bottom of the page, there are 'Import' and 'Refresh' buttons.

The CA sends you a package containing the CA's trusted certificate(s), your personal certificate(s) and a password to install the personal certificate(s).

### 14.4.5.5 Installing the CA's Certificate

- 1 Double click the CA's trusted certificate to produce a screen similar to the one shown next.



- 2 Click **Install Certificate** and follow the wizard as shown.

### 14.4.5.6 Installing a Personal Certificate

You need a password in advance. The CA may issue the password or you may have to specify it during the enrollment. Double-click the personal certificate given to you by the CA to produce a screen similar to the one shown next.

- 1 Click **Next** to begin the wizard.



- 2 The file name and path of the certificate you double-clicked should automatically appear in the **File name** text box. Click **Browse** if you wish to import a different certificate.



- 3 Enter the password given to you by the CA.

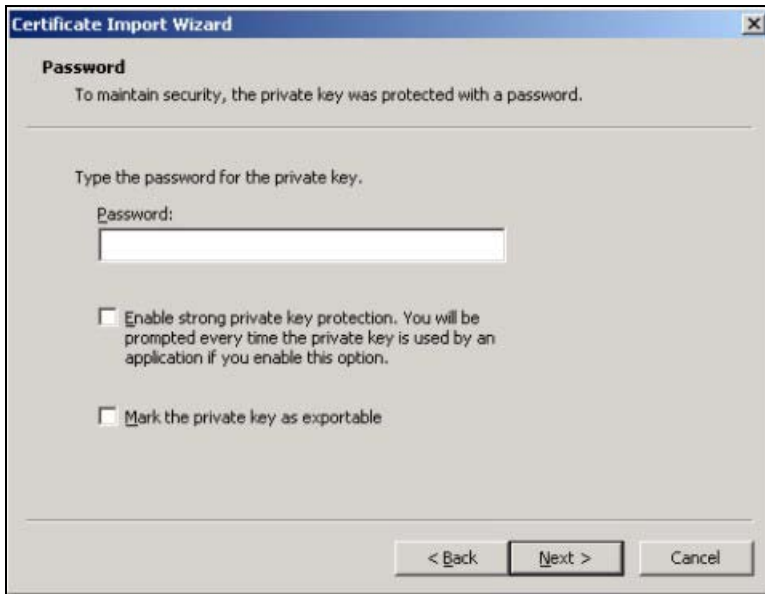

- 4 Have the wizard determine where the certificate should be saved on your computer or select **Place all certificates in the following store** and choose a different location.

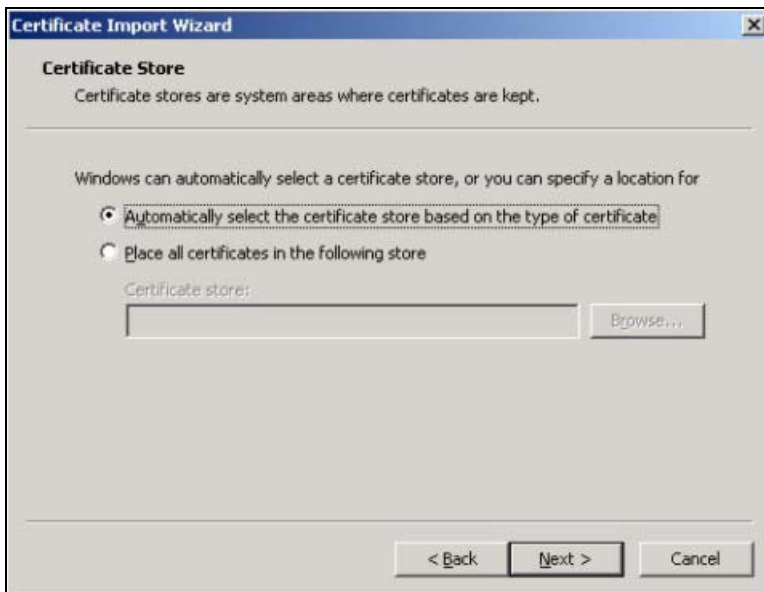

- 5 Click **Finish** to complete the wizard and begin the import process.



- 6 You should see the following screen when the certificate is correctly installed on your computer.



#### 14.4.5.7 Using a Certificate When Accessing the NWA/WAC

To access the NWA/WAC via HTTPS:

- 1 Enter 'https://NWA/WAC IP Address/' in your browser's web address field.

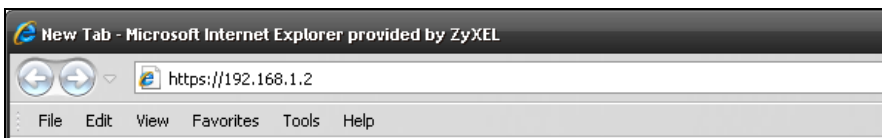

- 2 When **Authenticate Client Certificates** is selected on the NWA/WAC, the following screen asks you to select a personal certificate to send to the NWA/WAC. This screen displays even if you only have a single certificate as in the example.

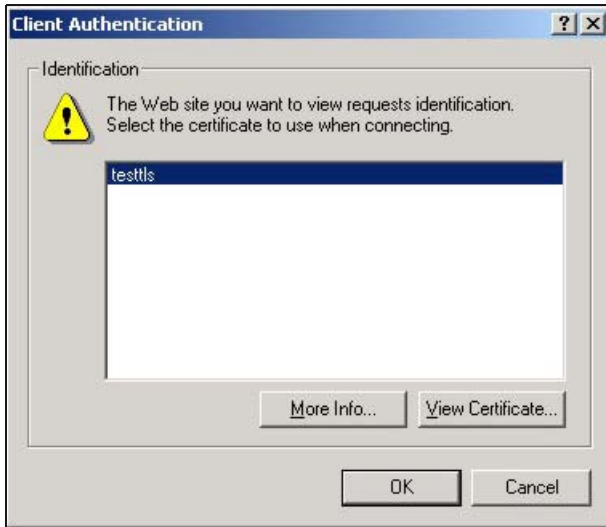

- 3 You next see the Web Configurator login screen.

## 14.5 SSH

You can use SSH (Secure SHell) to securely access the NWA/WAC's command line interface.

SSH is a secure communication protocol that combines authentication and data encryption to provide secure encrypted communication between two hosts over an unsecured network. In the following figure, computer B on the Internet uses SSH to securely connect to the NWA/WAC (A) for a management session.

**Figure 101** SSH Communication Over the WAN Example



### 14.5.1 How SSH Works

The following figure is an example of how a secure connection is established between two remote hosts using SSH v1.

Figure 102 How SSH v1 Works Example

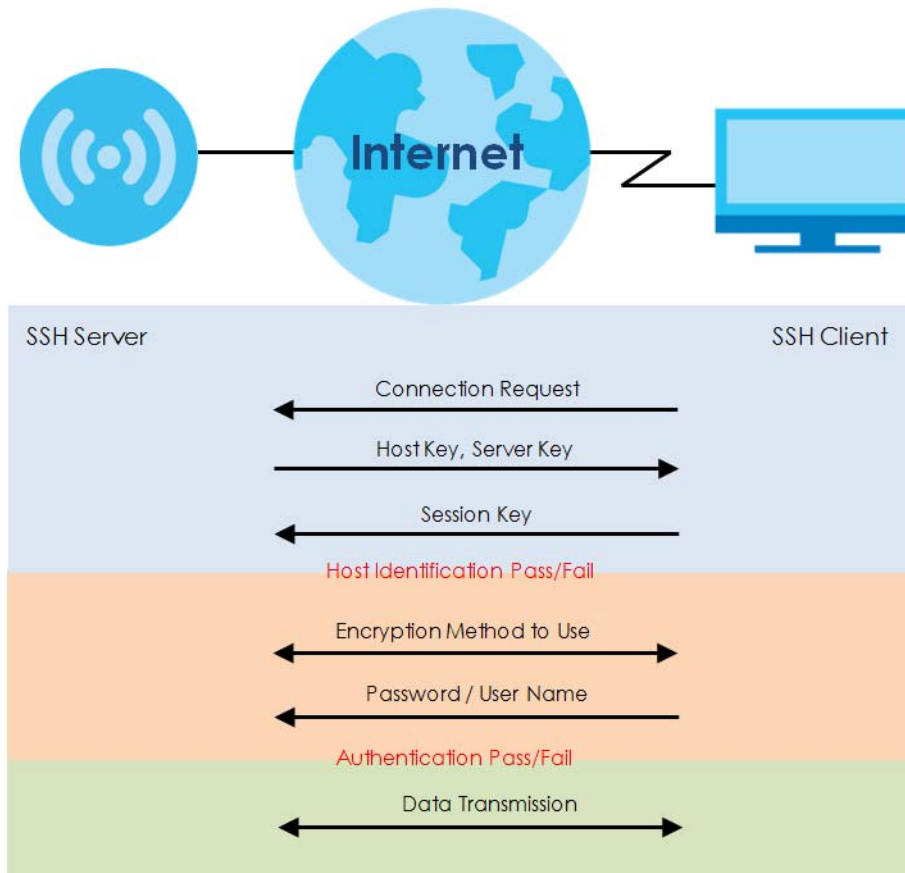

### 1 Host Identification

The SSH client sends a connection request to the SSH server. The server identifies itself with a host key. The client encrypts a randomly generated session key with the host key and server key and sends the result back to the server.

The client automatically saves any new server public keys. In subsequent connections, the server public key is checked against the saved version on the client computer.

### 2 Encryption Method

Once the identification is verified, both the client and server must agree on the type of encryption method to use.

### 3 Authentication and Data Transmission

After the identification is verified and data encryption activated, a secure tunnel is established between the client and the server. The client then sends its authentication information (user name and password) to the server to log in to the server.

## 14.5.2 SSH Implementation on the NWA/WAC

Your NWA/WAC supports SSH versions 1 and 2 using RSA authentication and four encryption methods (AES, 3DES, Archfour, and Blowfish). The SSH server is implemented on the NWA/WAC for management using port 22 (by default).



### 14.5.3 Requirements for Using SSH

You must install an SSH client program on a client computer (Windows or Linux operating system) that is used to connect to the NWA/WAC over SSH.

### 14.5.4 Configuring SSH

Click **Configuration > System > SSH** to open the following screen. Use this screen to configure your NWA/WAC's Secure Shell settings.

Note: It is recommended that you disable Telnet and FTP when you configure SSH for secure connections.

**Figure 103** Configuration > System > SSH

The following table describes the labels in this screen.

**Table 74** Configuration > System > SSH

LABEL	DESCRIPTION
Enable	Select the check box to allow or disallow the computer with the IP address that matches the IP address(es) in the <b>Service Control</b> table to access the NWA/WAC CLI using this service.
Version 1	Select the check box to have the NWA/WAC use both SSH version 1 and version 2 protocols. If you clear the check box, the NWA/WAC uses only SSH version 2 protocol.
Server Port	You may change the server port number for a service if needed, however you must use the same port number in order to use that service for remote management.
Server Certificate	Select the certificate whose corresponding private key is to be used to identify the NWA/WAC for SSH connections. You must have certificates already configured in the <b>My Certificates</b> screen.
Apply	Click <b>Apply</b> to save your changes back to the NWA/WAC.
Reset	Click <b>Reset</b> to return the screen to its last-saved settings.

### 14.5.5 Examples of Secure Telnet Using SSH

This section shows two examples using a command interface and a graphical interface SSH client program to remotely access the NWA/WAC. The configuration and connection steps are similar for most SSH client programs. Refer to your SSH client program user's guide.

#### 14.5.5.1 Example 1: Microsoft Windows

This section describes how to access the NWA/WAC using the Secure Shell Client program.

- 1 Launch the SSH client and specify the connection information (IP address, port number) for the NWA/WAC.
- 2 Configure the SSH client to accept connection using SSH version 1.
- 3 A window displays prompting you to store the host key in you computer. Click **Yes** to continue.

**Figure 104** SSH Example 1: Store Host Key



Enter the password to log in to the NWA/WAC. The CLI screen displays next.

### 14.5.5.2 Example 2: Linux

This section describes how to access the NWA/WAC using the OpenSSH client program that comes with most Linux distributions.

- 1 Test whether the SSH service is available on the NWA/WAC.
 

Enter "telnet 192.168.1.2 22" at a terminal prompt and press [ENTER]. The computer attempts to connect to port 22 on the NWA/WAC (using the default IP address of 192.168.1.2).

A message displays indicating the SSH protocol version supported by the NWA/WAC.

**Figure 105** SSH Example 2: Test

```
$ telnet 192.168.1.2 22
Trying 192.168.1.2...
Connected to 192.168.1.2.
Escape character is '^]'.
SSH-1.5-1.0.0
```

- 2 Enter "ssh -1 192.168.1.2". This command forces your computer to connect to the NWA/WAC using SSH version 1. If this is the first time you are connecting to the NWA/WAC using SSH, a message displays prompting you to save the host information of the NWA/WAC. Type "yes" and press [ENTER].

Then enter the password to log in to the NWA/WAC.

**Figure 106** SSH Example 2: Log in

```
$ ssh -1 192.168.1.2
The authenticity of host '192.168.1.2 (192.168.1.2)' can't be established.
RSA1 key fingerprint is 21:6c:07:25:7e:f4:75:80:ec:af:bd:d4:3d:80:53:d1.
Are you sure you want to continue connecting (yes/no)? yes
Warning: Permanently added '192.168.1.2' (RSA1) to the list of known hosts.
Administrator@192.168.1.2's password:
```

- 3 The CLI screen displays next.

## 14.6 Telnet

You can use Telnet to access the NWA/WAC's command line interface. Click **Configuration > System > TELNET** to configure your NWA/WAC for remote Telnet access. Use this screen to enable or disable Telnet and set the server port number.

**Figure 107** Configuration > System > TELNET

The following table describes the labels in this screen.

**Table 75** Configuration > System > TELNET

LABEL	DESCRIPTION
Enable	Select the check box to allow or disallow the computer with the IP address that matches the IP address(es) in the <b>Service Control</b> table to access the NWA/WAC CLI using this service.
Server Port	You may change the server port number for a service if needed, however you must use the same port number in order to use that service for remote management.
Apply	Click <b>Apply</b> to save your changes back to the NWA/WAC.
Reset	Click <b>Reset</b> to return the screen to its last-saved settings.

## 14.7 FTP

You can upload and download the NWA/WAC's firmware and configuration files using FTP. To use this feature, your computer must have an FTP client. See [Chapter 16 on page 185](#) for more information about firmware and configuration files.

To change your NWA/WAC's FTP settings, click **Configuration > System > FTP** tab. The screen appears as shown. Use this screen to specify FTP settings.

Figure 108 Configuration &gt; System &gt; FTP

The following table describes the labels in this screen.

Table 76 Configuration &gt; System &gt; FTP

LABEL	DESCRIPTION
Enable	Select the check box to allow or disallow the computer with the IP address that matches the IP address(es) in the <b>Service Control</b> table to access the NWA/WAC using this service.
TLS required	Select the check box to use FTP over TLS (Transport Layer Security) to encrypt communication. This implements TLS as a security mechanism to secure FTP clients and/or servers.
Server Port	You may change the server port number for a service if needed, however you must use the same port number in order to use that service for remote management.
Server Certificate	Select the certificate whose corresponding private key is to be used to identify the NWA/WAC for FTP connections. You must have certificates already configured in the <b>My Certificates</b> screen.
Apply	Click <b>Apply</b> to save your changes back to the NWA/WAC.
Reset	Click <b>Reset</b> to return the screen to its last-saved settings.

## 14.8 SNMP

Simple Network Management Protocol is a protocol used for exchanging management information between network devices. Your NWA/WAC supports SNMP agent functionality, which allows a manager station to manage and monitor the NWA/WAC through the network. The NWA/WAC supports SNMP version one (SNMPv1), version two (SNMPv2c), and version three (SNMPv3). The next figure illustrates an SNMP management operation.

Figure 109 SNMP Management Model

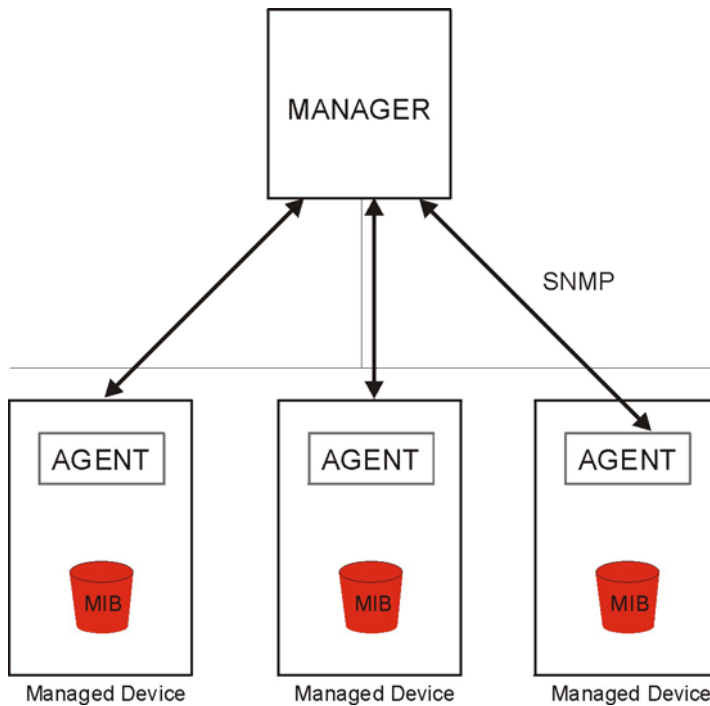

An SNMP managed network consists of two main types of component: agents and a manager.

An agent is a management software module that resides in a managed device (the NWA/WAC). An agent translates the local management information from the managed device into a form compatible with SNMP. The manager is the console through which network administrators perform network management functions. It executes applications that control and monitor managed devices.

The managed devices contain object variables/managed objects that define each piece of information to be collected about a device. Examples of variables include such as number of packets received, node port status etc. A Management Information Base (MIB) is a collection of managed objects. SNMP allows a manager and agents to communicate for the purpose of accessing these objects.

SNMP itself is a simple request/response protocol based on the manager/agent model. The manager issues a request and the agent returns responses using the following protocol operations:

- Get - Allows the manager to retrieve an object variable from the agent.
- GetNext - Allows the manager to retrieve the next object variable from a table or list within an agent. In SNMPv1, when a manager wants to retrieve all elements of a table from an agent, it initiates a Get operation, followed by a series of GetNext operations.
- Set - Allows the manager to set values for object variables within an agent.
- Trap - Used by the agent to inform the manager of some events.

### 14.8.1 Supported MIBs

The NWA/WAC supports MIB II that is defined in RFC-1213 and RFC-1215. The NWA/WAC also supports private MIBs (ZYXEL-ES-CAPWAP.MIB, ZYXEL-ES-COMMON.MIB, ZYXEL-ES-ZyXELAPMgmt.MIB, ZYXEL-ES-PROWLAN.MIB, ZYXEL-ES-RFMGMT.MIB, ZYXEL-ES-SMI.MIB, and ZYXEL-ES-WIRELESS.MIB) to collect information about CPU and memory usage and VPN total throughput. The focus of the MIBs is to let

administrators collect statistical data and monitor status and performance. You can download the NWA/WAC's MIBs from [www.zyxel.com](http://www.zyxel.com).

## 14.8.2 SNMP Traps

The NWA/WAC will send traps to the SNMP manager when any one of the following events occurs.

Table 77 SNMP Traps

OBJECT LABEL	OBJECT ID	DESCRIPTION
linkDown	1.3.6.1.6.3.1.1.5.3	This trap is sent when the Ethernet link is down.
linkUp	1.3.6.1.6.3.1.1.5.4	This trap is sent when the Ethernet link is up.
authenticationFailure	1.3.6.1.6.3.1.1.5.5	This trap is sent when an SNMP request comes from non-authenticated hosts.

## 14.8.3 Configuring SNMP

To change your NWA/WAC's SNMP settings, click **Configuration > System > SNMP** tab. The screen appears as shown. Use this screen to configure your SNMP settings. You can also configure user profiles that define allowed SNMPv3 access.

Figure 110 Configuration > System > SNMP

The following table describes the labels in this screen.

Table 78 Configuration > System > SNMP

LABEL	DESCRIPTION
Enable	Select the check box to allow or disallow users to access the NWA/WAC using SNMP.
Server Port	You may change the server port number for a service if needed, however you must use the same port number in order to use that service for remote management.
Trap	

Table 78 Configuration &gt; System &gt; SNMP (continued)

LABEL	DESCRIPTION
Community	Type the trap community, which is the password sent with each trap to the SNMP manager. The default is public and allows all requests.
Destination	Type the IP address of the station to send your SNMP traps to.
Trap Wireless Event	Select this to have the NWA/WAC send a trap to the SNMP manager when a wireless client is connected to or disconnected from the NWA/WAC.
SNMPv2c	Select this to allow SNMP managers using SNMPv2c to access the NWA/WAC.
Get Community	Enter the <b>Get Community</b> , which is the password for the incoming Get and GetNext requests from the management station. The default is public and allows all requests.
Set Community	Enter the <b>Set community</b> , which is the password for incoming Set requests from the management station. The default is private and allows all requests.
SNMPv3	Select this to allow SNMP managers using SNMPv3 to access the NWA/WAC.
Add	Click this to create a new entry. Select an entry and click <b>Add</b> to create a new entry after the selected entry.
Edit	Double-click an entry or select it and click <b>Edit</b> to be able to modify the entry's settings.
Remove	To remove an entry, select it and click <b>Remove</b> . The NWA/WAC confirms you want to remove it before doing so. Note that subsequent entries move up by one when you take this action.
#	This the index number of an SNMPv3 user profile.
User Name	This is the name of the user for which this SNMPv3 user profile is configured.
Authentication	This field displays the type of authentication the SNMPv3 user must use to connect to the NWA/WAC using this SNMPv3 user profile.
Privacy	This field displays the type of encryption the SNMPv3 user must use to connect to the NWA/WAC using this SNMPv3 user profile.
Privilege	This field displays whether the SNMPv3 user can have read-only or read and write access to the NWA/WAC using this SNMPv3 user profile.
Apply	Click <b>Apply</b> to save your changes back to the NWA/WAC.
Reset	Click <b>Reset</b> to return the screen to its last-saved settings.

## 14.8.4 Adding or Editing an SNMPv3 User Profile

This screen allows you to add or edit an SNMPv3 user profile. To access this screen, click the **Configuration > System > SNMP** screen's **Add** button or select a SNMPv3 user profile from the list and click the **Edit** button.

Figure 111 Configuration &gt; System &gt; SNMP &gt; Add

The screenshot shows a dialog box titled "Add SNMPv3 User". It contains the following fields:

- User Name : admin
- Authentication: MD5
- Privacy: NONE
- Privilege: Read-Write

Buttons: OK, Cancel

The following table describes the labels in this screen.

Table 79 Configuration > System > SNMP

LABEL	DESCRIPTION
User Name	Select the user name of the user account for which this SNMPv3 user profile is configured.
Authentication	Select the type of authentication the SNMPv3 user must use to connect to the NWA/WAC using this SNMPv3 user profile.  Select <b>MD5</b> to require the SNMPv3 user's password be encrypted by MD5 for authentication.  Select <b>SHA</b> to require the SNMPv3 user's password be encrypted by SHA for authentication.
Privacy	Select the type of encryption the SNMPv3 user must use to connect to the NWA/WAC using this SNMPv3 user profile.  Select <b>NONE</b> to not encrypt the SNMPv3 communications.  Select <b>DES</b> to use DES to encrypt the SNMPv3 communications.  Select <b>AES</b> to use AES to encrypt the SNMPv3 communications.
Privilege	Select whether the SNMPv3 user can have read-only or read and write access to the NWA/WAC using this SNMPv3 user profile.
OK	Click <b>OK</b> to save your changes back to the NWA/WAC.
Cancel	Click <b>Cancel</b> to exit this screen without saving your changes.



# CHAPTER 15

## Log and Report

### 15.1 Overview

Use the system screens to configure daily reporting and log settings.

#### 15.1.1 What You Can Do In this Chapter

- The **Email Daily Report** screen ([Section 15.2 on page 173](#)) configures how and where to send daily reports and what reports to send.
- The **Log Setting** screens ([Section 15.3 on page 175](#)) specify which logs are e-mailed, where they are e-mailed, and how often they are e-mailed.

### 15.2 Email Daily Report

Use this screen to start or stop data collection and view various statistics about traffic passing through your NWA/WAC.

Note: Data collection may decrease the NWA/WAC's traffic throughput rate.

Click **Configuration > Log & Report > Email Daily Report** to display the following screen. Configure this screen to have the NWA/WAC e-mail you system statistics every day.

Figure 112 Configuration &gt; Log &amp; Report &gt; Email Daily Report

Email Daily Report

---

**General Settings**

Enable Email Daily Report

---

**Email Settings**

Mail Server:  (Outgoing SMTP Server Name or IP Address)

SSL/TLS Encryption:  (v)

Mail Server Port:  (1-65535) (Optional)

Mail Subject:

Append system name

Append date time

Mail From:  (Email Address)

Mail To:  (Email Address)

(Email Address)

(Email Address)

(Email Address)

SMTP Authentication

User Name:

Password:

---

**Schedule**

Time for sending report:  (hours)  (minutes)

---

**Report Items**

System Resource Usage

CPU Usage

Memory Usage

Port Usage

Wireless Report

Station Count

TX/RX Statistics

Reset counters after sending report successfully

---

The following table describes the labels in this screen.

Table 80 Configuration &gt; Log &amp; Report &gt; Email Daily Report

LABEL	DESCRIPTION
Enable Email Daily Report	Select this to send reports by e-mail every day.
Mail Server	Type the name or IP address of the outgoing SMTP server.

Table 80 Configuration &gt; Log &amp; Report &gt; Email Daily Report (continued)

LABEL	DESCRIPTION
SSL/TLS Encryption	Select <b>SSL/TLS</b> to use Secure Sockets Layer (SSL) or Transport Layer Security (TLS) if you want encrypted communications between the mail server and the NWA/WAC.  Select <b>STARTTLS</b> to upgrade a plain text connection to a secure connection using SSL/TLS.  Select <b>No</b> to not encrypt the communications.
Mail Server Port	Enter the same port number here as is on the mail server for mail traffic.
Mail Subject	Type the subject line for the outgoing e-mail. Select <b>Append system name</b> to add the NWA/WAC's system name to the subject. Select <b>Append date time</b> to add the NWA/WAC's system date and time to the subject.
Mail From	Type the e-mail address from which the outgoing e-mail is delivered. This address is used in replies.
Mail To	Type the e-mail address (or addresses) to which the outgoing e-mail is delivered.
SMTP Authentication	Select this check box if it is necessary to provide a user name and password to the SMTP server.
User Name	This box is effective when you select the <b>SMTP Authentication</b> check box. Type the user name to provide to the SMTP server when the log is e-mailed.
Password	This box is effective when you select the <b>SMTP Authentication</b> check box. Type the password to provide to the SMTP server when the log is e-mailed.
Send Report Now	Click this button to have the NWA/WAC send the daily e-mail report immediately.
Time for sending report	Select the time of day (hours and minutes) when the log is e-mailed. Use 24-hour notation.
Report Items	Select the information to include in the report. Select <b>Reset counters after sending report successfully</b> if you only want to see statistics for a 24 hour period.
Reset All Counters	Click this to discard all report data and start all of the counters over at zero.
Apply	Click <b>Apply</b> to save your changes back to the NWA/WAC.
Reset	Click <b>Reset</b> to return the screen to its last-saved settings.

## 15.3 Log Setting

These screens control log messages and alerts. A log message stores the information for viewing (for example, in the **Monitor > View Log** screen) or regular e-mailing later, and an alert is e-mailed immediately. Usually, alerts are used for events that require more serious attention, such as system errors and attacks.

The NWA/WAC provides a system log and supports e-mail profiles and remote syslog servers. The system log is available on the **View Log** screen, the e-mail profiles are used to mail log messages to the specified destinations, and the other four logs are stored on specified syslog servers.

The **Log Setting** tab also controls what information is saved in each log. For the system log, you can also specify which log messages are e-mailed, where they are e-mailed, and how often they are e-mailed.

For alerts, the **Log Setting** screen controls which events generate alerts and where alerts are e-mailed.

The **Log Setting** screen provides a summary of all the settings. You can use the **Edit Log Setting** screen to maintain the detailed settings (such as log categories, e-mail addresses, server names, etc.) for any log.

Alternatively, if you want to edit what events is included in each log, you can also use the **Active Log Summary** screen to edit this information for all logs at the same time.

### 15.3.1 Log Setting Screen

To access this screen, click **Configuration > Log & Report > Log Setting**.

**Figure 113** Configuration > Log & Report > Log Setting

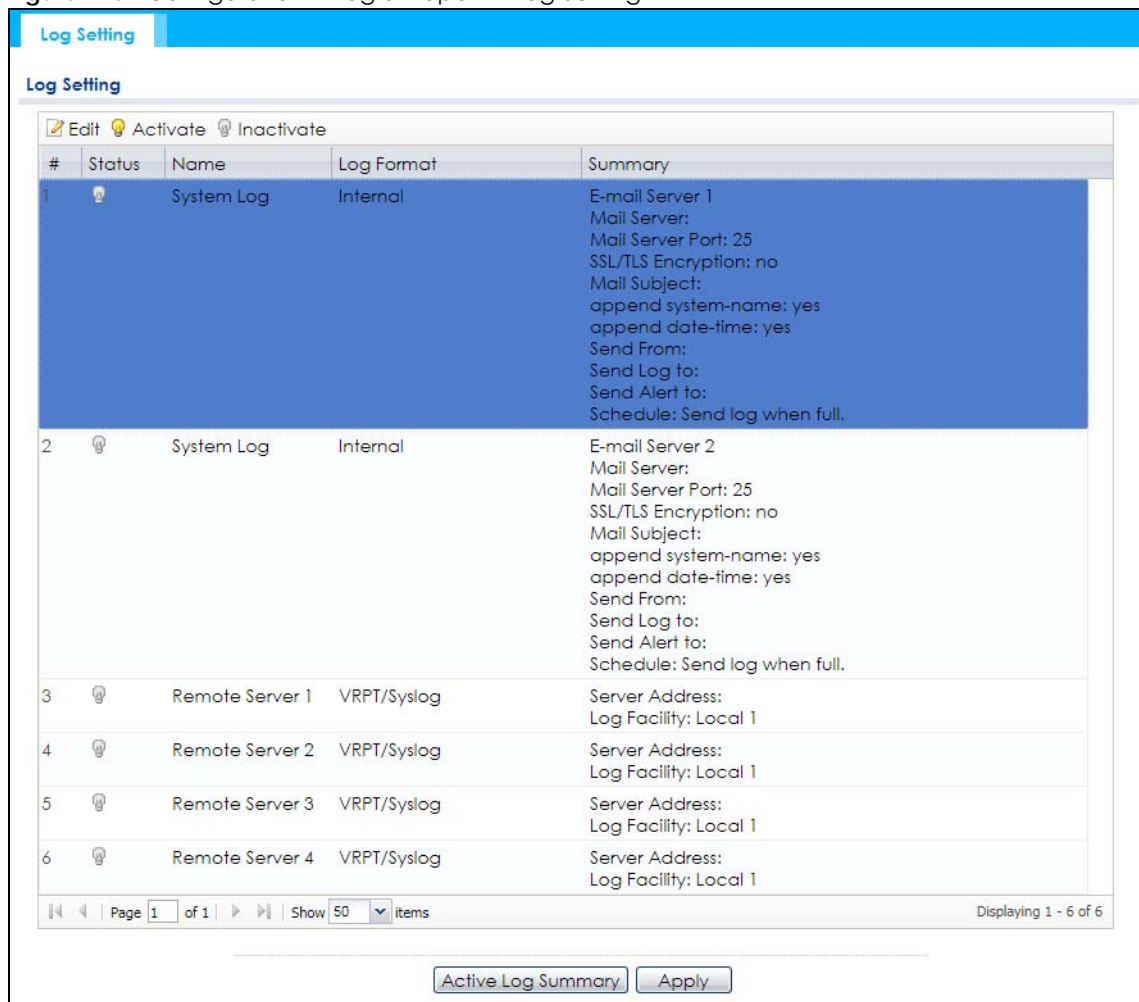

The following table describes the labels in this screen.

**Table 81** Configuration > Log & Report > Log Setting

LABEL	DESCRIPTION
Edit	Double-click an entry or select it and click <b>Edit</b> to open a screen where you can modify the entry's settings.
Activate	To turn on an entry, select it and click <b>Activate</b> .
Inactivate	To turn off an entry, select it and click <b>Inactivate</b> .
#	This field is a sequential value, and it is not associated with a specific log.
Status	This field shows whether the log is active or not.
Name	This field displays the name of the log (system log or one of the remote servers).

Table 81 Configuration &gt; Log &amp; Report &gt; Log Setting (continued)

LABEL	DESCRIPTION
Log Format	<p>This field displays the format of the log.</p> <p><b>Internal</b> - system log; you can view the log on the <b>View Log</b> tab.</p> <p><b>VRPT/Syslog</b> - Zyxel's Vantage Report, syslog-compatible format.</p> <p><b>CEF/Syslog</b> - Common Event Format, syslog-compatible format.</p>
Summary	This field is a summary of the settings for each log.
Active Log Summary	Click this button to open the <b>Active Log Summary</b> screen.
Apply	Click this button to save your changes (activate and deactivate logs) and make them take effect.

### 15.3.2 Edit System Log Settings

This screen controls the detailed settings for each log in the system log (which includes the e-mail profiles). Select a system log entry in the **Log Setting** screen and click the **Edit** icon.

Figure 114 Configuration > Log & Report > Log Setting > Edit System Log Setting

**Edit Log Setting**

**E-mail Server 1**

Active

Mail Server:  (Outgoing SMTP Server Name or IP Address)

SSL/TLS Encryption:  (v)

Mail Server Port:  (1-65535) (Optional)

Mail Subject:

Append system name

Append date time

Send From:  (E-Mail Address)

Send Log to:  (E-Mail Address)

Send Alerts to:  (E-Mail Address)

Sending Log:  (v)

Day for Sending Log:  (v)

Time for Sending Log:  (v)

SMTP Authentication

User Name:

Password:

**E-mail Server 2**

Active

Mail Server:  (Outgoing SMTP Server Name or IP Address)

**Active Log and Alert**

System Log\* E-mail Server 1\* E-mail Server 2\*

#	Log Category	System Log	E-mail Server 1	E-mail Server 2
1	Account	<input type="radio"/> <input checked="" type="radio"/> <input type="radio"/>	<input checked="" type="checkbox"/> <input type="checkbox"/>	<input checked="" type="checkbox"/> <input type="checkbox"/>
2	Bluetooth	<input type="radio"/> <input checked="" type="radio"/> <input type="radio"/>	<input checked="" type="checkbox"/> <input type="checkbox"/>	<input checked="" type="checkbox"/> <input type="checkbox"/>
3	Built-in Service	<input type="radio"/> <input checked="" type="radio"/> <input type="radio"/>	<input checked="" type="checkbox"/> <input type="checkbox"/>	<input checked="" type="checkbox"/> <input type="checkbox"/>
4	Connectivity Check	<input type="radio"/> <input checked="" type="radio"/> <input type="radio"/>	<input checked="" type="checkbox"/> <input type="checkbox"/>	<input checked="" type="checkbox"/> <input type="checkbox"/>
5	Daily Report	<input type="radio"/> <input checked="" type="radio"/> <input type="radio"/>	<input checked="" type="checkbox"/> <input type="checkbox"/>	<input checked="" type="checkbox"/> <input type="checkbox"/>
6	Default	<input type="radio"/> <input checked="" type="radio"/> <input type="radio"/>	<input checked="" type="checkbox"/> <input type="checkbox"/>	<input checked="" type="checkbox"/> <input type="checkbox"/>
7	Device HA	<input type="radio"/> <input checked="" type="radio"/> <input type="radio"/>	<input checked="" type="checkbox"/> <input type="checkbox"/>	<input checked="" type="checkbox"/> <input type="checkbox"/>
8	Dynamic Frequency ...	<input type="radio"/> <input checked="" type="radio"/> <input type="radio"/>	<input checked="" type="checkbox"/> <input type="checkbox"/>	<input checked="" type="checkbox"/> <input type="checkbox"/>
9	DHCP	<input type="radio"/> <input checked="" type="radio"/> <input type="radio"/>	<input checked="" type="checkbox"/> <input type="checkbox"/>	<input checked="" type="checkbox"/> <input type="checkbox"/>
10	File Manager	<input type="radio"/> <input checked="" type="radio"/> <input type="radio"/>	<input checked="" type="checkbox"/> <input type="checkbox"/>	<input checked="" type="checkbox"/> <input type="checkbox"/>
11	Force Authentication	<input type="radio"/> <input checked="" type="radio"/> <input type="radio"/>	<input checked="" type="checkbox"/> <input type="checkbox"/>	<input checked="" type="checkbox"/> <input type="checkbox"/>
12	Interface	<input type="radio"/> <input checked="" type="radio"/> <input type="radio"/>	<input checked="" type="checkbox"/> <input type="checkbox"/>	<input checked="" type="checkbox"/> <input type="checkbox"/>
13	PKI	<input type="radio"/> <input checked="" type="radio"/> <input type="radio"/>	<input checked="" type="checkbox"/> <input type="checkbox"/>	<input checked="" type="checkbox"/> <input type="checkbox"/>
14	System	<input type="radio"/> <input checked="" type="radio"/> <input type="radio"/>	<input checked="" type="checkbox"/> <input type="checkbox"/>	<input checked="" type="checkbox"/> <input type="checkbox"/>
15	User	<input type="radio"/> <input checked="" type="radio"/> <input type="radio"/>	<input checked="" type="checkbox"/> <input type="checkbox"/>	<input checked="" type="checkbox"/> <input type="checkbox"/>
16	Wireless LAN	<input type="radio"/> <input checked="" type="radio"/> <input type="radio"/>	<input checked="" type="checkbox"/> <input type="checkbox"/>	<input checked="" type="checkbox"/> <input type="checkbox"/>
17	WLAN Band Select	<input type="radio"/> <input checked="" type="radio"/> <input type="radio"/>	<input checked="" type="checkbox"/> <input type="checkbox"/>	<input checked="" type="checkbox"/> <input type="checkbox"/>
18	WLAN Dynamic Cha...	<input type="radio"/> <input checked="" type="radio"/> <input type="radio"/>	<input checked="" type="checkbox"/> <input type="checkbox"/>	<input checked="" type="checkbox"/> <input type="checkbox"/>
19	AP Load Balancing	<input type="radio"/> <input checked="" type="radio"/> <input type="radio"/>	<input checked="" type="checkbox"/> <input type="checkbox"/>	<input checked="" type="checkbox"/> <input type="checkbox"/>
20	WLAN Monitor Mode	<input type="radio"/> <input checked="" type="radio"/> <input type="radio"/>	<input checked="" type="checkbox"/> <input type="checkbox"/>	<input checked="" type="checkbox"/> <input type="checkbox"/>
21	WLAN Rogue AP Det...	<input type="radio"/> <input checked="" type="radio"/> <input type="radio"/>	<input checked="" type="checkbox"/> <input type="checkbox"/>	<input checked="" type="checkbox"/> <input type="checkbox"/>
22	Wlan Station Info	<input type="radio"/> <input checked="" type="radio"/> <input type="radio"/>	<input checked="" type="checkbox"/> <input type="checkbox"/>	<input checked="" type="checkbox"/> <input type="checkbox"/>
23	Zyxel One Network	<input type="radio"/> <input checked="" type="radio"/> <input type="radio"/>	<input checked="" type="checkbox"/> <input type="checkbox"/>	<input checked="" type="checkbox"/> <input type="checkbox"/>
24	ZyMesh	<input type="radio"/> <input checked="" type="radio"/> <input type="radio"/>	<input checked="" type="checkbox"/> <input type="checkbox"/>	<input checked="" type="checkbox"/> <input type="checkbox"/>
25	ZySH	<input type="radio"/> <input checked="" type="radio"/> <input type="radio"/>	<input checked="" type="checkbox"/> <input type="checkbox"/>	<input checked="" type="checkbox"/> <input type="checkbox"/>

Page 1 of 1 | Show 50 items | Displaying 1 - 25 of 25

**Log Consolidation**

Active

Log Consolidation Interval:  (10 - 600 seconds)

The following table describes the labels in this screen.

Table 82 Configuration > Log & Report > Log Setting > Edit System Log Setting

LABEL	DESCRIPTION
E-Mail Server 1/2	
Active	Select this to send log messages and alerts according to the information in this section. You specify what kinds of log messages are included in log information and what kinds of log messages are included in alerts in the <b>Active Log and Alert</b> section.
Mail Server	Type the name or IP address of the outgoing SMTP server.
SSL/TLS Encryption	Select <b>SSL/TLS</b> to use Secure Sockets Layer (SSL) or Transport Layer Security (TLS) if you want encrypted communications between the mail server and the NWA/WAC.  Select <b>STARTTLS</b> to upgrade a plain text connection to a secure connection using SSL/TLS.  Select <b>No</b> to not encrypt the communications.
Mail Server Port	Enter the same port number here as is on the mail server for mail traffic.
Mail Subject	Type the subject line for the outgoing e-mail. Select <b>Append system name</b> to add the NWA/WAC's system name to the subject. Select <b>Append date time</b> to add the NWA/WAC's system date and time to the subject.
Send From	Type the e-mail address from which the outgoing e-mail is delivered. This address is used in replies.
Send Log To	Type the e-mail address to which the outgoing e-mail is delivered.
Send Alerts To	Type the e-mail address to which alerts are delivered.
Sending Log	Select how often log information is e-mailed. Choices are: <b>When Full, Hourly and When Full, Daily and When Full</b> , and <b>Weekly and When Full</b> .
Day for Sending Log	This field is available if the log is e-mailed weekly. Select the day of the week the log is e-mailed.
Time for Sending Log	This field is available if the log is e-mailed weekly or daily. Select the time of day (hours and minutes) when the log is e-mailed. Use 24-hour notation.
SMTP Authentication	Select this check box if it is necessary to provide a user name and password to the SMTP server.
User Name	This box is effective when you select the <b>SMTP Authentication</b> check box. Type the user name to provide to the SMTP server when the log is e-mailed.
Password	This box is effective when you select the <b>SMTP Authentication</b> check box. Type the password to provide to the SMTP server when the log is e-mailed.
Active Log and Alert	
System log	Use the <b>System Log</b> drop-down list to change the log settings for all of the log categories.  <b>disable all logs</b> (red X) - do not log any information for any category for the system log or e-mail any logs to e-mail server 1 or 2.  <b>enable normal logs</b> (green check mark) - create log messages and alerts for all categories for the system log. If e-mail server 1 or 2 also has normal logs enabled, the NWA/WAC will e-mail logs to them.  <b>enable normal logs and debug logs</b> (yellow check mark) - create log messages, alerts, and debugging information for all categories. The NWA/WAC does not e-mail debugging information, even if this setting is selected.

Table 82 Configuration &gt; Log &amp; Report &gt; Log Setting &gt; Edit System Log Setting (continued)

LABEL	DESCRIPTION
E-mail Server 1	<p>Use the <b>E-Mail Server 1</b> drop-down list to change the settings for e-mailing logs to e-mail server 1 for all log categories.</p> <p>Using the <b>System Log</b> drop-down list to disable all logs overrides your e-mail server 1 settings.</p> <p><b>enable normal logs</b> (green check mark) - e-mail log messages for all categories to e-mail server 1.</p> <p><b>enable alert logs</b> (red exclamation point) - e-mail alerts for all categories to e-mail server 1.</p>
E-mail Server 2	<p>Use the <b>E-Mail Server 2</b> drop-down list to change the settings for e-mailing logs to e-mail server 2 for all log categories.</p> <p>Using the <b>System Log</b> drop-down list to disable all logs overrides your e-mail server 2 settings.</p> <p><b>enable normal logs</b> (green check mark) - e-mail log messages for all categories to e-mail server 2.</p> <p><b>enable alert logs</b> (red exclamation point) - e-mail alerts for all categories to e-mail server 2.</p>
#	This field is a sequential value, and it is not associated with a specific address.
Log Category	This field displays each category of messages. It is the same value used in the <b>Display</b> and <b>Category</b> fields in the <b>View Log</b> tab. The <b>Default</b> category includes debugging messages generated by open source software.
System log	<p>Select which events you want to log by <b>Log Category</b>. There are three choices:</p> <p><b>disable all logs</b> (red X) - do not log any information from this category</p> <p><b>enable normal logs</b> (green checkmark) - create log messages and alerts from this category</p> <p><b>enable normal logs and debug logs</b> (yellow check mark) - create log messages, alerts, and debugging information from this category; the NWA/WAC does not e-mail debugging information, however, even if this setting is selected.</p>
E-mail Server 1	Select whether each category of events should be included in the log messages when it is e-mailed (green check mark) and/or in alerts (red exclamation point) for the e-mail settings specified in <b>E-Mail Server 1</b> . The NWA/WAC does not e-mail debugging information, even if it is recorded in the <b>System log</b> .
E-mail Server 2	Select whether each category of events should be included in log messages when it is e-mailed (green check mark) and/or in alerts (red exclamation point) for the e-mail settings specified in <b>E-Mail Server 2</b> . The NWA/WAC does not e-mail debugging information, even if it is recorded in the <b>System log</b> .
Log Consolidation	
Active	Select this to activate log consolidation. Log consolidation aggregates multiple log messages that arrive within the specified <b>Log Consolidation Interval</b> . In the <b>View Log</b> tab, the text "[count=x]", where <i>x</i> is the number of original log messages, is appended at the end of the <b>Message</b> field, when multiple log messages were aggregated.
Log Consolidation Interval	Type how often, in seconds, to consolidate log information. If the same log message appears multiple times, it is aggregated into one log message with the text "[count=x]", where <i>x</i> is the number of original log messages, appended at the end of the <b>Message</b> field.
OK	Click this to save your changes and return to the previous screen.
Cancel	Click this to return to the previous screen without saving your changes.



### 15.3.3 Edit Remote Server

This screen controls the settings for each log in the remote server (syslog). Select a remote server entry in the **Log Setting** screen and click the **Edit** icon.

**Figure 115** Configuration > Log & Report > Log Setting > Edit Remote Server

**Log Settings for Remote Server**

Active

Log Format: VRPT/Syslog

Server Address: (Server Name or IP Address)

Log Facility: Local 1

**Active Log**

#	Log Category	Selection
1	Account	<input type="radio"/> <input type="radio"/> <input type="radio"/>
2	Bluetooth	<input type="radio"/> <input type="radio"/> <input type="radio"/>
3	Built-in Service	<input type="radio"/> <input type="radio"/> <input type="radio"/>
4	Connectivity Check	<input type="radio"/> <input type="radio"/> <input type="radio"/>
5	Daily Report	<input type="radio"/> <input type="radio"/> <input type="radio"/>
6	Default	<input type="radio"/> <input type="radio"/> <input type="radio"/>
7	Device HA	<input type="radio"/> <input type="radio"/> <input type="radio"/>
8	Dynamic Frequency Selection	<input type="radio"/> <input type="radio"/> <input type="radio"/>
9	DHCP	<input type="radio"/> <input type="radio"/> <input type="radio"/>
10	File Manager	<input type="radio"/> <input type="radio"/> <input type="radio"/>
11	Force Authentication	<input type="radio"/> <input type="radio"/> <input type="radio"/>
12	Interface	<input type="radio"/> <input type="radio"/> <input type="radio"/>
13	Interface Statistics	<input type="radio"/> <input type="radio"/> <input type="radio"/>
14	PKI	<input type="radio"/> <input type="radio"/> <input type="radio"/>
15	System	<input type="radio"/> <input type="radio"/> <input type="radio"/>
16	System Monitoring	<input type="radio"/> <input type="radio"/> <input type="radio"/>
17	Traffic Log	<input type="radio"/> <input type="radio"/> <input type="radio"/>
18	User	<input type="radio"/> <input type="radio"/> <input type="radio"/>
19	Wireless LAN	<input type="radio"/> <input type="radio"/> <input type="radio"/>
20	WLAN Band Select	<input type="radio"/> <input type="radio"/> <input type="radio"/>

Page 1 of 2 | Show 20 items | Displaying 1 - 20 of 28

OK Cancel

The following table describes the labels in this screen.

Table 83 Configuration > Log & Report > Log Setting > Edit Remote Server

LABEL	DESCRIPTION
Log Settings for Remote Server	
Active	Select this check box to send log information according to the information in this section. You specify what kinds of messages are included in log information in the <b>Active Log</b> section.
Log Format	This field displays the format of the log information. It is read-only. <b>VRPT/Syslog</b> - Zyxel's Vantage Report, syslog-compatible format. <b>CEF/Syslog</b> - Common Event Format, syslog-compatible format.
Server Address	Type the server name or the IP address of the syslog server to which to send log information.
Log Facility	Select a log facility. The log facility allows you to log the messages to different files in the syslog server. Please see the documentation for your syslog program for more information.
Active Log	
Selection	Use the <b>Selection</b> drop-down list to change the log settings for all of the log categories. <b>disable all logs</b> (red X) - do not send the remote server logs for any log category. <b>enable normal logs</b> (green check mark) - send the remote server log messages and alerts for all log categories. <b>enable normal logs and debug logs</b> (yellow check mark) - send the remote server log messages, alerts, and debugging information for all log categories.
#	This field is a sequential value, and it is not associated with a specific address.
Log Category	This field displays each category of messages. It is the same value used in the <b>Display</b> and <b>Category</b> fields in the <b>View Log</b> tab. The <b>Default</b> category includes debugging messages generated by open source software.
Selection	Select what information you want to log from each <b>Log Category</b> (except <b>All Logs</b> ; see below). Choices are: <b>disable all logs</b> (red X) - do not log any information from this category <b>enable normal logs</b> (green checkmark) - log regular information and alerts from this category <b>enable normal logs and debug logs</b> (yellow check mark) - log regular information, alerts, and debugging information from this category
OK	Click this to save your changes and return to the previous screen.
Cancel	Click this to return to the previous screen without saving your changes.

### 15.3.4 Active Log Summary

This screen allows you to view and to edit what information is included in the system log, e-mail profiles, and remote servers at the same time. It does not let you change other log settings (for example, where and how often log information is e-mailed or remote server names). To access this screen, go to the **Log Setting** screen, and click the **Active Log Summary** button.

Figure 116 Active Log Summary

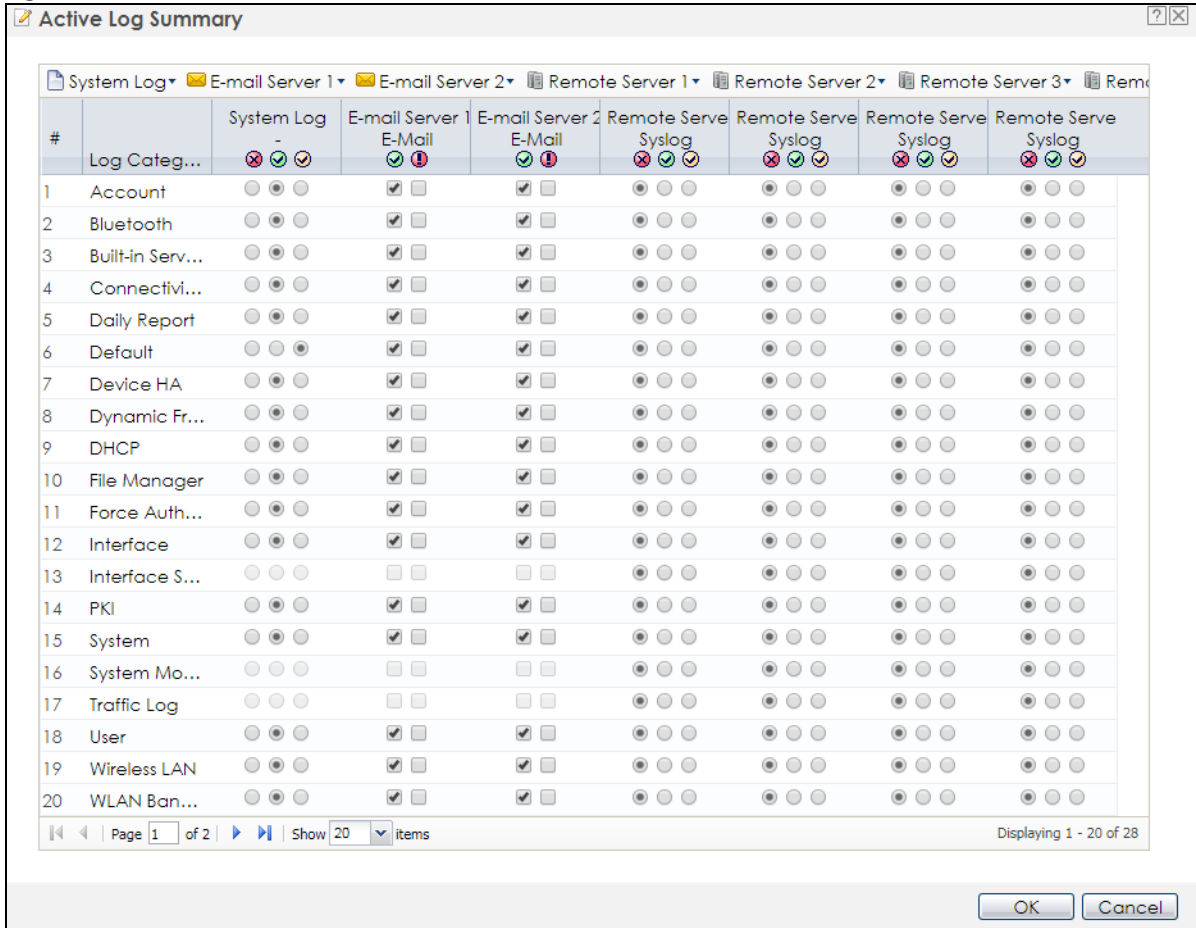

This screen provides a different view and a different way of indicating which messages are included in each log and each alert. (The **Default** category includes debugging messages generated by open source software.)

The following table describes the fields in this screen.

Table 84 Configuration > Log & Report > Log Setting > Active Log Summary

LABEL	DESCRIPTION
Active Log Summary	If the NWA/WAC is set to controller mode, the AC section controls logs generated by the controller and the AP section controls logs generated by the managed APs.
System log	Use the <b>System Log</b> drop-down list to change the log settings for all of the log categories.  <b>disable all logs</b> (red X) - do not log any information for any category for the system log or e-mail any logs to e-mail server 1 or 2.  <b>enable normal logs</b> (green check mark) - create log messages and alerts for all categories for the system log. If e-mail server 1 or 2 also has normal logs enabled, the NWA/WAC will e-mail logs to them.  <b>enable normal logs and debug logs</b> (yellow check mark) - create log messages, alerts, and debugging information for all categories. The NWA/WAC does not e-mail debugging information, even if this setting is selected.

Table 84 Configuration &gt; Log &amp; Report &gt; Log Setting &gt; Active Log Summary (continued)

LABEL	DESCRIPTION
E-mail Server 1	<p>Use the <b>E-Mail Server 1</b> drop-down list to change the settings for e-mailing logs to e-mail server 1 for all log categories.</p> <p>Using the <b>System Log</b> drop-down list to disable all logs overrides your e-mail server 1 settings.</p> <p><b>enable normal logs</b> (green check mark) - e-mail log messages for all categories to e-mail server 1.</p> <p><b>enable alert logs</b> (red exclamation point) - e-mail alerts for all categories to e-mail server 1.</p>
E-mail Server 2	<p>Use the <b>E-Mail Server 2</b> drop-down list to change the settings for e-mailing logs to e-mail server 2 for all log categories.</p> <p>Using the <b>System Log</b> drop-down list to disable all logs overrides your e-mail server 2 settings.</p> <p><b>enable normal logs</b> (green check mark) - e-mail log messages for all categories to e-mail server 2.</p> <p><b>enable alert logs</b> (red exclamation point) - e-mail alerts for all categories to e-mail server 2.</p>
Remote Server 1~4	<p>For each remote server, use the <b>Selection</b> drop-down list to change the log settings for all of the log categories.</p> <p><b>disable all logs</b> (red X) - do not send the remote server logs for any log category.</p> <p><b>enable normal logs</b> (green check mark) - send the remote server log messages and alerts for all log categories.</p> <p><b>enable normal logs and debug logs</b> (yellow check mark) - send the remote server log messages, alerts, and debugging information for all log categories.</p>
#	This field is a sequential value, and it is not associated with a specific address.
Log Category	This field displays each category of messages. It is the same value used in the <b>Display</b> and <b>Category</b> fields in the <b>View Log</b> tab. The <b>Default</b> category includes debugging messages generated by open source software.
System log	<p>Select which events you want to log by <b>Log Category</b>. There are three choices:</p> <p><b>disable all logs</b> (red X) - do not log any information from this category</p> <p><b>enable normal logs</b> (green checkmark) - create log messages and alerts from this category</p> <p><b>enable normal logs and debug logs</b> (yellow check mark) - create log messages, alerts, and debugging information from this category; the NWA/WAC does not e-mail debugging information, however, even if this setting is selected.</p>
E-mail Server 1 E-mail	Select whether each category of events should be included in the log messages when it is e-mailed (green check mark) and/or in alerts (red exclamation point) for the e-mail settings specified in <b>E-Mail Server 1</b> . The NWA/WAC does not e-mail debugging information, even if it is recorded in the <b>System log</b> .
E-mail Server 2 E-mail	Select whether each category of events should be included in log messages when it is e-mailed (green check mark) and/or in alerts (red exclamation point) for the e-mail settings specified in <b>E-Mail Server 2</b> . The NWA/WAC does not e-mail debugging information, even if it is recorded in the <b>System log</b> .
Remote Server 1~4 Syslog	<p>For each remote server, select what information you want to log from each <b>Log Category</b> (except <b>All Logs</b>; see below). Choices are:</p> <p><b>disable all logs</b> (red X) - do not log any information from this category</p> <p><b>enable normal logs</b> (green checkmark) - log regular information and alerts from this category</p> <p><b>enable normal logs and debug logs</b> (yellow check mark) - log regular information, alerts, and debugging information from this category</p>
OK	Click this to save your changes and return to the previous screen.
Cancel	Click this to return to the previous screen without saving your changes.

# CHAPTER 16

## File Manager

### 16.1 Overview

Configuration files define the NWA/WAC's settings. Shell scripts are files of commands that you can store on the NWA/WAC and run when you need them. You can apply a configuration file or run a shell script without the NWA/WAC restarting. You can store multiple configuration files and shell script files on the NWA/WAC. You can edit configuration files or shell scripts in a text editor and upload them to the NWA/WAC. Configuration files use a .conf extension and shell scripts use a .zysh extension.

#### 16.1.1 What You Can Do in this Chapter

- The **Configuration File** screen ([Section 16.2 on page 186](#)) stores and names configuration files. You can also download and upload configuration files.
- The **Firmware Package** screen ([Section 16.3 on page 191](#)) checks your current firmware version and uploads firmware to the NWA/WAC.
- The **Shell Script** screen ([Section 16.4 on page 193](#)) stores, names, downloads, uploads and runs shell script files.

#### 16.1.2 What you Need to Know

The following terms and concepts may help as you read this chapter.

##### Configuration Files and Shell Scripts

When you apply a configuration file, the NWA/WAC uses the factory default settings for any features that the configuration file does not include. When you run a shell script, the NWA/WAC only applies the commands that it contains. Other settings do not change.

These files have the same syntax, which is also identical to the way you run CLI commands manually. An example is shown below.

**Figure 117** Configuration File / Shell Script: Example

```
# enter configuration mode
configure terminal
# change administrator password
username admin password 4321 user-type admin
#configure default radio profile, change 2GHz channel to 11 & Tx output
power # to 50%
wlan-radio-profile default
2g-channel 11
output-power 50%
exit
write
```

While configuration files and shell scripts have the same syntax, the NWA/WAC applies configuration files differently than it runs shell scripts. This is explained below.

Table 85 Configuration Files and Shell Scripts in the NWA/WAC

Configuration Files (.conf)	Shell Scripts (.zysh)
<ul style="list-style-type: none"> <li>Resets to default configuration.</li> <li>Goes into CLI <b>Configuration</b> mode.</li> <li>Runs the commands in the configuration file.</li> </ul>	<ul style="list-style-type: none"> <li>Goes into CLI <b>Privilege</b> mode.</li> <li>Runs the commands in the shell script.</li> </ul>

You have to run the aforementioned example as a shell script because the first command is run in **Privilege** mode. If you remove the first command, you have to run the example as a configuration file because the rest of the commands are executed in **Configuration** mode.

## Comments in Configuration Files or Shell Scripts

In a configuration file or shell script, use “#” or “!” as the first character of a command line to have the NWA/WAC treat the line as a comment.

Your configuration files or shell scripts can use “exit” or a command line consisting of a single “!” to have the NWA/WAC exit sub command mode.

Note: “exit” or “!” must follow sub commands if it is to make the NWA/WAC exit sub command mode.

In the following example lines 1 and 2 are comments. Line 7 exits sub command mode.

```
! this is from Joe
# on 2010/12/05
wlan-ssid-profile default
ssid Joe-AP
qos wmm
security default
!
```

## Errors in Configuration Files or Shell Scripts

When you apply a configuration file or run a shell script, the NWA/WAC processes the file line-by-line. The NWA/WAC checks the first line and applies the line if no errors are detected. Then it continues with the next line. If the NWA/WAC finds an error, it stops applying the configuration file or shell script and generates a log.

You can change the way a configuration file or shell script is applied. Include `setenv stop-on-error off` in the configuration file or shell script. The NWA/WAC ignores any errors in the configuration file or shell script and applies all of the valid commands. The NWA/WAC still generates a log for any errors.

## 16.2 Configuration File

Click **Maintenance > File Manager > Configuration File** to open this screen. Use the **Configuration File** screen to store, run, and name configuration files. You can also download configuration files from the NWA/WAC to your computer and upload configuration files from your computer to the NWA/WAC.

Once your NWA/WAC is configured and functioning properly, it is highly recommended that you back up your configuration file before making further configuration changes. The backup configuration file will be useful in case you need to return to your previous settings.

## Configuration File Flow at Restart

- If there is not a **startup-config.conf** when you restart the NWA/WAC (whether through a management interface or by physically turning the power off and back on), the NWA/WAC uses the **system-default.conf** configuration file with the NWA/WAC's default settings.
- If there is a **startup-config.conf**, the NWA/WAC checks it for errors and applies it. If there are no errors, the NWA/WAC uses it and copies it to the **lastgood.conf** configuration file as a back up file. If there is an error, the NWA/WAC generates a log and copies the **startup-config.conf** configuration file to the **startup-config-bad.conf** configuration file and tries the existing **lastgood.conf** configuration file. If there isn't a **lastgood.conf** configuration file or it also has an error, the NWA/WAC applies the **system-default.conf** configuration file.
- You can change the way the **startup-config.conf** file is applied. Include the `setenv-startup stop-on-error off` command. The NWA/WAC ignores any errors in the **startup-config.conf** file and applies all of the valid commands. The NWA/WAC still generates a log for any errors.

**Figure 118** Maintenance > File Manager > Configuration File

The screenshot shows the 'Configuration File' tab in the File Manager. It displays a table of configuration files with columns for '#', 'File Name', 'Size', and 'Last Modified'. Below the table is an 'Upload Configuration File' section with a text input for 'File Path' and 'Browse...' and 'Upload' buttons.

#	File Name	Size	Last Modified
1	autobackup-5.00.conf	3078	2017-03-01 15:02:24
2	autobackup-5.01.conf	5600	2017-03-03 15:00:23
3	startup-config.conf	5720	2017-07-04 18:49:43
4	autobackup-5.10.conf	5721	2017-06-30 10:29:24
5	system-default.conf	3591	1970-01-01 08:00:10
6	autobackup-4.21.conf	3335	2017-03-01 14:18:42
7	oldfwid	5	2017-07-03 00:33:03
8	lastgood.conf	5693	2017-07-03 00:34:28
9	startup-config-bad.conf	3078	2017-03-01 15:02:37

Page 1 of 1 | Show 50 items | Displaying 1 - 9 of 9

Upload Configuration File

To upload a configuration file, browse to the location of the file (.conf) and then click Upload.

File Path:

**Do not turn off the NWA/WAC while configuration file upload is in progress.**

The following table describes the labels in this screen.

Table 86 Maintenance &gt; File Manager &gt; Configuration File



LABEL	DESCRIPTION
Rename	<p>Use this button to change the label of a configuration file on the NWA/WAC. You can only rename manually saved configuration files. You cannot rename the <b>lastgood.conf</b>, <b>system-default.conf</b> and <b>startup-config.conf</b> files.</p> <p>You cannot rename a configuration file to the name of another configuration file in the NWA/WAC.</p> <p>Click a configuration file's row to select it and click <b>Rename</b> to open the <b>Rename File</b> screen.</p>  <p>Specify the new name for the configuration file. Use up to 25 characters (including a-zA-Z0-9;~!@#%&amp;^&amp;()_+[]{}',.-).</p> <p>Click <b>OK</b> to save the duplicate or click <b>Cancel</b> to close the screen without saving a duplicate of the configuration file.</p>
Remove	<p>Click a configuration file's row to select it and click <b>Remove</b> to delete it from the NWA/WAC. You can only delete manually saved configuration files. You cannot delete the <b>system-default.conf</b>, <b>startup-config.conf</b> and <b>lastgood.conf</b> files.</p> <p>A pop-up window asks you to confirm that you want to delete the configuration file. Click <b>OK</b> to delete the configuration file or click <b>Cancel</b> to close the screen without deleting the configuration file.</p>
Download	<p>Click a configuration file's row to select it and click <b>Download</b> to save the configuration to your computer.</p>
Copy	<p>Use this button to save a duplicate of a configuration file on the NWA/WAC.</p> <p>Click a configuration file's row to select it and click <b>Copy</b> to open the <b>Copy File</b> screen.</p>  <p>Specify a name for the duplicate configuration file. Use up to 25 characters (including a-zA-Z0-9;~!@#%&amp;^&amp;()_+[]{}',.-).</p> <p>Click <b>OK</b> to save the duplicate or click <b>Cancel</b> to close the screen without saving a duplicate of the configuration file.</p>



Table 86 Maintenance &gt; File Manager &gt; Configuration File (continued)

LABEL	DESCRIPTION
Apply	<p>Use this button to have the NWA/WAC use a specific configuration file.</p> <p>Click a configuration file's row to select it and click <b>Apply</b> to have the NWA/WAC use that configuration file. The NWA/WAC does not have to restart in order to use a different configuration file, although you will need to wait for a few minutes while the system reconfigures.</p> <p>The following screen gives you options for what the NWA/WAC is to do if it encounters an error in the configuration file.</p>  <p><b>Immediately stop applying the configuration file</b> - this is not recommended because it would leave the rest of the configuration blank. If the interfaces were not configured before the first error, the console port may be the only way to access the device.</p> <p><b>Immediately stop applying the configuration file and roll back to the previous configuration</b> - this gets the NWA/WAC started with a fully valid configuration file as quickly as possible.</p> <p><b>Ignore errors and finish applying the configuration file</b> - this applies the valid parts of the configuration file and generates error logs for all of the configuration file's errors. This lets the NWA/WAC apply most of your configuration and you can refer to the logs for what to fix.</p> <p><b>Ignore errors and finish applying the configuration file and then roll back to the previous configuration</b> - this applies the valid parts of the configuration file, generates error logs for all of the configuration file's errors, and starts the NWA/WAC with a fully valid configuration file.</p> <p>Click <b>OK</b> to have the NWA/WAC start applying the configuration file or click <b>Cancel</b> to close the screen</p>
#	<p>This column displays the number for each configuration file entry. This field is a sequential value, and it is not associated with a specific address. The total number of configuration files that you can save depends on the sizes of the configuration files and the available flash storage space.</p>
File Name	<p>This column displays the label that identifies a configuration file.</p> <p>You cannot delete the following configuration files or change their file names.</p> <p>The <b>system-default.conf</b> file contains the NWA/WAC's default settings. Select this file and click <b>Apply</b> to reset all of the NWA/WAC settings to the factory defaults. This configuration file is included when you upload a firmware package.</p> <p>The <b>startup-config.conf</b> file is the configuration file that the NWA/WAC is currently using. If you make and save changes during your management session, the changes are applied to this configuration file. The NWA/WAC applies configuration changes made in the Web Configurator to the configuration file when you click <b>Apply</b> or <b>OK</b>. It applies configuration changes made via commands when you use the <code>write</code> command.</p> <p>The <b>lastgood.conf</b> is the most recently used (valid) configuration file that was saved when the device last restarted. If you upload and apply a configuration file with an error, you can apply <code>lastgood.conf</code> to return to a valid configuration.</p>
Size	<p>This column displays the size (in KB) of a configuration file.</p>

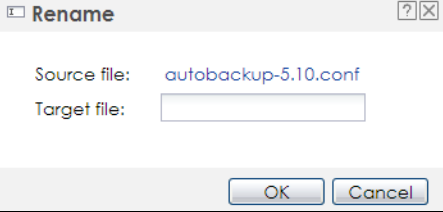
Table 86 Maintenance &gt; File Manager &gt; Configuration File (continued)

LABEL	DESCRIPTION
Last Modified	This column displays the date and time that the individual configuration files were last changed or saved.
Upload Configuration File	<p>The bottom part of the screen allows you to upload a new or previously saved configuration file from your computer to your NWA/WAC</p> <p>You cannot upload a configuration file named <b>system-default.conf</b> or <b>lastgood.conf</b>.</p> <p>If you upload <b>startup-config.conf</b>, it will replace the current configuration and immediately apply the new settings.</p>
File Path	Type in the location of the file you want to upload in this field or click <b>Browse...</b> to find it.
Browse...	Click <b>Browse...</b> to find the .conf file you want to upload. The configuration file must use a ".conf" filename extension. You will receive an error message if you try to upload a file of a different format. Remember that you must decompress compressed (.zip) files before you can upload them.
Upload	Click <b>Upload</b> to begin the upload process. This process may take up to two minutes.

## 16.2.1 Example of Configuration File Download Using FTP

The following example gets a configuration file named `startup-config.conf` from the NWA/WAC and saves it on the computer.

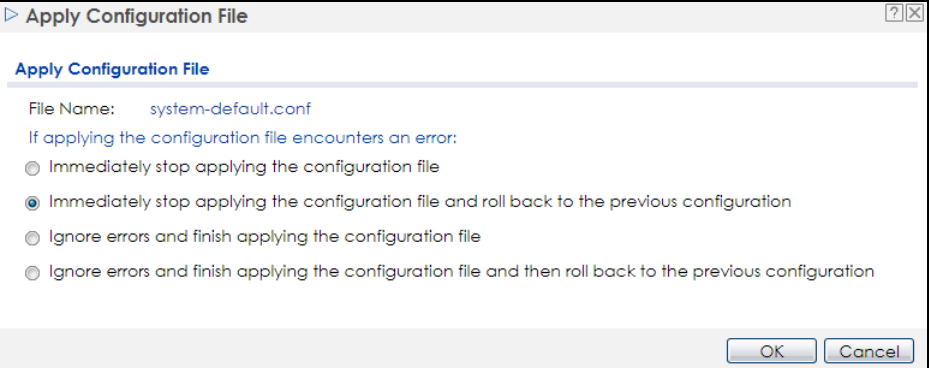
- 1 Connect your computer to the NWA/WAC.
- 2 The FTP server IP address of the NWA/WAC in standalone AP mode is 192.168.1.2, so set your computer to use a static IP address from 192.168.1.3 ~192.168.1.254.
- 3 Use an FTP client on your computer to connect to the NWA/WAC. For example, in the Windows command prompt, type `ftp 192.168.1.2`. Keep the console session connected in order to see when the firmware recovery finishes.
- 4 Enter your user name when prompted.
- 5 Enter your password as requested.
- 6 Use "cd" to change to the directory that contains the files you want to download.
- 7 Use "dir" or "ls" if you need to display a list of the files in the directory.
- 8 Use "get" to download files. Transfer the configuration file on the NWA/WAC to your computer. Type `get` followed by the name of the configuration file. This examples uses `get startup-config.conf`.

```
C:\>ftp 192.168.1.2
Connected to 192.168.1.2.
220----- Welcome to Pure-FTPd [privsep] [TLS] -----
220-You are user number 1 of 5 allowed.
220-Local time is now 21:28. Server port: 21.
220-This is a private system - No anonymous login
220 You will be disconnected after 600 minutes of inactivity.
User (192.168.1.2:(none)): admin
331 User admin OK. Password required
Password:
230 OK. Current restricted directory is /
ftp> cd conf
250 OK. Current directory is /conf
ftp> ls
200 PORT command successful
150 Connecting to port 5001
lastgood.conf
startup-config.conf
system-default.conf
226 3 matches total
ftp: 57 bytes received in 0.33Seconds 0.17Kbytes/sec.
ftp> get startup-config.conf
200 PORT command successful
150 Connecting to port 5002
226-File successfully transferred
226 0.002 seconds (measured here), 1.66 Mbytes per second
ftp: 2928 bytes received in 0.02Seconds 183.00Kbytes/sec.
ftp>
```

- 9 Wait for the file transfer to complete.
- 10 Enter "quit" to exit the ftp prompt.

## 16.3 Firmware Package

Click **Maintenance > File Manager > Firmware Package** to open this screen. Use the **Firmware Package** screen to check your current firmware version and upload firmware to the NWA/WAC.

Note: The Web Configurator is the recommended method for uploading firmware. You only need to use the command line interface if you need to recover the firmware. See the CLI Reference Guide for how to determine if you need to recover the firmware and how to recover it.

Find the firmware package at [www.zyxel.com](http://www.zyxel.com) in a file that (usually) uses a .bin extension.

**The firmware update can take up to five minutes. Do not turn off or reset the NWA/WAC while the firmware update is in progress!**

**Figure 119** Maintenance > File Manager > Firmware Package

Configuration File	Firmware Package	Shell Script
<b>Version</b>		
Boot Module:	V2.2	
Current Version:	V5.10(ABEL.0)b5	
Released Date:	2017-06-29 03:59:10	
<b>Upload File</b>		
To upload firmware package, browse to the location of the file and then click Upload.		
File Path:	<input type="text"/>	<input type="button" value="Browse..."/> <input type="button" value="Upload"/>

The following table describes the labels in this screen.

**Table 87** Maintenance > File Manager > Firmware Package

LABEL	DESCRIPTION
Boot Module	This is the version of the boot module that is currently on the NWA/WAC.
Current Version	This is the firmware version and the date created.
Released Date	This is the date that the version of the firmware was created.
File Path	Type in the location of the file you want to upload in this field or click <b>Browse...</b> to find it.
Browse...	Click <b>Browse...</b> to find the .bin file you want to upload. Remember that you must decompress compressed (.zip) files before you can upload them.
Upload	Click <b>Upload</b> to begin the upload process. This process may take up to two minutes.

After you see the **Firmware Upload in Process** screen, wait two minutes before logging into the NWA/WAC again.

Note: The NWA/WAC automatically reboots after a successful upload.

The NWA/WAC automatically restarts causing a temporary network disconnect. In some operating systems, you may see the following icon on your desktop.

**Figure 120** Network Temporarily Disconnected

After five minutes, log in again and check your new firmware version in the **Dashboard** screen.

### 16.3.1 Example of Firmware Upload Using FTP

This procedure requires the NWA/WAC's firmware. Download the firmware package from [www.zyxel.com](http://www.zyxel.com) and unzip it. The firmware file uses a .bin extension, for example, "510ABFH0C0.bin". Do the following after you have obtained the firmware file.

- 1 Connect your computer to the NWA/WAC.

- 2 The FTP server IP address of the NWA/WAC in standalone AP mode is 192.168.1.2, so set your computer to use a static IP address from 192.168.1.3 ~192.168.1.254.
- 3 Use an FTP client on your computer to connect to the NWA/WAC. For example, in the Windows command prompt, type `ftp 192.168.1.2`. Keep the console session connected in order to see when the firmware recovery finishes.
- 4 Enter your user name when prompted.
- 5 Enter your password as requested.
- 6 Enter "hash" for FTP to print a '#' character for every 1024 bytes of data you upload so that you can watch the file transfer progress.
- 7 Enter "bin" to set the transfer mode to binary.
- 8 Transfer the firmware file from your computer to the NWA/WAC. Type `put` followed by the path and name of the firmware file. This examples uses `put C:\ftproot\NWA/WAC_FW\510ABFH0C0.bin`.

```
C:\>ftp 192.168.1.2
Connected to 192.168.1.2.
220----- Welcome to Pure-FTPd [privsep] [TLS] -----
220-You are user number 1 of 5 allowed.
220-Local time is now 21:28. Server port: 21.
220-This is a private system - No anonymous login
220 You will be disconnected after 600 minutes of inactivity.
User (192.168.1.2:(none)): admin
331 User admin OK. Password required
Password:
230 OK. Current restricted directory is /
ftp> hash
Hash mark printing On ftp: (2048 bytes/hash mark) .
ftp> bin
200 TYPE is now 8-bit binary
ftp> put C:\ftproot\NWA/WAC_FW\510ABFH0C0.bin
```

- 9 Wait for the file transfer to complete.
- 10 Enter "quit" to exit the ftp prompt.

## 16.4 Shell Script

Use shell script files to have the NWA/WAC use commands that you specify. Use a text editor to create the shell script files. They must use a ".zysh" filename extension.

Click **Maintenance > File Manager > Shell Script** to open this screen. Use the **Shell Script** screen to store, name, download, upload and run shell script files. You can store multiple shell script files on the NWA/WAC at the same time.

Note: You should include `write` commands in your scripts. If you do not use the `write` command, the changes will be lost when the NWA/WAC restarts. You could use multiple `write` commands in a long script.

Figure 121 Maintenance &gt; File Manager &gt; Shell Script

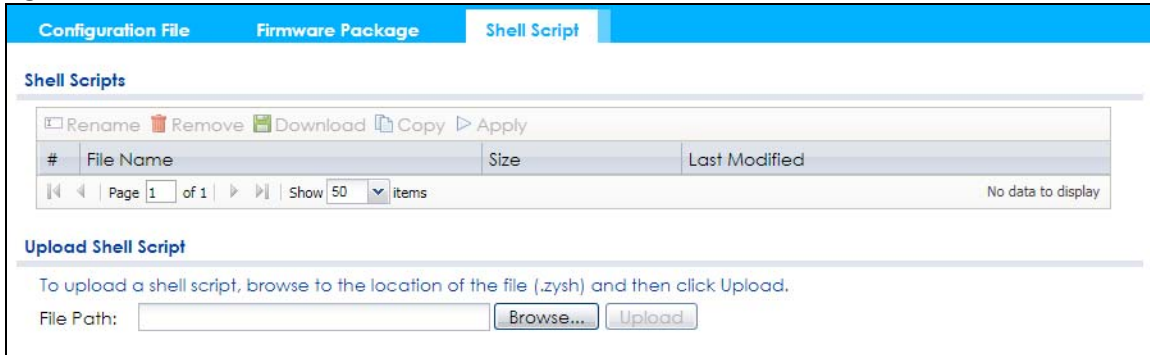

Each field is described in the following table.

Table 88 Maintenance &gt; File Manager &gt; Shell Script

LABEL	DESCRIPTION
Rename	<p>Use this button to change the label of a shell script file on the NWA/WAC.</p> <p>You cannot rename a shell script to the name of another shell script in the NWA/WAC.</p> <p>Click a shell script's row to select it and click <b>Rename</b> to open the <b>Rename File</b> screen.</p> <p>Specify the new name for the shell script file. Use up to 25 characters (including a-zA-Z0-9;~!@#\$\$%^&amp;()_+[]{}',.-).</p> <p>Click <b>OK</b> to save the duplicate or click <b>Cancel</b> to close the screen without saving a duplicate of the configuration file.</p>
Remove	<p>Click a shell script file's row to select it and click <b>Delete</b> to delete the shell script file from the NWA/WAC.</p> <p>A pop-up window asks you to confirm that you want to delete the shell script file. Click <b>OK</b> to delete the shell script file or click <b>Cancel</b> to close the screen without deleting the shell script file.</p>
Download	<p>Click a shell script file's row to select it and click <b>Download</b> to save the configuration to your computer.</p>
Copy	<p>Use this button to save a duplicate of a shell script file on the NWA/WAC.</p> <p>Click a shell script file's row to select it and click <b>Copy</b> to open the <b>Copy File</b> screen.</p> <p>Specify a name for the duplicate file. Use up to 25 characters (including a-zA-Z0-9;~!@#\$\$%^&amp;()_+[]{}',.-).</p> <p>Click <b>OK</b> to save the duplicate or click <b>Cancel</b> to close the screen without saving a duplicate of the configuration file.</p>
Apply	<p>Use this button to have the NWA/WAC use a specific shell script file.</p> <p>Click a shell script file's row to select it and click <b>Apply</b> to have the NWA/WAC use that shell script file. You may need to wait awhile for the NWA/WAC to finish applying the commands.</p>
#	This column displays the number for each shell script file entry.
File Name	This column displays the label that identifies a shell script file.
Size	This column displays the size (in KB) of a shell script file.
Last Modified	This column displays the date and time that the individual shell script files were last changed or saved.
Upload Shell Script	The bottom part of the screen allows you to upload a new or previously saved shell script file from your computer to your NWA/WAC.
File Path	Type in the location of the file you want to upload in this field or click <b>Browse...</b> to find it.

Table 88 Maintenance > File Manager > Shell Script (continued)

LABEL	DESCRIPTION
Browse...	Click <b>Browse...</b> to find the .zysh file you want to upload.
Upload	Click <b>Upload</b> to begin the upload process. This process may take up to several minutes.

# CHAPTER 17

## Diagnostics

### 17.1 Overview

Use the diagnostics screen for troubleshooting.

#### 17.1.1 What You Can Do in this Chapter

- The **Diagnostics** screen ([Section 17.2 on page 196](#)) generates a file containing the NWA/WAC's configuration and diagnostic information if you need to provide it to customer support during troubleshooting.

### 17.2 Diagnostics

This screen provides an easy way for you to generate a file containing the NWA/WAC's configuration and diagnostic information. You may need to generate this file and send it to customer support during troubleshooting.

Click **Maintenance > Diagnostics** to open the **Diagnostics** screen.

**Figure 122** Maintenance > Diagnostics

**Diagnostics**

**Diagnostic Information Collector**

Filename: none  
Last Modified: none  
Size: none

**Diagnostic Collect Category**

System  
 Networking  
 Interface  
 CAPWAP  
 Wireless  
 AAA  
 Logs  
 Others  
 Customized

Script:  ⓘ



The following table describes the labels in this screen.

Table 89 Maintenance > Diagnostics

LABEL	DESCRIPTION
Filename	This is the name of the most recently created diagnostic file.
Last modified	This is the date and time that the last diagnostic file was created. The format is yyyy-mm-dd hh:mm:ss.
Size	This is the size of the most recently created diagnostic file.
Diagnostic Collect Category	This field displays each category of settings. Select which categories you want the NWA/WAC to include in the diagnostic file.
Customized	Select this option to obtain the diagnostic information for configuration which is not included in a pre-defined category.
Script	If you select the <b>Customized</b> option, select a shell script file from the drop-down list. You can upload a new shell script file using the <b>Maintenance &gt; File Manager &gt; Shell Script</b> screen.
Collect Now	Click this to have the NWA/WAC create a new diagnostic file.
Download	Click this to save the most recent diagnostic file to a computer.

# CHAPTER 18

## LEDs

### 18.1 Overview

The LEDs of your NWA/WAC can be controlled such that they stay lit (ON) or OFF after the NWA/WAC is ready. There are two features that control the LEDs of your NWA/WAC - **Locator** and **Suppression**.

#### 18.1.1 What You Can Do in this Chapter

- The **Suppression** screen ([Section 18.2 on page 198](#)) allows you to set how you want the LEDs to behave after the device is ready.
- The **Locator** screen ([Section 18.3 on page 199](#)) allows users to see the actual location of the NWA/WAC between several devices in the network.

### 18.2 Suppression Screen

The LED Suppression feature allows you to control how the LEDs of your NWA/WAC behave after it's ready. The default LED suppression setting of your AP is different depending on your NWA/WAC model.

You can go to the **Maintenance > LEDs > Suppression** screen to see the default LED behavior and change the LED suppression setting. After you make changes in the suppression screen, it will be stored as the default when the NWA/WAC is restarted. See ([Section 1.6 on page 25](#)) for information on default values for different models.

Note: When the NWA/WAC is booting or performing firmware upgrade, the LEDs will lit regardless of the setting in LED suppression.

To access this screen, click **Maintenance > LEDs > Suppression**.

**Figure 123** Maintenance > LEDs > Suppression

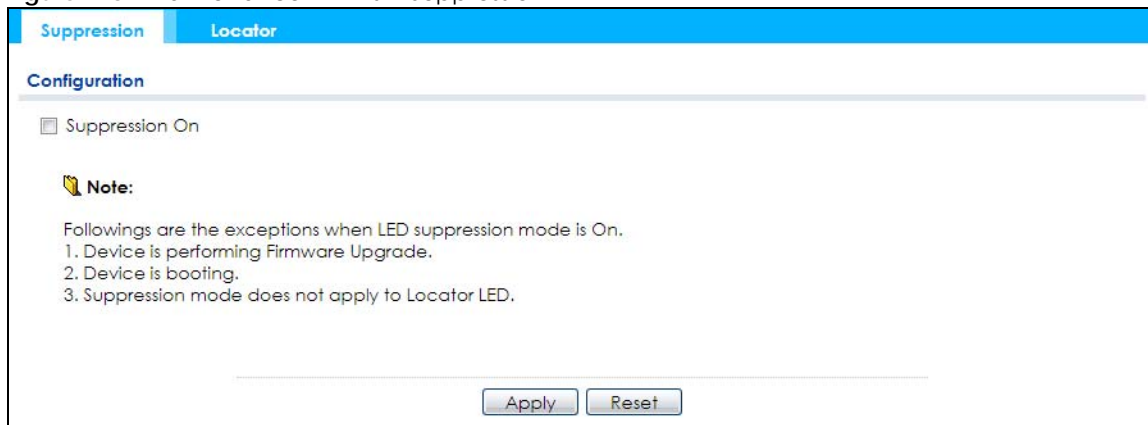

The following table describes fields in the above screen.

Table 90 Maintenance > LED > Suppression

LABEL	DESCRIPTION
Suppression On	If the <b>Suppression On</b> check box is checked, the LEDs of your NWA/WAC will turn off after it's ready. If the check box is unchecked, the LEDs will stay lit after the NWA/WAC is ready.
Apply	Click <b>Apply</b> to save your changes back to the NWA/WAC.
Reset	Click <b>Reset</b> to return the screen to its last-saved settings.

## 18.3 Locator Screen

The Locator feature identifies the location of your WAC among several devices in the network. You can run this feature and set a timer in this screen.

To run the locator feature, enter a number of minutes and click **Turn On** button to have the WAC find its location. The Locator LED will start to blink for the number of minutes set in the **Locator** screen. The default setting is 10 minutes. While the locator is running, the turn on button will gray out and return after it's finished. If you make changes to the time default setting, it will be stored as the default when the WAC restarts.

Note: The Locator feature is not affected by the Suppression setting.

To access this screen, click **Maintenance > LEDs > Locator**.

Figure 124 Maintenance > LEDs > Locator

The following table describes fields in the above screen.

Table 91 Maintenance > LED > Locator

LABEL	DESCRIPTION
Turn On	Click <b>Turn On</b> button to activate the locator. The Locator function will show the actual location of the WAC between several devices in the network.
Turn Off	Otherwise, click <b>Turn Off</b> to disable the locator feature.
Automatically Extinguish After	Enter a time interval between 1 and 60 minutes to stop the locator LED from blinking. Default is 10 minutes.
Apply	Click <b>Apply</b> to save changes in this screen.
Refresh	Click <b>Refresh</b> to update the information in this screen.

# CHAPTER 19

## Antenna Switch

### 19.1 Overview

Use this screen to adjust coverage depending on the orientation of the antenna.

#### 19.1.1 What You Need To Know

Positioning the antennas properly increases the range and coverage area of a wireless LAN.

On the NWA/WAC that comes with internal antennas and also has an antenna switch, you can adjust coverage depending on the orientation of the antenna for the NWA/WAC radios using the web configurator, the command line interface (CLI) or a physical switch. Check [Table 1 on page 13](#) and [Table 3 on page 15](#) to see if your NWA/WAC has an antenna switch.

**Figure 125** WAC6103D-I Physical Antenna Switch

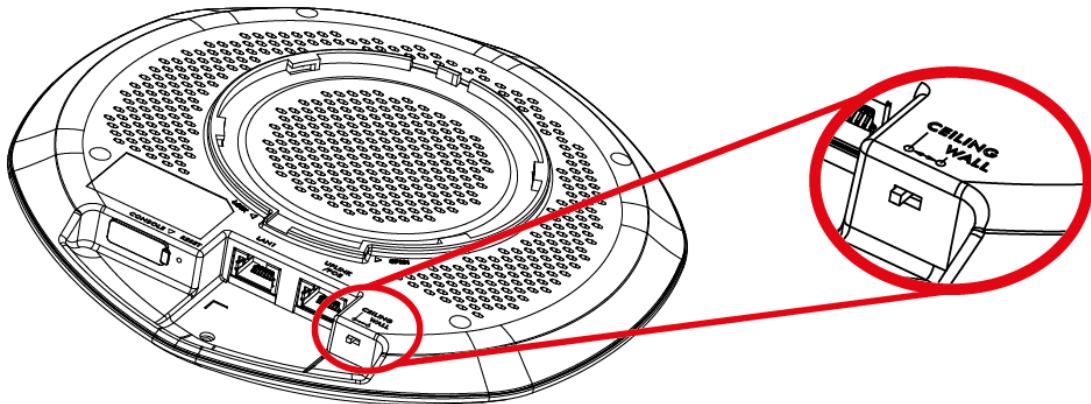

Note: With the physical antenna switch, you apply the same antenna orientation settings to both radios. You can set the radios to have different settings while using the web configurator or the command line interface.

Note: The antenna switch in the web configurator has priority over the physical antenna switch after you **Enable Software Control** in the **Maintenance > Antenna** screen. By default, software control is disabled.

### 19.2 Antenna Switch Screen

To access this screen, click **Maintenance > Antenna**.

Figure 126 Maintenance &gt; Antenna &gt; Antenna Switch

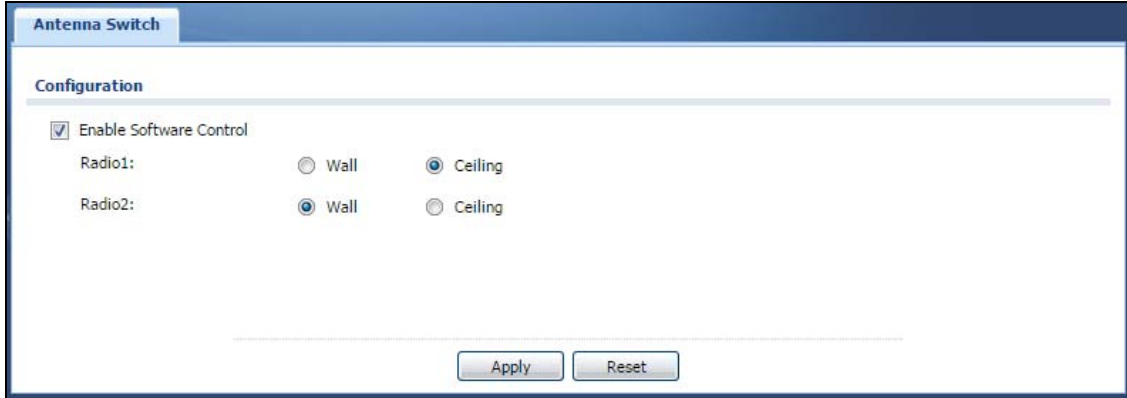

The screenshot shows a web interface for configuring an Antenna Switch. The page title is "Antenna Switch". Under the "Configuration" section, there is a checkbox labeled "Enable Software Control" which is checked. Below this, there are two rows of radio buttons. The first row is for "Radio1:" with "Wall" and "Ceiling" options; "Ceiling" is selected. The second row is for "Radio2:" with "Wall" and "Ceiling" options; "Wall" is selected. At the bottom of the configuration area, there are two buttons: "Apply" and "Reset".

Select the **Enable Software Control** option to use the Web configurator to adjust coverage depending on each radio's antenna orientation for better coverage. Select **Wall** if you mount the NWA/WAC to a wall. Select **Ceiling** if the NWA/WAC is mounted on a ceiling. You can switch from **Wall** to **Ceiling** if there are still wireless dead zones, and vice versa.

# CHAPTER 20

## Reboot

### 20.1 Overview

Use this screen to restart the device.

#### 20.1.1 What You Need To Know

If you applied changes in the Web configurator, these were saved automatically and do not change when you reboot. If you made changes in the CLI, however, you have to use the `write` command to save the configuration before you reboot. Otherwise, the changes are lost when you reboot.

Reboot is different to reset; reset returns the device to its default configuration.

### 20.2 Reboot

This screen allows remote users can restart the device. To access this screen, click **Maintenance > Reboot**.

**Figure 127** Maintenance > Reboot

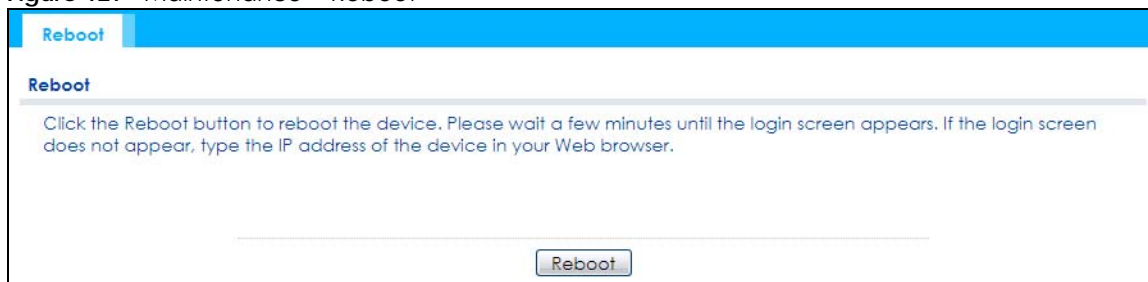

Click the **Reboot** button to restart the NWA/WAC. Wait a few minutes until the login screen appears. If the login screen does not appear, type the IP address of the device in your Web browser.

You can also use the CLI command `reboot` to restart the NWA/WAC.

# CHAPTER 21

## Shutdown

### 21.1 Overview

Use this screen to shut down the device.

**Always use Maintenance > Shutdown > Shutdown or the `shutdown` command before you turn off the NWA/WAC or remove the power. Not doing so can cause the firmware to become corrupt.**

#### 21.1.1 What You Need To Know

Shutdown writes all cached data to the local storage and stops the system processes. Shutdown is different to reset; reset returns the device to its default configuration.

### 21.2 Shutdown

To access this screen, click **Maintenance > Shutdown**.

**Figure 128** Maintenance > Shutdown

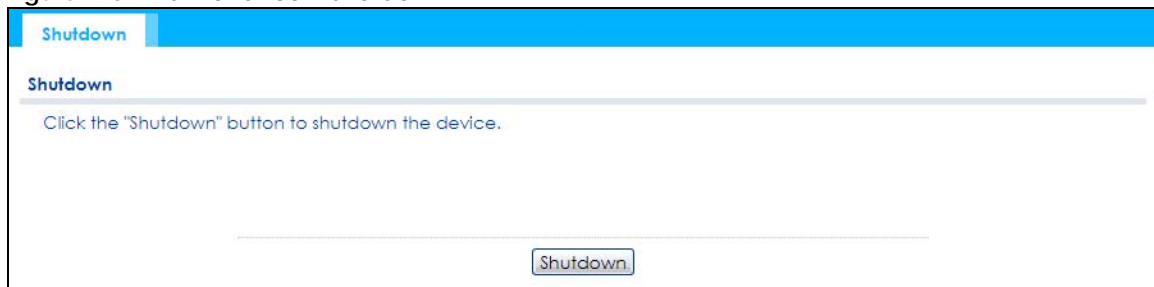

Click the **Shutdown** button to shut down the NWA/WAC. Wait for the device to shut down before you manually turn off or remove the power. It does not turn off the power.

You can also use the CLI command `shutdown` to shut down the NWA/WAC.

# CHAPTER 22

## Troubleshooting

### 22.1 Overview

This chapter offers some suggestions to solve problems you might encounter. The potential problems are divided into the following categories.

- [Power, Hardware Connections, and LED](#)
- [NWA/WAC Access and Login](#)
- [Internet Access](#)
- [Wireless Connections](#)
- [Resetting the NWA/WAC](#)

### 22.2 Power, Hardware Connections, and LED

---

[The NWA/WAC does not turn on. The LED is not on.](#)

---

- 1 Make sure you are using the power adaptor included with the NWA/WAC or a PoE power injector/switch.
- 2 Make sure the power adaptor or PoE power injector/switch is connected to the NWA/WAC and plugged in to an appropriate power source. Make sure the power source is turned on.
- 3 Disconnect and re-connect the power adaptor or PoE power injector/switch.
- 4 Inspect your cables for damage. Contact the vendor to replace any damaged cables.
- 5 If none of these steps work, you may have faulty hardware and should contact your NWA/WAC vendor.

---

[The LED does not behave as expected.](#)

---

- 1 Make sure you understand the normal behavior of the LED. See [Section 1.6 on page 25](#).
- 2 Check the hardware connections. See the Quick Start Guide.
- 3 Inspect your cables for damage. Contact the vendor to replace any damaged cables.



- 4 Disconnect and re-connect the power adaptor or PoE power injector to the NWA/WAC.
- 5 If the problem continues, contact the vendor.

## 22.3 NWA/WAC Access and Login

---

### I forgot the IP address for the NWA/WAC.

---

- 1 The default IP address (in standalone AP mode) is 192.168.1.2.
- 2 If you changed the IP address and have forgotten it, you have to reset the device to its factory defaults. See [Section 22.6 on page 212](#).
- 3 If your NWA/WAC is a DHCP client, you can find your IP address from the DHCP server. This information is only available from the DHCP server which allocates IP addresses on your network. Find this information directly from the DHCP server or contact your system administrator for more information.

### I cannot see or access the Login screen in the web configurator.

---

- 1 Make sure you are using the correct IP address.
  - The default IP address (in standalone AP mode) is 192.168.1.2.
  - If you changed the IP address, use the new IP address.
  - If you changed the IP address and have forgotten it, see the troubleshooting suggestions for [I forgot the IP address for the NWA/WAC](#).
- 2 Check the hardware connections, and make sure the LED is behaving as expected. See the Quick Start Guide and [Section 1.6 on page 25](#).
- 3 Make sure your Internet browser does not block pop-up windows and has JavaScripts and Java enabled.
- 4 Make sure your computer is in the same subnet as the NWA/WAC. (If you know that there are routers between your computer and the NWA/WAC, skip this step.)
  - If there is a DHCP server on your network, make sure your computer is using a dynamic IP address.
  - If there is no DHCP server on your network, make sure your computer's IP address is in the same subnet as the NWA/WAC.
- 5 Reset the device to its factory defaults, and try to access the NWA/WAC with the default IP address. See [Section 22.6 on page 212](#).
- 6 If the problem continues, contact the network administrator or vendor, or try one of the advanced suggestions.

#### Advanced Suggestions

- Try to access the NWA/WAC using another service, such as Telnet. If you can access the NWA/WAC, check the remote management settings to find out why the NWA/WAC does not respond to HTTP.
- If your computer is connected wirelessly, use a computer that is connected to a **LAN/ETHERNET** port.

---

I forgot the password.

---

- 1 The default password is **1234**.
- 2 If this does not work, you have to reset the device to its factory defaults. See [Section 22.6 on page 212](#).

---

I can see the **Login** screen, but I cannot log in to the NWA/WAC.

---

- 1 Make sure you have entered the user name and password correctly. The default password is **1234**. This fields are case-sensitive, so make sure [Caps Lock] is not on.
- 2 You cannot log in to the web configurator while someone is using Telnet to access the NWA/WAC. Log out of the NWA/WAC in the other session, or ask the person who is logged in to log out.
- 3 Disconnect and re-connect the power adaptor or PoE power injector to the NWA/WAC.
- 4 If this does not work, you have to reset the device to its factory defaults. See [Section 22.6 on page 212](#).

---

I cannot use FTP to upload / download the configuration file. / I cannot use FTP to upload new firmware.

---

See the troubleshooting suggestions for [I cannot see or access the Login screen in the web configurator](#). Ignore the suggestions about your browser.

## 22.4 Internet Access

---

I cannot access the Internet.

---

- 1 Check the hardware connections, and make sure the LED is behaving as expected. See the Quick Start Guide and [Section 22.2 on page 204](#).
- 2 Make sure the NWA/WAC is connected to a broadband modem or router with Internet access and your computer is set to obtain an dynamic IP address.

- 3 If you are trying to access the Internet wirelessly, make sure the wireless settings on the wireless client are the same as the settings on the NWA/WAC.
- 4 Disconnect all the cables from your device, and follow the directions in the Quick Start Guide again.
- 5 If the problem continues, contact your ISP.

---

I cannot access the Internet anymore. I had access to the Internet (with the NWA/WAC), but my Internet connection is not available anymore.

---

- 1 Check the hardware connections, and make sure the LED is behaving as expected. See the Quick Start Guide and [Section 1.6 on page 25](#).
- 2 Reboot the NWA/WAC.
- 3 If the problem continues, contact your ISP.

---

The Internet connection is slow or intermittent.

---

- 1 There might be a lot of traffic on the network. Look at the LED, and check [Section 1.6 on page 25](#). If the NWA/WAC is sending or receiving a lot of information, try closing some programs that use the Internet, especially peer-to-peer applications.
- 2 Check the signal strength. If the signal is weak, try moving the NWA/WAC closer to the NWA/WAC (if possible), and look around to see if there are any devices that might be interfering with the wireless network (microwaves, other wireless networks, and so on).
- 3 Reboot the NWA/WAC.
- 4 If the problem continues, contact the network administrator or vendor, or try one of the advanced suggestions.

#### Advanced Suggestions

Check the settings for QoS. If it is disabled, you might consider activating it. If it is enabled, you might consider raising or lowering the priority for some applications.

## 22.5 Wireless Connections

---

I cannot access the NWA/WAC or ping any computer from the WLAN.

---

- 1 Make sure the wireless LAN (wireless radio) is enabled on the NWA/WAC.

- 2 Make sure the radio or at least one of the NWA/WAC's radios is operating in AP mode.
- 3 Make sure the wireless adapter (installed on your computer) is working properly.
- 4 Make sure the wireless adapter (installed on your computer) is IEEE 802.11 compatible and supports the same wireless standard as the NWA/WAC's active radio.
- 5 Make sure your computer (with a wireless adapter installed) is within the transmission range of the NWA/WAC.
- 6 Check that both the NWA/WAC and your computer are using the same wireless and wireless security settings.

---

### Hackers have accessed my WEP-encrypted wireless LAN.

---

WEP is extremely insecure. Its encryption can be broken by an attacker, using widely-available software. It is strongly recommended that you use a more effective security mechanism. Use the strongest security mechanism that all the wireless devices in your network support. WPA2 or WPA2-PSK is recommended.

---

### The wireless security is not following the re-authentication timer setting I specified.

---

If a RADIUS server authenticates wireless stations, the re-authentication timer on the RADIUS server has priority. Change the RADIUS server's configuration if you need to use a different re-authentication timer setting.

---

### I cannot get a certificate to import into the NWA/WAC.

---

- 1 For **My Certificates**, you can import a certificate that matches a corresponding certification request that was generated by the NWA/WAC. You can also import a certificate in PKCS#12 format, including the certificate's public and private keys.
- 2 You must remove any spaces from the certificate's filename before you can import the certificate.
- 3 Any certificate that you want to import has to be in one of these file formats:
  - Binary X.509: This is an ITU-T recommendation that defines the formats for X.509 certificates.
  - PEM (Base-64) encoded X.509: This Privacy Enhanced Mail format uses lowercase letters, uppercase letters and numerals to convert a binary X.509 certificate into a printable form.
  - Binary PKCS#7: This is a standard that defines the general syntax for data (including digital signatures) that may be encrypted. A PKCS #7 file is used to transfer a public key certificate. The private key is not included. The NWA/WAC currently allows the importation of a PKCS#7 file that contains a single certificate.
  - PEM (Base-64) encoded PKCS#7: This Privacy Enhanced Mail (PEM) format uses lowercase letters, uppercase letters and numerals to convert a binary PKCS#7 certificate into a printable form.

- Binary PKCS#12: This is a format for transferring public key and private key certificates. The private key in a PKCS #12 file is within a password-encrypted envelope. The file's password is not connected to your certificate's public or private passwords. Exporting a PKCS #12 file creates this and you must provide it to decrypt the contents when you import the file into the NWA/WAC.

Note: Be careful not to convert a binary file to text during the transfer process. It is easy for this to occur since many programs use text files by default.

---

### I can only see newer logs. Older logs are missing.

---

When a log reaches the maximum number of log messages, new log messages automatically overwrite existing log messages, starting with the oldest existing log message first.

---

### The commands in my configuration file or shell script are not working properly.

---

- In a configuration file or shell script, use “#” or “!” as the first character of a command line to have the NWA/WAC treat the line as a comment.
- Your configuration files or shell scripts can use “exit” or a command line consisting of a single “!” to have the NWA/WAC exit sub command mode.
- Include `write` commands in your scripts. Otherwise the changes will be lost when the NWA/WAC restarts. You could use multiple `write` commands in a long script.

Note: “exit” or “!” must follow sub commands if it is to make the NWA/WAC exit sub command mode.

---

### I cannot get the firmware uploaded using the commands.

---

The Web Configurator is the recommended method for uploading firmware. You only need to use the command line interface if you need to recover the firmware. See the CLI Reference Guide for how to determine if you need to recover the firmware and how to recover it.

---

### Wireless clients are not being load balanced among my APs.

---

- Make sure that all the APs used by the wireless clients in question share the same SSID, security, and radio settings.
- Make sure that all the APs are in the same broadcast domain.
- Make sure that the wireless clients are in range of the other APs; if they are only in range of a single AP, then load balancing may not be as effective.

---

In the **Monitor > Wireless > AP Information > Radio List** screen, there is no load balancing indicator associated with any APs assigned to the load balancing task.

---

- Check to be sure that the AP profile which contains the load balancing settings is correctly assigned to the APs in question.
- The load balancing task may have been terminated because further load balancing on the APs in question is no longer required.

---

How do I remove the WAC6500 series indoor AP from its mounting bracket?

---

- Find the down arrow close to the Ethernet ports, then use a thin flat tool (for example, a flat screw driver) to lift up a clip beneath the down arrow.

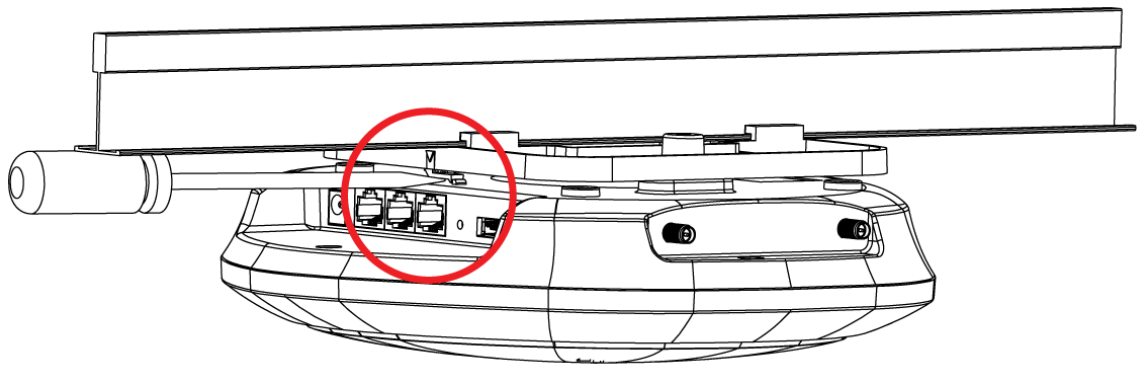

- Turn the WAC6500 series indoor AP counter-clockwise.

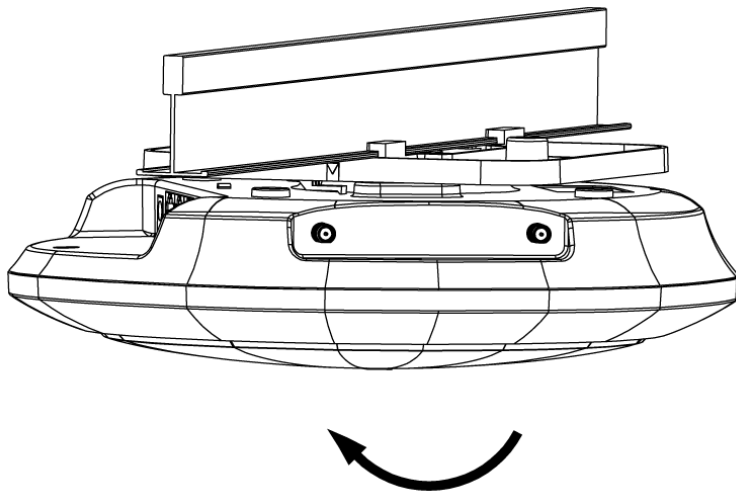

- Detach the WAC6500 series indoor AP from the mounting bracket.

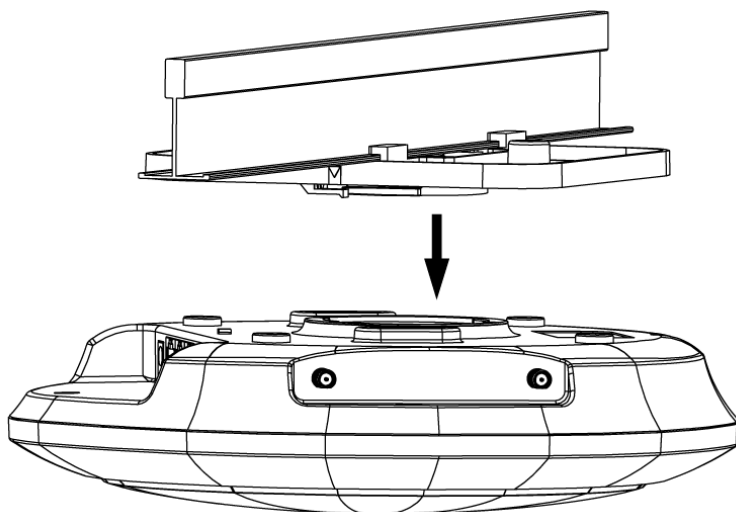

---

How do I remove the NWA1123-AC PRO and WAC6103D-I indoor AP from its mounting bracket?

---

- Find the down arrow close to the Ethernet ports, then use a thin flat tool (for example, a flat screw driver) to lift up a clip beneath 5GHz LED.

- Turn the NWA1123-AC PRO or WAC6103D-I indoor AP counter-clockwise to detach it from the mounting bracket.

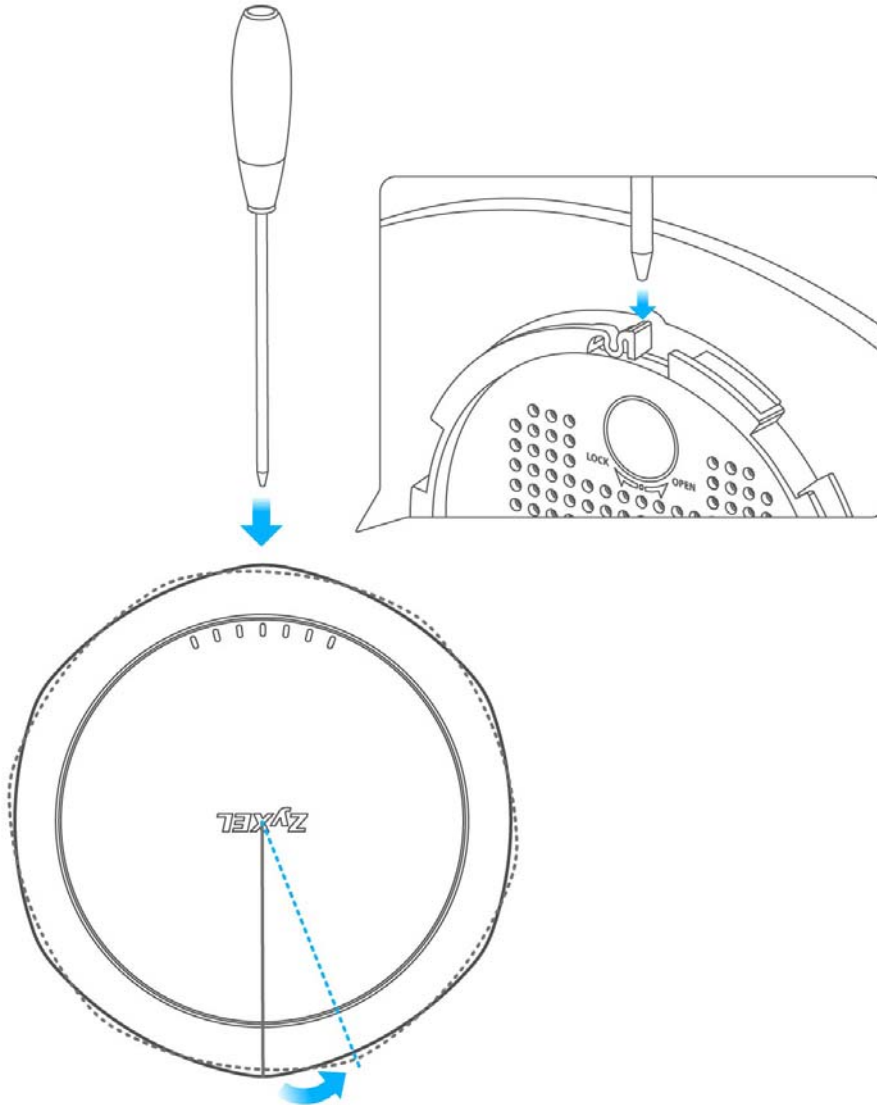

## 22.6 Resetting the NWA/WAC

If you cannot access the NWA/WAC by any method, try restarting it by turning the power off and then on again. If you still cannot access the NWA/WAC by any method or you forget the administrator password(s), you can reset the NWA/WAC to its factory-default settings. Any configuration files or shell scripts that you saved on the NWA/WAC should still be available afterwards.

Use the following procedure to reset the NWA/WAC to its factory-default settings. This overwrites the settings in the `startup-config.conf` file with the settings in the `system-default.conf` file.

Note: This procedure removes the current configuration.



- 1 Make sure the Power LED is on and not blinking.
- 2 Press the **RESET** button and hold it until the Power LED begins to blink. (This usually takes about ten seconds.)
- 3 Release the **RESET** button, and wait for the NWA/WAC to restart.

You should be able to access the NWA/WAC using the default settings.

## 22.7 Getting More Troubleshooting Help

Search for support information for your model at [www.zyxel.com](http://www.zyxel.com) for more troubleshooting suggestions.

# APPENDIX A

## Importing Certificates

This appendix shows you how to import public key certificates into your web browser.

Public key certificates are used by web browsers to ensure that a secure web site is legitimate. When a certificate authority such as VeriSign, Comodo, or Network Solutions, to name a few, receives a certificate request from a website operator, they confirm that the web domain and contact information in the request match those on public record with a domain name registrar. If they match, then the certificate is issued to the website operator, who then places it on the site to be issued to all visiting web browsers to let them know that the site is legitimate.

Many Zyxel products, such as the NWA/WAC, issue their own public key certificates. These can be used by web browsers on a LAN or WAN to verify that they are in fact connecting to the legitimate device and not one masquerading as it. However, because the certificates were not issued by one of the several organizations officially recognized by the most common web browsers, you will need to import the Zyxel-created certificate into your web browser and flag that certificate as a trusted authority.

Note: You can see if you are browsing on a secure website if the URL in your web browser's address bar begins with `https://` or there is a sealed padlock icon (  ) somewhere in the main browser window (not all browsers show the padlock in the same location).

### Internet Explorer

The following example uses Microsoft Internet Explorer 7 on Windows XP Professional; however, they can also apply to Internet Explorer on Windows Vista.

- 1 If your device's Web Configurator is set to use SSL certification, then the first time you browse to it you are presented with a certification error.

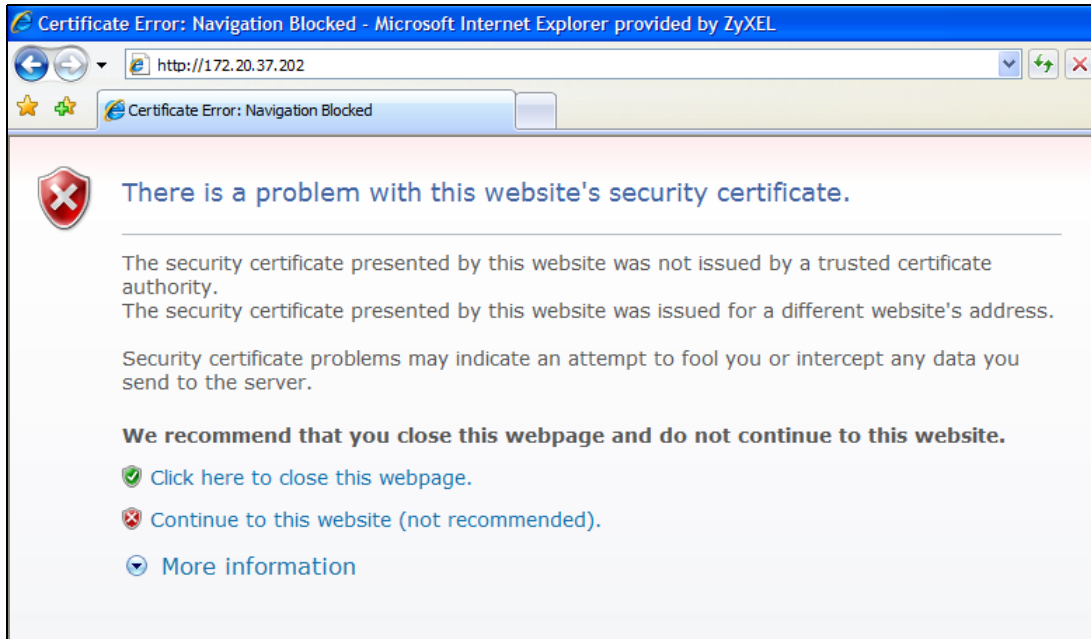

- 2 Click **Continue to this website (not recommended)**.
- 3 In the **Address Bar**, click **Certificate Error > View certificates**.

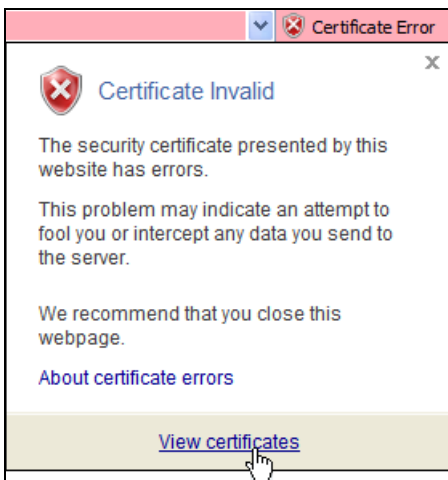

- 4 In the Certificate dialog box, click **Install Certificate**.

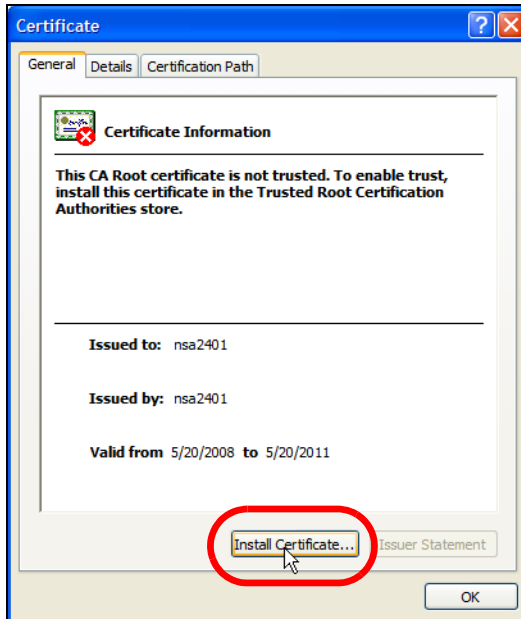

- 5 In the Certificate Import Wizard, click **Next**.



- 6 If you want Internet Explorer to **Automatically** select certificate store based on the type of certificate, click **Next** again and then go to step 9.

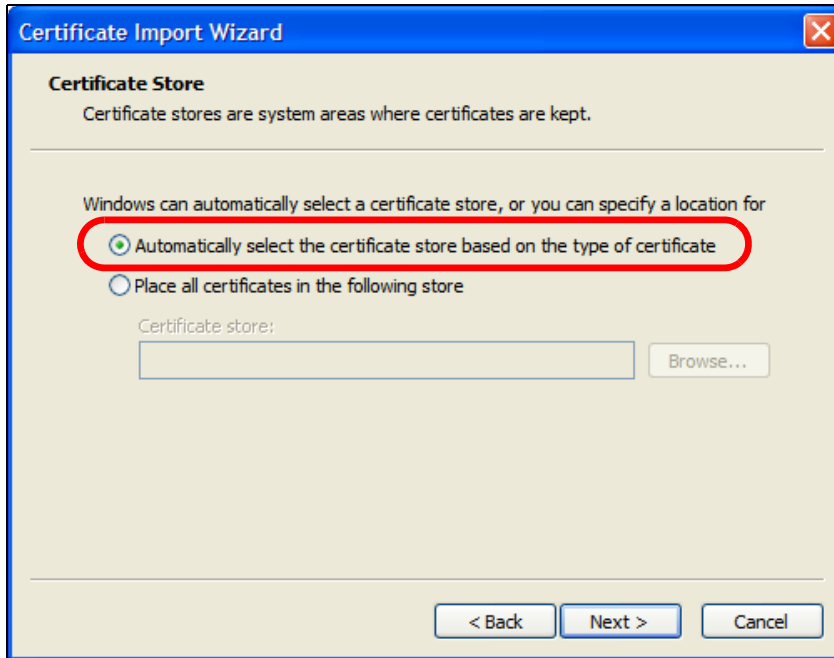

- 7 Otherwise, select **Place all certificates in the following store** and then click **Browse**.

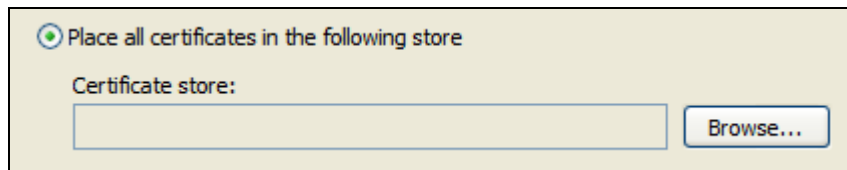

- 8 In the **Select Certificate Store** dialog box, choose a location in which to save the certificate and then click **OK**.

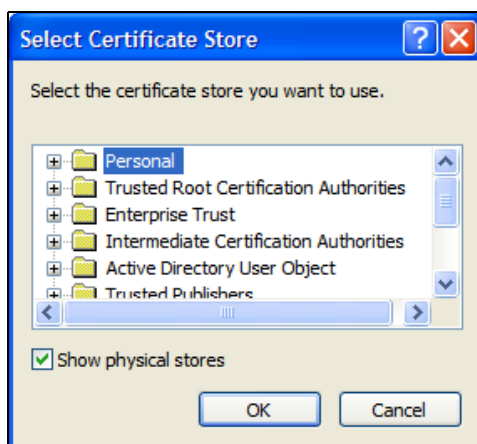

- 9 In the **Completing the Certificate Import Wizard** screen, click **Finish**.

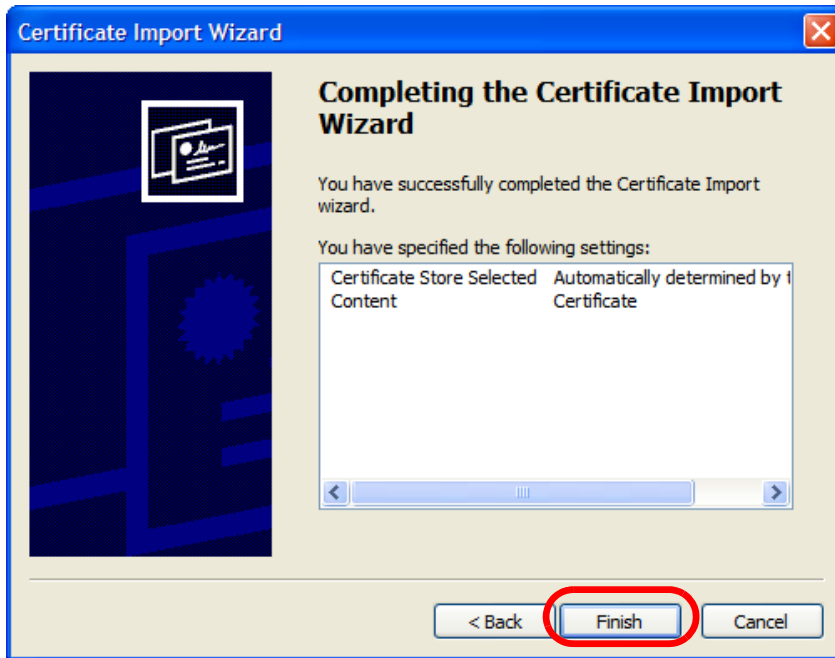

- 10 If you are presented with another **Security Warning**, click **Yes**.

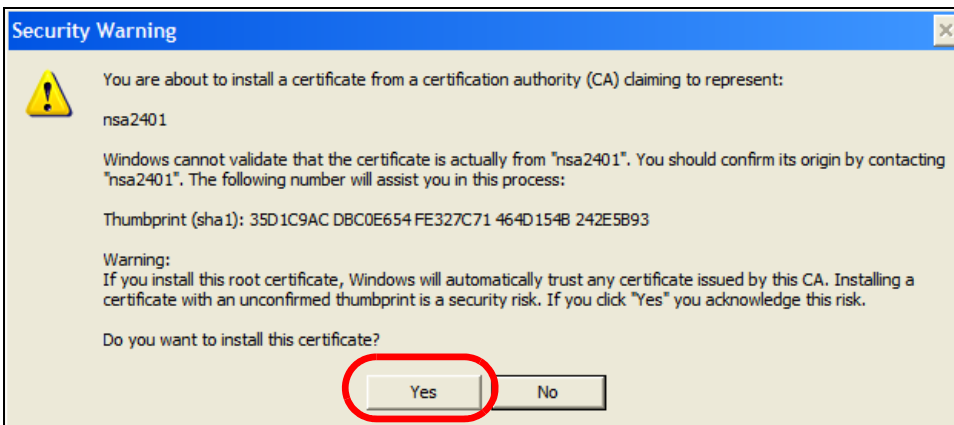

- 11 Finally, click **OK** when presented with the successful certificate installation message.

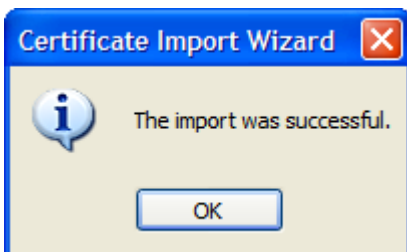

- 12 The next time you start Internet Explorer and go to a Zyxel Web Configurator page, a sealed padlock icon appears in the address bar. Click it to view the page's **Website Identification** information.

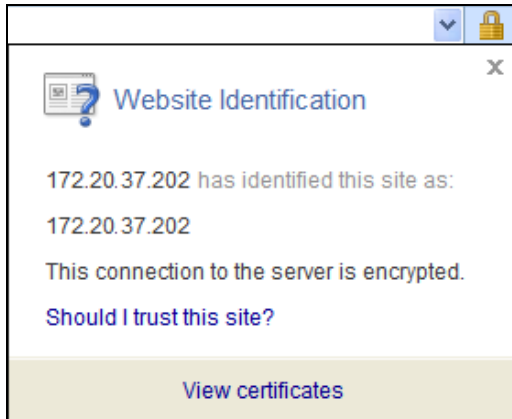

## Installing a Stand-Alone Certificate File in Internet Explorer

Rather than browsing to a Zyxel Web Configurator and installing a public key certificate when prompted, you can install a stand-alone certificate file if one has been issued to you.

- 1 Double-click the public key certificate file.



- 2 In the security warning dialog box, click **Open**.

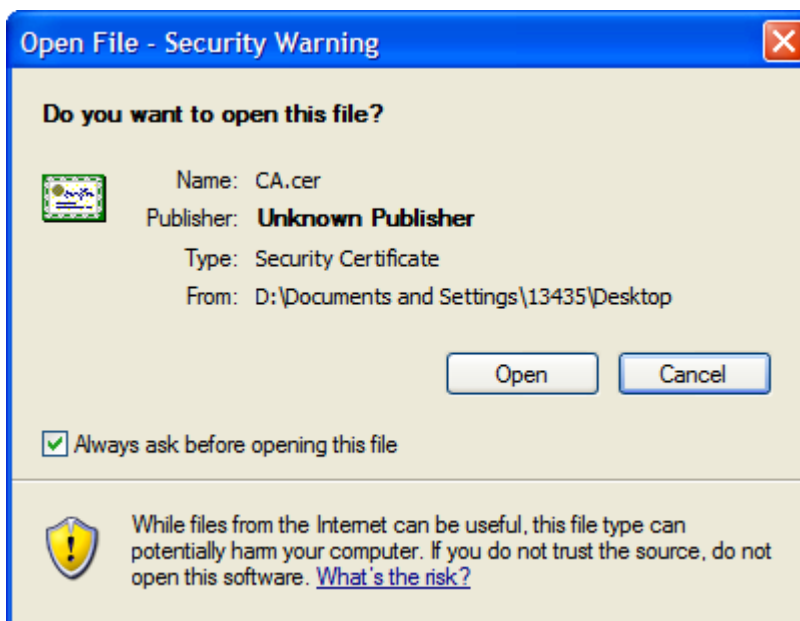

- 3 Refer to steps 4-12 in the Internet Explorer procedure beginning on [page 214](#) to complete the installation process.

## Removing a Certificate in Internet Explorer

This section shows you how to remove a public key certificate in Internet Explorer 7 on Windows XP.

- 1 Open **Internet Explorer** and click **Tools > Internet Options**.

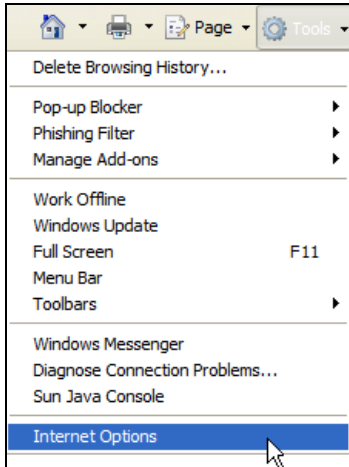

- 2 In the **Internet Options** dialog box, click **Content > Certificates**.

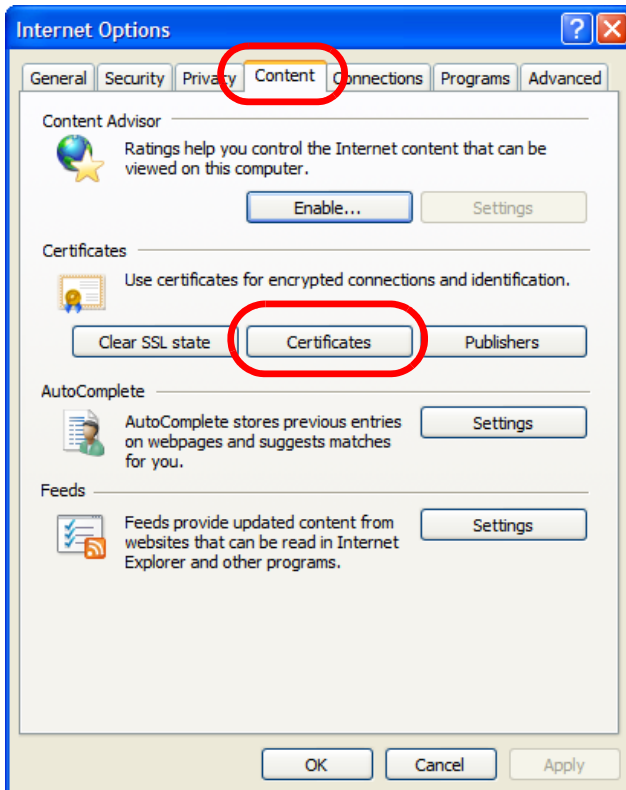



- In the **Certificates** dialog box, click the **Trusted Root Certificates Authorities** tab, select the certificate that you want to delete, and then click **Remove**.

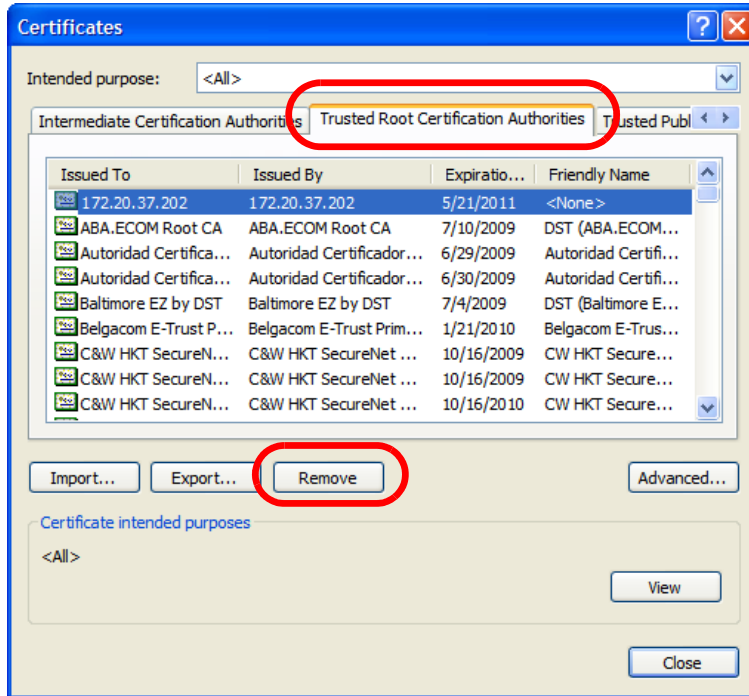

- In the **Certificates** confirmation, click **Yes**.



- In the **Root Certificate Store** dialog box, click **Yes**.

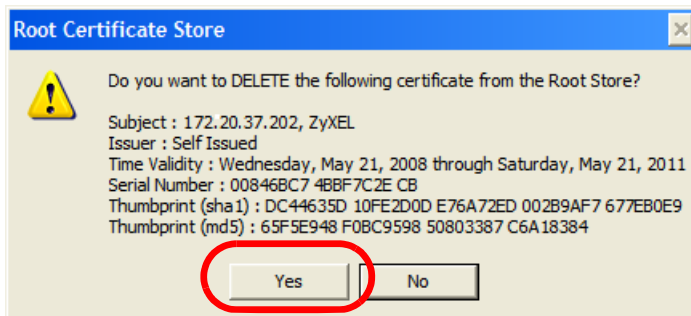

- The next time you go to the web site that issued the public key certificate you just removed, a certification error appears.

## Firefox

The following example uses Mozilla Firefox 2 on Windows XP Professional; however, the screens can also apply to Firefox 2 on all platforms.

- 1 If your device's Web Configurator is set to use SSL certification, then the first time you browse to it you are presented with a certification error.
- 2 Select **Accept this certificate permanently** and click **OK**.

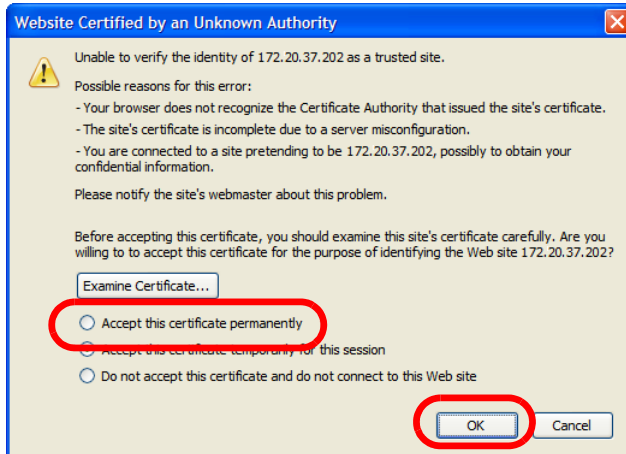

- 3 The certificate is stored and you can now connect securely to the Web Configurator. A sealed padlock appears in the address bar, which you can click to open the **Page Info > Security** window to view the web page's security information.

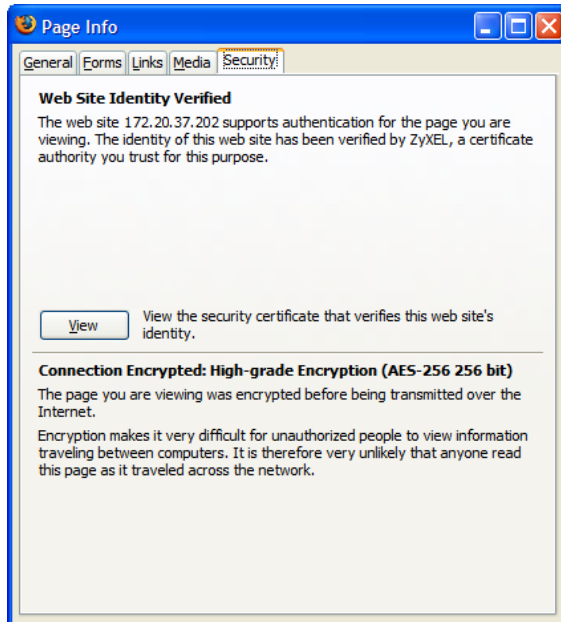

## Installing a Stand-Alone Certificate File in Firefox

Rather than browsing to a Zyxel Web Configurator and installing a public key certificate when prompted, you can install a stand-alone certificate file if one has been issued to you.

- 1 Open **Firefox** and click **Tools > Options**.

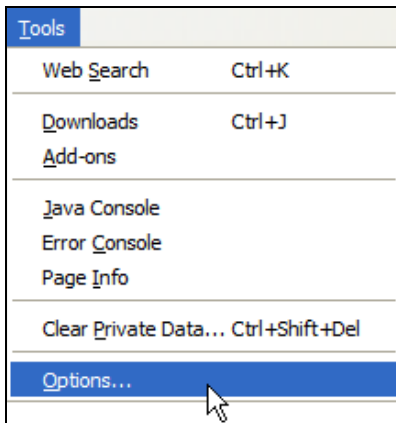

- 2 In the **Options** dialog box, click **Advanced > Encryption > View Certificates**.

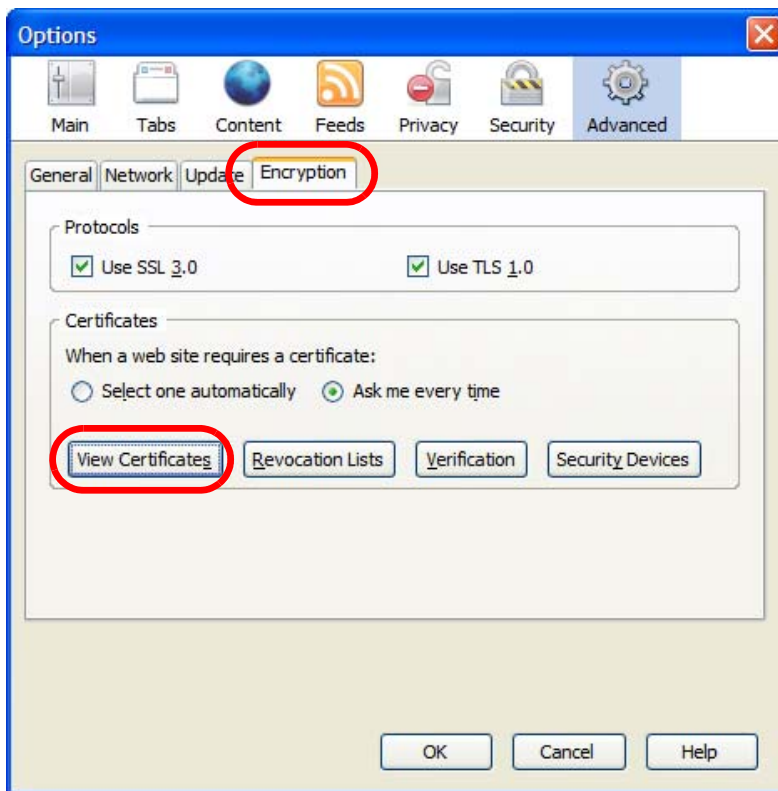

- 3 In the **Certificate Manager** dialog box, click **Web Sites > Import**.

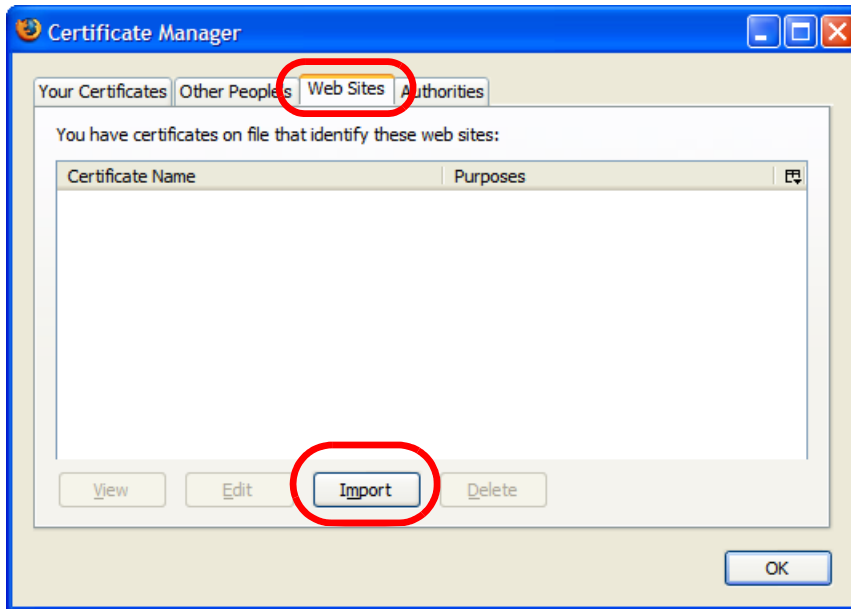

- 4 Use the **Select File** dialog box to locate the certificate and then click **Open**.

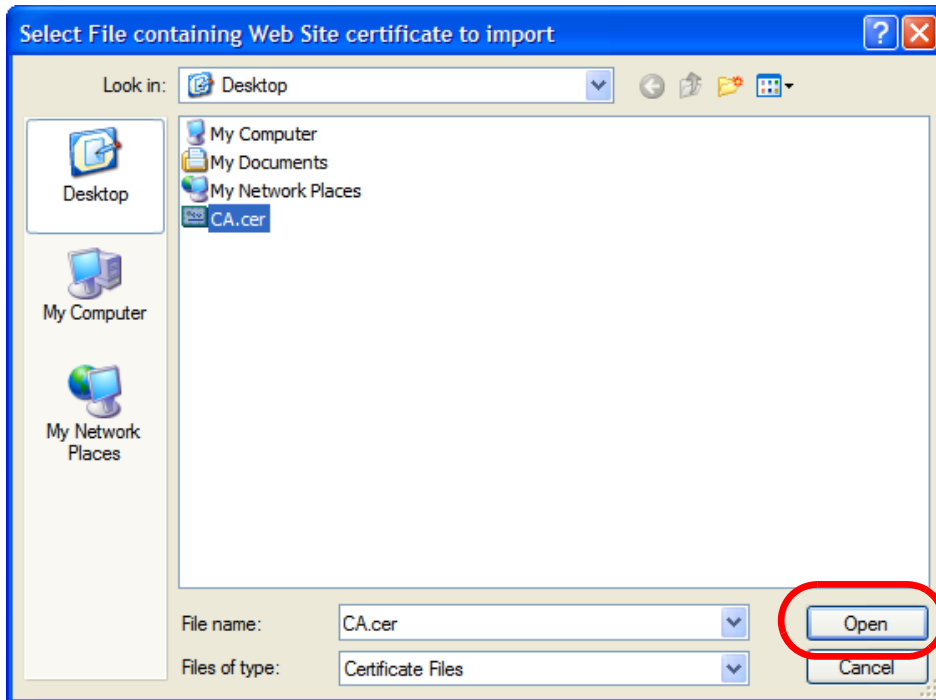

- 5 The next time you visit the web site, click the padlock in the address bar to open the **Page Info > Security** window to see the web page's security information.

## Removing a Certificate in Firefox

This section shows you how to remove a public key certificate in Firefox 2.

- 1 Open Firefox and click Tools > Options.

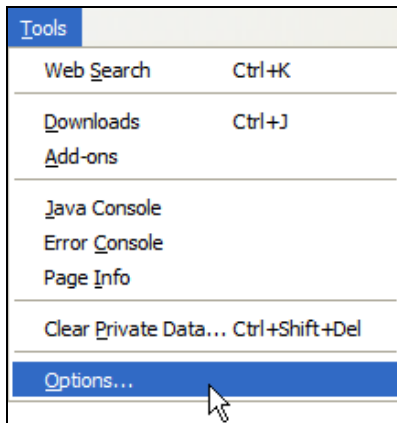

- 2 In the Options dialog box, click Advanced > Encryption > View Certificates.

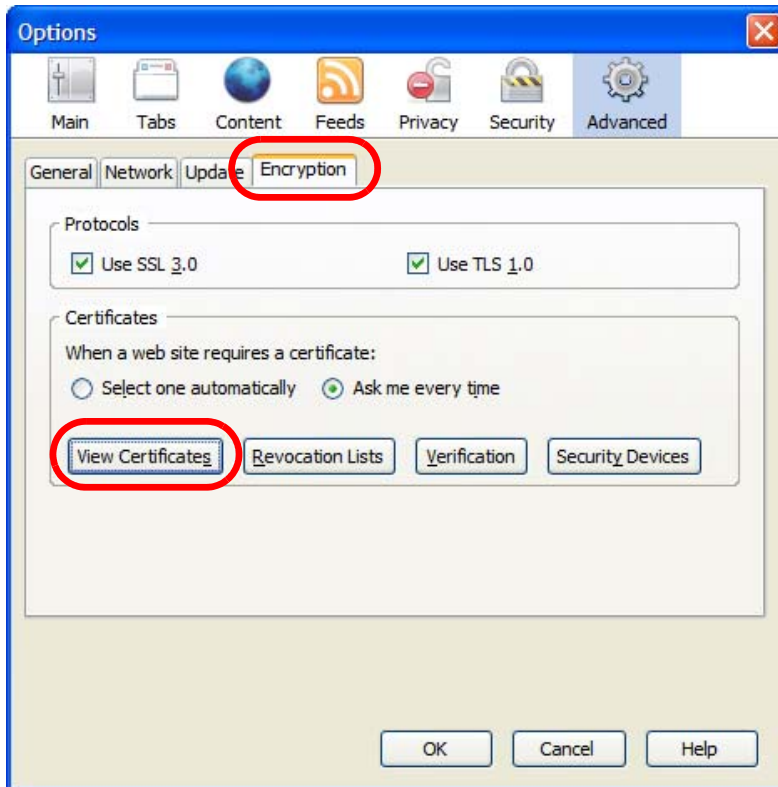

- 3 In the **Certificate Manager** dialog box, select the **Web Sites** tab, select the certificate that you want to remove, and then click **Delete**.

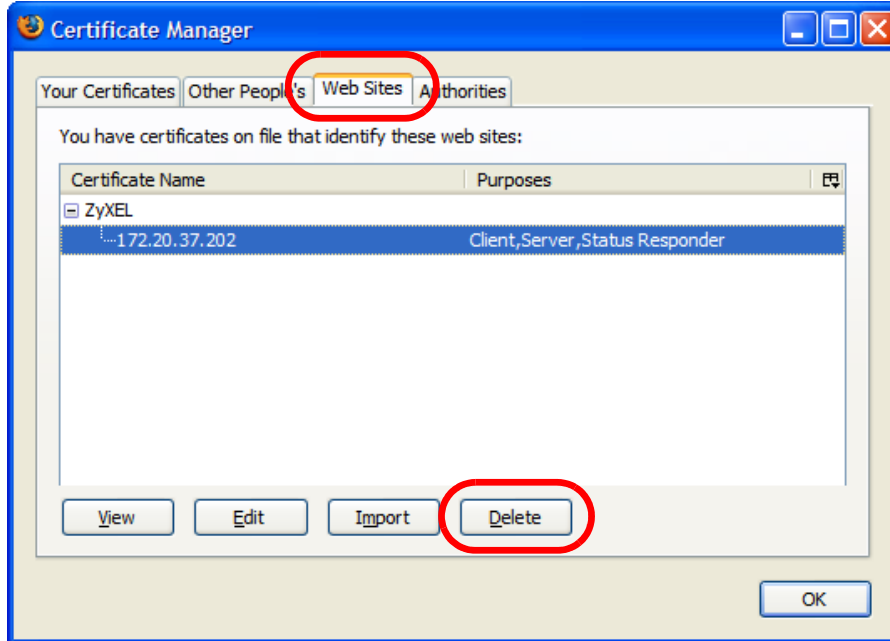

- 4 In the **Delete Web Site Certificates** dialog box, click **OK**.

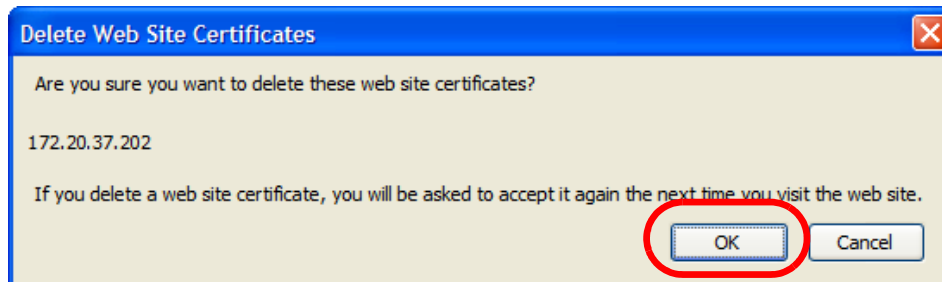

- 5 The next time you go to the web site that issued the public key certificate you just removed, a certification error appears.

# APPENDIX B

## IPv6

### Overview

IPv6 (Internet Protocol version 6), is designed to enhance IP address size and features. The increase in IPv6 address size to 128 bits (from the 32-bit IPv4 address) allows up to  $3.4 \times 10^{38}$  IP addresses.

### IPv6 Addressing

The 128-bit IPv6 address is written as eight 16-bit hexadecimal blocks separated by colons (:). This is an example IPv6 address `2001:0db8:1a2b:0015:0000:0000:1a2f:0000`.

IPv6 addresses can be abbreviated in two ways:

- Leading zeros in a block can be omitted. So `2001:0db8:1a2b:0015:0000:0000:1a2f:0000` can be written as `2001:db8:1a2b:15:0:0:1a2f:0`.
- Any number of consecutive blocks of zeros can be replaced by a double colon. A double colon can only appear once in an IPv6 address. So `2001:0db8:0000:0000:1a2f:0000:0000:0015` can be written as `2001:0db8::1a2f:0000:0000:0015`, `2001:0db8:0000:0000:1a2f::0015`, `2001:db8::1a2f:0:0:15` or `2001:db8:0:0:1a2f::15`.

### Prefix and Prefix Length

Similar to an IPv4 subnet mask, IPv6 uses an address prefix to represent the network address. An IPv6 prefix length specifies how many most significant bits (start from the left) in the address compose the network address. The prefix length is written as “/x” where x is a number. For example,

`2001:db8:1a2b:15::1a2f:0/32`

means that the first 32 bits (`2001:db8`) is the subnet prefix.

### Link-local Address

A link-local address uniquely identifies a device on the local network (the LAN). It is similar to a “private IP address” in IPv4. You can have the same link-local address on multiple interfaces on a device. A link-local unicast address has a predefined prefix of `fe80::/10`. The link-local unicast address format is as follows.

Table 92 Link-local Unicast Address Format

1111 1110 10	0	Interface ID
10 bits	54 bits	64 bits

### Global Address

A global address uniquely identifies a device on the Internet. It is similar to a “public IP address” in IPv4. A global unicast address starts with a 2 or 3.

## Unspecified Address

An unspecified address (0:0:0:0:0:0 or ::) is used as the source address when a device does not have its own address. It is similar to "0.0.0.0" in IPv4.

## Loopback Address

A loopback address (0:0:0:0:0:1 or ::1) allows a host to send packets to itself. It is similar to "127.0.0.1" in IPv4.

## Multicast Address

In IPv6, multicast addresses provide the same functionality as IPv4 broadcast addresses. Broadcasting is not supported in IPv6. A multicast address allows a host to send packets to all hosts in a multicast group.

Multicast scope allows you to determine the size of the multicast group. A multicast address has a predefined prefix of ff00::/8. The following table describes some of the predefined multicast addresses.

Table 93 Predefined Multicast Address

MULTICAST ADDRESS	DESCRIPTION
FF01:0:0:0:0:0:1	All hosts on a local node.
FF01:0:0:0:0:0:2	All routers on a local node.
FF02:0:0:0:0:0:1	All hosts on a local connected link.
FF02:0:0:0:0:0:2	All routers on a local connected link.
FF05:0:0:0:0:0:2	All routers on a local site.
FF05:0:0:0:0:0:1:3	All DHCP servers on a local site.

The following table describes the multicast addresses which are reserved and can not be assigned to a multicast group.

Table 94 Reserved Multicast Address

MULTICAST ADDRESS
FF00:0:0:0:0:0:0:0
FF01:0:0:0:0:0:0:0
FF02:0:0:0:0:0:0:0
FF03:0:0:0:0:0:0:0
FF04:0:0:0:0:0:0:0
FF05:0:0:0:0:0:0:0
FF06:0:0:0:0:0:0:0
FF07:0:0:0:0:0:0:0
FF08:0:0:0:0:0:0:0
FF09:0:0:0:0:0:0:0
FF0A:0:0:0:0:0:0:0
FF0B:0:0:0:0:0:0:0
FF0C:0:0:0:0:0:0:0
FF0D:0:0:0:0:0:0:0
FF0E:0:0:0:0:0:0:0
FF0F:0:0:0:0:0:0:0



## Subnet Masking

Both an IPv6 address and IPv6 subnet mask compose of 128-bit binary digits, which are divided into eight 16-bit blocks and written in hexadecimal notation. Hexadecimal uses four bits for each character (1 ~ 10, A ~ F). Each block's 16 bits are then represented by four hexadecimal characters. For example, FFFF:FFFF:FFFF:FFFF:FC00:0000:0000:0000.

## Interface ID

In IPv6, an interface ID is a 64-bit identifier. It identifies a physical interface (for example, an Ethernet port) or a virtual interface (for example, the management IP address for a VLAN). One interface should have a unique interface ID.

## EUI-64

The EUI-64 (Extended Unique Identifier) defined by the IEEE (Institute of Electrical and Electronics Engineers) is an interface ID format designed to adapt with IPv6. It is derived from the 48-bit (6-byte) Ethernet MAC address as shown next. EUI-64 inserts the hex digits fffe between the third and fourth bytes of the MAC address and complements the seventh bit of the first byte of the MAC address. See the following example.

Table 95

MAC	00	:	13	:	49	:	12	:	34	:	56
-----	----	---	----	---	----	---	----	---	----	---	----

Table 96

EUI-64	02	:	13	:	49	:	FF	:	FE	:	12	:	34	:	56
--------	----	---	----	---	----	---	----	---	----	---	----	---	----	---	----

## Stateless Autoconfiguration

With stateless autoconfiguration in IPv6, addresses can be uniquely and automatically generated. Unlike DHCPv6 (Dynamic Host Configuration Protocol version six) which is used in IPv6 stateful autoconfiguration, the owner and status of addresses don't need to be maintained by a DHCP server. Every IPv6 device is able to generate its own and unique IP address automatically when IPv6 is initiated on its interface. It combines the prefix and the interface ID (generated from its own Ethernet MAC address, see [Interface ID](#) and [EUI-64](#)) to form a complete IPv6 address.

When IPv6 is enabled on a device, its interface automatically generates a link-local address (beginning with fe80).

When the interface is connected to a network with a router and the NWA/WAC is set to automatically obtain an IPv6 network prefix from the router for the interface, it generates <sup>1</sup>another address which combines its interface ID and global and subnet information advertised from the router. This is a routable global IP address.

## DHCPv6

The Dynamic Host Configuration Protocol for IPv6 (DHCPv6, RFC 3315) is a server-client protocol that allows a DHCP server to assign and pass IPv6 network addresses, prefixes and other configuration information to DHCP clients. DHCPv6 servers and clients exchange DHCP messages using UDP.

---

1. In IPv6, all network interfaces can be associated with several addresses.

Each DHCP client and server has a unique DHCP Unique Identifier (DUID), which is used for identification when they are exchanging DHCPv6 messages. The DUID is generated from the MAC address, time, vendor assigned ID and/or the vendor's private enterprise number registered with the IANA. It should not change over time even after you reboot the device.

## Identity Association

An Identity Association (IA) is a collection of addresses assigned to a DHCP client, through which the server and client can manage a set of related IP addresses. Each IA must be associated with exactly one interface. The DHCP client uses the IA assigned to an interface to obtain configuration from a DHCP server for that interface. Each IA consists of a unique IAID and associated IP information.

The IA type is the type of address in the IA. Each IA holds one type of address. IA\_NA means an identity association for non-temporary addresses and IA\_TA is an identity association for temporary addresses. An IA\_NA option contains the T1 and T2 fields, but an IA\_TA option does not. The DHCPv6 server uses T1 and T2 to control the time at which the client contacts with the server to extend the lifetimes on any addresses in the IA\_NA before the lifetimes expire. After T1, the client sends the server (S1) (from which the addresses in the IA\_NA were obtained) a Renew message. If the time T2 is reached and the server does not respond, the client sends a Rebind message to any available server (S2). For an IA\_TA, the client may send a Renew or Rebind message at the client's discretion.

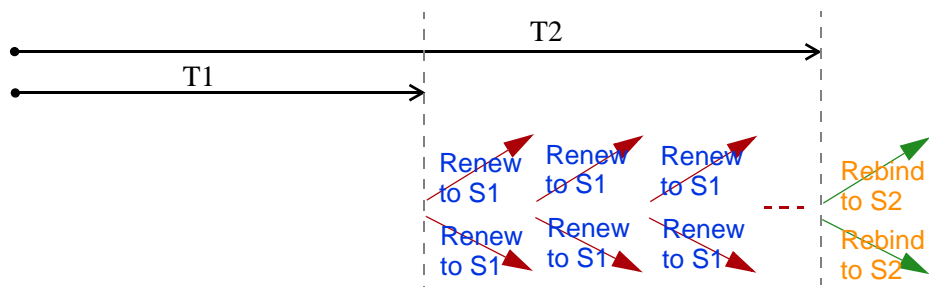

## DHCP Relay Agent

A DHCP relay agent is on the same network as the DHCP clients and helps forward messages between the DHCP server and clients. When a client cannot use its link-local address and a well-known multicast address to locate a DHCP server on its network, it then needs a DHCP relay agent to send a message to a DHCP server that is not attached to the same network.

The DHCP relay agent can add the remote identification (remote-ID) option and the interface-ID option to the Relay-Forward DHCPv6 messages. The remote-ID option carries a user-defined string, such as the system name. The interface-ID option provides slot number, port information and the VLAN ID to the DHCPv6 server. The remote-ID option (if any) is stripped from the Relay-Reply messages before the relay agent sends the packets to the clients. The DHCP server copies the interface-ID option from the Relay-Forward message into the Relay-Reply message and sends it to the relay agent. The interface-ID should not change even after the relay agent restarts.

## Prefix Delegation

Prefix delegation enables an IPv6 router to use the IPv6 prefix (network address) received from the ISP (or a connected uplink router) for its LAN. The NWA/WAC uses the received IPv6 prefix (for example, 2001:db2::/48) to generate its LAN IP address. Through sending Router Advertisements (RAs) regularly by multicast, the NWA/WAC passes the IPv6 prefix information to its LAN hosts. The hosts then can use the prefix to generate their IPv6 addresses.

## ICMPv6

Internet Control Message Protocol for IPv6 (ICMPv6 or ICMP for IPv6) is defined in RFC 4443. ICMPv6 has a preceding Next Header value of 58, which is different from the value used to identify ICMP for IPv4. ICMPv6 is an integral part of IPv6. IPv6 nodes use ICMPv6 to report errors encountered in packet processing and perform other diagnostic functions, such as "ping".

## Neighbor Discovery Protocol (NDP)

The Neighbor Discovery Protocol (NDP) is a protocol used to discover other IPv6 devices and track neighbor's reachability in a network. An IPv6 device uses the following ICMPv6 messages types:

- Neighbor solicitation: A request from a host to determine a neighbor's link-layer address (MAC address) and detect if the neighbor is still reachable. A neighbor being "reachable" means it responds to a neighbor solicitation message (from the host) with a neighbor advertisement message.
- Neighbor advertisement: A response from a node to announce its link-layer address.
- Router solicitation: A request from a host to locate a router that can act as the default router and forward packets.
- Router advertisement: A response to a router solicitation or a periodical multicast advertisement from a router to advertise its presence and other parameters.

## IPv6 Cache

An IPv6 host is required to have a neighbor cache, destination cache, prefix list and default router list. The NWA/WAC maintains and updates its IPv6 caches constantly using the information from response messages. In IPv6, the NWA/WAC configures a link-local address automatically, and then sends a neighbor solicitation message to check if the address is unique. If there is an address to be resolved or verified, the NWA/WAC also sends out a neighbor solicitation message. When the NWA/WAC receives a neighbor advertisement in response, it stores the neighbor's link-layer address in the neighbor cache. When the NWA/WAC uses a router solicitation message to query for a router and receives a router advertisement message, it adds the router's information to the neighbor cache, prefix list and destination cache. The NWA/WAC creates an entry in the default router list cache if the router can be used as a default router.

When the NWA/WAC needs to send a packet, it first consults the destination cache to determine the next hop. If there is no matching entry in the destination cache, the NWA/WAC uses the prefix list to determine whether the destination address is on-link and can be reached directly without passing through a router. If the address is onlink, the address is considered as the next hop. Otherwise, the NWA/WAC determines the next-hop from the default router list or routing table. Once the next hop IP address is known, the NWA/WAC looks into the neighbor cache to get the link-layer address and sends the packet when the neighbor is reachable. If the NWA/WAC cannot find an entry in the neighbor cache or the state for the neighbor is not reachable, it starts the address resolution process. This helps reduce the number of IPv6 solicitation and advertisement messages.

## Multicast Listener Discovery

The Multicast Listener Discovery (MLD) protocol (defined in RFC 2710) is derived from IPv4's Internet Group Management Protocol version 2 (IGMPv2). MLD uses ICMPv6 message types, rather than IGMP message types. MLDv1 is equivalent to IGMPv2 and MLDv2 is equivalent to IGMPv3.

MLD allows an IPv6 switch or router to discover the presence of MLD listeners who wish to receive multicast packets and the IP addresses of multicast groups the hosts want to join on its network.

MLD snooping and MLD proxy are analogous to IGMP snooping and IGMP proxy in IPv4.

MLD filtering controls which multicast groups a port can join.

## MLD Messages

A multicast router or switch periodically sends general queries to MLD hosts to update the multicast forwarding table. When an MLD host wants to join a multicast group, it sends an MLD Report message for that address.

An MLD Done message is equivalent to an IGMP Leave message. When an MLD host wants to leave a multicast group, it can send a Done message to the router or switch. The router or switch then sends a group-specific query to the port on which the Done message is received to determine if other devices connected to this port should remain in the group.

## Example - Enabling IPv6 on Windows XP/2003/Vista

By default, Windows XP and Windows 2003 support IPv6. This example shows you how to use the `ipv6 install` command on Windows XP/2003 to enable IPv6. This also displays how to use the `ipconfig` command to see auto-generated IP addresses.

```
C:\>ipv6 install
Installing...
Succeeded.

C:\>ipconfig

Windows IP Configuration

Ethernet adapter Local Area Connection:

    Connection-specific DNS Suffix  . :
    IP Address. . . . . : 10.1.1.46
    Subnet Mask . . . . . : 255.255.255.0
    IP Address. . . . . : fe80::2d0:59ff:feb8:103c%4
    Default Gateway . . . . . : 10.1.1.254
```

IPv6 is installed and enabled by default in Windows Vista. Use the `ipconfig` command to check your automatic configured IPv6 address as well. You should see at least one IPv6 address available for the interface on your computer.

## Example - Enabling DHCPv6 on Windows XP

Windows XP does not support DHCPv6. If your network uses DHCPv6 for IP address assignment, you have to additionally install a DHCPv6 client software on your Windows XP. (Note: If you use static IP addresses or Router Advertisement for IPv6 address assignment in your network, ignore this section.)

This example uses Dibbler as the DHCPv6 client. To enable DHCPv6 client on your computer:

- 1 Install Dibbler and select the DHCPv6 client option on your computer.
- 2 After the installation is complete, select **Start > All Programs > Dibbler-DHCPv6 > Client Install as service.**
- 3 Select **Start > Control Panel > Administrative Tools > Services.**
- 4 Double click **Dibbler - a DHCPv6 client.**

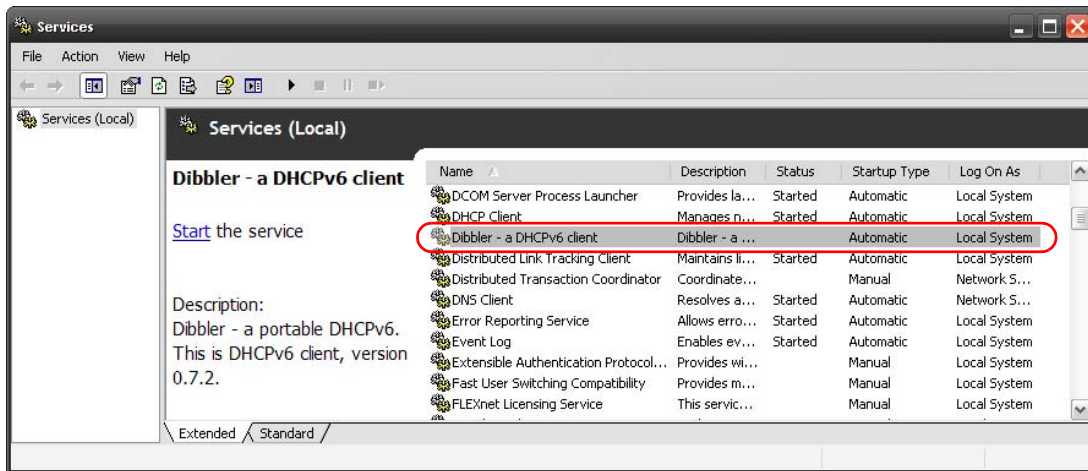

- 5 Click **Start** and then **OK**.

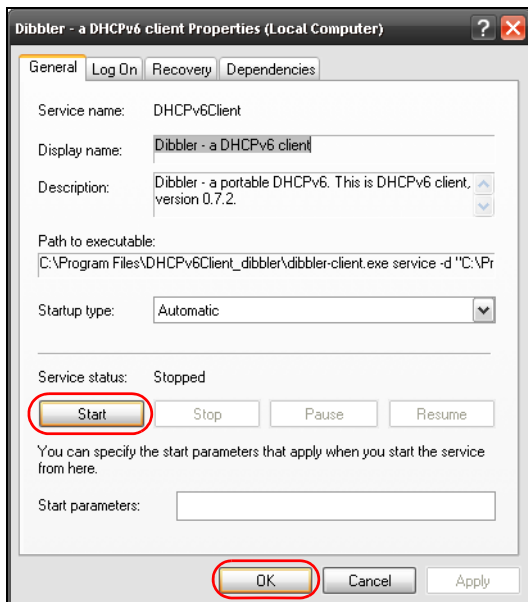

- 6 Now your computer can obtain an IPv6 address from a DHCPv6 server.

## Example - Enabling IPv6 on Windows 7

Windows 7 supports IPv6 by default. DHCPv6 is also enabled when you enable IPv6 on a Windows 7 computer.

To enable IPv6 in Windows 7:

- 1 Select **Control Panel > Network and Sharing Center > Local Area Connection**.
- 2 Select the **Internet Protocol Version 6 (TCP/IPv6)** checkbox to enable it.
- 3 Click **OK** to save the change.

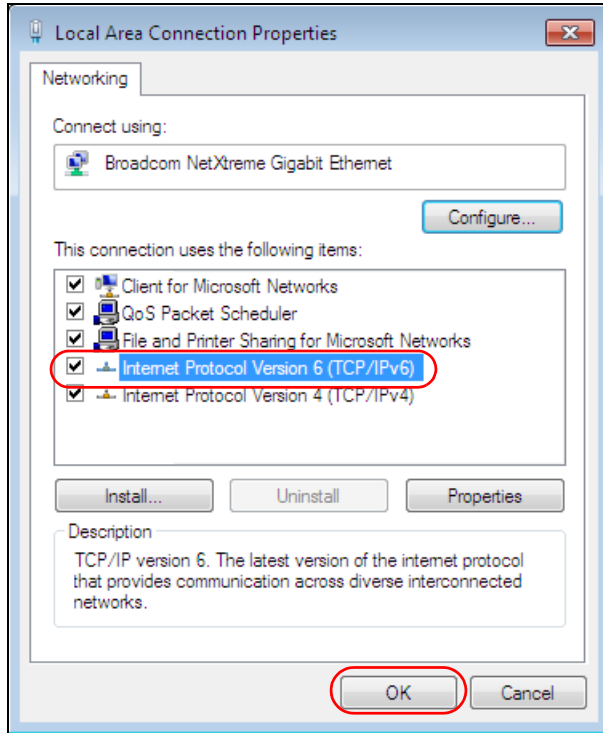

- 4 Click **Close** to exit the **Local Area Connection Status** screen.
- 5 Select **Start > All Programs > Accessories > Command Prompt**.
- 6 Use the `ipconfig` command to check your dynamic IPv6 address. This example shows a global address (2001:b021:2d::1000) obtained from a DHCP server.

```
C:\>ipconfig

Windows IP Configuration

Ethernet adapter Local Area Connection:

    Connection-specific DNS Suffix  . :
    IPv6 Address. . . . . : 2001:b021:2d::1000
    Link-local IPv6 Address . . . . . : fe80::25d8:dcab:c80a:5189%11
    IPv4 Address. . . . . : 172.16.100.61
    Subnet Mask . . . . . : 255.255.255.0
    Default Gateway . . . . . : fe80::213:49ff:feaa:7125%11
                                172.16.100.254
```

# APPENDIX C

## Customer Support

In the event of problems that cannot be solved by using this manual, you should contact your vendor. If you cannot contact your vendor, then contact a Zyxel office for the region in which you bought the device.

See <http://www.zyxel.com/homepage.shtml> and also [http://www.zyxel.com/about\\_zyxel/zyxel\\_worldwide.shtml](http://www.zyxel.com/about_zyxel/zyxel_worldwide.shtml) for the latest information.

Please have the following information ready when you contact an office.

### Required Information

- Product model and serial number.
- Warranty Information.
- Date that you received your device.
- Brief description of the problem and the steps you took to solve it.

### Corporate Headquarters (Worldwide)

#### Taiwan

- Zyxel Communications Corporation
- <http://www.zyxel.com>

### Asia

#### China

- Zyxel Communications (Shanghai) Corp.
- Zyxel Communications (Beijing) Corp.
- Zyxel Communications (Tianjin) Corp.
- <http://www.zyxel.cn>

#### India

- Zyxel Technology India Pvt Ltd
- <http://www.zyxel.in>

#### Kazakhstan

- Zyxel Kazakhstan
- <http://www.zyxel.kz>

## **Korea**

- Zyxel Korea Corp.
- <http://www.zyxel.kr>

## **Malaysia**

- Zyxel Malaysia Sdn Bhd.
- <http://www.zyxel.com.my>

## **Pakistan**

- Zyxel Pakistan (Pvt.) Ltd.
- <http://www.zyxel.com.pk>

## **Philippines**

- Zyxel Philippines
- <http://www.zyxel.com.ph>

## **Singapore**

- Zyxel Singapore Pte Ltd.
- <http://www.zyxel.com.sg>

## **Taiwan**

- Zyxel Communications Corporation
- <http://www.zyxel.com/tw/zh/>

## **Thailand**

- Zyxel Thailand Co., Ltd
- <http://www.zyxel.co.th>

## **Vietnam**

- Zyxel Communications Corporation-Vietnam Office
- <http://www.zyxel.com/vn/vi>

## **Europe**

### **Austria**

- Zyxel Deutschland GmbH
- <http://www.zyxel.de>

### **Belarus**

- Zyxel BY
- <http://www.zyxel.by>



## **Belgium**

- Zyxel Communications B.V.
- <http://www.zyxel.com/be/nl/>
- <http://www.zyxel.com/be/fr/>

## **Bulgaria**

- Zyxel България
- <http://www.zyxel.com/bg/bg/>

## **Czech Republic**

- Zyxel Communications Czech s.r.o
- <http://www.zyxel.cz>

## **Denmark**

- Zyxel Communications A/S
- <http://www.zyxel.dk>

## **Estonia**

- Zyxel Estonia
- <http://www.zyxel.com/ee/et/>

## **Finland**

- Zyxel Communications
- <http://www.zyxel.fi>

## **France**

- Zyxel France
- <http://www.zyxel.fr>

## **Germany**

- Zyxel Deutschland GmbH
- <http://www.zyxel.de>

## **Hungary**

- Zyxel Hungary & SEE
- <http://www.zyxel.hu>

## **Italy**

- Zyxel Communications Italy
- <http://www.zyxel.it/>

## Latvia

- Zyxel Latvia
- <http://www.zyxel.com/lv/lv/homepage.shtml>

## Lithuania

- Zyxel Lithuania
- <http://www.zyxel.com/lt/lt/homepage.shtml>

## Netherlands

- Zyxel Benelux
- <http://www.zyxel.nl>

## Norway

- Zyxel Communications
- <http://www.zyxel.no>

## Poland

- Zyxel Communications Poland
- <http://www.zyxel.pl>

## Romania

- Zyxel Romania
- <http://www.zyxel.com/ro/ro>

## Russia

- Zyxel Russia
- <http://www.zyxel.ru>

## Slovakia

- Zyxel Communications Czech s.r.o. organizacna zlozka
- <http://www.zyxel.sk>

## Spain

- Zyxel Communications ES Ltd
- <http://www.zyxel.es>

## Sweden

- Zyxel Communications
- <http://www.zyxel.se>

## Switzerland

- Studerus AG

- <http://www.zyxel.ch/>

### **Turkey**

- Zyxel Turkey A.S.
- <http://www.zyxel.com.tr>

### **UK**

- Zyxel Communications UK Ltd.
- <http://www.zyxel.co.uk>

### **Ukraine**

- Zyxel Ukraine
- <http://www.ua.zyxel.com>

## **Latin America**

### **Argentina**

- Zyxel Communication Corporation
- <http://www.zyxel.com/ec/es/>

### **Brazil**

- Zyxel Communications Brasil Ltda.
- <https://www.zyxel.com/br/pt/>

### **Ecuador**

- Zyxel Communication Corporation
- <http://www.zyxel.com/ec/es/>

## **Middle East**

### **Israel**

- Zyxel Communication Corporation
- <http://il.zyxel.com/homepage.shtml>

### **Middle East**

- Zyxel Communication Corporation
- <http://www.zyxel.com/me/en/>

## North America

### USA

- Zyxel Communications, Inc. - North America Headquarters
- <http://www.zyxel.com/us/en/>

## Oceania

### Australia

- Zyxel Communications Corporation
- <http://www.zyxel.com/au/en/>

## Africa

### South Africa

- Nology (Pty) Ltd.
- <http://www.zyxel.co.za>

# APPENDIX D

## Legal Information

### Copyright

Copyright © 2017 by Zyxel Communications Corporation.

The contents of this publication may not be reproduced in any part or as a whole, transcribed, stored in a retrieval system, translated into any language, or transmitted in any form or by any means, electronic, mechanical, magnetic, optical, chemical, photocopying, manual, or otherwise, without the prior written permission of Zyxel Communications Corporation.

Published by Zyxel Communications Corporation. All rights reserved.

### Disclaimers

Zyxel does not assume any liability arising out of the application or use of any products, or software described herein. Neither does it convey any license under its patent rights nor the patent rights of others. Zyxel further reserves the right to make changes in any products described herein without notice. This publication is subject to change without notice.

Your use of the NWA/WAC is subject to the terms and conditions of any related service providers.

### Trademarks

Trademarks mentioned in this publication are used for identification purposes only and may be properties of their respective owners.

### Regulatory Notice and Statement

#### UNITED STATES of AMERICA



The following information applies if you use the product within USA area.

#### FCC EMC Statement

- This device complies with part 15 of the FCC Rules. Operation is subject to the following two conditions:
  - (1) This device may not cause harmful interference, and
  - (2) this device must accept any interference received, including interference that may cause undesired operation.
- Changes or modifications not expressly approved by the party responsible for compliance could void the user's authority to operate the device.
- This product has been tested and complies with the specifications for a Class B digital device, pursuant to Part 15 of the FCC Rules. These limits are designed to provide reasonable protection against harmful interference in a residential installation. This device generates, uses, and can radiate radio frequency energy and, if not installed and used according to the instructions, may cause harmful interference to radio communications. However, there is no guarantee that interference will not occur in a particular installation.
- If this device does cause harmful interference to radio or television reception, which is found by turning the device off and on, the user is encouraged to try to correct the interference by one or more of the following measures:
  - Reorient or relocate the receiving antenna
  - Increase the separation between the devices
  - Connect the equipment to an outlet other than the receiver's
  - Consult a dealer or an experienced radio/TV technician for assistance

FCC Caution: Any changes or modifications not expressly approved by the party responsible for compliance could void the user's authority to operate this equipment.

#### FCC Radiation Exposure Statement

- This device complies with FCC RF radiation exposure limits set forth for an uncontrolled environment.
- This transmitter must be at least 20 cm from the user and must not be co-located or operating in conjunction with any other antenna or transmitter. This transmitter must be at least 22 cm (NWA5123-NI) from the user and must not be co-located or operating in conjunction with any other antenna or transmitter. This transmitter must be at least 30 cm (WAC6553D-E) from the user and must not be co-located or operating in conjunction with any other antenna or transmitter.
- Country Code selection feature to be disabled for products marketed to the US/CANADA.
- Operation of this device is restricted to indoor use only. (WAC6553D-E is a device for outdoor use.)

#### CANADA

The following information applies if you use the product within Canada area.

### Industry Canada ICES Statement

CAN ICES-3 (B)/NMB-3(B)

### Industry Canada RSS-GEN & RSS-247 Statement

- This device complies with Industry Canada license-exempt RSS standard(s). Operation is subject to the following two conditions: (1) this device may not cause interference, and (2) this device must accept any interference, including interference that may cause undesired operation of the device.
- This radio transmitter (2468C-NWA5123AC (NWA5123-AC, NWA1123-AC v2), 2468C-NWA5123ACHD (NWA5123-AC HD, NWA1123-AC HD), 2468C-NWA5123NI (NWA5123-NI), 2468C-WAC6502DE (WAC6502D-S, WAC6502D-E), 2468C-WAC6503DS (WAC6503D-S), 2468C-WAC6553DE (WAC6553D-E), 2468C-WAC6103DI (WAC6103D-I), 2468C-WAC5302DS (WAC5302D-S)) has been approved by Industry Canada to operate with the antenna types listed below with the maximum permissible gain and required antenna impedance for each antenna type indicated. Antenna types not included in this list, having a gain greater than the maximum gain indicated for that type, are strictly prohibited for use with this device.

Antenna Information

ANTENNA MODEL	NO.	TYPE	CONNECTOR	2.4 G GAIN	5G GAIN	REMARK
NWA5123-AC 2.4 GHz Antenna	1	PIFA	U.FL	3.08 (2400-2483.5 MHz)		
	2	PIFA	U.FL	3.07 (2400-2483.5 MHz)		
NWA5123-AC 5 GHz Antenna	3	PIFA	U.FL		4.06 (5150-5250 MHz) 3.91 (5725-5850 MHz)	
	4	PIFA	U.FL		3.99 (5150-5250 MHz) 3.79 (5725-5850 MHz)	
NWA5123-AC HD	1	PIFA	I-PEX	3 (2400-2483.5 MHz)		
NWA5123-AC HD	2	PIFA	I-PEX	3 (2400-2483.5 MHz)		
NWA5123-AC HD	3	Monopole	I-PEX		4 (5150-5250 MHz) 4 (5725-5850 MHz)	
NWA5123-AC HD	4	Monopole	I-PEX		4 (5150-5250 MHz) 4 (5725-5850 MHz)	
NWA5123-AC HD	5	Monopole	I-PEX		4 (5150-5250 MHz) 4 (5725-5850 MHz)	
NWA1123-AC HD	1	PIFA	I-PEX	3 (2400-2483.5 MHz)		
NWA1123-AC HD	2	PIFA	I-PEX	3 (2400-2483.5 MHz)		
NWA1123-AC HD	3	Monopole	I-PEX		4 (5150-5250 MHz) 4 (5725-5850 MHz)	
NWA1123-AC HD	4	Monopole	I-PEX		4 (5150-5250 MHz) 4 (5725-5850 MHz)	
NWA1123-AC HD	5	Monopole	I-PEX		4 (5150-5250 MHz) 4 (5725-5850 MHz)	
WAC6502D-E		Dipole	RSMA	5	7	
WAC6502D-S		Dipole	IPEX	4	6	
WAC6503D-S		Dipole	IPEX	4	6	
ZXL04-22008A		Dipole	N type	4.5	7	
SINBON / 2.4 G & 5 G Metal & PCB Antenna	1	PIFA	U.FL	3.28		Ceiling Mounted: Antenna 1, 2, 3  Wall Mounted: Antenna 1, 2, 4
	2	PIFA	U.FL	3.37		
	3	PIFA	U.FL	3.15		
	4	Dipole	U.FL	4.33		
	5	Loop	U.FL		4.38 (5150-5250 MHz) 4.23 (5725-5850 MHz)	Ceiling Mounted: Antenna 5, 6, 7  Wall Mounted: Antenna 5, 6, 8
	6	Loop	U.FL		4.31 (5150-5250 MHz) 4.22 (5725-5850 MHz)	
	7	Loop	U.FL		4.38 (5150-5250 MHz) 4.36 (5725-5850 MHz)	
	8	Dipole	U.FL		5.12 (5150-5250 MHz) 5.20 (5725-5850 MHz)	
81XCAL15.G01		Loop	I-PEX	5.82 (2400-2483.5 MHz)		
81XCAL15.G02		Loop	I-PEX	5.02 (2400-2483.5 MHz)		
AD751		PIFA	I-PEX		5 (5150-5250 MHz) 5 (5250-5350 MHz) 5 (5470-5725 MHz) 5 (5725-5850 MHz)	
A9701685		PCB	U.FL	4.0		
A9701686		PCB	U.FL	5.8		
A9701670		PCB	U.FL		5.2	
A9701671		PCB	U.FL		6.1	

If the product with 5G wireless function operating in 5150-5250 MHz and 5725-5850 MHz, the following attention must be paid,

- The device for operation in the band 5150-5250 MHz is only for indoor use to reduce the potential for harmful interference to co-channel mobile satellite systems.
- For devices with detachable antenna(s), the maximum antenna gain permitted for devices in the band 5725-5850 MHz shall be such that the equipment still complies with the e.i.r.p. limits specified for point-to-point and non-point-to-point operation as appropriate; and
- The worst-case tilt angle(s) necessary to remain compliant with the e.i.r.p. elevation mask requirement set forth in Section 6.2.2(3) of RSS 247 shall be clearly indicated.

If the product with 5G wireless function operating in 5250-5350 MHz and 5470-5725 MHz, the following attention must be paid.

- For devices with detachable antenna(s), the maximum antenna gain permitted for devices in the bands 5250-5350 MHz and 5470-5725 MHz shall be such that the equipment still complies with the e.i.r.p. limit.
- Le présent appareil est conforme aux CNR d'Industrie Canada applicables aux appareils radio exempts de licence. L'exploitation est autorisée aux deux conditions suivantes: (1) l'appareil ne doit pas produire de brouillage, et (2) l'utilisateur de l'appareil doit accepter tout brouillage radioélectrique subi, même si le brouillage est susceptible d'en compromettre le fonctionnement.
- Le présent émetteur radio (2468C-NWA5123AC (NWA5123-AC, NWA1123-AC v2), 2468C-NWA5123ACHD (NWA5123-AC HD, NWA1123-AC HD), 2468C-NWA5123NI (NWA5123-NI), 2468C-WAC6502DE (WAC6502D-S, WAC6502D-E), 2468C-WAC6503DS (WAC6503D-S), 2468C-WAC6553DE (WAC6553D-E), 2468C-WAC6103DI (WAC6103D-I), 2468C-WAC5302DS (WAC5302D-S)) de modèle s'il fait partie du matériel de catégorie) a été approuvé par Industrie Canada pour fonctionner avec les types d'antenne énumérés ci-dessous et ayant un gain admissible maximal et l'impédance requise pour chaque type d'antenne. Les types d'antenne non inclus dans cette liste, ou dont le gain est supérieur au gain maximal indiqué, sont strictement interdits pour l'exploitation de l'émetteur.



## Informations Antenne

MODÈLE D'ANTENNE	NB.	TYPE	CONNECTEUR	2.4 G GAIN	5G GAIN	REMARQUE
NWA5123-AC 2.4 GHz Antenna	1	PIFA	U.FL	3.08 (2400-2483.5 MHz)		
	2	PIFA	U.FL	3.07 (2400-2483.5 MHz)		
NWA5123-AC 5 GHz Antenna	3	PIFA	U.FL		4.06 (5150-5250 MHz) 3.91 (5725-5850 MHz)	
	4	PIFA	U.FL		3.99 (5150-5250 MHz) 3.79 (5725-5850 MHz)	
NWA5123-AC HD	1	PIFA	I-PEX	3 (2400-2483.5 MHz)		
NWA5123-AC HD	2	PIFA	I-PEX	3 (2400-2483.5 MHz)		
NWA5123-AC HD	3	Monopole	I-PEX		4 (5150-5250 MHz) 4 (5725-5850 MHz)	
NWA5123-AC HD	4	Monopole	I-PEX		4 (5150-5250 MHz) 4 (5725-5850 MHz)	
NWA5123-AC HD	5	Monopole	I-PEX		4 (5150-5250 MHz) 4 (5725-5850 MHz)	
NWA1123-AC HD	1	PIFA	I-PEX	3 (2400-2483.5 MHz)		
NWA1123-AC HD	2	PIFA	I-PEX	3 (2400-2483.5 MHz)		
NWA1123-AC HD	3	Monopole	I-PEX		4 (5150-5250 MHz) 4 (5725-5850 MHz)	
NWA1123-AC HD	4	Monopole	I-PEX		4 (5150-5250 MHz) 4 (5725-5850 MHz)	
NWA1123-AC HD	5	Monopole	I-PEX		4 (5150-5250 MHz) 4 (5725-5850 MHz)	
WAC6502D-E		Dipole	RSMA	5	7	
WAC6502D-S		Dipole	IPEX	4	6	
WAC6503D-S		Dipole	IPEX	4	6	
ZXL04-22008A		Dipole	N type	4.5	7	
SINBON / 2.4 G & 5 G Metal & PCB Antenna	1	PIFA	U.FL	3.28		Ceiling Mounted: Antenna 1, 2, 3
	2	PIFA	U.FL	3.37		
	3	PIFA	U.FL	3.15		
	4	Dipole	U.FL	4.33		Wall Mounted: Antenna 1, 2, 4
	5	Loop	U.FL		4.38 (5150-5250 MHz) 4.23 (5725-5850 MHz)	
	6	Loop	U.FL		4.31 (5150-5250 MHz) 4.22 (5725-5850 MHz)	
	7	Loop	U.FL		4.38 (5150-5250 MHz) 4.36 (5725-5850 MHz)	
	8	Dipole	U.FL		5.12 (5150-5250 MHz) 5.20 (5725-5850 MHz)	
81XCAL15.G01		Loop	I-PEX	5.82 (2400-2483.5 MHz)		
81XCAL15.G02		Loop	I-PEX	5.02 (2400-2483.5 MHz)		
AD751		PIFA	I-PEX		5 (5150-5250 MHz) 5 (5250-5350 MHz) 5 (5470-5725 MHz) 5 (5725-5850 MHz)	
A9701685		PCB	U.FL	4.0		
A9701686		PCB	U.FL	5.8		
A9701670		PCB	U.FL		5.2	
A9701671		PCB	U.FL		6.1	

Lorsque la fonction sans fil 5G fonctionnant en 5150-5250 MHz and 5725-5850 MHz est activée pour ce produit, il est nécessaire de porter une attention particulière aux choses suivantes

- Les dispositifs fonctionnant dans la bande 5150-5250 MHz sont réservés uniquement pour une utilisation à l'intérieur afin de réduire les risques de brouillage préjudiciable aux systèmes de satellites mobiles utilisant les mêmes canaux;
- Pour les dispositifs munis d'antennes amovibles, le gain maximal d'antenne permis (pour les dispositifs utilisant la bande de 5 725 à 5 850 MHz) doit être conforme à la limite de la p.i.r.e. spécifiée pour l'exploitation point à point et l'exploitation non point à point, selon le cas;

- Les pires angles d'inclinaison nécessaires pour rester conforme à l'exigence de la p.i.r.e. applicable au masque d'élévation, et énoncée à la section 6.2.2.3) du CNR-247, doivent être clairement indiqués.

Lorsque la fonction sans fil 5G fonctionnant en 5250-5350 MHz et 5470-5725 MHz est activée pour ce produit, il est nécessaire de porter une attention particulière aux choses suivantes.

- Pour les dispositifs munis d'antennes amovibles, le gain maximal d'antenne permis pour les dispositifs utilisant les bandes de 5 250 à 5 350 MHz et de 5 470 à 5 725 MHz doit être conforme à la limite de la p.i.r.e.

### Industry Canada radiation exposure statement

This equipment complies with IC radiation exposure limits set forth for an uncontrolled environment. This equipment should be installed and operated with a minimum distance of 20 cm between the radiator and your body.

This equipment complies with IC radiation exposure limits set forth for an uncontrolled environment. This equipment should be installed and operated with a minimum distance of 22cm (NWA5123-NI, NWA5123-AC HD, NWA1123-AC HD) between the radiator and your body.

This equipment complies with IC radiation exposure limits set forth for an uncontrolled environment. This equipment should be installed and operated with a minimum distance of 30 cm (WAC6553D-E) between the radiator and your body.

### Déclaration d'exposition aux radiations:

Cet équipement est conforme aux limites d'exposition aux rayonnements IC établies pour un environnement non contrôlé. Cet équipement doit être installé et utilisé avec un minimum de 20 cm de distance entre la source de rayonnement et votre corps.

Cet équipement est conforme aux limites d'exposition aux rayonnements IC établies pour un environnement non contrôlé. Cet équipement doit être installé et utilisé avec un minimum de 22 cm (NWA5123-NI, NWA5123-AC HD, NWA1123-AC HD) de distance entre la source de rayonnement et votre corps.

Cet équipement est conforme aux limites d'exposition aux rayonnements IC établies pour un environnement non contrôlé. Cet équipement doit être installé et utilisé avec un minimum de 30 cm (WAC6553D-E) de distance entre la source de rayonnement et votre corps.

### Caution:

- (i) the device for operation in the band 5150-5250 MHz is only for indoor use to reduce the potential for harmful interference to co-channel mobile satellite systems;
- (ii) the maximum antenna gain permitted for devices in the bands 5250-5350 MHz and 5470-5725 MHz shall comply with the e.i.r.p. limit; and
- (iii) the maximum antenna gain permitted for devices in the band 5725-5825 MHz shall comply with the e.i.r.p. limits specified for point-to-point and non point-to-point operation as appropriate.
- (iv) Users should also be advised that high-power radars are allocated as primary users (i.e. priority users) of the bands 5250-5350 MHz and 5650-5850 MHz and that these radars could cause interference and/or damage to LE-LAN devices.
- (v) WAC6553D-E is an outdoor device and only uses 5G Band 4 (5725-5850 MHz).

### Avertissement:

- (i) les dispositifs fonctionnant dans la bande 5150-5250 MHz sont réservés uniquement pour une utilisation à l'intérieur afin de réduire les risques de brouillage préjudiciable aux systèmes de satellites mobiles utilisant les mêmes canaux;
- (ii) le gain maximal d'antenne permis pour les dispositifs utilisant les bandes 5250-5350 MHz et 5 470-5 725 MHz doit se conformer à la limite de p.i.r.e.;
- (iii) le gain maximal d'antenne permis (pour les dispositifs utilisant la bande 5725-5825 MHz) doit se conformer à la limite de p.i.r.e. spécifiée pour l'exploitation point à point et non point à point, selon le cas.
- (iv) De plus, les utilisateurs devraient aussi être avisés que les utilisateurs de radars de haute puissance sont désignés utilisateurs principaux (c.-à-d., qu'ils ont la priorité) pour les bandes 5250-5350 MHz et 5650-5850 MHz et que ces radars pourraient causer du brouillage et/ou des dommages aux dispositifs LAN-EL.
- (v) WAC6553D-E est un appareil extérieur et seulement utilise 5G Bane 4 (5725-5850 MHz).

## EUROPEAN UNION



The following information applies if you use the product within the European Union.

### Declaration of Conformity with Regard to EU Directive 2014/53/EU (Radio Equipment Directive, RED)

- Compliance information for 2.4GHz and/or 5GHz wireless products relevant to the EU and other Countries following the EU Directive 2014/53/EU (RED). And this product may be used in all EU countries (and other countries following the EU Directive 2014/53/EU) without any limitation except for the countries mentioned below table:
- In the majority of the EU and other European countries, the 5GHz bands have been made available for the use of wireless local area networks (LANs). Later in this document you will find an overview of countries in which additional restrictions or requirements or both are applicable. The requirements for any country may evolve. Zyxel recommends that you check with the local authorities for the latest status of their national regulations for the 5GHz wireless LANs.
- If this device for operation in the band 5150-5350 MHz, it is for indoor use only.

#### NWA5123-AC

- This equipment should be installed and operated with a minimum distance of 20 cm between the radio equipment and your body.
- The maximum RF power operating for each band as follows:
  - The band 2,400 to 2,483.5 MHz is 97.95 mW,
  - The bands 5,150 MHz to 5,350 MHz is 199.07 mW,

- The 5,470 MHz to 5,725 MHz is 743.02 mW.

**NWA1123-ACv2**

- This equipment should be installed and operated with a minimum distance of 20 cm between the radio equipment and your body.
- The maximum RF power operating for each band as follows:
  - The band 2,400 to 2,483.5 MHz is 97.95 mW,
  - The bands 5,150 MHz to 5,350 MHz is 199.07 mW,
  - The 5,470 MHz to 5,725 MHz is 743.02 mW.

**NWA5121-N**

- This equipment should be installed and operated with a minimum distance of 20 cm between the radio equipment and your body.
- The maximum RF power operating for each band as follows:
  - The band 2,400 to 2,483.5 MHz is 84.72 mW,

**NWA5123-NI**

- This equipment should be installed and operated with a minimum distance of 20 cm between the radio equipment and your body.
- The maximum RF power operating for each band as follows:
  - The band 2,400 to 2,483.5 MHz is 90.99 mW,
  - The bands 5,150 MHz to 5,350 MHz is 183.65 mW,
  - The 5,470 MHz to 5,725 MHz is 558.47 mW.

**NWA5301-NJ**

- This equipment should be installed and operated with a minimum distance of 20 cm between the radio equipment and your body.
- The maximum RF power operating for each band as follows:
  - The band 2,400 to 2,483.5 MHz is 90.57 mW,

**WAC6503D-S**

- This equipment should be installed and operated with a minimum distance of 20 cm between the radio equipment and your body.
- The maximum RF power operating for each band as follows:
  - The band 2,400 to 2,483.5 MHz is 99.54 mW,
  - The bands 5,150 MHz to 5,350 MHz is 183.65 mW,
  - The 5,470 MHz to 5,725 MHz is 941.89 mW.

**WAC6502D-S**

- This equipment should be installed and operated with a minimum distance of 20 cm between the radio equipment and your body.
- The maximum RF power operating for each band as follows:
  - The band 2,400 to 2,483.5 MHz is 94.19 mW,
  - The bands 5,150 MHz to 5,350 MHz is 194.98 mW,
  - The 5,470 MHz to 5,725 MHz is 986.28 mW.

**WAC6502D-E**

- This equipment should be installed and operated with a minimum distance of 20 cm between the radio equipment and your body.
- The maximum RF power operating for each band as follows:
  - The band 2,400 to 2,483.5 MHz is 94.19 mW,
  - The bands 5,150 MHz to 5,350 MHz is 194.98 mW,
  - The 5,470 MHz to 5,725 MHz is 986.28 mW.

**WAC6553D-E**

- This equipment should be installed and operated with a minimum distance of 20 cm between the radio equipment and your body.
- The maximum RF power operating for each band as follows:
  - The band 2,400 to 2,483.5 MHz is 92.26 mW,
  - The bands 5,150 MHz to 5,350 MHz is 198.61 mW,
  - The 5,470 MHz to 5,725 MHz is 995.41 mW.

**WAC6103D-I**

- This equipment should be installed and operated with a minimum distance of 20 cm between the radio equipment and your body.
- The maximum RF power operating for each band as follows:
  - The band 2,400 to 2,483.5 MHz is 92.68 mW,
  - The bands 5,150 MHz to 5,350 MHz is 192.75 mW,
  - The 5,470 MHz to 5,725 MHz is 966.05 mW.

**WAC5302D-S**

- This equipment should be installed and operated with a minimum distance of 20 cm between the radio equipment and your body.
- The maximum RF power operating for each band as follows:
  - The band 2,400 to 2,483.5 MHz is 93.33 mW,
  - The bands 5,150 MHz to 5,350 MHz is 192.31 mW,
  - The 5,470 MHz to 5,725 MHz is 391.74 mW.

**NWA1123-AC PRO**

- This equipment should be installed and operated with a minimum distance of 20 cm between the radio equipment and your body.
- The maximum RF power operating for each band as follows:
  - The band 2,400 to 2,483.5 MHz is 92.68 mW,
  - The bands 5,150 MHz to 5,350 MHz is 192.75 mW,
  - The 5,470 MHz to 5,725 MHz is 966.05 mW.

**NWA1123-AC HD**

- This equipment should be installed and operated with a minimum distance of 20 cm between the radio equipment and your body.
- The maximum RF power operating for each band as follows:
  - The band 2,400 to 2,483.5 MHz is 97.274 mW,
  - The bands 5,150 MHz to 5,350 MHz is 198.61 mW,
  - The 5,470 MHz to 5,725 MHz is 995.40 mW.

**NWA5123-AC HD**

- This equipment should be installed and operated with a minimum distance of 20 cm between the radio equipment and your body.
- The maximum RF power operating for each band as follows:
  - The band 2,400 to 2,483.5 MHz is 97.274 mW,
  - The bands 5,150 MHz to 5,350 MHz is 198.61 mW,
  - The 5,470 MHz to 5,725 MHz is 995.40 mW.

Български (Bulgarian)	<p>С настоящото Zyxel декларира, че това оборудване е в съответствие със съществените изисквания и другите приложими разпоредбите на Директива 2014/53/EC.</p> <p><b>National Restrictions</b></p> <ul style="list-style-type: none"> <li>• The Belgian Institute for Postal Services and Telecommunications (BIPT) must be notified of any outdoor wireless link having a range exceeding 300 meters. Please check <a href="http://www.bipt.be">http://www.bipt.be</a> for more details.</li> <li>• Draadloze verbindingen voor buitengebruik en met een reikwijdte van meer dan 300 meter dienen aangemeld te worden bij het Belgisch Instituut voor postdiensten en telecommunicatie (BIPT). Zie <a href="http://www.bipt.be">http://www.bipt.be</a> voor meer gegevens.</li> <li>• Les liaisons sans fil pour une utilisation en extérieur d'une distance supérieure à 300 mètres doivent être notifiées à l'Institut Belge des services Postaux et des Télécommunications (IBPT). Visitez <a href="http://www.ibpt.be">http://www.ibpt.be</a> pour de plus amples détails.</li> </ul>
Español (Spanish)	<p>Por medio de la presente Zyxel declara que el equipo cumple con los requisitos esenciales y cualesquiera otras disposiciones aplicables o exigibles de la Directiva 2014/53/UE..</p>
Čeština (Czech)	<p>Zyxel tímto prohlašuje, že tento zařizení je ve shodě se základními požadavky a dalšími příslušnými ustanoveními směrnice 2014/53/EU.</p>
Dansk (Danish)	<p>Undertegnede Zyxel erklærer herved, at følgende udstyr overholder de væsentlige krav og øvrige relevante krav i direktiv 2014/53/EU.</p> <p><b>National Restrictions</b></p> <ul style="list-style-type: none"> <li>• In Denmark, the band 5150 - 5350 MHz is also allowed for outdoor usage.</li> <li>• I Danmark må frekvensbåndet 5150 - 5350 også anvendes udendørs.</li> </ul>
Deutsch (German)	<p>Hiermit erklärt Zyxel, dass sich das Gerät Ausstattung in Übereinstimmung mit den grundlegenden Anforderungen und den übrigen einschlägigen Bestimmungen der Richtlinie 2014/53/EU befindet.</p>
Eesti keel (Estonian)	<p>Käesolevaga kinnitab Zyxel seadme seadmed vastavust direktiivi 2014/53/EU põhinõuetele ja nimetatud direktiivist tulenevatele teistele asjakohastele sätetele.</p>
Ελληνικά (Greek)	<p>ΜΕ ΤΗΝ ΠΑΡΟΥΣΑ Zyxel ΔΗΛΩΝΕΙ ΟΤΙ ΕΞΟΥΛΙΣΜΟΣ ΣΥΜΜΟΡΦΩΝΕΤΑΙ ΠΡΟΣ ΤΙΣ ΟΥΣΙΩΔΕΙΣ ΑΠΑΙΤΗΣΕΙΣ ΚΑΙ ΤΙΣ ΛΟΙΠΕΣ ΣΧΕΤΙΚΕΣ ΔΙΑΤΑΞΕΙΣ ΤΗΣ ΟΔΗΓΙΑΣ 2014/53/EU.</p>
English	<p>Hereby, Zyxel declares that this device is in compliance with the essential requirements and other relevant provisions of Directive 2014/53/EU.</p>
Français (French)	<p>Par la présente Zyxel déclare que l'appareil équipements est conforme aux exigences essentielles et aux autres dispositions pertinentes de la directive 2014/53/EU.</p>
Hrvatski (Croatian)	<p>Zyxel ovime izjavljuje da je radijska oprema tipa u skladu s Direktivom 2014/53/EU.</p>
Íslenska (Icelandic)	<p>Hér með lýsir, Zyxel því yfir að þessi búnaður er í samræmi við grunnkröfur og önnur viðeigandi ákvæði tilskipunar 2014/53/EU.</p>
Italiano (Italian)	<p>Con la presente Zyxel dichiara che questo attrezzatura è conforme ai requisiti essenziali ed alle altre disposizioni pertinenti stabilite dalla direttiva 2014/53/EU.</p> <p><b>National Restrictions</b></p> <ul style="list-style-type: none"> <li>• This product meets the National Radio Interface and the requirements specified in the National Frequency Allocation Table for Italy. Unless this wireless LAN product is operating within the boundaries of the owner's property, its use requires a "general authorization." Please check <a href="http://www.sviluppoeconomico.gov.it/">http://www.sviluppoeconomico.gov.it/</a> for more details.</li> <li>• Questo prodotto è conforme alle specifiche di Interfaccia Radio Nazionali e rispetta il Piano Nazionale di ripartizione delle frequenze in Italia. Se non viene installato all'interno del proprio fondo, l'utilizzo di prodotti Wireless LAN richiede una "Autorizzazione Generale". Consultare <a href="http://www.sviluppoeconomico.gov.it/">http://www.sviluppoeconomico.gov.it/</a> per maggiori dettagli.</li> </ul>
Latviešu valoda (Latvian)	<p>Ar šo Zyxel deklarē, ka iekārtas atbilst Direktīvas 2014/53/EU būtiskajām prasībām un to saistītajiem noteikumiem.</p> <p><b>National Restrictions</b></p> <ul style="list-style-type: none"> <li>• The outdoor usage of the 2.4 GHz band requires an authorization from the Electronic Communications Office. Please check <a href="http://www.esd.lv">http://www.esd.lv</a> for more details.</li> <li>• 2.4 GHz frekvenču joslas izmantošanai ārpus telpām nepieciešama atļauja no Elektronisko sakaru direkcijas. Vairāk informācijas: <a href="http://www.esd.lv">http://www.esd.lv</a>.</li> </ul>
Lietuvių kalba (Lithuanian)	<p>Šiuo Zyxel deklaruoja, kad šis įranga atitinka esminius reikalavimus ir kitas 2014/53/EU Direktyvos nuostatas.</p>
Magyar (Hungarian)	<p>Alulírott, Zyxel nyilatkozom, hogy a berendezés megfelel a vonatkozó alapvető követelményeknek és az 2014/53/EU irányelv egyéb előírásainak.</p>
Malti (Maltese)	<p>Hawnhekk, Zyxel, jiddikjara li dan tagħmir jikkonforma mal-ftiġijiet essenzjali u ma provvedimenti oħrajn rilevanti li hemm fid-Direttiva 2014/53/EU.</p>
Nederlands (Dutch)	<p>Hierbij verklaart Zyxel dat het toestel uitrusting in overeenstemming is met de essentiële eisen en de andere relevante bepalingen van richtlijn 2014/53/EU.</p>

Polski (Polish)	Niniejszym Zyxel oświadcza, że sprzęt jest zgodny z zasadniczymi wymogami oraz pozostałymi stosownymi postanowieniami Dyrektywy 2014/53/EU.
Português (Portuguese)	Zyxel declara que este equipamento está conforme com os requisitos essenciais e outras disposições da Directiva 2014/53/EU.
Română (Romanian)	Prin prezenta, Zyxel declară că acest echipament este în conformitate cu cerințele esențiale și alte prevederi relevante ale Directivei 2014/53/EU.
Slovenčina (Slovak)	Zyxel týmto vyhlasuje, že zariadenia spĺňa základné požiadavky a všetky príslušné ustanovenia Smernice 2014/53/EU.
Slovenščina (Slovene)	Zyxel izjavlja, da je ta oprema v skladu z bistvenimi zahtevami in ostalimi relevantnimi določili direktive 2014/53/EU.
Suomi (Finnish)	Zyxel vakuuttaa täten että laitteet tyyppinen laite on direktiivin 2014/53/EU oleellisten vaatimusten ja sitä koskevien direktiivin muiden ehtojen mukainen.
Svenska (Swedish)	Härmed intygar Zyxel att denna utrustning står i överensstämmelse med de väsentliga egenskapskrav och övriga relevanta bestämmelser som framgår av direktiv 2014/53/EU.
Norsk (Norwegian)	Erklærer herved Zyxel at dette utstyret er i samsvar med de grunnleggende kravene og andre relevante bestemmelser i direktiv 2014/53/EU.

**Notes:**

1. Although Norway, Switzerland and Liechtenstein are not EU member states, the EU Directive 2014/53/EU has also been implemented in those countries.
2. The regulatory limits for maximum output power are specified in EIRP. The EIRP level (in dBm) of a device can be calculated by adding the gain of the antenna used (specified in dBi) to the output power available at the connector (specified in dBm).

**List of national codes**

COUNTRY	ISO 3166 2 LETTER CODE	COUNTRY	ISO 3166 2 LETTER CODE
Austria	AT	Liechtenstein	LI
Belgium	BE	Lithuania	LT
Bulgaria	BG	Luxembourg	LU
Croatia	HR	Malta	MT
Cyprus	CY	Netherlands	NL
Czech Republic	CR	Norway	NO
Denmark	DK	Poland	PL
Estonia	EE	Portugal	PT
Finland	FI	Romania	RO
France	FR	Serbia	RS
Germany	DE	Slovakia	SK
Greece	GR	Slovenia	SI
Hungary	HU	Spain	ES
Iceland	IS	Sweden	SE
Ireland	IE	Switzerland	CH
Italy	IT	Turkey	TR
Latvia	LV	United Kingdom	GB

**Professional installation instruction (WAC6553D-E)**

Please be advised that due to the unique function supplied by this product, the device is intended for use with our interactive entertainment software and licensed third-party only. The product will be distributed through controlled distribution channel and installed by trained professional and will not be sold directly to the general public through retail store.

- 1 Installation personal  
This product is designed for specific application and needs to be installed by a qualified personal who has RF and related rule knowledge. The general user shall not attempt to install or change the setting.
- 2 Installation location  
The product shall be installed at a location where the radiating antenna can be kept 30 cm from nearby person in normal operation condition to meet regulatory RF exposure requirement.
- 3 External antenna  
Use only the antennas which have been approved by Zyxel Communications Corporation. The non-approved antenna(s) may produce unwanted spurious or excessive RF transmitting power which may lead to the violation of FCC/IC limit and is prohibited.
- 4 Installation procedure

Please refer to user's manual for the detail.

5 Warning

Please carefully select the installation position and make sure that the final output power does not exceed the limit set force in relevant rules. The violation of the rule could lead to serious federal penalty.

## Instructions d'installation professionnelle (WAC6553D-E)

Veillez noter que l'appareil étant dédié à une fonction unique, il doit être utilisé avec notre logiciel propriétaire de divertissement interactif. Ce produit sera proposé par un réseau de distribution contrôlé et installé par des professionnels; il ne sera pas proposé au grand public par le réseau de la grande distribution.

1 Installation

Ce produit est destiné à un usage spécifique et doit être installé par un personnel qualifié maîtrisant les radiofréquences et les règles s'y rapportant. L'installation et les réglages ne doivent pas être modifiés par l'utilisateur final.

2 Emplacement d'installation

En usage normal, afin de respecter les exigences réglementaires concernant l'exposition aux radiofréquences, ce produit doit être installé de façon à respecter une distance de 30 cm entre l'antenne émettrice et les personnes.

3 Antenne externe.

Utiliser uniquement les antennes approuvées par le fabricant. L'utilisation d'autres antennes peut conduire à un niveau de rayonnement essentiel ou non essentiel dépassant les niveaux limites définis par FCC/IC, ce qui est interdit.

4 Procédure d'installation

Consulter le manuel d'utilisation.

5 Avertissement

Choisir avec soin la position d'installation et s'assurer que la puissance de sortie ne dépasse pas les limites en vigueur. La violation de cette règle peut conduire à de graves pénalités fédérales.

## Safety Warnings

- Do not use this product near water, for example, in a wet basement or near a swimming pool.
- Do not expose your device to dampness, dust or corrosive liquids.
- Do not store things on the device.
- Do not obstruct the device ventilation slots as insufficient airflow may harm your device. For example, do not place the device in an enclosed space such as a box or on a very soft surface such as a bed or sofa.
- Do not install, use, or service this device during a thunderstorm. There is a remote risk of electric shock from lightning.
- Connect ONLY suitable accessories to the device.
- Do not open the device or unit. Opening or removing covers can expose you to dangerous high voltage points or other risks. ONLY qualified service personnel should service or disassemble this device. Please contact your vendor for further information.
- Make sure to connect the cables to the correct ports.
- Place connecting cables carefully so that no one will step on them or stumble over them.
- Always disconnect all cables from this device before servicing or disassembling.
- Do not remove the plug and connect it to a power outlet by itself; always attach the plug to the power adaptor first before connecting it to a power outlet.
- Do not allow anything to rest on the power adaptor or cord and do NOT place the product where anyone can walk on the power adaptor or cord.
- Please use the provided or designated connection cables/power cables/adaptors. Connect it to the right supply voltage (for example, 110V AC in North America or 230V AC in Europe). If the power adaptor or cord is damaged, it might cause electrocution. Remove it from the device and the power source, repairing the power adapter or cord is prohibited. Contact your local vendor to order a new one.
- Do not use the device outside, and make sure all the connections are indoors. There is a remote risk of electric shock from lightning.
- CAUTION: Risk of explosion if battery is replaced by an incorrect type, dispose of used batteries according to the instruction. Dispose them at the applicable collection point for the recycling of electrical and electronic devices. For detailed information about recycling of this product, please contact your local city office, your household waste disposal service or the store where you purchased the product.
- The following warning statements apply, where the disconnect device is not incorporated in the device or where the plug on the power supply cord is intended to serve as the disconnect device.
  - For permanently connected devices, a readily accessible disconnect device shall be incorporated external to the device;
  - For pluggable devices, the socket-outlet shall be installed near the device and shall be easily accessible.

## Environment statement

### ErP (Energy-related Products)

Zyxel products put on the EU market in compliance with the requirement of the European Parliament and the Council published Directive 2009/125/EC establishing a framework for the setting of ecodesign requirements for energy-related products (recast), so called as "ErP Directive (Energy-related Products directive) as well as ecodesign requirement laid down in applicable implementing measures, power consumption has satisfied regulation requirements which are:

Network standby power consumption < 8W, and/or

Off mode power consumption < 0.5W, and/or

Standby mode power consumption < 0.5W.

For wireless setting, please refer to [Chapter 7 on page 84](#) chapter for more detail.

### European Union - Disposal and Recycling Information

The symbol below means that according to local regulations your product and/or its battery shall be disposed of separately from domestic waste. If this product is end of life, take it to a recycling station designated by local authorities. At the time of disposal, the separate collection of your product and/or its battery will help save natural resources and ensure that the environment is sustainable development.

Die folgende Symbol bedeutet, dass Ihr Produkt und/oder seine Batterie gemäß den örtlichen Bestimmungen getrennt vom Hausmüll entsorgt werden muss. Wenden Sie sich an eine Recyclingstation, wenn dieses Produkt das Ende seiner Lebensdauer erreicht hat. Zum Zeitpunkt der

Entsorgung wird die getrennte Sammlung von Produkt und/oder seiner Batterie dazu beitragen, natürliche Ressourcen zu sparen und die Umwelt und die menschliche Gesundheit zu schützen.

El símbolo de abajo indica que según las regulaciones locales, su producto y/o su batería deberán depositarse como basura separada de la doméstica. Cuando este producto alcance el final de su vida útil, llévelo a un punto limpio. Cuando llegue el momento de desechar el producto, la recogida por separado éste y/o su batería ayudará a salvar los recursos naturales y a proteger la salud humana y medioambiental.

Le symbole ci-dessous signifie que selon les réglementations locales votre produit et/ou sa batterie doivent être éliminés séparément des ordures ménagères. Lorsque ce produit atteint sa fin de vie, amenez-le à un centre de recyclage. Au moment de la mise au rebut, la collecte séparée de votre produit et/ou de sa batterie aidera à économiser les ressources naturelles et protéger l'environnement et la santé humaine.

Il simbolo sotto significa che secondo i regolamenti locali il vostro prodotto e/o batteria deve essere smaltito separatamente dai rifiuti domestici. Quando questo prodotto raggiunge la fine della vita di servizio portarlo a una stazione di riciclaggio. Al momento dello smaltimento, la raccolta separata del vostro prodotto e/o della sua batteria aiuta a risparmiare risorse naturali e a proteggere l'ambiente e la salute umana.

Symbolen innebär att enligt lokal lagstiftning ska produkten och/eller dess batteri kastas separat från hushållsavfallet. När den här produkten når slutet av sin livslängd ska du ta den till en återvinningsstation. Vid tiden för kasseringen bidrar du till en bättre miljö och mänsklig hälsa genom att göra dig av med den på ett återvinningsställe.



台灣



以下訊息僅適用於產品銷售至台灣地區

第十二條 經型式認證合格之低功率射頻電機，非經許可，公司，商號或使用者均不得擅自變更頻率、加大功率或變更原設計之特性及功能。

第十四條 低功率射頻電機之使用不得影響飛航安全及干擾合法通信；經發現有干擾現象時，應立即停用，並改善至無干擾時方得繼續使用。前項合法通信，指依電信法規規定作業之無線電通信。低功率射頻電機須忍受合法通信或工業、科學及醫療用電波輻射性電機設備之干擾。

- 電磁波曝露量 MPE 標準值 1mW/cm2，送測產品 (NWA5123-AC) 實測值為：0.316 mW/cm2 本產品使用時建議應距離人體 20 cm
- 電磁波曝露量 MPE 標準值 1mW/cm2，送測產品 (NWA1123-ACv2) 實測值為：0.316 mW/cm2 本產品使用時建議應距離人體 20 cm
- 電磁波曝露量 MPE 標準值 1mW/cm2，送測產品 (NWA5121-N) 實測值為：0.218 mW/cm2 本產品使用時建議應距離人體 20 cm
- 電磁波曝露量 MPE 標準值 1mW/cm2，送測產品 (NWA5123-NI) 實測值為：0.916 mW/cm2 本產品使用時建議應距離人體 22 cm
- 電磁波曝露量 MPE 標準值 1mW/cm2，送測產品 (NWA5301-NJ) 實測值為：0.122 mW/cm2 本產品使用時建議應距離人體 20 cm
- 電磁波曝露量 MPE 標準值 1mW/cm2，送測產品 (WAC6503D-S) 實測值為：0.744 mW/cm2 本產品使用時建議應距離人體 20 cm
- 電磁波曝露量 MPE 標準值 1mW/cm2，送測產品 (WAC6502D-S) 實測值為：0.320 mW/cm2 本產品使用時建議應距離人體 20 cm
- 電磁波曝露量 MPE 標準值 1mW/cm2，送測產品 (WAC6502D-E) 實測值為：0.403 mW/cm2 本產品使用時建議應距離人體 20 cm
- 電磁波曝露量 MPE 標準值 1mW/cm2，送測產品 (WAC6553D-E) 實測值為：0.539 mW/cm2 本產品使用時建議應距離人體 30 cm
- 電磁波曝露量 MPE 標準值 1mW/cm2，送測產品 (WAC6103D-I) 實測值為：0.448 mW/cm2 本產品使用時建議應距離人體 20 cm
- 電磁波曝露量 MPE 標準值 1mW/cm2，送測產品 (WAC5302D-S) 實測值為：0.109 mW/cm2 本產品使用時建議應距離人體 20 cm
- 電磁波曝露量 MPE 標準值 1mW/cm2，送測產品 (NWA1123-AC PRO) 實測值為：0.448 mW/cm2 本產品使用時建議應距離人體 20 cm
- 電磁波曝露量 MPE 標準值 1mW/cm2，送測產品 (NWA1123-AC HD) 實測值為：0.685 mW/cm2 本產品使用時建議應距離人體 20 cm
- 電磁波曝露量 MPE 標準值 1mW/cm2，送測產品 (NWA5123-AC HD) 實測值為：0.685 mW/cm2 本產品使用時建議應距離人體 20 cm
- 電磁波曝露量 MPE 標準值 1mW/cm2，送測產品 (WAC6303D-S) 實測值為：0.349 mW/cm2 本產品使用時建議應距離人體 20 cm

802.11a 警語：

無線傳輸設備 (UNII)

以下訊息僅適用於產品操作於 5.25-5.35 赫赫頻帶內並銷售至台灣地區

在 5.25-5.35 赫赫頻帶內操作之無線資訊傳輸設備，限於室內使用。(4.7.5)

無線資訊傳輸設備須忍受合法通信之干擾且不得干擾合法通信；如造成干擾，應立即停用，俟無干擾之虞，始得繼續使用。(4.7.6)

無線資訊傳輸設備的製造廠商應確保頻率穩定性，如依製造廠商使用手冊上所述正常操作，發射的信號應維持於操作頻帶中。(4.7.7)

無線資訊傳輸設備必須具備安全功能，以保護未經授權之一方任意更改軟體進而避免發射機操作於非經認證之頻率、輸出功率、調變形式或其他射頻參數設定。

**專業安裝警語：(WAC6553D-E)**

以下訊息僅適用於產品屬於專業安裝並銷售至台灣地區  
本器材須經專業工程人員安裝及設定，始得設置使用，且不得直接販售給一般消費者。

**安全警告**





為了您的安全，請先閱讀以下警告及指示：

- 請勿將此產品接近水、火焰或放置在高溫的環境。
- 避免設備接觸任何液體 - 切勿讓設備接觸水、雨水、高濕度、污水腐蝕性的液體或其他水份。
- 灰塵及污物 - 切勿接觸灰塵、污物、沙土、食物或其他不合適的材料。
- 雷雨天氣時，不要安裝，使用或維修此設備。有遭受電擊的風險。
- 切勿重摔或撞擊設備，並勿使用不正確的電源變壓器。
- 若接上不正確的電源變壓器會有爆炸的風險。
- 請勿隨意更換產品內的電池。
- 如果更換不正確之電池型式，會有爆炸的風險，請依製造商說明書處理使用過之電池。
- 請將廢電池丟棄在適當的電器或電子設備回收處。
- 請勿將設備解體。
- 請勿阻礙設備的散熱孔，空氣對流不足將會造成設備損害。
- 請插在正確的電壓供給插座（如：北美 / 台灣電壓 110V AC，歐洲是 230V AC）。
- 假若電源變壓器或電源變壓器的纜線損壞，請從插座拔除，若您還繼續插電使用，會有觸電死亡的風險。
- 請勿試圖修理電源變壓器或電源變壓器的纜線，若有毀損，請直接聯絡您購買的店家，購買一個新的電源變壓器。
- 請勿將此設備安裝於室外，此設備僅適合放置於室內。
- 請勿隨一般垃圾丟棄。
- 請參閱產品背貼上的設備額定功率。
- 請參考產品型錄或是彩盒上的作業溫度。
- 產品沒有斷電裝置或者採用電源線的插頭視為斷電裝置的一部分，以下警語將適用：
  - 對永久連接之設備，在設備外部須安裝可觸及之斷電裝置；
  - 對插接式之設備，插座必須接近安裝之地點而且是易於觸及的。

**About the Symbols**

Various symbols are used in this product to ensure correct usage, to prevent danger to the user and others, and to prevent property damage. The meaning of these symbols are described below. It is important that you read these descriptions thoroughly and fully understand the contents.

**Explanation of the Symbols**

SYMBOL	EXPLANATION
	Alternating current (AC): AC is an electric current in which the flow of electric charge periodically reverses direction.
	Direct current (DC): DC if the unidirectional flow or movement of electric charge carriers.
	Earth; ground: A wiring terminal intended for connection of a Protective Earthing Conductor.
	Class II equipment: The method of protection against electric shock in the case of class II equipment is either double insulation or reinforced insulation.

**Viewing Certifications**

Go to <http://www.zyxel.com> to view this product's documentation and certifications.

**Zyxel Limited Warranty**

Zyxel warrants to the original end user (purchaser) that this product is free from any defects in material or workmanship for a specific period (the Warranty Period) from the date of purchase. The Warranty Period varies by region. Check with your vendor and/or the authorized Zyxel local distributor for details about the Warranty Period of this product. During the warranty period, and upon proof of purchase, should the product have indications of failure due to faulty workmanship and/or materials, Zyxel will, at its discretion, repair or replace the defective products or components without charge for either parts or labor, and to whatever extent it shall deem necessary to restore the product or components to proper operating condition. Any replacement will consist of a new or re-manufactured functionally equivalent product of equal or higher value, and will be solely at the discretion of Zyxel. This warranty shall not apply if the product has been modified, misused, tampered with, damaged by an act of God, or subjected to abnormal working conditions.



### Note

Repair or replacement, as provided under this warranty, is the exclusive remedy of the purchaser. This warranty is in lieu of all other warranties, express or implied, including any implied warranty of merchantability or fitness for a particular use or purpose. Zyxel shall in no event be held liable for indirect or consequential damages of any kind to the purchaser.

To obtain the services of this warranty, contact your vendor. You may also refer to the warranty policy for the region in which you bought the device at [http://www.zyxel.com/web/support\\_warranty\\_info.php](http://www.zyxel.com/web/support_warranty_info.php).

### Registration

Register your product online to receive e-mail notices of firmware upgrades and information at [www.zyxel.com](http://www.zyxel.com).

### Open Source Licenses

This product contains in part some free software distributed under GPL license terms and/or GPL like licenses. Open source licenses are provided with the firmware package. You can download the latest firmware at [www.zyxel.com](http://www.zyxel.com). If you cannot find it there, contact your vendor or Zyxel Technical Support at [support@zyxel.com.tw](mailto:support@zyxel.com.tw).

To obtain the source code covered under those Licenses, please contact your vendor or Zyxel Technical Support at [support@zyxel.com.tw](mailto:support@zyxel.com.tw).

## Symbols

## A

- access [35](#)
- access privileges [18](#)
- access users [100](#)
  - see also users [100](#)
- admin users [100](#)
  - multiple logins [105](#)
  - see also users [100](#)
- alerts [175, 179, 180, 182, 183, 184](#)
- antenna switch [200](#)
- AP [17](#)
- applications
  - MBSSID [18](#)
  - Repeater [20](#)

## B

- backing up configuration files [187](#)
- Basic Service Set
  - see BSS
- BLE [97](#)
- Bluetooth [97](#)
  - advertisements [97](#)
  - advertising settings [99](#)
  - Bluetooth Low Energy [97](#)
  - Bluetooth Smart [97](#)
  - iBeacon [97](#)
  - iBeacon ID [97](#)
  - major [97](#)
  - minor [97](#)
  - UUID [97](#)
  - UUID format [99](#)
- Bluetooth Low Energy [97](#)

- Bluetooth Smart [97](#)
- boot module [192](#)
- BSS [18](#)

## C

- CA
  - and certificates [133](#)
- CA (Certificate Authority), see certificates
- CAPWAP [75, 77](#)
- CEF (Common Event Format) [177, 182](#)
- Certificate Authority (CA)
  - see certificates
- Certificate Management Protocol (CMP) [138](#)
- Certificate Revocation List (CRL) [133](#)
  - vs OCSP [147](#)
- certificates [132](#)
  - advantages of [133](#)
  - and CA [133](#)
  - and FTP [168](#)
  - and HTTPS [154](#)
  - and SSH [165](#)
  - and WWW [155](#)
  - certification path [133, 140, 145](#)
  - expired [133](#)
  - factory-default [133](#)
  - file formats [133](#)
  - fingerprints [141, 146](#)
  - importing [136](#)
  - not used for encryption [133](#)
  - revoked [133](#)
  - self-signed [133, 137](#)
  - serial number [140, 145](#)
  - storage space [135, 143](#)
  - thumbprint algorithms [134](#)
  - thumbprints [134](#)
  - used for authentication [133](#)
  - verifying fingerprints [134](#)
- certification requests [137, 138](#)
- certifications
  - viewing [252](#)

channel [19](#)  
CLI [21](#), [40](#)  
    button [40](#)  
    messages [40](#)  
    popup window [40](#)  
    Reference Guide [2](#)  
cold start [34](#)  
commands [21](#)  
    sent by Web Configurator [40](#)  
Common Event Format (CEF) [177](#), [182](#)  
comparison table [13](#), [14](#), [15](#), [16](#)  
configuration [17](#)  
    information [196](#)  
configuration files [185](#)  
    at restart [187](#)  
    backing up [187](#)  
    downloading [188](#)  
    downloading with FTP [167](#)  
    editing [185](#)  
    how applied [186](#)  
    lastgood.conf [187](#), [189](#)  
    managing [186](#)  
    startup-config.conf [189](#)  
    startup-config-bad.conf [187](#)  
    syntax [185](#)  
    system-default.conf [189](#)  
    uploading [190](#)  
    uploading with FTP [167](#)  
    use without restart [185](#)  
contact information [235](#)  
Control and Provisioning of Wireless Access Points  
    See CAPWAP  
copyright [241](#)  
CPU usage [56](#), [58](#)  
current date/time [56](#), [149](#)  
    daylight savings [151](#)  
    setting manually [152](#)  
    time server [153](#)  
customer support [235](#)

## D

date [149](#)  
daylight savings [151](#)  
DCS [85](#)

DHCP [149](#)  
    and domain name [149](#)  
diagnostics [196](#)  
disclaimer [241](#)  
domain name [149](#)  
DTLS [75](#)  
dual radios [19](#)  
dual-radio application [19](#)  
dynamic channel selection [85](#)

## E

e-mail  
    daily statistics report [173](#)  
encryption [20](#)  
ESSID [207](#)  
Extended Service Set IDentification [107](#)

## F

FCC interference statement [241](#)  
file extensions  
    configuration files [185](#)  
    shell scripts [185](#)  
file manager [185](#)  
firmware  
    and restart [191](#)  
    boot module, see boot module  
    current version [55](#), [192](#)  
    getting updated [191](#)  
    uploading [191](#), [192](#)  
    uploading with FTP [167](#)  
flash usage [56](#)  
FTP [21](#), [167](#)  
    and certificates [168](#)  
    with Transport Layer Security (TLS) [168](#)

## G

Guide  
    CLI Reference [2](#)

**H**

## HTTP

- over SSL, see HTTPS
- redirect to HTTPS [155](#)
- vs HTTPS [154](#)

HTTPS [154](#)

- and certificates [154](#)
- authenticating clients [154](#)
- avoiding warning messages [157](#)
- example [155](#)
- vs HTTP [154](#)
- with Internet Explorer [156](#)
- with Netscape Navigator [156](#)

HyperText Transfer Protocol over Secure Socket Layer, see HTTPS

**I**

IEEE 802.1x [108](#)

installation [17](#)

interface

- status [57](#)

interfaces

- as DHCP servers [149](#)

interference [19](#)

Internet Protocol version 6, see IPv6

IP Address [75](#)

- gateway IP address [75](#)

IP subnet [75](#)

IPv6 [227](#)

- addressing [227](#)
- EUI-64 [229](#)
- global address [227](#)
- interface ID [229](#)
- link-local address [227](#)
- Neighbor Discovery Protocol [227](#)
- ping [227](#)
- prefix [227](#)
- prefix length [227](#)
- stateless autoconfiguration [229](#)
- unspecified address [228](#)

**K**

key pairs [132](#)

**L**

lastgood.conf [187, 189](#)

layer-2 isolation [123](#)

- example [123](#)
- MAC [124](#)

LED suppression [198](#)

LEDs [25](#)

- Blinking [26, 28, 32](#)
- Flashing [26, 28, 29, 30, 32, 33](#)
- Off [26, 28, 29, 31, 32](#)

load balancing [85](#)

Locator LED [199](#)

log messages

- categories [180, 182, 183, 184](#)
- debugging [72](#)
- regular [72](#)
- types of [72](#)

logout

- Web Configurator [37](#)

logs

- e-mail profiles [175](#)
- e-mailing log messages [74, 179](#)
- formats [177](#)
- log consolidation [180](#)
- settings [175](#)
- syslog servers [175](#)
- system [175](#)
- types of [175](#)

**M**

MAC address

- range [55](#)

maintenance [17](#)

management [17](#)

Management Information Base (MIB) [169](#)

Management Mode

- CAPWAP and DHCP [76](#)
- CAPWAP and IP Subnets [77](#)

- managed AP [76](#)
- standalone mode [75](#)
- management mode [17](#)
- managing the device
  - good habits [22](#)
  - using FTP. See FTP.
- MBSSID [18](#)
- memory usage [56, 59](#)
- message bar [43](#)
- messages
  - CLI [40](#)
  - warning [43](#)
- mode [17](#)
- model name [55](#)
- My Certificates, see also certificates [135](#)

## N

- network access control [17](#)
- Network Time Protocol (NTP) [152](#)

## O

- objects
  - certificates [132](#)
  - users, account
    - user [100](#)
- Online Certificate Status Protocol (OCSP) [147](#)
  - vs CRL [147](#)
- operating mode [17](#)
- overview [13](#)

## P

- power off [34](#)
- power on [34](#)
- product registration [253](#)
- Public-Key Infrastructure (PKI) [133](#)
- public-private key pairs [132](#)

## R

- radio [19](#)
- reboot [34, 202](#)
  - vs reset [202](#)
- Reference Guide, CLI [2](#)
- registration
  - product [253](#)
- remote management
  - FTP, see FTP
  - Telnet [167](#)
  - WWW, see WWW
- reports
  - daily [173](#)
  - daily e-mail [173](#)
- reset [212](#)
  - vs reboot [202](#)
  - vs shutdown [203](#)
- RESET button [34, 212](#)
- restart [202](#)
- RF interference [19](#)
- RFC
  - 2510 (Certificate Management Protocol or CMP) [138](#)
- Rivest, Shamir and Adleman public-key algorithm (RSA) [137](#)
- root AP [17](#)
- RSA [137, 145, 146](#)
- RSSI threshold [113](#)

## S

- SCEP (Simple Certificate Enrollment Protocol) [138](#)
- Secure Socket Layer, see SSL
- serial number [55](#)
- service control
  - and users [153](#)
  - limitations [153](#)
  - timeouts [153](#)
- Service Set [107](#)
- Service Set Identifier
  - see SSID
- shell scripts [185](#)
  - downloading [194](#)
  - editing [193](#)

- how applied [186](#)
  - managing [193](#)
  - syntax [185](#)
  - uploading [195](#)
  - shutdown [34, 203](#)
    - vs reset [203](#)
  - Simple Certificate Enrollment Protocol (SCEP) [138](#)
  - Simple Network Management Protocol, see SNMP
  - SNMP [168, 169](#)
    - agents [169](#)
    - Get [169](#)
    - GetNext [169](#)
    - Manager [169](#)
    - managers [169](#)
    - MIB [169](#)
    - network components [169](#)
    - Set [169](#)
    - Trap [169](#)
    - traps [170](#)
    - versions [168](#)
  - SSH [163](#)
    - and certificates [165](#)
    - client requirements [165](#)
    - encryption methods [164](#)
    - for secure Telnet [165](#)
    - how connection is established [163](#)
    - versions [164](#)
    - with Linux [166](#)
    - with Microsoft Windows [165](#)
  - SSID [18](#)
  - SSID profile
    - pre-configured [18](#)
  - SSID profiles [18](#)
  - SSL [154](#)
  - starting the device [33](#)
  - startup-config.conf [189](#)
    - if errors [187](#)
    - missing at restart [187](#)
    - present at restart [187](#)
  - startup-config-bad.conf [187](#)
  - station [85](#)
  - statistics
    - daily e-mail report [173](#)
  - status [54](#)
  - status bar [43](#)
    - warning message popup [43](#)
  - stopping the device [33](#)
  - supported browsers [35](#)
  - syslog [177, 182](#)
  - syslog servers, see also logs
  - system log, see logs
  - system name [55, 149](#)
  - system uptime [56](#)
  - system-default.conf [189](#)
- ## T
- Telnet [167](#)
    - with SSH [165](#)
  - time [149](#)
  - time servers (default) [152](#)
  - trademarks [241](#)
  - Transport Layer Security (TLS) [168](#)
  - troubleshooting [196](#)
  - Trusted Certificates, see also certificates [142](#)
- ## U
- upgrading
    - firmware [191](#)
  - uploading
    - configuration files [190](#)
    - firmware [191](#)
    - shell scripts [193](#)
  - usage
    - CPU [56, 58](#)
    - flash [56](#)
    - memory [56, 59](#)
    - onboard flash [56](#)
  - use [17](#)
  - user authentication [100](#)
  - user name
    - rules [101](#)
  - user objects [100](#)
  - users [100](#)
    - access, see also access users
    - admin (type) [100](#)
    - admin, see also admin users
    - and service control [153](#)
    - currently logged in [56](#)

default lease time [104, 106](#)  
default reauthentication time [104, 106](#)  
lease time [103](#)  
limited-admin (type) [100](#)  
lockout [105](#)  
reauthentication time [103](#)  
types of [100](#)  
user (type) [100](#)  
user names [101](#)

SSID [107](#)  
wireless repeater [17](#)  
wireless security [18, 207](#)  
wireless station [85](#)  
Wizard Setup [47](#)  
WLAN interface [19](#)  
WPA2 [108](#)  
WWW [154](#)  
    and certificates [155](#)  
    see also HTTP, HTTPS [154](#)

## V

Vantage Report (VRPT) [177, 182](#)  
Virtual Local Area Network [80](#)  
VLAN [80](#)  
    introduction [80](#)  
VRPT (Vantage Report) [177, 182](#)

## W

warm start [34](#)  
warning message popup [43](#)  
warranty [252](#)  
    note [253](#)  
WDS [17, 20](#)  
Web Configurator [21, 35](#)  
    access [35](#)  
    requirements [35](#)  
    supported browsers [35](#)  
web configurator [17](#)  
WEP (Wired Equivalent Privacy) [108](#)  
wireless channel [207](#)  
wireless client [85](#)  
Wireless Distribution System (WDS) [20](#)  
wireless LAN [207](#)  
Wireless network  
    overview [84](#)  
wireless network  
    example [84](#)  
wireless profile [107](#)  
    layer-2 isolation [107](#)  
    MAC filtering [107](#)  
    radio [107](#)  
    security [107](#)